

# DENON

AV SURROUND RECEIVER

# AVR-3310CI

---

Owner's Manual

**GUI** *Graphical User Interface*



Use this manual in combination with the operating guide displayed on the GUI screen.

GUI Menu Operation (☞ page 26)

GUI Menu Map (☞ page 25)

Remote Control Unit Operations (☞ page 86)

## SAFETY PRECAUTIONS



**CAUTION:**  
**TO REDUCE THE RISK OF ELECTRIC SHOCK, DO NOT REMOVE COVER (OR BACK). NO USER-SERVICEABLE PARTS INSIDE. REFER SERVICING TO QUALIFIED SERVICE PERSONNEL.**

The lightning flash with arrowhead symbol, within an equilateral triangle, is intended to alert the user to the presence of uninsulated "dangerous voltage" within the product's enclosure that may be of sufficient magnitude to constitute a risk of electric shock to persons.

The exclamation point within an equilateral triangle is intended to alert the user to the presence of important operating and maintenance (servicing) instructions in the literature accompanying the appliance.

**WARNING:**  
**TO REDUCE THE RISK OF FIRE OR ELECTRIC SHOCK, DO NOT EXPOSE THIS APPLIANCE TO RAIN OR MOISTURE.**



**CAUTION:**  
**HOT SURFACE. DO NOT TOUCH.**

The top surface over the internal heat sink may become hot when operating this product continuously.

**PRECAUTION:**  
**SURFACE CHAUDE. NE PAS TOUCHER.**

La surface supérieure du dissipateur de chaleur peut devenir chaude si vous utilisez ce produit en continu.

## IMPOTANT SAFETY INSTRUCTIONS

1. Read these instructions.
2. Keep these instructions.
3. Heed all warnings.
4. Follow all instructions.
5. Do not use this apparatus near water.
6. Clean only with dry cloth.
7. Do not block any ventilation openings. Install in accordance with the manufacturer's instructions.
8. Do not install near any heat sources such as radiators, heat registers, stoves, or other apparatus (including amplifiers) that produce heat.
9. Do not defeat the safety purpose of the polarized or grounding-type plug. A polarized plug has two blades with one wider than the other. A grounding type plug has two blades and a third grounding prong. The wide blade or the third prong are provided for your safety. If the provided plug does not fit into your outlet, consult an electrician for replacement of the obsolete outlet.
10. Protect the power cord from being walked on or pinched particularly at plugs, convenience receptacles, and the point where they exit from the apparatus.
11. Only use attachments/accessories specified by the manufacturer.
12. Use only with the cart, stand, tripod, bracket, or table specified by the manufacturer, or sold with the apparatus. When a cart is used, use caution when moving the cart/apparatus combination to avoid injury from tip-over.
13. Unplug this apparatus during lightning storms or when unused for long periods of time.
14. Refer all servicing to qualified service personnel. Servicing is required when the apparatus has been damaged in any way, such as power-supply cord or plug is damaged, liquid has been spilled or objects have fallen into the apparatus, the apparatus has been exposed to rain or moisture, does not operate normally, or has been dropped.
15. Batteries shall not be exposed to excessive heat such as sunshine, fire or the like.



### CAUTION:

- The ventilation should not be impeded by covering the ventilation openings with items, such as newspapers, tablecloths, curtains, etc.
- No naked flame sources, such as lighted candles, should be placed on the unit.
- Observe and follow local regulations regarding battery disposal.
- Do not expose the unit to dripping or splashing fluids.
- Do not place objects filled with liquids, such as vases, on the unit.

### ATTENTION:

- La ventilation ne doit pas être gênée en recouvrant les ouvertures de la ventilation avec des objets tels que journaux, rideaux, tissus, etc.
- Aucune flamme nue, par exemple une bougie, ne doit être placée sur l'appareil.
- Veillez à respecter les lois en vigueur lorsque vous jetez les piles usagées.
- L'appareil ne doit pas être exposé à l'eau ou à l'humidité.
- Ne pas poser d'objet contenant du liquide, par exemple un vase, sur l'appareil.

### CAUTION:

To completely disconnect this product from the mains, disconnect the plug from the wall socket outlet. The mains plug is used to completely interrupt the power supply to the unit and must be within easy access by the user.

### PRECAUTION:

Pour déconnecter complètement ce produit du courant secteur, débranchez la prise de la prise murale. La prise secteur est utilisée pour couper complètement l'alimentation de l'appareil et l'utilisateur doit pouvoir y accéder facilement.

## FCC INFORMATION (For US customers)

### 1. COMPLIANCE INFORMATION

Product Name: AV Surround Receiver  
Model Number: AVR-3310CI

This product complies with Part 15 of the FCC Rules. Operation is subject to the following two conditions: (1) this product may not cause harmful interference, and (2) this product must accept any interference received, including interference that may cause undesired operation.

Denon Electronics (USA), LLC  
(a D & M Holdings Company)

100 Corporate Drive  
Mahwah, NJ 07430-2041  
Tel. (800) 497-8921

### 2. IMPORTANT NOTICE: DO NOT MODIFY THIS PRODUCT

This product, when installed as indicated in the instructions contained in this manual, meets FCC requirements. Modification not expressly approved by DENON may void your authority, granted by the FCC, to use the product.

### 3. IMPORTANT

When connecting this product to network hub or router, use only shielded STP or FTP LAN cables which is available at retailer.

Follow all installation instructions. Failure to follow instructions could void your authority, granted by the FCC, to use the product.

### 4. NOTE

This product has been tested and found to comply with the limits for a Class B digital device, pursuant to Part 15 of the FCC Rules. These limits are designed to provide reasonable protection against harmful interference in a residential installation.

This product generates, uses and can radiate radio frequency energy and, if not installed and used in accordance with the instructions, may cause harmful interference to radio communications. However, there is no guarantee that interference will not occur in a particular installation. If this product does cause harmful interference to radio or television reception, which can be determined by turning the product OFF and ON, the user is encouraged to try to correct the interference by one or more of the following measures:

- Reorient or relocate the receiving antenna.
- Increase the separation between the equipment and receiver.
- Connect the product into an outlet on a circuit different from that to which the receiver is connected.
- Consult the local retailer authorized to distribute this type of product or an experienced radio/TV technician for help.

### For Canadian customers

This Class B digital apparatus complies with Canadian ICES-003.

Cet appareil numérique de la classe B est conforme à la norme NMB-003 du Canada.

## NOTE ON USE / OBSERVATIONS RELATIVES A L'UTILISATION

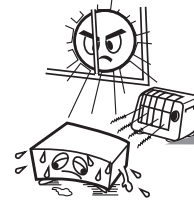

- Avoid high temperatures. Allow for sufficient heat dispersion when installed in a rack.
- Éviter des températures élevées. Tenir compte d'une dispersion de chaleur suffisante lors de l'installation sur une étagère.

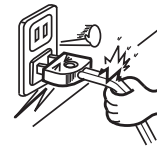

- Handle the power cord carefully. Hold the plug when unplugging the cord.
- Manipuler le cordon d'alimentation avec précaution. Tenir la prise lors du débranchement du cordon.



- Keep the unit free from moisture, water, and dust.
- Protéger l'appareil contre l'humidité, l'eau et la poussière.

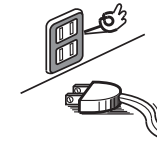

- Unplug the power cord when not using the unit for long periods of time.
- Débrancher le cordon d'alimentation lorsque l'appareil n'est pas utilisé pendant de longues périodes.



\* (For apparatuses with ventilation holes)

- Do not obstruct the ventilation holes.
- Ne pas obstruer les trous d'aération.



- Do not let foreign objects into the unit.
- Ne pas laisser des objets étrangers dans l'appareil.

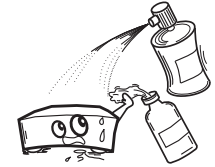

- Do not let insecticides, benzene, and thinner come in contact with the unit.
- Ne pas mettre en contact des insecticides, du benzène et un diluant avec l'appareil.

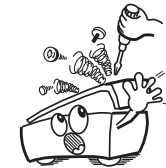

- Never disassemble or modify the unit in any way.
- Ne jamais démonter ou modifier l'appareil d'une manière ou d'une autre.

<b>Getting Started</b>	
<b>Flow of Operations Through Playback</b> .....	2
<b>Cautions on Handling</b> .....	2
<b>Cautions on Installation</b> .....	2
<b>Preparations</b> .....	3
Accessories .....	3
Insert Batteries in the Remote Control Unit .....	3
Operating Range of the Remote Control Unit .....	3
<b>Part Names and Functions</b> .....	4
Front Panel .....	4
Display .....	5
Rear Panel .....	6
Remote Control Unit .....	7
<b>Connections</b>	
<b>Important Information</b> .....	9
Cables Used for Connections .....	9
Converting Input Video Signals for Output (Video Conversion Function) .....	10
<b>Installing / Setting the Speakers</b> .....	11
<b>Speaker Connections</b> .....	13
<b>Connecting Devices</b> .....	14
<b>Connecting the Power Cord</b> .....	24
<b>Once Connections are Completed</b> .....	24
Turning the Power On .....	24
Turning the Power Off .....	24
<b>Settings</b>	
<b>GUI Menu Map</b> .....	25
<b>GUI Menu Operation</b> .....	26
Example of the Display of the GUI Mark at a Title .....	26
Examples of GUI Menu Screen Displays .....	26
Selecting the Input Source .....	27
<b>Make the Optimal Speaker Settings, and Correct the Room Acoustics (Audyssey™ Auto Setup)</b> .....	28
<b>Making Detailed Settings (Manual Setup)</b> .....	33
<b>Making the Input Settings (Input Setup)</b> .....	45
Important Information .....	45

<b>Playback</b>	
<b>Important Information</b> .....	52
<b>Playing Components</b> .....	52
Playing a Blu-ray Disc Player/DVD Player .....	52
iPod® Playback .....	52
<b>Tuning in Radio Stations</b> .....	54
Important Information .....	54
Listening to SIRIUS Satellite Radio .....	55
Listening to HD Radio Stations .....	57
<b>Playing Network Audio, USB Memory Devices</b> .....	58
Important Information .....	58
Listening to Internet Radio .....	60
Playing Files Stored on a Computer .....	62
Playing Files Stored on USB Memory Devices .....	62
Listening to Napster .....	63
Listening to Rhapsody .....	65
<b>Operations During Playback</b> .....	67
Adjusting the Master Volume .....	67
Turning Off the Sound Temporarily (Muting) .....	67
Listening with Headphones .....	67
Switching the front speakers .....	67
To Stop .....	67
Stopping Playback Temporarily .....	67
Fast-forwarding or Fast-reversing .....	67
To Cue to the Beginning of a Track .....	68
Playing Repeatedly .....	68
Selecting Tracks .....	68
Shuffling Playback .....	68
Playing in Random Order .....	68
Searching Pages .....	68
Searching by First Letter .....	68
<b>Selecting the Surround Mode (Surround Mode)</b> .....	69
<b>Adjusting the Sound and Picture Quality (Audio/Video Adjust)</b> .....	71
Adjusting the Sound (Audio Adjust) .....	71
Adjusting the Picture Quality (Picture Adjust) .....	75

<b>Checking the Status (Information)</b> .....	76
--	----

<b>Other Operations and Convenient Functions</b>	
<b>Other Operations</b> .....	77
Recording on an External Device (REC OUT mode) .....	77
<b>Convenient Functions</b> .....	78
HDMI Control Function .....	78
Setting the Power to Standby After a Certain Amount of Time (Sleep Timer Function) .....	79
Adjust the Volume of the Speakers .....	79
Saving Frequently Used Settings (Quick Select Function) .....	80
Playing the Same Network Audio on Different Devices Connected in a Network (Party Mode Function) .....	80
Operating a Wireless LAN-Compatible Mobile Terminal to Play Music and Videos .....	81
Operating the AVR-3310CI with a Browser (Web Control Function) .....	82
Various Memory Functions .....	83

<b>Playing in ZONE2/ZONE3 (Multi-zone Function)</b>	
<b>Audio Output</b> .....	84
① Zone Playback by Speaker Output .....	84
② Zone Playback by Audio Output (PRE OUT) .....	84
<b>Video Output</b> .....	84
Video Connection .....	84
<b>Playback</b> .....	85
<b>Quick Select Function</b> .....	86

## Operating the Connected Devices by Remote Control Unit

Operating the Main Remote Control Unit .....	86
Registering Preset Codes .....	86
Operating Components .....	87
Assigning buttons that are Not Used to Operate Other Devices (Punch Through Function) .....	90
Operating the Sub Remote Control Unit .....	91
Switching Zones .....	92
Switching the Multi-zone Input Source to the Same Input Source as Used in the MAIN ZONE .....	92
Setting the Zone for Which the Sub Remote Control Unit is Used (ZONE SELECT LOCK Mode) .....	92
Setting the Remote ID .....	92
Resetting the Settings .....	92

## Other Information ..... 93

## Troubleshooting ..... 100

Restoring All the Settings to as They were at the Time of Purchase (Resetting the Microprocessor) .....	103
---	-----

## Specifications ..... 104

## List of preset codes ..... End of this manual

# Getting Started

## Flow of Operations Through Playback

Perform the operations leading to playback on the AVR-3310CI in the order shown below.

### Connections

Installing/Setting the Speakers (☞ page 11)



Speaker Connections (☞ page 13)



Connecting Devices (☞ page 14)



Turning the Power On (☞ page 24)



### Settings

Audyssey™ Auto Setup (☞ page 28)



Manual Setup (☞ page 33)  
※ Perform "Manual Setup" as necessary.



Input Setup (☞ page 45)



### Playback

Playing Components (☞ page 52)



Selecting the Surround Mode (☞ page 69)



Adjusting the Sound and Picture Quality  
(☞ page 71)

## Cautions on Handling

### • Before turning the power switch on

Check once again that all connections are correct and that there are no problems with the connection cables.

• Power is supplied to some of the circuitry even when the unit is set to the standby mode. When traveling or leaving home for long periods of time, be sure to unplug the power cord from the power outlet.

### • About condensation

If there is a major difference in temperature between the inside of the unit and the surroundings, condensation (dew) may form on the operating parts inside the unit, causing the unit not to operate properly.

If this happens, let the unit sit for an hour or two with the power turned off and wait until there is little difference in temperature before using the unit.

### • Cautions on using mobile phones

Using a mobile phone near this unit may result in noise. If so, move the mobile phone away from this unit when it is in use.

### • Moving the unit

Turn off the power and unplug the power cord from the power outlet.

Next, disconnect the connection cables to other system units before moving the unit.

• Note that the illustrations in these instructions may differ from the actual unit for explanation purposes.

## Cautions on Installation

### Note:

For proper heat dispersal, do not install this unit in a confined space, such as a bookcase or similar enclosure.

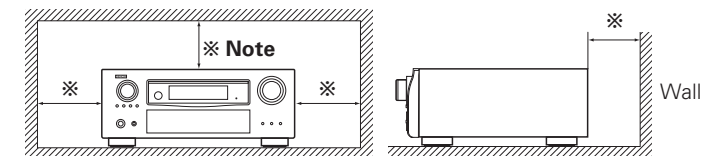

## Preparations

Thank you for purchasing this DENON product. To ensure proper operation, please read this owner's manual carefully before using the product.

After reading them, be sure to keep them for future reference.

## Accessories

Check that the following parts are supplied with the product.

① Owner's manual .....	1
② Getting started .....	1
③ Warranty (for North America model only).....	1
④ Service station list .....	1
⑤ Power cord (Cord length: Approx. 5.9 ft / 1.8 m) .....	1
⑥ Main remote control unit (RC-1118) .....	1
⑦ R6/AA batteries (for RC-1118) .....	2
⑧ Sub remote control unit (RC-1121).....	1
⑨ R03/AAA batteries (for RC-1121).....	2
⑩ AM loop antenna (for HD Radio broadcasts) .....	1
⑪ Dipole antenna (for HD Radio broadcasts) .....	1
⑫ Setup microphone (DM-A409, Cord length: Approx. 25 ft / 7.6 m) .....	1

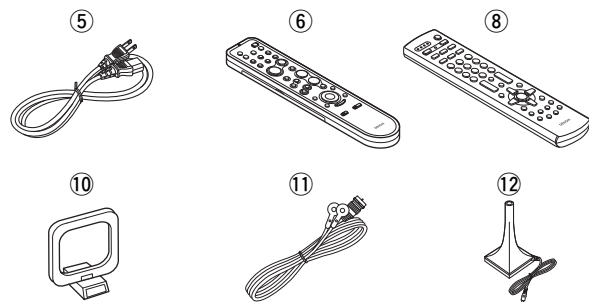

## Insert Batteries in the Remote Control Unit

In addition to the AVR-3310CI, the included main remote control unit (RC-1118) can also be used to operate the equipment listed below.

- ① DENON system components
- ② Non-DENON system components

To operate component products other than DENON, you must set the preset code (see page 86 "Registering Preset Codes").

### Inserting the Batteries

- ① Lift the clasp and remove the rear lid.

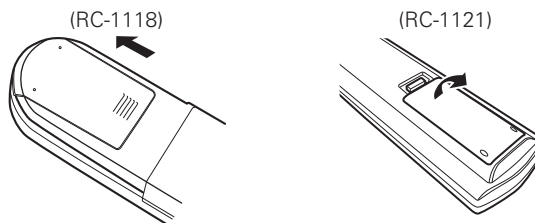

- ② Load the two batteries properly as indicated by the marks in the battery compartment.

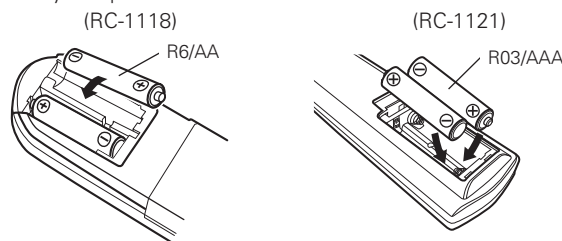

- ③ Put the rear cover back on.

### NOTE

- Insert the specified batteries in the remote control unit.
- Replace the batteries with new ones if the set does not operate even when the remote control unit is operated close to the unit. (The supplied batteries are only for verifying operation.)
- When inserting the batteries, be sure to do so in the proper direction, following the "⊕" and "⊖" marks in the battery compartment.
- To prevent damage or leakage of battery fluid:
  - Do not use a new battery together with an old one.
  - Do not use two different types of batteries.
  - Do not attempt to charge dry batteries.
  - Do not short-circuit, disassemble, heat or dispose of batteries in flames.
- If the battery fluid should leak, carefully wipe the fluid off the inside of the battery compartment and insert new batteries.
- Remove the batteries from the remote control unit if it will not be in use for long periods.
- Used batteries should be disposed of in accordance with the local regulations regarding battery disposal.

## Operating Range of the Remote Control Unit

Point the remote control unit at the remote sensor when operating it.

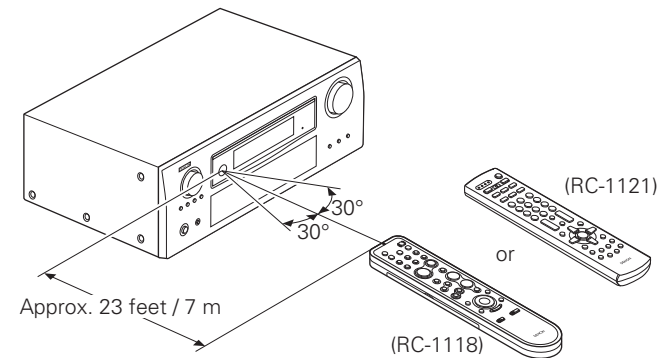

### NOTE

The set may function improperly or the remote control unit may not operate if the remote control sensor is exposed to direct sunlight, strong artificial light from an inverter type fluorescent lamp or infrared light.

# Part Names and Functions

## Front Panel

For buttons not explained here, see the page indicated in parentheses ( ).

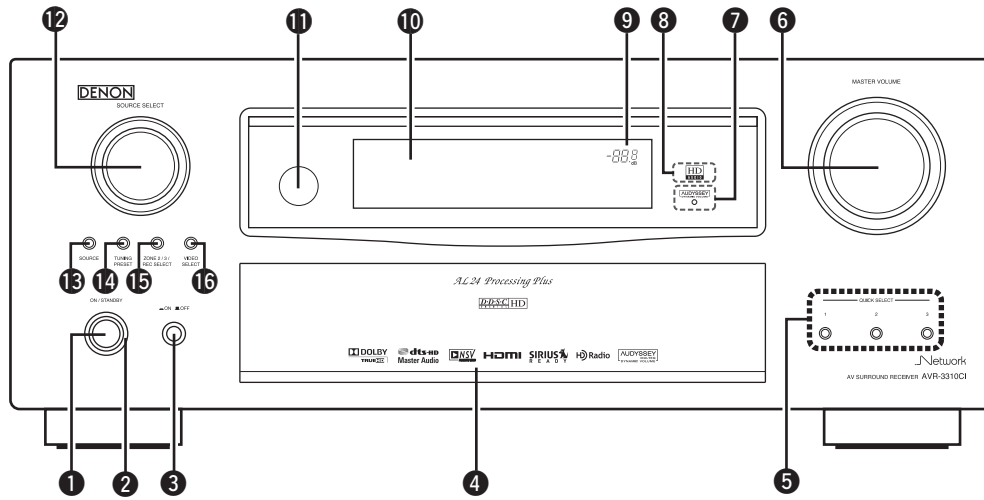

- 1 Power operation button ..... (24)
- 2 Power indicator ..... (24)
- 3 Power switch ..... (24)
- 4 Door  
When you are using buttons and/or terminals behind the door, press the bottom of the door to open it. When not using buttons and/or terminals behind the door, close it. Be careful not to catch your fingers when closing the door.
- 5 QUICK SELECT buttons ..... (80)
- 6 MASTER VOLUME control knob ..... (67)
- 7 AUDYSSEY DYNAMIC VOLUME™ indicator ..... (73)
- 8 HD AUDIO indicator ..... (69)
- 9 Master volume indicator
- 10 Display
- 11 Remote control sensor ..... (3)
- 12 SOURCE SELECT knob ..... (27)
- 13 SOURCE button ..... (27)
- 14 TUNING PRESET button ..... (56, 58)
- 15 ZONE 2/3 / REC SELECT button ..... (77, 85)
- 16 VIDEO SELECT button ..... (48)

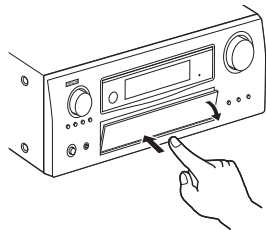

## [With the door open]

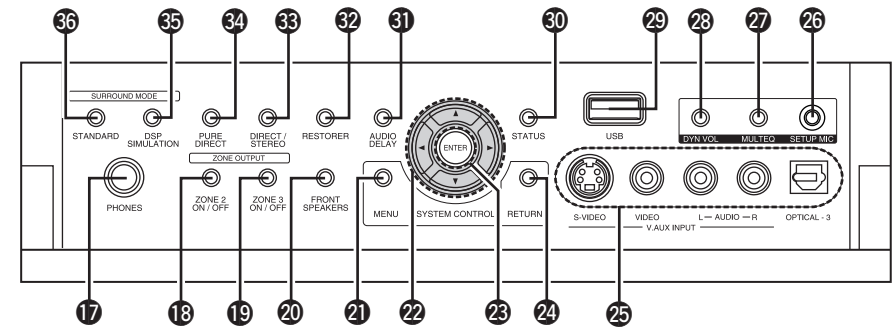

- 17 Headphones jack ..... (67)
- 18 ZONE2 ON/OFF button ..... (85)
- 19 ZONE3 ON/OFF button ..... (85)
- 20 FRONT SPEAKERS button ..... (67)
- 21 MENU button ..... (25)
- 22 Cursor buttons (Δ ▽ ◀ ▶) ..... (26)
- 23 ENTER button ..... (26)
- 24 RETURN button ..... (26)
- 25 V.AUX INPUT connectors ..... (21)
- 26 SETUP MIC jack ..... (29)
- 27 MULTEQ® button ..... (73)
- 28 DYNAMIC VOLUME™ button (DYN VOL) ... (74)
- 29 USB port ..... (21)
- 30 STATUS button ..... (76)
- 31 AUDIO DELAY button ..... (75)
- 32 RESTORER button ..... (74)
- 33 DIRECT/STEREO button ..... (70)
- 34 PURE DIRECT button ..... (70)
- 35 DSP SIMULATION button ..... (70)
- 36 STANDARD button ..... (69)

## Display

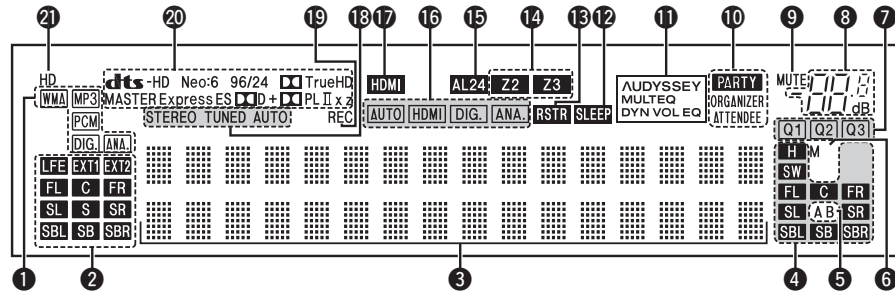
**1 Input signal indicators****2 Input signal channel indicators**

These light when digital signals are input. When playing HD Audio sources, the "EXT1" indicator lights when an extension channel (a channel other than the front, center, surround, surround back or LFE channel) is input. If there are two or more extension channels, the "EXT1" and "EXT2" indicators light.

**3 Information display**

The input source name, surround mode, setting values and other information are displayed here.

**4 Output signal channel indicators****5 Front speaker indicators**

These light according to the settings of the front A and B speakers.

**6 Monitor output indicators**

This indicator lights up when an HDMI monitor is connected.

**7 QUICK SELECT indicators****8 Master volume indicator****9 MUTE indicator**

This lights when the mute mode is selected.

**10 PARTY indicators**

These indicators light during party mode.

- **ORGANIZER**

This lights to indicate that party mode has started as Organizer.

- **ATTENDEE**

This lights to indicate that party mode has started as Attendee.

**11 AUDYSSEY MULTEQ indicators**

Lighting is as follows, depending on the setting of "Dynamic EQ" (page 73) and "Dynamic Volume" (page 74).

- : When "DynamicEQ" and "Dynamic Volume" are "ON".
- : When the "Dynamic EQ" setting is "ON" and the "Dynamic Volume" setting is "OFF".
- : When "DynamicEQ" and "Dynamic Volume" are "OFF".

**12 SLEEP indicator**

This lights when the sleep mode is selected.

**13 RESTORER indicator**

This lights when the RESTORER mode is selected.

**14 Multi zone indicators**

These light when the power for the respective zone is turned on.

**15 AL24 indicator**

This lights when AL24 Processing Plus (page 94) is activated.

**16 Input mode indicators****17 HDMI indicator**

This lights when playing using HDMI connections.

**18 Tuner reception mode indicators**

These light according to the reception conditions when the input source is set to "HD Radio".

- **STEREO**

In the FM mode, these light when receiving analog stereo broadcasts.

- **TUNED**

Lights when the broadcast is properly tuned in.

- **AUTO**

These light when in the auto tuning mode.

**19 Recording output source indicator**

This lights when the REC OUT mode is selected.

**20 Decoder indicators**

These light when the respective decoders are operating.

**21 HD indicator**

This lights during HD Radio reception.



Rear Panel

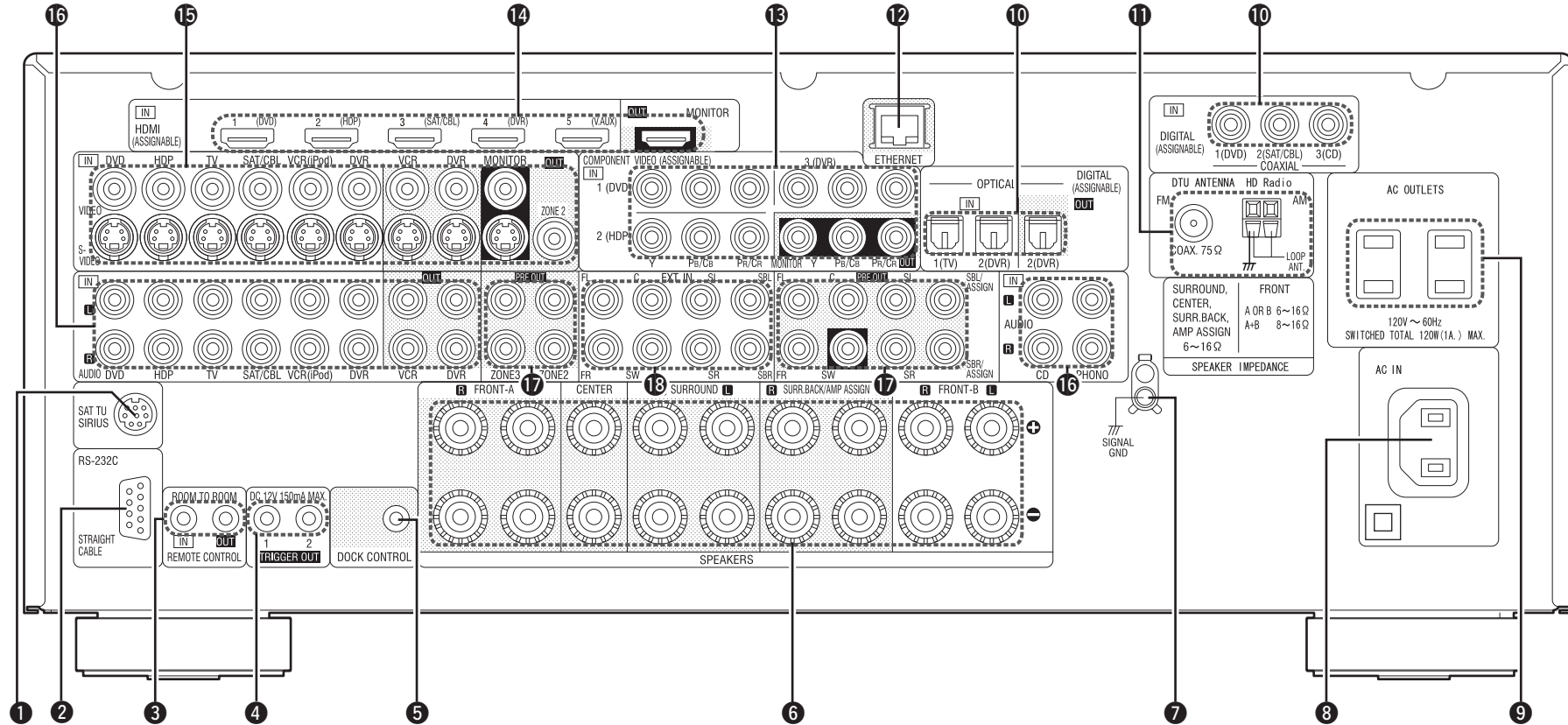

- |  |  |  |
|--|--|--|
| <b>1</b> SIRIUS connector ..... (19)     | <b>7</b> SIGNAL GND terminal ..... (17)            | <b>13</b> COMPONENT VIDEO connectors... (15, 16, 18) |
| <b>2</b> RS-232C connector ..... (22)    | <b>8</b> AC inlet ..... (24)                       | <b>14</b> HDMI connectors ..... (14)                 |
| <b>3</b> REMOTE CONTROL jacks ..... (22) | <b>9</b> AC OUTLETS ..... (24)                     | <b>15</b> VIDEO / S-VIDEO connectors ..... (15 ~ 19) |
| <b>4</b> TRIGGER OUT jacks ..... (22)    | <b>10</b> Digital audio connectors ..... (16 ~ 19) | <b>16</b> Analog audio connectors ..... (16 ~ 19)    |
| <b>5</b> DOCK CONTROL jack ..... (16)    | <b>11</b> HD Radio antenna terminals ..... (20)    | <b>17</b> PRE OUT connectors ..... (22, 84)          |
| <b>6</b> Speaker terminals ..... (13)    | <b>12</b> ETHERNET connector ..... (23)            | <b>18</b> EXT. IN connectors ..... (21)              |

Part Names and Functions

Remote Control Unit

Main Remote Control Unit (RC-1118)

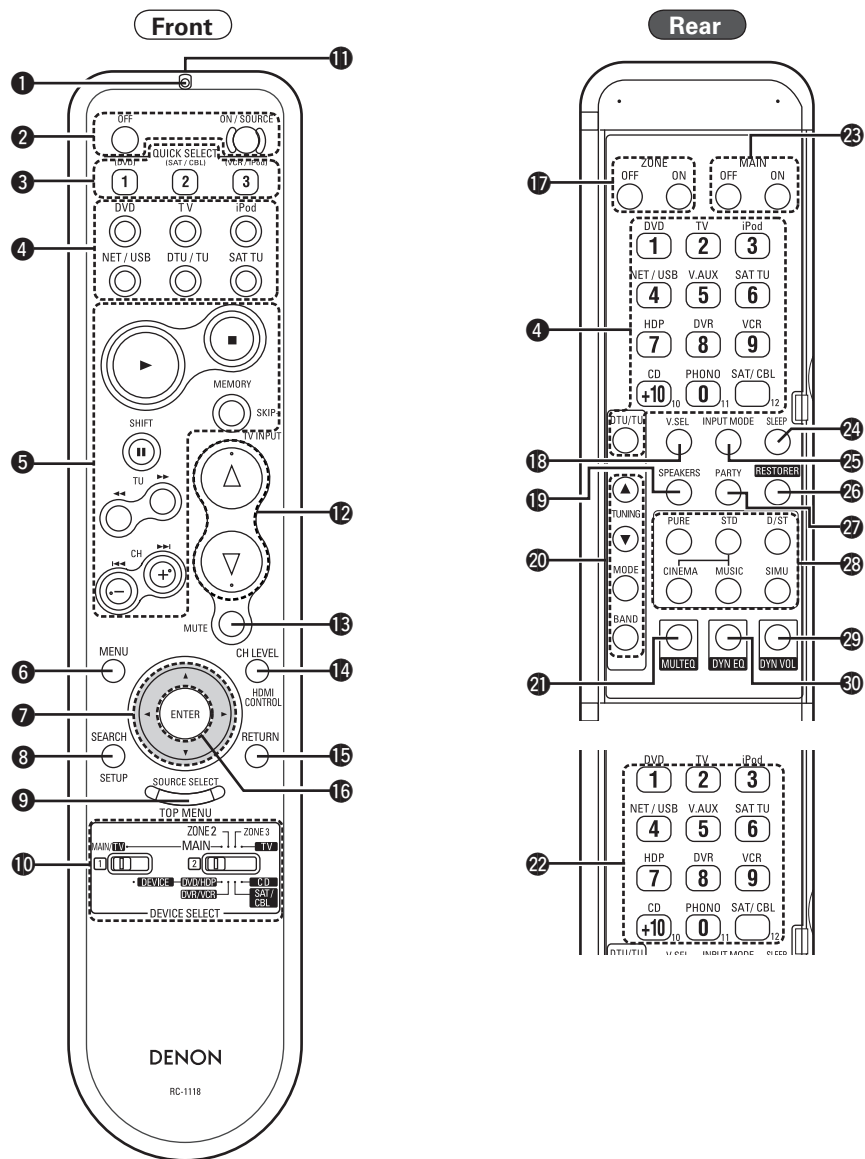

- 1 Indicator ..... (86)
- 2 Power buttons ..... (24)
- 3 QUICK SELECT buttons ..... (80)
- 4 Input source select button ..... (27)
- 5 System buttons ..... (67, 68, 87 ~ 90)
- 6 MENU button ..... (25)
- 7 Cursor buttons (Δ ▽ ◀ ▶) ..... (26)
- 8 SEARCH button ..... (68)
- 9 SOURCE SELECT button ..... (27)
- 10 DEVICE SELECT switches ..... (7, 86)
- 11 Remote control signal transmitter ..... (3)
- 12 Master volume control buttons ..... (67)
- 13 Muting button (MUTE) ..... (67)
- 14 Channel level adjustment button ..... (35, 79)
- 15 RETURN button ..... (26)
- 16 ENTER button ..... (26)
- 17 ZONE power button ..... (85)
- 18 VIDEO SELECT button ..... (48)
- 19 Front height speaker on/off button ..... (72)
- 20 Tuner operation buttons ..... (57)
- 21 MULTEQ® button ..... (73)
- 22 Number buttons (0 ~ 9, +10) ..... (86)
- 23 MAIN ZONE power buttons ..... (24)
- 24 SLEEP TIMER button ..... (79)
- 25 INPUT MODE button ..... (49)
- 26 RESTORER button ..... (74)
- 27 PARTY button ..... (80)
- 28 Surround mode buttons ..... (69, 70)
- 29 DYNAMIC VOLUME™ button ..... (74)
- 30 DYNAMIC EQ™ button ..... (73)



For buttons not explained here, see the page indicated in parentheses ( ).

**NOTE**

Buttons on the back panel may operate when the back lid is pressed.

**Operations possible by remote control**

- Operations on the AVR-3310CI
- Operations on five devices other than the AVR-3310CI
  - Preset the remote control codes of the devices to be operated (page 86).
  - Switch two device selector switches according to the devices to be operated.

Position of switches		Operable devices
	MAIN	AVR-3310CI (MAIN ZONE) iPod, DTU, SAT TU, NET/USB
	ZONE 2	AVR-3310CI (ZONE2)
	ZONE 3	AVR-3310CI (ZONE3)
	TV	TV
	DVD/HDP	Blu-ray disc player or DVD Player
	DVR/VCR	Digital video recorder or Video deck
	SAT/CBL	Satellite receiver or Cable TV
	CD	CD player

- Multi-zone (ZONE2 / ZONE3) operations (page 84)
- Punch through setting (page 90)

Sub Remote Control Unit (RC-1121)

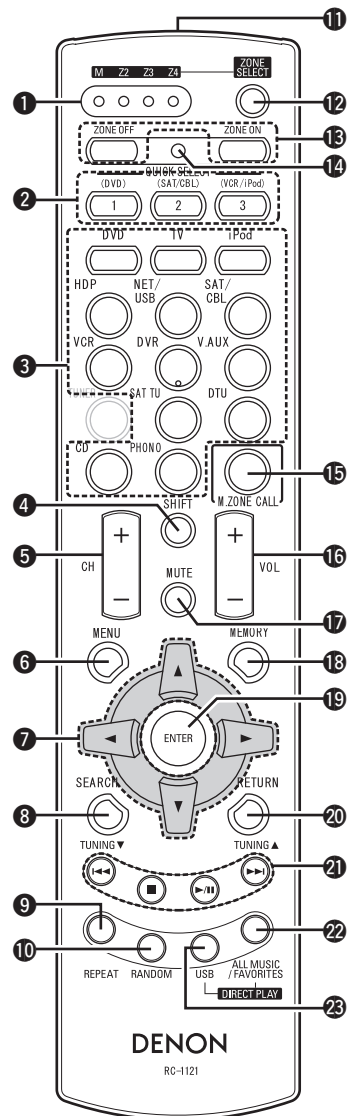

- 1 ZONE indicators ..... (92)
- 2 QUICK SELECT buttons ..... (80, 86)
- 3 Input source select buttons ..... (91)
- 4 SHIFT button ..... (91)
- 5 Channel button (CH) ..... (91)
- 6 MENU button ..... (25, 91)
- 7 Cursor buttons (Δ ∇ ◀ ▶) ..... (26, 91)
- 8 SEARCH button ..... (68, 91)
- 9 REPEAT button ..... (68, 91)
- 10 RANDOM button ..... (68, 91)
- 11 Remote control signal transmitter ..... (3)
- 12 ZONE SELECT button ..... (92)
- 13 Zone power on/off buttons ..... (85)
- 14 Advanced setup button ..... (92)
- 15 MAIN ZONE call button ..... (92)
- 16 Master volume control buttons (VOL) ..... (85)
- 17 Muting button (MUTE) ..... (85)
- 18 MEMORY button ..... (91)
- 19 ENTER button ..... (26, 91)
- 20 RETURN button ..... (26, 91)
- 21 System buttons ..... (91)
- 22 ALL MUSIC/FAVORITES (DIRECT PLAY) button ..... (91)
- 23 USB (DIRECT PLAY) button ..... (63, 91)

# Connections

## Important Information







Connections for all compatible audio and video signal formats are described in this owner's manual. Please select the types of connections suited for the equipment you are connecting. After connections are completed, certain settings must be made on the receiver. Make the settings indicated " **Set as Necessary** " for the individual items.





### NOTE

- Do not plug in the power cord until all connections have been completed.
- When making connections, also refer to the operating instructions of the other components.
- Be sure to connect the left and right channels properly (left with left, right with right).
- Do not bundle power cords together with connection cables. Doing so can result in humming or noise.

## Cables Used for Connections

Select the cables (sold separately) according to the equipment being connected.

Audio and video cables	
<b>HDMI connections</b>	 HDMI cable
Audio cables	
<b>Coaxial digital connections</b>	 Coaxial digital cable
<b>Optical digital connections</b>	 Optical cable
<b>Analog connections (stereo, surround)</b>	 Audio cable
<b>Analog connections (monaural, for subwoofer)</b>	 Audio cable
<b>Speaker connections</b>	 Speaker cables

Video cables	
<b>Component video connections</b>	 Component video cable
<b>S-Video connections</b>	 S-Video cable
<b>Video connections</b>	 Video cable
Other cables	
<b>Network connections</b>	 Ethernet cable

## Converting Input Video Signals for Output (Video Conversion Function)

The AVR-3310CI has 4 different types of video input/output terminal (HDMI, Component video, S-Video, Video).

Use the terminals according to the devices to be connected.

This function automatically converts various formats of video signals input to the AVR-3310CI into the format used to output the video signals from the AVR-3310CI to a monitor. (☞ page 99 "Relationship Between Video Signals and Monitor Output").

### [Flow of video signals for MAIN ZONE]

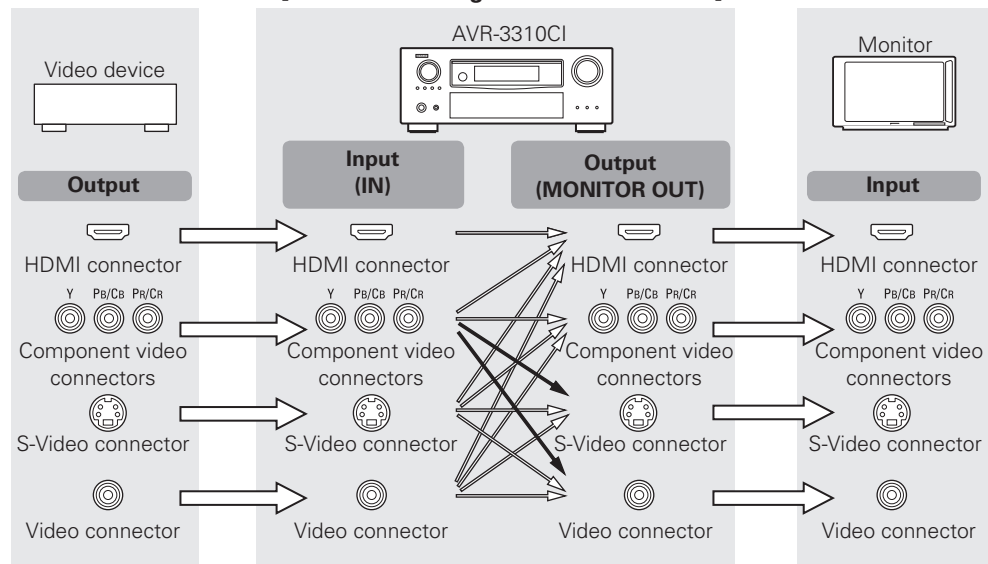

→ : When 480i/576i signals are input

### [Flow of video signals for ZONE2]

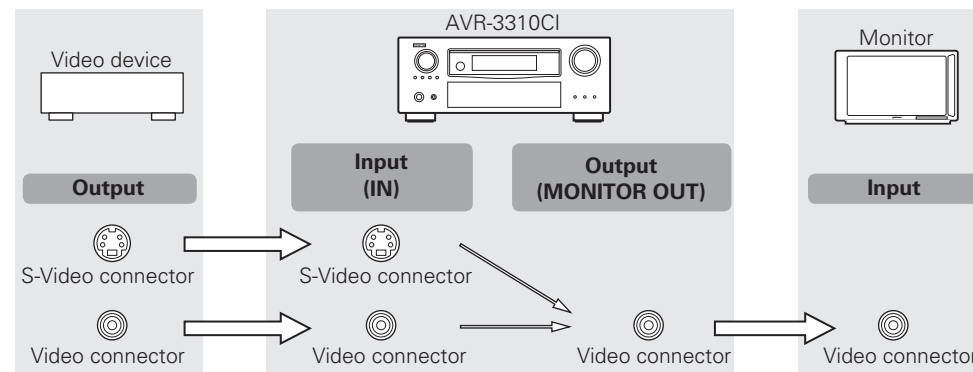

#### Set as Necessary

- Set when using the video conversion function.
  - "Video Convert" (☞ page 48)
  - "Resolution" (☞ page 48)



Resolutions of HDMI-compatible TVs can be checked at "HDMI Information" – "Monitor Information" (☞ page 76).

#### NOTE

- HDMI signals cannot be converted into analog signals.
- When a non-standard video signal from a game machine or some other source is input, the video conversion function might not operate.
- 480p/576p/1080i/720p/1080p component video input signals cannot be converted into S-Video or Video format.

# Installing / Setting the Speakers

- The AVR-3310CI is compatible with various types of surround playback.
- Decide on the surround modes to be played on the AVR-3310CI before making connections and settings.

## 1 Determine the Speaker Layout

Below we introduce examples of speaker layouts. Refer to these to arrange your speakers according to their type and how you want to use them.

### Installing All the Speakers

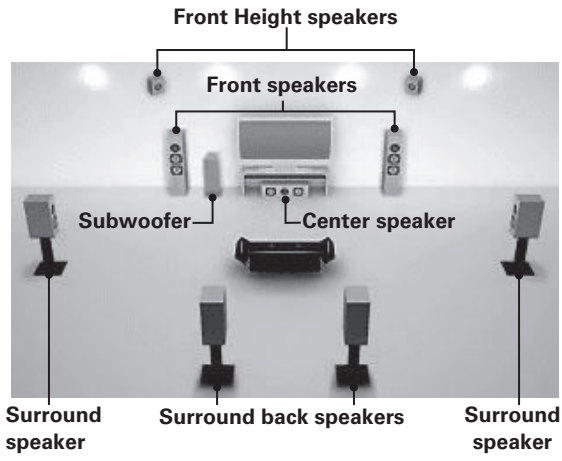

**NOTE**

It is not possible to use the surround back speakers and front height speakers simultaneously.

#### When 7.1ch (Front Height Speaker) Connected

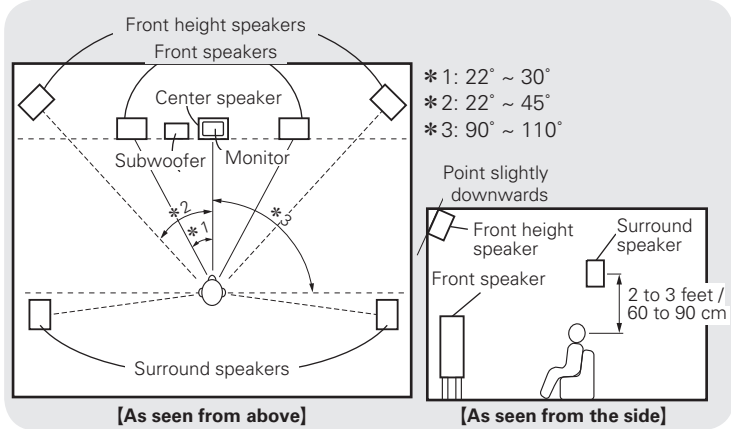

#### When 6.1ch (Surround Back Speaker) Connected

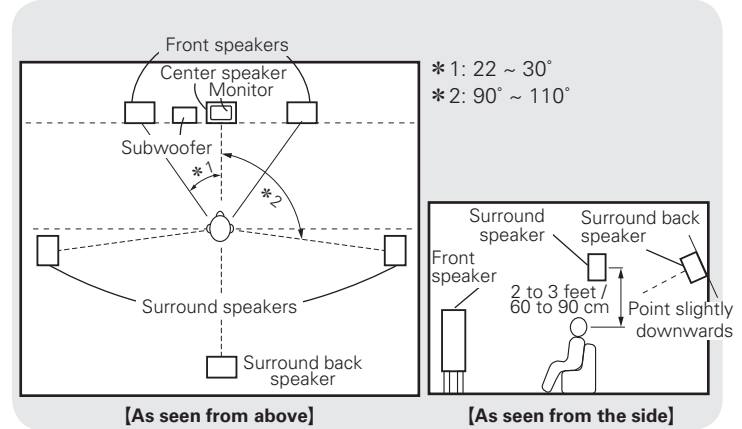

#### When 7.1ch (Surround Back Speaker) Connected

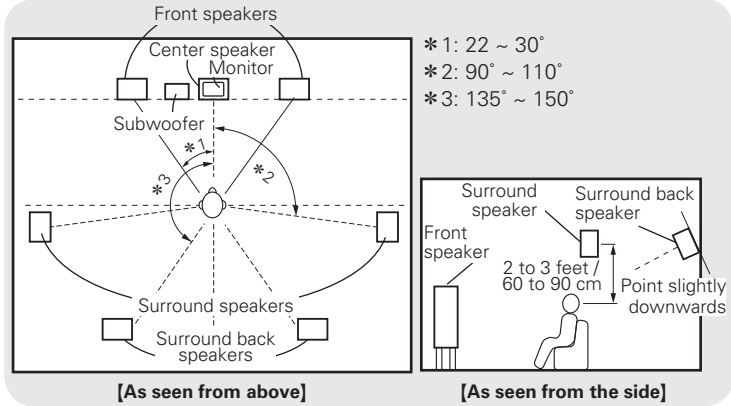



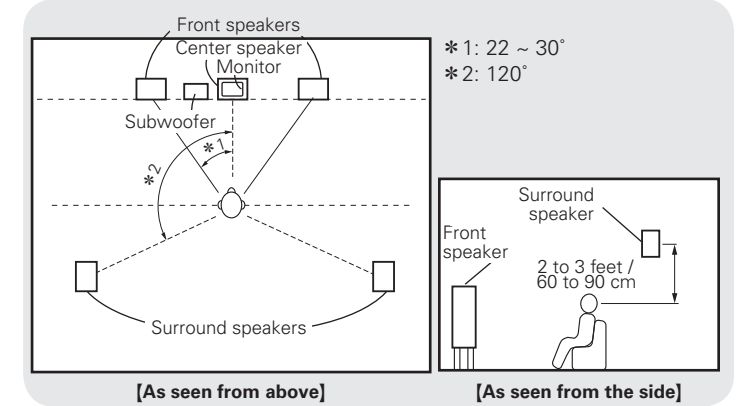







#### When 5.1ch Connected



## 2 Set the "Amp Assign" Mode According to the Speaker Layout

The signals output from the AVR-3310CI's SURR. BACK/AMP ASSIGN speaker terminals can be switched (☞ page 34 "Amp Assign").

Amp assign mode (☞ page 34)	SURR. BACK / AMP ASSIGN Speaker connections	Example of speaker installation (Number of channels played)	Amp assign mode (☞ page 34)	SURR. BACK / AMP ASSIGN Speaker connections	Example of speaker installation (Number of channels played)
<b>Normal</b>	Surround Back Speakers	 (7.1)	<b>ZONE2/3-MONO</b>	L ch : ZONE2 speaker R ch : ZONE3 speaker	<div style="display: flex; justify-content: space-around;"> <div style="text-align: center;"> <p>MAIN ZONE</p>  (5.1)         </div> <div style="text-align: center;"> <p>ZONE2 or ZONE3</p>  (1)         </div> </div>
<b>Normal</b>	Surround Back L Speaker ※ Connect to the "L" speaker terminal. ※ Set "Surround Back" (☞ page 34) to "1spkr".	 (6.1)	<b>Front A Bi-Amp or Front B Bi-Amp</b>	Front A or B speakers ※ For connections, see "About Bi-amp Connections" (☞ page 13).	 (5.1)
<b>Normal</b>	Not connected ※ Set "Surround Back" (☞ page 34) to "None".	 (5.1)	<b>Front Height</b>	Front height Speakers	 (7.1)
<b>ZONE2 (Default)</b>	ZONE2 speakers	<div style="display: flex; justify-content: space-around;"> <div style="text-align: center;"> <p>MAIN ZONE</p>  (5.1)         </div> <div style="text-align: center;"> <p>ZONE2</p>  (2)         </div> </div>			
<b>ZONE3</b>	ZONE3 speakers	<div style="display: flex; justify-content: space-around;"> <div style="text-align: center;"> <p>MAIN ZONE</p>  (5.1)         </div> <div style="text-align: center;"> <p>ZONE3</p>  (2)         </div> </div>			

# Speaker Connections

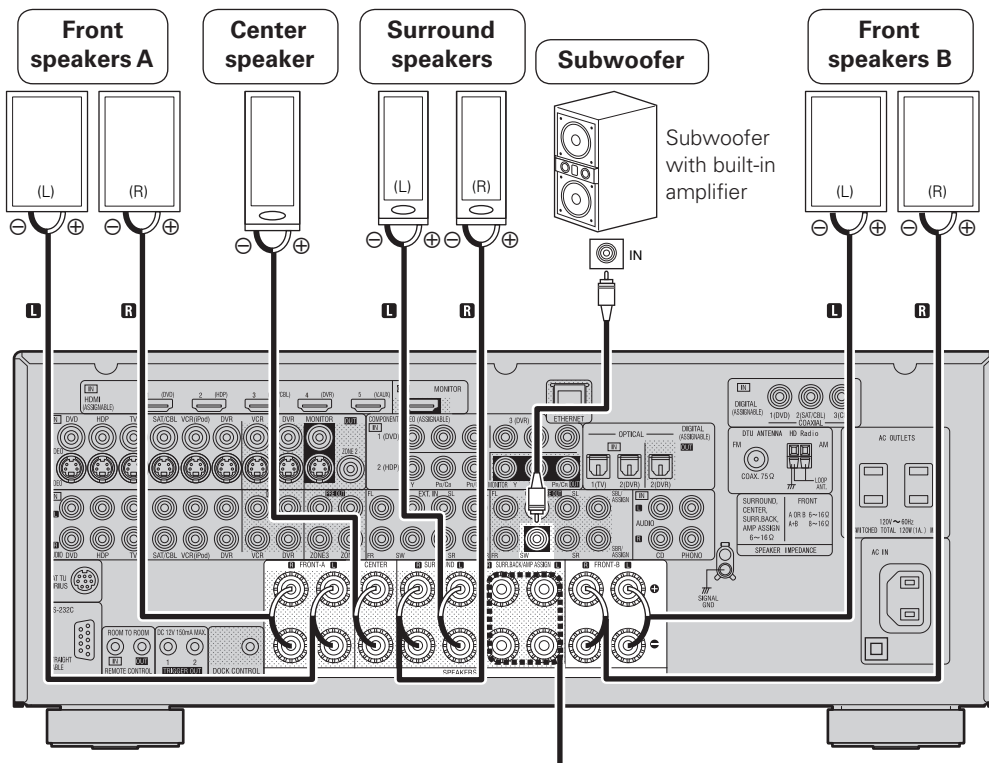

For connections of the SURR. BACK/AMP ASSIGN speaker terminals, see "Set the "Amp Assign" Mode According to the Speaker Layout" (page 12).





## Protection Circuit

If the core wires touch the rear panel and the screws etc., or the ± sides touch each other, the protection circuit will be activated and the power indicator will flash red at intervals of 0.5 secs. If the protection circuit is activated, the speaker output is isolated, and the power supply goes to the standby state. If the power supply is turned off, after the power supply cord is withdrawn, please confirm that speaker cable and input cable are connected. Also, if replaying large sound levels by using a speaker having an impedance less than that specified (eg, 4 Ω/ohms), the temperature will rise, and the protection circuit might be activated. The power supply will go into the standby state, and the power indicator will flash red at 2 second intervals.

In this case, please switch off the power supply, and wait until the AVR-3310CI has cooled down, and the surrounding ventilation is good. Even if there are no problems with the surrounding ventilation and connections, in the event of the protection circuit becoming activated, due to thinking that the AVR-3310CI has failed, please contact DENON Service center after switching off.

## Connecting the Speaker Cables

Carefully check the left (L) and right (R) channels and + (red) and – (black) polarities on the speakers being connected to the AVR-3310CI, and be sure to interconnect the channels and polarities correctly.

- 1** Peel off about 0.03 ft/10 mm of sheathing from the tip of the speaker cable, then either twist the core wire tightly or terminate it. 
- 2** Turn the speaker terminal counterclockwise to loosen it. 
- 3** Insert the speaker cable's core wire to the hilt into the speaker terminal. 
- 4** Turn the speaker terminal clockwise to tighten it. 

**When using a banana plug**  
Tighten the speaker terminal firmly before inserting the banana plug. 

**NOTE**  
Use speakers with an impedance of 6 to 16 Ω/ohms. When using front A and B speakers simultaneously, use speakers with an impedance of 8 to 16 Ω/ohms.

- NOTE**
- Connect so that the speaker cable core wires do not protrude from the speaker terminal. The protection circuit may be activated if the core wires touch the rear panel or if the + and – sides touch each other (see "Protection Circuit").
  - Never touch the speaker terminals while the power supply is connected. Doing so could result in electric shock.

## About Bi-amp Connections

These connections make for higher quality playback sound with no interference between the signals of the bass and treble units. When the "Amp Assign" setting (page 34) is "Front A Bi-Amp" or "Front B Bi-Amp", connect as follows. (The illustration shows a connection example for the Front A Bi-Amp speakers.)

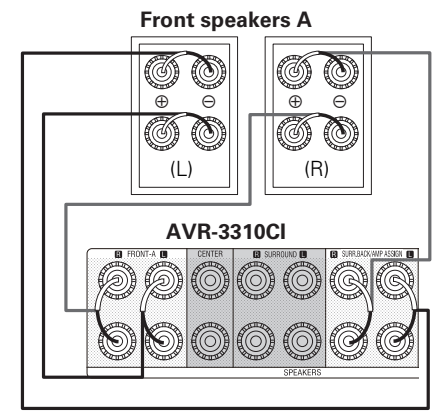

**NOTE**  
When in the "Front A Bi-Amp" and "Front B Bi-Amp" modes, the same signals are output from the front speaker terminals and the AMP ASSIGN terminals.

- NOTE**
- Use speakers compatible with bi-amp connections.
  - When making bi-amp connections, be sure to remove the short-circuiting plate or wire between the speaker's woofer and tweeter terminals.



# Connecting Devices

## Connecting Devices

- ❑ **Connecting Devices Equipped with HDMI Terminals** (🔗 page 14)
- ❑ **Connecting the Monitor** (🔗 page 15)
- ❑ **Connecting the Playback Components**
  - Blu-ray Disc Player / DVD Player (🔗 page 16)
  - Control dock for iPod (🔗 page 16)
  - CD Player (🔗 page 17)
  - Record Player (🔗 page 17)
- ❑ **Connecting the Recording Components**
  - Video Cassette Recorder (🔗 page 17)
  - Digital Video Recorder (🔗 page 18)
- ❑ **Connect the Tuner**
  - TV (🔗 page 18)
  - Satellite Receiver / Cable Tuner (🔗 page 19)
  - SIRIUS (🔗 page 19)
  - HD Radio (🔗 page 20)
- ❑ **Connections to Other Devices**
  - Video Camera / Game Console (🔗 page 21)
  - USB Port (🔗 page 21)
  - Component with Multi-channel Output connectors (🔗 page 21)
  - External Power Amplifier (🔗 page 22)
  - External Controller (🔗 page 22)
- ❑ **Connecting to a Home Network (LAN)** (🔗 page 23)

## Connecting Devices Equipped with HDMI Terminals

### Important Information

#### ❑ About HDMI

“HDMI” is the abbreviation of “High Definition Multimedia Interface”. This interface allows transfer of digital video signals and digital audio signals over a single HDMI cable.

“HDMI”, “HDMI logo” and “High-Definition Multimedia Interface” are trademarks or registered trademarks of HDMI Licensing LLC.

#### ❑ Functions Usable with HDMI Connections

##### Deep Color

Eliminates on-screen color banding, for smooth tonal transitions and subtle gradations between colors. Enables increased contrast ratio.

##### x.v.Color

Lets HDTVs display colors more accurately. Enables displays with natural, vivid colors. “x.v.Color” is a Sony registered trademark.

##### Auto Lip Sync (🔗 page 36)

If you connect the receiver to a TV that supports the Auto Lip Sync function, it can automatically correct delay between the audio and video.

##### HDMI Control Function (🔗 page 78)

This function allows you to operate external devices from the receiver and operate the receiver from external devices.

#### NOTE

- These functions will not work if the device connected to the HDMI terminal does not support Deep Color or x.v.Color signal transfer or the Auto Lip Sync function.
- The HDMI control function may not work depending on the device it is connected to and its settings.
- You cannot operate a TV or Blu-ray Disc player / DVD player that is not compatible with the HDMI control function.

#### ❑ Copyright Protection System (HDCP)

The AVR-3310CI supports HDCP (High-bandwidth Digital Contents Protection). HDCP is a copyright protection technology for digital video signals. The devices connected to the AVR-3310CI must also support HDCP.

#### NOTE

When a device that does not support HDCP is connected, video signals are not properly output.

## Connections

The AVR-3310CI allows connection of inputs from up to 5 HDMI devices and output to 1 monitor.

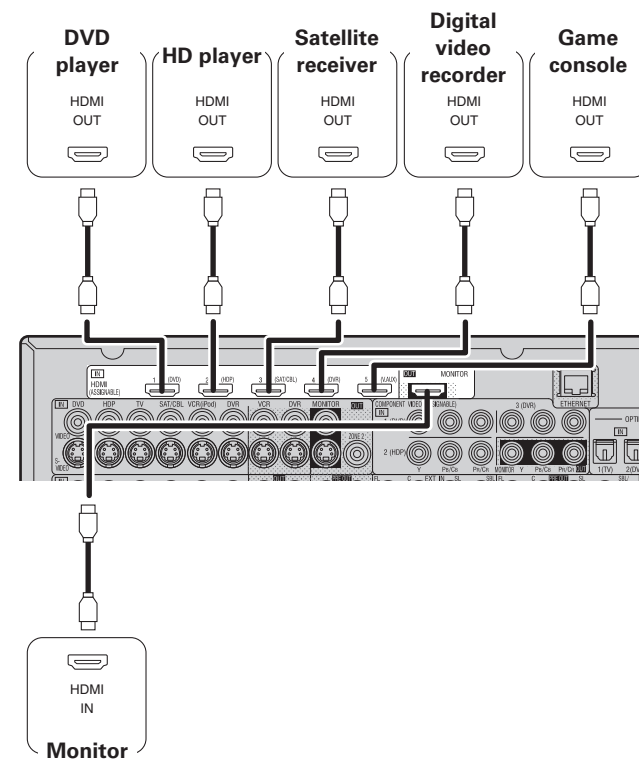

- Use a cable on which the HDMI logo is indicated (a certified HDMI product) for connection to the HDMI connector. Normal playback may not be possible when using a cable other than one on which the HDMI logo is indicated (a non-HDMI-certified product).
- When the AVR-3310CI is connected to other devices with HDMI cables, also connect the AVR-3310CI and TV using an HDMI cable.
- When a device supporting Deep Color signal transfer is connected, use a cable compatible with HDMI version 1.3a.
- Video signals are not output if the input video signals do not match the monitor's resolution. In this case, switch the Blu-ray Disc/DVD player's resolution to a resolution with which the monitor is compatible.

## Connecting Devices

### NOTE

- If the GUI menu “Audio Out” setting (page 36) is set to “AMP”, the sound may be interrupted when the monitor’s power is turned off.
- The audio signal from the HDMI output terminal (sampling frequency, number of channels, etc.) may be limited by the HDMI audio specifications of the connected device regarding permissible inputs.

### Connecting to a Device Equipped with a DVI-D Terminal

When an HDMI/DVI conversion cable (sold separately) is used, the HDMI video signals are converted to DVI signals, allowing connection to a device equipped with a DVI-D terminal.

### NOTE

- No sound is output when connected to a device equipped with a DVI-D terminal. Also make the audio connections.
- Signals cannot be output to DVI-D devices that do not support HDCP.
- Depending on the combination of devices, the video signals may not be output.

## Settings Related to HDMI Connections

Set as necessary. For details, see the respective reference pages.

- **Input Assign** (page 45)  
Set this to change the HDMI input terminal to which the input source is assigned.

- **HDMI Setup** (page 36)  
Make settings for HDMI video/audio output.
  - RGB Range
  - Audio Out
  - Auto Lip Sync
  - HDMI Control

### NOTE

The audio signals output from the HDMI connectors are only the HDMI input signals.

## Connecting the Monitor

- Select the terminal to use and connect the device.
- For video connections, see “Converting Input Video Signals for Output (Video Conversion Function)” (page 10).

For instructions on HDMI connections, see “Connecting Devices Equipped with HDMI Terminals” on page 14.

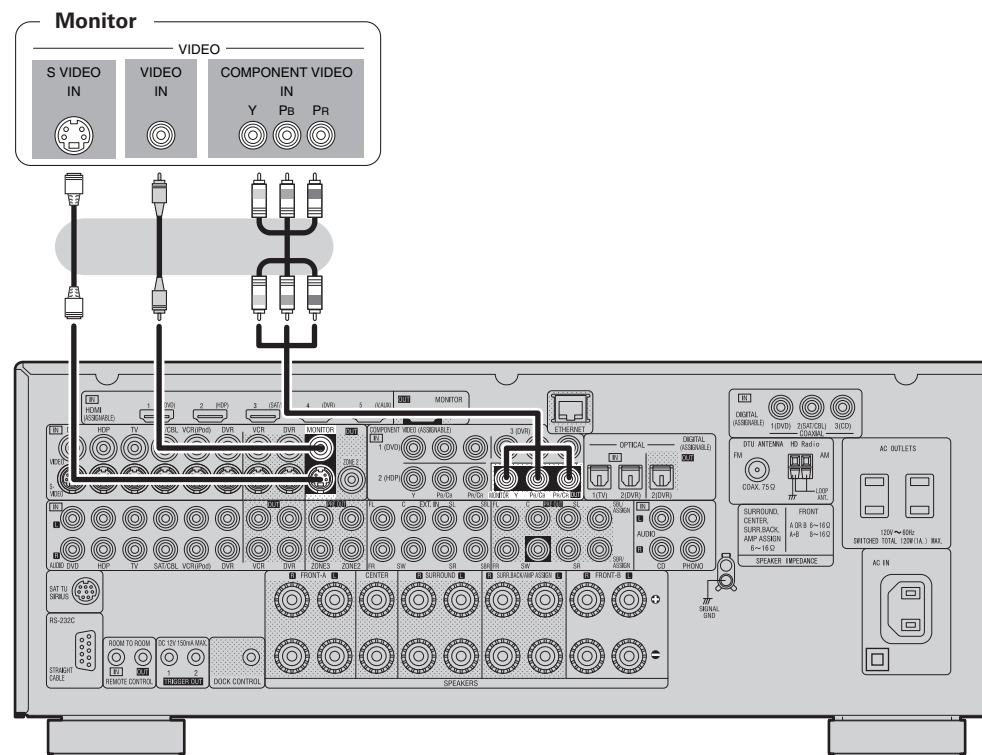

To listen to TV audio through this device, use the optical digital or analog connection.

## Connecting the Playback Components

### Blu-ray Disc Player / DVD Player

Select the terminal to use and connect the device.

For instructions on HDMI connections, see "Connecting Devices Equipped with HDMI Terminals" on page 14.

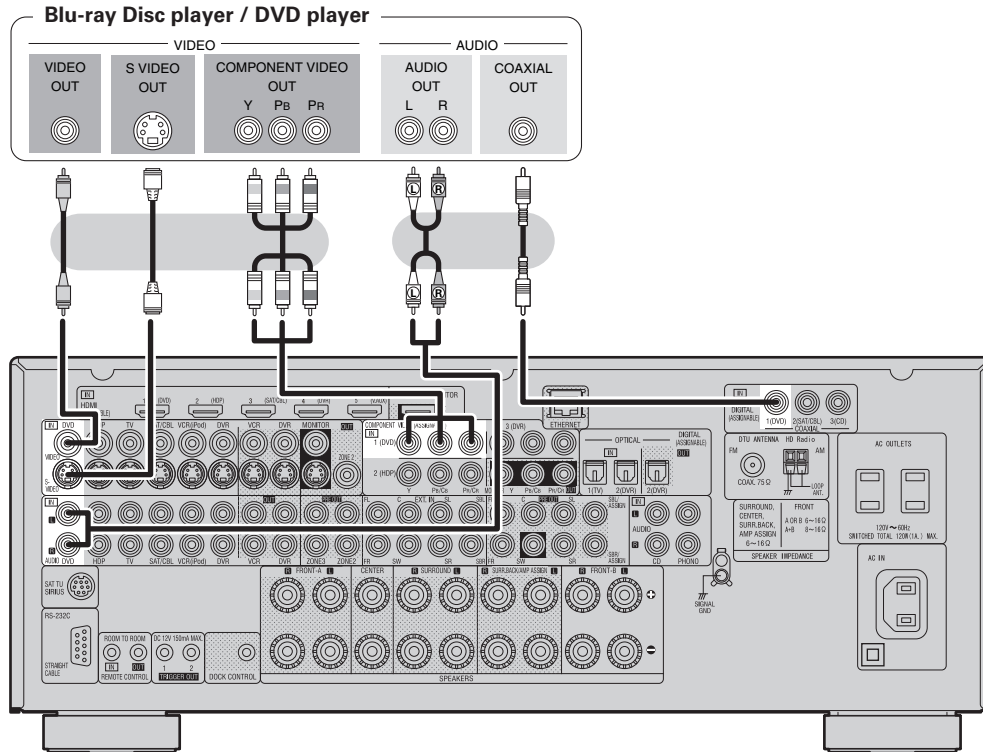

### Control Dock for iPod

Use a DENON control dock for iPod (ASD-1R or ASD-11R, sold separately) to connect the iPod to the AVR-3310CI. For instructions on the control dock for iPod settings, refer to the control dock for iPod's operating instructions.

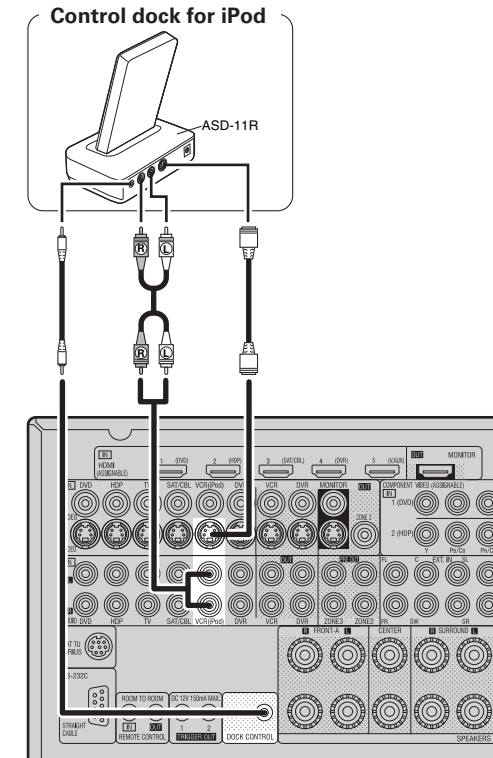

#### Set as Necessary

Set this to change the input signal to which the input source is assigned.  
**"Input Assign"** (page 45)

#### NOTE

In the case of HD audio (Dolby TrueHD, DTS-HD and Dolby Digital Plus and DTS Express) audio playback, connect with HDMI (page 14, "Connecting Devices Equipped with HDMI Terminals").

#### Set as Necessary

Set other than when iPod is assigned to the VCR (iPod) terminal.  
**"Input Assign" - "iPod dock"** (page 47)



With the default settings, the iPod can be used connected to the VCR (iPod) connector.

## Connecting Devices

### CD Player

Select the terminal to use and connect the device.

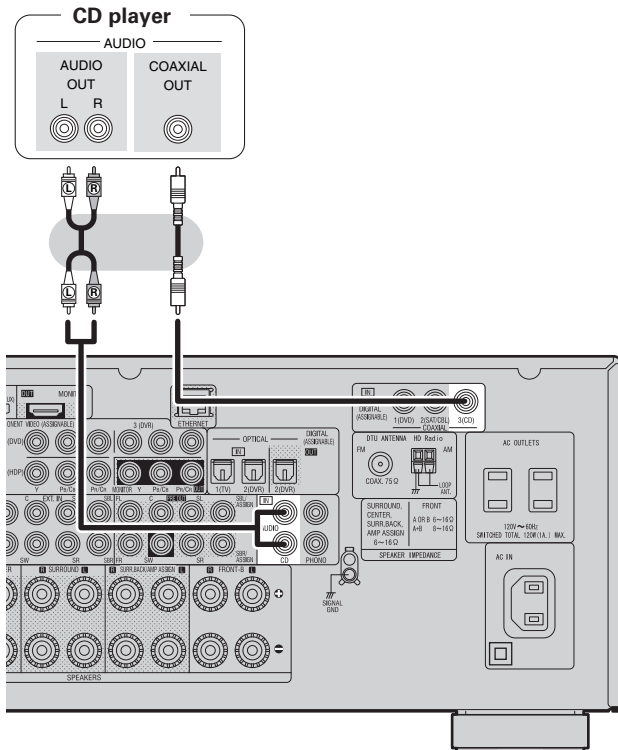

#### Set as Necessary

Set this to change the input signal to which the input source is assigned.

**"Input Assign"** (page 45)

### Record Player

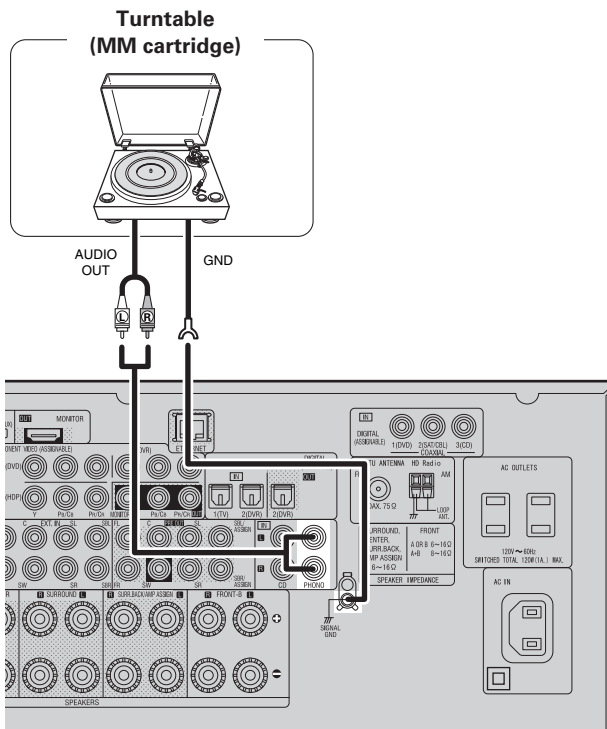

- The AVR-3310CI is compatible with record players with an MM cartridge. When you connect to a record player with an MC cartridge, use a commercially available MC head amp or a step-up transformer.
- When you increase the volume without connecting the record player, there may be "booming" noise from the speakers.

#### NOTE

The SIGNAL GND terminal of the AVR-3310CI is not a safety ground connection. Connect it to reduce noise when noise is excessive. Note that depending on the record player, connecting the ground line may have the reverse effect of increasing noise. In this case, it is not necessary to connect the ground line.

## Connecting the Recording Components

### Video Cassette Recorder

Select the terminal to use and connect the device.

For instructions on HDMI connections, see "Connecting Devices Equipped with HDMI Terminals" on page 14.

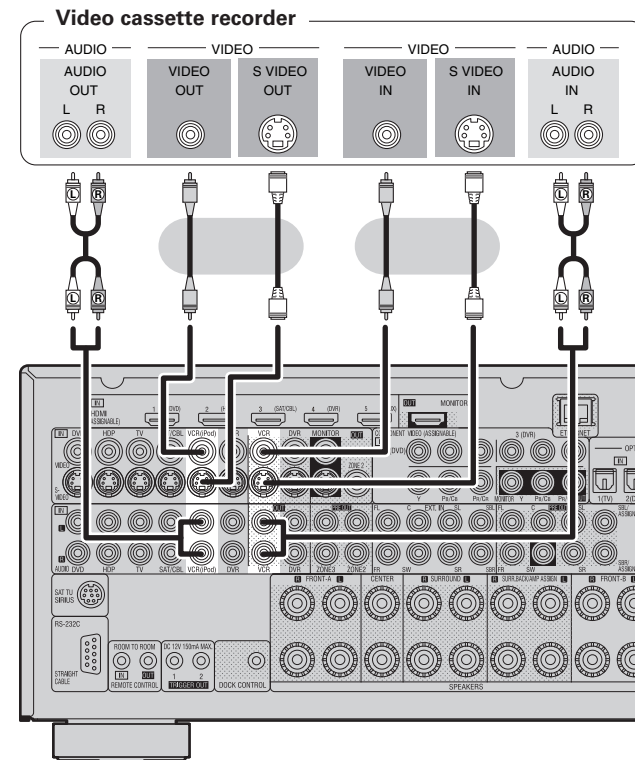

#### Set as Necessary

Set this to change the input signal to which the input source is assigned.

**"Input Assign"** (page 45)

#### NOTE

To record video signals through the AVR-3310CI, use the same type of video cable for connection between the AVR-3310CI and the player as the cable used for connection between the AVR-3310CI and the recorder.

## Digital Video Recorder

Select the terminal to use and connect the device.

For instructions on HDMI connections, see “Connecting Devices Equipped with HDMI Terminals” on page 14.

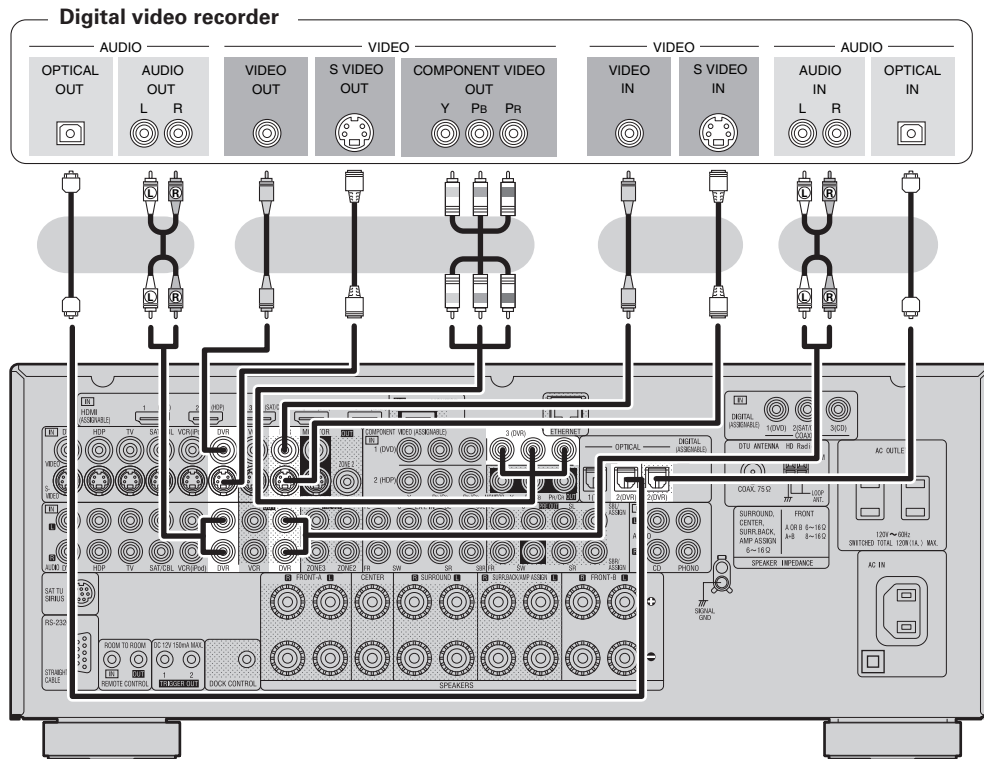

### Set as Necessary

Set this to change the input signal to which the input source is assigned.  
**“Input Assign”** (🔧 page 45)

### NOTE

- To record video signals through the AVR-3310CI, use the same type of video cable for connection between the AVR-3310CI and the player as the cable used for connection between the AVR-3310CI and the recorder.
- Do not connect the output of the component connected to the AVR-3310CI’s OPTICAL2 (DVR) output connector to any input connector other than OPTICAL2 (DVR).

## Connect the Tuner

### TV

Select the terminal to use and connect the device.

For instructions on HDMI connections, see “Connecting Devices Equipped with HDMI Terminals” on page 14.

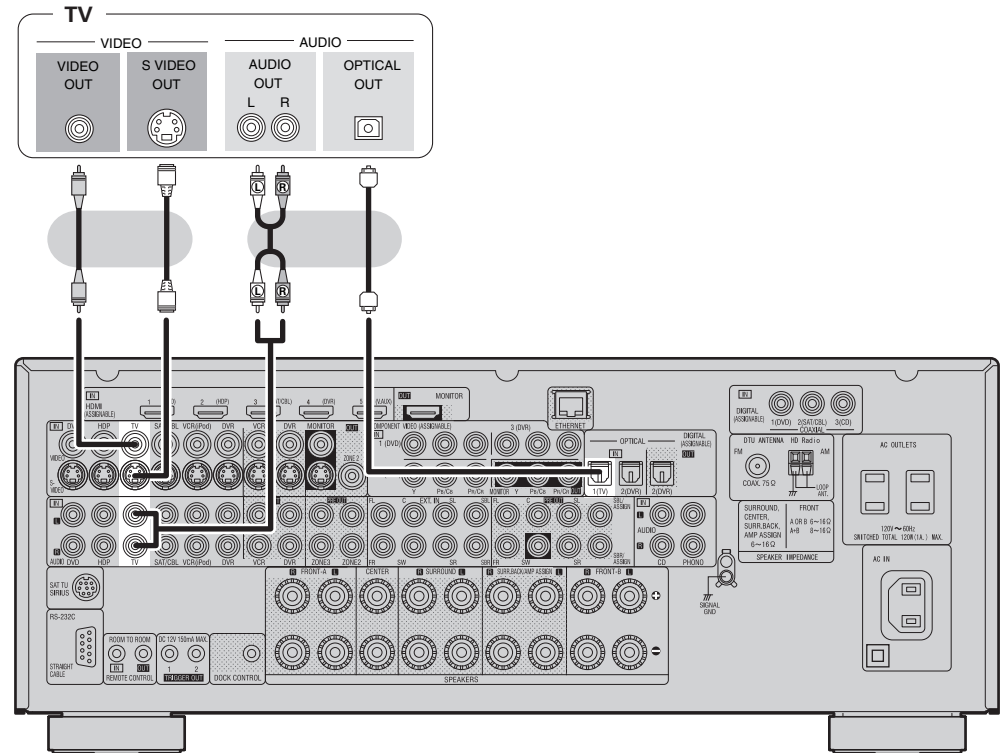

### Set as Necessary

Set this to change the input signal to which the input source is assigned.  
**“Input Assign”** (🔧 page 45)

Connecting Devices

Satellite Receiver / Cable Tuner (Set Top Box)

Select the terminal to use and connect the device.

For instructions on HDMI connections, see "Connecting Devices Equipped with HDMI Terminals" on page 14.

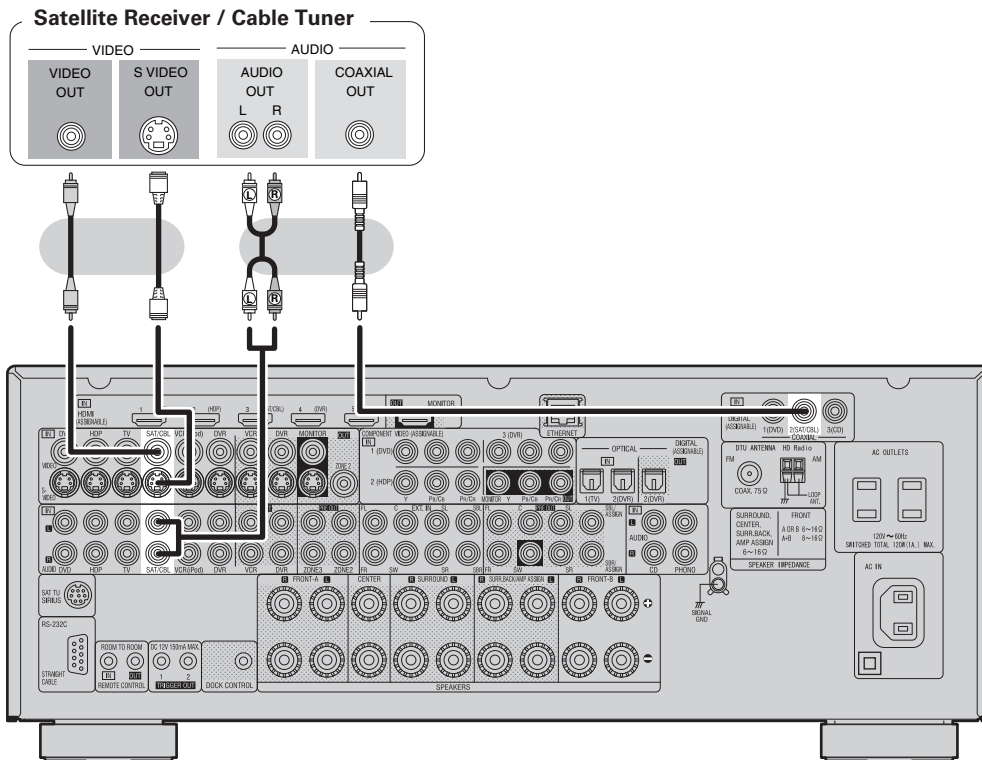

Set as Necessary

Set this to change the input signal to which the input source is assigned.  
"Input Assign" (page 45)

SIRIUS Connector

- The AVR-3310CI is a SIRIUS Satellite Radio Ready® receiver. You can receive SIRIUS® Satellite Radio by connecting to the SiriusConnect Home Tuner and subscribing to the SIRIUS service.
  - Plug the SIRIUS connector on the rear panel.
  - Position the Home Tuner antenna near a south-facing window to receive the best signal.
- For details, see "Listening to SIRIUS Satellite Radio" (page 55).  
When making connections, also refer to the operating instructions of the SiriusConnect Home Tuner.

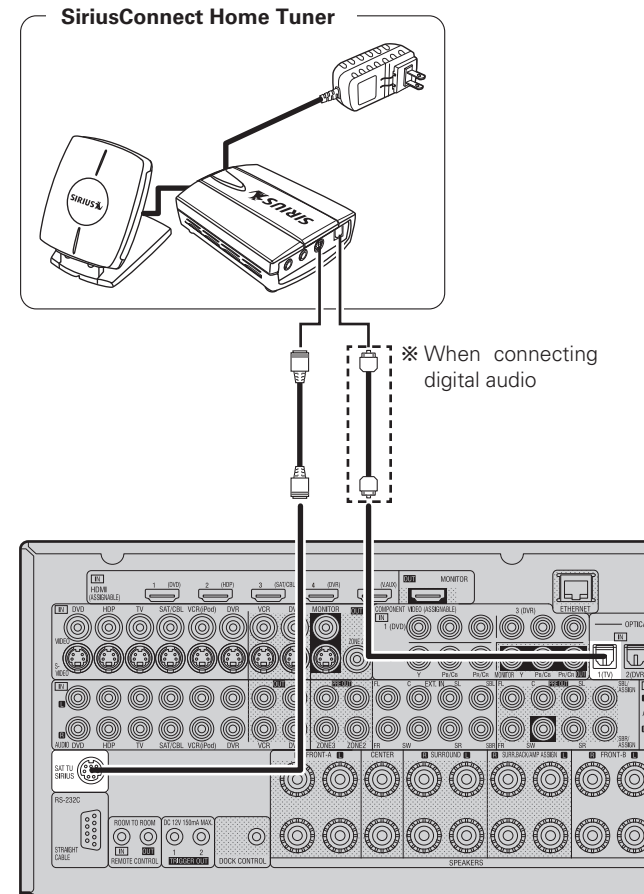

Set as Necessary

When connecting digital of the SiriusConnect Home Tuner, perform the setting "Digital".  
"Input Assign" (page 45)

**NOTE**

Keep the power cord unplugged until the SiriusConnect Home Tuner connection have been completed.

SIRIUS, XM and all related marks and logos are trademarks of Sirius XM Radio Inc. and its subsidiaries. All rights reserved. Service not available in Alaska and Hawaii.

**Positioning the Antenna**

For a consistent satellite signal, the antenna must be positioned correctly. Use the following map to determine which area you are in and position the antenna accordingly.

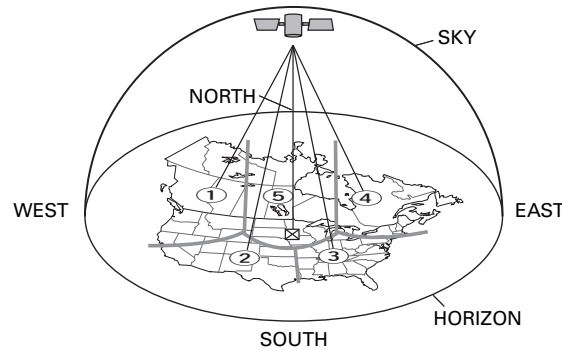

- Area 1** : Point the antenna toward the sky in the **east, northeast, or southeast**, either through a window or outside.
- Area 2** : Point the antenna toward the sky in the **north or northeast**, either through a window or outside.
- Area 3** : Point the antenna toward the sky in the **north or northwest**, either through a window or outside.
- Area 4** : Point the antenna toward the sky in the **west, northwest, or southwest**, either through a window or outside.
- Area 5** : Put the antenna outside and point it **straight up**. The antenna cannot be used indoors.

**HD Radio Terminals**

HD Radio is a service that is only available within the United States.

AM loop antenna (for HD Radio broadcasting, supplied)

- To prevent interference, install at least 3.3 feet/ 1 m away from the antenna connected to the AVR-3310CI's other AM tuner terminal.

Direction of broadcasting station

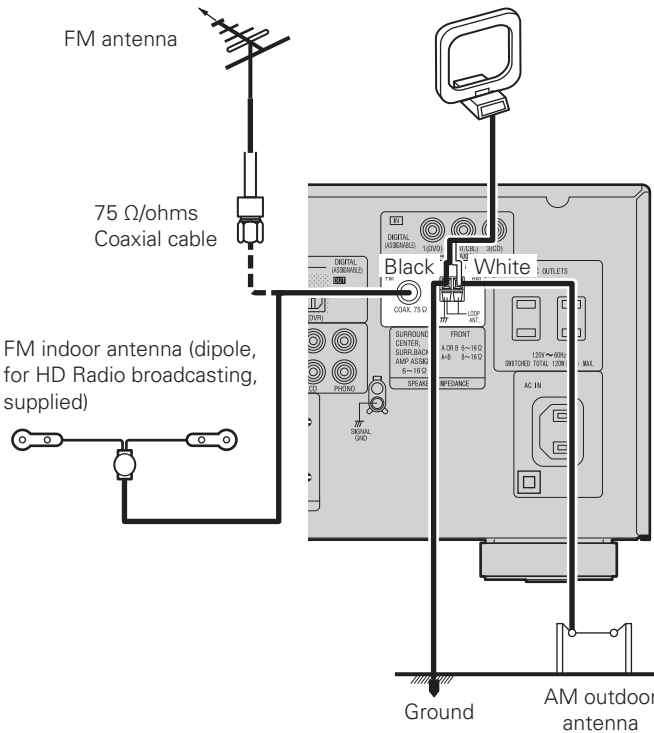

**AM loop antenna assembly**

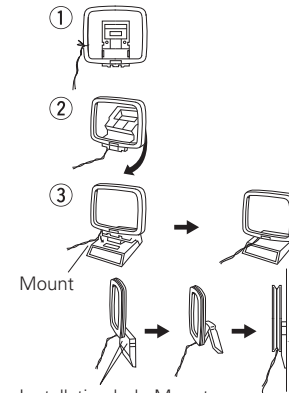

Remove the vinyl tie and take out the connection line.

Bend in the reverse direction.

a. With the antenna on top of any stable surface.

b. With the antenna attached to a wall.

Mount Installation hole Mount on wall, etc.

**Connection of AM antennas**

1. Push the lever.
2. Insert the conductor.
3. Return the lever.



**NOTE**

- Do not connect two FM antennas simultaneously.
- Even if an external AM antenna is used, do not disconnect the AM loop antenna.
- Make sure the AM loop antenna lead terminals do not touch metal parts of the panel.

Connecting Devices

Connections to Other Devices

Video Camera / Game Console

Select the terminal to use and connect the device.

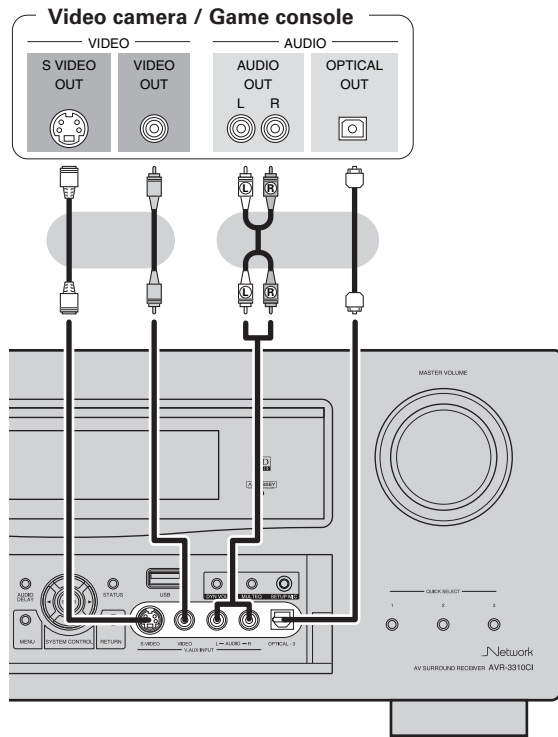

Set as Necessary

Set this to change the input signal to which the input source is assigned.  
**"Input Assign"** (page 45)

USB Port

When you connect a USB memory device to the USB port, you can enjoy music, etc., stored on the USB memory device.

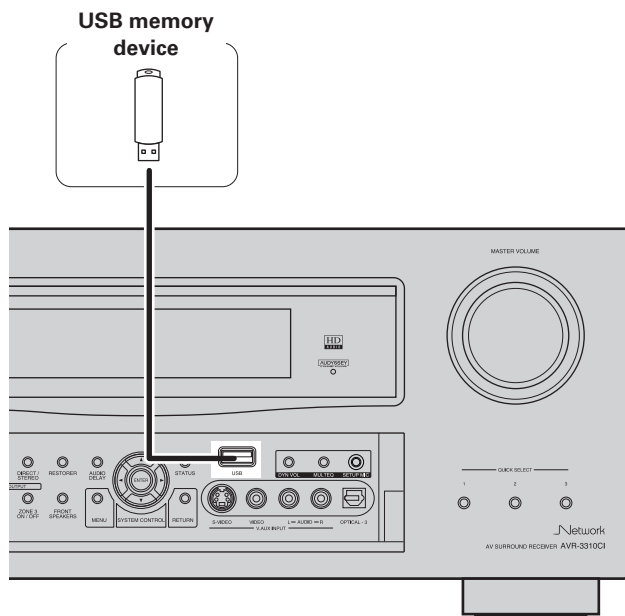

NOTE

Do not use an extension cable when connecting a USB memory device. This may cause radio interference with other devices.

Component with Multi-channel Output connectors

The video signal can be connected in the same way as a Blu-ray Disc player / DVD player (page 16 "Blu-ray Disc Player / DVD Player").

Blu-ray Disc player / DVD player / External decoder

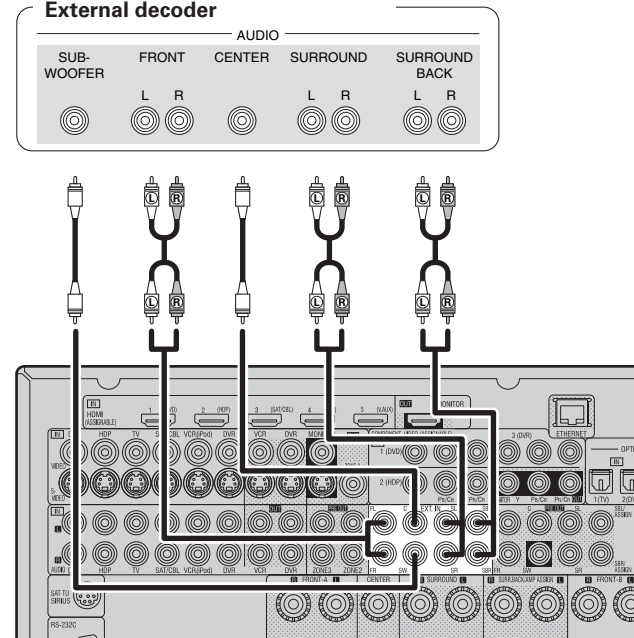

Set as Necessary

To play analog signals input from the external input (EXT. IN) terminal, set "Input Mode" (page 49) to "EXT. IN".  
 "EXT. IN" can also be selected with **[INPUT MODE]** on the main remote control unit.



When a device is connected to the SBL/SBR terminal of the external input terminals (EXT. IN), set "Amp Assign" (page 34) to "Normal".



## External Power Amplifier

- Select the terminal to use and connect the device.
- Connect when using an external power amp or an amp you already have.

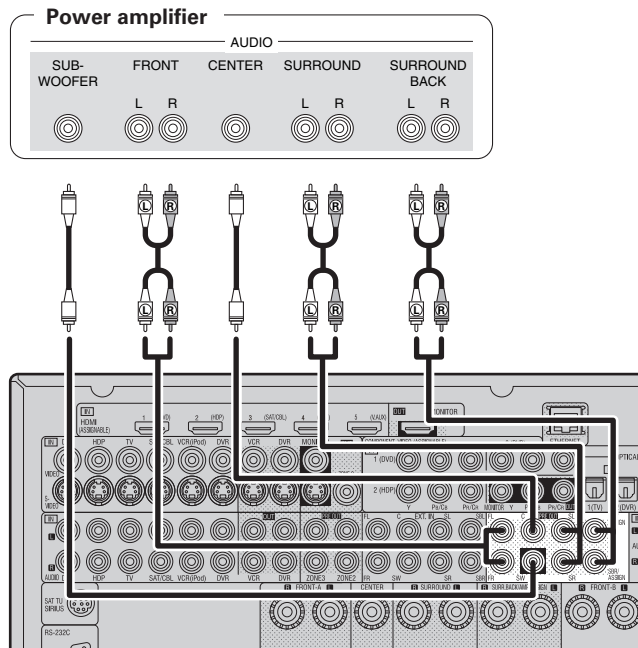

- When using just one surround back speaker, connect it to the left channel (L).
- Use the volume control on the subwoofer to control subwoofer volume.
- If the subwoofer volume sounds low, use the volume control provided on the subwoofer to adjust the volume.

### NOTE

- When speakers have been connected to PRE OUT terminals, do not connect the speakers to the speaker terminals.
- The channel output from the PRE OUT SBL and SBR terminals changes depending on the "Amp Assign" setting (page 34).

## External Controller

### RS-232C connector

When you connect an external control device, you can control the AVR-3310CI with the external control device. Perform the operation below beforehand.

- ① Turn on the AVR-3310CI's power.
- ② Turn off the AVR-3310CI's power from the external controller.
- ③ Check that the AVR-3310CI is in the standby mode.

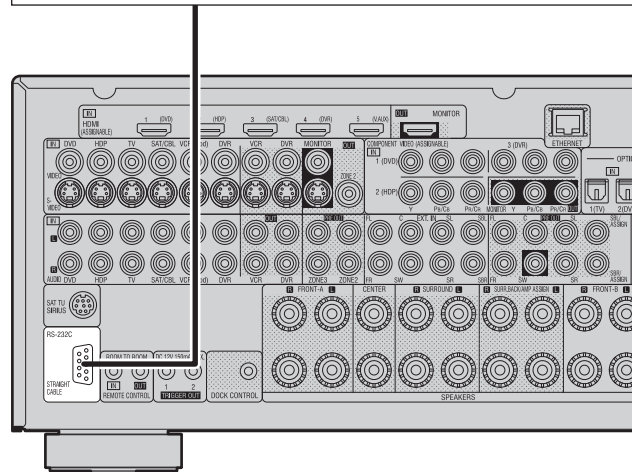

### Set as Necessary

Set this to use the RS-232C connector for the DENON RF remote controller.  
**"232C Port"** (page 43)



When using the AVR-3310CI in combination with the DENON RF remote controller (RC-7000CI, sold separately) or RF remote receiver (RC-7001RCI, sold separately), two-way communication is enabled. The AVR-3310CI's status information as well as iPod and Internet audio music files can be browsed watching the RF Remote Controller's display. For details, refer to the operating instructions of the respective devices.

### NOTE

On the GUI menu, when setting "232C Port" to "2Way Remote", you cannot use the RS-232C connector as an external controller (page 43).

## REMOTE CONTROL jacks

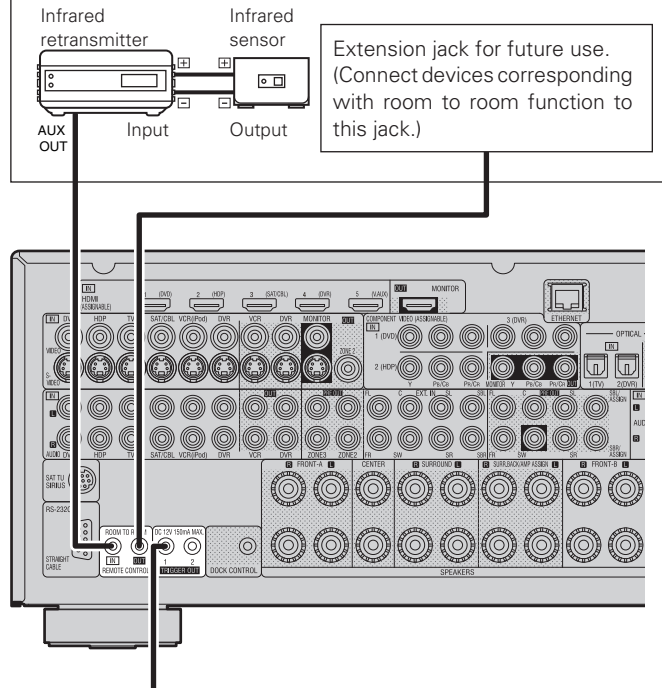

### TRIGGER OUT jacks

The TRIGGER OUT output terminal outputs a maximum 12 V/150 mA electrical signal. When a device with TRIGGER IN terminal is connected via a monaural mini-plug, the connected device's power on/standby can be controlled through linked operation to the AVR-3310CI.

### Set as Necessary

Set to change the conditions for linked operation via the TRIGGER OUT 1 or TRIGGER OUT 2 terminal.  
**"Trigger Out1"** or **"Trigger Out2"** (page 43)



When connecting a 2nd device, connect to the TRIGGER OUT 2 terminal in the same way as the TRIGGER OUT 1 terminal.

Connecting Devices

Connecting to a Home Network (LAN)

When you connect the AVR-3310CI to a home network, you can enjoy listening to music files stored on your PC, internet radio audio and other sources. You can also control the AVR-3310CI from your PC via the Web browser.

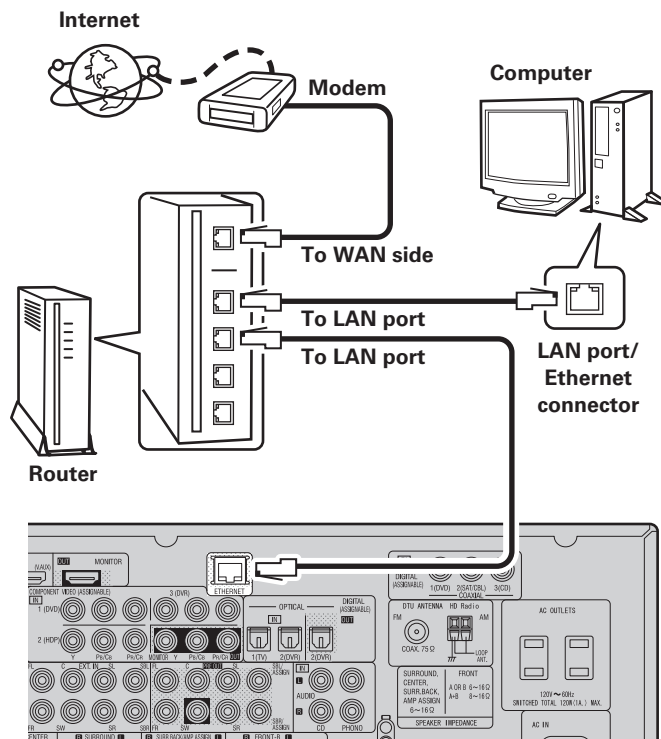

For connections to the Internet, contact an ISP (Internet Service Provider) or a computer shop.

Required system

❑ Broadband Internet connection

❑ Modem

❑ Router

When using the AVR-3310CI, we recommend you use a router equipped with the following functions:

- Built-in DHCP server  
This function automatically assigns IP addresses on the LAN.
- Built-in 100BASE-TX switch  
When connecting multiple devices, we recommend a switching hub with a speed of 100 Mbps or greater.

❑ Ethernet cable (CAT-5 or greater recommended)

Some flat type Ethernet cables are easily affected by noise. We recommend using a normal type cable.

❑ Computer  
[Recommended system]

- OS :  
Windows® XP Service Pack2 or later, Windows Vista
  - Software (Prepare one of the following.)
    - Windows Media Player ver.11
    - DLNA-compatible server software
  - Internet browser :  
Microsoft Internet Explorer 6 or later
  - LAN port
  - 300 MB or more free disk space
- ※ Operation is possible with DLNA servers other than the above, but such DLNA servers are not supported. For details, check the Web.

NOTE

- A contract with an ISP is required to connect to the Internet. No additional contract is needed if you already have a broadband connection to the Internet.
- The types of routers that can be used depend on the ISP. Contact an ISP or a computer shop for details.
- Depending on the server, video files may be displayed, but they cannot be played on the AVR-3310CI.



- If you have an Internet provider contract for a line on which network settings are made manually, make the settings at “Network Connecting” (page 38).
- With the AVR-3310CI, it is possible to use the DHCP and Auto IP functions to make the network settings automatically.
- When using the AVR-3310CI with the broadband router’s DHCP function enabled, the AVR-3310CI automatically performs the IP address setting and other settings. When using the AVR-3310CI connected to a network with no DHCP function, make the settings for the IP address, etc., at “Network Connecting” (page 38).
- The AVR-3310CI is not compatible with PPPoE. A PPPoE-compatible router is required if you have a contract for a line of the type with which the PPPoE is set.
- Depending on the ISP with which you have your contract, it may be necessary to make proxy server settings to use the Internet radio function. If you made proxy server settings on the computer to connect to the Internet, make the proxy server settings on the AVR-3310CI in the same way.

## Connecting the Power Cord

Wait until all connections have been completed before connecting the power cord.

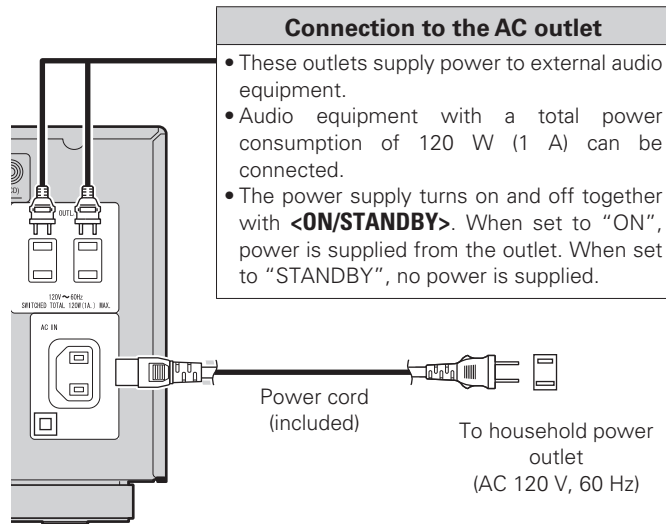

### NOTE

- Insert the AC plugs securely. Incomplete connections could cause noise.
- Only use the AC outlets to plug in audio equipment. Do not use them as power supplies for hairdryers or anything other than audio equipment.

**Symbols used to indicate buttons in this manual**

- Button located on both the main unit and the remote control unit → **BUTTON**
- Button only on the main unit → **<BUTTON>**
- Button only on the remote control unit → **[BUTTON]**

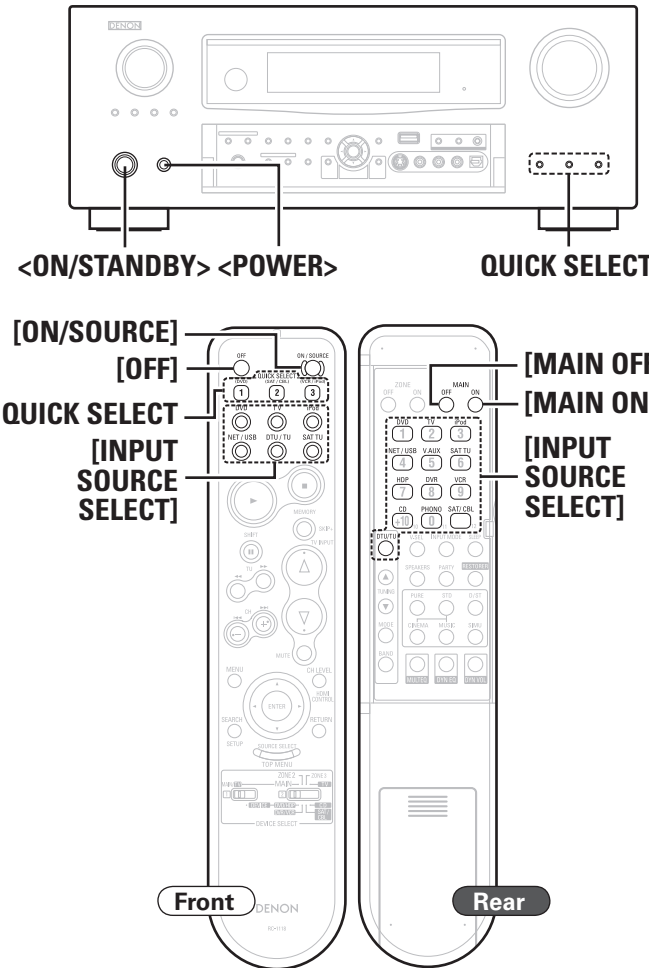

## Once Connections are Completed

### Turning the Power On

- 1 Press <POWER>**.  
The power indicator lights red and the power is set to the standby mode.
- 2 Press [ON/SOURCE] or <ON/STANDBY>**.  
The power indicator flashes green and the power turns on.

※ Also press **[INPUT SOURCE SELECT]** or **QUICK SELECT** when in standby mode, the power turns on.  
When **[INPUT SOURCE SELECT]** has been pressed, the input source set with the **[INPUT SOURCE SELECT]** is set. If a **QUICK SELECT** has been pressed, the input source stored in the memory for the quick select function is set (see page 80 "Saving Frequently Used Settings (Quick Select Function)").

### Turning the Power Off

- 1 Press [OFF] or <ON/STANDBY>**.  
The power is set to the standby mode.
- 2 Press <POWER>**.  
The power indicator turns off, and so does the power.

### NOTE

- Power continues to be supplied to some of the circuitry even when the power is in the standby mode. When leaving home for long periods of time or when traveling, either press **<POWER>** to turn off the power, or unplug the power cord from the power outlet.
- When using ZONE2 or ZONE3, it is possible to turn the power for the MAIN ZONE only on or off by pressing **[MAIN ON]** or **[MAIN OFF]**.

# Settings



## GUI Menu Map



Pressing **MENU** displays the GUI menu. From this menu, you can move to various setting screens.

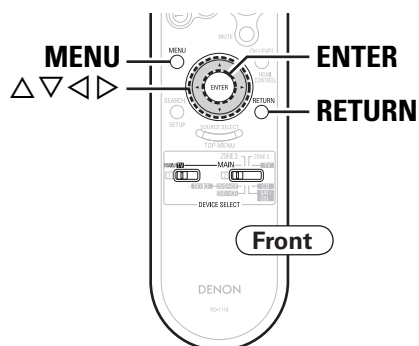

Setting items	Detailed items	Description	Page
<b>Audio / Video Adjust</b> Adjust various audio and video parameters.	<b>Audio Adjust</b>	Adjust various audio parameters.	71
	<b>Picture Adjust</b>	Adjust various video parameters.	75
<b>Information</b> Show information about receiver settings, input signals, etc.	<b>Status</b>	Shows information about current settings.	76
	<b>Audio Input Signal</b>	Shows information about audio input signals.	76
	<b>HDMI Information</b>	Shows information about HDMI input/output signals and monitor.	76
	<b>Auto Surround Mode</b>	Shows information about settings stored for the auto surround mode.	76
	<b>Quick Select</b>	Shows information about settings stored for the Quick Select function.	76
<b>Auto Setup</b> Makes the optimum speaker settings and corrects for the acoustic characteristics of the room.	<b>Preset Channel</b>	Shows information about preset channels.	76
	<b>Audyssey™ Auto Setup</b>	Makes the optimum settings for the speakers being used automatically.	28
<b>Manual Setup</b> Use this to make various types of detailed settings.	<b>Parameter Check</b>	Check Audyssey Auto Setup measurement results. This item is only displayed after Audyssey Auto Setup procedure has been performed.	33
	<b>Speaker Setup</b>	Sets the speaker size and distance, the channel level, etc.	34
<b>Input Setup</b> Use this to make settings related to playing input sources.	<b>HDMI Setup</b>	Make settings for HDMI video/audio output.	36
	<b>Audio Setup</b>	Make settings for audio playback.	37
	<b>Network Setup</b>	Make network settings.	38
	<b>Zone Setup</b>	Make settings for audio playback in the multi-zone system.	41
	<b>Option Setup</b>	Make various other settings.	41
<b>Input Setup</b> Use this to make settings related to playing input sources.	<b>Auto Preset</b>	Use the auto preset function to program radio stations.	50
	<b>Preset Skip</b>	Set the preset memories that you do not want to display when tuning.	50
	<b>Preset Name</b>	Assign name to a preset memory.	51
	<b>Parental Lock</b>	Set the Parental Lock.	51
	<b>Antenna Aiming</b>	Adjust the SIRIUS reception sensitivity.	51
	<b>Input Assign</b>	Change input connector assignment.	45
	<b>Video</b>	Makes the video settings.	48
	<b>Input Mode</b>	Sets the audio input mode and decode mode.	49
	<b>Rename</b>	Change the display name for this source.	49
	<b>Source Level</b>	Adjust the playback level of the audio input.	49
<b>Playback Mode (for iPod)</b>	Make settings for "iPod" playback.	50	
<b>Playback Mode (for NET/USB)</b>	Make settings for "NET/USB" playback.	50	
<b>Still Picture</b>	Make settings for still picture playback.	50	

# GUI Menu Operation



When a TV is connected to the AVR-3310CI, the GUI menu, sound field parameters, etc., can be displayed on the TV. This allows you to operate the AVR-3310CI and make settings on it while looking at the GUI menu displayed on the TV.

**1 Press MENU.**  
The GUI menu is displayed on the TV screen.

**2 Press  $\Delta$   $\nabla$   $\triangleleft$   $\triangleright$  to select the menu to be set or operated.**  
※ To return to the previous item, press  $\triangleleft$  or RETURN.

**3 Press RETURN to enter the setting.**  
※ Select "Default", then press ENTER to reset to the default setting.

**Exiting the GUI Menu**  
Press MENU while the GUI menu is displayed. The GUI menu display disappears.

## Example of the Display of the GUI Mark at a Title

Items for which this mark is indicated at the title can be operated from the GUI. We recommend performing such operations from the GUI.

## Making Detailed Settings (Manual Setup)

## Examples of GUI Menu Screen Displays

Typical examples are described below.

### (Example 1) Menu selection screen (Top menu)

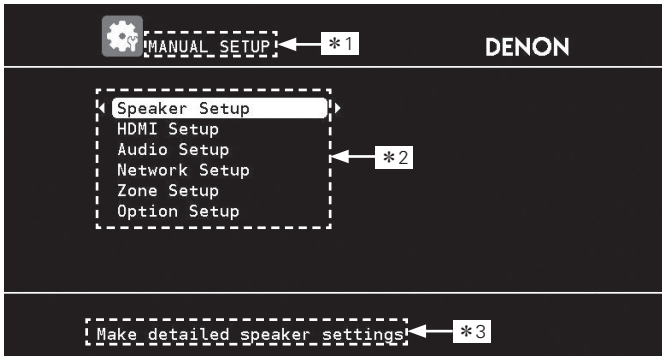

- \* 1 : Currently selected setup item
- \* 2 : List of currently selected setup items
- \* 3 : Guide text for the currently selected setup item

Press  $\nabla$  to select "HDMI Setup" and then press  $\triangleright$ . (Or press ENTER.)

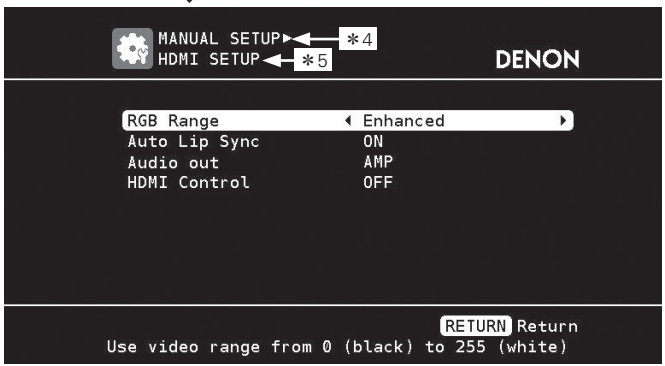

- \* 4 : History item
- \* 5 : Currently selected setup item

### (Example 2) Audyssey Auto Setup screen (with illustration)

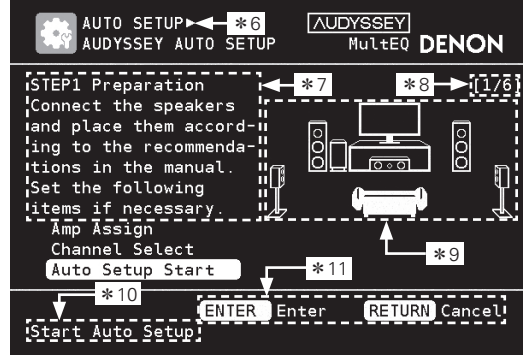

- \* 6 : History item
- \* 7 : Operation guidance text
- \* 8 : Operation step
- \* 9 : Illustration
- \* 10 : Guide text for the currently selected setup item
- \* 11 : Operation button guidance

### List

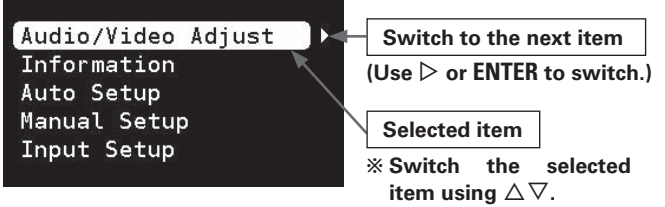

## GUI Menu Operation

## Selecting the Input Source

There are three ways to select the input source, as described below.

- ① Selecting the input source using the Source Select menu (GUI menu)
- ② Selecting the input source using the **[INPUT SOURCE SELECT]** (Main remote control unit)
- ③ Selecting the input source using the **<SOURCE SELECT>** (Main unit)

## ① Using the Input Setup Menu

The input source can also be selected using the source selection menu.

- 1** Set **[DEVICE SELECT 1]** to “MAIN/TV” and **[DEVICE SELECT 2]** to “MAIN”.

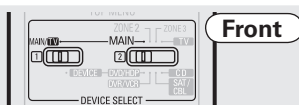

- 2** Press **[SOURCE SELECT]**.  
Display the “Source Select” menu.

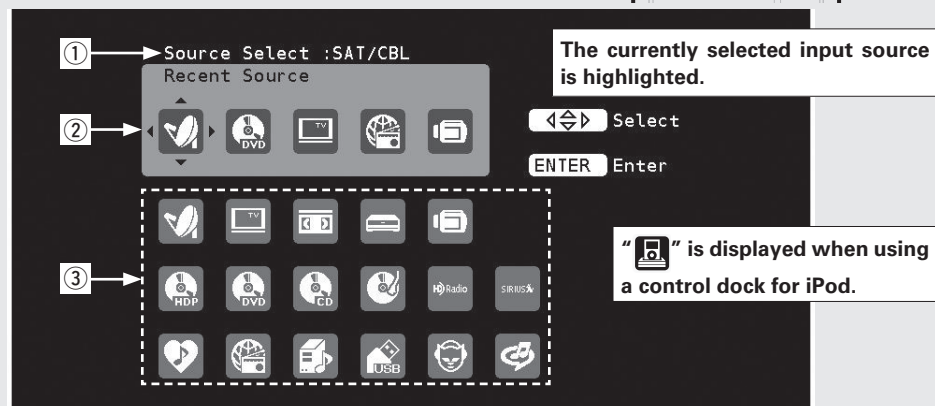

- ① **Input Source** : The name of the highlighted input source is displayed.
- ② **Recently used sources** : The recently used input sources (up to 5) are displayed.
- ③ Icons for the input sources in the different categories are displayed.

Video : (SAT/CBL), (TV), (VCR), (DVR), (V.AUX)

Player : (HDP), (DVD), (CD), (PHONO)

Tuner : (HD Radio), (SIRIUS)

Network: (Favorites), (Internet Radio), (Media Server), (USB), (Napster), (Rhapsody)

- 3** Use  $\Delta \nabla \triangle \blacktriangleleft$  to select the input source icon, then press **ENTER**.  
The input source is set and the source selection menu is turned off.



- Use the device selection buttons on the main remote control unit to set the device to be operated beforehand.
- When using with an iPod connected directly to the AVR-3310CI's USB port, select “USB” for the input source.
- Input sources that are not going to be used can be set ahead of time. Make this setting at “Source Delete” (page 42).
- To turn off the source selection menu without selecting an input source, press **[SOURCE SELECT]** again.

## ② Operating on the Main Remote Control Unit

- 1** Set **[DEVICE SELECT 1]** to “MAIN/TV” and **[DEVICE SELECT 2]** to “MAIN”.

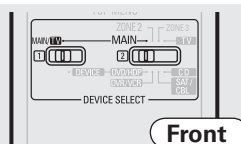

- 2** Press **[INPUT SOURCE SELECT]**.  
The desired input source can be selected directly.

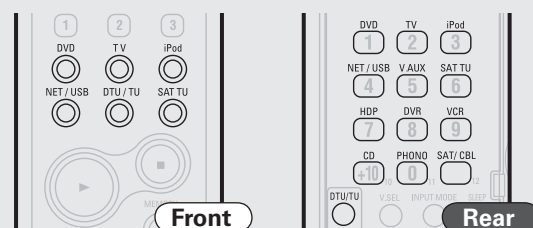

## ③ Operating on the Main Unit

Turn **<SOURCE SELECT>**.

- ※ If “ZONE2/3/ Rec Select”, “Video Select” or “Tuning Preset” mode is selected for the input source, press **<SOURCE>** before turning the **<SOURCE SELECT>**.

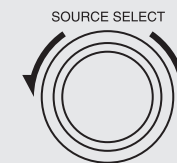



# Make the Optimal Speaker Settings, and Correct the Room Acoustics (Audyssey™ Auto Setup)



The acoustic characteristics of the connected speakers and listening room are measured and the optimum settings are made automatically.

## Audyssey Auto Setup Flow

**1 Connect the Included Setup Microphone**  
(page 29)



**2 Audyssey Auto Setup Preparations**  
(page 30)

- ❑ **Change the Amplifier Assignment (Amp Assign)**  
(page 30)
- ❑ **Set the channel to be measured (Channel Select)**  
(page 30)



**3 Perform Audyssey Auto Setup** (page 30)



**Check the Measuring Results and Equalizer Type after Audyssey Auto Setup (Parameter Check)**  
(page 33)

## Important Information

Audyssey MultEQ® automatically measures the acoustical problems in the listening environment to create the best audio experience for your home theater.

- When Audyssey™ Auto Setup procedure is performed, the MultEQ®, Dynamic EQ™ and Dynamic Volume™ functions (page 73, 74) are enabled.
- Use the included setup microphone (DM-A409) to perform Audyssey Auto Setup procedure.
- Measurements are performed by placing the calibrated microphone successively at multiple positions throughout the listening area as shown in **[Example ①]**. For best results, it is strongly recommended to measure 6 positions so that the measurements have the proper spatial weighting.

Even if the listening environment is small as shown in **[Example ②]**, measuring at multiple points throughout the listening environment results in more effective correction.

## When using Front Height Speakers

**[Example ①]**

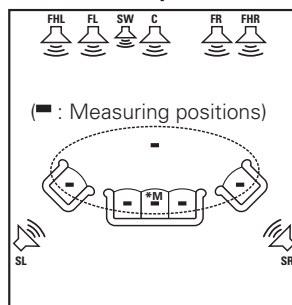

**[Example ②]**

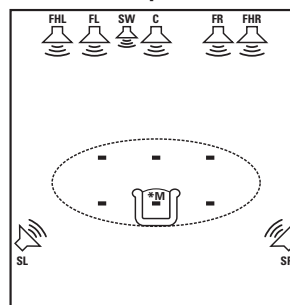

## When using Surround Back Speakers

**[Example ①]**

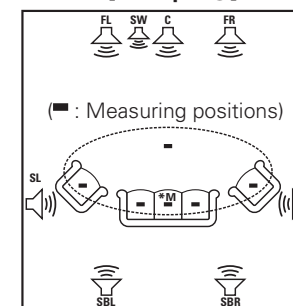

**[Example ②]**

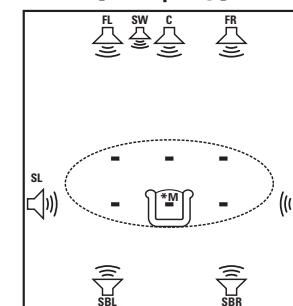

- FL** : Front speaker (L)
- FR** : Front speaker (R)
- FHL** : Front height speaker (L)
- FHR** : Front height speaker (R)
- C** : Center speaker
- SW** : Subwoofer
- SL** : Surround speaker (L)
- SR** : Surround speaker (R)
- SBL** : Surround back speaker (L)
- SBR** : Surround back speaker (R)

## About the main listening position (\*M)

The main listening position refers to the most central position where one would normally sit within the listening environment. MultEQ uses the measurements from this position to calculate speaker distance, level, polarity, and the optimum crossover value for the subwoofer.

See overleaf

**Make the Optimal Speaker Settings, and Correct the Room Acoustics (Audyssey™ Auto Setup)**

**NOTE**

- Loud test sounds may be played during Audyssey MultEQ automatic speaker setup. This is part of normal operation. If there is background noise in room, these test signals will increase in volume.
- Do not stand between the speakers and setup microphone or allow obstacles in the path while the measurements are being made. This will cause inaccurate readings.
- Make the room as quiet as possible. Background noise can disrupt the room measurements. Close windows, silence cell phones, televisions, radios, air conditioners, fluorescent lights, home appliances, light dimmers, or other devices as measurements may be affected by these sounds. Cell phones should be placed away from all audio electronics during the measurement process as Radio Frequency Interference (RFI) may cause measurement disruptions (even if the cell phone is not in use).
- Operating **MASTER VOLUME** during the measurements will cancel the measurements.

**1 Connect the Included Setup Microphone**

- Do not remove the setup microphone until Audyssey Auto Setup is completed.
- When using headphones, unplug the headphones before starting Audyssey Auto Setup procedure.

**1 Check the speaker connections.**  
(☞ page 13 "Speaker Connections")

**2 Turn on the TV and subwoofer power.**  
Change the TV input to AVR-3310CI input.

**3 Turn on the AVR-3310CI power.**  
(☞ page 24 "Turning the Power On")

**4 Connect the setup microphone to the SETUP MIC jack of the AVR-3310CI.**

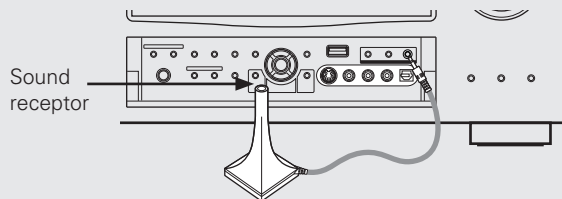

"Audyssey Auto Setup" screen is displayed when you connect the setup microphone.



**5 Mount the setup microphone on a tripod or stand and place it in the main listening position.**

When placing the setup microphone, adjust the height of the sound receiver part to the level of the listener's ear.

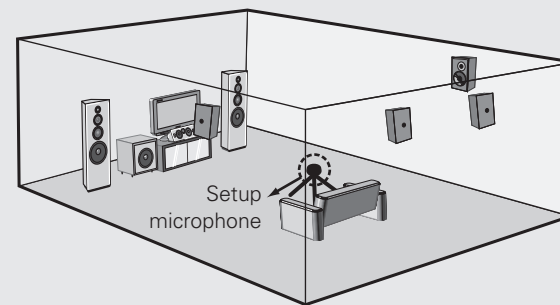

If your subwoofer provides volume and crossover settings, set these as shown below before starting Audyssey Auto Setup.

- Volume setting : "12 o'clock" position" or the middle of the gain knob's range.
- Low Pass Filter setting : Low Pass Filter Setting to "Off", or "Maximum/Highest Frequency".
- Phase setting : 0°
- Standby mode setting : "Off"

**NOTE**

- Do not hold the microphone in your hand during measurements.
- Avoid placing the microphone close to a seat back or wall as sound reflections may give inaccurate results.



## 2 Audyssey Auto Setup Preparations

 around items indicate the default setting.

### STEP1 Preparation

Perform the following settings if adjustments, etc., are required for the speaker environment you're using. If you do not need to perform the following settings, or have already completed them, select "Auto Setup Start" and then press **ENTER**. Proceed to "**STEP2**".

### Change the Amplifier Assignment (Amp Assign)

The signal output from the SURR.BACK/AMP ASSIGN speaker terminal of the AVR-3310CI can be switched to match your speaker environment (page 34 "Amp Assign").

**1** Press  $\Delta$ / $\nabla$  to select "Amp Assign", then press **ENTER**.



**2** Press  $\triangleleft$ / $\triangleright$  to select Amp Assign Mode, then press **RETURN**.

- Normal** : The surround back channel audio signals are output.
- ZONE2** : The ZONE2 audio signals are output.
- ZONE3** : The ZONE3 audio signals are output.
- ZONE2/3-MONO** : The ZONE2 / ZONE3 monaural audio signals are output.
- Front A Bi-Amp** : The bi-amp audio signals are output. Set this for bi-amp playback of the front A speakers.
- Front B Bi-Amp** : The bi-amp audio signals are output. Set this for bi-amp playback of the front A speakers.
- Front Height** : The front height channel audio signals are output.



- When you are using surround back speakers with ZONE2/ZONE3, set to "ZONE2" or "ZONE3".
- You can set in the same way as described in "Amp Assign" on page 34.

### NOTE

Since "Amp Assign" of AVR-3310CI is set to "ZONE2" by default, audio is not output from the surround back speakers. When using the surround back speakers with MAIN ZONE, change the "Amp Assign" setting to "Normal".

### Set the channel to be measured (Channel Select)

- **Front**  
The front speaker to be measured can be selected ahead of time here.
- **Subwoofer, Surround Back**  
If you set the channels you will not use beforehand, those channels will not be measured. Therefore, you can save an amount of time commensurate with that which would have been taken to measure those channels.

**1** Press  $\Delta$ / $\nabla$  to select "Channel Select", then press **ENTER**.



**2** Press  $\Delta$ / $\nabla$  to select a channel, press  $\triangleleft$ / $\triangleright$  to select the item, and then press **RETURN**.

#### Front

- A** : The sound is output from front speakers A when measuring the front speakers.
- B** : The sound is output from front speakers B when measuring the front speakers.
- A+B** : The sound is output simultaneously from front speakers A and B when measuring the front speakers.

#### Subwoofer, Surround Back

- Measure** : Measure the selected channel.
- Skip** : Skip the selected channel and do not measure.



When "Amp Assign" is set to "Normal", only then is "Surround Back" displayed.

## 3 Perform Audyssey Auto Setup

- Audyssey Auto Setup detects the presence of each speaker and automatically calculates the speaker size, channel level, distance and crossover frequency settings. In addition, acoustical distortions are corrected within the listening area.
- When measuring begins, a test tone is output from each speaker.
- Position and connect all speakers before commencing Audyssey Auto Setup.

### STEP2 Speaker Detection

**1** Press  $\Delta$ / $\nabla$  to select "Auto Setup Start", then press **ENTER**.

**2** Select "Measure" and then press **ENTER**.



**3** Once all the speakers have been detected, check the results of detection of the connected speakers.

**4** Press  $\Delta$ / $\nabla$  to select "Next Measurement", then press **ENTER**.

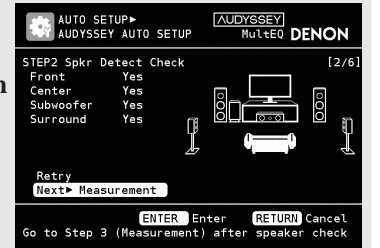

※ Press  $\Delta$  to select "Retry", and when you press **ENTER**, measuring at the main listening position starts again.

See overleaf 

Main remote control operation buttons

**MENU**  :Displaying the menu  
Cancel the menu

 :Moves the cursor  
(Up/Down/Left/Right)

**ENTER**  :Confirm the setting

**RETURN**  :Return to previous menu

## Make the Optimal Speaker Settings, and Correct the Room Acoustics (Audyssey™ Auto Setup)

### STEP3 Measurement

**5** Move the setup microphone to the 2nd position, use  $\Delta$ / $\nabla$  to select “Measure”, then press **ENTER**.

Measurements for the 2nd position begin.



※ To skip this step, select “Next ▶ Calculation” and proceed to **STEP4**.

**6** Perform Step 5 repeatedly for the 3rd, 4th, 5th, and 6th measurements.

When measurements of the 6th position are completed, “Measurements finished.” is displayed.



※ To skip this step, select “Next ▶ Calculation” and proceed to **STEP4**.

※ Measure at a total of 6 positions, including the main listening position and positions around it. It is possible to stop the settings with five positions or fewer, but for better results we recommend measuring at 6 positions.

### STEP4 Calculation

**7** On the **STEP3** screen, use  $\Delta$ / $\nabla$  to select “Next ▶ Calculation”, then press **ENTER**.

Analysis begins.



※ Analysis takes several minutes to complete.

The time required for this analysis depends on the number of speakers connected. The greater the number of speakers connected, the longer analysis will take.

### STEP5 Check

**8** Use  $\Delta$ / $\nabla$  to select the item you want to check, then press **ENTER**.

The measurement result confirmation screen is displayed.



Speaker Config. Check

Distance Check

Channel Level Check

Crossover Freq. Check

※ Subwoofer or other speakers may be set to a value that does not correspond to the actual distance.

**9** Press **RETURN**.

If you want to check another item, so repeat step 8.

**10** Press  $\nabla$  to select “Next ▶ Store”, then press **ENTER**.

### STEP6 Store

**11** Select “Store” then press **ENTER**.

“Now Storing... Please wait.” is displayed while the results are being stored.



#### NOTE

Do not turn the power off while the settings are being stored.

**12** When the screen shown on the right appears, unplug the setup microphone from the **AVR-3310CI SETUP MIC jack**.



**13** Select “Exit” and then press **ENTER**.

#### Exiting the GUI Menu

Press **MENU** while the GUI menu is displayed. The GUI menu display disappears.

#### NOTE

After performing Audyssey Auto Setup, do not change the speaker connections or subwoofer volume. In event of a change, perform Audyssey™ Auto Setup again.



- If there is a disparity between the results and the connection status, or if an error message is displayed, check the error message against the errors listed in the “Error Messages” section (page 32) and perform Audyssey Auto Setup again.
- If the result still differs from the actual connection status after remeasurement or the error message still appears, it is possible that the speakers are not connected properly. Turn the AVR-3310CI off, check the speaker connections and repeat the measurement process from the beginning. Turn the AVR-3310CI off, check the speaker connections and repeat the measurement process from the beginning.
- If you change a speaker position or orientation, perform Audyssey Auto Setup again to obtain optimal equalizer correction.



## Error Messages

An error message is displayed if it was not possible to complete Audyssey Auto Setup due to speaker placement, the measurement environment, etc. If this happens, check the relevant items, be sure to take the necessary measures, then perform Audyssey Auto Setup procedure over again.

### NOTE

Be sure to turn off the power before checking speaker connections.





### ❑ When Performing Audyssey Auto Setup Over Again

Press  $\Delta \nabla$  to select "Retry", and then press **ENTER**.

### ❑ When Measuring has Stopped

Press **RETURN**, the "Cancel auto setup?" prompt is displayed.

Press  $\triangleleft \triangleright$  and select "Yes", then press **ENTER**.

Error messages (examples)	Error contents	Measures
	<ul style="list-style-type: none"> <li>Included setup microphone is not connected.</li> <li>Not all speakers could be detected.</li> <li>The front L speaker was not properly detected.</li> </ul>	<ul style="list-style-type: none"> <li>Connect the included setup microphone to the SETUP MIC jack of the AVR-3310CI.</li> <li>Check the speaker connections.</li> </ul>
	<ul style="list-style-type: none"> <li>Too much noise in the room for accurate measurements to be made.</li> <li>Speaker or subwoofer sound is too low for accurate measurements to be made.</li> </ul>	<ul style="list-style-type: none"> <li>Either turn off any device generating noise or move it away.</li> <li>Perform again when the surroundings are quieter.</li> <li>Check the speaker installation and the direction in which the speakers are facing.</li> <li>Adjust the subwoofer's volume.</li> </ul>
	<ul style="list-style-type: none"> <li>Displayed speaker could not be detected.</li> </ul>	<ul style="list-style-type: none"> <li>Check the connections of the displayed speaker.</li> </ul>
	<ul style="list-style-type: none"> <li>Displayed speaker connected with the polarities reversed.</li> </ul>	<ul style="list-style-type: none"> <li>Check the polarities of the displayed speaker.</li> <li>For some speakers, this error message may be displayed even if the speaker is properly connected. If you are sure the connection is correct, press <math>\Delta \nabla</math> to select "Skip", then press <b>ENTER</b>.</li> </ul>



## Make the Optimal Speaker Settings, and Correct the Room Acoustics (Audyssey™ Auto Setup)

### Check the Measuring Results and Equalizer Type after Audyssey Auto Setup (Parameter Check)

This is displayed after Audyssey Auto Setup procedure is completed.

- 1 Press  $\nabla$  to select “Parameter Check”, and then press **ENTER** or  $\triangleright$ .

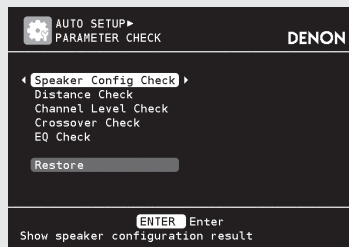

- 2 Press  $\triangle\nabla$  to select the item you want to check, and then press **ENTER** or  $\triangleright$ .

**Speaker Config. Check**   **Distance Check**   **Channel Level Check**   **Crossover Freq. Check**  
**EQ Check**

The measurement result of each speaker is displayed.

- ※ When you selected “EQ Check”, press  $\triangle\nabla$  to select the Correction curve you want to check (“Audyssey” or “Audyssey Flat”).
- ※ When you want to check another item, press **RETURN**.



If you set “Restore” to “Yes”, you can return to Audyssey Auto Setup measurement result (value calculated at the start by MultEQ) even when you have changed each setting manually.



## Making Detailed Settings (Manual Setup)

GUI

For details on how to select, set and cancel settings for each menu, see “GUI Menu Operation” (page 26).

### Items that can be set with the Manual Setup procedure



Making the speaker settings (Speaker Setup) page 34



Making the HDMI settings (HDMI Setup) page 36



Making the audio settings (Audio Setup) page 37



Making the network settings (Network Setup) page 38



Making the Multi-zone settings (Zone Setup) page 41



Making other settings (Option Setup) page 41



**MENU**: Displaying the menu  
Cancel the menu



: Moves the cursor  
(Up/Down/Left/Right)



**ENTER**: Confirm the setting



**RETURN**: Return to previous menu



## Making the Speaker Settings (Speaker Setup)



Default settings are underlined.

Perform when setting the speakers manually or when changing settings made in Audyssey Auto Setup.

Setting items	Setting contents
<p><b>Amp Assign</b> Sets the signal output to the speaker connected to the SURR. BACK/AMP ASSIGN terminals.</p>	<p><b>Normal</b> : The surround back channel audio signals are output.  <b>ZONE2</b> : The ZONE2 audio signals are output.  <b>ZONE3</b> : The ZONE3 audio signals are output.  <b>ZONE2/3-MONO</b> : The ZONE2 / ZONE3 monaural audio signals are output.  <b>Front A Bi-Amp</b> : The bi-amp audio signals are output. Set this for bi-amp playback of the front A speakers.  <b>Front B Bi-Amp</b> : The bi-amp audio signals are output. Set this for bi-amp playback of the front B speakers.  <b>Front Height</b> : The front height channel audio signals are output.</p> <p> Since "Amp Assign" of AVR-3310CI is set to "ZONE2" by default, audio is not output from the surround back speakers. When using the surround back speakers with MAIN ZONE, change the "Amp Assign" setting to "Normal".</p>
<p><b>Speaker Configuration</b> Select speaker configuration and size (bass reproduction capability).</p> <p><b>NOTE</b> Select "Large" or "Small" not according to the physical size of the speaker but according to the low frequency reproduction capabilities based on the frequency set at "Crossover Frequency" (page 300).</p>	<p><b>Front</b> : Set the front speaker size.</p> <ul style="list-style-type: none"> <li>• <b>Large</b> : Use of a large speaker that can adequately playback low frequencies.</li> <li>• <b>Small</b> : Use of a small speaker that has inadequate playback capacity for low frequencies.</li> </ul> <p></p> <ul style="list-style-type: none"> <li>• When "Subwoofer" is set to "No", "Front" can automatically set to "Large".</li> <li>• When "Front" is set to "Small", "Center", "Surround", "Surround Back" and "Front Height" can not be set to "Large".</li> </ul> <p><b>Center</b> : Set the presence and size of the center speaker.</p> <ul style="list-style-type: none"> <li>• <b>Large</b> : Use of a large speaker that can adequately playback low frequencies.</li> <li>• <b>Small</b> : Use of a small speaker that has inadequate playback capacity for low frequencies.</li> <li>• <b>None</b> : Select when a center speaker is not connected.</li> </ul> <p> "Large" is not displayed when "Front" is set to "Small".</p> <p><b>Subwoofer</b> : Set the presence of a subwoofer.</p> <ul style="list-style-type: none"> <li>• <b>Yes</b> : Use a subwoofer.</li> <li>• <b>No</b> : Select when a subwoofer is not connected.</li> </ul> <p> When "Front" is set to "Small", "Subwoofer" can automatically set to "Yes".</p>

Setting items	Setting contents
<p><b>Speaker Configuration</b> (Continued)</p>	<p><b>Surround</b> : Set the presence and size of the surround speakers.</p> <ul style="list-style-type: none"> <li>• <b>Large</b> : Use of a large speaker that can adequately playback low frequencies.</li> <li>• <b>Small</b> : Use of a small speaker that has inadequate playback capacity for low frequencies.</li> <li>• <b>None</b> : Select when the surround speakers A are not connected.</li> </ul> <p></p> <ul style="list-style-type: none"> <li>• When "Surround" is set to "Large", "Front Height" can be set to "Large".</li> <li>• When "Surround" is set to "None", "Surround Back" and "Front Height" can automatically set to "None".</li> </ul> <p><b>Surround Back</b> : Set the presence, size and number of surround back speakers.</p> <ul style="list-style-type: none"> <li>• <b>Large</b> : Use of a large speaker that can adequately playback low frequencies.</li> <li>• <b>Small</b> : Use of a small speaker that has inadequate playback capacity for low frequencies.</li> <li>• <b>None</b> : Select when the surround back speakers are not connected.</li> <li>• <b>2spkrs</b> : Use two surround back speakers.</li> <li>• <b>1spkr</b> : Use only one surround back speaker. When you select this setting, connect the surround back speaker to the left (L) channel.</li> </ul> <p></p> <ul style="list-style-type: none"> <li>• When the "Amp Assign" setting (page 34) is other than "Normal", you cannot make the "Surround Back" setting.</li> <li>• Even when the Surround Back Speaker setting is other than "None", sound may not be emitted from the surround back speaker, depending on the playback source. In this case, "Surround Parameters" – "Surround Back" setting other than "OFF" (page 72).</li> </ul> <p><b>Front Height</b> : Set the presence and size of the front height speakers.</p> <ul style="list-style-type: none"> <li>• <b>Large</b> : Use of a large speaker that can adequately playback low frequencies.</li> <li>• <b>Small</b> : Use of a small speaker that has inadequate playback capacity for low frequencies.</li> <li>• <b>None</b> : Select when the front height speakers are not connected.</li> </ul> <p> When the "Amp Assign" setting (page 34) is other than "Front Height", you cannot make the "Front Height" setting.</p>

See overleaf

Main remote control operation buttons



MENU :Displaying the menu  
Cancel the menu



:Moves the cursor  
(Up/Down/Left/Right)







:Confirm the setting



:Return to previous menu

## Making Detailed Settings (Manual Setup)

Setting items	Setting contents
<b>Bass Setting</b> Settings for subwoofer and LFE signal range playback.	<p><b>Subwoofer Mode</b> : Select low range signals to be reproduced by subwoofer.</p> <ul style="list-style-type: none"> <li>• <b>LFE</b> : The low range signal of the channel set to “Small” speaker size is added to the LFE signal output from the subwoofer.</li> <li>• <b>LFE+Main</b> : The low range signal of all channels is added to the LFE signal output from the subwoofer.</li> </ul> <p> This can be set when “Speaker Configuration” – “Subwoofer” (page 34) is set to “Yes”.</p> <ul style="list-style-type: none"> <li>• Play music or a movie source and select the mode offering the strongest bass.</li> <li>• Select “LFE+Main” if you want the bass signals to always be produced from the subwoofer.</li> </ul> <p><b>LPF for LFE</b> : Set LFE signal playback range.</p> <p>• <b>80Hz / 90Hz / 100Hz / 110Hz / 120Hz / 150Hz / 200Hz / 250Hz</b></p>
<b>Distance</b> Set distance from listening position to speakers. Measure beforehand the distance from the listening position to each speaker.	<p><b>Unit</b> : Set the unit of distance.</p> <ul style="list-style-type: none"> <li>• <b>Feet</b></li> <li>• <b>Meters</b></li> </ul> <p><b>Step</b> : Set the minimum variable width of the distance.</p> <ul style="list-style-type: none"> <li>• <b>1ft / 0.1ft</b></li> <li>• <b>0.1m / 0.01m</b></li> </ul> <p><b>Front L / Front R / Center / Subwoofer / Surround L / Surround R / S. Back L* / S. Back R* / Front Height L / Front Height R</b> : Select the speaker.</p> <p>*: When the “Speaker Configuration” – “Surround Back” setting (page 34) is set to “1spkr”, “S. Back” is displayed.</p> <ul style="list-style-type: none"> <li>• <b>0.0ft ~ 60.0ft / 0.00m ~ 18.00m</b> : Set the distance.</li> </ul> <p> Speakers set to “None” in “Speaker Configuration” (page 34) are not displayed.</p> <ul style="list-style-type: none"> <li>• The speakers that can be selected differ depending on the “Amp Assign” (page 34) and “Speaker Configuration” (page 34) settings.</li> <li>• Default settings : Front / Center / Subwoofer / Front Height : 12.0 ft (3.60 m) Surround / Surround Back : 10.0 ft (3.00 m)</li> <li>• Set the difference in the distance between the speakers to less than 20 feet (6.0 meters).</li> </ul> <p><b>Default</b> : Reset all distance settings to factory default.</p> <ul style="list-style-type: none"> <li>• <b>Yes</b> : Reset to the defaults.</li> <li>• <b>No</b> : Do not reset to the defaults.</li> </ul> <p> When you select “Default” and press <b>ENTER</b>, the “Default Setting?” prompt is displayed. Select either “Yes” or “No”, and press <b>ENTER</b>.</p>

Setting items	Setting contents
<b>Channel Level</b> Set the volume of the test tone to be the same when it is output from each speaker.	<p><b>Test Tone Start</b> : Output test tone.</p> <ul style="list-style-type: none"> <li>• <b>Front L / Front Height L / Center / Front Height R / Front R / Surround R / S. Back R* / S. Back L* / Surround L / Subwoofer</b> : Select the speaker.</li> <li>* : When the “Speaker Configuration” – “Surround Back” setting (page 34) is set to “1spkr”, “S. Back” is displayed.</li> <li>• <b>-12.0dB ~ +12.0dB (0.0dB)</b> : Adjust the volume.</li> </ul> <p> Speakers set to “None” in the “Speaker Configuration” (page 34) settings are not displayed.</p> <ul style="list-style-type: none"> <li>• When <math>\triangleleft</math> is pressed while the subwoofer volume is set to “-12 dB”, the “Subwoofer” setting switches to “OFF”.</li> <li>• When a headphones jack is inserted in the PHONES terminal of the AVR-3310CI, the “Channel Level” is not displayed.</li> <li>• You can also press <b>[CHANNEL LEVEL]</b> to set (page 79 “Adjust the Volume of the Different Speakers”).</li> </ul> <p><b>Default</b> : Reset all channel level settings to factory default.</p> <ul style="list-style-type: none"> <li>• <b>Yes</b> : Reset to the defaults.</li> <li>• <b>No</b> : Do not reset to the defaults.</li> </ul>
<b>Crossover Frequency</b> Outputs at below set frequency, each speaker’s bass signal output from the subwoofer. Set this according to the low frequency reproduction capabilities of the speakers you are using.	<p><b>40Hz / 60Hz / 80Hz / 90Hz / 100Hz / 110Hz / 120Hz / 150Hz / 200Hz / 250Hz</b> : Set the crossover frequency.</p> <p><b>Advanced</b> : Specify crossover frequency for each speaker.</p> <ul style="list-style-type: none"> <li>• <b>Front / Center / Surround / Surround Back / Front Height</b> : Select the speaker.</li> <li>• <b>40Hz / 60Hz / 80Hz / 90Hz / 100Hz / 110Hz / 120Hz / 150Hz / 200Hz / 250Hz</b> : Set the crossover frequency.</li> </ul> <p> Can be set when the “Speaker Configuration” – “Subwoofer” (page 34) setting is “Yes”, or when you have a speaker that is set to “Small”.</p> <ul style="list-style-type: none"> <li>• Always set the crossover frequency to “80 Hz”. When using small speakers, however, we recommend setting the crossover frequency to a higher frequency.</li> <li>• For speakers set to “Small”, sound below the crossover frequency is cut from the sound output. The cut bass sound is output from the subwoofer or front speakers.</li> <li>• The speakers that can be set when “Advanced” is selected differ according to the “Subwoofer Mode” setting (page 35).</li> <li>• When “LFE” is selected, speakers set to “Small” at “Speaker Configuration” can be set. If the speakers are set to “Large”, “Full Band” is displayed and the setting cannot be made.</li> <li>• If set to “LFE+Main”, this setting can be made regardless of the speaker size.</li> </ul>



Setting items	Setting contents
<b>Front Speaker Setup</b> Set the front speakers to use for every surround mode.	<p><b>Setting</b> : Choose the method for setting the front speakers.</p> <ul style="list-style-type: none"> <li>• <b>Normal</b> : The front speakers are set using the <b>&lt;FRONT SPEAKERS&gt;</b>.</li> <li>• <b>Custom</b> : The front speakers used for the different playing modes are set in advance.</li> </ul> <p><b>2CH DIRECT/STEREO</b> : The front speakers used in the direct, stereo and pure direct play modes (2 channel) are set in advance.</p> <ul style="list-style-type: none"> <li>• <b>A</b> : Front speaker A is used.</li> <li>• <b>B</b> : Front speaker B is used.</li> <li>• <b>A+B</b> : Both front speakers A and B are used.</li> </ul> <p><b>MULTI CH</b> : The front speakers used in modes other than the direct, stereo and pure direct play modes (2 channel) are set in advance.</p> <ul style="list-style-type: none"> <li>• <b>A</b> : Front speaker A is used.</li> <li>• <b>B</b> : Front speaker B is used.</li> <li>• <b>A+B</b> : Both front speakers A and B are used.</li> </ul> <p><b>NOTE</b></p> <ul style="list-style-type: none"> <li>• When set to "Custom", <b>&lt;FRONT SPEAKERS&gt;</b> does not operate.</li> <li>• The front speaker setting stored for the "Quick Select" function is given priority.</li> </ul>



## Making the HDMI Settings (HDMI Setup)



Default settings are underlined.

Make settings for HDMI video/audio output.

Setting items	Setting contents
<b>RGB Range</b> Set the video range of RGB output from the HDMI terminal.	<p><b>Normal</b> : Output with RGB video range (16 (black) to 235 (white)).</p> <p><b>Enhanced</b> : Output with RGB video range (0 (black) to 255 (white)).</p> <p> This setting is valid when using a TV equipped with a DVI terminal.</p>
<b>Auto Lip Sync</b> Automatic compensation for timing shift in audio and video output.	<p><b>ON</b> : Compensated.</p> <p><b>OFF</b> : Not compensated.</p>
<b>Audio Out</b> Select HDMI audio output device.	<p><b>AMP</b> : Playback through speakers connected to the receiver.</p> <p><b>TV</b> : Playback through TV connected to the receiver.</p> <p> When the HDMI control function is operating, the setting of audio playback in the connected TV takes priority (page 78 "HDMI Control Function").</p>

Setting items	Setting contents
<b>HDMI Control</b> External devices can be controlled from the AVR-3310CI and the AVR-3310CI can be controlled from external devices.	<p><b>ON</b> : Use the HDMI control function.</p> <p><b>OFF</b> : Do not use the HDMI control function.</p> <p></p> <ul style="list-style-type: none"> <li>• Please consult the operating instructions for each connected device to check the settings.</li> <li>• For details on the HDMI control function, see "HDMI Control Function" (page 78).</li> </ul> <p><b>NOTE</b></p> <ul style="list-style-type: none"> <li>• <b>When "HDMI Control" is set to "ON", it consumes more standby power.</b></li> <li>• When not using this unit for a long period, we recommend that you press <b>&lt;POWER&gt;</b> to turn off (OFF) the power.</li> <li>• When the "HDMI Control" setting has been changed, always turn off the power to the connecting devices afterwards and then turn back on.</li> <li>• The "HDMI Control" does not work when the power to the equipment is off.</li> <li>• When "HDMI Control" is set to "ON", power is supplied constantly to the AC outlet (UNSWITCHED).</li> </ul>
<b>Standby Source</b> Set the HDMI connector for HDMI signal input during standby.	<p><b>Last</b> : Standby with last used input source during power on.</p> <p><b>HDMI1 / HDMI2 / HDMI3 / HDMI4 / HDMI5</b> : The standby mode is set at the input source assigned to the respective.</p> <p> This can be set when "HDMI Control" is set to "ON".</p>
<b>Power Off Control</b> The power of the AVR-3310CI and external device turn off together.	<p><b>ON</b> : Switched.</p> <p><b>OFF</b> : Not switched.</p> <p></p> <ul style="list-style-type: none"> <li>• This can be set when "HDMI Control" is set to "ON".</li> <li>• Please consult the operating instructions for each connected device to check the settings.</li> <li>• For details on the HDMI control function, see "HDMI Control Function" (page 78).</li> </ul>

Main remote control operation buttons



:Displaying the menu  
:Cancel the menu



:Moves the cursor  
(Up/Down/Left/Right)



:Confirm the setting



:Return to previous menu

## Making Detailed Settings (Manual Setup)



## Making the Audio Settings (Audio Setup)



Default settings are underlined.

Make settings for audio playback.

Setting items	Setting contents
<b>EXT. IN SW Level</b> Set the playback level of the analog subwoofer signals input from the external input terminals (EXT. IN).	<b>+15dB</b> : This is the recommended level. <b>+10dB / +5dB / 0dB</b> : Select the level according to the player being used.
<b>2ch Direct/Stereo</b> Make speaker settings for 2-channel mode playback.	<b>Setting</b> : Select the method for setting the speakers used in the 2-channel direct and stereo playback modes. • <b>Basic</b> : The settings at "Speaker Setup" (page 34) are applied. • <b>Custom</b> : Make separate settings for 2-channel. <b>Front</b> : Set the front speaker size. • <b>Large</b> : Use of a large speaker that can adequately playback low frequencies. • <b>Small</b> : Use of a small speaker that has inadequate playback capacity for low frequencies. If "Speaker Configuration" – "Subwoofer" (page 34) is set to "No", the setting is automatically set to "Large". <b>Subwoofer</b> : Set the presence of a subwoofer. • <b>Yes</b> : Use a subwoofer. • <b>No</b> : Select when a subwoofer is not connected. If "Speaker Configuration" – "Subwoofer" (page 34) is set to "No", the setting is automatically set to "No". If the "Front" setting is "Small", the setting is automatically "Yes". <b>SW Mode</b> : Select low range signal to be reproduced by subwoofer. • <b>LFE</b> : When the "2ch Direct/Stereo" – "Front" setting is set to "Large", the LFE signal alone is output from the subwoofer. Also, when the "2ch Direct/Stereo" – "Front" setting is set to "Small", the front channel low range signal is added to the LFE signal output from the subwoofer. • <b>LFE+Main</b> : The front channel low range signal is added to the LFE signal output from the subwoofer. This can be set when "2ch Direct/Stereo" – "Subwoofer" is set to "Yes".

Setting items	Setting contents
<b>2ch Direct/Stereo</b> (Continued)	<b>Crossover</b> : Outputs at below set frequency, each speaker's bass signal output from the subwoofer. • <b>40Hz / 60Hz / <u>80Hz</u> / 90Hz / 100Hz / 110Hz / 120Hz / 150Hz / 200Hz / 250Hz</b>  • This can be set when "2ch Direct/Stereo" – "Subwoofer" is set to "Yes". • If the "2ch Direct/Stereo" – "Front" setting is "Large" and the "SW Mode" setting is "LFE", "Full Band" is displayed and the setting cannot be made. <b>Distance FL / Distance FR</b> : Select the speaker. • <b>0.0ft ~ 60.0ft (<u>12.0ft</u>) / 0.00m ~ 18.00m (<u>3.60m</u>)</b> : Set the distance to the speaker. Set so that the difference between the front left speaker and front right speaker distances is 6.0 m (20.0 ft) or less. <b>Level FL / Level FR</b> : Select the speaker. • <b>-12.0dB ~ +12.0dB (<u>0dB</u>)</b> : Adjust the level of each channel.
<b>Auto Surround Mode</b> Make setting for memorizing surround mode setting for each input signal type.	<b>ON</b> : Memorize settings. Automatically play with the last used surround mode. <b>OFF</b> : Do not memorize settings. Surround mode does not change according to input signal  • The auto surround mode function lets you store in the memory the surround mode last used for playing the four types of input signals listed below. ① Analog and PCM 2-channel signals ② Dolby Digital and DTS 2-channel signals ③ Dolby Digital and DTS multi-channel signals ④ Multi-channel signals other than Dolby Digital and DTS (PCM etc.) • When playing in the PURE DIRECT, the surround mode does not change even if the input signal is changed.
<b>EQ Customize</b> Set so that unused equalizer settings are not displayed when <b>MULTEQ</b> is pressed.  Equalizer settings for which "Not Used" is set with the Quick Select function cannot be stored and called out.	<b>Audyssey Byp. L/R</b> : Set when not using the "Audyssey Byp L/R" equalizer. • <b>Used</b> : Use. • <b>Not Used</b> : Do not use. Set so that "Audyssey Byp. L/R" settings can be made when Audyssey™ Auto Setup procedure is performed.





Setting items	Setting contents
<b>EQ Customize</b> (Continued)	<p><b>Audyssey Flat</b> : Set when not using the “Audyssey Flat” equalizer.</p> <ul style="list-style-type: none"> <li>• <b>Used</b> : Use.</li> <li>• <b>Not Used</b> : Do not use.</li> </ul> <p> Set so that “Audyssey Flat” settings can be made when Audyssey Auto Setup procedure is performed.</p> <p><b>Manual</b> : Set when not using the “Manual” equalizer.</p> <ul style="list-style-type: none"> <li>• <b>Used</b> : Use.</li> <li>• <b>Not Used</b> : Do not use.</li> </ul>

Setting items	Setting contents
<b>Network Connecting</b> (Continued)	<ol style="list-style-type: none"> <li>① On the GUI menu, select “Network Connecting” – “Detail” and press <b>ENTER</b>.</li> <li>② Use <math>\triangleleft \triangleright</math> to set “DHCP” to “OFF”, then press <math>\nabla</math>. The DHCP function is disabled.</li> <li>③ Use <math>\triangle \nabla \triangleright</math> to input the address and press <b>ENTER</b>. <ul style="list-style-type: none"> <li>• <b>IP Address</b> : Set the IP address within the ranges shown below. The Network Audio function cannot be used if other IP addresses are set. CLASS A: 10.0.0.0 ~ 10.255.255.255 CLASS B: 172.16.0.0 ~ 172.31.255.255 CLASS C: 192.168.0.0 ~ 192.168.255.255</li> <li>• <b>Subnet Mask</b> : When connecting an xDSL modem or terminal adapter directly to the AVR-3310CI, input the subnet mask indicated in the documentation supplied by your provider. Normally input 255.255.255.0.</li> <li>• <b>Default Gateway</b> : When connected to a gateway (router), input its IP address.</li> <li>• <b>Primary DNS, Secondary DNS</b> : If there is only one DNS address indicated in the documentation supplied by your provider, input it at “Primary DNS”. If there are two or more DNS addresses, input the first one at “Secondary DNS”.</li> </ul> </li> <li>④ Use <math>\nabla</math> to select “Exit” and press <b>ENTER</b>. Setup is complete.</li> </ol> <p>※ When connecting to the network via a Proxy server, select “Proxy” and press <b>ENTER</b> (page 39 “Proxy settings”).</p> <p></p> <ul style="list-style-type: none"> <li>• If you are using a broadband router (DHCP function), there is no need to make the settings at “IP Address” and “Proxy”, since the DHCP function is set to “ON” in the AVR-3310CI’s default settings.</li> <li>• If the AVR-3310CI is being used connected to a network without the DHCP function, the network settings must be made. In this case, some knowledge of networks is required. For details, consult a network administrator.</li> <li>• If you cannot connect to the Internet, recheck the connections and settings (page 23).</li> <li>• If you do not understand about Internet connection, contact your ISP (Internet Service Provider) or the store from which you purchased your computer.</li> <li>• When you want to cancel the setting during IP address input, press <b>RETURN</b>.</li> </ul>

**Making the Network Settings (Network Setup)** **Default settings are underlined.**



Make network settings.

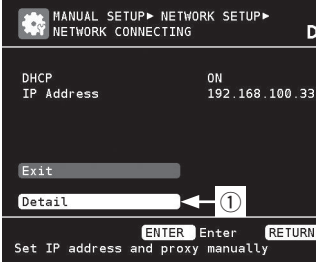
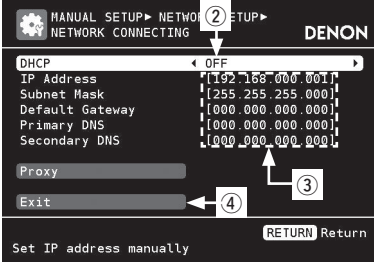

Setting items	Setting contents
<b>Network Connecting</b> Make settings for wired LAN.	<ol style="list-style-type: none"> <li>1. Connect the LAN cable (page 23 “Connecting to a Home Network (LAN)”).</li> <li>2. Turn on the AVR-3310CI (page 24 “Turning the Power On”). AVR-3310CI performs automatic network setup due to the DHCP function. When connecting to a network that has no DHCP function, perform the setting in step 3.</li> <li>3. Set the IP address at the “Network Connecting”.</li> </ol>



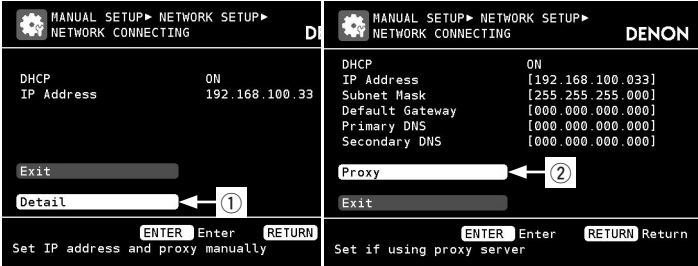
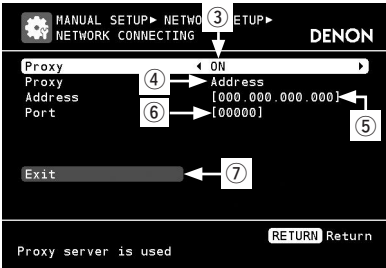





See overleaf





## Making Detailed Settings (Manual Setup)

Setting items	Setting contents
<b>Network Connecting</b> (Continued)	<p><b>Proxy settings</b> : Make this setting when connecting to the Internet via a proxy server.</p>   <p>① On the GUI menu, select “Network Connecting” – “Detail” and press <b>ENTER</b>.</p> <p>② Use <math>\Delta \nabla \triangleleft \triangleright</math> to set “Proxy” and press <b>ENTER</b>.</p> <p>③ Use <math>\triangleleft \triangleright</math> to set “Proxy” to “ON” and press <math>\nabla</math>. The proxy server is enabled.</p> <p>④ Use <math>\triangleleft \triangleright</math> to select the proxy server input method, and then press <math>\nabla</math>. <b>Address</b> : Select when inputting by address. <b>Name</b> : Select when inputting by domain name.</p> <p>⑤ Use <math>\Delta \nabla \triangleleft \triangleright</math> to input the proxy server address or domain name and press <b>ENTER</b>. When “Address” is selected in step ④ : Input the address When “Name” is selected in step ④ : Input the domain name The types of characters that can be input are as shown below.</p> <div style="border: 1px solid black; padding: 5px;"> <p><b>[Lower case characters]</b> abcdefghijklmnopqrstuvwxyz  <b>[Upper case characters]</b> ABCDEFGHIJKLMNOPQRSTUVWXYZ  <b>[Symbols]</b> ! " # \$ % &amp; ' ( ) * + , - . / : ; &lt; = &gt; ? @ [ \ ] ^ _ ` {   } ~          (Space)  <b>[Numbers]</b> 0123456789</p> </div> <p> You can change the character type when you press <b>[SEARCH]</b> during character input.</p>

Setting items	Setting contents
<b>Network Connecting</b> (Continued)	<p>⑥ Use <math>\Delta \nabla \triangleleft \triangleright</math> to input the proxy server port number and press <b>ENTER</b>.</p> <p>⑦ Use <math>\nabla</math> to select “Exit” and press <b>ENTER</b>. Setup is complete.</p>
<b>Other</b> Network function on/off setting during standby, and PC language setting.	<p><b>Network Standby</b> : Set the network function on/off during standby.</p> <ul style="list-style-type: none"> <li>• <b>ON</b> : Network is on during standby. Main unit operable with a network-compatible controller.</li> <li>• <b>OFF</b> : Suspend network function during standby.</li> </ul> <p> Set to “ON” when using the web control function.</p> <p><b>PC Language</b> : Select computer environment language.</p> <ul style="list-style-type: none"> <li>• <b>ara / chi (smp) / chi (trad) / cze / dan / dut / eng / fin / fre / ger / gre / heb / hun / ita / jpn / kor / nor / pol / por / por(BR) / rus / spa / swe / tur</b></li> </ul> <p><b>Friendly Name Edit</b> : The Friendly Name is the name AVR-3310CI displayed on the network. Up to 63 characters can be input. The default Friendly Name on first use is “DENON:[AVR-3310CI]”.</p> <p>The types of characters that can be input are as shown below.</p> <div style="border: 1px solid black; padding: 5px;"> <p><b>[Lower case characters]</b> abcdefghijklmnopqrstuvwxyz  <b>[Upper case characters]</b> ABCDEFGHIJKLMNOPQRSTUVWXYZ  <b>[Symbols]</b> ! " # \$ % &amp; ' ( ) * + , - . / : ; &lt; = &gt; ? @ [ \ ] ^ _ ` {   } ~          (Space)  <b>[Numbers]</b> 0123456789</p> </div> <p> You can change the character type when you press <b>[SEARCH]</b> during character input.</p> <p><b>Default</b> : Reset all settings to factory default.</p> <ul style="list-style-type: none"> <li>• <b>Yes</b> : Reset to the defaults.</li> <li>• <b>No</b> : Do not reset to the defaults.</li> </ul> <p><b>Party Mode Function</b> : Set the Party Mode function.</p> <ul style="list-style-type: none"> <li>• <b>OFF</b> : Disable Party Mode function.</li> <li>• <b>ON</b> : Enable Party Mode function.</li> </ul> <p> Refer to page 80, “Playing the Same Network Audio on Different Devices Connected in a Network (Party Mode Function)” for more information on the party mode function.</p>



Setting items	Setting contents
<b>Other</b> (Continued)	<p><b>Party Start Level</b> : Make settings for volume level when the Party Mode is started.</p> <ul style="list-style-type: none"> <li>• <b>Last</b> : The same volume as set before the party mode was started.</li> <li>• <b>-- (0)</b> : Always use the muting on condition when the Party Mode is started.</li> <li>• <b>-80dB ~ 18dB (1 ~ 99)</b> : Start party mode with your preferred volume.</li> </ul> <p> This can be set when "Party Mode Function" is set to "ON".</p> <ul style="list-style-type: none"> <li>• This is displayed from 0 to 99 when "Volume Display" ( page 41) is set to "Absolute".</li> <li>• You can set to the upper limit set with "Volume Limit" ( page 41).</li> </ul> <p><b>Network Status</b> : Displays up to a maximum of 10 DENON products connected on the same network.</p> <ul style="list-style-type: none"> <li>• <b>Friendly Name / Model Name / Power ON/Standby / Select Source / Volume Level / Party Mode status</b></li> </ul> <p> "Network Status" is only displayed for DENON products supporting the Network Status function.</p> <p><b>Update Notification</b> : Displays a notification message on the AVR-3310CI's GUI screen when the latest firmware is released with "Firmware Update". The notification message is displayed for about 20 seconds when the power is turned on. Connect to broadband Internet ( page 23) when using this function.</p> <ul style="list-style-type: none"> <li>• <b>ON</b> : Display update message.</li> <li>• <b>OFF</b> : Do not display upgrade message.</li> </ul> <p> When you press <b>ENTER</b> during display of the notification message, the "Check for Update" screen is displayed. (Refer to page 44 for more information on "Firmware Update")</p> <ul style="list-style-type: none"> <li>• Press <b>RETURN</b> to erase the notification message.</li> </ul> <p><b>Upgrade Notification</b> : Display a notification message on the AVR-3310CI's GUI screen when downloadable firmware is released with "Add New Feature". The notification message is displayed for about 20 seconds when the power is turned on. Connect to broadband Internet ( page 23) when using this function.</p> <ul style="list-style-type: none"> <li>• <b>ON</b> : Display update message.</li> <li>• <b>OFF</b> : Do not display upgrade message.</li> </ul> <p> When you press <b>ENTER</b> during display of the notification message, the "Add New Feature" screen is displayed. (Refer to page 44 for more information on "Add New Feature")</p> <ul style="list-style-type: none"> <li>• Press <b>RETURN</b> to erase the notification message.</li> </ul>

Setting items	Setting contents
<b>Rhapsody Account</b>	<p><b>Username / Password</b> Set or change Username and Password ( page 65 "Listening to Rhapsody").</p> <p>The types of characters that can be input are as shown below.</p> <div style="border: 1px solid black; padding: 5px;"> <p><b>[Lower case characters]</b> abcdefghijklmnopqrstuvwxyz  <b>[Upper case characters]</b> ABCDEFGHIJKLMNOPQRSTUVWXYZ  <b>[Symbols]</b> ! " # \$ % &amp; ' ( ) * + , - . / : ; &lt; = &gt; ? @ [ \ ] ^ _ ` {   } ~                      (Space)</p> <p><b>[Numbers]</b> 0123456789</p> </div> <p> You can change the character type when you press <b>[SEARCH]</b> during character input.</p> <ul style="list-style-type: none"> <li>• The password may not contain underscores ( _ ).</li> </ul>
<b>Napster Account</b>	<p><b>Username / Password</b> Set or change Username and Password ( page 63 "Listening to Napster").</p> <p>The types of characters that can be input are as shown below.</p> <div style="border: 1px solid black; padding: 5px;"> <p><b>[Lower case characters]</b> abcdefghijklmnopqrstuvwxyz  <b>[Upper case characters]</b> ABCDEFGHIJKLMNOPQRSTUVWXYZ  <b>[Symbols]</b> ! " # \$ % &amp; ' ( ) * + , - . / : ; &lt; = &gt; ? @ [ \ ] ^ _ ` {   } ~                      (Space)</p> <p><b>[Numbers]</b> 0123456789</p> </div> <p> You can change the character type when you press <b>[SEARCH]</b> during character input.</p> <ul style="list-style-type: none"> <li>• The password may not contain underscores ( _ ).</li> </ul>
<b>Network Information</b>	<p><b>Friendly Name / DHCP= ON/OFF / IP Address / MAC Address</b> Display network information.</p>

## Making Detailed Settings (Manual Setup)



## Making the Multi-zone Settings (Zone Setup)



Default settings are underlined.

Set the audio to playback with multi-zone (ZONE2, ZONE3).

Setting items	Setting contents
<b>Bass</b> Adjust low frequency range (bass).	<b>-10dB ~ +10dB (0dB)</b>
<b>Treble</b> Adjust high frequency range (treble).	<b>-10dB ~ +10dB (0dB)</b>
<b>HPF</b> Make settings for cutting the low range to reduce distortion in the bass.	<b>OFF</b> : The low range is not attenuated. <b>ON</b> : The low range is attenuated.
<b>Level Lch</b> Adjust the left channel output level.	<b>-12dB ~ +12dB (0dB)</b> The "Level Lch" can be set when "Channel" (page 41) is set to "Stereo".
<b>Level Rch</b> Adjust the right channel output level.	<b>-12dB ~ +12dB (0dB)</b> The "Level Rch" can be set when "Channel" (page 41) is set to "Stereo".
<b>Channel</b> Set the signal output from multi-zone.	<b>Stereo</b> : Select stereo output. <b>Mono</b> : Select mono output. When "Amp Assign" (page 34) is set to "ZONE2/3-MONO", the "Channel" setting is automatically set to "Mono".
<b>Volume Display</b> Set how volume is displayed.	<b>Relative</b> : Display --- dB (Min), in the range -80 dB ~ 18 dB. <b>Absolute</b> : Display in the range 0 (Min) ~ 99.  • The "Volume Display" setting is applied also to the "Volume Level", "Volume Limit" and "Power On Level" display method. • The "Volume Display" setting applies to all zones.
<b>Volume Level</b> Set the volume output level.	<b>Variable</b> : Volume adjustment enabled by main unit and remote controller. <b>-40dB (41)</b> : Fix volume at -40 dB. Set when adjusting volume by external amp. <b>0dB (81)</b> : Fix volume at 0 dB. Set when adjusting volume by external amp. When "Amp Assign" (page 34) is set to "ZONE2", "ZONE3" or "ZONE2/3-MONO", the "Volume Level" setting is automatically set to "Variable".

Setting items	Setting contents
<b>Volume Limit</b> Make a setting for maximum volume.	<b>OFF</b> : Do not set a maximum volume. <b>-20dB (61) / -10dB (71) / 0dB (81)</b> Can be set when the multi-zone "Volume Level" setting (page 41) is "Variable".
<b>Power On Level</b> Define the volume setting that is active when the power is turned on.	<b>Last</b> : Use the memorized setting from the last session. <b>--- (0)</b> : Always use the muting on condition when power is turned on. <b>-80dB ~ 18dB (1 ~ 99)</b> : The volume is adjusted to the set level. Can be set when the multi-zone "Volume Level" setting (page 41) is "Variable".
<b>Mute Level</b> Set the amount of attenuation when muting is on.	<b>Full</b> : The sound is muted entirely. <b>-40dB</b> : The sound is attenuated by 40 dB down. <b>-20dB</b> : The sound is attenuated by 20 dB down.



## Making Other Settings (Option Setup)



Default settings are underlined.

Setting items	Setting contents
<b>Volume Control</b> Set the MAIN ZONE volume setting.	<b>Volume Display</b> : Set how volume is displayed. • <b>Relative</b> : Display --- dB (Min), in the range -80 dB ~ 18 dB. • <b>Absolute</b> : Display in the range 0 (Min) ~ 99.  • The "Volume Display" setting is applied also to the "Volume Limit" and "Power On Level" display method. • The "Volume Display" setting applies to all zones. <b>Volume Limit</b> : Make a setting for maximum volume • <b>OFF</b> : Do not set a maximum volume. • <b>-20dB (61) / -10dB (71) / 0dB (81)</b> <b>Power On Level</b> : Define the volume setting that is active when the power is turned on. • <b>Last</b> : Use the memorized setting from the last session. • <b>--- (0)</b> : Always use the muting on condition when power is turned on. • <b>-80dB ~ 18dB (1 ~ 99)</b> : The volume is adjusted to the set level. <b>Mute Level</b> : Set the amount of attenuation when muting is on. • <b>Full</b> : The sound is muted entirely. • <b>-40dB</b> : The sound is attenuated by 40 dB down. • <b>-20dB</b> : The sound is attenuated by 20 dB down.







Setting items	Setting contents
<b>Source Delete</b> Remove input sources that are not used from the display.	<b>PHONO / CD / DVD / HDP / TV / SAT/CBL / VCR / DVR / V.AUX / NET/USB / SIRIUS / HD Radio</b> : Select input source that is not used. <ul style="list-style-type: none"> <li>• <b>ON</b> : Use this source.</li> <li>• <b>Delete</b> : Do not use this source.</li> </ul> <p><b>NOTE</b></p> <ul style="list-style-type: none"> <li>• Input sources being used in the various zones cannot be deleted.</li> <li>• Input sources set to "Delete" cannot be selected using <b>SOURCE SELECT</b>.</li> </ul>
<b>GUI</b> Make GUI related settings.	<b>Screensaver</b> : Make screensaver settings. <ul style="list-style-type: none"> <li>• <b>ON</b> : The screen saver is activated during GUI menu display or NET/USB / iPod / SIRIUS / HD Radio screen display if no operation is performed approximately for a continuous 3-minute period. When you press <math>\Delta \nabla \triangleleft \triangleright</math>, the screen saver is cancelled and the screen before that screen saver started is displayed.</li> <li>• <b>OFF</b> : Screen saver is not activated.</li> </ul> <b>Wall Paper</b> : Set wallpaper to display the background when playback is stopped, etc. <ul style="list-style-type: none"> <li>• <b>Picture</b> : Set the background to a picture (DENON logo).</li> <li>• <b>Black</b> : Set the background to black.</li> </ul> <b>Format</b> : Set the video signal format to be output for the TV you are using. <ul style="list-style-type: none"> <li>• <b>NTSC</b> : Select NTSC output.</li> <li>• <b>PAL</b> : Select PAL output.</li> </ul> <p> The "Format" can also be set by the following procedure. However, the GUI screen is not displayed.</p> <ol style="list-style-type: none"> <li>1. Press and hold the <b>&lt;AUDIO DELAY&gt;</b> and <b>&lt;RETURN&gt;</b> for at least 3 seconds. "Video Format" appears on the display.</li> <li>2. Press <math>\triangleleft \triangleright</math> and set the video signal format.</li> <li>3. Press the <b>&lt;ENTER&gt;</b>, <b>&lt;MENU&gt;</b> or <b>&lt;RETURN&gt;</b> to complete the setting.</li> </ol> <p><b>NOTE</b></p> When a format other than the video format of the connected TV is set, the picture will not be displayed properly.

Setting items	Setting contents
<b>GUI</b> (Continued)	<b>Master Volume</b> : Master volume display during adjustment. <ul style="list-style-type: none"> <li>• <b>Bottom</b> : Display at the bottom.</li> <li>• <b>Top</b> : Display at the top.</li> <li>• <b>OFF</b> : Turn display off.</li> </ul> <p> When the master volume display is hard to see when superimposed on movie subtitles, set to "Top".</p> <b>NET/USB</b> : Set the NET/USB screen display time when the input source is "NET/USB". <ul style="list-style-type: none"> <li>• <b>Always</b> : Show display continuously.</li> <li>• <b>30s</b> : Show display for 30 seconds after operation.</li> <li>• <b>10s</b> : Show display for 10 seconds after operation.</li> <li>• <b>OFF</b> : Turn display off.</li> </ul> <b>iPod</b> : Set the iPod screen display time when the input source is "iPod". <ul style="list-style-type: none"> <li>• <b>Always</b> : Show display continuously.</li> <li>• <b>30s</b> : Show display for 30 seconds after operation.</li> <li>• <b>10s</b> : Show display for 10 seconds after operation.</li> <li>• <b>OFF</b> : Turn display off.</li> </ul> <b>Tuner</b> : Set the tuner screen display time when the input source is "SIRIUS" or "HD Radio". <ul style="list-style-type: none"> <li>• <b>Always</b> : Show display continuously.</li> <li>• <b>30s</b> : Show display for 30 seconds after operation.</li> <li>• <b>10s</b> : Show display for 10 seconds after operation.</li> <li>• <b>OFF</b> : Turn display off.</li> </ul>
<b>Quick Select Name</b> Change the "Quick Select" display title to one you prefer.	<ol style="list-style-type: none"> <li>1. Use <math>\Delta \nabla</math> to select the name of the Quick Select setting you want to change, then press <math>\triangleright</math> or <b>ENTER</b>.</li> <li>2. Use <math>\triangleleft \triangleright</math> to set the cursor to the character you want to change.</li> <li>3. Use <math>\Delta \nabla</math> to change the character, then press <b>ENTER</b>.                             <ul style="list-style-type: none"> <li>• Up to 16 characters can be input.</li> <li>• You can change the character type when you press <b>[SEARCH]</b> during character input.</li> <li>• The types of characters that can be input are as shown below.</li> </ul> <div style="border: 1px solid black; padding: 5px; margin: 5px 0;"> <p><b>[Upper case characters]</b> ABCDEFGHIJKLMNOPQRSTUVWXYZ  <b>[Lower case characters]</b> abcdefghijklmnopqrstuvwxyz  <b>[Symbols]</b> ! " # \$ % &amp; ' ( ) * + , - . / : ; &lt; = &gt; ? @ [ \ ] ^ _ ` {   } ~                      (Space)</p> <p><b>[Numbers]</b> 0123456789</p> </div> </li> <li>4. Repeat steps 1 ~ 3 to change the display name.</li> </ol>

See overleaf

## Making Detailed Settings (Manual Setup)

Setting items	Setting contents
<b>Zone Rename</b> Change the display title of each zone to one you prefer.	<ol style="list-style-type: none"> <li>Use <math>\Delta</math> <math>\nabla</math> to select the zone name (MAIN ZONE, ZONE2 or ZONE3) you want to change, then press <math>\triangleright</math> or <b>ENTER</b>.</li> <li>Use <math>\triangleleft</math> <math>\triangleright</math> to set the cursor to the character you want to change.</li> <li>Use <math>\Delta</math> <math>\nabla</math> to change the character, then press <b>ENTER</b>.               <ul style="list-style-type: none"> <li>Up to 10 characters can be input.</li> <li>You can change the character type when you press <b>[SEARCH]</b> during character input.</li> <li>The types of characters that can be input are as shown below.</li> </ul> </li> </ol> <div style="border: 1px solid black; padding: 5px; margin: 5px 0;"> <p><b>[Upper case characters]</b> ABCDEFGHIJKLMNOPQRSTUVWXYZ  <b>[Lower case characters]</b> abcdefghijklmnopqrstuvwxyz  <b>[Symbols]</b> ! " # \$ % &amp; ' ( ) * + , - . / : ; &lt; = &gt; ? @ [ \ ] ^ _ ` {   } ~            (Space)</p> <p><b>[Numbers]</b> 0123456789</p> </div> <ol style="list-style-type: none"> <li>Repeat steps 1 ~ 3 to change the display name.</li> </ol>
<b>Trigger Out 1</b> Select the condition for activating Trigger Out 1 for the input source, surround mode, etc. See "TRIGGER OUT jacks" (page 22) for more information on trigger out.	<ul style="list-style-type: none"> <li><input type="checkbox"/> <b>When Setting for Zone (MAIN ZONE / ZONE2 / ZONE3)</b>              Trigger out is activated through linkage to the power of the zone set to "ON".</li> <li><input type="checkbox"/> <b>When Setting for Input Source</b>              Activate trigger out when the input source set to "ON" is selected.             <ul style="list-style-type: none"> <li> Valid for the zone set to "ON" with "When Setting for Zone".</li> </ul> </li> <li><input type="checkbox"/> <b>When Setting for Surround Mode</b>              Activate trigger out when the surround mode set to "ON" is selected.             <ul style="list-style-type: none"> <li> Valid when the "MAIN ZONE" set to "ON" with "When Setting for Zone" is selected, and when the input source set to "ON" with "When Setting for Input Source" is selected.</li> </ul> </li> </ul> <ul style="list-style-type: none"> <li>• <b>ON</b> : Activate trigger on this mode.</li> <li>• <b>---</b> : Do not activate trigger on this mode.</li> </ul>
<b>Trigger Out 2</b> As with "Trigger Out 1", select the condition for activating Trigger Out 2.	
<b>Remote ID</b> Set when you operate another DENON AV amplifier with the remote control unit of the AVR-3310CI. Match the remote control unit you are using with the remote ID of the AVR-3310CI.	<ol style="list-style-type: none"> <li>1 / 2 / 3 / 4</li> </ol> <ul style="list-style-type: none"> <li> When using the AVR-3310CI with only the included main remote control unit (RC-1118), use Remote ID "1" (default).              When using the included sub remote control unit (RC-1121) and a separately sold remote control unit (RC-7000CI, etc.), this function can be used. Match the ID setting of the remote control unit and the receiver.</li> </ul>

Setting items	Setting contents
<b>232C Port</b> Set when using an external controller or two-way remote control connected to the RS-232C terminal.	<p><b>Serial Control</b> : Set when using an external controller.</p> <p><b>2Way Remote</b> : Set when using a 2-way remote control unit.</p> <ul style="list-style-type: none"> <li> When using a DENON two-way remote control (RC-7000CI or RC-7001RCI, sold separately), set to "2Way Remote".</li> </ul> <p><b>NOTE</b></p> <p>When setting to "2Way Remote", you can not use the RS-232C connector as an external controller.</p>
<b>Dimmer</b> Adjust display brightness of the receiver.	<p><b>Bright</b> : Normal display brightness.</p> <p><b>Dim</b> : Reduced display brightness.</p> <p><b>Dark</b> : Very low display brightness.</p> <p><b>OFF</b> : Turns the display off.</p>
<b>Setup Lock</b> Protect settings from inadvertent change.	<p><b>OFF</b> : Turn protection off.</p> <p><b>ON</b> : Turn protection on.</p> <ul style="list-style-type: none"> <li> When "Setup Lock" is set to "ON", the settings listed below can no longer be changed. Also, "SETUP LOCKED!" is displayed if you attempt to operate related settings.             <ul style="list-style-type: none"> <li>· GUI menu operations</li> <li>· RESTORER</li> <li>· Audio/Video Adjust</li> <li>· MultEQ</li> <li>· Dynamic EQ</li> <li>· Dynamic Volume</li> <li>· Channel Level</li> <li>· Audio Delay</li> <li>· Input Mode</li> </ul> </li> <li>• When canceling the setting, set "Setup Lock" to "OFF".</li> </ul>
<b>Maintenance Mode</b> Used when receiving maintenance from a DENON service engineer or custom installer.	<p><b>NOTE</b></p> <p>Only use this function if so instructed by a DENON serviceperson or installer.</p>

Setting items	Setting contents												
<p><b>Firmware Update</b> Update the firmware of the receiver.</p>	<p><b>Check for Update</b> : You can check for firmware updates. You can also check approximately how long it will take to complete an update.</p> <p><b>Start</b> : Execute the update process. When updating starts, the power indicator becomes red and the GUI screen is shut down. The amount of update time which has elapsed is displayed. When updating is complete the power indicator becomes green and normal status is resumed.</p> <p>※ If updating fails, the set automatically retries, but if updating is still not possible, one of the messages shown below is displayed. If the display reads as shown below, check the settings and network environment, then update again.</p> <table border="1"> <thead> <tr> <th>Display</th> <th>Description</th> </tr> </thead> <tbody> <tr> <td><b>Updating failed</b></td> <td>Updating failed.</td> </tr> <tr> <td><b>Login failed</b></td> <td>Failure to log into server.</td> </tr> <tr> <td><b>Server is busy</b></td> <td>Server is busy. Wait a while then try again.</td> </tr> <tr> <td><b>Connection fail</b></td> <td>Failure connecting to server.</td> </tr> <tr> <td><b>Download fail</b></td> <td>Downloading of the firmware has failed.</td> </tr> </tbody> </table>	Display	Description	<b>Updating failed</b>	Updating failed.	<b>Login failed</b>	Failure to log into server.	<b>Server is busy</b>	Server is busy. Wait a while then try again.	<b>Connection fail</b>	Failure connecting to server.	<b>Download fail</b>	Downloading of the firmware has failed.
Display	Description												
<b>Updating failed</b>	Updating failed.												
<b>Login failed</b>	Failure to log into server.												
<b>Server is busy</b>	Server is busy. Wait a while then try again.												
<b>Connection fail</b>	Failure connecting to server.												
<b>Download fail</b>	Downloading of the firmware has failed.												
<p><b>Add New Feature</b> Display the new functions (payment required) which can be purchased for downloading to the AVR-3310CI and upgrade. When you purchase a new function and register your user information, "Registered" is displayed on this menu and you can proceed with the upgrade.</p>	<p><b>Upgrade</b> : Execute the upgrade process. When updating starts, the power indicator becomes red and the GUI screen is shut down. The amount of update time which has elapsed is displayed. When updating is complete the power indicator becomes green and normal status is resumed.</p> <p>※ If the upgrade is not successful, an error message identical to those in "Firmware Update" will appear on the display, check the settings and network environment, then update again.</p> <p><b>Upgrade Status</b> : A list of the additional functions provided by the Upgrade will be displayed.</p> <p> When "Not Registered" is displayed on the Add New Feature screen, you cannot upgrade. To use the upgrade function, you should purchase an upgrade package from the DENON website. To purchase the package, you will need the ID number shown on this screen. To display the ID number on the screen, hold &lt;D&gt; and &lt;STATUS&gt; down for 3 seconds or more.</p>												

Notes concerning use of "Firmware Update" and "Add New Feature"
<ul style="list-style-type: none"> <li>• In order to use these functions, you must have the correct system requirements and settings for a broadband Internet connection.</li> <li>• Do not turn off the power until updating or upgrading is completed.</li> <li>• Even with a broadband connection to the Internet, approximately 1 hour is required for the updating/upgrading procedure to be completed. Once updating/upgrading starts, normal operations on the AVR-3310CI cannot be performed until updating/upgrading is completed. Furthermore, updating/upgrading the firmware may reset the backup data for the parameters, etc., set for the AVR-3310CI.</li> <li>• The following backup data may be erased after an update or upgrade. <ul style="list-style-type: none"> <li>• Internet radio preset channel</li> <li>• Internet radio Recently Played data</li> <li>• Care of data in Internet radio, media server and USB memory device</li> </ul> </li> <li>• In the event of an update error during update or upgrade, turn the AVR-3310CI's power off and then on again. "Update Retry" appears on the display and update restarts from the point at which update failed. If the error continues despite this, check the network environment.</li> </ul>



- Information regarding the "Firmware Update" function and "Add New Feature" will be announced on the DENON web site each time related plans are defined.
- When usable new firmware is released with "Firmware Update" or "Add New Feature", a notification message is displayed on the GUI screen. When you do not want to be notified, set "Update Notification" (🔧 page 40) and "Upgrade Notification" (🔧 page 40) to "OFF".





## Making the Input Settings (Input Setup)

GUI

For details on how to select, set and cancel settings for each menu, see "GUI Menu Operation" (page 26).

Make the settings related to the currently selected input source.  
Before displaying the menu screen, press **[SOURCE SELECT]** to switch to the input source to be set.  
The items that can be set differ according to the selected input source.  
The set can be used without changing these settings. Make these settings as necessary.  
For a description of "GUI Menu Map" and operating instructions, see page 25.

### Items that can be set with the Input Setup procedure

Changing the Input Terminal Assignments (Input Assign) (page 45)

Making the Video Settings (Video) (page 48)

Changing the Input Mode and Decoding Mode (Input Mode) (page 49)

Changing the Input Source's Display Name (Rename) (page 49)

Correcting the Input Source's Playback Level (Source Level) (page 49)

Setting the Playback Mode (Playback Mode) (page 50)

- iPod (page 50)
- NET/USB, Media Server, USB, Napster and Rhapsody (page 50)

Making the Settings to Play Still Pictures (Still Picture) (page 50)

Automatically Presetting Radio Stations (Auto Preset) (page 50)

Setting Preset Channels so that They are not Displayed When Tuning (Preset Skip) (page 50)

Giving Names to Preset Stations (Preset Name) (page 51)

Check the SIRIUS Radio Reception Sensitivity (Antenna Aiming) (page 51)

Setting SIRIUS Radio Reception Restrictions (Parental Lock) (page 51)

## Important Information

### About the Display of Input Sources in This Manual

In this manual, the names of input sources that can be set at the different items are indicated as shown below.

**PHONO** **CD** **DVD** **HDP** **TV** **SAT/CBL** **VCR** **DVR** **V.AUX** **NET/USB** **Internet Radio**  
**Media Server** **USB** **Napster** **Rhapsody** **SIRIUS** **HD Radio**

#### NOTE

Input sources that have been set to "Delete" at "Source Delete" (page 42) cannot be selected.

## Changing the Input Terminal Assignments (Input Assign)

GUI

Default settings are underlined.

### Examples of Input Assign Menu Screen Displays

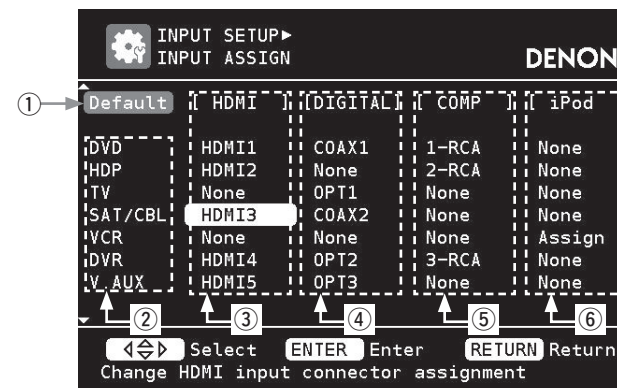

- ① Default button
- ② Input Source
- ③ HDMI input
- ④ Digital audio input
- ⑤ Component video input
- ⑥ iPod dock



Input Assignments Menu Operations

1 Press MENU.

The GUI menu is displayed on the TV screen.

Use the  $\Delta \nabla$  to select "Input Setup", then press ENTER or  $\triangleright$ .



2 Select "Input Assign", then press ENTER or  $\triangleright$ .

The "INPUT ASSIGN" screen is displayed.

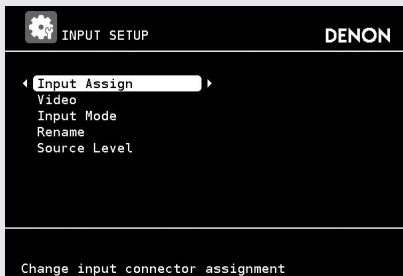

3 Use  $\Delta \nabla \triangleleft \triangleright$  to move the orange highlight to the item you want to set.

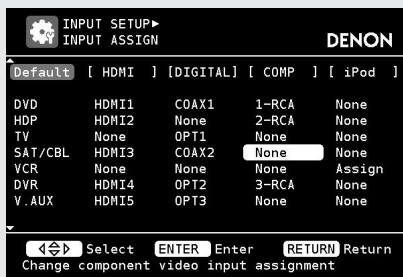

4 Press ENTER, then use  $\triangleleft \triangleright$  to select the input terminal to be assigned.

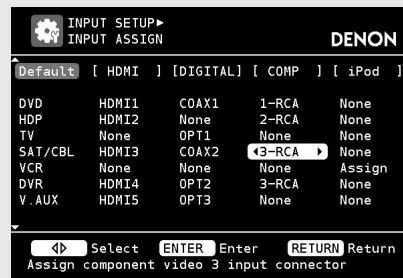

5 Press ENTER to enter the setting.

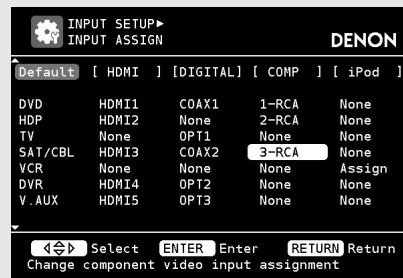

Setting items	Setting contents																
<p><b>HDMI</b></p> <p>Set this to change the HDMI input terminals assigned to the input sources.</p>	<p>The <b>DVD</b> <b>HDP</b> <b>TV</b> <b>SAT/CBL</b> <b>VCR</b> <b>DVR</b> <b>V.AUX</b> input sources are assigned to the HDMI input terminals as shown below.</p> <p><b>HDMI 1 / HDMI 2 / HDMI 3 / HDMI 4 / HDMI 5</b></p> <p><b>None</b> : Do not assign an HDMI input terminal to the selected input source.</p> <p>※ Upon purchase, the settings of the different input sources are as shown below.</p> <table border="1"> <thead> <tr> <th>Input source</th> <th>DVD</th> <th>HDP</th> <th>TV</th> <th>SAT/CBL</th> <th>VCR</th> <th>DVR</th> <th>V.AUX</th> </tr> </thead> <tbody> <tr> <td>Default setting</td> <td>HDMI 1</td> <td>HDMI 2</td> <td>None</td> <td>HDMI 3</td> <td>None</td> <td>HDMI 4</td> <td>HDMI 5</td> </tr> </tbody> </table> <p> An input source to which an HDMI input terminal cannot be assigned is displayed as " - - -".</p> <ul style="list-style-type: none"> <li>To play the video signal assigned at "HDMI" combined with the audio signal assigned at "Input Assign" - "Digital", select "Digital" at "Input Mode" (page 49).</li> <li>When the AVR-3310CI and monitor are connected with an HDMI cable, if the monitor is not compatible with HDMI audio signal playback, only the video signals are output to the monitor.</li> <li>The audio signals input from the analog, digital and EXT. IN connectors are not output to the monitor.</li> <li>When control dock for iPod is used as the input source, assignment of the HDMI input terminal is disabled, even if it is assigned.</li> <li>When "HDMI Control" (page 36) is set to "ON", HDMI input terminal cannot be assigned to "TV".</li> </ul>	Input source	DVD	HDP	TV	SAT/CBL	VCR	DVR	V.AUX	Default setting	HDMI 1	HDMI 2	None	HDMI 3	None	HDMI 4	HDMI 5
Input source	DVD	HDP	TV	SAT/CBL	VCR	DVR	V.AUX										
Default setting	HDMI 1	HDMI 2	None	HDMI 3	None	HDMI 4	HDMI 5										
<p><b>Digital</b></p> <p>Set this to change the digital input terminals assigned to the input sources.</p>	<p>The <b>CD</b> <b>DVD</b> <b>HDP</b> <b>TV</b> <b>SAT/CBL</b> <b>VCR</b> <b>DVR</b> <b>V.AUX</b> <b>SIRIUS</b> input sources are assigned to the digital input terminals as shown below.</p> <p><b>Coax 1 (Coaxial) / Coax 2 / Coax 3 / Opt 1 (Optical) / Opt 2 / Opt 3</b></p> <p><b>None</b> : Do not assign a digital input terminal to the selected input source.</p>																

See overleaf

## Making the Input Settings (Input Setup)





Setting items	Setting contents																						
<b>Digital</b> (Continued)	<p>※ Upon purchase, the settings of the different input sources are as shown below.</p> <table border="1"> <tr> <td><b>Input source</b></td> <td><b>CD</b></td> <td><b>DVD</b></td> <td><b>HDP</b></td> <td><b>TV</b></td> <td><b>SAT/CBL</b></td> <td><b>VCR</b></td> </tr> <tr> <td><b>Default setting</b></td> <td><b>Coax 3</b></td> <td><b>Coax 1</b></td> <td>None</td> <td><b>Opt 1</b></td> <td><b>Coax 2</b></td> <td>None</td> </tr> </table> <table border="1"> <tr> <td><b>Input source</b></td> <td><b>DVR</b></td> <td><b>V.AUX</b></td> <td><b>SIRIUS</b></td> </tr> <tr> <td><b>Default setting</b></td> <td><b>Opt 2</b></td> <td><b>Opt 3</b></td> <td>None</td> </tr> </table> <p> When control dock for iPod is used as the input source, assignment of the digital input terminal is disabled, even if it is assigned.</p>	<b>Input source</b>	<b>CD</b>	<b>DVD</b>	<b>HDP</b>	<b>TV</b>	<b>SAT/CBL</b>	<b>VCR</b>	<b>Default setting</b>	<b>Coax 3</b>	<b>Coax 1</b>	None	<b>Opt 1</b>	<b>Coax 2</b>	None	<b>Input source</b>	<b>DVR</b>	<b>V.AUX</b>	<b>SIRIUS</b>	<b>Default setting</b>	<b>Opt 2</b>	<b>Opt 3</b>	None
<b>Input source</b>	<b>CD</b>	<b>DVD</b>	<b>HDP</b>	<b>TV</b>	<b>SAT/CBL</b>	<b>VCR</b>																	
<b>Default setting</b>	<b>Coax 3</b>	<b>Coax 1</b>	None	<b>Opt 1</b>	<b>Coax 2</b>	None																	
<b>Input source</b>	<b>DVR</b>	<b>V.AUX</b>	<b>SIRIUS</b>																				
<b>Default setting</b>	<b>Opt 2</b>	<b>Opt 3</b>	None																				
<b>Component</b> Set this to change the component video input terminals assigned to the input sources.	<p>The <b>DVD</b> <b>HDP</b> <b>TV</b> <b>SAT/CBL</b> <b>VCR</b> <b>DVR</b> <b>V.AUX</b> input sources are assigned to the component video input terminals as shown below.</p> <p><b>1-RCA</b> (Component video 1) / <b>2-RCA</b> (Component video 2) / <b>3-RCA</b> (Component video 3)  <b>None</b> : Do not assign a component video input terminal to the selected input source.</p> <p>※ Upon purchase, the settings of the different input sources are as shown below.</p> <table border="1"> <tr> <td><b>Input source</b></td> <td><b>DVD</b></td> <td><b>HDP</b></td> <td><b>TV</b></td> <td><b>SAT/CBL</b></td> <td><b>VCR</b></td> <td><b>DVR</b></td> <td><b>V.AUX</b></td> </tr> <tr> <td><b>Default setting</b></td> <td><b>1-RCA</b></td> <td><b>2-RCA</b></td> <td>None</td> <td>None</td> <td>None</td> <td><b>3-RCA</b></td> <td>None</td> </tr> </table> <p></p> <ul style="list-style-type: none"> <li>• An input source to which a component video input terminal cannot be assigned is displayed as “---”.</li> <li>• When control dock for iPod is used as the input source, assignment of the component video input terminal is disabled, even if it is assigned.</li> </ul>	<b>Input source</b>	<b>DVD</b>	<b>HDP</b>	<b>TV</b>	<b>SAT/CBL</b>	<b>VCR</b>	<b>DVR</b>	<b>V.AUX</b>	<b>Default setting</b>	<b>1-RCA</b>	<b>2-RCA</b>	None	None	None	<b>3-RCA</b>	None						
<b>Input source</b>	<b>DVD</b>	<b>HDP</b>	<b>TV</b>	<b>SAT/CBL</b>	<b>VCR</b>	<b>DVR</b>	<b>V.AUX</b>																
<b>Default setting</b>	<b>1-RCA</b>	<b>2-RCA</b>	None	None	None	<b>3-RCA</b>	None																





Setting items	Setting contents
<b>iPod dock</b> Assign the control dock for iPod input.	<p>The control dock for iPod can be assigned to the <b>CD</b> <b>DVD</b> <b>HDP</b> <b>TV</b> <b>SAT/CBL</b> <b>VCR</b> <b>DVR</b> <b>V.AUX</b> input sources.</p> <p><b>Assign</b> : Assign the control dock for iPod to the selected input source.  <b>None</b> : Do not assign the control dock for iPod to the selected input source.</p> <p></p> <ul style="list-style-type: none"> <li>• By default on first use, it is assigned to “VCR (iPod)”.</li> <li>• An input source to which control dock for iPod cannot be assigned is displayed as “---”.</li> <li>• If control dock for iPod is not connected to the AVR-3310CI, assignment of the “iPod dock” is disabled, and you can use it as a standard input source.</li> </ul>
<b>Default</b> Reset all settings to factory default.	<p><b>Yes</b> : Reset to the defaults.  <b>No</b> : Do not reset to the defaults.</p> <p> If you select “Default” and press <b>ENTER</b> the message “Default Setting?” is displayed. Select “Yes” or “No”, and then press <b>ENTER</b>.</p>

## Making the Video Settings (Video)

GUI

Default settings are underlined.

Setting items	Setting contents
<b>Video Select</b> Change video input to your preferred input source.	<p><b>SOURCE</b> : Play the picture and sound of the input source.  <b>DVD / HDP / TV / SAT/CBL / VCR / DVR / V.AUX</b> : Select video input source to view. This can be set for individual input sources.</p> <p> Set by either pressing <b>&lt;VIDEO SELECT&gt;</b> on the main unit or <b>[VIDEO SELECT]</b> on the main remote control.</p> <ul style="list-style-type: none"> <li>When operating from the main remote control unit                      Press <b>[VIDEO SELECT]</b> repeatedly until the picture you want to see is displayed.                      To cancel, press <b>[VIDEO SELECT]</b>, and select "SOURCE"</li> <li>When operating from the main unit                      After pressing <b>&lt;VIDEO SELECT&gt;</b> on the main unit, turn the <b>&lt;SOURCE SELECT&gt;</b> on the main unit until the picture you want to see is displayed.                      To cancel, press <b>&lt;VIDEO SELECT&gt;</b>, then turn <b>&lt;SOURCE SELECT&gt;</b> and select "SOURCE".</li> </ul> <p><b>NOTE</b></p> <ul style="list-style-type: none"> <li>It is not possible to select HDMI input signals.</li> <li>The video select function does not work with HDMI signals.</li> <li>Input sources for which "Delete" is selected at "Source Delete" ( page 42) cannot be selected.</li> </ul>
<b>Video Convert</b> The input video signal is converted automatically in function of the connected TV (  page 10 "Converting Input Video Signals for Output (Video Conversion Function)").	<p>This can be set when the input source is <b>DVD HDP TV SAT/CBL</b>  <b>VCR DVR V.AUX</b>.</p> <p><b>ON</b> : The input video signal is converted.  <b>OFF</b> : The input video signal is not converted.</p> <p> </p> <ul style="list-style-type: none"> <li>When a non-standard video signal from a game machine or some other source is input, the video conversion function might not operate. In this case set "Video Convert" to "OFF".</li> <li>When "Video Convert" is set to "OFF", the video conversion function does not work. In this case, connect the AVR-3310CI and TV with the same type of cable.</li> </ul>

Setting items	Setting contents
<b>i/p Scaler</b> The input source's resolution is converted to the resolution set at "Resolution".	<p>This can be set when the input source is <b>DVD HDP TV SAT/CBL</b>  <b>VCR DVR V.AUX NET/USB</b>.</p> <p><b>Analogue</b> : Use i/p scaler function for analog video signal.  <b>Analogue &amp; HDMI</b> : Use i/p scaler function for analog and HDMI video signal.  <b>OFF</b> : Do not use i/p scaler function.</p> <p> </p> <ul style="list-style-type: none"> <li>This can be set when "Video Convert" is set to "ON".</li> <li>"Analogue &amp; HDMI" can be set for input sources for which an HDMI input terminal is assigned.</li> <li>When "i/p Scaler" is set to "Analogue &amp; HDMI", it has no effect on the x.v. Color signal or computer resolutions.</li> </ul>
<b>Resolution</b> Set resolution of the video signal output to HDMI.	<p>This can be set when the input source is <b>DVD HDP TV SAT/CBL</b>  <b>VCR DVR V.AUX NET/USB</b>.</p> <p><b>Auto</b> : The number of pixels the TV connected to the HDMI output terminal supports is detected automatically and the appropriate output resolution is set.  <b>480p/576p / 1080i / 720p / 1080p / 1080p:24Hz</b> : Set the output resolution.</p> <p> </p> <ul style="list-style-type: none"> <li>This can be set when "i/p Scaler" is set to anything other than "OFF".</li> <li>When "i/p Scaler" is set to "Analogue &amp; HDMI", the resolution of both the analog video input signal and HDMI input signal can be set.</li> <li>To watch 1080p/24Hz pictures, use a TV that supports 1080p/24Hz video signals.</li> <li>When set to "1080p/24Hz", you can enjoy film-like pictures for film sources (in 24 Hz). For video sources and mixed sources, we recommend setting the resolution to "1080p".</li> <li>It is not possible to convert a 50 Hz signal into 1080p/24Hz. It is output at a resolution of 1080p/50Hz.</li> </ul>
<b>Progressive Mode</b> Select optimum progressive mode for video material.	<p>This can be set when the input source is <b>DVD HDP TV SAT/CBL</b>  <b>VCR DVR V.AUX</b>.</p> <p><b>Auto</b> : The video material is automatically detected and the appropriate mode is set.  <b>Video 1</b> : Select mode suitable for video playback  <b>Video 2</b> : Select mode suitable for video and 30-frame film material playback.</p> <p> This can be set when "i/p Scaler" is set to anything other than "OFF".</p>
<b>Aspect</b> Set the aspect ratio for the video signals output to the HDMI.	<p>This can be set when the input source is <b>DVD HDP TV SAT/CBL</b>  <b>VCR DVR V.AUX NET/USB</b>.</p> <p><b>Full</b> : Output at 16:9 aspect ratio.  <b>Normal</b> : Output at 4:3 aspect ratio.</p> <p> This can be set when "i/p Scaler" is set to anything other than "OFF".</p>





## Making the Input Settings (Input Setup)

## Changing the Input Mode and Decoding Mode (Input Mode)

GUI

Default settings are underlined.

The selectable input modes depend on the input source and "Input Assign" (☞ page 45) setting.

Setting items	Setting contents
<b>Input Mode</b> Set the audio input modes for the different input sources.	<p><b>Auto</b> : Automatically detect input signal and perform playback.  <b>HDMI</b> : Play only signals from HDMI input.  <b>Digital</b> : Play only signals from digital input.  <b>Analog</b> : Play only signals from analog input.  <b>EXT. IN</b> : Play only signals from EXT. IN input.</p> <p></p> <ul style="list-style-type: none"> <li>• "HDMI" can be set for input sources for which "HDMI" is assigned at "Input Assign".</li> <li>• "Digital" can be set for input sources for which "Digital" is assigned at "Input Assign".</li> <li>• When digital signals are properly input, the "[DIG.]" indicator lights on the display. If the "[DIG.]" indicator does not light, check the digital input connector assignment and the connections.</li> <li>• The surround mode cannot be set if the input mode is set to "EXT. IN".</li> <li>• This can also be set by pressing [INPUT MODE]. Each time you press the button, the input mode display will change.</li> </ul> <div style="text-align: center;">  </div>
<b>Decode Mode</b> Set the decode mode for input source.	<p>This can be set when the input source is <b>CD</b> <b>DVD</b> <b>HDP</b> <b>TV</b> <b>SAT/CBL</b> <b>VCR</b> <b>DVR</b> <b>V.AUX</b>.</p> <p><b>Auto</b> : Detect type of digital input signal and decode and play automatically.  <b>PCM</b> : Decode and play only PCM input signals.  <b>DTS</b> : Decode and play only DTS input signals.</p> <p></p> <ul style="list-style-type: none"> <li>• This can be set for input sources for which "HDMI" or "Digital" is assigned at "Input Assign" (☞ page 46).</li> <li>• Normally set this to "Auto". Set "PCM" and "DTS" when inputting the corresponding input signal.</li> </ul>

## Changing the Input Source's Display Name (Rename)

GUI

Setting items	Setting contents
<b>Rename</b> Change the display name of the selected input source.	<ol style="list-style-type: none"> <li>1. Press <math>\triangleright</math> or <b>ENTER</b>.</li> <li>2. Use <math>\triangleleft</math> <math>\triangleright</math> to set the cursor to the character you want to change.</li> <li>3. Use <math>\triangle</math> <math>\nabla</math> to change the character, then press <b>ENTER</b>.           <ul style="list-style-type: none"> <li>• Up to 8 characters can be input.</li> <li>• The input character type can be switched by pressing [SEARCH] while the display name is being changed.</li> <li>• The types of characters that can be input are as shown below.</li> </ul> <div style="border: 1px solid black; padding: 5px; margin: 5px 0;"> <p>[Upper case characters] ABCDEFGHIJKLMNOPQRSTUVWXYZ            [Lower case characters] abcdefghijklmnopqrstuvwxyz            [Symbols] ! " # \$ % &amp; ' ( ) * + , - . / : ; &lt; = &gt; ? @ [ \ ] ^ _ ` {   } ~            (Space)</p> <p>[Numbers] 0123456789</p> </div> </li> <li>4. Repeat steps 2 and 3 to change the display name.</li> </ol>
<b>Default</b> Reset all settings to factory default.	<p><b>Yes</b> : Reset to the defaults.  <b>No</b> : Do not reset to the defaults.</p>

## Correcting the Input Source's Playback Level (Source Level)

GUI

Default settings are underlined.

- Corrects the playback level of the selected input source's audio input.
- Set this if there are differences in the input volume levels between the different sources.

### Setting contents

**-12dB ~ +12dB (0dB)**

-  The analog input level and digital input level can be adjusted independently for input sources for which "HDMI" or "Digital" is assigned at "Input Assign" (☞ page 46).



## Setting the iPod with iPod Dock Playback Mode (Playback Mode)

GUI

This can be set for the input source for which "iPod dock" is assigned at "Input Assign" (page 47).

Setting items	Setting contents
<b>Repeat</b> Make settings for repeat mode.	<b>All</b> : Repeat all songs. <b>One</b> : Repeat the current song. <b>OFF</b> : Cancel repeat mode.
<b>Shuffle</b> Make settings for shuffle mode.	<b>Songs</b> : Shuffle all songs. <b>Albums</b> : Shuffle songs from current album only. <b>OFF</b> : Cancel shuffle mode.

## Setting the NET/USB, Media Server, USB, Napster and Rhapsody Playback Mode (Playback Mode)

GUI

Default settings are underlined.

This can be set when the input source is **NET/USB** **Media Server** **USB** **Napster** **Rhapsody**.

Setting items	Setting contents
<b>Direct Play</b> Use <b>DIRECT PLAY</b> on the sub remote control unit to set the folder to be played.	<b>Favorites</b> : Play songs registered as "Favorites". <b>Music</b> : Play the songs saved on the PC media.
<b>Repeat</b> Make settings for repeat mode.	<b>All</b> : Repeat all files. <b>One</b> : Repeat the current file. <b>OFF</b> : Cancel repeat mode.
<b>Random</b> Make random mode settings.	<b>ON</b> : Enable random playback. <b>OFF</b> : Disable random playback.

## Making the Settings to Play Still Pictures (Still Picture)

GUI

Default settings are underlined.

This can be set when the input source is **NET/USB**.

Setting items	Setting contents
<b>Slide Show</b> Make slide show settings.	<b>ON</b> : Display still picture images in a slide show. <b>OFF</b> : Display only the selected still picture image.
<b>Interval</b> Set the playback time per image.	<b>5s ~ 60s</b> ( <u>5s</u> )

## Automatically Presetting Radio Stations (Auto Preset)

GUI

Setting items	Setting contents
<b>Start</b> Start the auto preset process.	This can be set when the input source is <b>HD Radio</b> .  If an FM station cannot be preset automatically, select the desired station by tuning it in manually, then preset it manually.

## Setting Preset Channels so that They are not Displayed When Tuning (Preset Skip)

GUI

Default settings are underlined.

Setting items	Setting contents
<b>A1 ~ G8</b> Set the preset channels that you do not want to display.	This can be set when the input source is <b>SIRIUS</b> <b>HD Radio</b> . <b>ON</b> : Display the selected preset channel. <b>Skip</b> : Do not display the selected preset channel.  When set to "Block Presets" to "Skip", it is possible to skip entire preset memory blocks (A to G).



## Making the Input Settings (Input Setup)

Giving Names to Preset Stations (Preset Name) 

Setting items	Setting contents
<b>A1 ~ G8</b> Select the preset channel.	This can be set when the input source is <b>HD Radio</b> . <ol style="list-style-type: none"> <li>Press <b>▷</b> or <b>ENTER</b>.</li> <li>Use <b>◀ ▷</b> to set the cursor to the character you want to change.</li> <li>Use <b>△ ▽</b> to change the character, then press <b>ENTER</b>. <ul style="list-style-type: none"> <li>Up to 8 characters can be input.</li> <li>The input character type can be switched by pressing <b>[SEARCH]</b> while the display name is being changed.</li> <li>The types of characters that can be input are as shown below.</li> </ul> <div style="border: 1px solid black; padding: 5px; margin: 5px 0;"> <p><b>[Upper case characters]</b> ABCDEFGHIJKLMNOPQRSTUVWXYZ  <b>[Lower case characters]</b> abcdefghijklmnopqrstuvwxyz  <b>[Symbols]</b> ! " # \$ % &amp; ' ( ) * + , - . / : ; &lt; = &gt; ? @ [ \ ] ^ _ ` {   } ~  (Space)  <b>[Numbers]</b> 0123456789</p> </div> </li> <li>Repeat steps 2 and 3 to change the display name.</li> </ol>
<b>Default</b> Reset all settings to factory default.	<b>Yes</b> : Reset to the defaults. <b>No</b> : Do not reset to the defaults.

Check the SIRIUS Radio Reception Sensitivity (Antenna Aiming) 

- This can be set when the input source is **SIRIUS**.
- Install the antenna with radio reception sensitivity set to maximum.

Setting items	Setting contents										
<b>Satellite</b> Indicate satellite signal strength.	<table border="1"> <thead> <tr> <th>Display</th> <th>Condition</th> </tr> </thead> <tbody> <tr> <td>■■■■</td> <td>Signal strength is excellent</td> </tr> <tr> <td>■■■</td> <td>Signal strength is good</td> </tr> <tr> <td>■</td> <td>Signal strength is weak</td> </tr> <tr> <td></td> <td>No signal</td> </tr> </tbody> </table>	Display	Condition	■■■■	Signal strength is excellent	■■■	Signal strength is good	■	Signal strength is weak		No signal
Display	Condition										
■■■■	Signal strength is excellent										
■■■	Signal strength is good										
■	Signal strength is weak										
	No signal										
<b>Terrestrial</b> Indicate terrestrial signal strength.											

Setting SIRIUS Radio Reception Restrictions (Parental Lock) 

Default settings are underlined&gt;.

- This can be set when the input source is **SIRIUS**.
- For any channel, set the radio reception limits.

Setting items	Setting contents
<b>Lock Setting</b> Set the channel radio reception limits.	<ol style="list-style-type: none"> <li>Press <b>△ ▽</b> to select "Lock Setting", and then press <b>▷</b> or <b>ENTER</b>.</li> <li>Pressing <b>△ ▽ ◀ ▷</b>, input the password (4 digits number) and press <b>ENTER</b>.</li> <li>Select channel by pressing <b>△ ▽</b>, and set the lock by pressing <b>◀ ▷</b>.  <b>Unlock</b> : Do not lock selected channel(s).  <b>Lock</b> : Lock selected channel(s). When a Parental Locked channel is tuned, "Enter Lock Code" is displayed, then input the password. <ul style="list-style-type: none"> <li>The default password is "0000".</li> <li>If the password is wrong, "Lock Code is incorrect" is displayed. Input the correct password.</li> <li>While listening to the channel being played, you can also set parental lock (🔒 page 56).</li> </ul> </li> </ol>
<b>Edit Lock Code</b> Change the password.	<ol style="list-style-type: none"> <li>Press <b>△ ▽</b> to select "Edit Lock Code", and then press <b>▷</b> or <b>ENTER</b>.</li> <li>Input current lock code (4 digits) using <b>△ ▽ ◀ ▷</b>, and press <b>ENTER</b>.</li> <li>Input new lock code (4 digits) using <b>△ ▽ ◀ ▷</b>, and press <b>ENTER</b>.</li> <li>Input new lock code (4 digits) again using <b>△ ▽ ◀ ▷</b>, and press <b>ENTER</b>.</li> <li>Press <b>△ ▽</b> to select "Execute", and then press <b>ENTER</b>.  If the correct password is input, "Completed" is displayed, and the new password is modified. <ul style="list-style-type: none"> <li>If the old password is incorrectly input, "Current Lock Code is incorrect" is displayed, and proceed again from step 1.</li> <li>If the password input is 3 digits or less, "Enter 4 digits number" is displayed, and input again with a 4 digit password.</li> <li>If the new password is not correctly input, "New Lock Codes do not Match" is displayed and the password does not change.</li> </ul> </li> </ol>





## Symbols used to indicate buttons in this manual

- Button located on both the main unit and the remote control unit → **BUTTON**
- Button only on the main unit → **<BUTTON>**
- Button only on the remote control unit → **[BUTTON]**

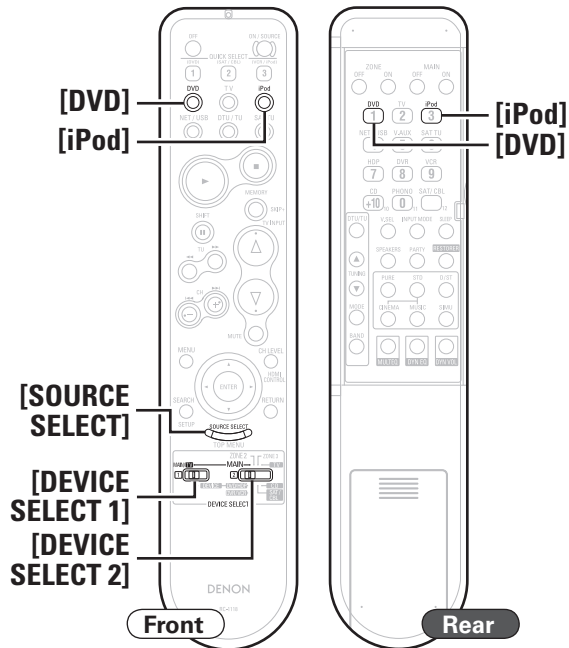

## Important Information

Before starting playback, make the connections between the different components and the settings on the receiver.

### NOTE

- Also refer to the operating instructions of the connected components when playing them.
- External devices can be controlled by remote control unit (☞ page 86 “Operating the Connected Devices by Remote Control Unit”).

## Playing Components

### Playing a Blu-ray Disc Player/DVD Player

The following describes the procedure for playing Blu-ray disc player / DVD player. Use the same procedure to play other components.

#### 1 Playback preparation.

- ① Turn on the power of the TV, subwoofer and player.
- ② Switch the TV's input to the AVR-3310CI.
- ③ Load the disc in the player.

#### 2 Turn the AVR-3310CI power on.

(☞ page 24 “Turning the Power On”)

#### 3 Press [SOURCE SELECT] and select the input source.

Display the “SOURCE SELECT” menu (☞ page 27).

#### 4 Play the component connected to the AVR-3310CI.

Make the necessary settings on the player (language setting, subtitles setting, etc.) beforehand.

#### 5 Adjust the items below.

- Adjusting the master volume (☞ page 67)
- Selecting the surround mode (☞ page 69)
- Adjusting the Sound and Picture Quality (☞ page 71)

## iPod® Playback

When a DENON control dock for iPod (ASD-1R or ASD-11R, sold separately) is used, you can play images and music stored on an iPod®.

iPod is a trademark of Apple Inc., registered in the U.S. and other countries.

※ The iPod may only be used to copy or play contents that are not copyrighted or contents for which copying or playback is legally permitted for your private use as an individual. Be sure to comply with applicable copyright legislation.

## Listening to music on an iPod®

### 1 Playback preparation.

- ① Connecting the DENON control dock for iPod to the AVR-3310CI (☞ page 16 “Control Dock for iPod”).
- ② Set the iPod® in the DENON control dock for iPod.
- ③ Set [DEVICE SELECT 1] to “MAIN/TV” [DEVICE SELECT 2] to “MAIN”.

### 2 Turn the AVR-3310CI power on.

(☞ page 24 “Turning the Power On”)

### 3 Press [SOURCE SELECT] to display the GUI Source Select menu, then select “iPod” (☞ page 27).

The input source switches to the source to which the control dock for iPod is assigned and the iPod menu is displayed.

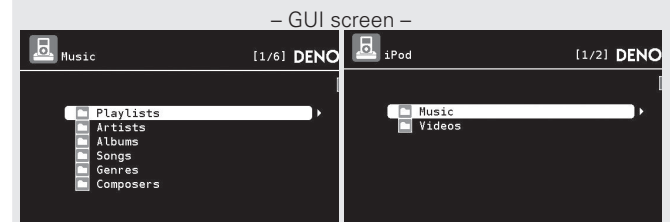

(When using an ASD-1R)

(When using an ASD-11R)

※ When using an ASD-11R, the “Music” and “Videos” folders are displayed on the top menu.

※ Once communications between the AVR-3310CI and the iPod are completed, the connections screen is displayed on the iPod.

※ If the connections screen is not displayed, the iPod may not be properly connected. Reconnect it.

See overleaf

Playing Components

**Symbols used to indicate buttons in this manual**

Button located on both the main unit and the remote control unit → **BUTTON**  
 Button only on the main unit → **<BUTTON>**  
 Button only on the remote control unit → **[BUTTON]**

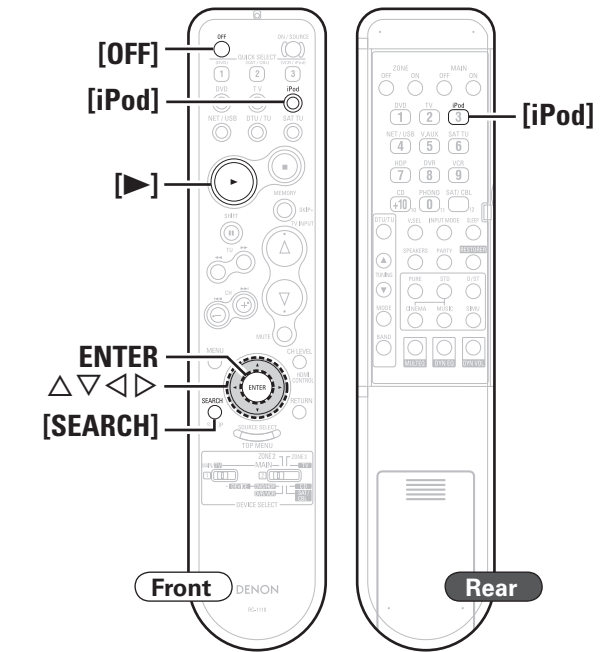
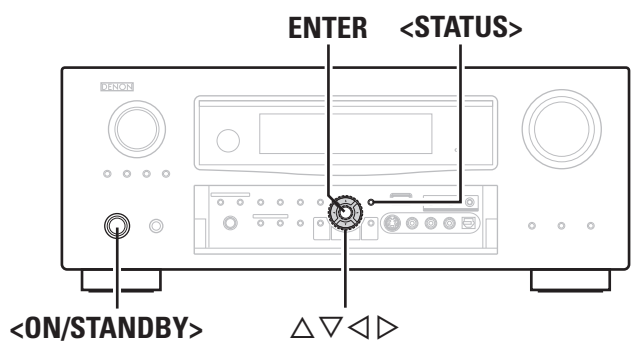

**4 Press [SEARCH] and hold it down for a 2 seconds or more to select the display mode.**

※ There are two modes for display the contents recorded on the iPod.

**Browse mode** :  
 This is the mode for displaying the iPod information on the GUI screen to operate the iPod. In this mode, you cannot perform operations directly on the iPod itself.  
 \* With the AVR-3310CI's display, only English letters and numbers and certain symbols can be displayed. Any characters that cannot be displayed are replaced with ". (period)".

**Remote mode** :  
 This is the mode for performing operations directly on the iPod itself while watching the screen displayed on the iPod. In this mode, the GUI screen is not displayed.  
 \* "Remote iPod" appears on the main unit's display.

Display mode		Browse mode	Remote mode
Playable files	Audio file	○	○
	Picture file	×	○ * 2
	Video file	○ * 1	○ * 2
Active buttons	Remote control unit (AVR-3310CI)	○	○
	iPod®	×	○

\* 1 : When using an ASD-11R DENON control dock for iPod.  
 \* 2 : Video may not be output, depending on the combination of ASD-1R or ASD-11R DENON control dock for iPod and iPod.

**5 Use Δ ∇ to select the item, then press ENTER or ▷ to select the file to be played.**

**6 Press [▶], ENTER or ▷. Playback starts.**

**7 Adjust the items below.**

- Adjusting the master volume (☞ page 67)
- Selecting the surround mode (☞ page 69)
- Adjusting the Sound and Picture Quality (☞ page 71)

- To stop (☞ page 67)
- Stopping playback temporarily (☞ page 67)
- Fast-forwarding or fast-reversing (☞ page 67)
- To cue to the beginning of a track (☞ page 68)
- Playing repeatedly (☞ page 68)
- Shuffling playback (☞ page 68)
- Searching pages (☞ page 68)

- ✎ Use the RESTORER mode to expand the low and high frequency components of compressed audio files and achieve a richer sound (☞ page 74). The default setting is "Mode 3".
- The title name, artist name and album name can be checked by pressing <STATUS> during playback.
- The time (default : 30 sec) for which the GUI menus are displayed can be set at "GUI" - "iPod" (☞ page 42). Press Δ ∇ ◀ ▶ to return to the original screen.
- Press [OFF] or <ON/STANDBY> and set the AVR-3310CI's power to the standby mode before disconnecting the iPod. Also switch the input source to one to which the menu "iPod" is not assigned before disconnecting the iPod.

**NOTE**

- Depending on the type of iPod and the software version, some functions may not operate.
- DENON will accept no responsibility whatsoever for any loss of iPod data.



## Viewing Videos on an iPod® in the Browse Mode

When an iPod equipped with a video function is connected to a DENON ASD-11R control dock for iPod, video files can be played in the browse mode.

- 1** Use  $\triangle\triangledown$  to select “Videos”, then press **ENTER** or  $\triangleright$ .
- 2** Use  $\triangle\triangledown$  to select the search item or folder, then press **ENTER** or  $\triangleright$ .
- 3** Use  $\triangle\triangledown$  to select the video file, then press **ENTER**,  $\triangleright$  or  $\blacktriangleright$ .  
Playback starts.

## Viewing Still Pictures and Videos on an iPod® in the Remote Mode

Photos and videos on an iPod® equipped with a slide show or video function can be played using DENON ASD-1R or ASD-11R control dock for iPod.

- 1** Press and hold **[SEARCH]** to set the Remote mode.  
“Remote iPod” is displayed on the AVR-3310CI’s display.
- 2** Watching the iPod’s screen, use  $\triangle\triangledown$  to select “Photos” or “Videos”.
- 3** Press **ENTER** until the image you want to view is displayed.



“TV Out” at the iPod’s “Slide show Settings” or “Video Settings” must be set to “On” in order to display the iPod’s photo data or videos on the monitor. For details, see the iPod’s operating instructions.

### NOTE

Video may not be output, depending on the combination of ASD-1R or ASD-11R DENON control dock for iPod and iPod.

## Tuning in Radio Stations

### Important Information

#### About SIRIUS XM Radio

To listen to Satellite Radio, you’ll need to connect either a SIRIUS or XM Satellite Radio tuner (sold separately) to your satellite-ready receiver. Satellite Radio is available to residents of the US (except Alaska and Hawaii) and Canada.

Satellite Radio delivers a variety of commercial-free music from categories ranging from Pop, Rock, Country, R&B, Dance, Jazz, Classical and many more plus coverage of all the top professional and college sports including play by play games from select leagues and teams. Additional programming includes expert sports talk, uncensored entertainment, comedy, family programming, local traffic and weather and news from your most trusted sources.

Whether you purchase a SIRIUS or XM tuner, you’ll need to activate and subscribe to begin enjoying the service. Easy to follow installation and setup instructions are provided with the satellite tuners. Whichever service you choose, there are a variety of programming packages available, including the option of adding “The Best of SIRIUS” programming to your XM tuner or “The Best of XM” programming to your SIRIUS tuner, enabling you to enjoy the most popular programming among both services. The “Best of” packages are not available to SIRIUS or XM Canada subscribers at this time.

Family friendly packages are also available to restrict channels featuring content that may be inappropriate for children.

To subscribe to XM, U.S. customers should visit [xmradio.com](http://xmradio.com) or call 1-800-XMRADIO (1-800-967-2346); Canadian customers should visit [xmradio.ca](http://xmradio.ca) or call XM Listener Care at 1-877-GETXMSR (1-877-438-9677).

To subscribe to SIRIUS, U.S. and Canadian customers can call 1-888-539-SIRI (1-888-539-7474) or visit [sirius.com](http://sirius.com) (US) or [siriuscanada.ca](http://siriuscanada.ca) (Canada).

#### SIRIUS XM Radio Legal

SIRIUS, XM and all related marks and logos are trademarks of Sirius XM Radio Inc. and its subsidiaries. All other marks and logos are the property of their respective owners. All rights reserved. SIRIUS and XM subscriptions sold separately. Taxes and a one-time activation fee may apply. XM tuners and home docks or SIRIUS tuners (each sold separately) are required to receive the SIRIUS or XM satellite radio service. All programming and fees subject to change. It is prohibited to copy, decompile, disassemble, reverse engineer, hack, manipulate or otherwise make available any technology or software incorporated in receivers compatible with the SIRIUS or XM Satellite Radio Systems. **Service not available in Alaska and Hawaii.**

#### Using the HD Radio™ Receiver

HD radio stations offer higher sound quality than conventional FM/AM broadcasts. It is also possible to receive data services and select broadcasts from among up to eight multicast programs.

HD Radio technology provides higher quality sound than conventional broadcasts and allows reception of data services.

- FM sounds as sensational as CDs
- AM sounds as rich as analog FM stereo
- A variety of “data services”, including text-based information, song title, artist name, album name, genre, etc. can be received.

Furthermore, in addition to conventional broadcasts, with HD Radio broadcasting it is possible to choose from up to 8 multicast programs.

For detailed information on HD Radio technology, please go to “[www.ibiquity.com](http://www.ibiquity.com)”.

#### HD Radio®

HD Radio™ technology manufactured under license from iBiquity Digital Corporation. iBiquity Digital, the HD Radio logo, and the HD logo are registered trademarks of iBiquity Digital Corporation. HD Radio™ is a trademark of iBiquity Digital Corporation. U.S. and Foreign Patents.

## Tuning in Radio Stations – SIRIUS Satellite Radio



### Symbols used to indicate buttons in this manual

- Button located on both the main unit and the remote control unit → **BUTTON**  
 Button only on the main unit → **<BUTTON>**  
 Button only on the remote control unit → **[BUTTON]**

<SOURCE SELECT> ENTER <STATUS>

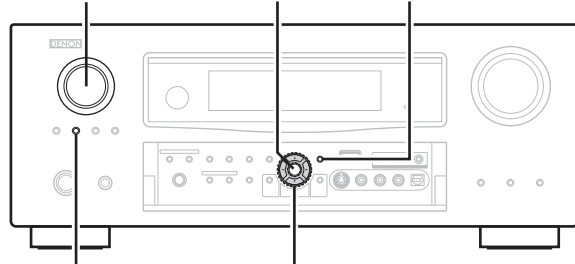

<TUNING PRESET> Δ ∇ ◀ ▶

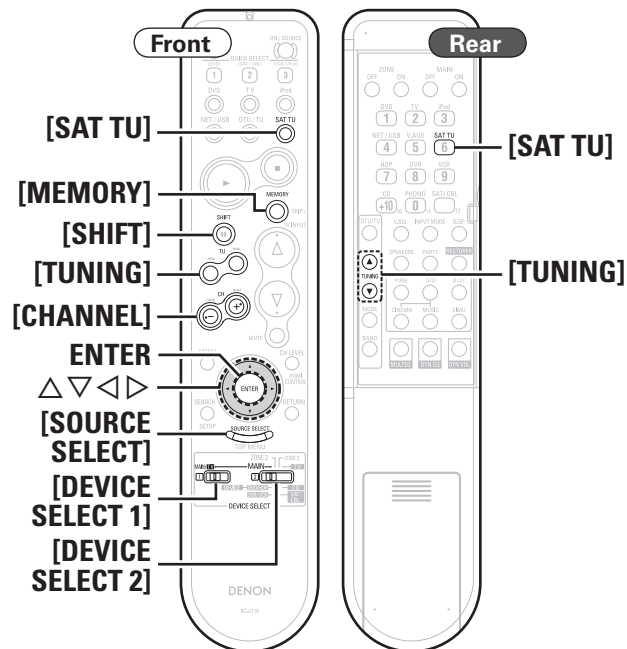

## Listening to SIRIUS Satellite Radio

When operating SIRIUS with the AVR-3310CI via the main remote control unit or sub remote control unit, use **[SAT TU]**.

- 1 Set **[DEVICE SELECT 1]** to “MAIN/TV” and **[DEVICE SELECT 2]** to “MAIN”.
- 2 Press **[SOURCE SELECT]** to display the GUI Source Select menu, then select “SIRIUS” (☞ page 27).
- 3 Use **[TUNING]** to select the channel.  
When the channel is tuned in, the name of the song and artist are displayed.
- 4 Adjust the items below.
  - Adjusting the master volume** (☞ page 67)
  - Selecting the surround mode** (☞ page 69)
  - Adjusting the Sound and Picture Quality** (☞ page 71)



- The channel switches continuously when **[TUNING]** is pressed and held.
- The song title, artist name, composer name, category and reception level can be checked by pressing **<STATUS>**.
- The time (default : 30 sec) for which the GUI menu are displayed can be set “GUI” – “Tuner” (☞ page 42). Press Δ ∇ ◀ ▶ to return to the original screen.

## Checking the SIRIUS Signal Strength and Radio ID

- 1 Press **<STATUS>** until “SIGNAL” appears on the display.

The display will switch as shown below, depending on the reception conditions.

Display	Status
EXCELLENT	Signal strength is excellent
GOOD	Signal strength is good
WEAK	Signal strength is weak
NO SIGNAL	No signal

- 2 Adjust the position of the antenna until “SIGNAL: EXCELLENT” is shown on the display.

- 3 Press **<STATUS>** until the channel (example: “SR001”) is displayed.

- 4 Press **[TUNING]** and select channel 0 (SR000).  
Channel No. and Sirius ID are alternately shown on the display.

```
SR000 SiriusID
*****
```

← Sirius ID

※ Write your own SIRIUS ID for storage use.  
Sirius ID : \_\_\_\_\_



The strength of both the SIRIUS satellite and terrestrial signals can be checked “Antenna Aiming” (☞ page 51).

## Presetting Radio Channels (Preset Memory)

Your favorite broadcast channels can be preset so that you can tune them in easily. Up to 56 channels can be preset.

**1** Tune in the broadcast channel you want to preset.

**2** Press [MEMORY].

**3** Press [SHIFT] to select the block in which the channel is to be preset, then press [CHANNEL] to select the preset number.

**4** Press [MEMORY] again to complete the setting.



To preset other channels, repeat steps 1 to 4.

### NOTE

Preset channels are erased by overwriting them.

## Listening to Preset Channels

Press [CHANNEL] to select the desired preset channel, then press ENTER.



You can also operate via the main unit. In this case, perform the following operations.

Press <TUNING PRESET>, then turn <SOURCE SELECT> to select the preset radio channel.

## Searching Categories

**1** Press < >.



**2** Use < > to select the category, to use Δ ∇ to select the desired channel.



- “UPDATING” is displayed while the encoding code is being updated.
- “SIRIUS UPDATING” is displayed when updating SIRIUS tuner firmware.
- Refer to “Troubleshooting” – “SIRIUS Satellite Radio” (page 103) regarding other messages.

## Parental Lock

**1** Tune to the channel you want to lock.

**2** Press ENTER for at least 3 seconds.  
“Enter Lock Code” is displayed.

**3** Enter the 4-digit lock code using Δ ∇ < >.  
When you enter the correct code, the corresponding channel is locked.

**4** Press ENTER.



- Channels under Parental Lock cannot be tuned in by performing Tuning Up/Down or by category search.
- Channels stored in preset memory can be tuned in by the preset channel select operation, even if Parental Lock is applied.
- When a channel to which Parental Lock is applied is being played, Parental Lock for that channel is cancelled by performing step 2.
- See “Edit Lock Cord” (page 51) for the method of changing Parental Lock Cord.
- You can also set “Parental Lock” (page 51) from the menu.

## Tuning in Radio Stations – HD Radio

**Symbols used to indicate buttons in this manual**

- Button located on both the main unit and the remote control unit → **BUTTON**
- Button only on the main unit → **<BUTTON>**
- Button only on the remote control unit → **[BUTTON]**

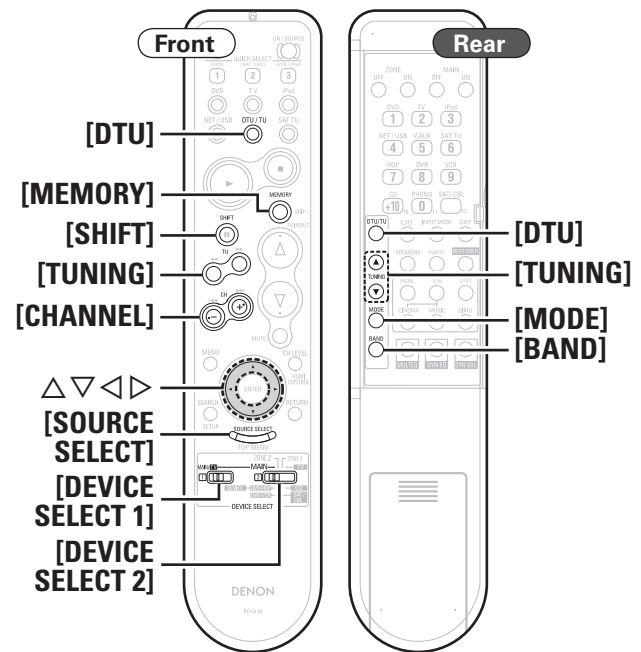
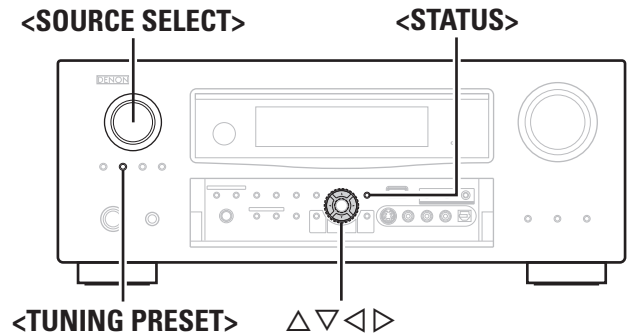

## Listening to HD Radio Stations

- 1 Set **[DEVICE SELECT 1]** to “MAIN/TV” and **[DEVICE SELECT 2]** to “MAIN”.
- 2 Press **[SOURCE SELECT]** to display the GUI Source Select menu, then select “HD Radio” (☞ page 27).
- 3 Press **[BAND]** to select “FM” or “AM”.
- 4 Tune in the desired broadcast station.
  - ① **To tune in automatically (Auto Tuning)**  
Press **[MODE]** to select “HD-AUTO” or “AUTO”, then use **[TUNING]** to select the station you want to hear.
    - The “HD” indicator lights on the display when an HD Radio station is tuned in.
    - When “HD-AUTO” (tuning mode) is selected, only HD Radio stations are tuned in.
    - If “AUTO” (tuning mode) is selected, both HD Radio and analog stations are tuned in.
  - ② **To tune in manually (Manual Tuning)**  
Press **[MODE]** to select “MANUAL”, then use **[TUNING]**.

- 5 Adjust the items below.
  - Adjusting the master volume** (☞ page 67)
  - Selecting the surround mode** (☞ page 69)
  - Adjusting the Sound and Picture Quality** (☞ page 71)

- If the desired station cannot be tuned in with auto tuning, tune it in manually.
- When tuning in stations manually, press and hold **[TUNING]** to change frequencies continuously.
- The time (default : 30 sec) for which the GUI menu is displayed can be set “GUI” – “Tuner” (☞ page 42). Press  $\Delta \nabla \triangleleft \triangleright$  to return to the original screen.

## Selecting Audio Programs

HD Radio includes up to 9 audio programs (HD1 to HD8 and Analog). The different audio programs also have data programs.

**Press  $\Delta \nabla$  to select the audio program.**  
If the station you are listening to has multiple audio programs, “HD1” is indicated on the display. If it only has one audio program, “HD” is indicated.

## Presetting Radio Stations (Preset Memory)

Your favorite broadcast stations can be preset so that you can tune them in easily. Up to 56 stations can be preset.

- 1 Tune in the broadcast station you want to preset.
- 2 Press **[MEMORY]**.
- 3 Press **[SHIFT]** to select the block in which the channel is to be preset, then press **[CHANNEL]** to select the preset number.
- 4 Press **[MEMORY]** again to complete the setting.

- To preset other stations, repeat steps 1 to 4.
- Multicasts can also be preset.
- Stations can be preset automatically at “Auto Preset” (☞ page 50).

**NOTE**  
Preset stations are erased by overwriting them.

## Listening to Preset Stations

**1** Press **[SHIFT]** to select the memory block (A to G).

**2** Press **[CHANNEL]** to select the desired preset station.



- You can also operate via the main unit. In this case, perform the following operations.  
Press **<TUNING PRESET>**, then turn **<SOURCE SELECT>** to select the preset radio station.
- If an audio program from HD2 to HD8 has been interrupted or if a program is called out using the preset buttons after it has been interrupted, HD1 is automatically selected after about 20 seconds.

### □ Default settings

Tuner presets	
A1 ~ A8	87.5 / 87.9 / 89.1 / 93.3 / 97.9 / 98.1 / 98.9 / 100.1 MHz
B1 ~ B8	101.9 / 102.7 / 107.9 / 90.1 / 90.1 / 90.1 / 90.1 / 90.1 MHz
C1 ~ C8	530 / 600 / 930 / 1000 / 1120 / 1210 / 1400 / 1710 kHz
D1 ~ D8	90.1 MHz
E1 ~ E8	90.1 MHz
F1 ~ F8	90.1 MHz
G1 ~ G8	90.1 MHz

## Check the HD Radio Reception Information

Press **<STATUS>** while an HD Radio broadcast is being received.

The current reception information is shown on the display.

- ① Normal  
↓
- ② Frequency / Signal strength  
↓
- ③ Long station name / Program and Program type  
↓
- ④ Title name / Artist name  
↓
- ⑤ Album name / Genre name

### NOTE

If the station signal weakens while receiving a digital broadcast (while "HD" and text is displayed), the mode automatically switches to the analog reception mode (the reception frequency is displayed). Because of this, the "HD" indicator and text may flicker if the station signal level is weak and unstable.

## Playing Network Audio, USB Memory Devices

This procedure can be used to play Internet radio stations or music or still picture (JPEG) files stored on a computer or USB memory device.

### Important Information

#### About the Internet Radio Function

- Internet radio refers to radio broadcasts distributed over the Internet. Internet radio stations from around the world can be tuned in. The AVR-3310CI is equipped with the following Internet radio functions:
  - Stations can be selected by genre and region.
  - Up to 56 Internet radio stations can be preset.
  - Internet radio stations in MP3 and WMA (Windows Media Audio) format can be listened to.
  - Your favorite radio stations can be registered by accessing an exclusive DENON Internet radio URL from a Web browser on a computer.
    - ※ The function is managed for individual users, so you must provide your MAC or e-mail address.  
Exclusive URL: <http://www.radiodenon.com>
    - ※ The radio station database service may be suspended without notice.
- The AVR-3310CI's Internet radio station list is created using a radio station database service (vTuner). This database service provides a list edited and created for the AVR-3310CI.

**Playing Network Audio, USB Memory Devices**

**Media Player**

This function lets you play music files and playlists (m3u, wpl) stored on a computer (media server) connected to the AVR-3310CI via a network.

With the AVR-3310CI's network audio playback function, connection to the server is possible using one of the technologies below.

- Windows Media Player Network Sharing Service
- Windows Media DRM10

**Album Art Function**

When a WMA (Windows Media Audio), MP3 or MPEG-4 AAC file includes album art data, the album art can be displayed while the music files are playing.



For music files in WMA (Windows Media Audio) format, the album art is only played when using Windows Media Player ver. 11.

**Slide Show Function**

Still picture (JPEG) files stored in folders on a media server can be played as slide shows. The time for which each picture is displayed can be set.



When still picture (JPEG) files are played on the AVR-3310CI, they are played in the direction in which they are stored in the folder, so store in them in the direction in which you want them to play.

**USB Memory Devices**

A USB memory device can be connected to the AVR-3310CI's USB port to play music and still picture (JPEG) files stored on the USB memory device.

- Only USB memory devices conforming to mass storage class and MTP (Media Transfer Protocol) standards can be played on the AVR-3310CI.
- The AVR-3310CI is compatible with USB memory devices in "FAT16" or "FAT32" format.

**Album Art Function**

When an MP3 music file includes album art data, the album art can be displayed while playing the file.

**Slide Show Function**

Still picture (JPEG) files stored on USB memory devices can be played as slide shows.

The time for which each picture is displayed can be set.



When still picture (JPEG) files are played on the AVR-3310CI, they are played in the direction in which they are stored in the folder, so store in them in the direction in which you want them to play.

**[Compatible formats]**

	Internet radio	Media server* 1	USB memory devices* 1
<b>WMA</b> (Windows Media Audio)	○	○	○* 3
<b>MP3</b> (MPEG-1 Audio Layer-3)	○	○	○
<b>WAV</b>	-	○	○
<b>MPEG-4 AAC</b>	-	○* 2	○* 2
<b>FLAC</b> (Free Lossless Audio Codec)	-	○	○
<b>JPEG</b>	-	○	○

A server or server software compatible with distribution in the corresponding formats is required to play music files via a network.

\* 1 : Media server and USB

- The AVR-3310CI is compatible with MP3 ID3-Tag (Ver. 2) standards.
- The AVR-3310CI is compatible with WMA META tags.
- WAV format Quantization bit rate: 16 bits.

\* 2 : Only files that are not protected by copyright can be played on the AVR-3310CI.

Contents downloaded from pay sites on the Internet are copyright protected. Also, files encoded in WMA format when ripped from a CD, etc., on a computer may be copyright protected, depending on the computer's settings.

\* 3 : Copyright-protected files can be played on certain portable players compatible with MTP.

**[Compatible formats]**

	Sampling frequency	Bit rate	Extension
<b>WMA</b> (Windows Media Audio)	32/44.1/48kHz	48 ~ 192kbps	.wma
<b>MP3</b> (MPEG-1 Audio Layer-3)	32/44.1/48kHz	32 ~ 320kbps	.mp3
<b>WAV</b>	32/44.1/48kHz	-	.wav
<b>MPEG-4 AAC</b>	32/44.1/48kHz	16 ~ 320kbps	.aac/ .m4a/ .mp4
<b>FLAC</b> (Free Lossless Audio Codec)	32/44.1/48kHz	-	.flac

**About Napster**

Napster is a monthly subscription music distribution service provided by Napster. This service allows users to download and play pieces of music they want to hear on the AVR-3310CI. Before you can use Napster, you will need to visit the Napster website on your PC to create an account and register as a member. For details, access the following site:

[http://www.napster.com/choose/index\\_default.html](http://www.napster.com/choose/index_default.html)

**About Rhapsody**

Rhapsody is a paid music broadcast service of RealNetworks. When you first listen to Rhapsody, it is necessary to subscribe to a Rhapsody account at the Rhapsody homepage by your PC and register this machine. See the Rhapsody homepage for details.

[www.rhapsody.com/denon](http://www.rhapsody.com/denon)

**Symbols used to indicate buttons in this manual**

- Button located on both the main unit and the remote control unit → **BUTTON**
- Button only on the main unit → **<BUTTON>**
- Button only on the remote control unit → **[BUTTON]**

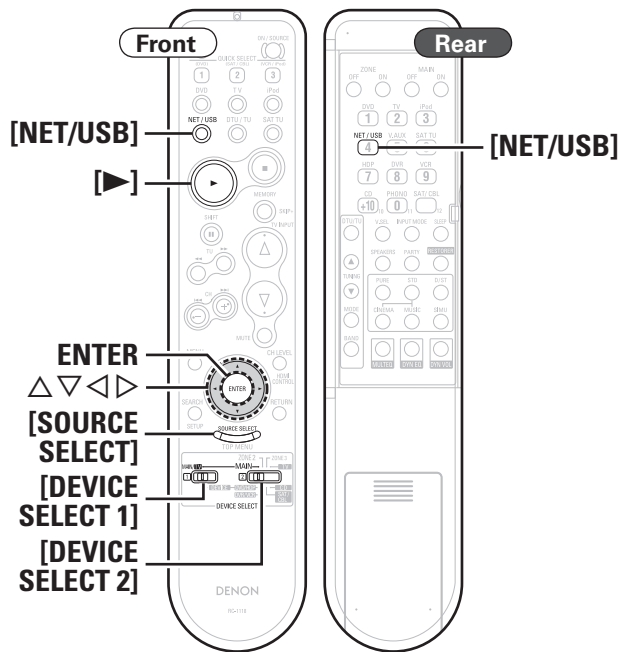
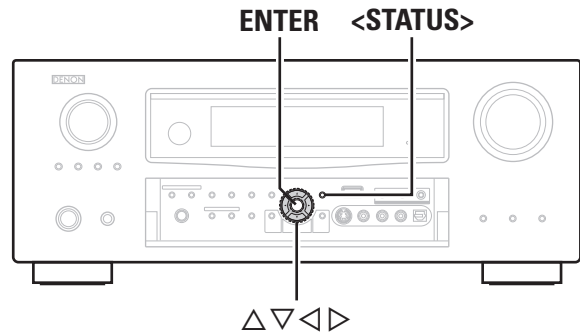

## Listening to Internet Radio

- Playback preparation.**
  - Check the network environment, then turn on the AVR-3310CI's power (☞ page 23 "Connecting to a Home Network (LAN)").
  - If settings are required, make the "Network Connecting" (☞ page 38).
  - Set **[DEVICE SELECT 1]** to "MAIN/TV" **[DEVICE SELECT 2]** to "MAIN".
- Press [SOURCE SELECT] to display the GUI Source Select menu, then select "🌐" (☞ page 27).**
- Press  $\Delta$ / $\nabla$  to select the item you want to play, then press ENTER or  $\triangleright$ .**  
The station list is displayed.
- Press  $\Delta$ / $\nabla$  to select the station, then press ENTER,  $\triangleright$  or  $\blacktriangleright$ .**  
Playback starts once buffering reaches "100%".
- Adjust the items below.**
  - Adjusting the master volume** (☞ page 67)
  - Selecting the surround mode** (☞ page 69)
  - Adjusting the Sound and Picture Quality** (☞ page 71)

- To stop** (☞ page 67)
- Searching pages** (☞ page 68)
- Searching by first letter** (☞ page 68)

- There are many Internet radio stations on the Internet, and the quality of the programs they broadcast as well as the bit rate of the tracks varies widely. Generally, the higher the bit rate, the higher the sound quality, but depending on the communication lines and server traffic, the music or audio signals being streamed may be interrupted. Inversely, lower bit rates mean a lower sound quality but less tendency for the sound to be interrupted.
- "Server Full" or "Connection Down" is displayed if the station is busy or not broadcasting.
- On the AVR-3310CI, folder and file names can be displayed as titles. Any characters that cannot be displayed are replaced with ". (period)".
- Use the RESTORER mode to expand the low and high frequency components of compressed audio files and achieve a richer sound "RESTORER" (☞ page 74). The default setting is "Mode 3".
- When **<STATUS>** is pressed, the display can be switched between the title name and radio station name.
- The time (default : 30 sec) for which the GUI menu are displayed can be set at GUI menu "GUI" – "NET/USB" (☞ page 42). Press  $\Delta$ / $\nabla$ / $\triangleleft$ / $\triangleright$  to return to the original screen.

## Recently Played Internet Radio Stations

Recently played internet radio stations can be selected from "Recently Played".  
Up to 20 stations stored in "Recently Played".

- Press  $\Delta$ / $\nabla$  to select "Recently Played", then press ENTER or  $\triangleright$ .**
- Press  $\Delta$ / $\nabla$  to select the item you want to play, then press ENTER,  $\triangleright$  or  $\blacktriangleright$ .**

Getting Started  
Connections  
Settings  
Playback  
Multi-zone  
Remote Control  
Information  
Troubleshooting  
Specifications

## Playing Network Audio, USB Memory Devices

**Symbols used to indicate buttons in this manual**

- Button located on both the main unit and the remote control unit → **BUTTON**
- Button only on the main unit → **<BUTTON>**
- Button only on the remote control unit → **[BUTTON]**

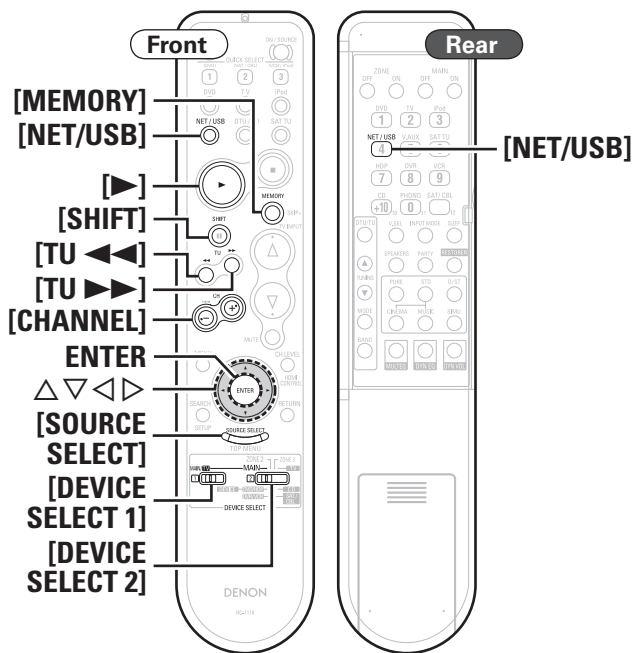
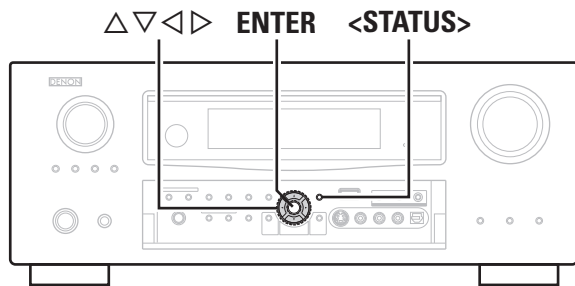

## Search Stations by Keyword (Alphabetic Strings)

- 1 Press  $\Delta$   $\nabla$  to select “Search by Keyword”, then press **ENTER** or  $\triangleright$ .  
The search display appear.

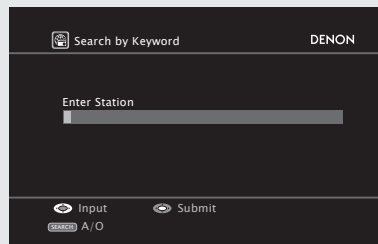

- 2 Enter the characters, then press **ENTER**.

## Presetting Internet Radio Stations

Preset Internet radio stations can be selected directly.

- 1 While the Internet radio station you want to preset is playing, press **[MEMORY]**.
- 2 Press  $\Delta$   $\nabla$  to select “Preset”, then press **ENTER**.
- 3 Press **[SHIFT]**, then press **[CHANNEL]** to select the desired preset number.
- 4 Press **[MEMORY]** again to complete the setting.  
The Internet radio station is now preset.

### NOTE

If registered at a number that has already been preset, the previously registered setting is cleared.

## Listening to Preset Internet Radio Stations

After pressing **[SHIFT]**, press **[CHANNEL]** to select the registered preset number.

The AVR-3310CI automatically connects to the Internet and playback begins.

## Registering Internet Radio Stations as Your Favorites

Favorites are listed at the top of the menu screen, so when a station is registered as a favorite it can be tuned in easily.

- 1 Press **[MEMORY]** while the Internet radio station you want to register is playing.
- 2 Press  $\Delta$   $\nabla$  to select “Favorites”, then press **ENTER**.
- 3 Press  $\triangleleft$  to select “Add”.  
The Internet radio station is registered.  
\* If you do not want to register it, press  $\triangleright$ .

## Listening to Internet Radio Stations Registered in Your Favorites

- 1 Press **[SOURCE SELECT]** to display the GUI Source Select menu, then select “” (page 27).
- 2 Press  $\Delta$   $\nabla$  to select the Internet radio station, then press **ENTER**,  $\triangleright$  or  $\triangleright$ .  
The AVR-3310CI automatically connects to the Internet and playback begins.

## Clearing Internet Radio Stations from Your Favorites

- 1 Press **[SOURCE SELECT]** to display the GUI Source Select menu, then select “” (page 27).
- 2 Press  $\Delta$   $\nabla$  to select the Internet radio station you want to clear, then press **[MEMORY]**.
- 3 Press  $\triangleleft$  to select “Remove”.  
The selected Internet radio station is cleared.  
\* To cancel the operation without clearing the station, press  $\triangleright$ .



## Playing Files Stored on a Computer

Use this procedure to play music files, image files or playlists.

### 1 Playback preparation.

- ① Check the network environment, then turn on the AVR-3310CI's power (☞ page 23 "Connecting to a Home Network (LAN)").
- ② If settings are required, make the "Network Connecting" (☞ page 38).
- ③ Prepare the computer (☞ Computer's operating instructions).
- ④ Set [DEVICE SELECT 1] to "MAIN/TV" [DEVICE SELECT 2] to "MAIN".

### 2 Press [SOURCE SELECT] to display the GUI Source Select menu, then select "USB" (☞ page 27).

### 3 Use $\Delta$ / $\nabla$ to select the server including the file to be played, then press ENTER or $\triangleright$ .

### 4 Press $\Delta$ / $\nabla$ to select the search item or folder, then press ENTER or $\triangleright$ .

### 5 Press $\Delta$ / $\nabla$ to select the file, then press ENTER, $\triangleright$ or $\blacktriangleright$ . Playback starts once buffering reaches "100%".

### 6 Adjust the items below.

- Adjusting the master volume (☞ page 67)
- Selecting the surround mode (☞ page 69)
- Adjusting the Sound and Picture Quality (☞ page 71)

To stop (☞ page 67)

Stopping playback temporarily (☞ page 67)

Selecting tracks (☞ page 68)

Playing repeatedly (☞ page 68)

Playing in random order (☞ page 68)

Searching pages (☞ page 68)

Searching by first letter (☞ page 68)



- When playing still picture (JPEG) files, files can also be selected using the operation described below.  
During playback, either press [TU  $\blacktriangleleft$ ] (previous file) or [TU  $\blacktriangleright$ ] (next file).
- Connections to the required system and specific settings must be made in order to play music files (☞ page 23).
- Before starting, you must launch the computer's server software and set the files as server contents. For details, see the operating instructions of your server software.
- Depending on the size of the still picture (JPEG) file, some time may be required for the file to be displayed.
- The order in which the tracks/files are displayed depends on the server specifications. If due to the server specifications the tracks/files are not displayed in alphabetical order, searching by the first letter may not work properly.
- WMA Lossless files can be played when using a server supporting transcoding, such as Windows Media Player Ver. 11.
- Use the RESTORER mode to expand the low and high frequency components of compressed audio files and achieve a richer sound (☞ page 74). The default setting is "Mode 3".
- The time (default : 30 sec) for which the GUI menus are displayed can be set at "GUI" - "NET/USB" (☞ page 42).
- Use <STATUS> to switch between displaying the title name, artist name or album name.

### Playing files that have been Preset or Registered in Your Favorites

Files can be preset, registered in your favorites and played using the same operations as for Internet radio stations (☞ page 61).

#### NOTE

- Presettings are erased by overwriting them.
- When the operation described below is performed, the media server's database is updated and it may no longer be possible to play preset or favorite music files.
  - When you quit the media server and then restart it.
  - When music files are deleted or added on the media server.
- When using an ESCIENT server, place "ESCIENT" before the server name.

## Playing Files Stored on USB Memory Devices

Only USB memory devices conforming to mass storage class and MTP (Media Transfer Protocol) standards can be played on the AVR-3310CI.

### 1 Playback preparation.

- ① Connect the USB memory device to the USB port.
- ② Set [DEVICE SELECT 1] to "MAIN/TV" [DEVICE SELECT 2] to "MAIN".

### 2 Press [SOURCE SELECT] to display the GUI Source Select menu, then select "USB" (☞ page 27).

### 3 Press $\Delta$ / $\nabla$ to select the search item or folder, then press ENTER or $\triangleright$ .

### 4 Press $\Delta$ / $\nabla$ to select the file, then press ENTER, $\triangleright$ or $\blacktriangleright$ . Playback starts once buffering reaches "100%".

### 5 Adjust the items below.

- Adjusting the master volume (☞ page 67)
- Selecting the surround mode (☞ page 69)
- Adjusting the Sound and Picture Quality (☞ page 71)

To stop (☞ page 67)

Stopping playback temporarily (☞ page 67)

Selecting tracks (☞ page 68)

Playing repeatedly (☞ page 68)

Playing in random order (☞ page 68)

Searching pages (☞ page 68)

Searching by first letter (☞ page 68)

Playing Network Audio, USB Memory Devices, Listening to Napster

**Symbols used to indicate buttons in this manual**

- Button located on both the main unit and the remote control unit → **BUTTON**
- Button only on the main unit → **<BUTTON>**
- Button only on the remote control unit → **[BUTTON]**

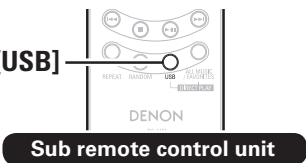
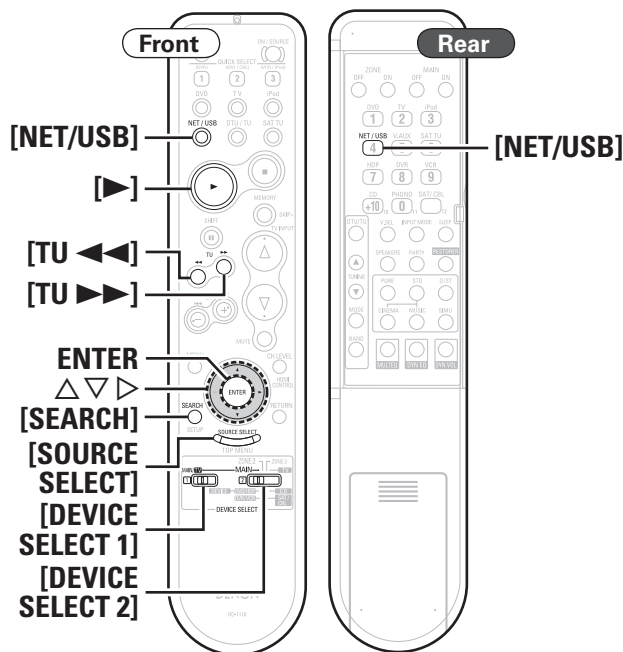
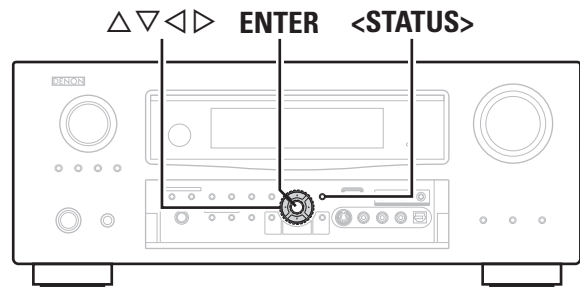

- By default, the front panel's USB port will be used.
- Depending on the size of the still picture (JPEG) file, some time may be required for the file to be displayed.
- During playback of still picture (JPEG) files, the files can also be switched using [TU <<] (previous file) and [TU >>] (next file).
- If the USB memory device is divided into multiple partitions, only the top partition can be selected.
- The AVR-3310CI is compatible with MP3 files conforming to "MPEG-1 Audio Layer-3" standards.
- When [USB] on the sub remote control unit is pressed, playback starts from the first file stored on the USB memory device.

- NOTE**
- DENON will accept no responsibility whatsoever for any loss or damage to data on USB memory devices when using the USB memory device connected to the AVR-3310CI.
  - USB memory devices will not work via a USB hub.
  - DENON does not guarantee that all USB memory devices will operate or receive power. When using a portable USB connection type HDD of the kind to which an AC adapter can be connected to supply power, use the AC adapter.
  - It is not possible to connect and use a computer via the AVR-3310CI's USB port using a USB cable.
  - The AVR-3310CI is not compatible with the iPod shuffle.

**Listening to Napster**

- 1 Playback preparation.**
- ① Check the network environment, then turn on the AVR-3310CI's power (page 23 "Connecting to a Home Network (LAN)").
  - ② If settings are required, make the "Network Connecting" (page 38).
  - ③ Set [DEVICE SELECT 1] to "MAIN/TV" [DEVICE SELECT 2] to "MAIN".

- 2 Press [SOURCE SELECT] to display the GUI Source Select menu, then select "Ⓜ" (page 27).**

- 3 Use Δ ∇ ▷ to input "Username" and "Password".**

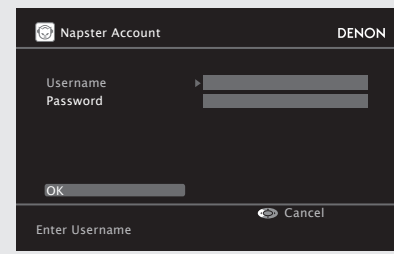

- 4 After inputting the "Username" and "Password", select "OK", then press ENTER.**  
If the "Username" and "Password" match, the top menu for Napster is displayed.

Username : \_\_\_\_\_

**[Input characters]**

**[Lower case characters]** abcdefghijklmnopqrstuvwxyz  
**[Upper case characters]** ABCDEFGHIJKLMNOPQRSTUVWXYZ  
**[Symbols]** ! " # \$ % & ' ( ) \* + , - . / : ; < = > ? @ [ \ ] ^ \_ { | } ~  
 (Space)

**[Numbers]** 0123456789

Password : \_\_\_\_\_

**[Input characters]**

**[Lower case characters]** abcdefghijklmnopqrstuvwxyz  
**[Upper case characters]** ABCDEFGHIJKLMNOPQRSTUVWXYZ  
**[Symbols]** ! " # \$ % & ' ( ) \* + , - . / : ; < = > ? @ [ \ ] ^ \_ { | } ~  
 (Space)

**[Numbers]** 0123456789

- 5 Adjust the items below.**
- Adjusting the master volume (page 67)
  - Selecting the surround mode (page 69)
  - Adjusting the Sound and Picture Quality (page 71)

**Search From Napster Menu**

- 1** Use Δ ∇ to select search item or folder, then press ENTER or ▷.
- 2** Use Δ ∇ to select the track item, then press ENTER or ▷.

## Enter a Character Search For the Track You Want to Listen to

### 1 Press [SEARCH].

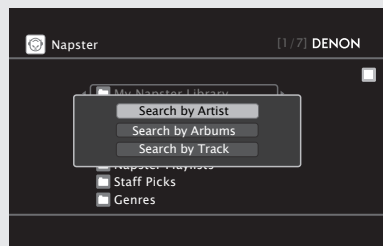

※ You can search by artist name, album name or track name.

### 2 Use $\Delta$ / $\nabla$ to select the search item, then press ENTER.

The search display appears.

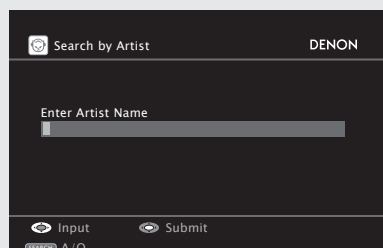

### 3 Enter the characters, then press ENTER.

## Registering Tracks in My Napster Library

**1** Press  $\triangleright$  while the track you wish to register is playing.

**2** Select “Add to my library”, then press ENTER or  $\triangleright$ .  
The track is entered in the Library.

### ☐ Listening to Tracks Registered In My Napster Library

**1** Use  $\Delta$ / $\nabla$  to select “My Library”, then press ENTER or  $\triangleright$ .

**2** Use  $\Delta$ / $\nabla$  to select the information or track, then press ENTER,  $\triangleright$  or  $\blacktriangleright$ .  
After selecting, the information is displayed.

☐ To stop (🔗 page 67)

☐ Selecting tracks (🔗 page 68)

☐ Playing repeatedly (🔗 page 68)

☐ Playing in random order (🔗 page 68)

☐ Searching pages (🔗 page 68)



- Use the RESTORER mode to expand the low and high frequency components of compressed audio files and achieve a richer sound (🔗 page 74). The default setting is “Mode 3”.
- The time (default : 30 sec) for which the GUI menus are displayed can be set at “GUI” – “NET/USB” (🔗 page 42).
- Use <STATUS> to switch between displaying the title name, artist name or album name.

## Listening to Rhapsody

**Symbols used to indicate buttons in this manual**

Button located on both the main unit and the remote control unit → **BUTTON**  
 Button only on the main unit → **<BUTTON>**  
 Button only on the remote control unit → **[BUTTON]**

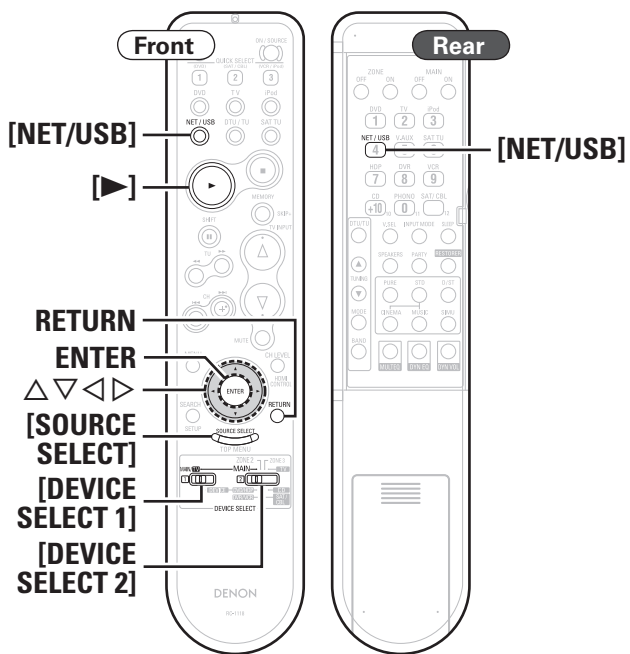
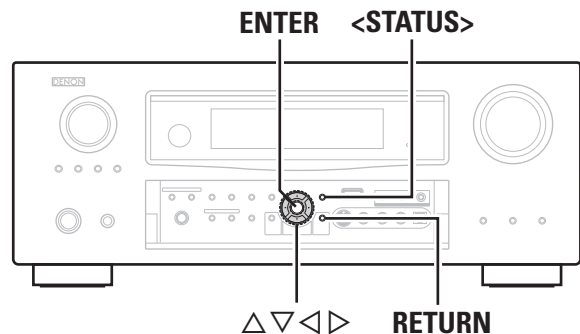

## Listening to Rhapsody

### 1 Playback preparation.

- ① Check the network environment, then turn on the AVR-3310CI's power (☞ page 23 "Connecting to a Home Network (LAN)").
- ② If settings are required, make the "Network Connecting" (☞ page 38).
- ③ Set **[DEVICE SELECT 1]** to "MAIN/TV" **[DEVICE SELECT 2]** to "MAIN".

### 2 Press **[SOURCE SELECT]** to display the GUI Source Select menu, then select "Rhapsody" (☞ page 27).

### 3 Use $\Delta$ $\nabla$ to select "Sign in your account", then press **ENTER** or $\triangleright$ .

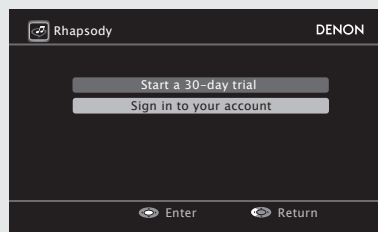

### 4 Enter Username and Password.

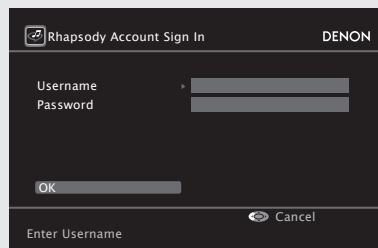

### 5 After inputting the "Username" and "Password", select "OK", then press **ENTER**.

If the "Username" and "Password" match, the top menu for Rhapsody is displayed.

**Username :** \_\_\_\_\_

**[Input characters]**

**[Lower case characters]** abcdefghijklmnopqrstuvwxyz  
**[Upper case characters]** ABCDEFGHIJKLMNOPQRSTUVWXYZ  
**[Symbols]** ! " # \$ % & ' ( ) \* + , - . / : ; < = > ? @ [ \ ] ^ \_ ` { | } ~  
 (Space)  
**[Numbers]** 0123456789

**Password :** \_\_\_\_\_

**[Input characters]**

**[Lower case characters]** abcdefghijklmnopqrstuvwxyz  
**[Upper case characters]** ABCDEFGHIJKLMNOPQRSTUVWXYZ  
**[Symbols]** ! " # \$ % & ' ( ) \* + , - . / : ; < = > ? @ [ \ ] ^ \_ ` { | } ~  
 (Space)  
**[Numbers]** 0123456789

### 6 Adjust the items below.

- Adjusting the master volume** (☞ page 67)
- Selecting the surround mode** (☞ page 69)
- Adjusting the Sound and Picture Quality** (☞ page 71)

### NOTE

- The password should be no longer than 99 characters.
- The password may not contain underscores ( \_ ).
- Press **RETURN** to cancel the input. When "Cancel input?" is displayed, select "Yes", then press **ENTER**.

## Select the Search Mode

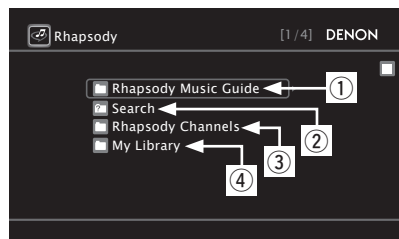

### ① Search From Rhapsody Latest Information

- 1** Use  $\Delta$ / $\nabla$  to select “Rhapsody Music Guide”, then press **ENTER** or  $\triangleright$ .
- 2** Use  $\Delta$ / $\nabla$  to select the information for track selection, then press **ENTER** or  $\triangleright$ .  
After selecting, the information is displayed.
- 3** Use  $\Delta$ / $\nabla$  to select the track, then press **ENTER**,  $\triangleright$  or  $[\triangleright]$ .

### ② Enter a Character Search For the Track You Want to Listen to

- 1** Use  $\Delta$ / $\nabla$  to select “Search”, then press **ENTER** or  $\triangleright$ .
- 2** Use  $\Delta$ / $\nabla$  to select the search item, then press **ENTER** or  $\triangleright$ .  
The search display appears.  
※ You can search by artist name, album name, track name or keyword.
- 3** Enter the characters, then press **ENTER**.

### ③ Search From the Rhapsody Internet Radio Station

- 1** Use  $\Delta$ / $\nabla$  to select “Rhapsody Channels”, then press **ENTER** or  $\triangleright$ .
- 2** Use  $\Delta$ / $\nabla$  to select radio station, then press **ENTER**,  $\triangleright$  or  $[\triangleright]$ .

### ④ Listening to Tracks Registered In My Library

- 1** Use  $\Delta$ / $\nabla$  to select “My Library”, then press **ENTER** or  $\triangleright$ .
- 2** Use  $\Delta$ / $\nabla$  to select the information or track, then press **ENTER**,  $\triangleright$  or  $[\triangleright]$ .  
After selecting, the information is displayed

## Track Menu

Press  $\triangleright$  during playback to display the Track Menu.

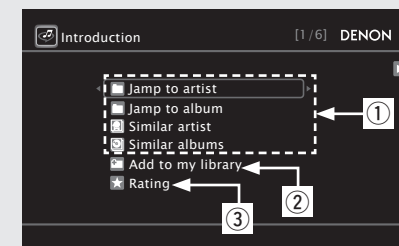

### ① Search From the Similar Music

Use  $\Delta$ / $\nabla$  to select the search item, then press **ENTER** or  $\triangleright$ .

### ② Registering Tracks in My Library

Use  $\Delta$ / $\nabla$  to select “Add to My Library”, then press **ENTER** or  $\triangleright$ .  
The track is entered in the Library.

### ③ Rating Function

- 1** Use  $\Delta$ / $\nabla$  to select “Rating”, then press **ENTER** or  $\triangleright$ .
- 2** Use  $\triangleleft$ / $\triangleright$  to select the rating, then press **ENTER**.



- Use the RESTORER mode to expand the low and high frequency components of compressed audio files and achieve a richer sound (page 74). The default setting is “Mode 3”.
- The time (default : 30 sec) for which the GUI menus are displayed can be set at “GUI” – “NET/USB” (page 42).
- Use **<STATUS>** to switch between displaying the title name, artist name or album name.

Symbols used to indicate buttons in this manual

Button located on both the main unit and the remote control unit → **BUTTON**  
 Button only on the main unit → **<BUTTON>**  
 Button only on the remote control unit → **[BUTTON]**

**<FRONT SPEAKERS> ENTER MASTER VOLUME**

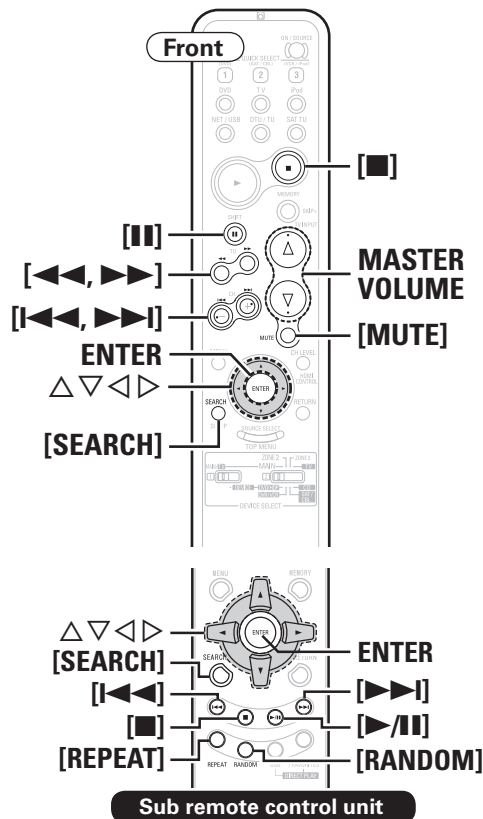
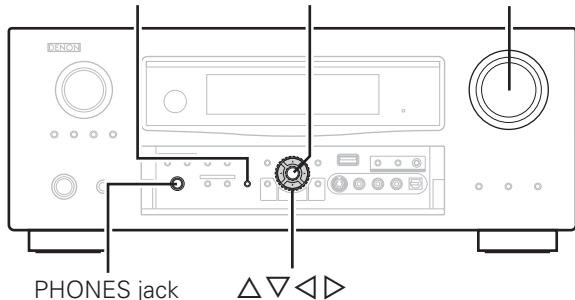

## Operations During Playback

### Adjusting the Master Volume

Use **MASTER VOLUME** to adjust the volume.

- When the "Volume Display" setting ( page 41) is "Relative"  
 [Adjustable range] --- -80.5dB ~ 18.0dB
- When the "Volume Display" setting ( page 41) is "Absolute"  
 [Adjustable range] 0.0 ~ 99.0

※ The adjustable range depends on the input signal, the channel level settings, etc.

### Turning Off the Sound Temporarily (Muting)

Press **[MUTE]**.



- The sound is reduced to the level set at "Mute Level" ( page 41).
- To cancel, press **[MUTE]** again. Muting can also be canceled by adjusting the master volume.

### Listening with Headphones

Plug the headphones into the **PHONES jack** on the main unit.

The sound from the speakers and pre-out connectors is automatically cut.

#### NOTE

- To prevent hearing loss, do not raise the volume level excessively when using headphones.
- Remove your headphones when performing Audyssey™ Auto Setup or adjusting the speaker volume.

### Switching the front speakers

Press **<FRONT SPEAKERS>**.

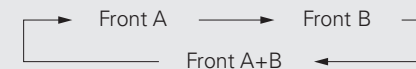

#### NOTE

When you set to "Custom" with "Front Speaker Setup" ( page 36), you cannot operate **<FRONT SPEAKERS>**.

### To Stop

During playback, either press and hold **ENTER** or press **[■]**.

### Stopping Playback Temporarily

During playback, press **ENTER**, **[■]** or **[▶/■]** on the sub remote control unit.

Press again to resume playback.

### Fast-forwarding or Fast-reversing

During playback, press and hold **[◀◀]** (fast-reverse) or **[▶▶]** (fast-forward), or press and hold **Δ ▽**.

## To Cue to the Beginning of a Track

During playback, either press [**⏮**] (to search for previous tracks) or [**⏭**] (to search for subsequent tracks), or press **△ ▽**.

## Playing Repeatedly

Press [**REPEAT**].

**All** : Repeat all songs.

**One** : Repeat the current song.

**OFF** : Disable repeat playback.

※ GUI menu "Repeat" (🔧 page 50) can be set in the same way.



The repeat mode applies when playing tracks on the USB memory device and on the media server.

## Selecting Tracks

During playback, either press **△** (previous track) or **▽** (next track).

## Shuffling Playback

Press [**RANDOM**].

**Albums** : Shuffle songs from current album only.

**Songs** : Shuffle all songs.

**OFF** : Cancel shuffle mode.

※ GUI menu "Shuffle" (🔧 page 50) can be set in the same way.

## Playing in Random Order

Press [**RANDOM**].

**ON** : Enable random playback.

**OFF** : Disable random playback.

※ GUI menu "Random" (🔧 page 50) can be set in the same way.



The random mode applies when playing tracks on the USB memory device and on the media server.

## Searching Pages

Press [**SEARCH**], then press **◀** (previous page) or **▶** (next page).

※ To cancel, press **△ ▽** or [**SEARCH**].

## Searching by First Letter

This operation is convenient for choosing items from the menu screens for Internet radio stations or files stored on the computer.

**When the menu screen is displayed, press [**SEARCH**] twice, then press **◀ ▶** to select the first letter you want to search for.**

- If there are multiple items starting with the selected letter, they are displayed in alphabetical order.
- If it is not possible to search the list, "unsorted list." is displayed.

※ To cancel, press **△ ▽** or [**SEARCH**].



If the list is not in alphabetical order, you may not be able to perform a character search.



# Selecting the Surround Mode (Surround Mode)



**Symbols used to indicate buttons in this manual**

- Button located on both the main unit and the remote control unit → **BUTTON**
- Button only on the main unit → **<BUTTON>**
- Button only on the remote control unit → **[BUTTON]**

## STANDARD DIRECT/STEREO

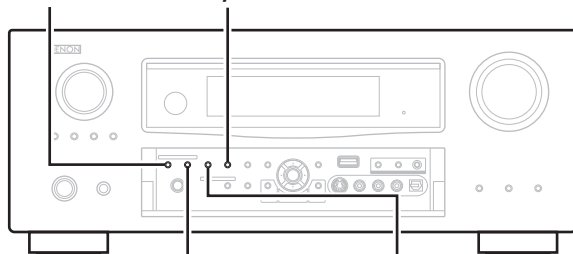

DSP SIMULATION      PURE DIRECT

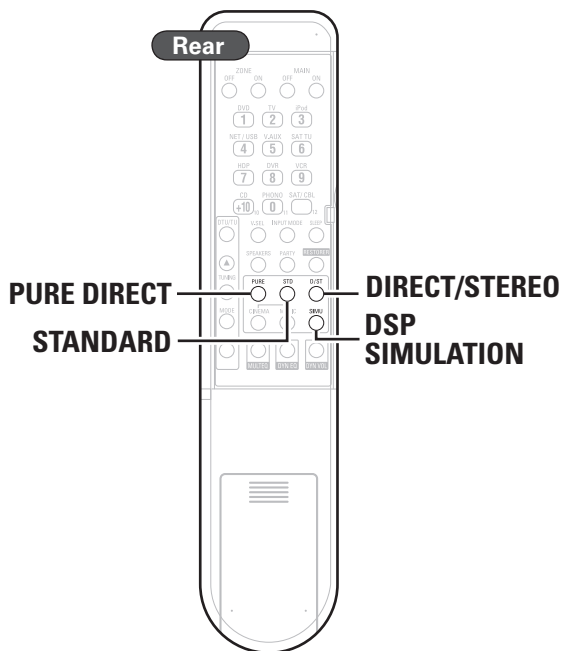

## ① Playing Sources According to the Sources' Audio Signal Format/ Number of Channels (Standard Playback)

### Operations

The selectable surround modes depend on the following:

- Format of the audio signals being input
- Number of channels of the audio signals being input
- The set amplifier assignment (☞ page 34)

### 1 Playing the source (☞ page 52).

### 2 Press **STANDARD** to select the surround mode.

## ❑ Surround Playback of 2-channel Sources

① The mode switches as shown below each time **STANDARD** is pressed.

**DOLBY PLIIz** \*1 : The signals are decoded in DOLBY PLIIz for playback.

**DOLBY PLIIx** \*2 : The signals are decoded in DOLBY PLIIx for playback.

**DOLBY PLII** : The signals are decoded in DOLBY PLII for playback.

**DTS NEO:6** : The signals are decoded in DTS NEO:6 for playback.

\*1 : This can be set when "Amp Assign" is set to "Front Height" and "Speaker Configuration" – "Front Height" is set to something other than "None".

\*2 : This can be set when "Amp Assign" is set to "Normal" and "Speaker Configuration" – "Surround Back" is set to something other than "None".

② Select the mode for the source at "Mode" (☞ page 71).

**Cinema** : This mode is suited for movie sources.

**Music** : This mode is suited for music sources.

**Game** : This mode is suited for games.

**Pro Logic** : This is the Pro Logic playback mode. This can be selected when playing with a DOLBY PLII decoder.

**Height** : This is the Front Height playback mode. Set "Front Height" to "ON" (☞ page 72).

※ The modes that can be selected depend on the input source being played.

## ❑ Surround Playback of Multi-channel Sources (Dolby Digital, DTS, etc.)

In the case of standard playback of multi channel sources, the AVR-3310CI recognizes the format of the multi-channel audio input signal and automatically operates the appropriate decoder for surround sound.

### Displaying the Currently Playing Surround Mode

Input signal	The indication contents of the display
DOLBY DIGITAL (other than 2ch) / DOLBY DIGITAL EX	DOLBY DIGITAL
	DOLBY DIGITAL EX
	DOLBY DIGITAL+PLIIx CINEMA
	DOLBY DIGITAL+PLIIx MUSIC
DOLBY DIGITAL+PLIIz HEIGHT	DOLBY DIGITAL+PLIIz HEIGHT
	DOLBY DIGITAL+
	DOLBY DIGITAL+ +EX
	DOLBY DIGITAL+ + PLIIx CINEMA
DOLBY DIGITAL Plus (*4)	DOLBY DIGITAL+ + PLIIx MUSIC
	DOLBY DIGITAL+ + PLIIz HEIGHT
	DOLBY TrueHD
	DOLBY TrueHD+EX
DOLBY TrueHD (*4)	DOLBY TrueHD+PLIIx CINEMA
	DOLBY TrueHD+PLIIx MUSIC
	DOLBY TrueHD+PLIIz HEIGHT
	DTS SURROUND
DTS (5.1ch) / DTS-ES Discrete 6.1 / DTS-ES Matrix 6.1 / DTS 96/24	DTS+PLIIx CINEMA
	DTS+PLIIx MUSIC
	DTS+PLIIz HEIGHT
	DTS+NEO:6
	DTS ES MTRX6.1 (*1)
	DTS ES DSCR6.1 (*2)
	DTS 96/24 (*3)
DTS-HD (*4)	DTS-HD HI RES
	DTS-HD MSTR
	DTS-HD+NEO:6
	DTS-HD+PLIIx CINEMA
	DTS-HD+PLIIx MUSIC
PCM (multi ch)	DTS-HD+PLIIz HEIGHT
	DTS EXPRESS
	MULTI CH IN
	MULTI IN+PLIIx CINEMA
	MULTI IN+PLIIx MUSIC
	MULTI IN+PLIIz HEIGHT
	MULTI CH IN 7.1

\*1 : This is displayed when the input signal is "DTS-ES Matrix 6.1" and the AVR-3310CI's "AFDM" setting is set to "ON"

\*2 : This is displayed when the input signal is "DTS-ES Discrete 6.1".

\*3 : This is displayed when the input signal is "DTS 96/24".

\*4 : When a signal is input, the HD AUDIO indicator lights.

☞ For details, see page 97, 98.



## ② Playing in a DENON Original Surround Mode

The desired mode according to the program source and viewing situation can be selected from among 7 DENON original surround modes.

### 1 Playing the source (🔧 page 52).

### 2 Select the surround mode by pressing **DSP SIMULATION**.

- 5CH/7CH STEREO** : This mode is for enjoying stereo sound from all speakers.
- ROCK ARENA** : This mode is for enjoying the atmosphere of a live concert in an arena.
- JAZZ CLUB** : This mode is for enjoying the atmosphere of a live concert in a jazz club.
- MONO MOVIE** \* : This mode is for playing monaural movie sources with surround sound.
- VIDEO GAME** : This mode is suited for achieving surround sound with video games.
- MATRIX** : This mode lets you add a sense of expansion to stereo music sources.
- VIRTUAL** : This mode is for enjoying surround effects using only the front speakers or headphones.

\* : When playing sources recorded in monaural in the "MONO MOVIE" mode, the sound will be off balance with a single channel (left or right), so input to both channels.



Depending on the program source being played, it may not be possible to achieve a satisfactory surround effect. In this case, try other modes to achieve a sound field suited to your tastes.

#### NOTE

When the input signal is DOLBY TrueHD, DOLBY DIGITAL Plus, DTS-HD or DTS EXPRESS, you cannot select DENON original surround mode.

## ③ Direct Playback

In this mode the signals bypass the tone control circuitry for high quality sound.  
The sound is output to the same channels as the input signal.

### 1 Playing the source (🔧 page 52).

### 2 Press **DIRECT/STEREO** to select the "DIRECT".

### Displaying the Currently Playing Surround Mode

Input signal	The indication contents of the display
Analog signal / PCM (2ch) / Dolby Digital source / DTS source / Other 2-channel digital signals	DIRECT
PCM (multi ch)	MULTI CH DIRECT
	MULTI CH DIRECT + Dolby EX
	MULTI CH DIRECT + PLIIx CINEMA
	MULTI CH DIRECT + PLIIx MUSIC
	MULTI CH DIRECT + PLIIz HEIGHT
MULTI CH DIRECT 7.1	

For details, see page 98.

## ④ Stereo Playback

This is the mode for playing in stereo. The tone can be adjusted. Sound is output from the front left and right speakers and subwoofer.

### 1 Playing the source (🔧 page 52).

### 2 Press **DIRECT/STEREO** to select the "STEREO".

## ⑤ Playing the Pure Direct Mode

This is the mode that recreates the original sound most faithfully, providing extremely high quality sound.

### 1 Playing the source (🔧 page 52).

### 2 Press **PURE DIRECT**.



- To cancel, press **PURE DIRECT** again.
- During playback in PURE DIRECT mode, the surround parameters are the same as in DIRECT mode.
- Video signals are only output when HDMI signals are played in the PURE DIRECT mode.

#### NOTE

When in the PURE DIRECT mode, the GUI menu display is not displayed and the display on the main unit is turned off.



# Adjusting the Sound and Picture Quality (Audio/Video Adjust)

For details on how to select, set and cancel settings for each menu, see "GUI Menu Operation" (page 26).



## Adjusting the Sound (Audio Adjust)





Default settings are underlined.





The sound being played in the surround mode can be adjusted to your liking. The items (parameters) that can be adjusted depend on the signal being input and the currently set surround mode. For details on the adjustable parameters, see "Surround Modes and Parameters" (page 95).

Setting items	Setting contents
<b>Surround Parameters</b> Adjust surround sound parameters.	<p><b>Mode</b> : Set the play modes for the different surround modes.</p> <p><input type="checkbox"/> <b>In the PLIIx or PLII mode</b></p> <ul style="list-style-type: none"> <li><b>Cinema</b> : Surround sound mode optimized for movie sources.</li> <li><b>Music</b> : Surround sound mode optimized for music sources.</li> <li><b>Game</b> : Surround sound mode optimized for games.</li> <li><b>Pro Logic</b> : Dolby Pro Logic playback mode (PLII mode only).</li> </ul> <p><input type="checkbox"/> <b>In the PLIIz mode</b></p> <p><b>Height</b> : Dolby PLIIz Height playback mode.</p> <p><input type="checkbox"/> <b>In the DTS NEO:6 mode</b></p> <ul style="list-style-type: none"> <li><b>Cinema</b> : Surround sound mode optimized for movie sources.</li> <li><b>Music</b> : Surround sound mode optimized for music sources.</li> </ul> <p> When "Surround Parameters" – "Front Height" (page 72) is set to "ON", the "Height" mode is set automatically.</p> <ul style="list-style-type: none"> <li>The "Music" mode is also effective for movie sources including a lot of stereo music.</li> <li>The "Cinema" and "Music" modes can also be set by pressing <b>[CINEMA]</b> or <b>[MUSIC]</b>.</li> </ul> <p><b>Cinema EQ</b> : Soften the treble range of movie soundtracks for better understanding.</p> <ul style="list-style-type: none"> <li><b>OFF</b> : "Cinema EQ" is not used.</li> <li><b>ON</b> : "Cinema EQ" is used.</li> </ul> <p><b>DRC</b> : Compress dynamic range (difference between loud and soft sounds).w</p> <ul style="list-style-type: none"> <li><b>Auto</b> : Automatic dynamic range compression on/off control according to source. This can be set in the Dolby TrueHD mode.</li> <li><b>Low / Middle / High</b> : These set the compression level.</li> <li><b>OFF</b> : Dynamic range compression always off.</li> </ul> <p><b>D.COMP</b> : Compress dynamic range (difference between loud and soft sounds).</p> <ul style="list-style-type: none"> <li><b>OFF</b> : Turn dynamic range compression off.</li> <li><b>Low / Middle / High</b> : These set the compression level.</li> </ul>

Setting items	Setting contents
<b>Surround Parameters</b> (Continued)	<p><b>LFE</b> : Adjust the low-frequency effects level (LFE).</p> <ul style="list-style-type: none"> <li><b>-10dB ~ 0dB</b></li> </ul> <p> For proper playback of the different sources, we recommend setting to the values below.</p> <ul style="list-style-type: none"> <li>Dolby Digital sources : "0dB"</li> <li>DTS movie sources : "0dB"</li> <li>DTS music sources : "-10dB"</li> </ul> <p><b>Center Image</b> : Assign center channel signal to front left and right channels for wider sound.</p> <ul style="list-style-type: none"> <li><b>0.0 ~ 1.0 (0.3)</b></li> </ul> <p><b>Panorama</b> : Assign front L/R signal also to surround channels, for wider sound.</p> <ul style="list-style-type: none"> <li><b>OFF</b> : Do not set.</li> <li><b>ON</b> : Set.</li> </ul> <p><b>Dimension</b> : Shift sound image center to front or rear, to adjust playback balance.</p> <ul style="list-style-type: none"> <li><b>0 ~ 6 (3)</b></li> </ul> <p><b>Center Width</b> : Assign center channel signal to front left and right channels for wider sound.</p> <ul style="list-style-type: none"> <li><b>0 ~ 7 (3)</b></li> </ul> <p><b>Delay Time</b> : Adjust delay time to control sound stage size.</p> <ul style="list-style-type: none"> <li><b>0ms ~ 300ms (30ms)</b></li> </ul> <p><b>Effect Level</b> : Adjust effect signal level.</p> <ul style="list-style-type: none"> <li><b>1 ~ 15 (10)</b></li> </ul> <p> Set to a lower level if the positioning and sense of phase of the surround signals seems unnatural.</p> <p><b>Room Size</b> : Determine size of acoustic environment.</p> <ul style="list-style-type: none"> <li><b>Small</b> : Simulate acoustics of a small room.</li> <li><b>Medium small</b> : Simulate acoustics of a medium-small room.</li> <li><b>Medium</b> : Simulate acoustics of a medium room.</li> <li><b>Medium large</b> : Simulate acoustics of a medium-large room.</li> <li><b>Large</b> : Simulate acoustics of a large room.</li> </ul> <p><b>NOTE</b></p> <p>"Room Size" does not indicate the size of the room in which sources are played.</p>



Setting items	Setting contents
<b>Surround Parameters</b> (Continued)	<p><b>Front Height</b> : Set the front height channel.</p> <ul style="list-style-type: none"> <li>• <b>ON</b> : Use the front height channel.</li> <li>• <b>OFF</b> : Do not use the front height channel.</li> </ul> <p></p> <ul style="list-style-type: none"> <li>• "Front Height" is not displayed with the settings listed below. <ul style="list-style-type: none"> <li>• When the "Amp Assign" setting (page 34) is set to something other than "Front Height"</li> <li>• When the "Speaker Configuration" – "Front Height" setting (page 34) is set to "None"</li> </ul> </li> <li>• "Front Height" cannot be set if the HD Audio source being played includes a front height channel. In this case, the Front height channel is played back without decoding in PLIIz mode, using the input signal.</li> <li>• This can also be set by pressing <b>[SPEAKERS]</b>.</li> </ul> <p><b>AFDM (Auto flag detect mode)</b> : Detects the source's surround back channel signal and sets the optimum surround mode automatically.</p> <ul style="list-style-type: none"> <li>• <b>OFF</b> : Do not set.</li> <li>• <b>ON</b> : Set.</li> </ul> <p><b>[Example] Playing Dolby Digital software (with EX flag)</b></p> <ul style="list-style-type: none"> <li>• When "AFDM" is set to "ON", the surround mode is automatically set to the DOLBY D + PLIIx C mode.</li> <li>• To play in the DOLBY DIGITAL EX mode, set "AFDM" to "OFF" and "Surround Back" to "MTRX ON".</li> </ul> <p></p> <ul style="list-style-type: none"> <li>• Some Dolby Digital EX sources do not include EX flags. If the playback mode does not switch automatically even when "AFDM" is set to "ON", set "Surround Back" to "MTRX ON" or "PLIIx CINEMA".</li> <li>• If the setting in "Speaker Configuration" – "Surround Back" (page 34) is "None", "Surround Back" is not displayed.</li> </ul> <p><b>Surround Back</b> : Sets the method of generating of the surround back channel.</p> <p><input type="checkbox"/> <b>For 2-channel sources</b></p> <ul style="list-style-type: none"> <li><b>ON</b> : The surround back channel is used.</li> <li><b>OFF</b> : No signal is played from the surround back channels.</li> </ul> <p><input type="checkbox"/> <b>For multi-channel sources</b></p> <p>Set the decoding method for the surround back channel.</p> <p><b>DSCRT ON</b> : Play the surround back signals included in the 7.1-channel source.</p> <p><b>MTRX ON</b> : Generate and play the surround back signals from the surround channel signals.</p> <p><b>ES MTRX</b> *1 : Generate and play the surround back signals from the surround channel signals of the DTS source.</p> <p><b>ES DSCRT</b> *2 : Play the surround back signals included in the 6.1-channel DTS source.</p>

Setting items	Setting contents
<b>Surround Parameters</b> (Continued)	<p><b>PLIIx CINEMA</b> *3 : Generate and play the surround back signals by decoding the signals in the Dolby Pro Logic IIx Cinema mode.</p> <p><b>PLIIx MUSIC</b> : Generate and play the surround back signals by decoding the signals in the Dolby Pro Logic IIx Music mode.</p> <p><b>OFF</b> : The surround back channel is not played.</p> <ul style="list-style-type: none"> <li>*1 : This can be selected when playing DTS sources.</li> <li>*2 : This can be selected when playing DTS sources including a signal to identify discrete 6.1-channel signals.</li> <li>*3 : This can be selected when "Speaker Configuration" – "Surround Back" (page 34) is set to "2spkr".</li> </ul> <p></p> <ul style="list-style-type: none"> <li>• This can also be set by pressing <b>STANDARD</b>.</li> <li>• If the source being played contains a surround back signal, the decoder type is automatically selected by the AFDM function. Set "AFDM" to "OFF" to switch to your preferred decoder.</li> <li>• If the setting in "Speaker Configuration" – "Surround Back" (page 34) is "None", "Surround Back" is not displayed.</li> </ul> <p><b>Subwoofer Att.</b> : Attenuate subwoofer level when using EXT. IN input.</p> <ul style="list-style-type: none"> <li>• <b>ON</b> : Set.</li> <li>• <b>OFF</b> : Do not set. Usually use in this mode.</li> </ul> <p></p> <p>Set this to "ON" if the subwoofer channel level seems too high when playing audio signal.</p> <p><b>Subwoofer</b> : Turn subwoofer output on and off.</p> <ul style="list-style-type: none"> <li>• <b>ON</b> : The subwoofer is used.</li> <li>• <b>OFF</b> : The subwoofer is not used.</li> </ul> <p><b>Default</b> : Restores all the surround parameter settings to their defaults.</p> <ul style="list-style-type: none"> <li>• <b>No</b> : Do not reset to the defaults.</li> <li>• <b>Yes</b> : Reset to the defaults.</li> </ul>
<b>Tone</b> Adjust the tonal quality of the sound.	<p><b>Tone Control</b> : Sets the tone control function ON and OFF.</p> <ul style="list-style-type: none"> <li>• <b>ON</b> : Allow tone adjustment (treble, bass).</li> <li>• <b>OFF</b> : Playback without tone adjustment.</li> </ul> <p></p> <ul style="list-style-type: none"> <li>• This can be set when "Dynamic EQ" (page 73) is set to "OFF".</li> <li>• The tone cannot be adjusted in the direct mode.</li> </ul> <p><b>Bass</b> : Adjust low frequency range (bass).</p> <ul style="list-style-type: none"> <li>• <b>-6dB ~ +6dB</b></li> </ul> <p></p> <p>This can be set when "Tone Control" (page 72) is set to "ON".</p> <p><b>Treble</b> : Adjust high frequency range (treble).</p> <ul style="list-style-type: none"> <li>• <b>-6dB ~ +6dB</b></li> </ul> <p></p> <p>This can be set when "Tone Control" (page 72) is set to "ON".</p>

See overleaf



Main remote control  
operation buttons:Displaying the menu  
Cancel the menu:Moves the cursor  
(Up/Down/Left/Right)



:Confirm the setting







:Return to previous menu

## Adjusting the Sound and Picture Quality (Audio/Video Adjust)

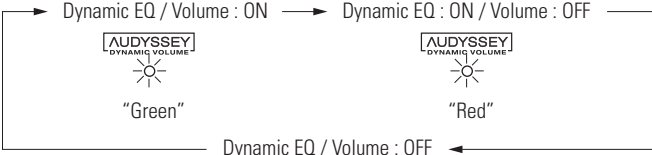
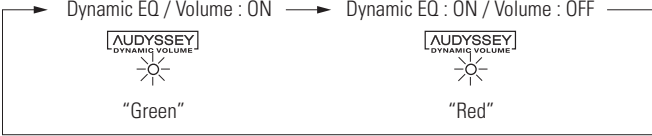
Setting items	Setting contents
<b>Audyssey Settings</b> Set MultEQ, Dynamic EQ and Dynamic Volume.	<p><b>MultEQ</b> : Corrects both time and frequency response problems in the listening area.</p> <ul style="list-style-type: none"> <li>• <b>Audyssey</b> : Optimize the frequency response of all speakers.</li> <li>• <b>Audyssey Byp.L/R</b> : Optimize frequency response of speakers except front L and R speakers.</li> <li>• <b>Audyssey Flat</b> : Optimize frequency response of all speakers to flat response.</li> <li>• <b>Manual</b> : Apply frequency response set with "Manual EQ" (page 74).</li> <li>• <b>OFF</b> : Turn "MultEQ" equalizer off.</li> </ul> <p> "Audyssey", "Audyssey Byp. L/R" and "Audyssey Flat" can be selected after Audyssey Auto Setup has been performed. "Audyssey" is automatically selected after performing Audyssey Auto Setup. "When "Audyssey", "Audyssey Byp.L/R" or "Audyssey Flat" is selected, "MULTEQ" lights.</p> <ul style="list-style-type: none"> <li>• After running Audyssey Auto Setup, if the Speaker Configuration, Distance, Channel Level, and Crossover Frequency have changed without increasing the number of speakers measured, only "MULTEQ" lights.</li> <li>• If "Dynamic EQ" or "Dynamic Volume" is set to "ON" when "MultEQ" is set to either "OFF" or "Manual", "MultEQ" is automatically set to "Audyssey".</li> <li>• You can also press <b>MULTEQ</b> to set.</li> </ul> <p><b>NOTE</b></p> <ul style="list-style-type: none"> <li>• "MultEQ" and "Manual EQ" cannot be selected when "EQ Customize" is set to "Not Used" (page 38).</li> <li>• When using headphones, "MultEQ" is set to "OFF".</li> </ul> <p><b>Dynamic EQ</b> : Solves the problem of deteriorating sound quality as volume is decreased by taking into account human perception and room acoustics.</p> <ul style="list-style-type: none"> <li>• <b>ON</b> : Use the Dynamic EQ equalizer.</li> <li>• <b>OFF</b> : Do not use the Dynamic EQ equalizer.</li> </ul> <p> After performing "Audyssey Auto Setup", the "Dynamic EQ" setting automatically becomes "ON".</p> <ul style="list-style-type: none"> <li>• "MULTEQ DYN EQ" is displayed when set to "ON".</li> <li>• When "MultEQ" is set to "OFF" or "Manual", "Dynamic EQ" is automatically set to "OFF".</li> <li>• If "Dynamic Volume" is set to "ON", "Dynamic EQ" is automatically set to "ON".</li> <li>• When you set "Dynamic EQ" to "ON", "Tone Control" is switched "OFF".</li> <li>• You can also press <b>[DYNAMIC EQ]</b> to set.</li> </ul>

Setting items	Setting contents
<b>Audyssey Settings</b> (Continued)	<p>Dynamic EQ : ON/Volume : OFF → Dynamic EQ / Volume : OFF</p> <div style="display: flex; justify-content: space-around; align-items: center;"> <div style="text-align: center;">             "Red"         </div> <div style="text-align: center;">             "Off"         </div> </div> <p><b>About Dynamic EQ</b></p> <p>Audyssey Dynamic EQ solves the problem of deteriorating sound quality as volume is decreased by taking into account human perception and room acoustics. Audyssey Dynamic EQ works in tandem with Audyssey MultEQ® to provide well-balanced sound for every listener at any volume level.</p> <p><b>Reference Level Offset</b> : Audyssey Dynamic EQ is referenced to the standard film mix level. It makes adjustments to maintain the reference response and surround envelopment when the volume is turned down from 0 dB. However, film reference level is not always used in music or other non-film content. The Dynamic EQ Reference Level Offset provides three offsets from the film level reference (5 dB, 10 dB, and 15 dB) that can be selected when the mix level of the content is not within the standard.</p> <ul style="list-style-type: none"> <li>• <b>0dB</b> (Film Ref) : This is the default setting and should be used when listening to movies.</li> <li>• <b>5dB</b> : Select this setting for content that has a very wide dynamic range, such as classical music.</li> <li>• <b>10dB</b> : Select this setting for jazz or other music that has a wider dynamic range. This setting should also be selected for TV content as that is usually mixed at 10 dB below film reference.</li> <li>• <b>15dB</b> : Select this setting for pop/rock music or other program material that is mixed at very high listening levels and has a compressed dynamic range.</li> </ul> <p> Setting is enabled when "Dynamic EQ" is "ON" (page 73).</p>

Setting items	Setting contents
<b>Audyssey Settings</b> (Continued)	<p><b>Dynamic Volume</b> : Solves the problem of large variations in volume level between TV, movies and other content (between quiet passages and loud passages, etc.) by automatically adjusting to the user's preferred volume setting.</p> <ul style="list-style-type: none"> <li>• <b>ON</b> : Use the "Dynamic Volume" equalizer. The Dynamic Volume effect will be at the level of the "Setting" (page 74).</li> <li>• <b>OFF</b> : Do not use the "Dynamic Volume" equalizer.</li> </ul> <p> "AUDYSSEY MULTIEQ DYN VOL" is displayed when set to "ON".</p> <ul style="list-style-type: none"> <li>• When "MultEQ" is set to "OFF", "Dynamic Volume" is automatically set to "OFF".</li> <li>• You can also press <b>DYNAMIC VOLUME</b> to set.</li> </ul> <div style="border: 1px solid black; padding: 5px; text-align: center;"> <p><b>Operation on the main unit</b></p>  </div> <div style="border: 1px solid black; padding: 5px; text-align: center;"> <p><b>Operation on the main remote control unit</b></p>  </div> <div style="border: 1px solid black; padding: 5px;"> <p style="text-align: center;"><b>About Dynamic Volume</b></p> <p>Audyssey Dynamic Volume™ solves the problem of large variations in volume level between television programs, commercials, and between the soft and loud passages of movies.</p> <p>Audyssey Dynamic EQ™ is integrated into Dynamic Volume so that as the playback volume is adjusted automatically, the perceived bass response, tonal balance, surround impression, and dialog clarity remain the same.</p> </div> <p><b>Setting</b> : Set "Dynamic Volume" equalizer effect.</p> <ul style="list-style-type: none"> <li>• <b>Midnight</b> : High setting affects volume the most, causing all sounds to be of equal loudness.</li> <li>• <b>Evening</b> : Middle setting prevents loud and soft sounds from being much louder and softer respectively than average sounds.</li> <li>• <b>Day</b> : Low setting provides the least adjustments to the loudest and softest of sounds.</li> </ul> <p> Can be set when "Dynamic Volume" is set to "ON".</p>

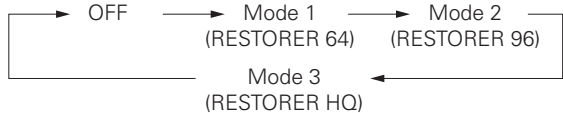
Setting items	Setting contents
<b>Manual EQ</b>	<p>Use the graphic equalizer to adjust the tone of each speaker.</p> <p><b>Adjust CH</b> : Correct the tone of each speaker.</p> <ol style="list-style-type: none"> <li>① Select the speaker tone adjustment method.  <b>All</b> : Adjust the tone of all speakers together.  <b>L/R</b> : Adjust the tone of left and right speakers together.  <b>Each</b> : Adjust the tone of each speaker.</li> <li>② Select the speaker.</li> <li>③ Select the adjustment frequency band.  <b>63Hz / 125Hz / 250Hz / 500Hz / 1kHz / 2kHz / 4kHz / 8kHz / 16kHz</b>                      ※ Select the speakers you want to adjust when "L/R" or "Each" is selected.</li> <li>④ <b>Adjust the level.</b>  <b>-20.0dB ~ +6.0dB (0.0dB)</b></li> </ol> <p> Can be set when the "MultEQ" setting (page 73) is "Manual EQ".</p> <p><b>Base Curve Copy</b> : Copy "Audyssey Flat" curve from MultEQ.  <b>Yes</b> : Copy.  <b>No</b> : Do not copy.</p> <p> "Base Curve Copy" is displayed after Audyssey Auto Setup procedure has been performed.</p> <p><b>Default</b> : Reset the settings to the default values.</p> <ul style="list-style-type: none"> <li>• <b>Yes</b> : Reset.</li> <li>• <b>No</b> : Do not Reset.</li> </ul>
<b>RESTORER</b>	<p>This function restores compressed audio signals to how they were before compression and corrects the sense of volume of the bass and treble to obtain richer playback sound.</p> <p><b>OFF</b> : Do not use RESTORER.</p> <p><b>Mode 1</b> (RESTORER 64) : Optimized mode for compressed sources with very weak highs.</p> <p><b>Mode 2</b> (RESTORER 96) : Apply suitable bass and treble boost for all compressed sources.</p> <p><b>Mode 3</b> (RESTORER HQ) : Optimized mode for compressed sources with normal highs.</p> <p></p> <ul style="list-style-type: none"> <li>• This can be set with analog signals or when a PCM signal (fs = 44.1/48 kHz) is input.</li> <li>• This cannot be set when the input mode is set to "EXT. IN" or when the surround mode is set to "DIRECT".</li> <li>• The default setting for "iPod" and "NET/USB" are "Mode3". All others are set to "OFF".</li> <li>• When set to something other than "OFF", "RSTR" is displayed.</li> <li>• This can also be set by pressing <b>RESTORER</b> during playback.</li> </ul> <div style="text-align: center;">  </div>

See overleaf

## Adjusting the Sound and Picture Quality (Audio/Video Adjust)

Setting items	Setting contents
<b>RESTORER</b> (Continued)	<p><b>About the RESTORER function</b></p> <ul style="list-style-type: none"> <li>Such compressed audio formats as MP3, WMA (Windows Media Audio) and MPEG-4 AAC reduce the amount of data by eliminating signal components that are hard for the human ear to hear. The RESTORER function generates the signals eliminated upon compression, restoring the sound to conditions near those of the original sound before compression. It also corrects the sense of volume of the bass to obtain richer sound with compressed audio signals.</li> <li>This is displayed on the GUI menu and can be set when the input source is set to "HD Radio" or "NET/USB", or when analog signals (including FM/AM signals) or PCM signals (fs = 44.1/48 kHz) are input.</li> </ul>
<b>Audio Delay</b> While viewing video, manually adjust the time to delay audio output.	<p><b>0ms ~ 200ms</b></p>  <ul style="list-style-type: none"> <li>This can be set within the range of 0 to 100 ms when "Auto Lip Sync" is set to "ON" and when a TV compatible with Auto Lipsync is connected.</li> <li>Store "Audio Delay" for each input source.</li> <li>You can also press &lt;AUDIO DELAY&gt; to set.</li> </ul>



## Adjusting the Picture Quality (Picture Adjust)

GUI

Default settings are underlined.

- This can be set when the input source is **DVD** **HDP** **TV** **SAT/CBL** **VCR** **DVR** **V.AUX** **NET/USB**.
  - ※ With input sources other than the ones above, this can be set when "Video Select" is selected. In this case, the original input source settings are called out.
- Can be set when the "Video Convert" setting (page 48) is "ON".

Setting items	Setting contents
<b>Contrast</b> Adjust picture contrast.	<b>-6 ~ +6 (0)</b>
<b>Brightness</b> Adjust picture brightness.	<b>0 ~ +12</b>
<b>Chroma Level</b> Adjust picture chroma level (saturation).	<b>-6 ~ +6 (0)</b>
<b>Hue</b> Adjust color hue.	<b>-6 ~ +6 (0)</b>
<b>DNR</b> Reduce overall picture noise.	<b>OFF / Low / Middle / High</b>
<b>Enhancer</b> Emphasize picture contours.	<b>0 ~ +12</b>







- "DNR" and "Enhancer" are each effective with HDMI output.
- The value set at "Picture Adjust" is stored in the memory individually for each input source.







# Checking the Status (Information)



Setting items	Setting contents		
 <b>Status</b> Shows information about current settings.	<input type="checkbox"/> <b>MAIN ZONE</b> Shows information about settings for MAIN ZONE. The items displayed differ according to the input source. <b>Select Source / Name / Zone Rename / Surround Mode / Input Mode / Decode Mode / HDMI / Digital / Component / iPod dock / Rec Select / Video Select / Video Convert / i/p Scaler / Resolution / Progressive Mode / Aspect</b> etc.		
	<input type="checkbox"/> <b>ZONE2 / ZONE3</b> Shows information about settings for multi-zone. <b>Zone Rename / Power / Select Source / Volume Level</b>		
 <b>Audio Input Signal</b> Shows information about audio input signals.	<b>Surround Mode</b> : The currently set surround mode <b>Signal</b> : The input signal type <b>fs</b> : The input signal's sampling frequency <b>Format</b> : The number of channels in the input signal (front, surround, LFE) <b>Offset</b> : The dialogue normalization correction value <b>Flag</b> : This is displayed when inputting signals including a surround back channel. "MATRIX" is displayed with Dolby Digital EX and DTS-ES Matrix signals, "DISCRETE" with DTS-ES Discrete signals.		
	<table border="1" style="width: 100%;"> <thead> <tr> <th>Dialogue normalization function</th> </tr> </thead> <tbody> <tr> <td>           This is automatically activated when playing Dolby Digital sources.            This function automatically corrects the standard signal level for individual program sources.            The correction value can be checked using the &lt;STATUS&gt;.           <div style="border: 1px solid black; padding: 5px; text-align: center; margin: 10px 0;">             Dial.Norm              Offset - 4dB           </div>           The figure is the correction value when the standard level is corrected.         </td> </tr> </tbody> </table>	Dialogue normalization function	This is automatically activated when playing Dolby Digital sources. This function automatically corrects the standard signal level for individual program sources. The correction value can be checked using the <STATUS>. <div style="border: 1px solid black; padding: 5px; text-align: center; margin: 10px 0;">             Dial.Norm              Offset - 4dB           </div> The figure is the correction value when the standard level is corrected.
Dialogue normalization function			
This is automatically activated when playing Dolby Digital sources. This function automatically corrects the standard signal level for individual program sources. The correction value can be checked using the <STATUS>. <div style="border: 1px solid black; padding: 5px; text-align: center; margin: 10px 0;">             Dial.Norm              Offset - 4dB           </div> The figure is the correction value when the standard level is corrected.			
 <b>HDMI Information</b> Shows information about HDMI input/output signals and monitor.	<b>Signal Information</b> • Resolution / Color Space / Pixel Depth <b>Monitor Information</b> • Interface / Supported resol.		
 <b>Auto Surround Mode</b> Shows information about auto surround mode settings.	<b>Analog/PCM 2ch / Digital 2ch / Digital 5.1ch / Multi ch</b>  This can be displayed when "Auto Surround Mode" is set to "ON".		

Setting items	Setting contents
 <b>Quick Select</b> Shows information about "Saving Frequently Used Settings (Quick Select Function)" (page 80) settings.	<b>Quick Select 1 / Quick Select 2 / Quick Select 3 / ZONE2 Quick Select / ZONE3 Quick Select</b> • Select Source / Video Select / MultEQ / Dynamic EQ / Dynamic Volume / Auto Surround Mode (Analog/PCM 2ch / Digital 2ch / Digital 5.1ch / Multi ch) / Volume Level
 <b>Preset Channel</b> Shows information about preset channels.	This can be checked when the input source is set to <b>NET/USB</b> <b>SIRIUS</b> <b>HD Radio</b> . <b>A / B / C / D / E / F / G</b> • A1 ~ A8 / B1 ~ B8 / C1 ~ C8 / D1 ~ D8 / E1 ~ E8 / F1 ~ F8 / G1 ~ G8

Main remote control operation buttons



:Displaying the menu  
Cancel the menu



:Moves the cursor  
(Up/Down/Left/Right)



:Confirm the setting



:Return to previous menu

# Other Operations and Convenient Functions

**Symbols used to indicate buttons in this manual**

- Button located on both the main unit and the remote control unit → **BUTTON**
- Button only on the main unit → **<BUTTON>**
- Button only on the remote control unit → **[BUTTON]**

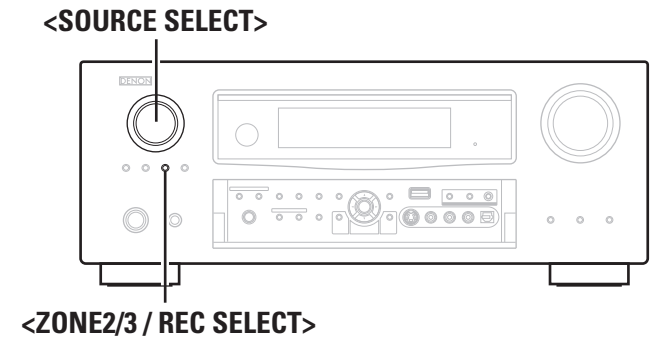

## Other Operations

### Recording on an External Device (REC OUT mode)

You can listen to one program source while recording a different program source.

- 1 Press <ZONE2/3 / REC SELECT> .**  
"ZONE2 SOURCE" is shown on the display.
- 2 Turn <SOURCE SELECT> until "RECOUT SOURCE" is displayed.**  
The "REC" indicator lights.  

ZONE2 SOURCE	↔	ZONE2 PHONO	↔	.....	↔	ZONE2 HD Radio
↑						↓
RECOUT HD Radio	↔	RECOUT SIRIUS	↔	.....	↔	RECOUT SOURCE
- 3 Turn <SOURCE SELECT> to choose the input source to be recorded.**
- 4 Play the program source.**  
\* For operating instructions, refer to the respective equipment's operating instructions.
- 5 Start recording.**  
\* For operating instructions, refer to the respective equipment's operating instructions.

- To cancel, press <ZONE2/3 / REC SELECT>, then turn <SOURCE SELECT> until "ZONE2 SOURCE" is displayed.
- Make a test recording before starting the actual recording.
- Signals are only output to the analog REC OUT connectors when the digital signals input to the digital input connectors (OPTICAL/ COAXIAL) are PCM (2-channel) signals.
- Digital audio signals input to the HDMI connectors are not output to the REC OUT connectors, so connect using the OPTICAL or COAXIAL connectors.
- Sources selected with the REC OUT mode are output from ZONE2 as well.
- In the REC OUT mode, the remote control unit's ZONE2 mode buttons cannot be operated.
- The "HD Radio" digital audio output signals are not output from the OPTICAL2 output connectors. Also, network audio signals (Internet radio, music server, USB) are not output if they are copyright-protected.

**NOTE**

- Recordings you make are for your personal enjoyment and should not be used for other purposes without permission of the copyright holder.
- Input sources for which "Delete" is selected at "Source Delete" (page 42) cannot be selected.



# Convenient Functions

## HDMI Control Function

When you make an HDMI connection with a TV or player compatible with AVR-3310CI and HDMI control functions, you can perform the following operations by setting the HDMI control function of each device.

- AVR-3310CI power off can be linked to the TV power off step.**  
When you set "Output audio from amp" in the TV audio output setup operation, you can switch the amp power on.
- You can switch audio output devices with a TV operation.**
- You can adjust AVR-3310CI volume in the TV volume adjustment operation.**
- You can switch AVR-3310CI input source through linkage to TV input switching.**
- When playing the player, the AVR-3310CI input function switches to the function of that player.**



- When you want to listen to TV audio by AVR-3310CI, connect optical digital or analog audio (page 15 "Connecting the Monitor").
- When using these functions set as follows: "HDMI Control" (page 36) set to "ON".

### NOTE

- When "HDMI Control" is set to "ON", it consumes more standby power.
- The HDMI control function controls operations of a TV that is compatible with the HDMI control function. Make sure that the TV and HDMI are connected when you perform HDMI control.
- When you power off AVR-3310CI, the HDMI control function does not operate. Either power on or set to standby.
- Some functions may not operate depending on the connected TV or player. Check the owner's manual of each device for details beforehand.
- When "HDMI Control" is set to "ON", it is not possible to assign an HDMI terminal to "TV" at "Input Assign" (page 46).

**1 Turn the power on for all the equipment connected by HDMI cable.**

**2 Set the HDMI control function for all equipment connected by HDMI cable.**

Set "HDMI Control" (page 36) to "ON".

※ Please consult the operating instructions for the connected equipment to check the settings.

※ Carryout steps 1 and 2 should any of the equipment be plugged out.

**3 Switch the television input to the HDMI connected to the AVR-3310CI.**

**4 Switch the AVR-3310CI input to the HDMI input source and check if the picture from the player is ok.**

**5 When you turn the TV's power to standby, check that the power of the AVR-3310CI and player also goes on standby.**



If the HDMI control function does not operate properly, check the following points.

- Is the TV or player compatible with the HDMI control function?
- Is the AVR-3310CI properly set?
  - Is the "HDMI Control" (page 36) set to "ON"?
  - Is the "Power Off Control" (page 36) set to "ON"?
- Are the HDMI control function settings of all equipment correct?

### NOTE

Should any of the operations below be performed, the interlocking function may be reset, in which case, repeat step's 1 and 2.

- "Input Assign" - "HDMI" (page 46) setting has changed.
- There is a change to the connection between the equipment and the HDMI, or an increase in equipment.

## Convenient Functions

 Symbols used to indicate buttons in this manual

- Button located on both the main unit and the remote control unit → **BUTTON**
- Button only on the main unit → **<BUTTON>**
- Button only on the remote control unit → **[BUTTON]**

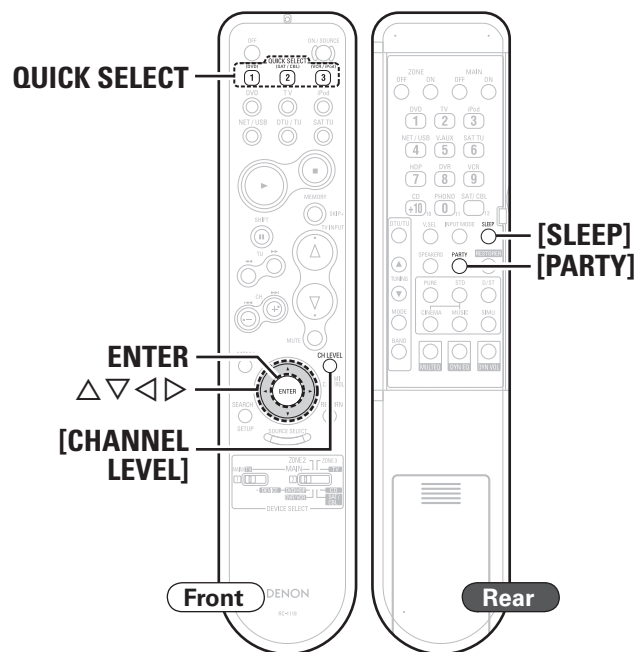
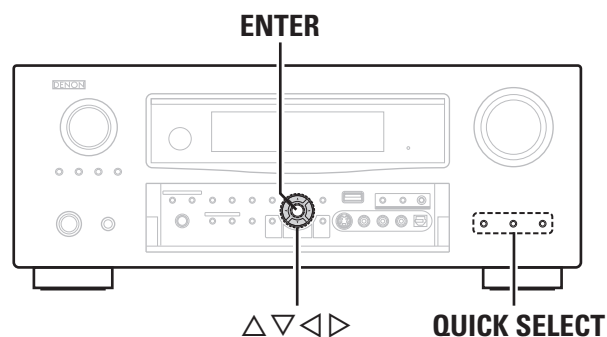

## Setting the Power to Standby After a Certain Amount of Time (Sleep Timer Function)

With this function, you can set the AVR-3310CI so that the power is automatically switched to standby after the set amount of time has passed.

This is convenient for playing sources while going to sleep. When the sleep timer turns the power off in the MAIN ZONE, the power also turns off in the ZONE2 and ZONE3.

### Press [SLEEP] and display the time you want to set.

The "SLEEP" indicator on the display lights.

- The time switches as shown below each time [SLEEP] is pressed.

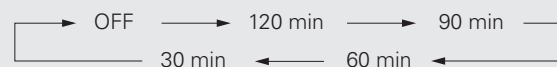

### To cancel the sleep timer

Press [SLEEP] to set "OFF".

The "SLEEP" indicator on the display turns off.



The sleep timer setting is canceled if the AVR-3310CI's power is set to standby or turned off.

## Adjust the Volume of the Speakers

You can adjust the channel level either according to the playback sources or to suit your taste, as described below.

### Adjust the Volume of the Different Speakers

#### 1 Press [CHANNEL LEVEL].

#### 2 Use $\Delta$ $\nabla$ to select the speaker.

The speaker that can be set switches each time one of the buttons is pressed.

#### 3 Use $\triangleleft$ $\triangleright$ to adjust the volume.

※ In the case of a subwoofer, press  $\triangleleft$  when it is at "-12 dB" will change the setting to "OFF".



When a headphone jack is inserted, the headphone channel level can be adjusted.

### Adjusting the Volume of Groups of Speakers (Fader Function)

This function lets you adjust (fade) the sound from all the front (Front speaker / Front height speaker / Center speaker) or rear (Surround speaker / Surround back speaker) speakers at once.

#### 1 Use $\nabla$ to select "Fader", then select the item to be adjusting using $\triangleleft$ or $\triangleright$ .

#### 2 Use $\triangleleft$ $\triangleright$ to adjust the volume of the speakers. ( $\triangleleft$ : front, $\triangleright$ : rear)



- The fader function does not affect the subwoofer.
- The fader can be adjusted until the volume of the speaker adjusted to the lowest value is -12 dB.

## Saving Frequently Used Settings (Quick Select Function)

All of the settings in step 1 can be memorized together. By memorizing frequently used settings, you can quickly access and enjoy a playback environment that is consistently the same.

### Saving the Settings

#### 1 Set the items below to the settings you want to save.

- ① Input Source (☞ page 27)
- ② Volume Level (☞ page 67)
- ③ Surround Mode (☞ page 69)
- ④ Audyssey Setting (MultEQ®, Dynamic EQ™, Dynamic Volume™) (☞ page 73, 74)
- ⑤ Video Select (☞ page 48)

#### 2 Press and hold the desired QUICK SELECT until “Memory” appears on the display.

The current settings will be memorized.

#### [Quick Select Defaults]

	Input Source	Volume
Quick Select 1	DVD	-40dB
Quick Select 2	SAT/CBL	-40dB
Quick Select 3	VCR	-40dB

### Calling the Settings Out

Press **QUICK SELECT** at which the settings you want to call out are saved.

The “[Q1]”, “[Q2]” or “[Q3]” indicator lights on the display.

#### ❑ Naming Quick Select settings

See “Quick Select Name” (☞ page 42).

#### NOTE

Input sources stored with the quick select function cannot be selected if they have been deleted at “Source Delete” (☞ page 42). In this case, store them again.

## Playing the Same Network Audio on Different Devices Connected in a Network (Party Mode Function)

The same network audio (Internet Radio, Media Server or iPod DIRECT) can be played on multiple DENON products equipped with the Party Mode function and connected in a network.

The party mode consists of one organizer and up to four attendees. When one unit starts the party mode as the organizer, up to four devices on which the party mode function is activated automatically participate in the party as attendees. “Party Mode Function” (☞ page 39) must be set to “ON” ahead of time in order to use the party mode function.

### Starting the Party Mode as the Organizer

#### 1 Press [PARTY] to become the organizer.

“Enter Party Mode?” is displayed.

※ An error message is displayed when you are not connected to a network.

#### 2 Press ◀▶ to select “Yes”, then press ENTER.

The “**PARTY ORGANIZER**” indicator on the display lights. The input source automatically switches to “NET/USB” and the attendees are automatically selected.

#### 3 Play the desired track.

#### ❑ To Cancel the Party Mode

#### 1 While in the party mode, press [PARTY].

“Exit Party Mode?” is displayed on the GUI screen.

#### 2 Press ◀▶ to select “Yes”, then press ENTER.

“Power off Attendees component?” is displayed.

#### 3 Press ◀▶ to select “Yes” or “No”, then press ENTER.

**Yes** : The power of the attendees is turned off and the party mode is canceled.

**No** : The party mode is canceled without turning off the power of the attendees.

## Participating in the Party Mode as an Attendee

- When the organizer starts the party mode, up to four attendees are selected automatically. No operation is required.
- When a device becomes an attendee, “**PARTY ATTENDEE**” appears on the display. The input source automatically switches to “NET/USB” and the same network audio as on the organizer is played.
- If there are fewer than four attendees, a device can join the party mode after it has started. To participate in the party mode, perform the operation described below.

#### 1 Press [PARTY].

“Enter Party Mode?” is displayed.

※ An error message is displayed when you are not connected to a network.

#### 2 Press ◀▶ to select “Yes”, then press ENTER.

#### ❑ To Cancel the Party Mode

#### 1 While in the party mode, press [PARTY].

“Exit Party Mode?” is displayed on the GUI screen.

#### 2 Press ◀▶ to select “Yes”, then press ENTER.

In this case, the other devices remain in the party mode.



“Rhapsody”, “Napster” and “USB” are not available in the Party Mode.

There can only be one organizer in the network. To form a new party mode, first cancel the current party mode.

## Convenient Functions

## Operating a Wireless LAN-Compatible Mobile Terminal to Play Music and Videos

- Perform this procedure using a wireless LAN-compatible mobile terminal conforming to the DLNA (Digital Living Network Alliance) standard.
- This function allows you to play contents located on a computer (music server) or mobile terminal device connected in a network by operating a mobile terminal device in the same network.
- There are two types of operations on the mobile terminal device.

### Playing Contents on a Computer (Media Server)

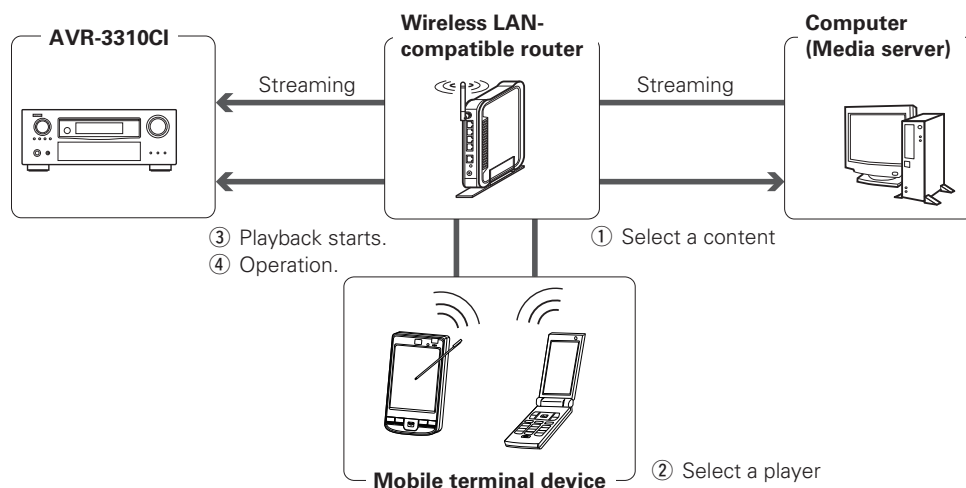

## 1 From the mobile terminal device, browse the media server in the same network and choose the contents you want to play.

## 2 From the mobile terminal device, select the AVR-3310CI among the products in the network.

Playback of the contents selected in step 1 begins.

※ When selecting the AVR-3310CI from the mobile terminal device, the name of the AVR-3310CI is displayed at "Friendly Name" (☞ page 39 "Friendly Name Edit").

※ The following operations are possible from the mobile terminal device:

- File operations (play, stop, pause, track search)
- Play mode settings (repeat/random)
- Volume adjustment

### Playing Contents on a Mobile Terminal Device

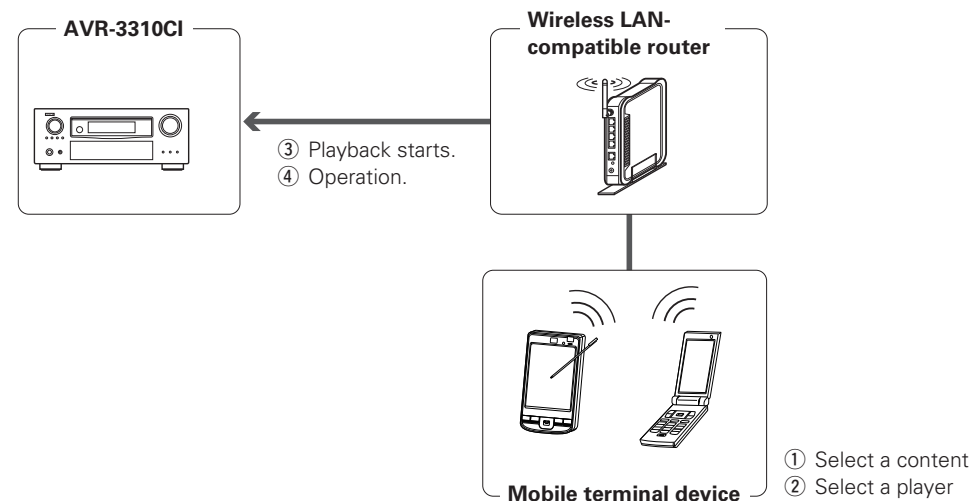

## 1 Select the contents you want to play from among the mobile terminal devices.

## 2 From the mobile terminal device, select the AVR-3310CI among the products in the network.

Playback of the contents selected in step 1 begins.

※ When selecting the AVR-3310CI from the mobile terminal device, the name of the AVR-3310CI is displayed at "Friendly Name" (☞ page 39 "Friendly Name Edit").

※ The following operations are possible from the mobile terminal device:

- File operations (play, stop, pause, track search)
- Play mode settings (repeat/random)
- Volume adjustment



- "📶" is displayed on the GUI screen while the mobile terminal device is being operated.
- For the various settings and operating procedures, see the operating instructions of the mobile terminal devices being used.
- When selecting the AVR-3310CI from the mobile terminal device, the name of the AVR-3310CI is displayed at "Friendly Name". "Friendly Name" can be edited at "Friendly Name Edit" (☞ page 39) as desired so that it is easily distinguishable from other devices.
- When playback is started from the mobile terminal device, the AVR-3310CI's input source automatically switches to "NET/USB". Also, when the "Network Standby" setting (☞ page 39) is set to "ON", the power automatically turns on.

### NOTE

When operations related to browsing or playback (play, stop, pause, track search) are performed on the AVR-3310CI while operating the mobile terminal device, the connection to the network is disconnected. The network connection is also disconnected when the party mode is started.

## Operating the AVR-3310CI with a Browser (Web Control Function)

You can operate the AVR-3310CI using a browser.

**1** Switch “ON” the “Network Standby” setting (☞ page 39).

**2** Check the AVR-3310CI’s IP address with “Network Information” (☞ page 40).

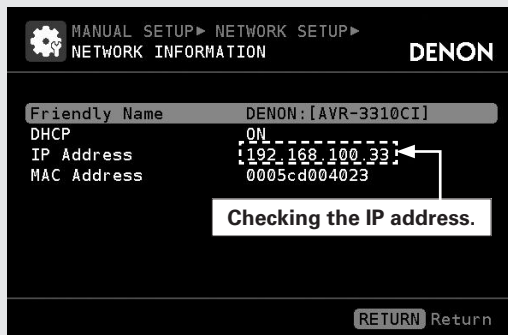

**3** Enter the AVR-3310CI IP address in browser’s address box.

Forexample, if the IP address of AVR-3310CI is “192.168.100.33”, enter “http://192.168.100.33”.

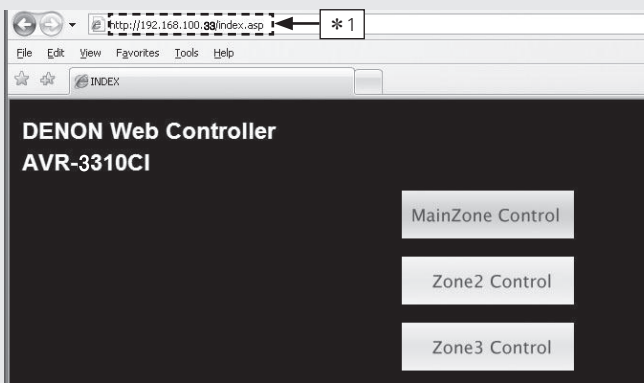

\* 1: Entering the IP address.

**4** When the top menu is displayed, click on the menu you want to operate.

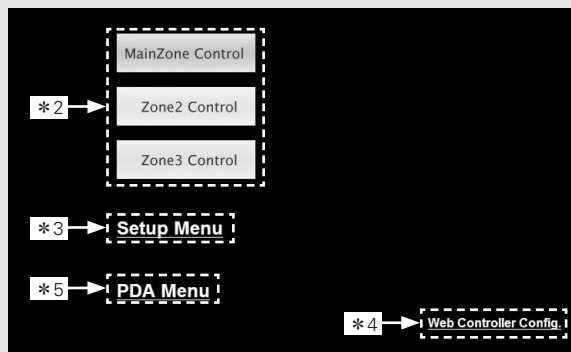

- \* 2: Click when you operate each zone (☞ [Example 1])
- \* 3: Click when you operate the setup menu (☞ [Example 2])
- \* 4: Click to change the Web control screen setting. (☞ [Example 3])
- \* 5: Click when you operate a small screen such as a PDA screen, etc. (☞ [Example 4])

**5** Operate.

[Example 1] Main zone control screen

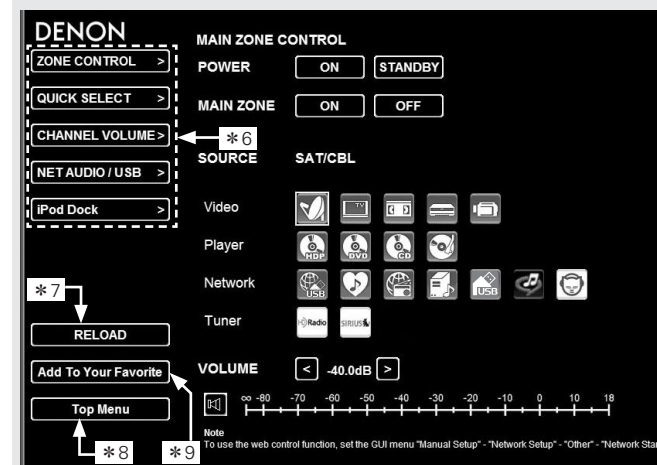

- \* 6: Click to perform each operation.  
Changes to each operation screen (☞ [Example 5])
- \* 7: Click when you update to the latest information.  
Normally, there is a change to the latest information each time you operate. When operated from the main unit, click because the screen is not updated.
- \* 8: Click to return to the top menu.  
Displayed when setting “Top Menu Link Setup” to “ON” in [Example 3]
- \* 9: Click to add a setting to the “Favorites” in your browser.  
We recommend registering the setting screens for the different zones in the browser’s favorites so as not to accidentally perform menu operations for zones you do not intend to operate.

## Convenient Functions

**[Example 2]** Setup menu screen

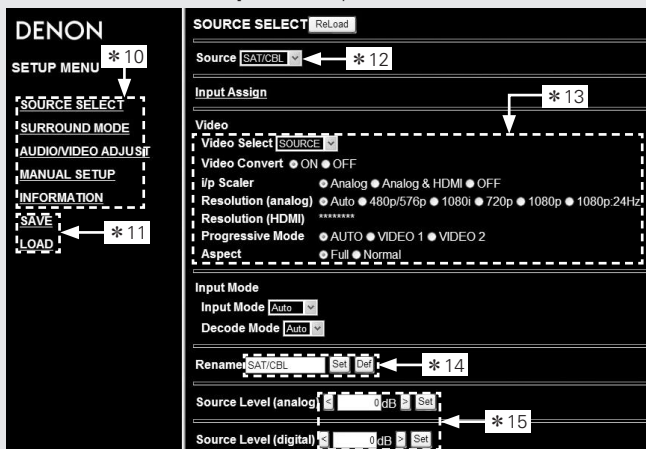

- \* 10: Click the menu from which you want to make settings.  
The display on the right becomes each setting screen.
- \* 11: Click "SAVE" when you want to save settings, and click "LOAD" when you want to call settings.  
Becomes each operation screen.
- \* 12: Click "v" and select from the displayed items.
- \* 13: Click to determine a setting.
- \* 14: After entering characters, click "Set" to set, or click "Def" to return to initial setting.
- \* 15: Enter figures or click "<" or ">" to make the setting, and then click "Set".

**[Example 3]** Web configuration screen

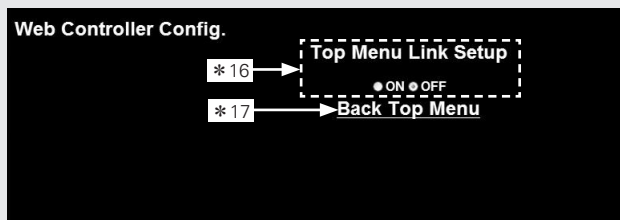

- \* 16: Click "ON" when performing Top Menu Link Setup.  
When set up, return to the top menu from each operation screen. (Default setting: "OFF")
- \* 17: Click to return to the top menu.

**[Example 4]** PDA menu screen

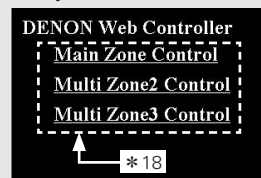

- \* 18: Select to operate each zone.

### NOTE

You cannot change setup menu operations and zone name on the PDA menu screen.

**[Example 5]** Net Audio operating screen

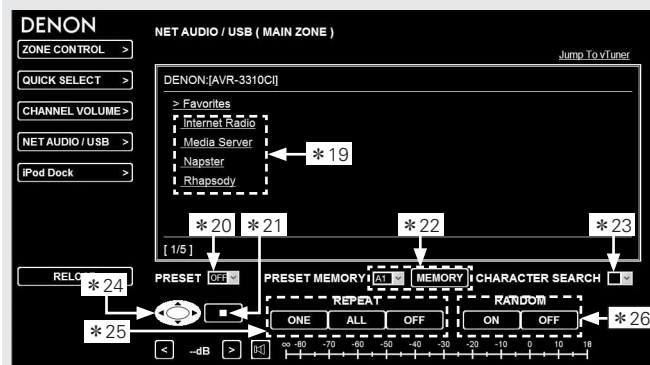

- \* 19: Click the menu from which you want to make settings.
- \* 20: Click "v" to select the preset channel you want to play.
- \* 21: Click to stop play.
- \* 22: When registering presets, click "v" to select the channel you want to register, and then click "MEMORY".
- \* 23: When searching using an acronym, click "v" and select from the displayed characters.
- \* 24: Click when selecting menu.
- \* 25: Click to repeat play.
- \* 26: Click to random play.

**[Example 6]** Dedicated iPod Touch screen

※ When accessed from the iPod Touch browser, an optimized operation screen is displayed.



## Various Memory Functions

### Personal Memory Plus Function

This function sets the settings (input mode, surround mode, HDMI output mode, MultEQ, Dynamic EQ, Dynamic Volume, audio delay etc.) last selected for the individual input sources.



The surround parameters, tone settings and the volumes of the different speakers are stored for the individual surround modes.

### Last Function Memory

This stores the settings as they were directly before the standby mode was set.

When the power is turned back on, the settings are restored to as they were directly before the standby mode was set.

# Playing in ZONE2/ZONE3 (Multi-zone Function)

This function allows you to play sound in rooms other than the main zone where multi-channel sound is played.



The source selected for ZONE2 is also output from the recording output connectors.

## Audio Output

There are two methods to do this, as described below. Choose one of the methods.

- ① Zone playback by speaker output
- ② Zone playback by audio output (PRE OUT)  
Use an external amplifier.

### ① Zone Playback by Speaker Output

The ZONE2 and ZONE3 audio signals are output from the AVR-3310CI's SURR BACK/AMP ASSIGN speaker terminals using the amplifier assignment function.

### Connecting and Setting the Speakers

	Amp Assign mode setting (page 34) and the audio signals that are output	Connecting the speakers
<b>ZONE2</b>	<p><b>ZONE2</b></p> <p>Output signal : Stereo (L / R)</p>	
<b>ZONE3</b>	<p><b>ZONE3</b></p> <p>Output signal : Stereo (L / R)</p>	
<b>ZONE2 and ZONE3</b>	<p><b>ZONE2 (MONO)</b></p> <p>Output signal : Monaural</p>	

### ② Zone Playback by Audio Output (PRE OUT)

#### Audio Connections (ZONE2, ZONE3)

The audio signals of the AVR-3310CI's ZONE2 and ZONE3 audio output terminals are output to the ZONE2 and ZONE3 amplifiers and played on these amplifiers.

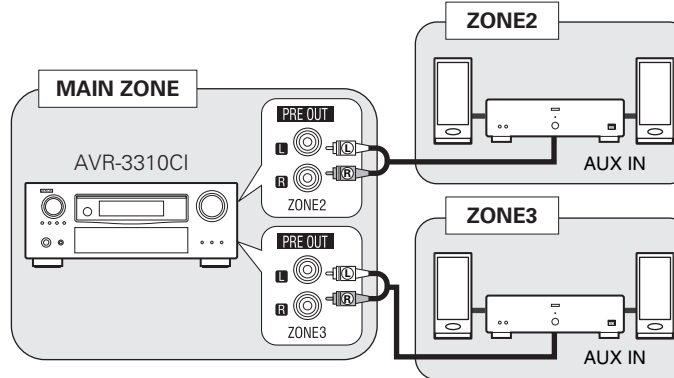

Also be sure to read the operating instructions of the connected devices.

#### NOTE

- We recommend using high quality pin-plug cables for audio connections in order to prevent noise.
- When the input source to which the digital input connectors (OPTICAL/COAXIAL) are assigned is selected in ZONE2 or ZONE3, playback is only possible if the digital signal being input is in PCM (2-channel) format.
- It is not possible to play the digital audio signals input from the HDMI terminals in ZONE2 and ZONE3.
- When certain digital signals are being input, noise may be output from the ZONE2 and ZONE3 audio output connectors.

## Video Output

### Video Connection

The video signals of the AVR-3310CI's ZONE2 video output terminal are played by the ZONE2 TV.

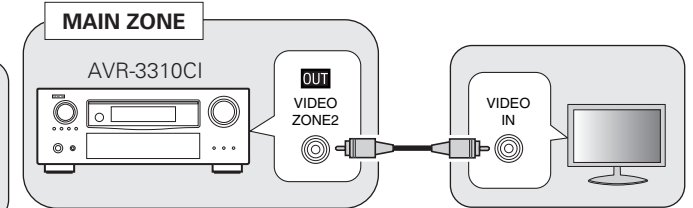

#### NOTE

It is not possible to output video signals input to the HDMI or component terminals to ZONE2.

**Symbols used to indicate buttons in this manual**

Button located on both the main unit and the remote control unit → **BUTTON**  
 Button only on the main unit → **<BUTTON>**  
 Button only on the remote control unit → **[BUTTON]**

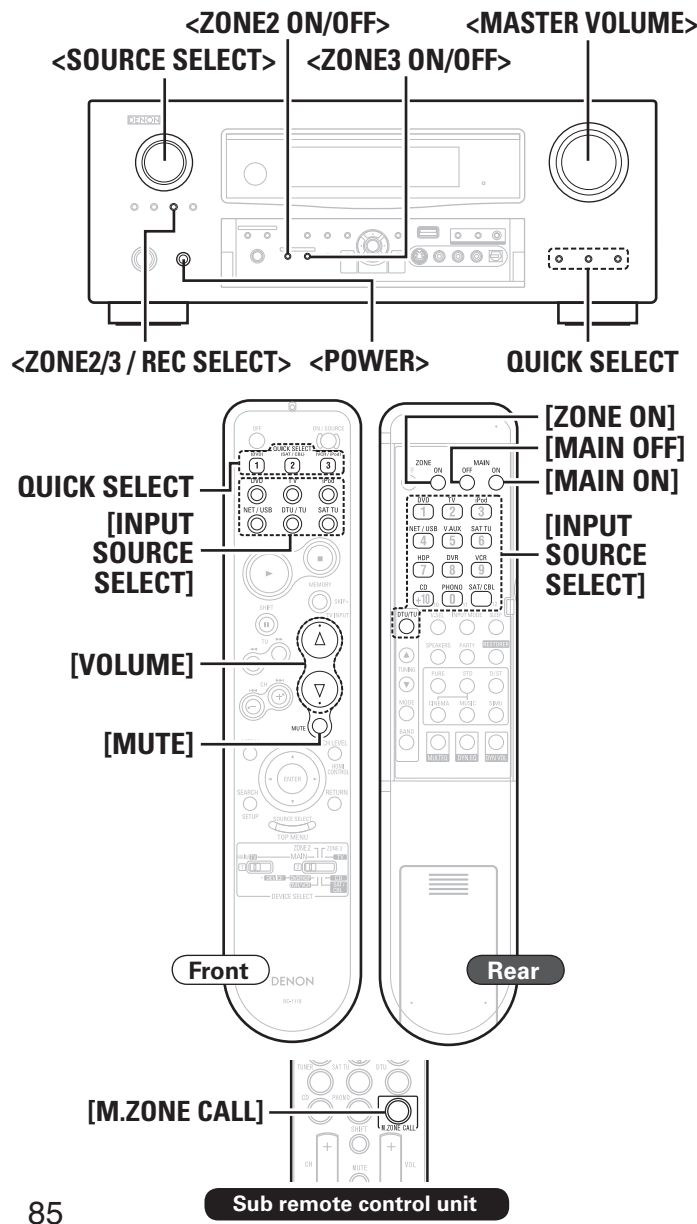

## Playback

The operating procedure is the same for “① Zone Playback by Speaker Output” and “② Zone Playback by Audio Output (PRE OUT)”.

**1 Press <POWER>.**

**2 Turn on the zone power.**

**Operation on the main unit**

Press **<ZONE2 ON/OFF>** or **<ZONE3 ON/OFF>** for the zone to be operated.

When the power turns on, the “**Z2**” or “**Z3**” indicator lights on the display.

**Operation on the remote control unit**

① **Set the main remote control unit’s [DEVICE SELECT] shown on below.**

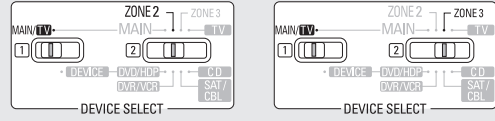

② **Press [ZONE ON].**  
 When the power turns on, the “**Z2**” or “**Z3**” indicator lights on the display.

※ Also press **[INPUT SOURCE SELECT]** when in standby mode, the power turns on.

※ When using ZONE2 or ZONE3, it is possible to turn the power for the MAIN ZONE only on or off by pressing **[MAIN ON]** or **[MAIN OFF]**.

**3 Select the input source.**

**Operation on the main unit**

① Press **<ZONE2/3/ REC SELECT>** and select the zone to be adjusted.

② Turn **<SOURCE SELECT>** to choose the input source.

**Operation on the remote control unit**

**In the zone mode you want to operate, press [INPUT SOURCE SELECT].**

※ The same input source as in the main zone can be selected easily by pressing the **[M.ZONE CALL]** on the sub remote control unit.

## 4 Adjust the item below.

❑ **Adjust the Volume**

**Operation on the main unit**

① Press **<ZONE2/3/ REC SELECT>** and select the zone to be adjusted.

② Turn **<MASTER VOLUME>** to adjust.

**Operation on the remote control unit**

**In the zone mode whose volume you want to adjust, press [VOLUME].**

**[Adjustable range]** --- **-80dB ~ -40dB ~ 18dB**  
 (When the “Volume Display” setting is “Relative”)

**[Adjustable range]** **0 ~ 41 ~ 99**  
 (When the “Volume Display” setting is “Absolute”)

※ Upon purchase, “Volume Limit” is set to “-10dB (71)”.

❑ **Turning off the Sound Temporarily (MUTE)**

**In the zone mode for which you want to mute the sound, press [MUTE].**

The sound is reduced to the level set at menu “Mute Level” (☞ page 41).

※ To cancel, either adjust the volume or press **[MUTE]** again.  
 ※ The setting is canceled when the zone’s power is turned off.

Sub remote control unit



## Quick Select Function

It is also possible to save three settings for multi-zone.

### 1 Set the items below to the settings you want to save.

- ① **Input Source** (☞ page 85)
- ② **Volume Level** (☞ page 85)

### 2 In the zone mode for which you want to operate, press and hold the desired **QUICK SELECT** until “Memory” appears on the display.

The current settings will be memorized.

#### [Quick Select Defaults]

	Input Source	Volume
Z2/Z3 Quick Select 1	DVD	-40dB
Z2/Z3 Quick Select 2	SAT/CBL	-40dB
Z2/Z3 Quick Select 3	VCR	-40dB

### Calling the Settings Out

Press **QUICK SELECT** at which the settings you want to call out are saved.

#### ❑ Naming Quick Select settings

See “Quick Select Name” (☞ page 42).

## Operating the Connected Devices by Remote Control Unit

### Operating the Main Remote Control Unit

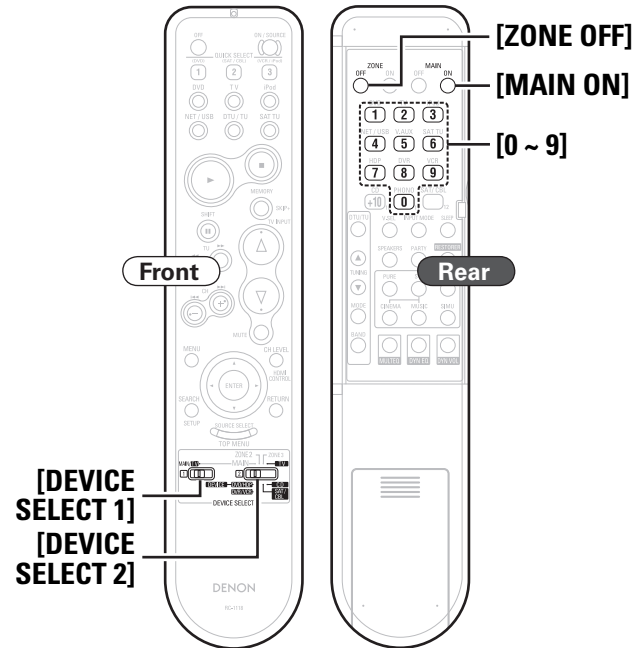

### Registering Preset Codes

DENON and other makes of components can be operated by setting the preset memory.

#### 1 Switch [DEVICE SELECT 1].

**MAIN/TV** : To register a TV

**DEVICE** : To operate a Blu-ray disc player, DVD player, Digital video recorder, video deck, satellite receiver, cable TV or CD player

#### 2 Set [DEVICE SELECT 2] to the component to be registered.

**TV** : TV

**DVD/HDP** : DVD player or Blu-ray disc player

**DVR/VCR** : Digital video recorder or video deck

**SAT/CBL** : Satellite receiver or cable TV

**CD** : CD player

#### 3 Press [ZONE OFF] and [MAIN ON] at the same time. The indicator starts flashing.

#### 4 Press [0 ~ 9] and input the 3-digit number of the brand of the component to be preset. The numbers are shown in the Preset Code Table (☞ End of this manual).

#### 5 To store the codes of another component in the memory, repeat steps 1 to 4.



- Some manufacturers use more than one type of remote control code. Refer to the included list of preset codes to change the number and verify correct operation.
- VDP (Video Disc Player) can be preset when [DEVICE SELECT 2] is set to “DVD/HDP”.
- The preset memory can be set for one component only among the following: TV, DVD/HDP, DVR/VCR, SAT/CABLE and CD.
- Depending on the model and year of manufacture of your equipment, some buttons may not operate.

## Operating the Main Remote Control Unit

### Operating Components

#### 1 Switch [DEVIDE SELECT 1].

**MAIN/TV** : To operate the TV, iPod, HD Radio, SIRIUS or NET/USB

**DEVICE** : To operate a Blu-ray disc player, DVD player, Digital video recorder, video deck, satellite receiver, cable TV or CD player

#### 2 Set [DEVIDE SELECT 2] to the component you want to operate.

**MAIN** : iPod, HD Radio, SIRIUS or NET/USB

**TV** : TV

**DVD/HDP** : DVD player or Blu-ray disc player

**DVR/VCR** : Digital video recorder or video deck

**SAT/CBL** : Satellite receiver or cable TV

**CD** : CD player

#### 3 Operate the component.

※ For details, refer to the component's operating instructions.

#### NOTE

Depending on the model and year of manufacture, this function cannot be used for some models, even if they are of makes listed in the list of preset codes.

### iPod

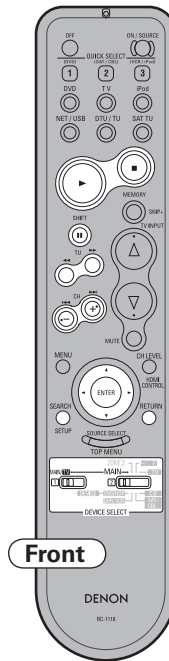

Front		
<b>DEVIDE SELECT</b>		
	Play / Pause	
	Stop	
	Manual search (fast-reverse / fast-forward)	
	Auto search (cue)	
	Cursor	
<b>ENTER</b>	Enter	
<b>II</b>	Pause	
<b>SEARCH</b>	<b>Press and hold</b>	<b>Once</b>
	Browse/Remote mode switching	Page search mode switching
<b>RETURN</b>	Return	

### HD Radio (DTU)

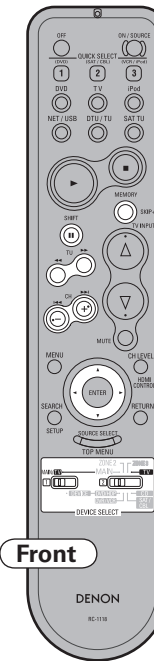

Front	
<b>DEVIDE SELECT</b>	
<b>SHIFT</b>	Preset channel selection
<b>MEMORY</b>	Preset memory registration
<b>TU</b>	Tuning +/-
<b>CH +/-</b>	Preset channel selection
	Multicast switching ( $\Delta \nabla$ ) / Cursor
Rear	
<b>TUNING <math>\Delta \nabla</math></b>	Tuning +/-
<b>MODE</b>	Switch search modes
<b>BAND</b>	AM/FM Switching



SIRIUS (SAT TU)

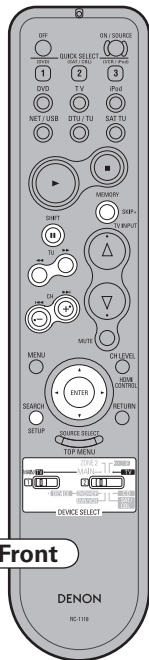

Front

Front	
<b>DEVICE SELECT</b>	
<b>SHIFT</b>	Preset channel selection
<b>MEMORY</b>	Preset memory registration
<b>TU</b>	Channel selection
<b>CH + -</b>	Preset channel selection
<b>Δ ∇ ◀ ▶</b>	Category search / Cursor
<b>ENTER</b>	To parental lock password check screen (Press and hold)
Rear	
<b>TUNING ▲ ▼</b>	Channel selection

NET/USB

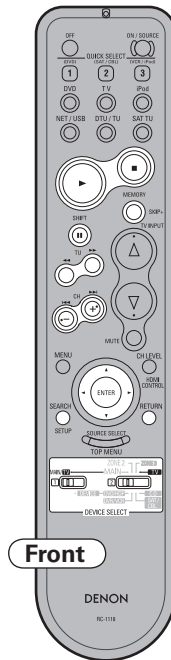

Front

Front	
<b>DEVICE SELECT</b>	
<b>▶</b>	Play/Pause
<b>■</b>	Stop
<b>SHIFT</b>	Preset channel selection
<b>MEMORY</b>	Preset memory registration
<b>◀ ▶</b>	Switching picture
<b>CH + -</b>	Preset channel selection
<b>Δ ∇ ◀ ▶</b>	Cursor
<b>ENTER</b>	Enter
<b>SEARCH</b>	Page Search / Character Search
<b>RETURN</b>	Return

TV

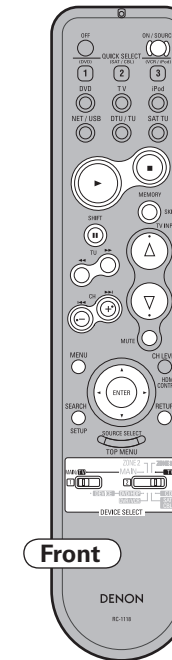

Front

Front	
<b>DEVICE SELECT</b>	
<b>ON/SOURCE</b>	Power on / Standby
<b>▶</b>	Play *
<b>  </b>	Pause *
<b>■</b>	Stop *
<b>◀ ▶</b>	Manual search * (fast-reverse / fast-forward)
<b>CH + -</b>	Switch channels (+, -) *
<b>TV INPUT</b>	Switching the input
<b>VOLUME ▲ ▼</b>	▲ : TV Volume (+) ▼ : TV Volume (-)
<b>MUTE</b>	TV mute
<b>MENU</b>	Calling out the menus
<b>Δ ∇ ◀ ▶</b>	Cursor operation
<b>ENTER</b>	Enter setting
<b>SETUP</b>	Setup
<b>RETURN</b>	Return
Rear	
<b>1 ~ 12</b>	Channels
<b>Default setting (Preset code)</b>	HITACHI (014)
<b>Special Remarks</b>	①

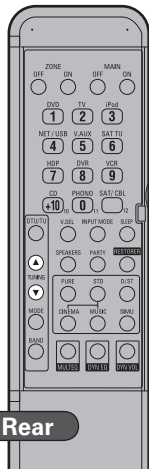

Rear



Rear

**[Special Remarks]**

- ① Only one device can be set in the preset memory for each mode. When a new preset code is registered, the existing code is automatically erased.

\* : When the punch through function (page 90) is set, this functions as the button for the device for which punch through is set.

Operating the Main Remote Control Unit

Blu-ray disc Player / DVD Player

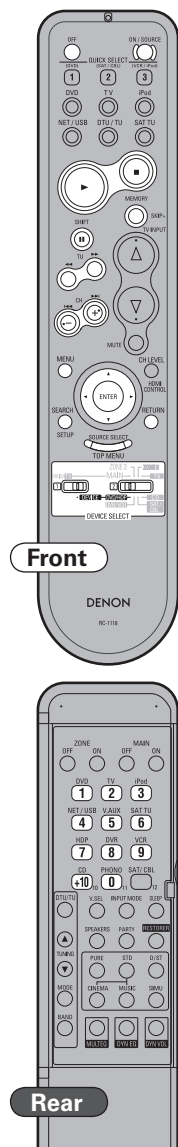

Front		
<b>DEVICE SELECT</b>		
<b>POWER OFF</b>	Power off	
<b>ON/SOURCE</b>	Power on or Power on / Standby	
<b>▶</b>	Play	
<b>■</b>	Stop	
<b>⏸</b>	Pause	
<b>SKIP +</b>	<b>BD Player</b>	<b>DVD Player</b>
	-	Disc skip
<b>◀▶▶▶</b>	Manual search (fast-reverse / fast-forward)	
<b>◀▶▶▶</b>	Auto search (cue)	
<b>MENU</b>	Calling out the menus	
<b>△▽◀▶</b>	Cursor operation	
<b>ENTER</b>	Enter setting	
<b>SETUP</b>	Setup	
<b>RETURN</b>	Return	
<b>SOURCE SELECT / TOP MENU</b>	Calling out the top menus	
Rear		
<b>0 ~ 9, +10</b>	Number input / Track selection	
<b>Default setting (Preset code)</b>	<b>BD Player</b>	<b>DVD Player</b>
	DENON (121)	DENON (111) *
<b>Special Remarks</b>	①, ②	

\* : The initial setting of Preset code is 111 (DVD Player).

Digital Video Recorder (DVR) / Video Deck (VCR)

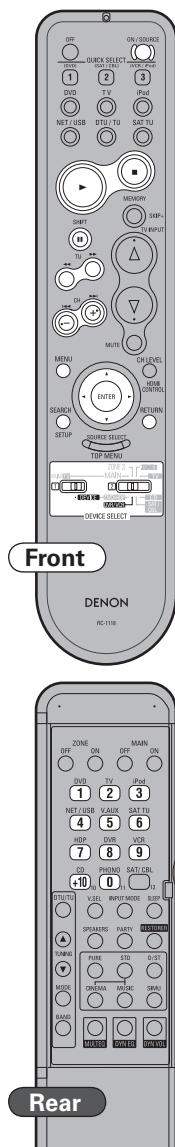

Front	
<b>DEVICE SELECT</b>	
<b>ON/SOURCE</b>	Power on / Standby
<b>▶</b>	Play
<b>■</b>	Stop
<b>⏸</b>	Pause
<b>◀▶▶▶</b>	Manual search (fast-reverse / fast-forward)
<b>CH + -</b>	Switch channels (+, -)
<b>MENU</b>	Calling out the menus
<b>△▽◀▶</b>	Cursor operation
<b>ENTER</b>	Enter setting
<b>SETUP</b>	Setup
<b>RETURN</b>	Return
Rear	
<b>0 ~ 9, +10</b>	Channels
<b>Default setting (Preset code)</b>	HITACHI (008)
<b>Special Remarks</b>	①

Satellite receiver/Cable TV

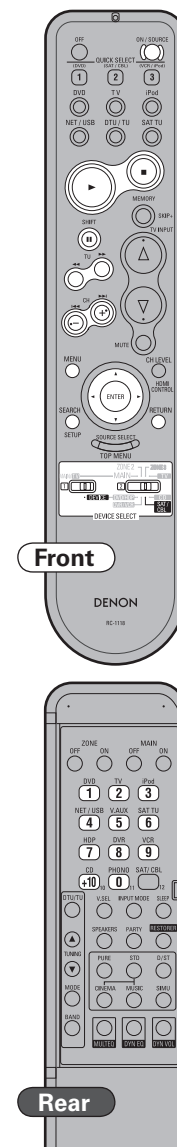

Front		
<b>DEVICE SELECT</b>		
<b>ON/SOURCE</b>	Power on / Standby	
<b>▶</b>	Play *	
<b>⏸</b>	Pause *	
<b>■</b>	Stop *	
<b>◀▶▶▶</b>	Manual search * (fast-reverse / fast-forward)	
<b>CH + -</b>	Switch channels (+, -) *	
<b>△▽◀▶</b>	Cursor operation	
<b>ENTER</b>	Enter setting	
<b>MENU</b>	Calling out the menus	
<b>SETUP</b>	Setup	
<b>RETURN</b>	Return	
Rear		
<b>0 ~ 9, +10</b>	Channels	
<b>Default setting (Preset code)</b>	<b>Satellite Receiver</b>	<b>Cable TV</b>
	-	ABC (009)
<b>Special Remarks</b>	①	

\* : When the punch through function (page 90) is set, this functions as the button for the device for which punch through is set.

[Special Remarks]

- ① Only one device can be set in the preset memory for each mode. When a new preset code is registered, the existing code is automatically erased.
- ② For some brands, the DVD remote control buttons may have different function names. Check beforehand.

CD Player

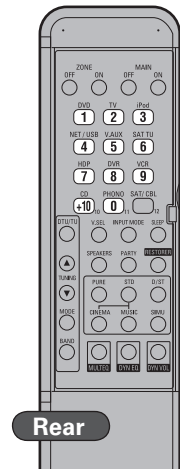
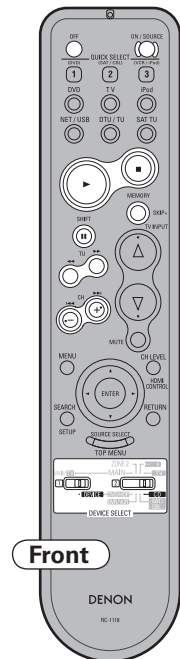

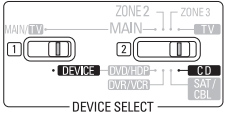
Front	
<b>DEVICE SELECT</b>	
<b>POWER OFF</b>	Power off
<b>ON/SOURCE</b>	Power on or Power on / Standby
	Play
	Stop
	Pause
<b>SKIP +</b>	Disc skip +
	Manual search (fast-reverse / fast-forward)
	Auto search (cue)
Rear	
<b>0 ~ 9, +10</b>	Number input / Track selection
<b>Default setting (Preset code)</b>	DENON (111)
<b>Special Remarks</b>	①

**Assigning buttons that are Not Used to Operate Other Devices (Punch Through Function)**

The Blu-ray disc Player/DVD player, Digital Video recorder, video deck, or CD player can be operated as described below even when [DEVICE SELECT 2] is set to the "SAT/CBL" or "TV" position.

- Play (▶)
- Stop (■)
- Pause (⏸)
- fast-forward (⏩)
- fast-reverse (⏪)
- Auto Search (⏮, ⏭)

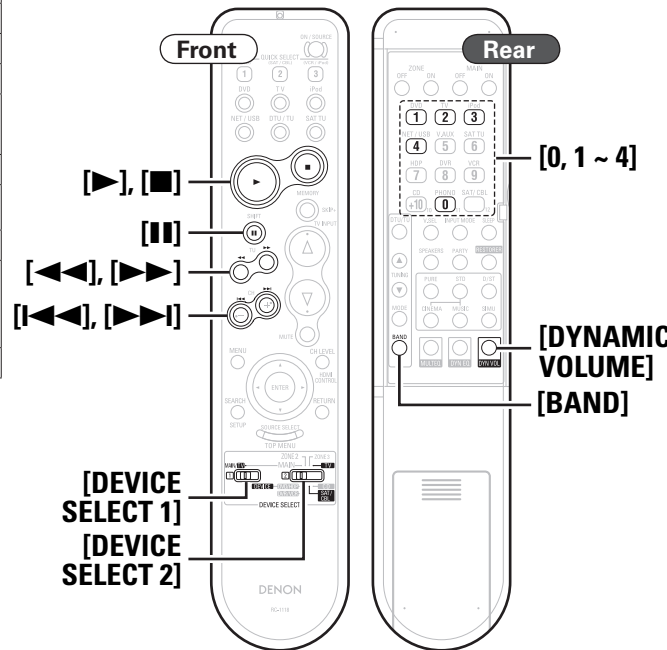

**1** Switch [DEVICE SELECT 1].

- MAIN/TV** : Assigning TV buttons to operate other devices
- DEVICE** : Assigning satellite receiver or cable TV buttons to operate other devices

**2** Switch [DEVICE SELECT 2].

- TV** : Assigning TV buttons to operate other devices
- SAT/CBL** : Assigning satellite receiver or cable TV buttons to operate other devices

**3** Press [BAND] and [DYNAMIC VOLUME] at the same time.

The indicator starts flashing.

**4** Refer to the table below and input the number corresponding to the device to be assigned.

Device to be assigned	Numbers
iPod, HD Radio, SIRIUS, NET/USB	[1]
CD Player	[2]
Blu-ray disc Player / DVD Player	[3]
Digital Video Recorder, Video Deck	[4]
No setting	[0]



This is set to "No setting" upon purchase.

**[Special Remarks]**

- ① Only one device can be set in the preset memory for each mode. When a new preset code is registered, the existing code is automatically erased.

## Operating the Sub Remote Control Unit

- The sub remote control unit is equipped with frequently used buttons, so it can be used for simple remote control unit operations.
- The sub remote control unit can also be used for multi-zone, so you can use it to control the AVR-3310CI from other rooms.
- The operations listed below can be performed with the sub remote control unit.
  - Switching the input source
  - Adjusting the volume
  - SIRIUS, HD Radio and iPod operations
  - NET/USB direct play
  - GUI menu operations
  - Zone power on/off
- It is not possible to operate devices other than the amplifier.



The AVR-3310CI cannot be used in the ZONE4 mode.

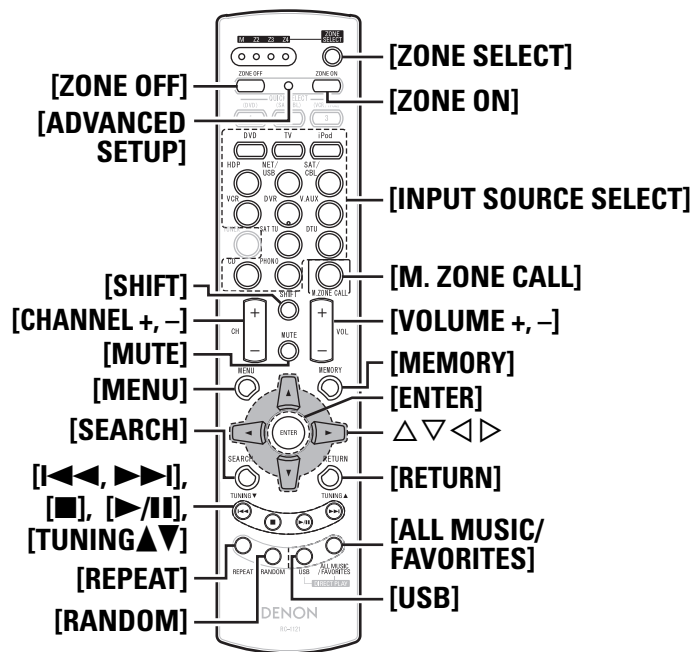

## Functions of Buttons by Component

Device operated	DTU (HD Radio)			SAT TU (SIRIUS)			NET/USB			iPod		
	M	Z2	Z3	M	Z2	Z3	M	Z2	Z3	M	Z2	Z3
<b>ZONE SELECT</b>	Zone operation mode selection											
<b>ZONE OFF</b>	Power turned off (※1)											
<b>ZONE ON</b>	Power turned on (※1)											
<b>INPUT SOURCE SELECT</b>	Input source selection											
<b>CHANNEL + / -</b>	Preset channel selection									-		
<b>SHIFT</b>	Preset channel memory block selection									-		
<b>VOLUME + / -</b>	Adjustment of volume (※1)											
<b>MUTE</b>	Muting (※1)											
<b>MENU</b>	Menu	-		Menu	-		Menu	-		Menu	-	
<b>MEMORY</b>	Preset memory registration									-		
△ ▽ ◀ ▶	Multicast switching (△ ▽) / Cursor			Category search / Cursor			Cursor					
<b>ENTER</b>	-			To Parental Lock password check screen (press and hold)			Enter					
<b>SEARCH</b>	-			-			Page forward screen / Character search			Page forward screen / Browse/Remote mode switching (press and hold)		
<b>RETURN</b>	-			-			Return			Return		
◀▶▶▶, ▶▶▶▶, <b>TUNING ▲ ▼</b>	Tuning			Channel selection			Track search					
■	-			-			Stop					
▶	-			-			Play/pause					
<b>REPEAT</b>	-			-			1-track/All-track repeat play			1-track/All-track repeat play		
<b>RANDOM</b>	-			-			1-track random play			1-track/album shuffle play		
<b>USB</b>	-			-			※2					
<b>ALL MUSIC *</b> (Music server only)	-			-			※3					
<b>FAVORITES *</b>	-			-			※4					

※1: Affects the currently selected zone.

※2: The input source switches to "NET/USB" and the files on the USB memory device are played.

※3: The input source switches to "NET/USB" and the files in "All Music" on the music server are played.

※4: The input source switches to "NET/USB" and the files in "Favorites" are played.

\*: Whether "All Music" or "Favorites" is selected depends on the "Direct Play" setting (page 50).

### DIRECT PLAY button

- Playback is possible in the mode selected at GUI menu "Direct Play".
- FAVORITES**: Playback starts from the first track registered in the favorites.
- ALL MUSIC**: Playback starts from the first track registered in the "All Music" folder.
- When **[USB]** is pressed, playback starts from the first track on the USB memory device.

### NOTE

When the music server is stopped or restarted, it may no longer be possible to play tracks stored in the favorites.

## Switching Zones

Use this procedure to select the zone to be operated by the sub remote control unit.

### 1 Press [ZONE SELECT].

The currently selected multi-zone indicator lights.

### 2 While the multi-zone indicator is light, press [ZONE SELECT] to select the zone to be operated.

The currently selected multi-zone indicator lights.

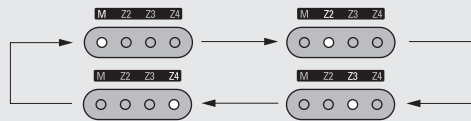

## Switching the Multi-zone Input Source to the Same Input Source as Used in the MAIN ZONE

This function is convenient for example when you want to listen to the same song as the one playing in the MAIN ZONE while in a different zone.

### 1 Press [ZONE SELECT] and set to ZONE2 or ZONE3.

The currently selected multi-zone indicator lights.

### 2 Press [M.ZONE CALL] on the sub remote control unit.

The multi-zone input source switches to the MAIN ZONE's input source.

#### NOTE

- This cannot be used for the MAIN ZONE or ZONE4.
- When [M.ZONE CALL] is pressed while the multi-zone power is off, the multi-zone power turns on and the input source switches to the MAIN ZONE's input source.

## Setting the Zone for Which the Sub Remote Control Unit is Used (ZONE SELECT LOCK Mode)

We recommend always using the sub remote control unit for the same room. When this is done, the unit can be set so that the zone does not switch when buttons are operated.

### 1 Use the tip of a pen to press [ADVANCED SETUP].

All the multi-zone indicators light.

### 2 Select the multi-zone to be set.

The selected multi-zone indicator lights.

- ① To set to "MAIN ZONE" : Press [REPEAT].
- ② To set to "ZONE2" : Press [RANDOM].
- ③ To set to "ZONE3" : Press [USB].
- ④ To set to "ZONE4" : Press [ALL MUSIC/FAVORITES].

### 3 Use the tip of a pen to press [ADVANCED SETUP].

The multi-zone indicator turns off.

#### To Cancel

### 1 Use the tip of a pen to press [ADVANCED SETUP].

The currently selected multi-zone indicator lights.

### 2 Press [ZONE SELECT].

All the multi-zone indicators light.

### 3 Use the tip of a pen to press [ADVANCED SETUP].

The multi-zone indicator turns off.

## Setting the Remote ID

When using multiple DENON AV receivers in the same room, make this setting so that no AV receiver other than the desired one operates.

### 1 While pressing [MENU], press [ADVANCED SETUP] with the tip of a pen.

The multi-zone indicator corresponding to the currently selected remote ID flashes.

### 2 Select the remote ID to be set.

- ① To set to 1 : Press [REPEAT].  
The "M" indicator flashes.
- ② To set to 2 : Press [RANDOM].  
The "Z2" indicator flashes.
- ③ To set to 3 : Press [USB].  
The "Z3" indicator flashes.
- ④ To set to 4 : Press [ALL MUSIC/FAVORITES].  
The "Z4" indicator flashes.

### 3 While pressing [MENU], press [ADVANCED SETUP] with the tip of a pen.

The multi-zone indicator turns off.

#### NOTE

When changing a setting, be sure to set the same remote ID as the AVR-3310CI's (page 43).

## Resetting the Settings

### While pressing [ZONE OFF], press [ADVANCED SETUP] with the tip of a pen.

All the multi-zone indicators flash 4 times, then all the settings are restored to their defaults.

# Other Information

## Explanation of Terms

The AVR-3310CI is equipped with a digital signal processing circuit that lets you play program sources in the surround mode to achieve the same sense of presence as in a movie theater.

### Dolby Digital

#### Dolby Digital

Dolby Digital is a multi-channel digital signal format developed by Dolby Laboratories.

A total of 5.1-channels are played: 3 front channels ("FL", "FR" and "C"), 2 surround channels ("SL" and "SR") and the "LFE" channel for low frequencies.

Because of this, there is no crosstalk between channels and a realistic sound field with a "three-dimensional" feeling (sense of distance, movement and positioning) is achieved.

A real, overpowering sense of presence is achieved when playing movie sources in AV rooms as well.

#### Dolby Digital Plus

Dolby Digital Plus is an improved Dolby Digital signal format that is compatible with up to 7.1-channels of discrete digital sound and also improves sound quality thanks to extra data bit rate performance. It is upwardly compatible with conventional Dolby Digital, so it offers greater flexibility in response to the source signal and the conditions of the playback equipment.

#### Dolby TrueHD

Dolby TrueHD is a high definition audio technology developed by Dolby Laboratories, using lossless coding technology to faithfully reproduce the sound of the studio master.

This format is compatible with a maximum sampling frequency of 96 kHz and up to 7.1-channels, so it is used for applications particularly prioritizing sound quality.

#### Dolby Pro Logic II

Dolby Pro Logic II is a matrix decoding technology developed by Dolby Laboratories.

Regular music such as that on CDs is encoded into 5-channels to achieve an excellent surround effect.

The surround channel signals are converted into stereo and full band signals (with a frequency response of 20 Hz to 20 kHz or greater) to create a "three-dimensional" sound image offering a rich sense of presence for all stereo sources.

#### Dolby Pro Logic IIx

Dolby Pro Logic IIx is a further improved version of the Dolby Pro Logic II matrix decoding technology.

Audio signals recorded in 2-channels are decoded to achieve a natural sound with up to 7.1-channels.

There are 3 modes: "Music" suited for playing music, "Cinema" suited for playing movies, and "Game" which is optimized for playing games.

#### Dolby Digital EX

Dolby Digital EX is a 6.1-channel surround format proposed by Dolby Laboratories that allows users to enjoy in their homes the "DOLBY DIGITAL SURROUND EX" audio format jointly developed by Dolby Laboratories and Lucas Films.

The 6.1 channels of sound, including surround back channels, provide improved sound positioning and expression of space.

#### Dolby Pro Logic IIz

Dolby Pro Logic IIz introduces a new dimension to Home Entertainment through the addition of a pair of front height channels. Compatible with stereo, 5.1 and 7.1 content, Dolby Pro Logic IIz provides enhanced spaciousness, depth and dimension to movies, concert video and video game playback while maintaining the full integrity of the source mix.

Dolby Pro Logic IIz identifies and decodes spatial cues that occur naturally in all content, directing this information to the front height channels, complementing the performance of left and right surround sound speakers. Content that is encoded with Dolby Pro Logic IIz height channel information can be even more revealing, with perceptually discrete height channel information bringing an exciting new dimension to home entertainment.

Dolby Pro Logic IIz, with front height channels is also an ideal alternative for households that cannot support the placement of back surround speakers of a typical 7.1 channel system but may have bookshelf space available to support the addition of height speakers.

Manufactured under license from Dolby Laboratories. "Dolby", "Pro Logic" and the double-D symbol are trademarks of Dolby Laboratories.

### DTS Surround

#### DTS Digital Surround

DTS Digital Surround is the standard digital surround format of DTS, Inc., compatible with a sampling frequency of 44.1 or 48 kHz and up to 5.1-channels of digital discrete surround sound.

#### DTS-HD High Resolution Audio

DTS-HD High Resolution Audio is an improved version of the conventional DTS, DTS-ES and DTS 96/24 signals formats, compatible with sampling frequencies of 96 or 48 kHz and up to 7.1-channels of discrete digital sound. High data bit rate performance provides high quality sound. This format is fully compatible with conventional products, including conventional DTS digital surround 5.1-channel data.

#### DTS-HD Master Audio

DTS-HD Master Audio is DTS, Inc.'s lossless audio format compatible with up to 96 kHz/7.1-channels. The lossless audio coding technology faithfully reproduces the sound of the studio master. It is fully compatible with conventional products, including conventional DTS digital surround 5.1-channel data.

#### DTS-ES™ Discrete 6.1

DTS-ES™ Discrete 6.1 is a 6.1-channel discrete digital audio format adding a surround back (SB) channel to the DTS digital surround sound.

Decoding of conventional 5.1-channel audio signals is also possible according to the decoder.

#### DTS-ES™ Matrix 6.1

DTS-ES™ Matrix 6.1 is a 6.1-channel discrete digital audio format inserting a surround back (SB) channel to the DTS digital surround sound through matrix encoding. Decoding of conventional 5.1-channel audio signals is also possible according to the decoder.

#### DTS NEO:6™ Surround

DTS NEO:6™ is a matrix decoding technology for achieving 6.1-channel surround playback with 2-channel sources. It includes "DTS NEO:6 Cinema" suited for playing movies and "DTS NEO:6 Music" suited for playing music.



## DTS 96/24

DTS 96/24 is a digital audio format enabling high sound quality playback in 5.1-channels with a sampling frequency of 96 kHz and 24 bit quantization on DVD-Video.

## DTS Express

DTS Express is an audio format supporting low bit rates (max. 5.1-channels, 24 to 256 kbps).

Manufactured under license under U.S. Patent #'s: 5,451,942; 5,956,674; 5,974,380; 5,978,762; 6,226,616; 6,487,535; 7,212,872; 7,333,929; 7,392,195; 7,272,567 & other U.S. and worldwide patents issued & pending. DTS is a registered trademark and the DTS logos, Symbol, DTS-HD and DTS-HD Master Audio are trademarks of DTS, Inc. © 1996-2008 DTS, Inc. All Rights Reserved.

## Audyssey

### Audyssey MultEQ®

Audyssey MultEQ is a room equalization solution that calibrates any audio system so that it can achieve optimum performance for every listener in a large listening area. Based on several room measurements, MultEQ calculates an equalization solution that corrects for both time and frequency response problems in the listening area and also performs a fully automated surround system setup.

### Audyssey Dynamic EQ™

Audyssey Dynamic EQ solves the problem of deteriorating sound quality as volume is decreased by taking into account human perception and room acoustics. Audyssey Dynamic EQ works in tandem with Audyssey MultEQ to provide well-balanced sound for every listener at any volume level.

### Audyssey Dynamic Volume™

Audyssey Dynamic Volume solves the problem of large variations in volume level between television programs, commercials, and between the soft and loud passages of movies.

Audyssey Dynamic EQ is integrated into Dynamic Volume so that as the playback volume is adjusted automatically, the perceived bass response, tonal balance, surround impression, and dialog clarity remain the same.



Manufactured under license from Audyssey Laboratories. U.S. and foreign patents pending. Audyssey MultEQ® is a registered trademark of Audyssey Laboratories. Audyssey Dynamic EQ™ is a trademark of Audyssey Laboratories. Audyssey Dynamic Volume™ is a trademark of Audyssey Laboratories.

## AL24 Processing Plus

### AL24 Processing for All Channels

DENON has further developed its proprietary AL24 Processing, an analog waveform reproduction technology, to support the 192 kHz sampling frequency. AL24 Processing Plus, thoroughly suppresses quantization noise associated with D/A conversion of LPCM signals to reproduce the low-level signals with optimum clarity that will bring out all the delicate nuances of the music.

Equipped for not only front left and right channels but also for the surround left and right, center and subwoofer channels.

## About Networks

### Windows Media Player Ver.11

This is a media player distributed free of charge by Microsoft Corporation.

It can be used to play playlists created with Windows Media Player Ver. 11 as well as files in such formats as WMA, DRM WMA, MP3 and WAV.

### vTuner

This is a free online contents server for Internet radio. Note that usage fees are included in upgrade costs.

For inquiries about this service, visit the vTuner site below.  
vTuner website: <http://www.radiodeno.com>

This product is protected by certain intellectual property rights of Nothing Else Matters Software and BridgeCo. Use or distribution of such technology outside of this product is prohibited without a license from Nothing Else Matters Software and BridgeCo or an authorized subsidiary.

### DLNA

- DLNA and DLNA CERTIFIED are trademarks and/or service marks of Digital Living Network Alliance.
- Some contents may not be compatible with other DLNA CERTIFIED™ products.

### Windows Media DRM

A copyright-protected technology developed by Microsoft.

Content providers are using the digital rights management technology for Windows Media contained in this device (WM-DRM) to protect the integrity of their content (Secure Content) so that their intellectual property, including copyright, in such content is not misappropriated. This device uses WM-DRM software to play Secure Content (WM-DRM Software). If the security of the WM-DRM Software in this device has been compromised, owners of Secure Content (Secure Content Owners) may request that Microsoft revoke the WM-DRM Software's right to acquire new licenses to copy, display and/or play Secure Content. Revocation does not alter the WM-DRM Software's ability to play unprotected content. A list of revoked WM-DRM Software is sent to your device whenever you download a license for Secure Content from the Internet or from a PC. Microsoft may, in conjunction with such license, also download revocation list onto your device on behalf of Secure Content Owners.

# Surround

## Surround Modes and Parameters

Surround Mode	Signals and adjustability in the different modes															
	Channel output						Parameter (default values are shown in parentheses)									
	Front L/R	Center	Surround L/R	Surround Back L/R	Subwoofer	Front Height L/R	D. COMP *1	DRC *2	LFE *3	AFDM *1	Surround Back	Cinema EQ.	Mode	Room Size	Effect Level	
PURE DIRECT, DIRECT (2ch)	○	×	×	×	◎*4	×	○ (OFF)	○ (Auto)	○ (0 dB)	×	×	×	×	×	×	
MULTI CH DIRECT	○	◎	◎	◎	◎	◎ (NOTE3)	×	×	○ (0 dB)	○ (ON)	○	×	×	×	×	
STEREO	○	×	×	×	◎	×	○ (OFF)	○ (Auto)	○ (0 dB)	×	×	×	×	×	×	
EXT. IN	○	◎	◎	◎	◎	×	×	×	×	×	×	×	×	×	×	
MULTI CH IN	○	◎	◎	◎	◎	◎ (NOTE3)	×	×	○ (0 dB)	○ (ON)	○	○ (OFF)	×	×	×	
DOLBY PRO LOGIC IIz	○	◎	◎	×	◎	◎	○ (OFF)	○ (Auto)	○ (0 dB)	×	×	○ (OFF)	○ (Height)	×	×	
DOLBY PRO LOGIC IIx	○	◎	◎	◎	◎	×	○ (OFF)	○ (Auto)	×	×	○	○ (NOTE1)	○ (Cinema)	×	×	
DOLBY PRO LOGIC II	○	◎	◎	×	◎	×	○ (OFF)	○ (Auto)	×	×	○	○ (NOTE2)	○ (Cinema)	×	×	
DTS NEO:6	○	◎	◎	◎	◎	×	○ (OFF)	○ (Auto)	×	×	○	○ (NOTE1)	○ (Cinema)	×	×	
DOLBY DIGITAL	○	◎	◎	◎	◎	◎ (NOTE3)	○ (OFF)	×	○ (0 dB)	○ (ON)	○	○ (OFF)	×	×	×	
DOLBY DIGITAL Plus	○	◎	◎	◎	◎	◎ (NOTE3)	○ (OFF)	×	○ (0 dB)	○ (ON)	○	○ (OFF)	×	×	×	
DOLBY TrueHD	○	◎	◎	◎	◎	◎ (NOTE3)	×	○ (Auto)	○ (0 dB)	○ (ON)	○	○ (OFF)	×	×	×	
DTS SURROUND	○	◎	◎	◎	◎	◎ (NOTE3)	○ (OFF)	×	○ (0 dB)	○ (ON)	○	○ (OFF)	×	×	×	
DTS 96/24	○	◎	◎	◎	◎	◎ (NOTE3)	○ (OFF)	×	○ (0 dB)	○ (ON)	○	○ (OFF)	×	×	×	
DTS-HD	○	◎	◎	◎	◎	◎ (NOTE3)	○ (OFF)	×	○ (0 dB)	○ (ON)	○	○ (OFF)	×	×	×	
DTS EXPRESS	○	◎	◎	◎	◎	◎ (NOTE3)	○ (OFF)	×	○ (0 dB)	○ (ON)	○	○ (OFF)	×	×	×	
5CH/7CH STEREO	○	◎	◎	◎	◎	◎ (NOTE3)	○ (OFF)	○ (Auto)	○ (0 dB)	×	○	×	×	×	×	
ROCK ARENA	○	◎	◎	◎	◎	◎ (NOTE3)	○ (OFF)	○ (Auto)	○ (0 dB)	×	○	×	×	○ (Medium)	○ (10)	
JAZZ CLUB	○	◎	◎	◎	◎	◎ (NOTE3)	○ (OFF)	○ (Auto)	○ (0 dB)	×	○	×	×	○ (Medium)	○ (10)	
MONO MOVIE	○	◎	◎	◎	◎	◎ (NOTE3)	○ (OFF)	○ (Auto)	○ (0 dB)	×	○	×	×	○ (Medium)	○ (10)	
VIDEO GAME	○	◎	◎	◎	◎	◎ (NOTE3)	○ (OFF)	○ (Auto)	○ (0 dB)	×	○	×	×	○ (Medium)	○ (10)	
MATRIX	○	◎	◎	◎	◎	◎ (NOTE3)	○ (OFF)	○ (Auto)	○ (0 dB)	×	○	×	×	×	×	
VIRTUAL	○	×	×	×	◎	×	○ (OFF)	○ (Auto)	○ (0 dB)	×	×	×	×	×	×	

○ : Signal / Adjustable

×

◎ : Turned on or off by speaker configuration setting

NOTE1 : This parameter is available when the "Mode" is set to "Cinema" (page 71).

NOTE2 : This parameter is available when the "Mode" is set to "Cinema" or "ProLogic" (page 71).

NOTE3 : This parameter is available when the "Front Height" is set to "ON" (page 72).

### NOTE:

\*1 : When playing Dolby Digital and DTS signals.

\*2 : When playing Dolby TrueHD signal.

\*3 : When playing Dolby Digital, DTS and DVD-Audio.

\*4 : When the "Subwoofer Mode" is set to "LFE+Main" (page 35) only.

Surround Mode	Signals and adjustability in the different modes												
	Parameter (default values are shown in parentheses)												
	Delay Time	Subwoofer	Front Height	PRO LOGIC II/IIx MUSIC mode only			NEO:6 MUSIC mode only	EXT. IN only	Tone Control (NOTE5)	MultEQ	Dynamic EQ (NOTE6)	Dynamic Volume (NOTE7)	RESTORER (NOTE8)
Panorama				Dimension	Center Width	Center Image	Subwoofer Att.						
PURE DIRECT, DIRECT (2ch)	×	○	×	×	×	×	×	×	×	×	×	×	×
MULTI CH DIRECT	×	×	×	×	×	×	×	×	×	×	×	×	×
STEREO	×	×	×	×	×	×	×	×	○ (OFF)	○ (OFF)	○	○	○
EXT. IN	×	×	×	×	×	×	×	○	×	×	×	×	×
MULTI CH IN	×	×	○	×	×	×	×	×	○ (OFF)	○ (OFF)	○	○	×
DOLBY PRO LOGIC IIz	×	×	○	×	×	×	×	×	○ (OFF)	○ (OFF)	○	○	○
DOLBY PRO LOGIC IIx	×	×	○	○ (OFF)	○ (3)	○ (3)	×	×	○ (OFF)	○ (OFF)	○	○	○
DOLBY PRO LOGIC II	×	×	○	○ (OFF)	○ (3)	○ (3)	×	×	○ (OFF)	○ (OFF)	○	○	○
DTS NEO:6	×	×	×	×	×	×	○ (0.3)	×	○ (OFF)	○ (OFF)	○	○	○
DOLBY DIGITAL	×	×	○	×	×	×	×	×	○ (OFF)	○ (OFF)	○	○	×
DOLBY DIGITAL Plus	×	×	○	×	×	×	×	×	○ (OFF)	○ (OFF)	○	○	×
DOLBY TrueHD	×	×	○	×	×	×	×	×	○ (OFF)	○ (OFF)	○	○	×
DTS SURROUND	×	×	○	×	×	×	×	×	○ (OFF)	○ (OFF)	○	○	×
DTS 96/24	×	×	○	×	×	×	×	×	○ (OFF)	○ (OFF)	○	○	×
DTS-HD	×	×	○	×	×	×	×	×	○ (OFF)	○ (OFF)	○	○	×
DTS EXPRESS	×	×	○	×	×	×	×	×	○ (OFF)	○ (OFF)	○	○	×
5CH/7CH STEREO	×	×	×	×	×	×	×	×	○ (OFF)	○ (OFF)	○	○	○
ROCK ARENA	×	×	×	×	×	×	×	×	○ (NOTE4)	○ (OFF)	○	○	○
JAZZ CLUB	×	×	×	×	×	×	×	×	○ (OFF)	○ (OFF)	○	○	○
MONO MOVIE	×	×	×	×	×	×	×	×	○ (OFF)	○ (OFF)	○	○	○
VIDEO GAME	×	×	×	×	×	×	×	×	○ (OFF)	○ (OFF)	○	○	○
MATRIX	○ (30 ms)	×	×	×	×	×	×	×	○ (OFF)	○ (OFF)	○	○	○
VIRTUAL	×	×	×	×	×	×	×	×	○ (OFF)	○ (OFF)	○	○	○

○ : Signal / Adjustable

× : No signal / Not adjustable

NOTE4 : BASS +6 dB, TREBLE +4 dB

NOTE5 : Cannot be set when the "Dynamic EQ" (page 73) setting is "ON".

NOTE6 : Cannot be set when the "MultEQ" (page 73) setting is "OFF".

NOTE7 : Cannot be set when the "Dynamic EQ" (page 73) setting is "OFF".

NOTE8 : "RESTORER" can be set for analog or PCM 48 kHz or 44.1 kHz input signals.

### Differences in Surround Mode Names Depending on the Input Signals

Button	Surround Mode	Note	Input signals																		
			ANALOG	LINEAR PCM / WAV	WMA (Windows Media Audio) / MP3 / MPEG-4 AAC / FLAC	DTS-HD		DTS					DOLBY		DOLBY DIGITAL					MULTI CH PCM	
						DTS-HD Master Audio	DTS-HD High Resolution Audio	DTS EXPRESS	DTS ES DSCRT (With Flag)	DTS ES MTRX (With Flag)	DTS (5.1ch)	DTS 96/24	DOLBY TrueHD	DOLBY DIGITAL Plus	DOLBY DIGITAL EX (With Flag)	DOLBY DIGITAL EX (With no Flag)	DOLBY DIGITAL (5.1/5/4ch)	DOLBY DIGITAL (4/3ch)	DOLBY DIGITAL (2ch)	PCM (multi ch)	PCM (2ch)
STANDARD																					
DTS SURROUND																					
	DTS-HD MSTR		×	×	×	●	×	×	×	×	×	×	×	×	×	×	×	×	×	×	×
	DTS-HD HI RES		×	×	×	×	●	×	×	×	×	×	×	×	×	×	×	×	×	×	×
	DTS ES DSCRT6.1	*1 *3	×	×	×	×	×	×	● ◎	×	×	×	×	×	×	×	×	×	×	×	×
	DTS ES MTRX6.1	*1 *3	×	×	×	×	×	×	×	● ◎	×	×	×	×	×	×	×	×	×	×	×
	DTS SURROUND		×	×	×	×	×	×	○	○	●	×	×	×	×	×	×	×	×	×	×
	DTS 96/24		×	×	×	×	×	×	×	×	×	●	×	×	×	×	×	×	×	×	×
	DTS (-HD) + PLIIx CINEMA	*2 *3	×	×	×	○	○	○	○	○	○	○	×	×	×	×	×	×	×	×	×
	DTS (-HD) + PLIIx MUSIC	*1 *3	×	×	×	○	○	○	○	○	○	○	×	×	×	×	×	×	×	×	×
	DTS (-HD) + PLIIz HEIGHT	*4	×	×	×	○	○	○	○	○	○	○	×	×	×	×	×	×	×	×	×
	DTS EXPRESS		×	×	×	×	×	●	×	×	×	×	×	×	×	×	×	×	×	×	×
	DTS (-HD) + NEO:6	*1 *3	×	×	×	○	○	○	×	○	○	○	×	×	×	×	×	×	×	×	×
	DTS NEO:6 CINEMA		○	○	○	×	×	×	×	×	×	×	×	×	×	×	×	×	○	×	○
	DTS NEO:6 MUSIC		○	○	○	×	×	×	×	×	×	×	×	×	×	×	×	×	○	×	○
DOLBY SURROUND																					
	DOLBY TrueHD		×	×	×	×	×	×	×	×	×	×	●	×	×	×	×	×	×	×	×
	DOLBY DIGITAL+		×	×	×	×	×	×	×	×	×	×	×	●	×	×	×	×	×	×	×
	DOLBY DIGITAL EX	*1 *3	×	×	×	×	×	×	×	×	×	×	×	×	○	○	○	○	×	×	×
	DOLBY (D+) (HD) +EX	*1 *3	×	×	×	×	×	×	×	×	×	×	○	○	×	×	×	×	×	×	×
	DOLBY DIGITAL		×	×	×	×	×	×	×	×	×	×	×	×	○	●	●	●	×	×	×
	DOLBY (D) (D+) (HD) +PLIIx CINEMA	*2 *3	×	×	×	×	×	×	×	×	×	×	○	○	● ◎	○	○	○	○	×	×
	DOLBY (D) (D+) (HD) +PLIIx MUSIC	*1 *3	×	×	×	×	×	×	×	×	×	×	○	○	○	○	○	○	×	×	×
	DOLBY (D) (D+) (HD) +PLIIz HEIGHT	*4	×	×	×	×	×	×	×	×	×	×	○	○	○	○	○	○	×	×	×
	DOLBY PRO LOGIC IIz HEIGHT	*4	○	○	○	×	×	×	×	×	×	×	×	×	×	×	×	×	○	×	○
	DOLBY PRO LOGIC IIx CINEMA	*1 *3	○	○	○	×	×	×	×	×	×	×	×	×	×	×	×	×	○	×	○
	DOLBY PRO LOGIC IIx MUSIC	*1 *3	○	○	○	×	×	×	×	×	×	×	×	×	×	×	×	×	○	×	○
	DOLBY PRO LOGIC IIx GAME	*1 *3	○	○	○	×	×	×	×	×	×	×	×	×	×	×	×	×	○	×	○
	DOLBY PRO LOGIC II CINEMA		○	○	○	×	×	×	×	×	×	×	×	×	×	×	×	×	○	×	○
	DOLBY PRO LOGIC II MUSIC		○	○	○	×	×	×	×	×	×	×	×	×	×	×	×	×	○	×	○
	DOLBY PRO LOGIC II GAME		○	○	○	×	×	×	×	×	×	×	×	×	×	×	×	×	○	×	○
	DOLBY PRO LOGIC		○	○	○	×	×	×	×	×	×	×	×	×	×	×	×	×	○	×	○

**NOTE:**

- \*1: This mode is not available when the surround back speaker setup is set to "None".
- \*2: This mode is not available when the surround back speaker setup is set to "1spkr" or "None".
- \*3: Can be set when "Amp Assign" is set to "Normal".
- \*4: This mode is not available when the front height speaker setup is set to "None".

- : Mode selectable in initial status
- ◎ : Mode fixed when "AFDM" is "ON"
- : Selectable mode
- × : Non-selectable mode

Button	Surround Mode	Note	Input signals																			
			ANALOG	LINEAR PCM / WAV	WMA (Windows Media Audio) / MP3 / MPEG-4 AAC / FLAC	DTS-HD		DTS					DOLBY		DOLBY DIGITAL					MULTI CH PCM		
						DTS-HD Master Audio	DTS-HD High Resolution Audio	DTS EXPRESS	DTS ES DSCRT (With Flag)	DTS ES MTRX (With Flag)	DTS (5.1ch)	DTS 96/24	DOLBY TrueHD	DOLBY DIGITAL Plus	DOLBY DIGITAL EX (With Flag)	DOLBY DIGITAL EX (With no Flag)	DOLBY DIGITAL (5.1/5/4ch)	DOLBY DIGITAL (4/3ch)	DOLBY DIGITAL (2ch)	PCM (multi ch)	PCM (2ch)	
STANDARD																						
MULTI CH IN																						
	MULTI CH IN		×	×	×	×	×	×	×	×	×	×	×	×	×	×	×	×	×	●	×	
	MULTI IN + PLIIx CINEMA	*2 *3	×	×	×	×	×	×	×	×	×	×	×	×	×	×	×	×	×	○	×	
	MULTI IN + PLIIx MUSIC	*1 *3	×	×	×	×	×	×	×	×	×	×	×	×	×	×	×	×	×	○	×	
	MULTI IN + PLIIz HEIGHT	*5	×	×	×	×	×	×	×	×	×	×	×	×	×	×	×	×	×	○	×	
	MULTI IN + DOLBY EX	*1 *3	×	×	×	×	×	×	×	×	×	×	×	×	×	×	×	×	×	○	×	
	MULTI CH IN 7.1	*1 *3	×	×	×	×	×	×	×	×	×	×	×	×	×	×	×	×	×	● ◎ (7.1)	×	
DIRECT																						
	DIRECT		○	○	○	○	○	○	○	○	○	○	○	○	○	○	○	○	○	○	×	○
	MULTI CH DIRECT		×	×	×	×	×	×	×	×	×	×	×	×	×	×	×	×	×	○	×	
	M DIRECT + PLIIx CINEMA	*2 *3	×	×	×	×	×	×	×	×	×	×	×	×	×	×	×	×	×	○	×	
	M DIRECT + PLIIx MUSIC	*1 *3	×	×	×	×	×	×	×	×	×	×	×	×	×	×	×	×	×	○	×	
	M DIRECT + PLIIz HEIGHT	*4	×	×	×	×	×	×	×	×	×	×	×	×	×	×	×	×	×	○	×	
	M DIRECT + DOLBY EX	*1 *3	×	×	×	×	×	×	×	×	×	×	×	×	×	×	×	×	×	○	×	
	M DIRECT 7.1	*1 *3	×	×	×	×	×	×	×	×	×	×	×	×	×	×	×	×	×	○ (7.1)	×	
PURE DIRECT																						
	PURE DIRECT		○	○	○	○	○	○	○	○	○	○	○	○	○	○	○	○	○	○	×	○
	MULTI CH PURE DIRECT		×	×	×	×	×	×	×	×	×	×	×	×	×	×	×	×	×	○	×	
	M PURE D + PLIIx CINEMA	*2 *3	×	×	×	×	×	×	×	×	×	×	×	×	×	×	×	×	×	○	×	
	M PURE D + PLIIx MUSIC	*1 *3	×	×	×	×	×	×	×	×	×	×	×	×	×	×	×	×	×	○	×	
	M PURE D + PLIIz HEIGHT	*4	×	×	×	×	×	×	×	×	×	×	×	×	×	×	×	×	×	○	×	
	M PURE D + DOLBY EX	*1 *3	×	×	×	×	×	×	×	×	×	×	×	×	×	×	×	×	×	○	×	
	M CH PURE DIRECT 7.1	*1 *3	×	×	×	×	×	×	×	×	×	×	×	×	×	×	×	×	×	○ (7.1)	×	
DSP SIMULATION																						
	5CH/7CH STEREO	*5	○	○	○	×	×	×	○	○	○	○	×	×	○	○	○	○	○	○	○	○
	ROCK ARENA		○	○	○	×	×	×	○	○	○	○	×	×	○	○	○	○	○	○	○	○
	JAZZ CLUB		○	○	○	×	×	×	○	○	○	○	×	×	○	○	○	○	○	○	○	○
	MONO MOVIE		○	○	○	×	×	×	○	○	○	○	×	×	○	○	○	○	○	○	○	○
	VIDEO GAME		○	○	○	×	×	×	○	○	○	○	×	×	○	○	○	○	○	○	○	○
	MATRIX		○	○	○	×	×	×	○	○	○	○	×	×	○	○	○	○	○	○	○	○
	VIRTUAL		○	○	○	×	×	×	○	○	○	○	×	×	○	○	○	○	○	○	○	○
STEREO																						
	STEREO		●	●	●	○	○	○	○	○	○	○	○	○	○	○	○	○	○	○	●	●

**NOTE :**

- \*1: This mode is not available when the surround back speaker setup is set to "None".
- \*2: This mode is not available when the surround back speaker setup is set to "1spkr" or "None".
- \*3: Can be set when "Amp Assign" is set to "Normal".
- \*4: This mode is not available when the front height speaker setup is set to "None".
- \*5: If the surround back and front height speaker setup is set to "None", then "5CH STEREO" is displayed.

● : Mode selectable in initial status

○ : Selectable mode

× : Non-selectable mode

# Relationship Between Video Signals and Monitor Output

Video Convert	MAIN ZONE MONITOR OUT											
	Input Signals				Output Signals				GUI menu displayed			
	HDMI	COMPONENT	S-VIDEO	VIDEO	HDMI	COMPONENT	S-VIDEO	VIDEO	HDMI	COMPONENT	S-VIDEO	VIDEO
ON/OFF	×	×	×	×	×	×	×	×	Only the GUI menu is displayed	×	×	×
ON	×	×	×	○	VIDEO	VIDEO	VIDEO	VIDEO	○ (VIDEO)	×	×	×
ON	×	×	○	×	S-VIDEO	S-VIDEO	S-VIDEO	S-VIDEO	○ (S-VIDEO)	×	×	×
ON	×	×	○	×								
ON	×	○ (1080p)	×	×	COMPONENT	COMPONENT	COMPONENT	COMPONENT	○ (COMPONENT)	×	×	×
ON	×	○ (1080i ~ 480p)	×	×								
ON	×	○ (480i/576i)	×	×								
ON	×	○ (1080p)	×	○								
ON * 1	×	○ (1080p)	×	○								
ON	×	○ (1080i ~ 480p)	×	○								
ON	×	○ (480i/576i)	×	○								
ON	×	○ (1080p)	○	×								
ON * 1	×	○ (1080p)	○	×								
ON	×	○ (1080i ~ 480p)	○	×								
ON	×	○ (480i/576i)	○	×								
ON	×	○ (1080p)	○	×								
ON * 1	×	○ (1080p)	○	×								
ON	×	○ (1080i ~ 480p)	○	×								
ON	×	○ (480i/576i)	○	×								
ON	○	×	×	×	HDMI	COMPONENT	COMPONENT	COMPONENT	○ (HDMI)	×	×	×
ON	○	×	×	×								
ON	○	×	○	×								
ON	○	×	○	×								
ON	○	○	×	×								
ON	○	○	×	×								
ON	○	○	○	×								
ON	○	○	○	×								
ON	○	○	○	×								
ON	○	○	○	×								
ON	○	○	○	×								
OFF	×	×	×	×								
OFF	×	×	○	×								
OFF	×	×	○	×								
OFF	×	○	×	×								
OFF	×	○	○	×								
OFF	×	○	○	×								
OFF	○	×	×	×								
OFF	○	×	○	×								
OFF	○	×	○	×								
OFF	○	○	×	×								
OFF	○	○	×	×								
OFF	○	○	○	×								

○ : Video signal input present

×

\* 1 : When no HDMI monitor is connected or the HDMI monitor's power is not on

○ ( ) : Superimposed on the picture indicated in ( ).

×

\* 2 : Only the GUI menu is displayed when no HDMI monitor is connected or the HDMI monitor's power is not on.

\* 3 : When no HDMI monitor is connected or the HDMI monitor's power is "OFF", the GUI menu is superimposed on the picture indicated in ( ).

ZONE2 MONITOR OUT		
INPUT		OUTPUT
S-VIDEO	VIDEO	VIDEO
×	×	×
×	○	VIDEO
○	×	S-VIDEO
○	○	S-VIDEO



- The main zone video conversion function is compatible with the following formats: NTSC, PAL, SECAM, NTSC4.43, PAL-N, PAL-M and PAL-60.
- When SECAM signals of video input are up-converted, the signals are output in PAL format from the S-Video and Video connectors.
- The GUI menu display cannot be superimposed when x.v.Color signals and computer's resolution (e.g. VGA) are input.

# Troubleshooting

If a problem should arise, first check the following:

**1. Are the connections correct?**

**2. Is the set being operated as described in the owner's manual?**

**3. Are the other components operating properly?**

If this unit does not operate properly, check the items listed in the table below. Should the problem persist, there may be a malfunction.

In this case, disconnect the power immediately and contact your store of purchase.

## [General]

Symptom	Cause / Countermeasure	Page
Set does not operate properly.	<ul style="list-style-type: none"> <li>Reset the microprocessor.</li> </ul>	103
Power does not turn on, or turns off directly after it was turned on.	<ul style="list-style-type: none"> <li>Check that the power plugs are securely inserted into the AVR-3310CI's AC inlet and the wall power outlet.</li> </ul>	24
No sound is produced from speakers.	<ul style="list-style-type: none"> <li>Check the connections to the input devices and the speaker cable connections.</li> </ul>	13 ~ 23
	<ul style="list-style-type: none"> <li>Check the connections to the playback devices and select the appropriate input source.</li> </ul>	14 ~ 24, 27
	<ul style="list-style-type: none"> <li>Adjust the master volume to an appropriate level.</li> </ul>	67
	<ul style="list-style-type: none"> <li>Cancel the mute mode.</li> </ul>	67
	<ul style="list-style-type: none"> <li>Disconnect the headphones. No sound is output from the speakers or the PRE OUT terminals when headphones are connected.</li> </ul>	67
Display is off.	<ul style="list-style-type: none"> <li>Select an input source for which the digital input setting has been made.</li> </ul>	46, 47
	<ul style="list-style-type: none"> <li>Match the terminal to which the digital input terminal is assigned with the input mode.</li> </ul>	49
	<ul style="list-style-type: none"> <li>Set the dimmer function to a setting other than "OFF".</li> </ul>	43
"DOLBY DIGITAL" indicator does not appear on display.	<ul style="list-style-type: none"> <li>Cancel the PURE DIRECT mode. The display turns off when in the Pure Direct mode.</li> </ul>	70
	<ul style="list-style-type: none"> <li>Check the Blu-ray Disc player / DVD player's audio output setting. For details, read the Blu-ray Disc player / DVD player's operating instructions.</li> </ul>	-

Symptom	Cause / Countermeasure	Page
Power switches off suddenly while you are using the AVR-3310CI, the power indicator will flash in red at intervals of approximately 2 seconds.	<ul style="list-style-type: none"> <li>The protection circuit will be activated depending upon the temperature rise in the internal parts of the unit. Please switch off power at once, and re-apply the power after the body temperature has fallen sufficiently.</li> <li>Please re-install AVR-3310CI in a place having good ventilation.</li> </ul>	-
Power switches off suddenly while you are using the AVR-3310CI, the power indicator will flash red at intervals of approximately 0.5 seconds.	<ul style="list-style-type: none"> <li>Please use speakers which have the specified impedance.</li> <li>The protection circuit has been activated because the core wires of different speaker cables have touched each other or a core wire has slipped out of the terminal and is touching the AVR-3310CI's rear panel. Unplug the power cord, then after twisting the core wires together tightly again, or effecting termination treatments etc, please reconnect once again.</li> </ul>	13 13
Even applying power, the power display flashes red at intervals of approximately 0.5 seconds.	<ul style="list-style-type: none"> <li>The AVR-3310CI amplifier circuit has failed. Switch off the power and please contact the DENON service adviser.</li> </ul>	-

## [Remote Control Unit]

Symptom	Cause / Countermeasure	Page
Set does not work properly when remote control unit operated.	<ul style="list-style-type: none"> <li>Batteries are worn. Replace with new batteries.</li> </ul>	3
	<ul style="list-style-type: none"> <li>Operate the remote control unit within a distance of about 7 m from the AVR-3310CI and at an angle of within 30°.</li> </ul>	3
	<ul style="list-style-type: none"> <li>Remove the obstacle between the AVR-3310CI and the remote control unit.</li> </ul>	-
	<ul style="list-style-type: none"> <li>Insert the batteries in the proper direction, checking the ⊕ and ⊖ marks.</li> </ul>	3
	<ul style="list-style-type: none"> <li>The set's remote control sensor is exposed to strong light (direct sunlight, inverter type fluorescent bulb light, etc.). Move the set to a place in which the remote control sensor will not be exposed to strong light.</li> </ul>	3
	<ul style="list-style-type: none"> <li>Make sure the remote control IDs of the main unit and remote control unit match.</li> </ul>	43, 92
	<ul style="list-style-type: none"> <li>Set the remote control unit's function button properly.</li> </ul>	7, 8

**[Audio]**

Symptom	Cause / Countermeasure	Page
No sound is produced from center speaker.	<ul style="list-style-type: none"> <li>When playing monaural audio sources, select a surround mode other than "STANDARD" (Dolby/DTS Surround).</li> </ul>	69
No sound is produced from surround speakers.	<ul style="list-style-type: none"> <li>Set the surround mode to a mode for surround playback.</li> </ul>	69, 70
No sound is produced from surround back speaker.	<ul style="list-style-type: none"> <li>Check that the surround back speaker's power amplifier assignment is set to "Normal".</li> </ul>	34
	<ul style="list-style-type: none"> <li>Set the surround back speakers to something other than "None".</li> </ul>	34
	<ul style="list-style-type: none"> <li>Set "Surround Parameter" – "Surround Back" to something other than "OFF".</li> </ul>	72
No sound is produced from subwoofer.	<ul style="list-style-type: none"> <li>Set the surround mode to the surround playback mode.</li> </ul>	69, 70
	<ul style="list-style-type: none"> <li>Turn on the subwoofer's power.</li> <li>Set the subwoofer to "Yes".</li> <li>Check the subwoofer connections.</li> <li>Increase the subwoofer's channel level.</li> </ul>	– 34 13 35
DTS sound is not output.	<ul style="list-style-type: none"> <li>Set the Blu-ray disc/DVD player's audio output setting to "Bit-stream". For details, refer to the Blu-ray disc/DVD player's operating instructions.</li> </ul>	–
	<ul style="list-style-type: none"> <li>Use a DTS-compatible Blu-ray disc player/DVD player.</li> <li>Set the decode mode to "Auto" or "DTS".</li> </ul>	– 49
Dolby TrueHD, DTS-HD, Dolby Digital Plus audio is not output.	<ul style="list-style-type: none"> <li>Make HDMI connections.</li> </ul>	14
	<ul style="list-style-type: none"> <li>Set the Blu-ray disc/DVD player's audio output setting to "Bit-stream". For details, refer to the Blu-ray disc/DVD player's operating instructions.</li> <li>Use a DTS-compatible Blu-ray disc player.</li> </ul>	– –

**[Control dock for iPod]**

Symptom	Cause / Countermeasure	Page
iPod cannot be played.	<ul style="list-style-type: none"> <li>Connect to the terminal to which "iPod dock" was assigned and switch the input source.</li> </ul>	24, 47
	<ul style="list-style-type: none"> <li>Check the iPod connections.</li> <li>Plug the control dock for iPod's AC adapter into a power outlet. Communications with the AVR-3310CI are not possible unless the AC adapter is plugged in.</li> </ul>	16 –

**[Video]**

Symptom	Cause / Countermeasure	Page
No picture appears.	<ul style="list-style-type: none"> <li>Check the connections of the AVR-3310CI's video output terminals and the TV's input terminals.</li> </ul>	14, 15
	<ul style="list-style-type: none"> <li>Make the proper input setting for the input terminals of the TV connected to the AVR-3310CI.</li> </ul>	–
	<ul style="list-style-type: none"> <li>Cancel the PURE DIRECT mode.</li> </ul>	70
	<ul style="list-style-type: none"> <li>High definition (1080i/720p) and progressive (480p/576p) video signals are not down-converted. Set the player to interlace (480i/576i) signals.</li> <li>Check the "Video Select" setting.</li> </ul>	– 48
Picture cannot be recorded.	<ul style="list-style-type: none"> <li>The REC OUT video terminal does not have a video conversion function, so use a video cable to input video signals, an S-Video cable to input S-Video signals.</li> </ul>	18
DVDs cannot be copied on a VCR.	<ul style="list-style-type: none"> <li>This is not a malfunction. Most movie software includes copy prevention signals and cannot be copied.</li> </ul>	–
GUI is not displayed.	<ul style="list-style-type: none"> <li>Set "Format" according to the format (NTSC or PAL) of the TV being used.</li> </ul>	42

**[HDMI]**

Symptom	Cause / Countermeasure	Page
HDMI audio signals are not output from speakers.	<ul style="list-style-type: none"> <li>Set "Audio Out" to "AMP" to output HDMI audio signals from the speakers.</li> </ul>	36
No picture appears with HDMI connections.	<ul style="list-style-type: none"> <li>Check the connection of the HDMI connectors.</li> </ul>	14
	<ul style="list-style-type: none"> <li>Select the input source assigned to the HDMI terminal at "HDMI".</li> </ul>	27, 46
	<ul style="list-style-type: none"> <li>Connect a monitor that is compatible with copyright protection (HDCP).</li> <li>Check that the output format (HDMI FORMAT) of the connected player, etc., matches the TV's compatible input formats.</li> </ul>	14 14, 15
No sound is output from the monitor connected with HDMI connections.	<ul style="list-style-type: none"> <li>Set "Audio Out" to "TV" to output HDMI audio signals from the TV.</li> </ul>	36
When performing the following operations on a connected device, AVR-3310CI has the same operations.	<ul style="list-style-type: none"> <li>Set "HDMI Control" to "OFF". When you only want to operate the power on/off each device, set "Power Off Control" to "OFF".</li> </ul>	36
<ul style="list-style-type: none"> <li>Power ON/OFF</li> <li>Switching audio output devices</li> <li>Adjust volume</li> <li>Switch input source</li> </ul>		



**[NET/USB / Rhapsody/ Napster]**

Symptom	Cause / Countermeasure	Page
When a USB memory device is connected, "USB" is not displayed on the GUI menu.	• The set cannot recognize a USB memory device. Check the connection.	21
	• A USB memory device not conforming to mass storage class or MTP standards is connected. Connect a USB memory device conforming to mass storage class or MTP standards.	-
	• A USB memory device that the set cannot recognize is connected. This is not a malfunction. DENON does not guarantee that all USB memory devices will operate or receive power.	-
	• USB memory device is connected via USB hub. Connect the USB memory device directly to the USB port.	-
Files on a USB memory device cannot be played.	• USB memory device is in format other than FAT16 or FAT32. Set the format to FAT16 or FAT32. For details, refer to the USB memory device's operating instructions.	-
	• USB memory device is divided into multiple partitions. When divided into multiple partitions, only files stored in the top partition can be played.	-
	• Files are stored in a non-compatible format. Record the files in a compatible format.	58, 59
	• You are attempting to play a file that is copyright protected. Files that are copyright protected cannot be played on this set.	59
The file names are not displayed properly (".,." etc.).	• Characters that cannot be displayed are used. This is not a malfunction. On this set, characters that cannot be displayed are replaced with a ". (period)".	-
Internet radio cannot be played.	• Ethernet cable is not properly connected or network is disconnected. Check the connection status.	23
	• Program is being broadcast in non-compatible format. Only Internet radio programs in MP3 and WMA can be played on this set.	58, 59
	• The computer's or router's firewall is activated. Check the computer's or router's firewall settings.	-
	• Radio station is not currently broadcasting. Choose a radio station that is currently broadcasting.	60, 61
Files stored on a computer cannot be played.	• IP address is wrong. Check the set's IP address.	40
	• Files are stored in a non-compatible format. Record in a compatible format.	58, 59
	• You are attempting to play a file that is copyright protected. Files that are copyright protected cannot be played on this set.	59
	• Set and computer are connected by USB cable. The set's USB port cannot be used for connection to a computer.	-

Symptom	Cause / Countermeasure	Page
Server is not found, or it is not possible to connect to the server.	• The computer's or router's firewall is activated. Check the computer's or router's firewall settings.	-
	• Computer's power is not turned on. Turn on the power.	-
	• Server is not running. Launch the server.	-
	• Set's IP address is wrong. Check the set's IP address.	40
Cannot connect to preset or favorite radio stations.	• Radio station is not currently broadcasting. Wait a while before trying again.	-
	• Radio station is not currently in service. It is not possible to connect to radio stations that are no longer in service.	-
For some radio stations, "Server Full" or "Connection Down" is displayed and station cannot be connected to.	• Station is congested or not currently broadcasting. Wait a while before trying again.	-
Sound is broken during playback.	• Network's signal transfer speed is slow or communications lines or radio station is congested. This is not a malfunction. When playing broadcast data with a high bit rate, the sound may be broken, depending on the communications conditions.	-
Sound quality is poor or played sound is noisy.	• File being played has a low bit rate. This is not a malfunction.	-
Cannot login to Rhapsody. ("Incorrect Username or Password" is displayed.)	• Login information is incorrect. Check if the Username for Rhapsody has been properly entered. Re-enter the Password. (Password is not displayed.) <a href="http://www.rhapsody.com/denon">www.rhapsody.com/denon</a>	40
Cannot compile Playlist.	• The AVR-3310CI does not respond to playlist compilation. When the playlist is compiled in PC Application, it is registered to "My Library". In this way, the playlist can be played in AVR-3310CI.	-
Cannot delete Rhapsody Channel registered in "My Channels".	• Cannot be done with AVR-3310CI. Delete from PC Application.	-
Cannot delete Tracks, Playlists, Channels registered in "My Library".	• Cannot be done with AVR-3310CI. Delete from PC Application.	-
Cannot login to Napster. ("Incorrect Username or Password" is displayed.)	• Login information is incorrect. Check if the Username for Napster has been properly entered. Re-enter the Password. (Password is not displayed.) <a href="http://www.napster.com/choose/index_default.html">http://www.napster.com/choose/index_default.html</a>	40

**[SIRIUS Satellite Radio]**

Symptom	Cause / Countermeasure	Page
"CHECK SIRIUS TUNER" is displayed.	• The SiriusConnect Home Tuner unit is not connected. Check that the connections are correct.	19
"ANTENNA ERROR" is displayed.	• The antenna is not connected. Check that the connections are correct.	19
"NO SIGNAL" is displayed.	• The signal cannot be received. Reposition the antenna.	-
"INVALID CHANNEL" is displayed.	• Channel is not present. Select another channel.	-
"ACQUIRING SIGNAL" is displayed.	• The signal cannot be received. Reposition your SiriusConnect Home Tuner and Home Dock antenna.	-
	• Displays while SiriusConnect Home Tuner is connected. Reposition your SiriusConnect Home Tuner and Home Dock antenna.	-
"Call SIRIUS" * is displayed.	• Channels are not subscribed to. If you subscribe to the channel, you can receive the channel.	-
"SUBSCRIPTION UPDATED" is displayed.	• While updating contract information.	-
"Enter Lock Code [ ]" is displayed.	• Selected channels are locked. Please insert pass word (4 digits) into "[ ]".	-

\*: After scroll displays "Call 888-539-....." twice, displays "Call SIRIUS".

## Restoring All the Settings to as They were at the Time of Purchase (Resetting the Microprocessor)

Perform this procedure if the display is abnormal or if operations cannot be performed. When the microprocessor is reset, all the settings are reset to their default values.

- 1** Turn off the power using <POWER>.
- 2** Press <POWER> while simultaneously pressing <STANDARD> and <DSP SIMULATION>.
- 3** Once the display starts flashing at intervals of about 1 second, release the two buttons.



If in step 3 the display does not flash at intervals of about 1 second, start over from step 1.

# Specifications

## Audio section

### Power amplifier

#### Rated output:

Front:  
130 W + 130 W (8 Ω/ohms, 20 Hz ~ 20 kHz with 0.05 % T.H.D.)  
170 W + 170 W (6 Ω/ohms, 1 kHz with 0.7 % T.H.D.)

Center:  
130 W (8 Ω/ohms, 20 Hz ~ 20 kHz with 0.05 % T.H.D.)  
170 W (6 Ω/ohms, 1 kHz with 0.7 % T.H.D.)

Surround (A + B):  
130 W + 130 W (8 Ω/ohms, 20 Hz ~ 20 kHz with 0.05 % T.H.D.)  
170 W + 170 W (6 Ω/ohms, 1 kHz with 0.7 % T.H.D.)

Surround back:  
130 W + 130 W (8 Ω/ohms, 20 Hz ~ 20 kHz with 0.05 % T.H.D.)  
170 W + 170 W (6 Ω/ohms, 1 kHz with 0.7 % T.H.D.)

#### Dynamic power:

140 W x 2ch (8 Ω/ohms)

210 W x 2ch (4 Ω/ohms)

#### Output connectors:

Center, Surround, Surround back 6 ~ 16 Ω/ohms  
Front: A or B 6 ~ 16 Ω/ohms  
A + B 8 ~ 16 Ω/ohms

### Analog

**Input sensitivity / Input impedance:** 200 mV / 12 kΩ/kohms (except for EXT. IN (SV, S, SB), CD, PHONO, V. AUX)  
200 mV / 47 kΩ/kohms (EXT. IN (SV, S, SB), CD, PHONO, V. AUX)

**Frequency response:** 10 Hz ~ 100 kHz +1, -3 dB (DIRECT mode)

**S/N:** 102 dB (IHF-A weighted, DIRECT mode)

**Distortion:** 0.005 % (20 Hz ~ 20 kHz) (DIRECT mode)

**Rated output:** 1.2 V

### Digital

#### D/A output:

Rated output — 2 V (at 0 dB playback)  
Total harmonic distortion — 0.008 % (1 kHz, at 0 dB)  
S/N ratio — 102 dB  
Dynamic range — 100 dB  
Format — Digital audio interface

#### Digital input:

### Phono equalizer (PHONO input — REC OUT)

**Input sensitivity:** 2.5 mV

**RIAA deviation:** ±1 dB (20 Hz to 20 kHz)

**S/N:** 74 dB (A weighting, with 5 mV input)

**Rated output:** 150 mV

**Distortion factor:** 0.03 % (1 kHz, 3 V)

## Video section

### Standard video connectors

**Input / output level and impedance:** 1 Vp-p, 75 Ω/ohms  
**Frequency response:** 5 Hz ~ 10 MHz — +0, -3 dB (when video convert set to "OFF")

### S-Video connectors

**Input / output level and impedance:** Y (brightness) signal — 1 Vp-p, 75 Ω/ohms  
C (color) signal — 0.286 Vp-p, 75 Ω/ohms  
**Frequency response:** 5 Hz ~ 10 MHz — +0, -3 dB (when video convert set to "OFF")

### Color component video connector

**Input / output level and impedance:** Y (brightness) signal — 1 Vp-p, 75 Ω/ohms  
P<sub>B</sub> / C<sub>B</sub> signal — 0.7 Vp-p, 75 Ω/ohms  
P<sub>R</sub> / C<sub>R</sub> signal — 0.7 Vp-p, 75 Ω/ohms  
**Frequency response:** 5 Hz ~ 100 MHz — +0, -3 dB (when video convert set to "OFF")

## HD Radio section

### [FM]

### [AM]

(note: μV at 75 Ω/ohms, 0 dBf = 1 × 10<sup>-15</sup> W)

<b>Receiving Range:</b>	87.5 MHz ~ 107.9 MHz	530 kHz ~ 1710 kHz
<b>Usable Sensitivity:</b>	1.5 μV (14.8 dBf)	20 μV
<b>S/N (IHF-A):</b>	MONO 78 dB	
	STEREO 68 dB	
	HD 85 dB	85 dB
<b>Total harmonic Distortion (at 1 kHz):</b>	MONO 0.1 %	
	STEREO 0.2 %	
	HD 0.02 %	0.02 %

## General

**Power supply:** AC 120 V, 60 Hz

**Power consumption:** 7.0 A

0.1 W (Standby)

**Maximum external dimensions:** 434 (W) x 171 (H) x 414 (D) mm (17-3/32" x 6-47/64" x 16-19/64")

**Weight:** 12.9 kg (28 lbs 7 oz)

## Main remote control unit (RC-1118)

**Batteries:** R6/AA Type (two batteries)

**Maximum external dimensions:** 52 (W) x 243 (H) x 21 (D) mm (2-3/64" x 9-9/16" x 53/64")

**Weight:** 184 g (Approx 6.5 oz) (including batteries)

## Sub remote control unit (RC-1121)

**Batteries:** R03/AAA Type (two batteries)

**Maximum external dimensions:** 49 (W) x 220 (H) x 24.5 (D) mm (1-59/64" x 8-21/32" x 31/32")

**Weight:** 114 g (Approx 4 oz) (including batteries)

※ For purposes of improvement, specifications and design are subject to change without notice.

List of preset codes / Liste de codes pré-réglés

**DEVICE SELECT : TV**

**Television**

<b>A</b>	3M	100
	Addison	163
	Admiral	033, 044, 050, 141
	Advent	130
	Adventura	041
	Aiko	138
	Akai	018, 019, 034, 119, 137, 151
	Albatron	127, 131
	Alleron	039
	America Action	139
	Ampro	129
	Amtron	038
	Anam	139
	Anam National	035, 038
	AOC	030, 036, 079, 137, 151, 154
	Apex	048, 062
	Apex Digital	174
	Audiovox	038, 067, 071, 138, 139, 140
	Aventura	029
<b>B</b>	Axion	120
	Bang & Olufsen	146
	Barco	020
	Baur	034
	Belcor	030
	Bell & Howell	033
	Benq	089, 135
	Blue Sky	020
	Bradford	038, 139
	Brilliant	145
	Brockwood	030
	Broksonic	050, 139, 141
	by:sign	123
<b>C</b>	Candle	037, 041, 137, 151
	Carnivale	137, 151
	Carver	155
	CCE	147, 152
	Celebrity	034
	Celera	048
	Changhong	048
	Ching Tai	163
	Chun Yun	157, 163, 169, 173
	Chung Hsin	160, 169
	Citizen	037, 038, 049, 137, 138, 151, 153, 156
	Clarion	139
	Coby	074

	Contec	139
	Contec/Cony	038
	Craig	038, 139
	Crosley	049, 155
	Crown	038, 139, 153
	CTX	082
	Curtis Mathes	010, 019, 044, 137, 140, 143, 151, 153, 155, 156
	CXC	038, 139
	Cytron	118
<b>D</b>	Daewoo	030, 036, 049, 138, 140, 153
	Daytron	030
	Dell	012, 032
	Denon	143
	DiamondVision	125
	Dimensia	010
	Disney	060
	Dumont	013, 030
	Durabrand	012, 029, 050, 111, 136, 139, 141
	Dwin	044, 128
<b>E</b>	Electroband	034
	Electrograph	142
	Electrohome	034, 035, 050
	Element	106
	Emerson	012, 029, 030, 038, 039, 049, 050, 139, 141, 153
	Emprex	124
	Envision	137, 151
	Epson	080, 097
	Erres	149
	ESA	018, 029
	Ether	158
<b>F</b>	Firststar	170
	Fujitsu	037, 039, 077
	Funai	029, 038, 039, 139
	Furi	165
	Futuretech	038, 139
<b>G</b>	Gateway	085, 142, 144
	GE	010, 012, 035, 040, 045, 055, 140
	GFM	027, 028
	Gibraltar	013, 030, 137, 151
	Go Video	134
	Goldstar	012, 030, 036, 137, 151
	Gradiente	084
	Grundig	152
	Grunpy	038, 039, 139
<b>H</b>	Haier	107, 114, 136, 148
	Hallmark	012
	Hankook	158, 168, 169
	Harman/Kardon	155

	Harvard	038, 139
	Havermy	044
	Hello Kitty	140
	Hewlett Packard	068
	Hisense	087, 167, 174
	Hitachi	[014]*, 058, 103, 143, 181
	HP	031
	Hyundai	133
<b>I</b>	Ilo	090, 115, 117, 122
	IMA	038
	Infinity	155
	InFocus	099
	Initial	117
	Innova	152
	Insignia	029, 108, 109, 110
<b>J</b>	Janeil	041
	JBL	155
	JC Penney	010, 036, 037, 040
	JCB	034
	Jean	159, 163, 167, 170
	Jinxiang	161, 165, 167
	JVC	023, 024, 025, 040, 050
<b>K</b>	Kawasho	034
	Kaypani	154
	KEC	139
	Kenwood	030, 137, 151
	Kioto	020, 155
	KLH	048
	Kloss Novabeam	038, 041
	Kolin	166, 169
	KTV	038, 137, 139, 147, 151, 153
<b>L</b>	LG	012, 030, 036, 127, 151
	Logik	033
	LXI	010, 012, 155
<b>M</b>	M & S	155
	Magnasonic	049
	Magnavox	028, 037, 047, 054, 056, 137, 151, 155
	Majestic	033
	Marantz	046, 137, 151, 152, 155
	Maxent	112, 142
	Mediator	149
	Megapower	127
	Megatron	012, 143
	Memorex	012, 029, 033, 036, 050, 141
	MGA	012, 030, 036, 137, 151
	Megatron	013, 040, 153
	Mintek	117
	Mitsubishi	012, 030, 036, 044, 057, 178
	Monivision	127, 131

	Montgomery Ward	033
	Motorola	035, 044
	MTC	030, 036, 137, 151, 156
	Multitech	038, 139, 147
<b>N</b>	NAD	012, 152
	NEC	030, 035, 036, 081, 137, 151
	Netsat	152
	Net-TV	090, 142
	Newave	163, 164, 168
	Nikko	012, 137, 138, 151
	Norcent	079, 174
	Norwood Micro	090
	Noshi	150
	NTC	138
<b>O</b>	Olevia	064, 072, 078
	Orwa	038, 139
	Oppo	121
	Optoma	098
	Optonica	044
	Orion	050, 141
	Otto Versand	034
<b>P</b>	Panasonic	007, 008, 009, 035, 040, 059, 069, 176
	Penney	012, 030, 137, 150, 151, 153, 156
	Philco	030, 035, 036, 037, 050, 137, 151, 155
	Philips	020, 021, 022, 035, 037, 046, 066, 105, 149, 152, 155
	Philips Magnavox	020, 046, 047
	Phonola	149
	Pilot	030, 137, 151, 153
	Pioneer	180, 184
	Polaroid	030, 048, 075
	Portland	030, 036, 138, 153
	Prima	083, 130
	Princeton	127
	Prism	040
	Proscan	010
	Proton	012, 154
	Protron	073
	Proview	086, 106
	Pulsar	013, 030
	Pye	149
<b>Q</b>	Quasar	035, 040
	Quelle	034
<b>R</b>	Radio Shack/Realistic	010, 038
	Radiola	149
	RadioShack	012, 030, 137, 139, 151, 153
	RCA	010, 011, 030, 035, 036, 043, 045, 150, 156
	Realistic	012, 030, 137, 139, 151, 153

<b>S</b>	Runco	013, 137, 151
	Sampo	137, 142, 151, 153, 154
	Samsung	012, 018, 019, 030, 036, 101, 102, 137, 147, 151, 152, 156
	Samsux	153
	Sansui	050, 141
	Sanyo	092
	SBR	149
	Sceptre	096
	Scimitsu	030
	Scotch	012
	Norwood Micro	012, 030, 038, 039, 116, 139
	Scott	010, 012, 029, 039, 088, 155
	Sears	010, 012, 029, 039, 088, 155
	SEI	034
	Sharp	015, 016, 017, 044, 070, 153, 179, 183
	Shen Ying	163
	Sheng Chia	044, 164
	Shogun	030
	Signature	033
	Simpson	037
	Sinudyne	034
	SKY	152
	Skygiant	169
	Sony	000, 001, 002, 034, 052, 053, 175, 182
	Soundesign	012, 037, 038, 039, 139
	Sova	073
	Sowa	162, 167
	Squareview	029
	SSS	030, 038, 139
	Starlite	038, 139
	Studio Experience	131
	Superscan	044
	Supre-Macy	041
	Supreme	034
	SVA	020, 113, 148, 174
	Sylvania	026, 027, 028, 029, 037, 063, 104, 137, 151, 155
	Symphonic	029, 038, 139
	Synco	157, 162, 163, 164, 168, 172
	Syntax	072
	Syntax-Brilliant	072, 088
<b>T</b>	Tacico	163, 168
	Tandy	044
	Tatung	035, 090, 144, 159, 162, 167
	Technics	040
	Techview	132
	Techwood	040
	Teco	159, 164, 168
	Teknika	030, 033, 036, 037, 038, 039, 138, 139, 153, 155, 156

Telefunken	019
TMK	012
Toshiba	003, 004, 005, 006, 030, 051, 156, 177
Totevision	153
Trutech	091
Tuntex	158, 163
TVS	050, 141

<b>U</b> US Logic	090
<b>V</b> Vector Research	137, 151
Vidikron	155
Vidtech	012, 030, 036
Viewsonic	061, 076, 142
Viking	041
Viore	115
Vizio	061, 093, 094, 095, 126, 144

<b>W</b> Wards	010, 012, 030, 033, 036, 039, 137, 151, 155
Westinghouse	061, 065, 140
White Westinghouse	049, 050, 141
<b>Y</b> Yamaha	030, 036, 137, 151
Yapshe	171
<b>Z</b> Zenith	012, 013, 014, 030, 033, 042, 050, 138, 141

### TV/VCR Combination

<b>R</b> RCA	011
<b>S</b> Sylvania	026

### TV/DVD Combination

<b>A</b> Akai	119
Apex	062
Axion	120
<b>C</b> Coby	074
Cytron	118
<b>D</b> DiamondVision	125
Disney	060
<b>G</b> GFM	028
<b>H</b> Haier	114
<b>I</b> Ilo	117
Initial	117
Insignia	108
<b>L</b> LG	030
<b>M</b> Mintek	117
<b>O</b> Oppo	121
<b>P</b> Panasonic	069
Philips	066
Polaroid	075
<b>R</b> RCA	010
<b>S</b> Sansui	051
Sharp	070
Sylvania	027, 063

<b>T</b> Toshiba	005, 051
<b>W</b> Westinghouse	065

### TV/DVD/VCR Combination

<b>M</b> Magnavox	028
<b>P</b> Panasonic	059
<b>T</b> Toshiba	006

## DEVICE SELECT : DVD/HDP

### Blu-ray Disc Player

<b>D</b> Denon	121
----------------	-----

### DVD Player

<b>A</b> Accele Vision	088
Accurian	146
Advent	131
Akai	098, 126
Alco	129
Allegro	142
Amphion MediaWorks	117
AMW	117
Apex	025, 026, 027, 028, 049, 059, 136
Apple	109
Argo	043
Aspire	132
Astar	090
Audiovox	075, 129
Axion	099
<b>B</b> Bang & Olufsen	137
Blaupunkt	136
Blue Parade	039
BOSS	089
Broksonic	061, 126
<b>C</b> California Audio Labs	128
Changhong	071, 153
CineVision	074, 142
Coby	050, 081
Curtis Mathes	143
CyberHome	029, 043, 151, 152, 155, 156
Cytron	097
<b>D</b> Daewoo	057, 142
Denon	014, 070, [111]*, 112, 128
Desay	116
DiamondVision	124, 125
Disney	053, 063
Durabrand	144
<b>E</b> Emerson	127, 138, 145

Enterprise	138
Epson	120
ESA	145
<b>F</b> Fisher	139
Funai	145

<b>G</b> Gateway	068, 154
GE	044, 054, 136
GFM	101
Go Video	012, 142
Gradiente	128
Greenhill	136

<b>H</b> Haier	103
Harman/Kardon	082, 140
Hitachi	013
Hiteker	025

<b>I</b> Ilo	096
Initial	096, 136
Insignia	055, 102, 145
Integra	039
Irradio	091
iSymphony	108

<b>J</b> JBL	140
JVC	030, 031, 032, 033, 034

<b>K</b> Kawasaki	129
Kenwood	080, 128
KLH	058, 129, 136
Koss	067, 134

<b>L</b> Landel	147
Lasonic	141
Lenoxx	133, 144
LG	055, 076, 077, 095, 138, 142
Liquid Video	134
Liteon	068, 146

<b>M</b> Magnavox	047, 062, 127, 135, 145
Memorex	053, 126
Microsoft	044
Mintek	096, 136
Mitsubishi	056

<b>N</b> Nesa	136
Next Base	147
Nexstech	115

<b>O</b> Onkyo	071, 135
Oppo	100, 114
Optoma	122
Oritron	067, 134

<b>P</b> Panasonic	017, 018, 019, 020, 021, 022, 023, 024, 078, 083, 084, 085, 128, 135
Philips	007, 037, 038, 047, 052, 064, 073, 104, 135
Pioneer	039, 040, 041, 042, 087
Polaroid	028, 086
Proceed	025
Proscan	044

Protron	119
<b>Q</b> Qwestar	067
<b>R</b> RCA	035, 036, 039, 044, 129, 136
Regent	133
Rio	142

Rowa	130
<b>S</b> Sampo	148, 150
Samsung	011, 012, 013, 015, 016, 048, 128
Sansui	008, 126
Sanyo	126, 139
Sharp	051, 060, 079, 092, 093, 094
Shinsonic	096
Sonic Blue	142

Sony	000, 001, 002, 003, 004, 005, 006, 045, 065, 066, 105, 106, 107
Sungale	113
Superscan	127
Sylvania	046, 101, 123, 127, 145
Symphonic	038

<b>T</b> Teac	129, 149, 157, 158
Technics	128
Theta Digital	039

Toshiba	007, 008, 009, 010, 069, 126, 135
Trutech	110

<b>U</b> Urban Concepts	135
US Logic	096

<b>V</b> Venturer	129
VocoStar	118

<b>W</b> Westinghouse	072
<b>X</b> Xbox	044

<b>Y</b> Yamaha	017, 128
<b>Z</b> Zenith	055, 135, 138, 142

### DVD/VCR Combination

<b>B</b> Broksonic	061
<b>C</b> CineVision	074
<b>G</b> Go Video	012
<b>I</b> Insignia	055
<b>P</b> Panasonic	018, 019, 020
<b>S</b> Samsung	012, 048
Sony	002, 003, 004, 005
Sylvania	046
<b>T</b> Toshiba	007, 010

### TV/DVD Combination

<b>A</b> Akai	098
Apex	026
Audiovox	075
Axion	099
<b>C</b> Coby	081

Cytron	097
<b>D</b> DiamondVision	124
Disney	063
<b>G</b> GFM	101
<b>H</b> Haier	103

<b>I</b> Ilo	096
Initial	096
Insignia	102

<b>L</b> LG	077
<b>M</b> Mintek	096
<b>O</b> Oppo	100

<b>P</b> Panasonic	078
Philips	073
Polaroid	086

<b>R</b> RCA	035
<b>S</b> Sansui	008
Sharp	079

Sylvania	046, 123
<b>T</b> Toshiba	008, 101
<b>W</b> Westinghouse	072

### TV/DVD/VCR Combination

<b>M</b> Magnavox	062
<b>P</b> Panasonic	021
<b>T</b> Toshiba	009

## DEVICE SELECT : DVR/VCR

### Digital Video Recorder

<b>A</b> ABS	035
Alienware	035
<b>B</b> Bang & Olufsen	079
<b>C</b> CyberPower	035
<b>D</b> Dell	035
DIRECTV	063, 065, 066, 067, 071, 073, 077
Dish Network	076
Dishpro	076
<b>E</b> EchoStar	076
ExpressVu	076
<b>G</b> Gateway	035
GOI	076
<b>H</b> Hewlett Packard	035
HNS	072
Howard Computers	035
HP	035
HTS	076
Hughes Network Systems	063, 065, 066, 067, 073
Humax	063
Hush	035

<b>I</b>	iBUYPOWER	035
<b>J</b>	JVC	063, 076
<b>L</b>	Linksys	035
<b>M</b>	Media Center PC	035
	Microsoft	035
	Mind	035
<b>N</b>	Niveus Media	035
	Northgate	035
<b>P</b>	Panasonic	070
	Philips	063, 065, 066, 067, 068, 072
	Proscan	077
<b>R</b>	RCA	063, 065, 072, 077
	ReplayTV	069
<b>S</b>	Samsung	065, 067, 072
	Sonic Blue	069
	Sony	035, 064, 074, 078
	Stack	035
	Systemax	035
<b>T</b>	Tagar Systems	035
	Tivo	063, 064, 065, 068, 073, 074, 078
	Toshiba	035, 075
	Touch	035
<b>U</b>	UltimateTV	077
<b>V</b>	Viewsonic	035
	Voodoo	035
<b>Z</b>	ZT Group	035

### Video Cassette Recorder

<b>A</b>	ABS	035
	Adventura	008, 033
	Aiwa	008, 033
	Akai	020
	Alienware	035
	American High	032
	Asha	013, 030
	Audio Dynamics	018
	Audiovox	031
<b>B</b>	Beaumarck	013, 030
	Bell & Howell	029
	Broksonic	056
<b>C</b>	Calix	031
	Candle	030, 031
	Canon	032
	CineVision	058
	Citizen	030, 031
	Colorlyme	018
	Craig	013, 030, 031
	Curtis Mathes	012, 018, 030, 032
	Cybernex	013, 030
	CyberPower	035

<b>D</b>	Daewoo	019, 033
	Davidson	008
	DBX	018
	Dell	035
	Denon	014
	DIRECTV	061
	Durabrand	025
	Dynatech	008, 033
<b>E</b>	Electrohome	010, 031
	Electroponic	031
	Emerson	008, 010, 021, 031, 032, 033
<b>F</b>	Fisher	029
	Fuji	026, 032
	Funai	008, 021, 033
<b>G</b>	Garrard	008, 033
	Gateway	035
	GE	012, 013, 030, 032
	Go Video	013, 048
	Goldstar	018, 031
	Gradiente	008, 033
<b>H</b>	Harley Davidson	033
	Harman/Kardon	018
	Headquarter	029
	Hewlett Packard	035
	Hitachi	[008]*, 014
	Howard Computers	035
	HP	035
	Hughes Network Systems	014, 061
	Humax	061
	Hush	035
<b>I</b>	iBUYPOWER	035
	Insignia	059
	Instant Replay	032
<b>J</b>	JC Penney	018, 029, 030, 031, 032
	JCL	032
	JVC	016, 017, 018, 029
<b>K</b>	Kenwood	018, 029
	Kodak	031, 032
<b>L</b>	LG	031
	Linksys	035
	Lloyd's	008, 033
	LXI	031
<b>M</b>	Magnasonic	021
	Magnavox	008, 021, 022, 025, 028, 032
	Magnin	013, 031
	Marantz	018, 029, 032
	Marta	031
	Matsushita	032
	Media Center PC	035
	MEI	032
	Memorex	008, 013, 025, 029, 030, 031, 032, 033, 062

	MGA	010, 013
	MGN Technology	013, 030
	Microsoft	035
	Mind	035
	Minolta	014
	Mitsubishi	010, 038
	Motorola	032
	MTC	008, 013, 030
	Multitech	008, 030, 033
<b>N</b>	NEC	018, 029
	Nikko	031
	Niveus Media	035
	Noblex	013, 030
	Northgate	035
<b>O</b>	Olympus	032
	Optimus	021, 031
	Optonica	024
	Orion	044, 062
<b>P</b>	Panasonic	000, 001, 002, 003, 004, 032, 060
	Penney	013, 014
	Pentax	014
	Philco	032
	Philips	024, 032, 041, 061
	Philips Magnavox	041
	Pilot	031
	Profitronic	013
	Pulsar	025
<b>Q</b>	Quarter	029
	Quartz	029
	Quasar	032
<b>R</b>	RadioShack	008, 024, 031
	Radio Shack/Realistic	024, 029, 030, 031, 032, 033
	Radix	031
	Randex	031
	RCA	011, 012, 013, 014, 015, 030, 032, 051
	Realistic	008, 024, 029, 030, 031, 032, 033
	ReplayTV	060
	Ricavision	035
	Runco	025
<b>S</b>	Samsung	013, 019, 020, 030, 040, 048, 049, 061
	Sanky	025
	Sansui	008, 044, 062
	Sanyo	013, 029, 030
	Scott	010, 019
	Sears	008, 014, 029, 031, 032
	Sharp	023, 024, 042
	Shogun	013, 030
	Singer	032
	Sonic Blue	060

	Sony	005, 006, 007, 008, 026, 034, 035, 036, 037, 045, 052, 053, 054
	Stack	035
	STS	014, 032
	Sylvania	008, 010, 021, 022, 032, 033, 046, 055
	Symphonic	008, 021, 022, 033
	Systemax	035
<b>T</b>	Tagar Systems	035
	Tandy	029
	Tashiko	031
	Teac	008, 033
	Technics	032
	Teknika	008, 031, 032, 033
	Thomas	008
	Tivo	061
	TMK	013, 030
	Toshiba	009, 010, 019, 035, 039, 047, 050, 057
	Totevision	013, 030, 031
	Touch	035
<b>U</b>	Unitech	013, 030
<b>V</b>	Vector	019
	Vector Research	018
	Video Concepts	018, 019
	Videosonic	013, 030
	Viewsonic	035
	Villain	008
	Voodoo	035
<b>W</b>	Wards	008, 013, 014, 024, 030, 031, 032, 033
<b>X</b>	XR-1000	008, 032, 033
<b>Y</b>	Yamaha	018, 029
<b>Z</b>	Zenith	008, 025, 026, 027, 043
	ZT Group	035

### DVD/VCR Combination

<b>B</b>	Broksonic	056
<b>C</b>	CineVision	058
<b>G</b>	Go Video	048
<b>I</b>	Insignia	059
<b>P</b>	Panasonic	002, 003, 004
<b>S</b>	Samsung	040, 048, 049
	Sony	037, 045, 052, 053, 054
	Sylvania	046
<b>T</b>	Toshiba	039, 050, 057

### TV/VCR Combination

<b>R</b>	RCA	051
<b>S</b>	Sylvania	055

### TV/DVD/VCR Combination

<b>M</b>	Magnavox	022
<b>P</b>	Panasonic	001
<b>T</b>	Toshiba	047

### DEVICE SELECT : SAT/CBL

### Satellite Receiver

<b>A</b>	AccessHD	109
	Alpha Digital	109
	Alphastar	083
	Artec	106
<b>C</b>	CaptiveWorks	102
	Channel Master	111
	Chaparral	077
	Coolsat	103
	Coship	114
	Crossdigital	120
<b>D</b>	Digital Stream	110
	DIRECTV	058, 059, 060, 061, 062, 063, 064, 068, 069, 073, 074, 075, 076, 088, 089, 090, 093, 095, 116
	Dish Network	052, 053, 054, 055, 065, 091, 115, 119
	Dishpro	115, 119
	Drake	078
<b>E</b>	Echostar	052, 065, 091, 115, 119
	Expressvu	119
<b>G</b>	GE	056, 057, 112
	General Instrument	079, 117
	GOI	119
	Goodmind	112
<b>H</b>	Hisense	118
	Hitachi	074, 084
	HTS	119
	Hughes Network Systems	060, 062, 067, 068, 070, 075, 093
	Humax	104
<b>I</b>	Ilo	118
	Insignia	096
<b>J</b>	Jerrold	117
	JVC	052, 065, 091, 119
<b>L</b>	Lasonic	113
	LG	096, 105
<b>M</b>	Magnavox	073, 107
	Memorex	073
	MicroGem	108
	Mitsubishi	068, 099
	Motorola	117
<b>N</b>	Next Level	117
<b>P</b>	Panasonic	061, 095, 097

Pansat	100
Paysat	073
PCT	111
Philco	107
Philips	060, 067, 068, 070, 072, 073, 090
Pioneer	060
Primestar	082
Proscan	056, 057
Proton	118
<b>R</b> RadioShack	117
RCA	056, 057, 058, 070, 076, 086, 087, 088, 089, 092
Realistic	080
<b>S</b> Samsung	060, 062, 069, 070, 071, 094
Sharp	098
Sony	059, 066, 116
Star Choice	117
STS	085
<b>T</b> Tivax	109
Tivo	060, 070
Toshiba	063
<b>U</b> UltimateTV	116
Uniden	073, 081
US Digital	118
<b>V</b> Viewsat	101
Voom	117
<b>Z</b> Zenith	064, 096

## Cable TV

<b>A</b> ABC	[009]*, 010, 012, 028, 040
Adelphia	007
Americast	047
Antronix	014, 015
Archer	015
AT&T	003
<b>B</b> Bell South	047
<b>C</b> Cable Vision	006
Cabletenna	014
Cableview	013
Clearmaster	046
ClearMax	046
Colour Voice	016
Comcast	000, 005, 033
Comtronics	017
Contec	018
Coolmax	046
COX	005
<b>D</b> Daeryung	036
Director	033
Dumont	051
<b>E</b> Eastern	019

Everquest	041
<b>F</b> Focus	045
<b>G</b> GC Electronics	015
GE	009, 010
Gehua	033
Gemini	020, 041
General Instrument	005, 010, 033, 044
Goldstar	042
<b>H</b> Hamlin	021
Hitachi	010
<b>J</b> Jasco	041
Jerrold	005, 010, 020, 028, 029, 033, 041, 044
<b>L</b> LG	050
<b>M</b> Magnavox	022
MegaCable	005
Memorex	023, 040
Motorola	000, 003, 005, 033, 037, 039, 044
Movie Time	024
Multitech	046
<b>N</b> NEC	011
NET Brazil	035
NSC	024
Oak	018
<b>O</b> Pace	008, 043
Panasonic	026, 027, 040
Paragon	040
Philips	016, 022
Pioneer	002, 030, 036, 042
Popular Mechanics	045
Proscan	009, 010
Pulsar	040
Quasar	040
<b>R</b> RadioShack	041, 046
RCA	013, 027
Realistic	015
Recoton	045
Regal	021
Regency	019
Rembrandt	010
Runco	040
<b>S</b> Samsung	008, 034, 042
Scientific Atlanta	001, 002, 003, 007, 012, 036, 038
Signal	020, 041
Signature	010
Sony	006, 048
Sprucer	027
Standard Component	025
Starcom	020, 028, 041
Stargate	020, 041
Starquest	020, 041

Supercable	044
Supermax	046
<b>T</b> Time Warner	004
Tocom	031
Torx	049
Toshiba	040
Trans PX	044
Tristar	046
TS	049
Tusa	020, 041
TV86	024
<b>U</b> Unika	014, 015
United Cable	028
Universal	014, 015
<b>V</b> V2	046
View Star	018, 022, 024
Viewmaster	046
Vision	046
Vortex View	046
<b>Z</b> Zenith	032, 040, 047
Zentek	045

## DEVICE SELECT : CD

### CD Player

<b>A</b> Accuphase	018
Acoustic Research	019
ADS	020
Aiwa	021
Akai	022
Audio Alchemy	023
Audio Pro	024
Audio-Technica	025
<b>B</b> B & K	026
<b>C</b> California Audio Labs	036
Carver	040, 041
<b>D</b> Denon	001, 042, [111]*
DKK	035
DMX Electronics	040
Dynamic Bass	041
<b>G</b> GE	017
Genexxa	037
<b>H</b> Harman/Kardon	007
<b>J</b> JVC	003, 011, 012
<b>K</b> Kenwood	038, 039
<b>L</b> Krell	040
<b>L</b> Linn	040
<b>M</b> Magnavox	027
Marantz	028
Miro	035

Mission	040
Musical Fidelity	029
<b>N</b> NEC	030
NSM	040
<b>O</b> Onkyo	002
Optimus	035, 037, 039, 041
<b>P</b> Philips	009, 010
Pioneer	006
Polk Audio	040
Proscan	017
Proton	040
<b>Q</b> QED	040
Quad	040
<b>R</b> RCA	000, 017
Realistic	041
Rotel	040
<b>S</b> SAE	040
Sansui	040
Sanyo	031
SAST	040
Sharp	032
Silsonic	038
Sonic Frontiers	040
Sony	004, 005, 008, 013, 014
Soundesign	033
Symphonic	034
<b>T</b> TAG McLaren	040
Technics	015
<b>W</b> Wards	040
<b>Y</b> Yamaha	016
<b>Z</b> Zonda	040

[ ]\*: Preset codes set upon shipment from the factory.  
: Les codes prérégés diffèrent en fonction de la livraison de l'usine.

DVD preset codes / Codes prérégés DVD			
DENON Model No. / Modèle numéro	111 (default / default)		014
	DVD-900	DVD-2900	DVD-800
DVD-1000	DVD-2910	DVD-1600	
DVD-1400	DVD-2930	DVD-2000	
DVD-1500	DVD-3800	DVD-2500	
DVD-1710	DVD-3910	DVD-3000	
DVD-1720	DVD-3930	DVD-3300	
DVD-1730	DVD-A11		
DVD-1740	DVD-5000		
DVD-1910	DVD-A1XV		
DVD-1920	DVD-A1XVA		
DVD-1930	DVD-A1		
DVD-1940	DVM-3700		
DVD-2200			
DVD-2800			
DVD-2800II			

Blu-Ray preset codes / Codes prérégés Blu-Ray	
DENON	121
Model No. / Modèle numéro	DVD-1800BD DVD-2500BT DVD-3800BD DVD-A1UDCI

**DENON**

[www.denon.com](http://www.denon.com)

Denon Brand Company, D&M Holdings Inc.  
Printed in China 5411 10342 003D