

DENON

AV SURROUND RECEIVER

AVR-888

Owner's Manual

Manuel de l'Utilisateur

SAFETY PRECAUTIONS



CAUTION
RISK OF ELECTRIC SHOCK
DO NOT OPEN



CAUTION:
TO REDUCE THE RISK OF ELECTRIC SHOCK, DO NOT REMOVE COVER (OR BACK). NO USER-SERVICEABLE PARTS INSIDE. REFER SERVICING TO QUALIFIED SERVICE PERSONNEL.

The lightning flash with arrowhead symbol, within an equilateral triangle, is intended to alert the user to the presence of uninsulated "dangerous voltage" within the product's enclosure that may be of sufficient magnitude to constitute a risk of electric shock to persons.

The exclamation point within an equilateral triangle is intended to alert the user to the presence of important operating and maintenance (servicing) instructions in the literature accompanying the appliance.

WARNING:
TO REDUCE THE RISK OF FIRE OR ELECTRIC SHOCK, DO NOT EXPOSE THIS APPLIANCE TO RAIN OR MOISTURE.

SAFETY INSTRUCTIONS

1. Read Instructions – All the safety and operating instructions should be read before the product is operated.
2. Retain Instructions – The safety and operating instructions should be retained for future reference.
3. Heed Warnings – All warnings on the product and in the operating instructions should be adhered to.
4. Follow Instructions – All operating and use instructions should be followed.
5. Cleaning – Unplug this product from the wall outlet before cleaning. Do not use liquid cleaners or aerosol cleaners.
6. Attachments – Do not use attachments not recommended by the product manufacturer as they may cause hazards.
7. Water and Moisture – Do not use this product near water – for example, near a bath tub, wash bowl, kitchen sink, or laundry tub; in a wet basement; or near a swimming pool; and the like.
8. Accessories – Do not place this product on an unstable cart, stand, tripod, bracket, or table. The product may fall, causing serious injury to a child or adult, and serious damage to the product. Use only with a cart, stand, tripod, bracket, or table recommended by the manufacturer, or sold with the product. Any mounting of the product should follow the manufacturer's instructions, and should use a mounting accessory recommended by the manufacturer.
9. A product and cart combination should be moved with care. Quick stops, excessive force, and uneven surfaces may cause the product and cart combination to overturn.
10. Ventilation – Slots and openings in the cabinet are provided for ventilation and to ensure reliable operation of the product and to protect it from overheating, and these openings must not be blocked or covered. The openings should never be blocked by placing the product on a bed, sofa, rug, or other similar surface. This product should not be placed in a built-in installation such as a bookcase or rack unless proper ventilation is provided or the manufacturer's instructions have been adhered to.
11. Power Sources – This product should be operated only from the type of power source indicated on the marking label. If you are not sure of the type of power supply to your home, consult your product dealer or local power company. For products intended to operate from battery power, or other sources, refer to the operating instructions.
12. Grounding or Polarization – This product may be equipped with a polarized alternating-current line plug (a plug having one blade wider than the other). This plug will fit into the power outlet only one way. This is a safety feature. If you are unable to insert the plug fully into the outlet, try reversing the plug. If the plug should still fail to fit, contact your electrician to replace your obsolete outlet. Do not defeat the safety purpose of the polarized plug.
13. Power-Cord Protection – Power-supply cords should be routed so that they are not likely to be walked on or pinched by items placed upon or against them, paying particular attention to cords at plugs, convenience receptacles, and the point where they exit from the product.
15. Outdoor Antenna Grounding – If an outside antenna or cable system is connected to the product, be sure the antenna or cable system is grounded so as to provide some protection against voltage surges and built-up static charges. Article 810 of the National Electrical Code, ANSI/NFPA 70, provides information with regard to proper grounding of the mast and supporting structure, grounding of the lead-in wire to an antenna discharge unit, size of grounding conductors, location of antenna-discharge unit, connection to grounding electrodes, and requirements for the grounding electrode. See Figure A.
16. Lightning – For added protection for this product during a lightning storm, or when it is left unattended and unused for long periods of time, unplug it from the wall outlet and disconnect the antenna or cable system. This will prevent damage to the product due to lightning and power-line surges.
17. Power Lines – An outside antenna system should not be located in the vicinity of overhead power lines or other electric light or power circuits, or where it can fall into such power lines or circuits. When installing an outside antenna system, extreme care should be taken to keep from touching such power lines or circuits as contact with them might be fatal.
18. Overloading – Do not overload wall outlets, extension cords, or integral convenience receptacles as this can result in a risk of fire or electric shock.
19. Object and Liquid Entry – Never push objects of any kind into this product through openings as they may touch dangerous voltage points or short-out parts that could result in a fire or electric shock. Never spill liquid of any kind on the product.
20. Servicing – Do not attempt to service this product yourself as opening or removing covers may expose you to dangerous voltage or other hazards. Refer all servicing to qualified service personnel.
21. Damage Requiring Service – Unplug this product from the wall outlet and refer servicing to qualified service personnel under the following conditions:
 - a) When the power-supply cord or plug is damaged,
 - b) If liquid has been spilled, or objects have fallen into the product,
 - c) If the product has been exposed to rain or water,
 - d) If the product does not operate normally by following the operating instructions. Adjust only those controls that are covered by the operating instructions as an improper adjustment of other controls may result in damage and will often require extensive work by a qualified technician to restore the product to its normal operation,
 - e) If the product has been dropped or damaged in any way, and
 - f) When the product exhibits a distinct change in performance – this indicates a need for service.
22. Replacement Parts – When replacement parts are required, be sure the service technician has used replacement parts specified by the manufacturer or have the same characteristics as the original part. Unauthorized substitutions may result in fire, electric shock, or other hazards.
23. Safety Check – Upon completion of any service or repairs to this product, ask the service technician to perform safety checks to determine that the product is in proper operating condition.
24. Wall or Ceiling Mounting – The product should be mounted to a wall or ceiling only as recommended by the manufacturer.
25. Heat – The product should be situated away from heat sources such as radiators, heat registers, stoves, or other products (including amplifiers) that produce heat.

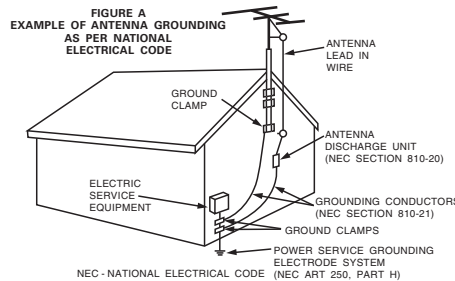

FCC INFORMATION (For US customers)

1. PRODUCT

This product complies with Part 15 of the FCC Rules. Operation is subject to the following two conditions: (1) this product may not cause harmful interference, and (2) this product must accept any interference received, including interference that may cause undesired operation.

2. IMPORTANT NOTICE: DO NOT MODIFY THIS PRODUCT

This product, when installed as indicated in the instructions contained in this manual, meets FCC requirements. Modification not expressly approved by DENON may void your authority, granted by the FCC, to use the product.

3. NOTE







This product has been tested and found to comply with the limits for a Class B digital device, pursuant to Part 15 of the FCC Rules. These limits are designed to provide reasonable protection against harmful interference in a residential installation.

This product generates, uses and can radiate radio frequency energy and, if not installed and used in accordance with the instructions, may cause harmful interference to radio communications. However, there is no guarantee that interference will not occur in a particular installation. If this product does cause harmful interference to radio or television reception, which can be determined by turning the product OFF and ON, the user is encouraged to try to correct the interference by one or more of the following measures:

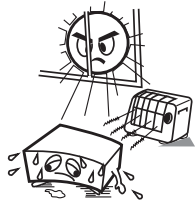
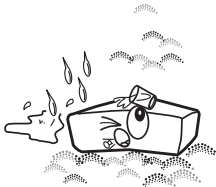
- Reorient or relocate the receiving antenna.
- Increase the separation between the equipment and receiver.
- Connect the product into an outlet on a circuit different from that to which the receiver is connected.
- Consult the local retailer authorized to distribute this type of product or an experienced radio/TV technician for help.

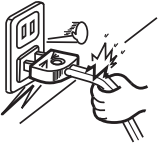
This Class B digital apparatus complies with Canadian ICES-003.
Cet appareil numérique de la classe B est conforme à la norme NMB-003 du Canada.

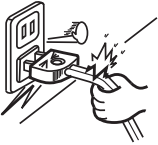
NOTE ON USE / OBSERVATIONS RELATIVES A L'UTILISATION

| | | |
|---|--|--|
|  <ul style="list-style-type: none"> • Avoid high temperatures. Allow for sufficient heat dispersion when installed in a rack. • Eviter des températures élevées. Tenir compte d'une dispersion de chaleur suffisante lors de l'installation sur une étagère. |  <ul style="list-style-type: none"> • Keep the unit free from moisture, water, and dust. • Protéger l'appareil contre l'humidité, l'eau et la poussière. |  <ul style="list-style-type: none"> • Do not let foreign objects into the unit. • Ne pas laisser des objets étrangers dans l'appareil. |
|  <ul style="list-style-type: none"> • Handle the power cord carefully. Hold the plug when unplugging the cord. • Manipuler le cordon d'alimentation avec précaution. Tenir la prise lors du débranchement du cordon. |  <ul style="list-style-type: none"> • Unplug the power cord when not using the unit for long periods of time. • Débrancher le cordon d'alimentation lorsque l'appareil n'est pas utilisé pendant de longues périodes. |  <ul style="list-style-type: none"> • Do not let insecticides, benzene, and thinner come in contact with the unit. • Ne pas mettre en contact des insecticides, du benzène et un diluant avec l'appareil. |
|  <ul style="list-style-type: none"> • Handle the power cord carefully. Hold the plug when unplugging the cord. • Manipuler le cordon d'alimentation avec précaution. Tenir la prise lors du débranchement du cordon. |  <p>* (For apparatuses with ventilation holes)</p> <ul style="list-style-type: none"> • Do not obstruct the ventilation holes. • Ne pas obstruer les trous d'aération. |  <ul style="list-style-type: none"> • Never disassemble or modify the unit in any way. • Ne jamais démonter ou modifier l'appareil d'une manière ou d'une autre. |

Contents

Getting Started

| | |
|---|---|
| Accessories | 2 |
| Cautions on Handling | 3 |
| Cautions on Installation | 3 |
| About the Remote Control Unit | 3 |
| Inserting the Batteries..... | 3 |
| Operating Range of the Remote Control Unit..... | 3 |
| Part Names and Functions | 4 |
| Front Panel..... | 4 |
| Display..... | 4 |
| Rear Panel..... | 5 |
| Remote Control Unit..... | 6 |

Connections

| | |
|---|-------|
| Preparations | 7 |
| Cables Used for Connections..... | 7 |
| Video Conversion Function..... | 8 |
| On-Screen Display for Component Video Outputs and HDMI Output..... | 8 |
| Speaker Connections | 9 |
| Speaker Installation..... | 9 |
| Speaker Connections..... | 9, 10 |
| Connecting Equipment with HDMI connectors | 11 |
| Connecting the Monitor | 12 |
| Connecting the Playback Components | 12 |
| DVD Player..... | 12 |
| Record Player..... | 13 |
| CD Player..... | 13 |
| iPod®..... | 14 |
| TV/CABLE Tuner..... | 14 |
| Connecting the Recording Components | 15 |
| Digital Video Recorder..... | 15 |
| Video Cassette Recorder..... | 15 |
| CD Recorder / MD Recorder / Tape Deck..... | 16 |
| Connections to Other Devices | 16 |
| Video Camera / Game Console..... | 16 |
| Component with Multi-channel Output connectors..... | 17 |
| XM connector..... | 17 |
| Antenna terminals..... | 18 |
| Multi-zone..... | 19 |
| Connecting the Power Cord | 19 |
| Once Connections are Completed | 19 |

Menu Operations

| | |
|--|----|
| Operations | 20 |
| Example of Display of Default Values | 20 |
| Examples of On-screen Display and Front Display | 21 |
| Menu Map | 22 |

Auto Setup

| | |
|-------------------------------|----|
| Preparations | 23 |
| Auto Setup | 24 |
| 1 Start Menu..... | 24 |
| Error Messages..... | 25 |
| 2 Option..... | 25 |
| 3 Parameter Check..... | 25 |

Manual Setup

| | |
|---------------------------------------|--------|
| Speaker Setup | 26 |
| 1 Speaker Configuration..... | 26 |
| 2 Subwoofer Setup..... | 26 |
| 3 Distance..... | 26, 27 |
| 4 Channel Level..... | 27 |
| 5 Crossover Frequency..... | 27 |
| HDMI Setup | 27 |
| 1 HDMI Audio Setup..... | 27 |
| 2 HDMI Video Setup..... | 28 |
| Audio Setup | 28 |
| 1 EXT. IN Subwoofer Level..... | 28 |
| 2 2ch Direct/Stereo..... | 28, 29 |
| 3 Dolby Digital Setup..... | 29 |
| 4 Auto Surround Mode..... | 29 |
| 5 Manual EQ..... | 29 |
| Zone2 Setup | 30 |
| 1 Lch Level..... | 30 |
| 2 Rch Level..... | 30 |
| 3 Volume Limit..... | 30 |
| 4 Power On Level..... | 30 |
| 5 Mute Level..... | 30 |
| Option Setup | 30 |
| 1 Amp Assign..... | 30 |
| 2 Volume Control..... | 31 |
| 3 Source Delete..... | 31 |
| 4 On-Screen Display..... | 31 |
| 5 Quick Select Name..... | 32 |
| 6 Remote ID Setup..... | 32 |
| 7 Display..... | 32 |
| 8 Setup Lock..... | 32 |

Input Setup

| | |
|--|--------|
| Settings Related to Playing Input Sources | 33 |
| Auto Preset..... | 33 |
| Preset Skip..... | 33 |
| Preset Name..... | 33 |
| Input Mode..... | 34 |
| Rename..... | 34 |
| Assign..... | 34, 35 |
| iPod..... | 35 |
| Other..... | 35, 36 |
| Antenna Aiming..... | 36 |

Surround Modes

| | |
|---|----|
| Standard Playback | 36 |
| Surround Playback of 2-channel Sources..... | 36 |
| Playing Multi-channel Sources (Dolby Digital, DTS, etc.)..... | 36 |
| DSP Simulation Playback | 37 |
| Stereo Playback | 37 |
| Direct Playback | 37 |
| Playback in the PURE DIRECT Mode..... | 37 |

Parameter

| | |
|----------------------------------|--------|
| 1 Surround Parameter..... | 38, 39 |
| 2 Tone Control..... | 40 |
| 3 Room EQ..... | 40 |
| 4 RESTORER..... | 40 |
| 5 Night Mode..... | 41 |
| 6 Audio Delay..... | 41 |

Information

| | |
|--|----|
| Status | 41 |
| 1 Main Zone..... | 41 |
| 2 ZONE2..... | 41 |
| Audio Input Signal | 41 |
| HDMI Information | 42 |
| 1 HDMI Signal Information..... | 42 |
| 2 HDMI Monitor Information..... | 42 |
| Auto Surround Mode | 42 |
| Quick Select | 42 |
| Preset Station | 42 |

Playback

Preparations43
 Turning the Power On43
 Selecting the input source43
 Operations During Playback43
Playing Video and Audio Equipment44
 Basic Operation44
Listening to FM/AM Broadcasts44
 Basic Operation44
 Presetting Radio Stations (Preset Memory)44
 Listening to Preset Stations44
Listening to XM Satellite Radio Programs45
 Basic Operation45
 Checking the XM Signal Strength and Radio ID46
 Searching Categories46
iPod® Playback46
 Basic Operation46
 Listening to Music47
 Viewing Still Pictures or Videos on the iPod47

Other Operations and Functions

Other Operations48
 Recording on an External Device (REC OUT mode)48
Convenient Functions48
 Channel Level48
 Fader Function48
 Quick Select Function49
 Personal Memory Plus Function49
 Last Function Memory49
 Backup Memory49
 Resetting the Microprocessor49

Remote Control Unit Operations

Operating DENON Audio Components50
Presetting50
Operating Preset Component50 ~ 52
Punch Through Function53

Amp Assign / Multi-zone Connections and Operations

Multi-zone Settings with the Amp Assign Function54 ~ 56
Multi-zone Settings and Operations with Zone Output56
Multi-zone Operations57
 Turning the Power On and Off57
 Selecting the Input Source57
 Adjusting the Volume57
 Turning off the Sound Temporarily57

Other Information58 ~ 66

Troubleshooting67 ~ 69

Specifications70

List of preset codes End of this manual

Getting Started

Thank you for purchasing this DENON product. To ensure proper operation, please read this owner's manual carefully before using the product.

After reading them, be sure to keep them for future reference.

Accessories

Check that the following parts are supplied with the product.

| | |
|---|---|
| ① Owner's manual | 1 |
| ② Warranty (for North America model only) | 1 |
| ③ Service station list | 1 |
| ④ Remote control (RC-1080) | 1 |
| ⑤ R6P/AA batteries | 2 |
| ⑥ FM indoor antenna | 1 |
| ⑦ AM loop antenna | 1 |
| ⑧ Setup microphone (Cord length: Approx. 25 ft / 7.6 m) | 1 |

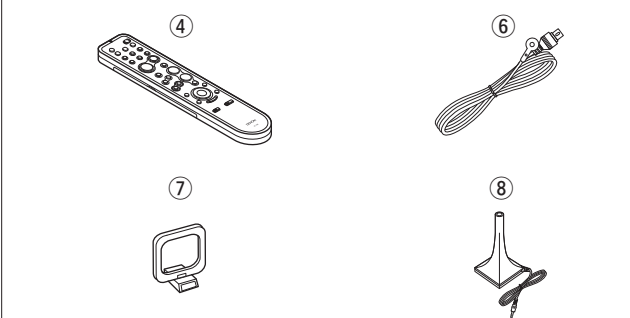

Cautions on Handling

• Before turning the power switch on

Check once again that all connections are correct and that there are no problems with the connection cables.

- Power is supplied to some of the circuitry even when the unit is set to the standby mode. When traveling or leaving home for long periods of time, be sure to unplug the power cord from the power outlet.

• About condensation

If there is a major difference in temperature between the inside of the unit and the surroundings, condensation (dew) may form on the operating parts inside the unit, causing the unit not to operate properly.

If this happens, let the unit sit for an hour or two with the power turned off and wait until there is little difference in temperature before using the unit.

• Cautions on using mobile phones

Using a mobile phone near this unit may result in noise. If so, move the mobile phone away from this unit when it is in use.

• Moving the unit

Turn off the power and unplug the power cord from the power outlet.

Next, disconnect the connection cables to other system units before moving the unit.

- Note that the illustrations in these instructions may differ from the actual unit for explanation purposes.

Cautions on Installation

Note:

For proper heat dispersal, do not install this unit in a confined space, such as a bookcase or similar enclosure.

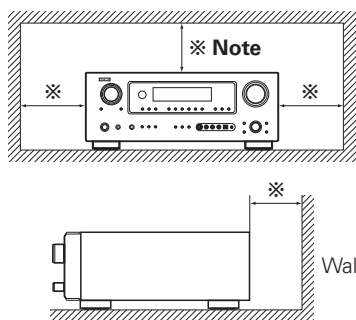

About the Remote Control Unit

In addition to the AVR-888, the included remote control unit (RC-1080) can also be used to operate the equipment listed below.

- ① DENON system components
- ② Non-DENON system components
 - By setting the preset memory (page 50 ~ 52)

Inserting the Batteries

- ① Lift the clasp and remove the rear lid.
- ② Load the two batteries properly as indicated by the marks in the battery compartment.

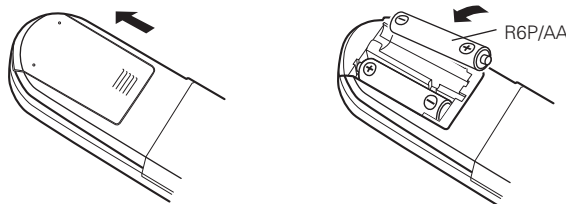

- ③ Put the rear cover back on.

NOTE

- Replace the batteries with new ones if the set does not operate even when the remote control unit is operated close to the unit.
- The supplied batteries are only for verifying operation.
- When inserting the batteries, be sure to do so in the proper direction, following the “+” and “-” marks in the battery compartment.
- To prevent damage or leakage of battery fluid:
 - Do not use a new battery together with an old one.
 - Do not use two different types of batteries.
 - Do not attempt to charge dry batteries.
 - Do not short-circuit, disassemble, heat or dispose of batteries in flames.
- If the battery fluid should leak, carefully wipe the fluid off the inside of the battery compartment and insert new batteries.
- Remove the batteries from the remote control unit if it will not be in use for long periods.
- When replacing the batteries, have the new batteries ready and insert them as quickly as possible.

Operating Range of the Remote Control Unit

Point the remote control unit at the remote sensor when operating it.

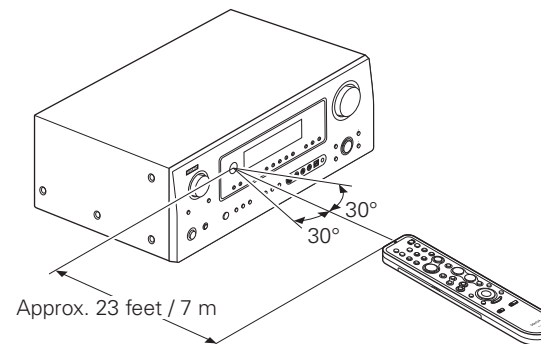

NOTE

The set may function improperly or the remote control unit may not operate if the remote control sensor is exposed to direct sunlight, strong artificial light from an inverter type fluorescent lamp or infrared light.

Part Names and Functions

For buttons not explained here, see the page indicated in parentheses ().

Front Panel

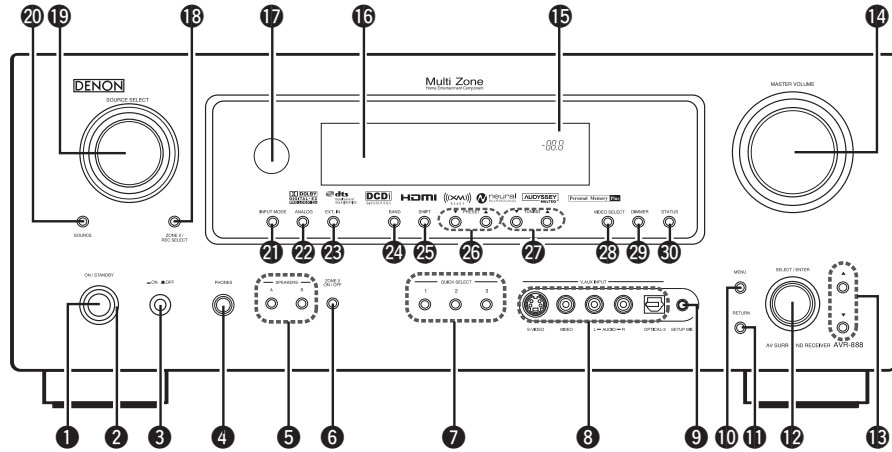

- 1 Power operation button (ON/STANDBY)** (43)
- 2 Power indicator** (43)
- 3 Power switch (ON/OFF)** (43)
- 4 Headphones jack (PHONES)** (43)
- 5 SPEAKER buttons** (43)
- 6 ZONE2 ON/OFF button** (57)
- 7 QUICK SELECT buttons** (49)
- 8 V. AUX INPUT connectors**
Remove the cap covering the terminals when you want to use them.
- 9 SETUP MIC jack** (23)
- 10 MENU button** (20)
- 11 RETURN button** (20)
- 12 SELECT/ENTER knob** (20)
 - The **SELECT/ENTER** knob on the main unit operates in the same way as the **CURSOR** ◀ and ▶ buttons on the remote control unit.
- 13 Cursor buttons (Δ ▽)** (20)
- 14 MASTER VOLUME control knob** (43)
- 15 Master volume indicator**
- 16 Display**
- 17 Remote control sensor** (3)
- 18 ZONE2/REC SELECT button** (48)

- 19 SOURCE SELECT knob** (43)
- 20 SOURCE button** (43)
- 21 INPUT MODE button** (34)
- 22 ANALOG button** (34)
- 23 EXT. IN button** (34)
- 24 BAND button** (44)
- 25 SHIFT button** (44)
- 26 PRESET buttons** (44)
- 27 TUNING buttons** (44)
- 28 VIDEO SELECT button** (35)
- 29 DIMMER button** (32)
- 30 STATUS button** (45)

Display

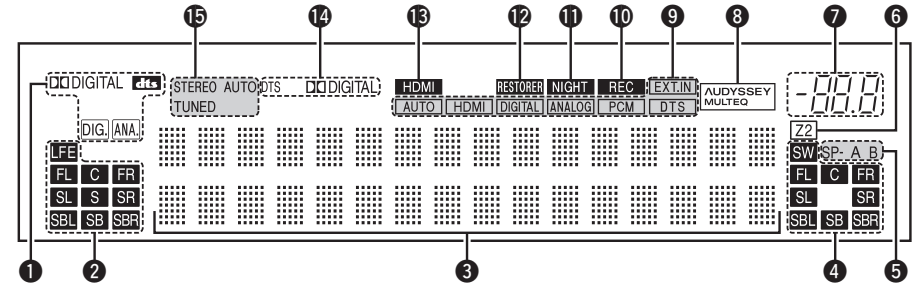

- 1 Input signal indicators**
- 2 Input signal channel indicators**
These light when digital signals are input.
- 3 Information display**
The input source name, surround mode, setting values and other information are displayed here.
- 4 Output signal channel indicators**
- 5 Front speaker indicator**
These light according to the settings of the front A and B speakers.
- 6 ZONE2 output indicator**
This lights when the power for the ZONE2 is turned on.
- 7 Master volume indicator**
- 8 AUDYSSEY MULTEQ indicator**
This lights when the room equalizer is selected.
- 9 Input mode indicators**
- 10 Recording output source indicator**
This lights when the REC OUT mode is selected.
- 11 NIGHT indicator**
This lights when the night mode is selected.
- 12 RESTORER indicator**
This lights when the RESTORER mode is selected.
- 13 HDMI indicator**
This lights when playing using HDMI connections.
- 14 Decoder indicators**
These light when the respective decoders are operating.
- 15 Tuner reception mode indicators**
These light according to the reception conditions when the input source is set to "TUNER":
 - **AUTO**
This lights when in the auto tuning mode.
 - **STEREO**
In the FM mode, this lights when receiving analog stereo broadcasts.
 - **TUNED**
This lights when the broadcast is properly tuned in.

Rear Panel

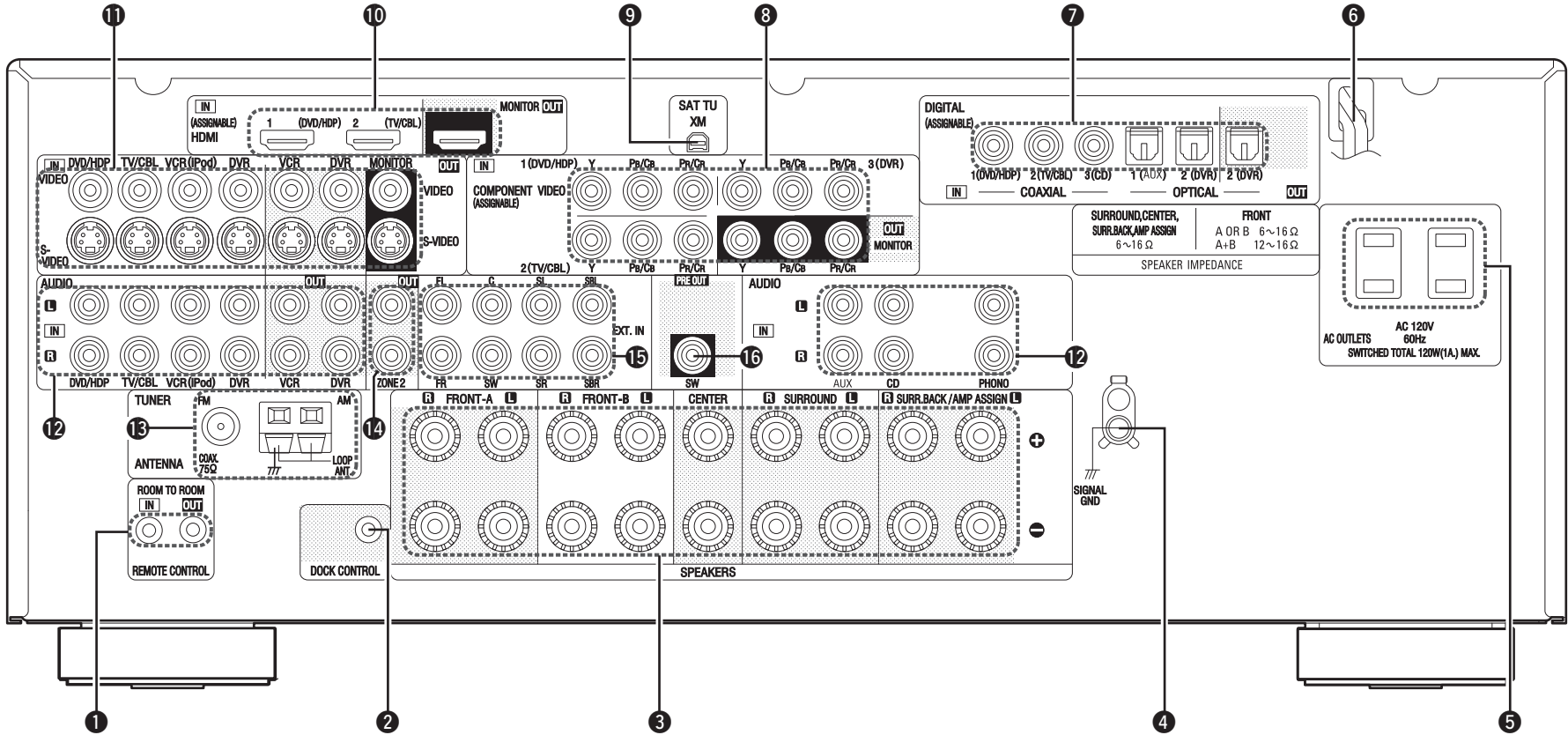

- 1 REMOTE CONTROL jack (19)
- 2 DOCK CONTROL jack (14)
- 3 Speaker terminals (SPEAKERS) (9)
- 4 SIGNAL GND terminal (13)
- 5 AC OUTLETS (20)
- 6 AC inlet (AC IN) (20)
- 7 Digital audio connectors (OPTICAL / COAXIAL) (12, 15)
- 8 COMPONENT VIDEO connectors (12)
- 9 XM connector (SAT TU) (17)
- 10 HDMI connectors (11)
- 11 VIDEO / S-VIDEO connectors (12)
- 12 Analog audio connectors (AUDIO) (12)
- 13 FM/AM antenna terminals (TUNER ANTENNA) (18)
- 14 ZONE2 connectors (19)
- 15 EXT. IN connectors (17)
- 16 PRE OUT connector (9)

Getting Started
Connections
Setup
Playback
Remote Control
Multi-Zone
Information
Troubleshooting

Remote Control Unit

[Front]

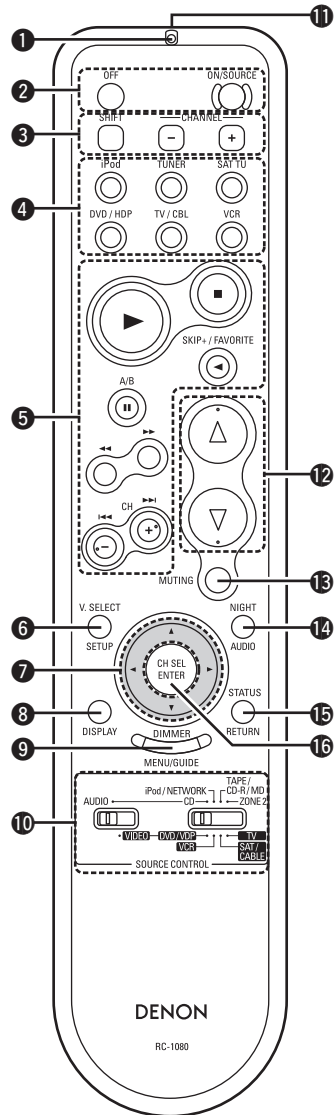

- ❶ Indicator (50)
- ❷ Power buttons (43)
- ❸ Tuner system buttons (44)
- ❹ Source select buttons (43)
- ❺ System buttons (47)
- ❻ Video select button (V. SELECT) (35)
- ❼ Cursor buttons (Δ▽◀▶) (20)
- ❽ DISPLAY button (41)
- ❾ DIMMER button (32)
- ❿ Mode selector switches (44, 46)
- ⓫ Remote control signal transmitter (3)
- ⓬ Master volume control buttons (43)
- ⓭ MUTING button (43)
- ⓮ NIGHT button (41)
- ⓯ STATUS button (45)
- ⓰ Channel select (CH SEL) / ENTER button (20, 48)

[Rear]

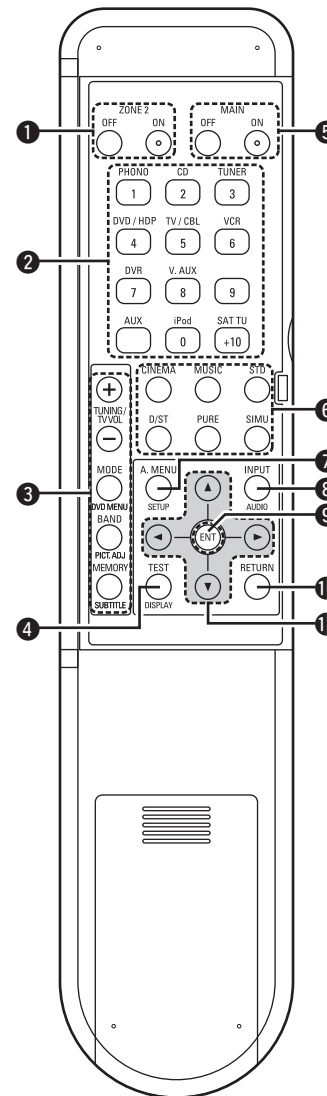

- ❶ ZONE2 power buttons (57)
- ❷ Source select buttons (43)
- ❸ Tuner system buttons (44)
- ❹ Test tone button (TEST) (27)
- ❺ Main zone power buttons (MAIN) (57)
- ❻ Surround mode buttons (36, 37)
- ❼ Amp menu button (A. MENU) (20)
- ❽ Input mode button (INPUT) (34)
- ❾ Enter button (ENT) (20)
- ❿ RETURN button (20)
- ⓫ Cursor buttons (Δ▽◀▶) (20)

NOTE

If buttons on the front or rear are pressed strongly, the button on the opposite side will be activated too.

Connections

Connections for all compatible audio and video signal formats are described in these operating instructions. Please select the types of connections suited for the equipment you are connecting. With some types of connections, certain settings must be made on the AVR-888. For details, refer to the instructions for the respective connection items below.













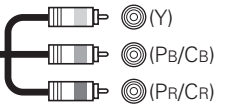

NOTE

- Do not plug in the power cord until all connections have been completed.
- When making connections, also refer to the operating instructions of the other components.
- Be sure to connect the left and right channels properly (left with left, right with right).
- Do not bundle power cords together with connection cables. Doing so can result in humming or noise.

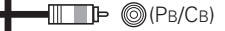
Preparations

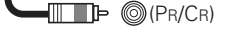
Cables Used for Connections

Select the cables according to the equipment being connected.

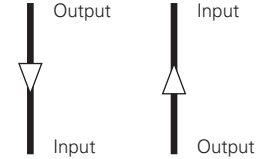
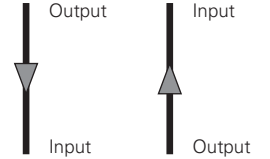
| Audio cables | Video cables |
|---|--|
| <p>Coaxial digital connections</p> <p>(Orange)  Coaxial digital (75 Ω/ohms pin-plug) cable</p> <p>Optical digital connections</p> <p> Optical cable</p> <p>Analog connections (stereo)</p> <p>(White)  (Red)  Stereo pin-plug cable</p> <p>Analog connections (monaural, for subwoofer)</p> <p>(Black)  Pin-plug cable</p> <p>Speaker connections</p> <p> Speaker cables</p> | <p>Component video connections</p> <p>(Green)  (Y)  (Blue)  (PB/CB)  (Red)  (PR/CR) </p> <p>Component video cable</p> <p>S-Video connections</p> <p> S-Video cable</p> <p>Video connections</p> <p>(Yellow)  75 Ω/ohms pin-plug video cable</p> |
| Audio and video cables | |
| <p>HDMI connections</p> <p> 19-pin HDMI cable</p> | |
| Signal direction | |
| <p>Audio signal: </p> <p>Video signal: </p> | |

Video Conversion Function

- This function automatically converts various formats of video signals input to the AVR-888 into the format used to output the video signals from the AVR-888 to a monitor.
- The AVR-888's video input/output circuitry is compatible with the following four types of video signals:
 Digital video signals: HDMI
 Analog video signals: Component video, S-Video and Video

[Flow of video signals inside the AVR-888]

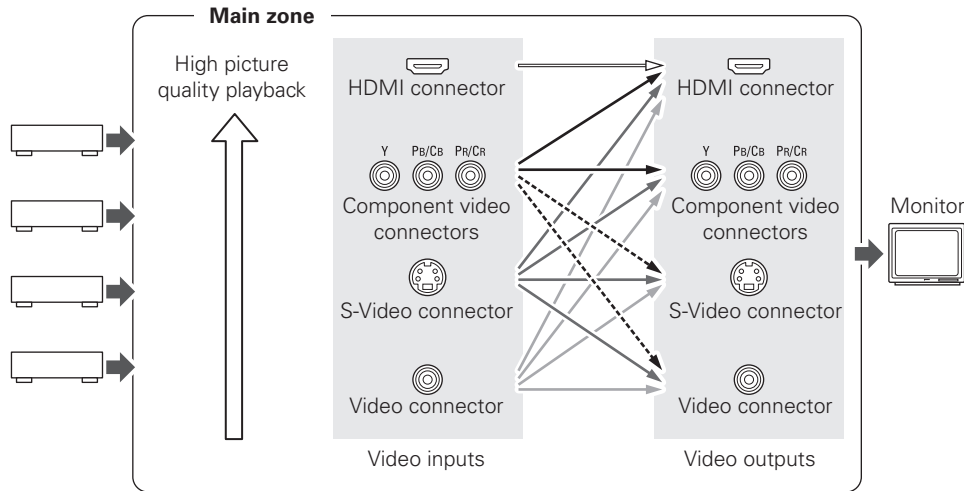

- When not using this function, connect a monitor output with the same type of connector as the video input connector.
- The resolution of the HDMI input-compatible monitor connected to the AVR-888 can be checked at menu "Information" – "HDMI Information" (page 42).

NOTE

- HDMI signals cannot be converted into analog signals.
- 1080p component input video signals cannot be output to anything other than component video connectors.
- 480p/576p, 1080i and 720p component video input signals cannot be converted into S-Video or Video format.
- When a non-standard video signal from a game machine or some other source is input, the video conversion function might not operate.

On-Screen Display for Component Video Outputs and HDMI Output

- When viewing HDMI or component video signals via the AVR-888, the on-screen display appears when the **MENU** button or the remote control unit's **DISPLAY** button is operated.
- When only HDMI or component video signals are input to the AVR-888, the characters of the on-screen display are not displayed over the picture.

Speaker Connections

Speaker Installation

The illustration below shows a basic example of installation of the amplifier combined with 8 speakers and a monitor.

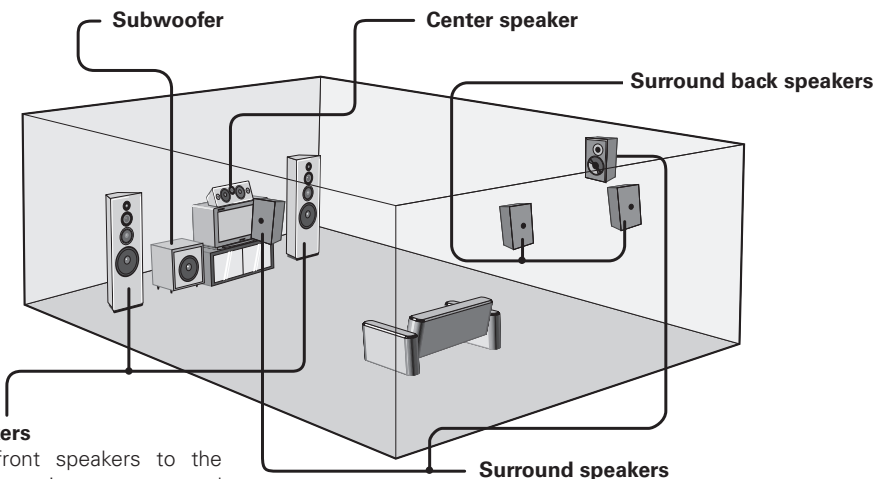

Front speakers

Place the front speakers to the sides of the monitor or screen and as flush with the screen surface as possible.



The table below shows a typical speaker configuration for the AVR-888.

| | FRONT | | CENTER | SURROUND | | SURROUND BACK | | | SUBWOOFER |
|--------------------------|-------|---|--------|----------|---|---------------|---|--------|-----------|
| | L | R | | L | R | L | R | 1 only | |
| 7.1-channels (FRONT A+B) | ○ | ○ | ○ | ○ | ○ | ○ | ○ | - | ○ |
| 7.1-channels | ○ | ○ | ○ | ○ | ○ | ○ | ○ | - | ○ |
| 6.1-channels | ○ | ○ | ○ | ○ | ○ | - | - | ○ | ○ |
| 5.1-channels | ○ | ○ | ○ | ○ | ○ | - | - | - | ○ |
| 3.1-channels | ○ | ○ | ○ | - | - | - | - | - | ○ |
| 2.1-channels | ○ | ○ | - | - | - | - | - | - | ○ |
| 2-channels | ○ | ○ | - | - | - | - | - | - | - |

Speaker Connections

Example: 5.1-channels (FRONT A+B) and ZONE2 use

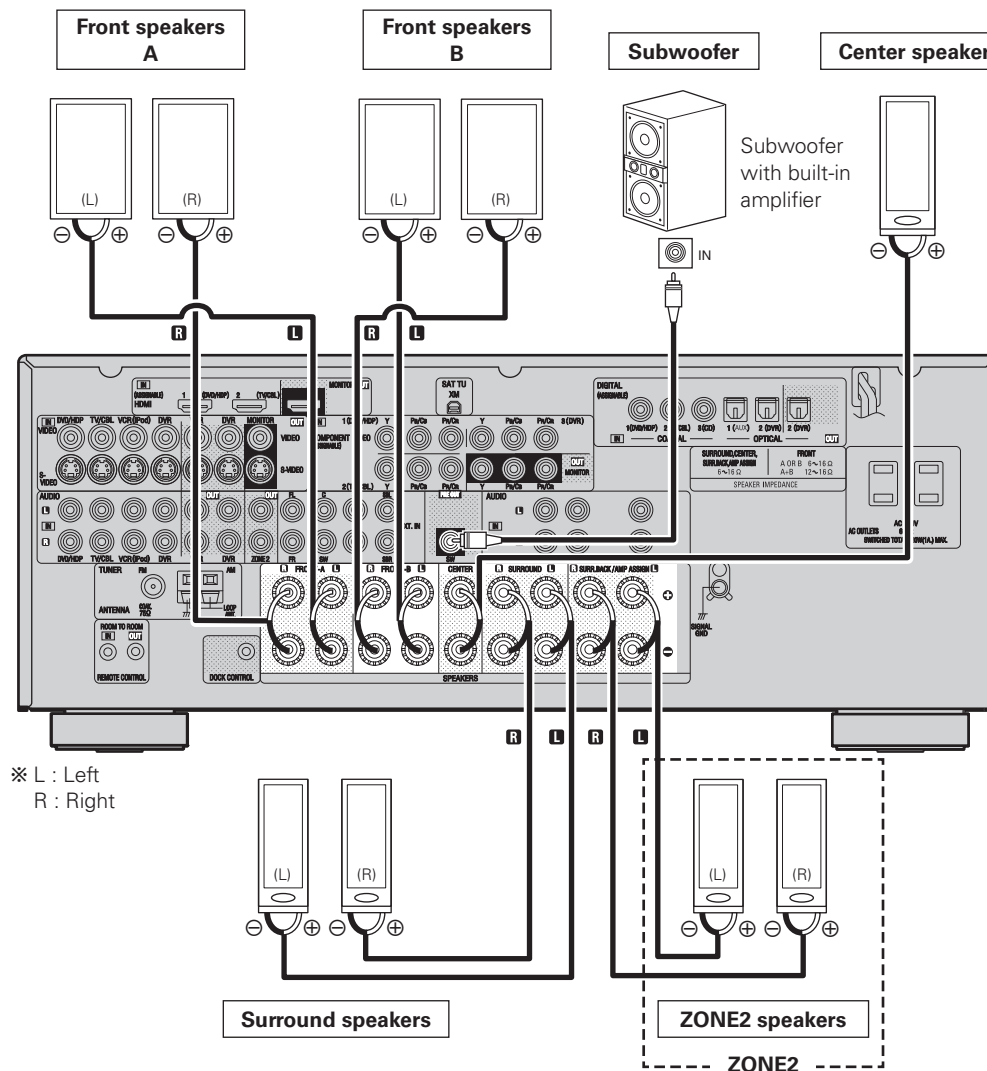

※ L : Left
R : Right



When using just one surround back speaker, connect it to the left channel (SBL).

NOTE

By default, the AVR-888's "Amp Assign" setting is set to "ZONE2". To use as the surround back speaker for the main zone, change the "Amp Assign" setting (page 30).

Connecting the Speaker Cables

Carefully check the left (L) and right (R) channels and + (red) and – (black) polarities on the speakers being connected to the AVR-888, and be sure to interconnect the channels and polarities correctly.

1 Peel off about 0.03 ft/10 mm of sheathing from the tip of the speaker cable, then either twist the core wire tightly or terminate it.



2 Turn the speaker terminal counterclockwise to loosen it.



3 Insert the speaker cable's core wire to the hilt into the speaker terminal.



4 Turn the speaker terminal clockwise to tighten it.



When using a banana plug

Tighten the speaker terminal firmly before inserting the banana plug.

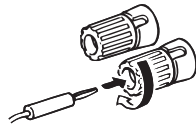

NOTE

- Use speakers with an impedance of 6 to 16 Ω /ohms. When using front A and B speakers simultaneously, use speakers with an impedance of 8 to 16 Ω /ohms.
- Connect the speaker cables in such a way that they do not stick out of the speaker terminals. The protection circuit may be activated if the core wires touch the rear panel or if the + and – sides touch each other (☞ "Protection circuit").
- Never touch the speaker terminals while the power supply is connected. Doing so could result in electric shock.

Protection circuit

If speakers with an impedance lower than specified (for example 4 Ω /ohms speakers) are used for an extended period of time with the volume turned up high, the temperature may rise, activating the protection circuit.

When the protection circuit is activated, the speaker output is shut off and the power indicator flashes red. If this happens, unplug the power cord, then check the speaker cable and input cable connections. If the set is extremely hot, wait for it to cool off and improve ventilation around it. Once this is done, plug the power cord back in and turn the set's power back on.

If the protection circuit is activated again even though there are no problems in the ventilation around the set nor in the connections, the set may be damaged. Turn the power off, then contact a DENON service center.

Connecting Equipment with HDMI connectors

With HDMI connections, the video and audio signals can be transferred with a single cable.

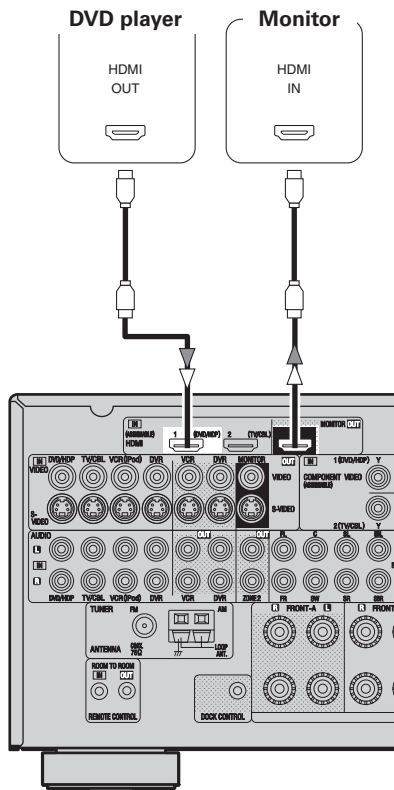

- ※ The AVR-888 is equipped for HDMI version 1.3a. This version is compatible with other versions, allowing connection to all components equipped with an HDMI connector.
- ※ The AVR-888 is compatible with 30- and 36-bit Deep Color.

| Compatible audio format | Details | Discs (examples) |
|--------------------------|---------------------------------|--------------------------|
| 2-channel linear PCM | 2ch 32-192 kHz 16/20/24 bits | CD, DVD-Video, DVD-Audio |
| Multi-channel linear PCM | 8ch 32-192 kHz 16/20/24 bits | DVD-Audio |
| Dolby Digital, DTS | Bitstream | DVD-Video |

Copyright protection system (HDCP)

In order to play the digital video and audio signals of a DVD-Video or DVD-Audio disc using HDMI/DVI connections, both the connected DVD player and monitor must be equipped for a copyright protection system called "HDCP" (High-bandwidth Digital Content Protection).
HDCP is a copy protection technology consisting of data encoding and mutual identification of the devices.
The AVR-888 is HDCP-compatible. For details on the DVD player or monitor you are using, refer to its operating instructions.



- By default, the HDMI audio signals are output from the speakers connected to the AVR-888.
- To output the sound from the TV, make the settings at menu "Manual Setup" – "HDMI Setup" – "HDMI Audio Setup" – "TV" (page 27).

NOTE

- Use a CPPM-compatible DVD player to play DVD-Audio discs that are copyright-protected by CPPM.
- The AVR-888 cannot be controlled from another device via the HDMI cable.
- The audio signals output from the HDMI connector (sampling frequency, bit rate, etc.) may be restricted by the connected device.
- Video signals are not output properly when using devices that are not HDCP-compatible.
- Video signals are not output if the input video signals do not match the monitor's resolution. In this case, switch the DVD player's resolution to a resolution with which the monitor is compatible.
- If the menu "Manual Setup" – "HDMI Setup" – "HDMI Audio Setup" setting (page 27) is set to "AMP," the sound may be interrupted when the monitor's power is turned off.
- Use a cable on which the HDMI logo is indicated (a certified HDMI product) for connection to the HDMI connector. Normal playback may not be possible when using a cable other than one on which the HDMI logo is indicated (a non-HDMI-certified product).
- If the monitor or DVD player does not support deep color, deep color signal transfer is not possible.
- If the monitor or DVD player does not support xvYCC, xvYCC signal transfer is not possible.



- When the AVR-888 and DVD player are connected using an HDMI cable, also connect the AVR-888 and monitor using an HDMI cable.
- If the connected monitor or DVD player only has a DVI-D connector, use an HDMI/DVI converter cable. When using a DVI cable, no audio signals are transmitted.
- Use a Deep Color compatible cable for connection to Deep Color compatible devices.

When connecting with an HDMI/DVI converter cable (adapter)

- HDMI video signals are theoretically compatible with the DVI format.
When connecting to a monitor, etc., equipped with a DVI-D connector, connection is possible using an HDMI/DVI converter cable, but depending on the combination of components in some cases the video signals will not be output.
- When connecting using an HDMI/DVI converter adapter, the video signals may not be output properly due to poor connections with the connected cable, etc.

Connecting the Monitor

- Connect the cables to be used (☞ page 8 “Video Conversion Function”).
- With HDMI connections, the video and audio signals can be transferred with a single cable.
- To output the audio signals to the monitor with HDMI connections, set menu “Manual Setup” – “HDMI Setup” – “HDMI Audio Setup” to “TV” (☞ page 27).

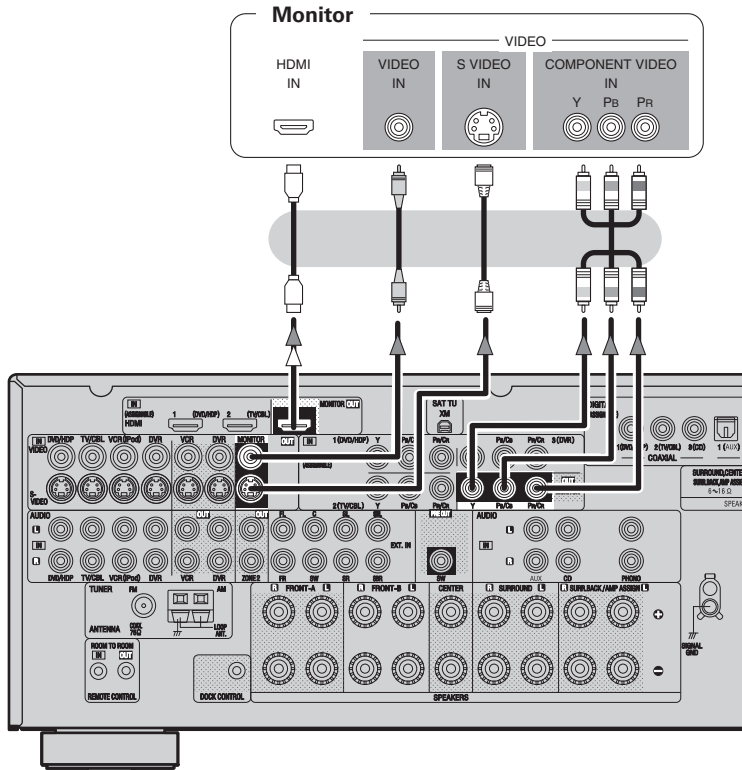

NOTE

- The component video connectors may be indicated differently on your monitor. For details, see the monitor’s operating instructions.
- No audio signals are output from the HDMI monitor output connector. To play the sound by monitor, make analog or digital audio output connections to monitor’s audio input connectors.
- The audio signals output from the HDMI connectors are only the HDMI input signals. Video-converted HDMI signals are not included in the audio signals.

Connecting the Playback Components

Carefully check the left (L) and right (R) channels and the inputs and outputs, and be sure to interconnect correctly.

DVD Player

- Connect the cables to be used.
- With HDMI connections, the video and audio signals can be transferred with a single cable.

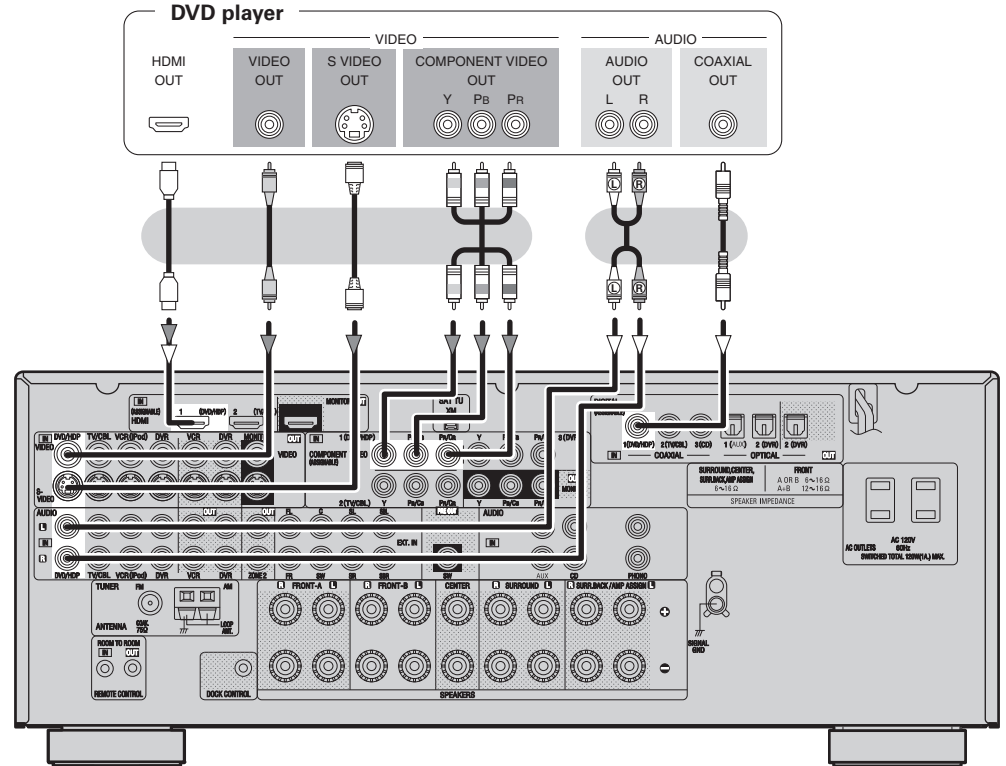

- Connect an HDP (High-Definition Player) in the same way.
- When using an optical cable for the digital audio connection, make the settings at menu “Input Setup” – “Assign” – “Digital In” (☞ page 35).

Record Player

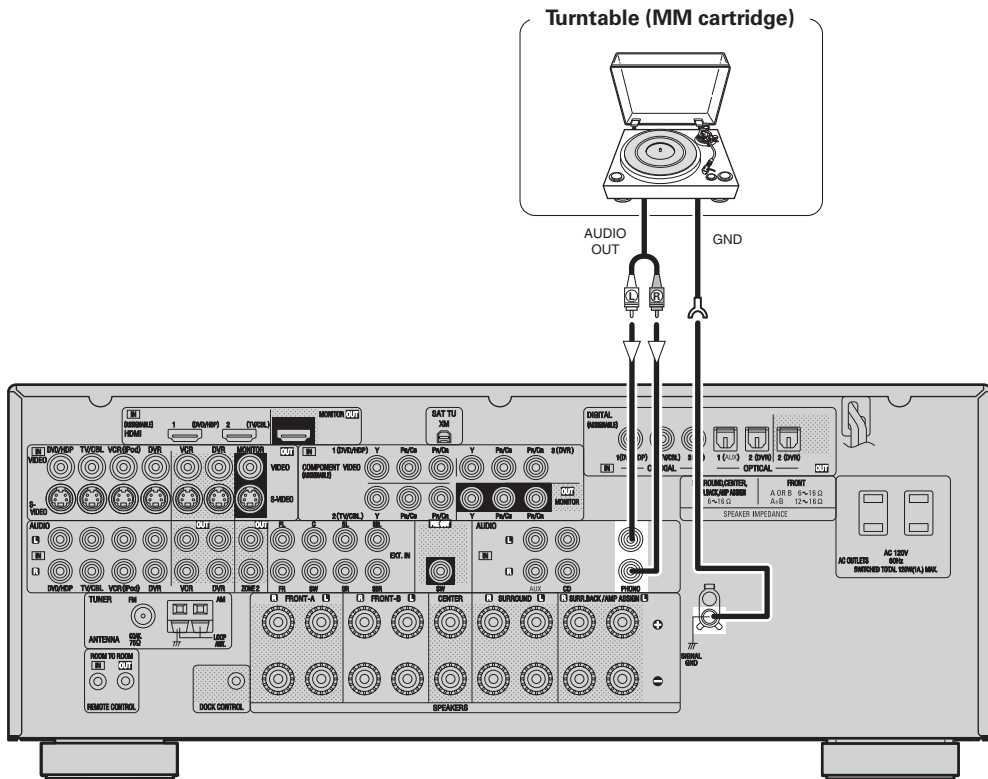

- When connecting a record player with an MC cartridge, use a commercially available MC head amplifier or a step-up transformer.
- Induction humming (a booming sound) may be produced from the speakers if the volume is raised with no record player connected.
- With some record players, noise may be generated when the ground wire is connected. If so, disconnect the ground wire.

NOTE

The AVR-888's SIGNAL GND terminal is meant to reduce noise when a record player is connected. This is not a safety ground terminal.

CD Player

Connect the cables to be used.

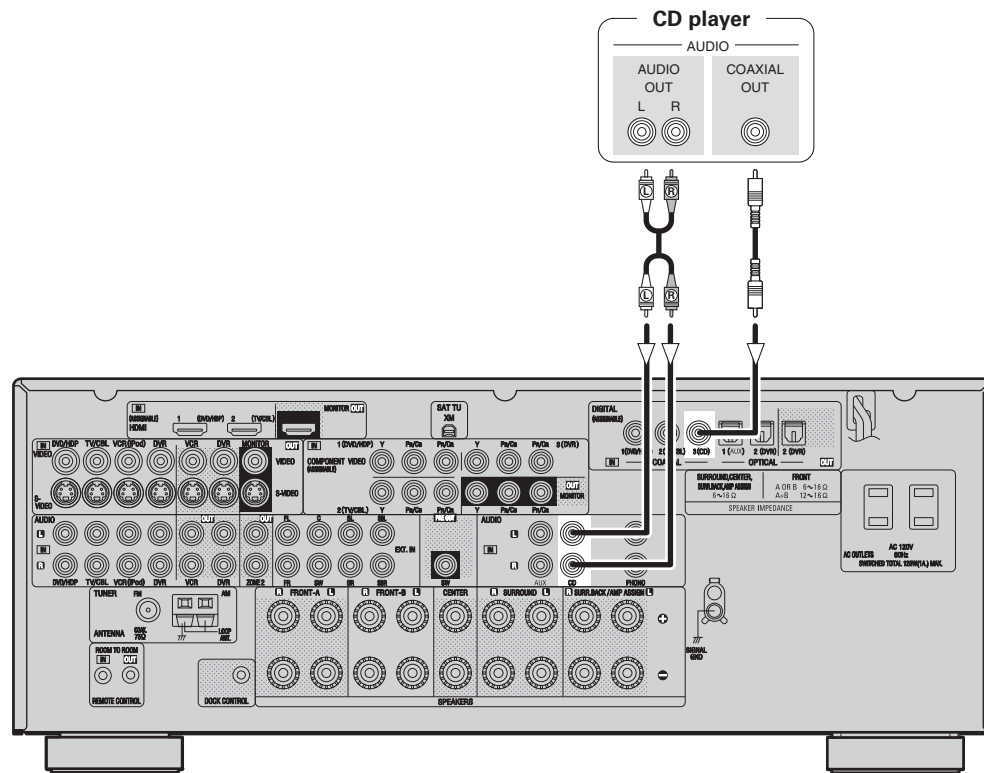

- When using an optical cable for the digital audio connection, make the settings at menu "Input Setup" – "Assign" – "Digital In" (page 35).

iPod®

Use a DENON Control Dock for iPod (ASD-1R, ASD-3N or ASD-3W, sold separately) to connect the iPod to the AVR-888. For instructions on the Control Dock for iPod settings, refer to the Control Dock for iPod's operating instructions.

Example 1:

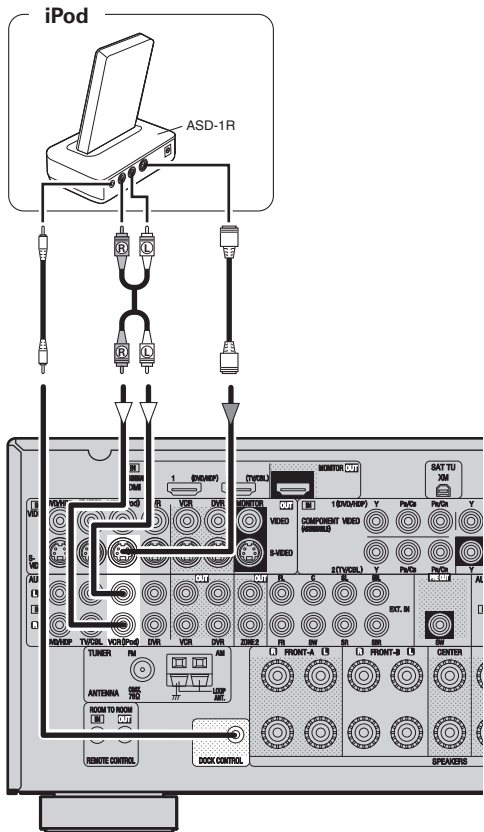

Example 2:

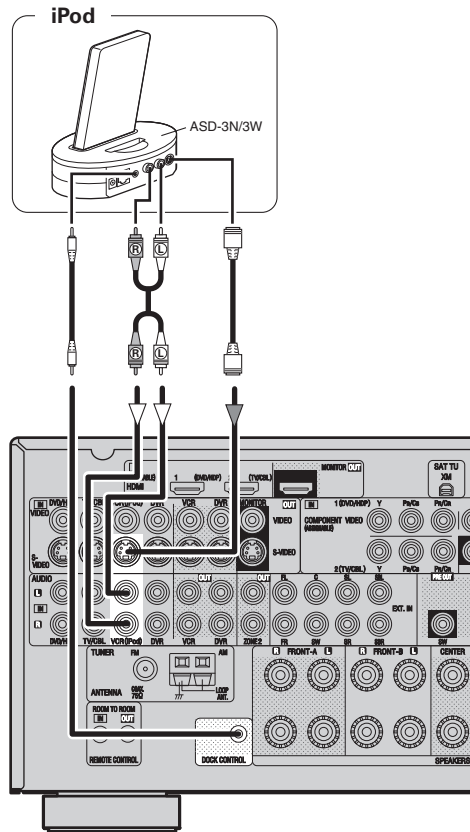

- With the default settings, the iPod can be used connected to the VCR (iPod) connector.
- To assign the iPod to a connector other than VCR (iPod), make the settings at menu "Input Setup" – "(input source to which iPod dock assigned)" – "Assign" – "iPod dock" (page 35).

TV/CABLE Tuner

Connect the cables to be used.

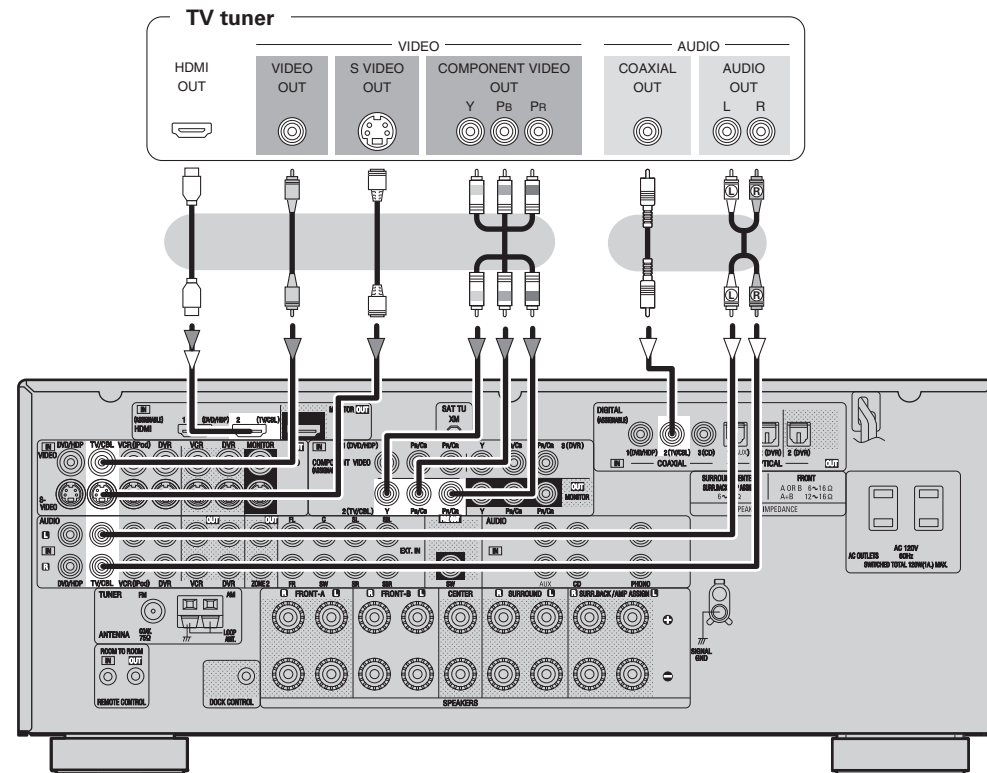

When using an optical cable for the digital audio connection, make the settings at menu "Input Setup" – "Assign" – "Digital In" (page 35).

Connecting the Recording Components

Carefully check the left (L) and right (R) channels and the inputs and outputs, and be sure to interconnect correctly.

Digital Video Recorder

Connect the cables to be used.

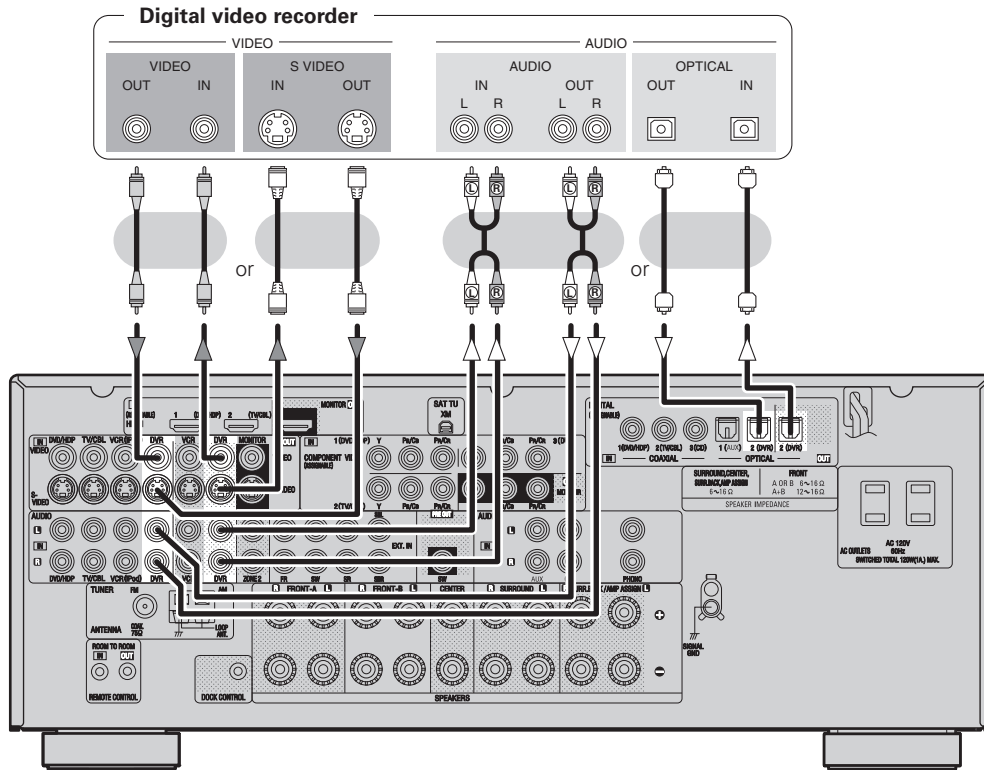

- Make analog connections if you wish to record analog audio signals.
- When recording via the AVR-888, the playback device's cable must be of the same type as the cable used to connect the AVR-888's VCR OUT connector.
Example: TV IN → S-Video cable : DVR OUT → S-Video cable
TV IN → Video cable : DVR OUT → Video cable
- When using a component video cable for the video connection, make the settings at menu "Input Setup" – "Assign" – "Component In" (page 35).

NOTE

Do not connect the output of the component connected to the AVR-888's OPTICAL2 output connector to any input connector other than OPTICAL2.

Video Cassette Recorder

Connect the cables to be used.

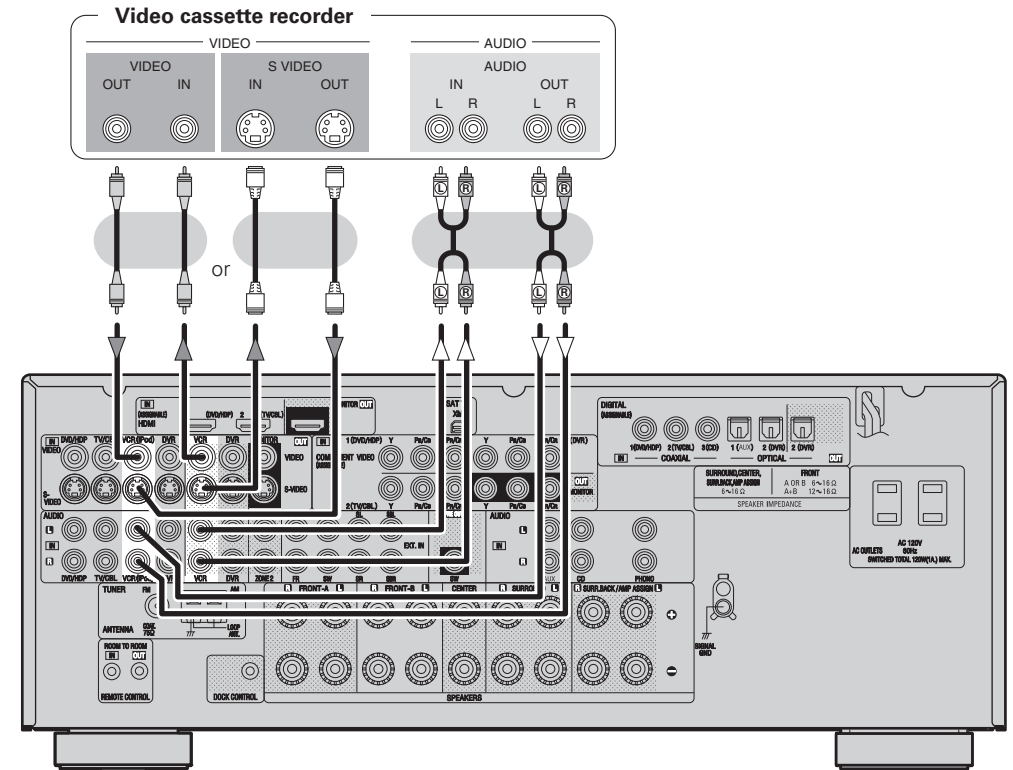

- When recording via the AVR-888, the playback device's cable must be of the same type as the cable used to connect the AVR-888's VCR OUT connector.
Example: TV IN → S-Video cable : VCR OUT → S-Video cable
TV IN → Video cable : VCR OUT → Video cable
- When using a component video cable for the video connection, make the settings at menu "Input Setup" – "Assign" – "Component In" (page 35).

CD Recorder / MD Recorder / Tape Deck

Make analog connections if you wish to record analog audio signals, or digital connections if you wish to record digital audio signals, depending on the types of connectors on the components being used.

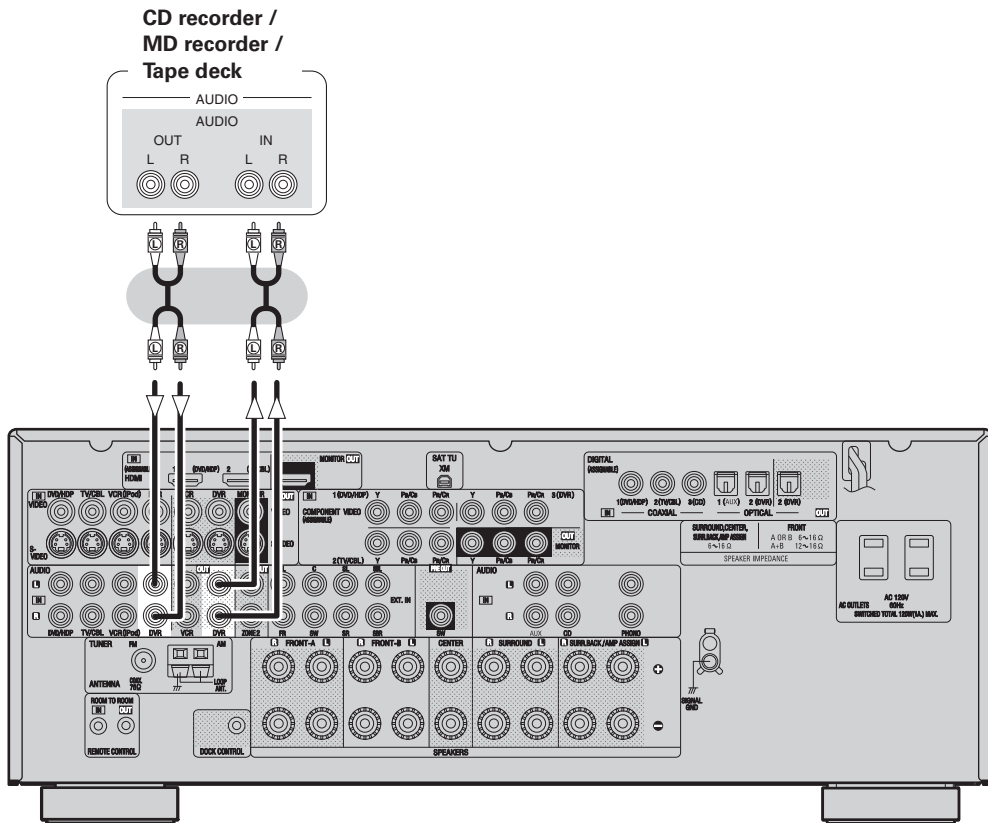

Connections to Other Devices

Carefully check the left (L) and right (R) channels and the inputs and outputs, and be sure to interconnect correctly.

Video Camera / Game Console

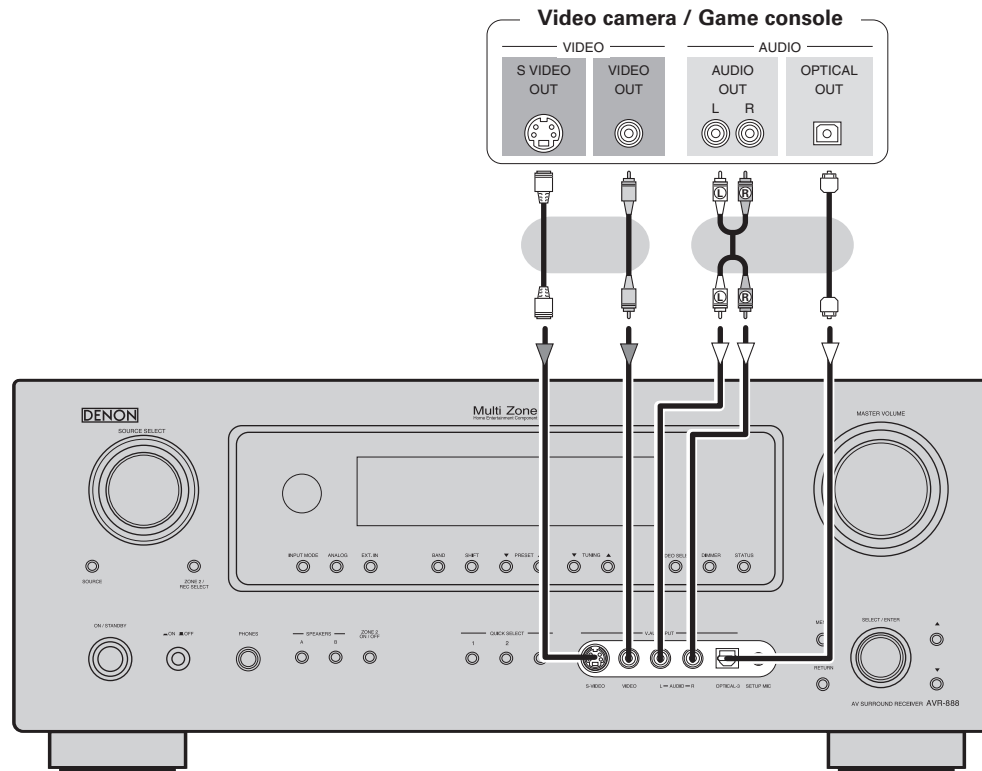

Getting Started
Connections
Setup
Playback
Remote Control
Multi-Zone
Information
Troubleshooting

Component with Multi-channel Output connectors

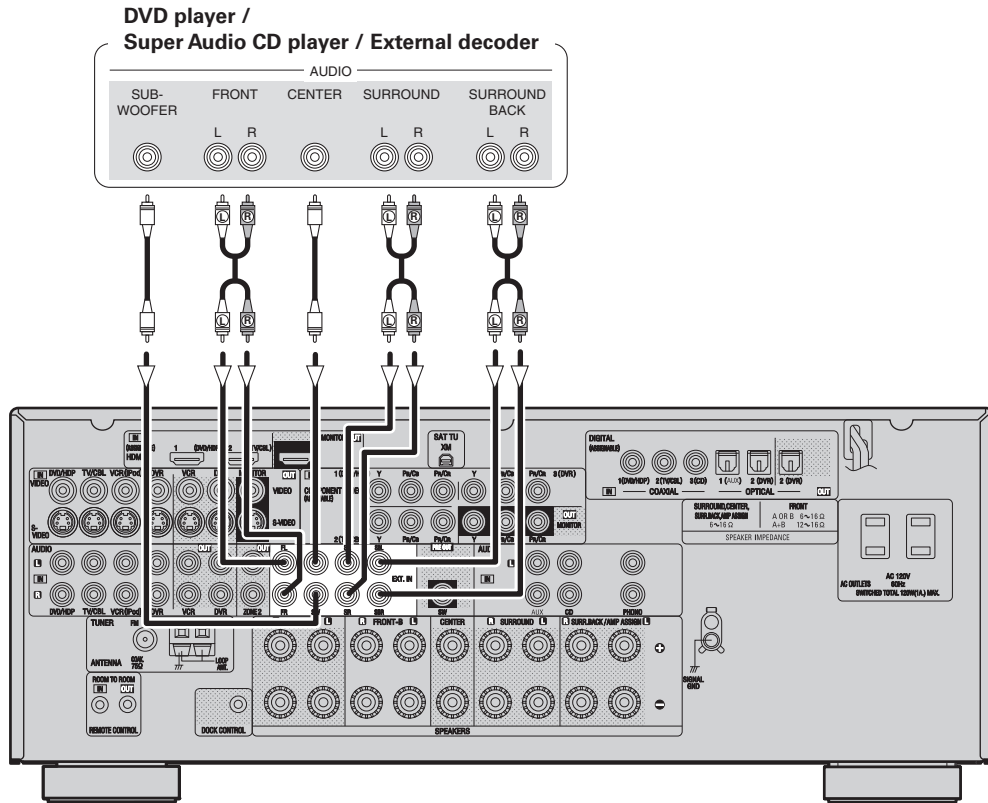

- To play the analog input signals input to the EXT. IN connectors, press the **EXT. IN** button on the main unit or **INPUT** button on the remote control unit and select "EXT. IN" or make the settings at menu "Input Setup" – "Input Mode" – "Input Mode" – "EXT. IN" (page 34).
- The video signal can be connected in the same way as a DVD player (page 12).
- To play copyright-protected discs, connect the AVR-888's EXT. IN connector with the DVD player's analog multi-channel output connector.

XM connector

- The AVR-888 is an XM Ready® receiver. You can receive XM® Satellite Radio by connecting to the XM Mini-Tuner and Home Dock (includes home antenna, sold separately) and subscribing to the XM service.
- Plug the XM Mini-Tuner and Home Dock into the XM connector on the rear panel.
- Position the Home Dock antenna near a south-facing window to receive the best signal. For details, see "Listening to XM Satellite Radio Programs" (page 45, 46). When making connections, also refer to the operating instructions of the XM Mini-Tuner and Home Dock.

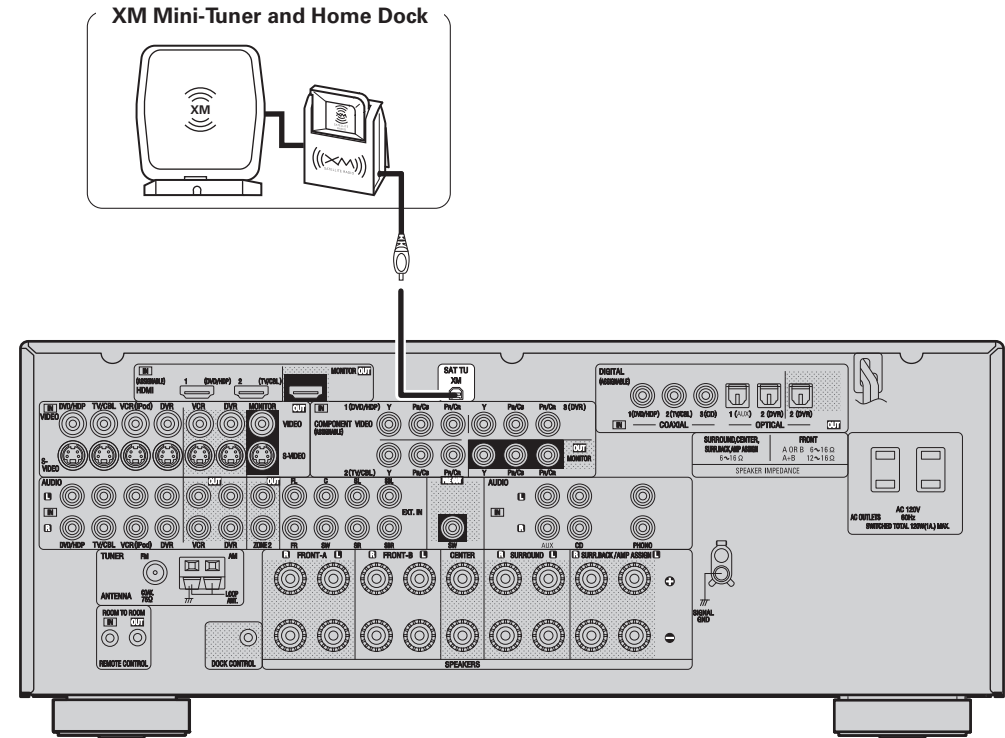

NOTE
Keep the power cord unplugged until the XM Mini-Tuner and Home Dock connection have been completed.

- The XM name and related logo are registered trademarks of XM Satellite Radio Inc. All rights reserved.
- XM Ready is a registered trademark of XM Satellite Radio Inc. All rights reserved.

Antenna terminals

An F-type FM antenna cable plug can be connected directly.

Direction of broadcasting station

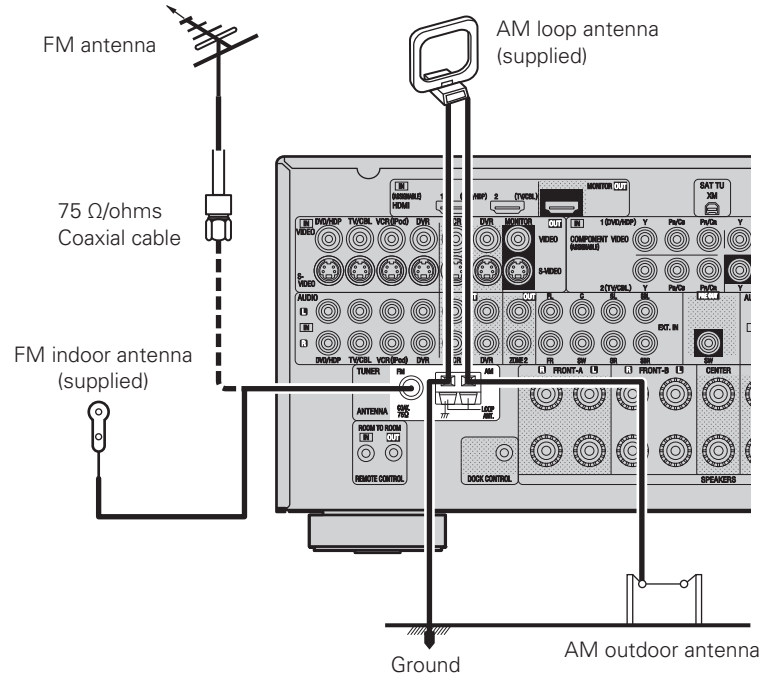

AM loop antenna assembly

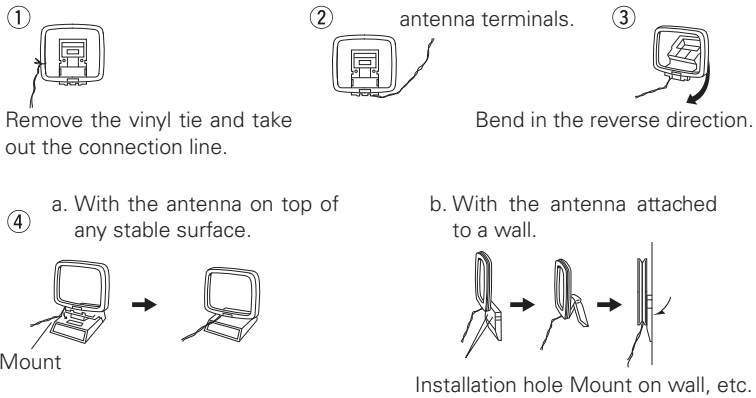

Connection of AM antennas

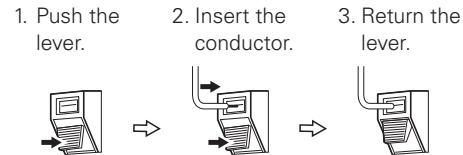

NOTE

- Do not connect two FM antennas simultaneously.
- Even if an external AM antenna is used, do not disconnect the AM loop antenna.
- Make sure the AM loop antenna lead terminals do not touch metal parts of the panel.

Note to CATV system installer:

This reminder is provided to call the CATV system installer's attention to Article 820-40 of the NEC which provides guidelines for proper grounding and, in particular, specifies that the cable ground shall be connected to the grounding system of the building, as close to the point of cable entry as practical.

Multi-zone

ZONE2 out Connections

If another pre-main (integrated) amplifier is connected, the ZONE2 out connectors can be used to play a different program source in ZONE2 the same time (page 54 ~ 57).

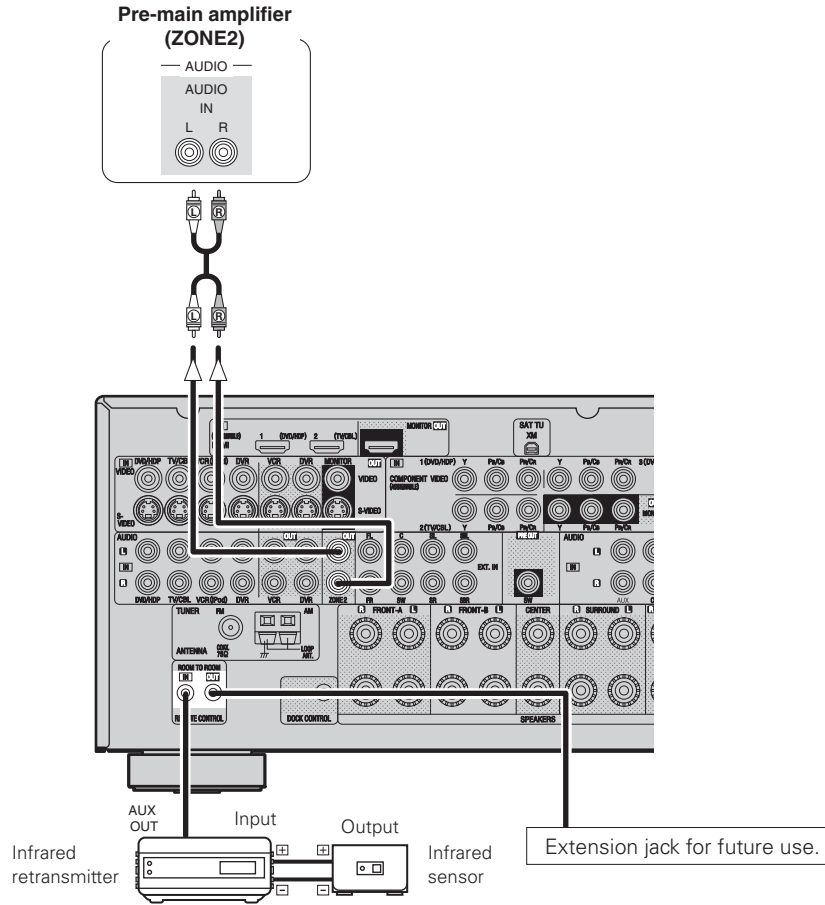

NOTE

- For the audio output, use high quality pin-plug cords so that no induction humming or noise is produced.
- For instructions on installing and operating separately sold devices, refer to the respective devices' operating instructions.
- To conduct multi-zone playback, see "Amp Assign / Multi-zone Connections and Operations" (page 54 ~ 57).

Connecting the Power Cord

Wait until all connections have been completed before connecting the power cord.

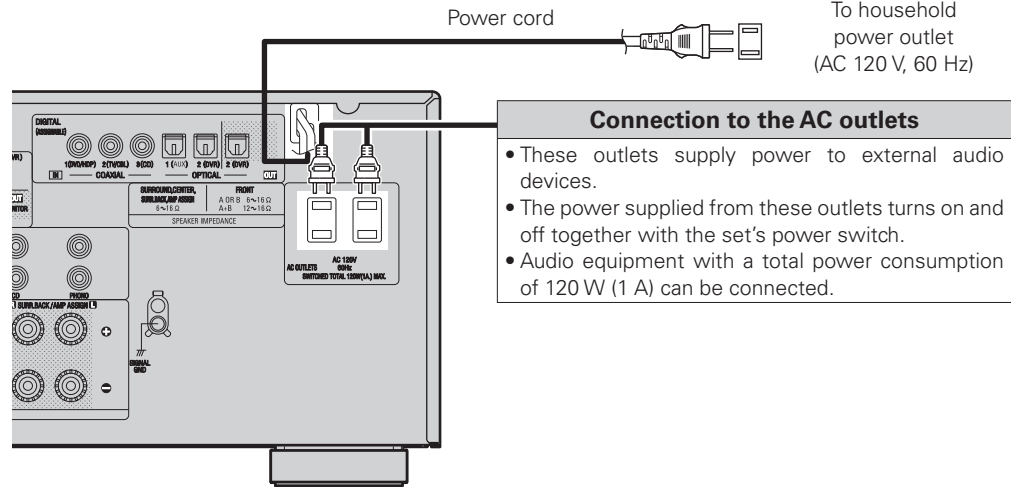

NOTE

- Insert the AC plugs securely. Incomplete connections could cause noise.
- Only use the AC outlets to plug in audio devices. Do not use them as power supplies for hairdryers or anything other than audio equipment.

Once Connections are Completed

Turning the Power On (page 43)

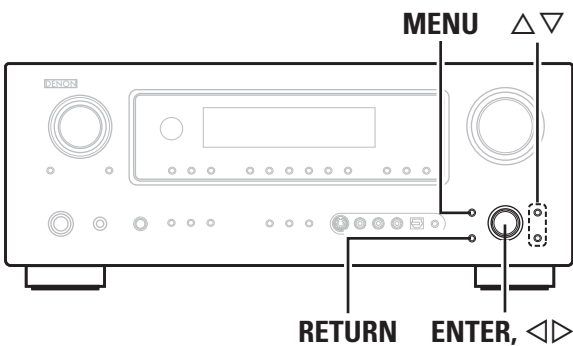

[Front]

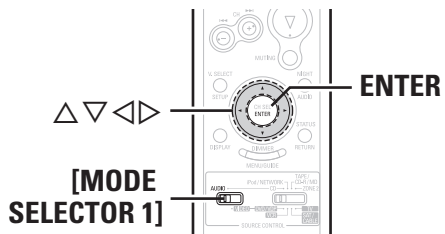

[Rear]

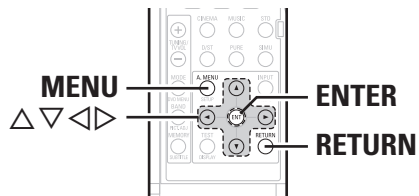

About the button names in these explanations
 < > : Buttons on the main unit
 [] : Buttons on the remote control unit
Button name only:
 Buttons on the main unit and remote control unit

Menu Operations

With the AVR-888, settings and operations for most functions can be performed by operating while looking at the menus displayed on the monitor screen.

Operations

The same operation is possible on the main unit or remote control unit.

- 1 Press MENU.**
The menu is displayed.
※ To operate from the remote control unit, be sure to set the **[MODE SELECTOR 1]** to "AUDIO".
- 2 Press $\Delta \nabla$ to select the item you want to set, then press ENTER.**
- 3 Press $\Delta \nabla$ again to select the item you want to set, then press ENTER.**
- 4 To change the setting:**
Press $\Delta \nabla$ to select the item you want to change, then press $\triangleleft \triangleright$ to change the setting.
※ To return to the previous item, press **RETURN**.
※ Select "Default Yes," then press \triangleleft to reset to the default setting.
- 5 Press ENTER to enter the setting.**
- 6 Press MENU to finish.**



When **MENU** is pressed, the settings made up to that point are entered and the settings menu screen turns off.

Example of Display of Default Values

In lists of selectable items or adjustable ranges, the item surrounded by a border is the default value.

[Selectable items] **A** B A + B

Examples of On-screen Display and Front Display

Some typical examples are described below.

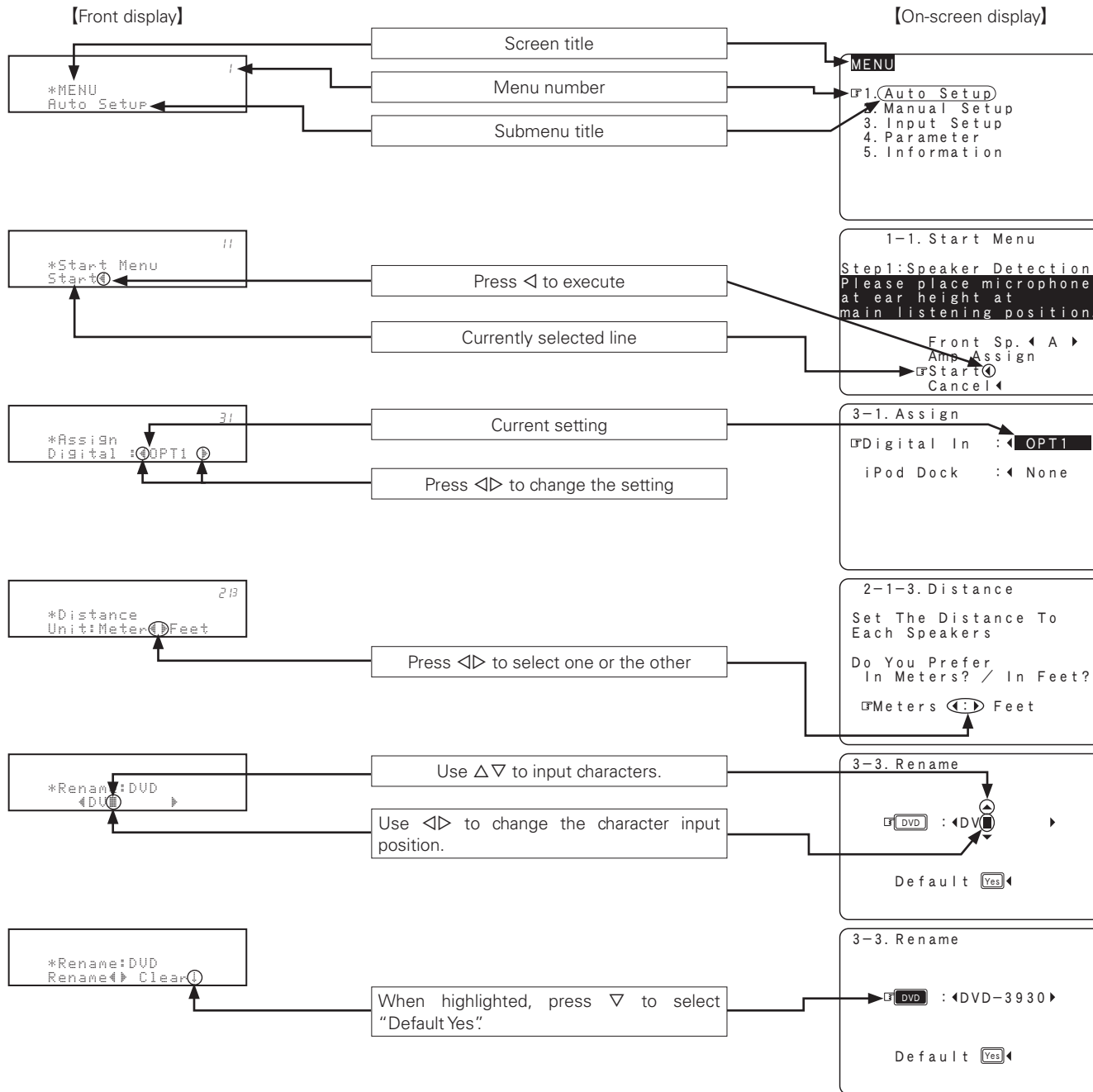

Menu Map

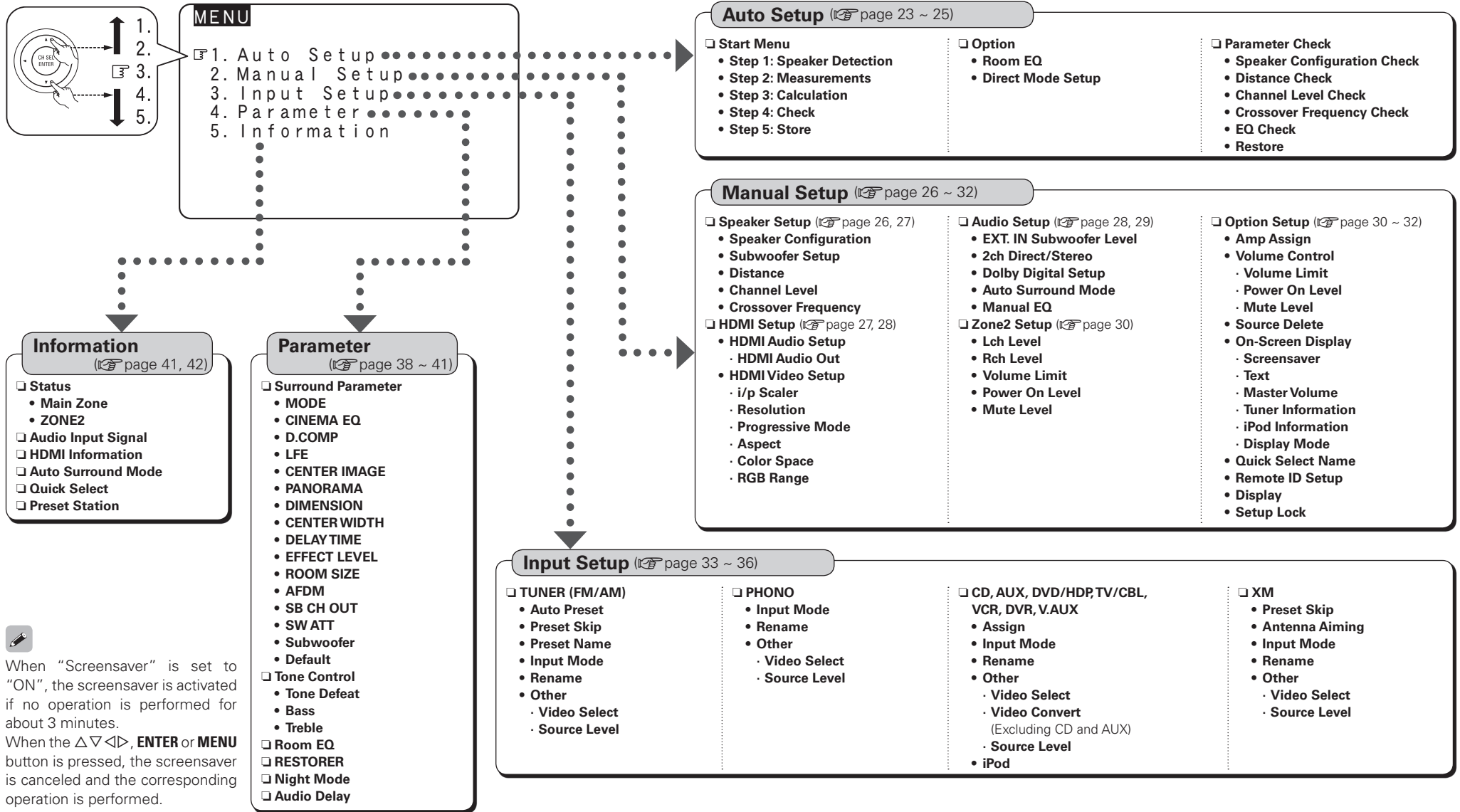

Auto Setup

- This procedure lets you measure the acoustic properties of your speakers and listening room and make the optimum settings automatically.
- This function provides the optimum listening environment for all listening positions in a home theater where several people view or listen to the video or audio source simultaneously.

The measurements are performed by moving the setup microphone successively to the different positions where the family members sit within the listening area surrounded by the speakers, as shown in **Example ①**. For better results, we recommend making measurements in 6 or more positions.

Even if the home theater is only used by a small number of persons as shown in **Example ②**, measuring at points around the listening position results in more effective correction.

Example ①

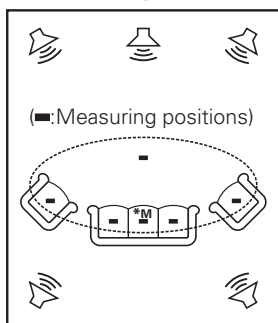

Example ②

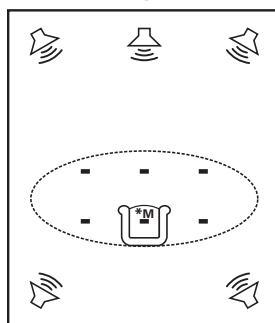

About the main listening position (*M)

The main listening position refers to the center of the listening position, or the place where you would sit to watch or listen when alone.

This position is used as the basis when measuring the distance of the speakers.



To set the listening environment manually to suit your tastes, see page 26, 27.

Preparations

1 Connect the included setup microphone to the **SETUP MIC** jack on the main unit.

The "Auto Setup" screen appears automatically.

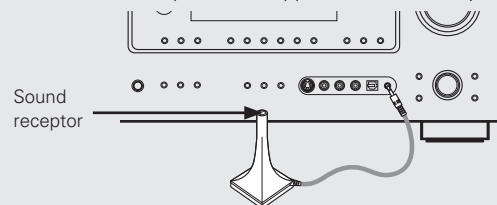

2 Mount the setup microphone on a camera tripod, etc., and set it at the main listening position, with the sound receptor pointing towards the ceiling.

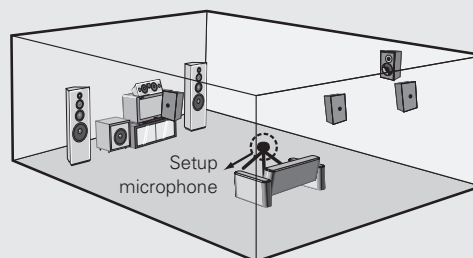

※ Adjust the height of the setup microphone's sound receptor so that it is at the height of the ears when listening.



When using a subwoofer with a setting function, make the following settings before starting the auto setup procedure:

- Volume: "Center"
- Crossover frequency: "Maximum"
- Low pass filter: "Off"
- Standby mode: "Off"

NOTE

- Do not disconnect the setup microphone until the auto setup procedure is completed.
- When using headphones, unplug the headphones before starting the auto setup procedure.

Auto Setup

Optimize settings for speakers in use.

● Menu screen ●

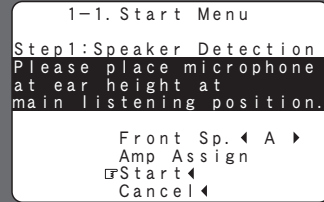

1 Start Menu

The settings are performed automatically.

Start

Start auto setup and output the test tone.



If an error message appears during the measurements, check "Error Messages"; take the necessary countermeasures, then redo the measurements (🔍 page 25).

Set as desired before starting the auto setup procedure.

Front Speaker

The front speaker to be measured can be selected ahead of time here.

[Selectable items]

A : Output test tone from front speakers A.

B : Output test tone from front speakers B.

A + B : Output test tone from front speakers A and B.

Amp Assign

Advanced setting : changes power amplifier assignment.
For details, refer to "Amp Assign" (🔍 page 30).

Step 1 : Speaker Detection

The speaker connection status and the speaker polarities are detected at the main listening position. At this time, the listening environment with respect to the main listening position ("Speaker size check", "Distance correction", "Channel level adjustment", "Crossover frequency check" and "Room EQ correction") is measured automatically at the main listening position.

Once the measurements are completed, the results of the speaker connection are displayed.

NOTE

- Loud test tones are output during the measurements. Be careful when measuring at night or when there are small children nearby.
- Do not stand between the speakers and setup microphone or allow obstacles between them while the measurements are being made. Obstacles will make it impossible to measure correctly.
- Keep as quiet as possible during measurements. Loud sounds in the area will make it impossible to measure correctly.
- Operating the **MASTER VOLUME** knob on the main unit or the **MASTER VOLUME** buttons on the remote control unit during the measurements will cancel the measurements.
- Do not change the speaker connections or subwoofer volume after "Step 1."

Step 2 : Measurements

The listening environment with respect to the listening position ("Speaker size check", "Crossover Frequency check" and "Room EQ correction") is measured automatically at positions 2 to 6.

Once a measurement is made, move the setup microphone to the next position.



Measurements can be completed even if only taken in 5 positions, but for better results we recommend taking them in **6 positions**.

Step 3 : Calculation

When "Calculate" is selected at "Step 2", the speaker system is analyzed automatically.



The time required for this analysis depends on the number of speakers connected. The more the number of speakers, the longer the time required for analysis.

Step 4 : Check

Once the auto setup procedure is completed, a measuring result checking screen appears.

Select any item whose measuring results you want to check and check the results.



Values that are different from the actual distance may be set for speakers with built-in filters (subwoofers, etc.).

Step 5 : Store

The auto setup measurement results are stored.

NOTE

Do not turn the power off while the settings are being stored in the memory.

Error Messages

If the auto setup procedure could not be completed due to speaker installation, the measuring environment, etc., an error message is displayed. If this happens, check the relevant items, be sure to take the necessary measures, then perform the auto setup procedure over again.

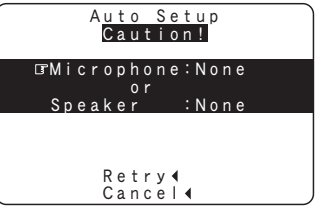
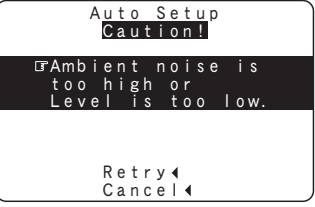
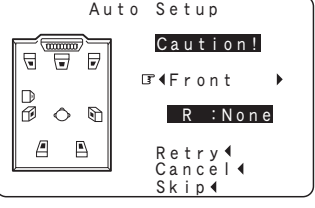
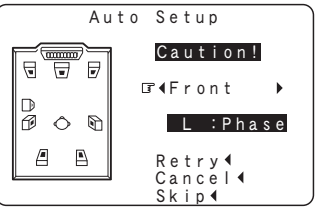
| Error messages (examples) | Cause | Measures |
|---|--|--|
|  | <ul style="list-style-type: none"> Included setup microphone is not connected. Not all speakers could be detected. | <ul style="list-style-type: none"> Connect the included setup microphone to the SETUP MIC jack on the main unit. Check the speaker connections. |
|  | <ul style="list-style-type: none"> Too much noise in the room for accurate measurements to be made. Speaker or subwoofer sound is too low for accurate measurements to be made. | <ul style="list-style-type: none"> Either turn off any device generating noise or move it away. Try again when the surroundings are quiet. Check the speaker installation and the direction in which the speakers are facing. Adjust the subwoofer's volume. |
|  | <ul style="list-style-type: none"> Displayed speaker could not be detected. <ul style="list-style-type: none"> The front L and front R speakers were not properly detected. Only one channel of the surround speakers was detected. Sound was output from the R channel when only one surround back speaker was connected. The surround back, but the surround speaker was not detected. | <ul style="list-style-type: none"> Check the connections of the displayed speaker. |
|  | <ul style="list-style-type: none"> Displayed speaker connected with the polarities reversed. | <ul style="list-style-type: none"> Check the polarities of the displayed speaker. For some speakers, this error message may be displayed even if the speaker is properly connected. In this case, select "Skip". |

 Select "Retry" to make the measurements again.

NOTE Be sure to turn the power off before checking the speaker connections.

2 Option

Select settings for room EQ, mic, etc.

Room EQ

Select room EQ setting method.

[Selectable items]

All : Apply settings to all surround modes.

Assign : Make settings for each surround mode separately.

Direct Mode Setup

Select room EQ use for DIRECT or PURE DIRECT mode.

[Selectable items]

ON : Use room EQ.

OFF : Do not use room EQ.

3 Parameter Check

Check auto setup measurement results.

This is displayed after the auto setup procedure is completed.

[Selectable items]

Speaker Config. Check

Distance Check

Channel Level Check

Crossover Freq. Check

EQ Check



The auto setup results can be set again when "Restore" is selected.

Manual Setup

Make detail settings for various parameters.

Speaker Setup

Use this procedure to set the speakers manually or if you wish to change the settings made with the auto setup procedure.

● Menu screen ●

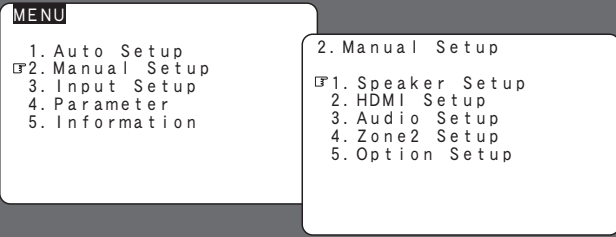

1 Speaker Configuration

Select speaker configuration and size.
(bass reproduction capability)

Front Speaker

Select front speaker size.

[Selectable items] **Large** **Small**

Center Speaker

Select center speaker use and size.

[Selectable items] **Large** **Small** **None**

Subwoofer

Select subwoofer use.

[Selectable items] **Yes** **No**

Surround Speaker

Select surround speakers use and size.

[Selectable items] **Large** **Small** **None**

Surround Back Speaker

Select surround back speaker use and size.

[Selectable items] (**Large** **Small** **None**)
(**2spkrs** **1spkr**)

NOTE

By default, the AVR-888's "Amp Assign" setting is set to "ZONE2". To use as the surround back speaker for the main zone, change the "Amp Assign" setting (🔧 page 30).

Large :Select this when using large speakers with ample low frequency reproduction capabilities.

Small :Select this when using small speakers without ample low frequency reproduction capabilities.

None :Select this when no speaker is connected.

Yes :Select this when a subwoofer is connected.

No :Select this when no subwoofer is connected.

2spkrs **1spkr** :

Select the number of surround back speakers.



- Select "Large" or "Small" not according to the physical size of the speaker but according to the low frequency reproduction capabilities based on the frequency set at "Crossover Frequency" (🔧 page 27).
- When "Front Speaker" is set to "Small", "Subwoofer" is automatically set to "Yes".
- If "Subwoofer" is set to "No", "Front Speaker" is automatically set to "Large".
- If "Surround Speaker" is set to "None", "Surround Back Speaker" are automatically set to "None".
- When using just one surround back speaker, connect it to the left channel (SBL).

2 Subwoofer Setup

Select low range signal to be reproduced by subwoofer.

[Selectable items]

LFE :Play low range and LFE signal of channels set to "Small".

LFE+Main :Play low range and LFE signal of all channels.



- This can be set when menu "Speaker Configuration" – "Subwoofer" is set to "Yes".
- Play music or a movie source and select the mode offering the strongest bass.
- Select "LFE+Main" if you want the bass signals to always be produced from the subwoofer.

3 Distance

Set distance from listening position to speakers.

Before making the settings, measure the distance from the listening position to the different speakers.

Feet / Meters

Select unit for distance.

Step

Select step. (smallest distance)

[Selectable items]

1ft **0.1ft** : Can be selected when "Feet" is set.

0.1m **0.01m** : Can be selected when "Meters" is set.

Default

Resets the settings to the default values.

Distance measurement

Select the speaker you want to set, then set the distance. Set the value closest to the measured distance.

[Variable range]

0.0ft ~ 60.0ft : Display when "Feet" is set.

0.00m ~ 18.00m : Display when "Meters" is set.

NOTE

Set the distance between the listening position and the various speakers to no more than 20.0 ft (6.00 meters).

4 Channel Level

Adjust channel levels to obtain equal volume from all speakers.

Test Tone

Select test tone playback method.

[Selectable items]

Auto : Automatically switch speaker from which test tone is output.

Manual : Manually switch speaker from which test tone is output.

Test Tone Start

Output test tone.

[Variable range] **-12dB** ~ **0dB** ~ **+12dB**

Default

Resets the settings to the default values.



Operating from the remote control unit

Adjusting with the remote control unit using the test tones is only possible in the "Auto" mode and only effective in the STANDARD mode. The adjusted levels for the different modes are automatically stored in the memory.

[Adjusting using test tones]

- Press the **TEST** button.
Test tones are output from the various speakers.
- Use the **< >** button to adjust so that the volume is equal for all speakers.
- When the adjustments are completed, press the **TEST** button again.



- When the menu "Speaker Configuration" – "Surround Back Speaker" setting (page 26) is set to "1spkr"; the surround back speaker display is set to "Surround Back Sp."
- Speakers set to "None" in the "Speaker Configuration" settings are not displayed.
- When "Channel Level" is adjusted, the adjusted values are set for all the surround modes. To adjust the channel level separately for the different surround modes, use the operation see page 48.

5 Crossover Frequency

Select crossover frequency from which subwoofer handles low range signal.

[Selectable items]

40Hz **60Hz** **80Hz** **90Hz** **100Hz** **110Hz** **120Hz** **150Hz**
200Hz **250Hz** :

Only the portion of the bass sound of the various speakers output from the subwoofer that has a frequency below the frequency set here is output.

Set this according to the low frequency reproduction capabilities of the speakers you are using.

Advanced :

Set the crossover frequency separately for the different speakers.



- The "Crossover Frequency" can be set when there are speakers that have been set to "Small" at menu "Speaker Configuration" or when "Subwoofer" is set to "Yes" (page 26).
- If menu "Subwoofer Setup" (page 26) is set to "LFE"; speakers set to "Small" at "Speaker Configuration" can be set. If set to "LFE+Main", this can be set regardless of the size of the speaker.
- For speakers set to "Small", sound below the crossover frequency is cut from the sound output. The cut bass sound is output from the subwoofer or front speakers.
- Always set the crossover frequency to "80 Hz". When using small speakers, however, we recommend setting the crossover frequency to a higher frequency.

HDMI Setup

Make settings for HDMI video/audio output.

● Menu screen ●

2. Manual Setup

1. Speaker Setup
2. HDMI Setup
3. Audio Setup
4. Zone2 Setup
5. Option Setup

2-2. HDMI Setup

1. HDMI Audio Setup
2. HDMI Video Setup

1 HDMI Audio Setup

Select HDMI audio output device.

HDMI Audio Out

Select test tone playback method.

[Selectable items]

AMP : Use speakers connected to receiver for audio playback.

TV : Use speakers of monitor for audio playback.

2 HDMI Video Setup

Select HDMI video output device.

i/p Scaler

Make settings for i/p scaler function.

[Selectable items]

A to H : Use i/p scaler function for analog video signal.

OFF : Do not use i/p scaler function.

Resolution

Make settings for resolution of HDMI video output signal.

[Selectable items]

Auto : Detect monitor panel resolution and automatically set output resolution.

480p/576p : Output at 480p/576p resolution.

1080i : Output at 1080i resolution.

720p : Output at 720p resolution.

1080p : Output at 1080p resolution.



This can be set when "i/p Scaler" is set to anything other than "OFF".

NOTE

- It is not possible to convert "1080i" signals into "720p" format.
- It is not possible to convert "720p" signals into "1080i" format.

Progressive Mode

Select optimum progressive mode for video material.

[Selectable items]

Auto : Automatically detect video material type.

Video1 : Select mode suitable for video playback.

Video2 : Select mode suitable for video and 30-frame film material playback.



This can be set when "i/p Scaler" is set to anything other than "OFF".

Aspect

This sets the aspect ratio when outputting 480i/576i or 480p/576p input signals from the HDMI output connector.

[Selectable items]

FULL : Output at 16:9 aspect ratio.

NORMAL : Output at 4:3 aspect ratio.



This can be set when "i/p Scaler" is set to anything other than "OFF".

Color Space

Make settings for output color space.

[Selectable items]

YCbCr : Output using YCbCr format.

RGB : Output using RGB format.



When connected to a monitor with a DVI-D connector (HDCP compatible) using an HDMI/DVI converter cable, the signals are output in RGB format, regardless of this setting.

RGB Range

Make settings for RGB output range.

[Selectable items]

Normal : Use video range from 16 (black) to 235 (white).

Enhanced : Video range from 0 (black) to 255 (white). Use this setting to avoid black washout.

Audio Setup

Make settings for audio playback.

● Menu screen ●

2. Manual Setup

1. Speaker Setup
2. HDMI Setup
3. Audio Setup
4. Zone2 Setup
5. Option Setup

2-3. Audio Setup

1. EXT. IN SW Level
2. 2ch Direct/Stereo
3. Dolby Digital Setup
4. Auto Surround Mode
5. Manual EQ

1 EXT. IN Subwoofer Level

Set the subwoofer level for playback.
Select according to the player in use.

[Selectable items]

0dB **+5dB** **+10dB** :

Select according to the player in use.

+15dB :

This is the recommended level.

2 2ch Direct/Stereo

Make speaker settings for 2-channel mode playback.

Setting

To change the settings, select "Custom".

[Selectable items]

Basic* : To change the settings, select "Custom".

Custom : Make separate settings for 2-channel mode.

* : Use the same settings as in "Speaker Setup".

Front

Select front speaker size.

[Selectable items]

Large **Small** : Select front speaker size.

Subwoofer

Select subwoofer use.

[Selectable items]

Yes **No** : Select subwoofer use.

Subwoofer Mode

Select low range signal to be reproduced by subwoofer.

[Selectable items]

LFE **LFE+Main** : Select subwoofer signal.

Crossover

Select crossover frequency from which subwoofer handles low range signal.

[Selectable items]

40Hz **60Hz** **80Hz** **90Hz** **100Hz** **110Hz** **120Hz** **150Hz**
200Hz **250Hz** : Select crossover frequency.

Distance FL

Set distance from listening position to front left speaker.

[Variable range] **0.0ft ~ 60.0ft**

Distance FR

Set distance from listening position to front right speaker.

[Variable range] **0.0ft ~ 60.0ft**

3 Dolby Digital Setup

Set dynamic range for downmix playback of Dolby Digital sources.

[Selectable items]

ON : Compression is used. Select this if sound from front speakers is distorted.

OFF : Do not use compression. This is the recommended setting.



- Set this to "ON" if the sound from the front speakers seems distorted.
- When not using the center speaker or surround speakers, the playback sound is down-mixed and output from the front speakers.

4 Auto Surround Mode

Make setting for memorizing surround mode setting for each input signal type.

[Selectable items]

ON : Memorize settings. Most recently stored surround mode is automatically selected.

OFF : Do not memorize settings. Surround mode does not change according to input signal.



- The auto surround mode function lets you store in the memory the surround mode last used for playing the four types of input signals listed below.
 - ① Analog and PCM 2-channel signals
 - ② Dolby Digital and DTS 2-channel signals
 - ③ Dolby Digital and DTS multi-channel signals
 - ④ Multi-channel signals other than Dolby Digital and DTS (PCM, etc.)
- When playing in the PURE DIRECT mode, the surround mode does not change even if the input signal is changed.

5 Manual EQ

Adjust tonal quality for each speaker using graphic equalizer.

Base Curve Copy

Copy the Room EQ's "Audyssey Flat" correction curve.

[Selectable items]

Yes **No**



"Base Curve Copy" is displayed after the auto setup procedure has been performed.

Adjust CH

Select speaker adjustment method.

[Selectable items]

Each CH : Adjust tonal quality for each speaker separately.

L/R CH : Adjust tonal quality for each L/R speaker pair.

ALL CH : Adjust tonal quality for all speakers together.

Manual EQ

Select the speaker and frequency band and adjust the level.

[Selectable items] **63Hz** **125Hz** **250Hz** **500Hz** **1kHz**
2kHz **4kHz** **8kHz** **16kHz**

[Variable range] **-20dB ~ +6dB**

Default

Resets the settings to the default values.

Zone2 Setup

Make settings for audio playback in a ZONE2 system.

● Menu screen ●

2. Manual Setup

- 1. Speaker Setup
- 2. HDMI Setup
- 3. Audio Setup
- 4. Zone2 Setup
- 5. Option Setup

2-4. Zone2 Setup

Level Lch : ◀ 0dB ▶
 Rch : ◀ 0dB ▶
 Vol. Limit : ◀ OFF ▶
 Power On Lev. : ◀ Last ▶
 Mute Lev. : ◀ Full ▶

1 Lch Level

Adjust the left channel output level.

[Variable range] **-12dB** ~ **0dB** ~ **+12dB**

2 Rch Level

Adjust the right channel output level.

[Variable range] **-12dB** ~ **0dB** ~ **+12dB**

3 Volume Limit

Make a setting for maximum volume.

[Selectable items]

- OFF** : Do not set a maximum volume.
- 20dB** : Set the maximum volume to -20 dB.
- 10dB** : Set the maximum volume to -10 dB.
- 0dB** : Set the maximum volume to 0 dB.

4 Power On Level

Define the volume setting that is active when the power is turned on.

[Selectable items]

- Last** : Use the memorized setting from the last session.
- : Always use the muting on condition when power is turned on.
- 70dB ~ +18dB** : Set the volume level when the power is turned on in units of 1 dB.

5 Mute Level

Set the amount of attenuation when muting is on.

[Selectable items]

- Full** : The sound is cut off entirely.
- 40dB** : The sound is attenuated by 40 dB.
- 20dB** : The sound is attenuated by 20 dB.

Option Setup

Make various other settings.

● Menu screen ●

2. Manual Setup

- 1. Speaker Setup
- 2. HDMI Setup
- 3. Audio Setup
- 4. Zone2 Setup
- 5. Option Setup

2-5. Option Setup

- 1. Amp Assign
- 2. Vol. Control
- 3. Source Delete
- 4. On-Screen Display
- 5. Quick Select Name
- 6. Remote ID Setup
- 7. Display
- 8. Setup Lock

1 Amp Assign

Define how the amplifier for the surround back speaker channels is used.

The places where the surround back amplifier are used can be set freely according to the usage environment. This makes it possible to output sound to rooms other than the room (the main zone) where surround playback is performed (multi-zone playback) or play the sound with high quality using the front speakers (bi-amp connections).

[Selectable items]

7.1ch **ZONE2** **FrontA Bi-Amp** **FrontB Bi-Amp** **2ch**



For details, see "Amp Assign / Multi-zone Connections and Operations" (page 54 ~ 56).

2 Volume Control

Set the main zone volume setting.

Volume Limit

Make a setting for maximum volume.

[Selectable items]

OFF : Do not set a maximum volume.

-20dB : Set the maximum volume to -20 dB.

-10dB : Set the maximum volume to -10 dB.

0dB : Set the maximum volume to 0 dB.

Power On Level

This sets the volume set when the main zone's power is turned on.

[Selectable items]

Last : Use the memorized setting from the last session.

--- : Always use the muting on condition when power is turned on.

-80dB ~ +18dB : Set the volume level when the power is turned on in units of 1 dB.

Mute Level

This sets the amount of attenuation of the volume when the mute mode is set in the main zone.

[Selectable items]

Full : The sound is cut off entirely.

-40dB : The sound is attenuated by 40 dB.

-20dB : The sound is attenuated by 20 dB.

3 Source Delete

Remove input sources that are not used from the display.

[Selectable items]

ON : Use this source.

Delete : Do not use this source.

NOTE

- Input sources being used in the various zones cannot be deleted.
- Input sources set to "Delete" cannot be selected using the **SOURCE SELECT** knob on the main unit or **SOURCE SELECT** button on the remote control unit.

4 On-Screen Display

Make on-screen display related settings.

Screensaver

Make screensaver settings.

Use the screensaver to prevent burn-in on the monitor screen.

When set to "ON," the screensaver is activated if there is no activity for about 3 minutes.

[Selectable items]

ON : Activate the screensaver if there is no activity for about 3 minutes.

OFF : Turn the screensaver function off.

Text

Input source and mode display.

[Selectable items]

ON : Turn display on.

OFF : Turn display off.

Master Volume

Master volume display during adjustment.

[Selectable items]

ON : Turn display on.

OFF : Turn display off.

Tuner Information

This sets the time the on-screen display is displayed when an operation is performed.

[Selectable items]

Always : Show display continuously.

30sec : Show display for 30 seconds after operation.

10sec : Show display for 10 seconds after operation.

OFF : Turn display off.

iPod Information

This sets the time the on-screen display is displayed when an operation is performed.

[Selectable items]

Always : Show display continuously.

30sec : Show display for 30 seconds after operation.

10sec : Show display for 10 seconds after operation.

OFF : Turn display off.

Display Mode

Select the on-screen display's display mode.

[Selectable items]

Mode1 : If there is no video signal, flickering of the on-screen display is not prevented.

Mode2 : Prevents flickering of the on-screen display when there is no video signal.

Use this mode if the on-screen display does not appear in the Mode 1, as may happen according to the TV being used.

5 Quick Select Name

Change the Quick Select name.
Up to 16 characters can be input.

[Input characters]

A~Z **a~z** **0~9** **!"#%&'()*+,-./:;= (space)**

6 Remote ID Setup

Set remote control ID.

[Selectable items]

1 **2** **3** **4**

NOTE

When using the AVR-888 with only the included remote control unit (RC-1080), there is no need to make settings.

7 Display

Adjust display brightness of the receiver.

[Selectable items]

- Bright** : Normal display brightness.
- Dim** : Reduced display brightness.
- Dark** : Very low display brightness.
- OFF** : Display is off unless controls are operated.



Operating from the main unit

Press the **DIMMER** button.



8 Setup Lock

Protect settings from inadvertent change.

[Selectable items]

ON : Turn protection on.

OFF : Turn protection off.



- When "Setup Lock" is set to "ON", the settings listed below can no longer be changed. Also, "SETUP LOCKED!" is displayed if you attempt to operate related buttons.
 - Menu operations
 - RESTORER
 - Night Mode
 - Parameter
 - Room EQ
 - Channel Level
 - Audio Delay
- To cancel the setting, press the **MENU** button to re-display the "Setup Lock" screen, then change the setting to "OFF".

Input Setup

Use this procedure to select the input source and make the settings related to playing input sources.

TUNER (AM/FM)

This menu is for "TUNER".

Menu screen

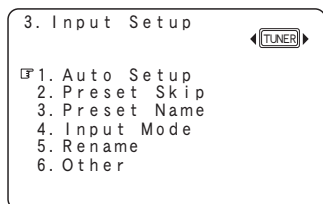

XM

This menu is for "XM".

Menu screen

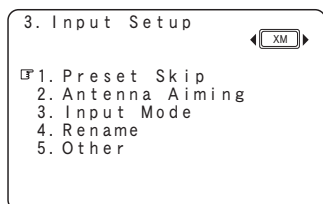

PHONO

This menu is for "PHONO".

Menu screen

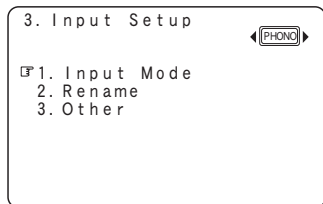

CD, AUX, DVD/HDP, TV/CBL, VCR, DVR, V.AUX

This menu is for "CD", "AUX", "DVD/HDP", "TV/CBL", "VCR", "DVR", "V.AUX".

Menu screen

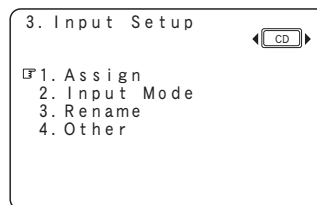

※ The menu settings below can be made for these input sources when "iPod dock" is set to "Assign".

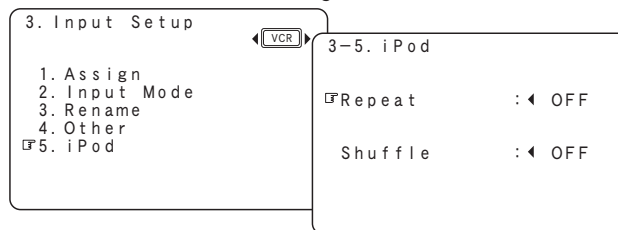

Changing the input source within Input Setup

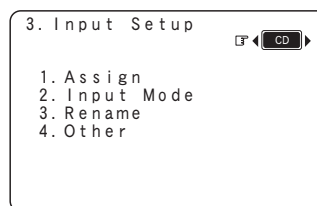

The input source currently selected in the main zone is not changed even when the input source within Input Setup is changed.

Settings Related to Playing Input Sources

Auto Preset

Use the auto preset function to program radio stations.

[Input source] **TUNER**

[Selectable items]

Start : Start the auto preset process.



If an FM station cannot be preset automatically, select the desired station by tuning it in manually, then preset it manually.

Preset Skip

Set the preset memories that you do not want to display when tuning.

A ~ G

Select the preset channel(s) you do not want to display.

[Input source] **TUNER** **XM**

[Selectable items]

ON : Display this number.

Skip : Skip this number.

Preset Name

Assign name to a preset memory.
Names containing up to 8 characters can be input.

A1 ~ G8

Select the preset memory number.

[Input source] **TUNER**

[Characters that can be input]

A ~ Z **a ~ z** **0 ~ 9** **! " # % & ' () * + , - . / : ; = (space)**

Input Mode

Make input mode and decode mode settings for this source. The selectable input modes depend on the input source and "Assign" setting (☞ page 34, 35).

Input Mode

Set the input mode for this source.

[Input source] **TUNER** **PHONO**

[Selectable items]

Analog : Play only signals from analog input.

EXT. IN : Play only signals from EXT. IN input.

[Input source] **XM**

[Selectable items]

Auto : Automatically detect input signal and perform playback.

EXT. IN : Play only signals from EXT. IN input.

[Input source] **CD** **AUX** **DVD/HDP** **TV/CBL** **VCR** **DVR**
V.AUX

[Selectable items]

Auto : Automatically detect input signal and perform playback.

HDMI *1: Play only signals from HDMI input. (Excluding CD and AUX)

Digital *2: Play only signals from digital input.

Analog : Play only signals from analog input.

EXT. IN : Play only signals from EXT. IN input.

*1: This can be selected for input sources for which the menu "Assign" setting is set to "HDMI".

*2: This can be selected for input sources for which the menu "Assign" setting is set to "Digital In" (☞ page 35).



- When a digital signal is properly input, the "DIGITAL" or "HDMI" indicator lights on the display. If the "DIG." indicator does not light, check the digital input connector assignment and the connections.
- The surround mode cannot be set if the input mode is set to "EXT. IN".



Operating from the main unit or remote control unit

[Operation on the main unit]

- Selecting the "Auto," "HDMI" or "Digital" mode
Press the **INPUT MODE** button.



- Selecting the analog mode
Press the **ANALOG** button.

- Selecting the EXT.IN mode
Press the **EXT.IN** button.

[Operation on the remote control unit]

Press the **INPUT** button.



Decode Mode

Set the decode mode for this source.

[Input source] **CD** **AUX** **DVD/HDP** **TV/CBL** **VCR** **DVR**
V.AUX

[Selectable items]

Auto : Detect type of digital input signal and decode and play automatically.

PCM : Decode and play only PCM input signals.

DTS : Decode and play only DTS input signals.



- This can be selected for input sources for which the menu "Assign" setting is set to "HDMI" or "Digital In" (☞ page 35).
- Only set "PCM" and "DTS" when playing the respective signals.

Rename

Change the display name for this source. Names containing up to 8 characters can be input.

[Characters that can be input]

A ~ Z **a ~ z** **0 ~ 9** **! " # % & ' () * + , - . / : ; = (space)**

Assign

Assign input sources to input connectors.

HDMI

Select HDMI connector to assign to this source.

[Input source] **DVD/HDP** **TV/CBL** **VCR** **DVR** **V.AUX**

[Selectable items]

HDMI1 : Assign HDMI1 input connector.

HDMI2 : Assign HDMI2 input connector.

None : No HDMI input connector assigned.

| Input source | DVD/HDP | TV/CBL | VCR | DVR | V.AUX |
|-----------------|--------------|--------------|------|------|-------|
| Default setting | HDMI1 | HDMI2 | None | None | None |



- With HDMI, the video and audio signals are transferred simultaneously. When HDMI is assigned to an input source, the audio signal switches to HDMI along with the video signal. To use with the digital audio input connectors assigned, set menu "Input Mode" to "Digital".
- When the AVR-888 and monitor are connected with an HDMI cable, if the monitor is not compatible with HDMI audio signal playback, only the video signals are output to the monitor.
- The audio signals input from the analog, digital and EXT. IN connectors are not output to the monitor.

NOTE

This cannot be set for input sources for which "iPod dock" is assigned.

Digital In

Select digital input connector to assign to this source.

[Input source] **CD** **AUX** **DVD/HDP** **TV/CBL** **VCR** **DVR**
V.AUX

[Selectable items]

- COAX1** : Assign COAXIAL 1 input connector.
- COAX2** : Assign COAXIAL 2 input connector.
- COAX3** : Assign COAXIAL 3 input connector.
- OPT1** : Assign OPTICAL 1 input connector.
- OPT2** : Assign OPTICAL 2 input connector.
- OPT3** : Assign OPTICAL 3 input connector.
- None** : No digital input connector assigned.

| Input source | CD | AUX | DVD/HDP | TV/CBL | VCR | DVR | V.AUX |
|-----------------|--------------|-------------|--------------|--------------|------|-------------|-------------|
| Default setting | COAX3 | OPT1 | COAX1 | COAX2 | None | OPT2 | OPT3 |

NOTE

This cannot be set for input sources for which "iPod dock" is assigned.

Component In

Select component video input to assign to this source.

[Input source] **DVD/HDP** **TV/CBL** **VCR** **DVR** **V.AUX**

[Selectable items]

- 1-RCA** : Assign component video 1 input connector.
- 2-RCA** : Assign component video 2 input connector.
- 3-RCA** : Assign component video 3 input connector.
- None** : No component video input connector assigned.

| Input source | DVD/HDP | TV/CBL | VCR | DVR | V.AUX |
|-----------------|--------------|--------------|------|--------------|-------|
| Default setting | 1-RCA | 2-RCA | None | 3-RCA | None |



This cannot be set for input sources for which "iPod dock" is assigned.

iPod dock

Assign Control Dock for iPod to this source.

[Input source] **CD** **AUX** **DVD/HDP** **TV/CBL** **VCR** **DVR**
V.AUX

[Selectable items]

- Assign** : Assign iPod input.
- None** : Do not assign iPod input.



- With the default settings, the Control Dock for iPod can be used connected to the VCR (iPod) connector.
- Even if "iPod dock" is set to "Assign", if the AVR-888 is not connected to a Control dock for iPod, the input source can be used as the normal input source.

iPod

Make settings for "iPod" playback.

[Input source] **CD** **AUX** **DVD/HDP** **TV/CBL** **VCR** **DVR**
V.AUX

Repeat

Make settings for repeat mode.

[Selectable items]

- All** : Repeat all songs.
- One** : Repeat the current song.
- OFF** : Cancel repeat mode.

Shuffle

Make settings for shuffle mode.

[Selectable items]

- Songs** : Shuffle all songs.
- Albums** : Shuffle songs from current album only.
- OFF** : Cancel shuffle mode.



This can be selected for input sources for which "Assign" is assigned at the "iPod dock" setting.

Other

Make various other settings.

Video Select

Switch video input source while listening to audio signal.

[Selectable items]

DVD/HDP **TV/CBL** **VCR** **DVR** **V.AUX** :

Select video input source to view.

Source :

The video and audio for the same input source are played.



Operating from the main unit or remote control unit

- Press the **VIDEO SELECT** button on the main unit or the **V. SELECT** button on the remote control unit until the desired picture appears.
- ※ To cancel, press the **VIDEO SELECT** button on the main unit or the **V. SELECT** button on the remote control unit to select "Source".

NOTE

- It is not possible to select HDMI input signals.
- When playing HDMI video input signals, the analog video signal of another input source cannot be selected for the HDMI video output.
- Input sources for which "Delete" is selected at "Source Delete" cannot be selected.

Video Convert

Automatically convert video input signal to monitor output format.

[Input source] **DVD/HDP** **TV/CBL** **VCR** **DVR** **V.AUX**

[Selectable items]

ON : Enable conversion.

OFF : Disable conversion.

NOTE

When a non-standard video signal from a game machine or some other source is input, the video conversion function might not operate. If this happens, please set the conversion mode to "OFF".

Source Level

Corrects the playback level of the selected input source's audio input.

[Variable range] **-12dB** ~ **0dB** ~ **+12dB**



For input sources for which "HDMI" and "Digital In" are set at the menu "Assign" setting, the analog input level and digital input level can be set separately.

Antenna Aiming

Adjust the XM radio reception sensitivity.

[Input source] **XM**

Satellite

Indicate satellite signal strength.

Terrestrial

Indicate terrestrial signal strength.

| Display | Condition |
|---------|-----------------------------|
| ■■■■■ | Signal strength is strong |
| ■■■■ | Signal strength is good |
| ■■■ | Signal strength is marginal |
| ■■ | Signal strength is weak |
| ■ | No signal |

Surround Modes

Standard Playback

This is the standard mode for enjoying surround sound according to the program source.

Surround Playback of 2-channel Sources

To select these surround modes using the buttons on the remote control unit, press the **STD** button. The mode switches each time the button is pressed.

When using a surround back speaker

[Selectable items] **DOLBY PLIIx** **DTS NEO:6** **neural**

When not using a surround back speaker

[Selectable items] **DOLBY PLII** **DTS NEO:6** **neural**

DOLBY PLIIx or **DOLBY PLII** : The signals are decoded in DOLBY PLIIx or DOLBY PLII for playback.

→ **Cinema** : This mode is suited for movie sources.

→ **Music** : This mode is suited for music sources.

→ **Game** : This mode is suited for games.

→ **Pro Logic** : This is the Pro Logic playback mode. This can be selected when playing with a DOLBY PLII decoder. When this mode is selected, "DOLBY PL" is displayed.

DTS NEO:6 : The signals are decoded in DTS NEO:6 for playback.

→ **Cinema** : This mode is suited for movie sources.

→ **Music** : This mode is suited for music sources.

neural : It is possible to play analog input signals and PCM (2-channel, 48 kHz or less) in the surround mode. This is the optimum mode for playing sources recorded in XM HD Surround (page 60).



Select the "Cinema", "Music", "Game" and "Pro Logic" modes at menu "Parameter" - "Surround Parameter" - "MODE" (page 38).

Playing Multi-channel Sources (Dolby Digital, DTS, etc.)

[Selectable items]

STANDARD :

This mode is for decoding the input signals according to their format and playing surround sound. The display when the STANDARD mode is selected depends on the input signal and surround back output playback mode.

| Input signal | | Display |
|----------------------|---|----------------------------|
| Dolby Digital Source | DOLBY DIGITAL (other than 2ch) / DOLBY DIGITAL EX | DOLBY DIGITAL |
| | | DOLBY DIGITAL EX |
| DTS Surround Source | DTS (5.1ch) / DTS-ES Discrete 6.1 / DTS-ES Matrix 6.1 / DTS 96/24 | DOLBY DIGITAL+PLIIx CINEMA |
| | | DOLBY DIGITAL+PLIIx MUSIC |
| | | DTS SURROUND |
| | | DTS+PLIIx CINEMA |
| | | DTS+PLIIx MUSIC |
| | | DTS+NEO:6 |
| DVD-Audio | PCM (multi ch) | DTS ES MTRX6.1 (*1) |
| | | DTS ES DSCRT6.1 (*2) |
| | | DTS 96/24 (*3) |
| | | MULTI CH IN |
| | | MULTI IN+PLIIx CINEMA |
| | | MULTI IN+PLIIx MUSIC |
| | | MULTI CH IN 7.1 |

*1 : This is displayed when the input signal is "DTS-ES Matrix 6.1" and the AVR-888's "AFDM" setting is set to "ON".

*2 : This is displayed when the input signal is "DTS-ES Discrete 6.1".

*3 : This is displayed when the input signal is "DTS 96/24".



For details, see page 63.

DSP Simulation Playback

The desired mode according to the program source and viewing situation can be selected from among 7 DENON original surround modes.

The surround parameters can be adjusted (page 61, 62) to achieve an even more realistic, powerful sound field.

[Selectable items]

7CH STEREO : This mode is for enjoying stereo sound from all speakers.

ROCK ARENA : This mode is for enjoying the atmosphere of a live concert in an arena.

JAZZ CLUB : This mode is for enjoying the atmosphere of a live concert in a jazz club.

MONO MOVIE * : This mode is for playing monaural movie sources with surround sound.

VIDEO GAME : This mode is suited for achieving surround sound with video games.

MATRIX : This mode lets you add a sense of expansion to stereo music sources.

VIRTUAL : This mode is for enjoying surround effects using only the front speakers or headphones.

* : When playing sources recorded in monaural in the MONO MOVIE mode, the sound will be off balance with a single channel (left or right), so input to both channels.



- To select these surround modes using the buttons on the remote control unit, press the **SIMU** button. The mode switches each time the button is pressed.
- Depending on the program source being played, it may not be possible to achieve a satisfactory surround effect. In this case, try other modes to achieve a sound field suited to your tastes.

Stereo Playback

[Selectable items]

STEREO :

This is the mode for playing in stereo. The tone can be adjusted. Sound is output from the front left and right speakers and subwoofer.

Direct Playback

[Selectable items]

DIRECT :

In this mode the signals bypass the tone adjustment circuitry for high quality sound.

The sound is output to the same channels as the input signal.

The display when the DIRECT mode is selected depends on the input signal.

For multi-channel sources, the display depends on the surround back output's play mode.

| Input signal | Display |
|---|-------------------------|
| Analog signal / PCM (2ch) / Dolby Digital source / DTS source / Other 2-channel digital signals | DIRECT |
| PCM (multi ch) | MULTI CH DIRECT |
| | M DIRECT + PLIIx CINEMA |
| | M DIRECT + PLIIx MUSIC |
| | M DIRECT 7.1 |



For details, see page 64.

Playback in the PURE DIRECT Mode

This is the mode that recreates the original sound most faithfully, providing extremely high quality sound.

Press the **PURE** button on the remote control unit.



- When in the PURE DIRECT mode, the on-screen display is not displayed and the display on the main unit is turned off.
- If the HDMI input connector is selected, video outputs are output in the PURE DIRECT mode.
- The channel level and surround parameters in the PURE DIRECT mode are the same as in the DIRECT mode.

Parameter

● Menu screen ●

4. Parameter

1. Surround Parameter
2. Tone Control
3. Room EQ
4. RESTORER
5. Night Mode
6. Audio Delay

1 Surround Parameter

Adjust surround sound parameters.

The adjustable parameters differ for the different surround modes (page 61, 62).

MODE

Select the mode according to the playback source.

In the PLIIx or PLII mode

[Selectable items] **CINEMA** **MUSIC** **GAME** **PL** *

*: Can be selected in the PLII mode.

In the DTS NEO:6 mode

[Selectable items] **CINEMA** **MUSIC**

CINEMA : Surround sound mode optimized for movie sources.

MUSIC : Surround sound mode optimized for music sources.

GAME : Surround sound mode optimized for games.

PL : Dolby Pro Logic playback mode.



The MUSIC mode is also effective for movie sources including a lot of stereo music.

CINEMA EQ

Soften the treble range of movie soundtracks for better understanding.

[Selectable items]

ON : CINEMA EQ is used.

OFF : CINEMA EQ is not used.

D.COMP

Compress dynamic range (difference between loud and soft sounds).

[Selectable items]

OFF : Turn dynamic range compression off.

LOW : Low setting.

MID : Middle setting.

HIGH : High setting.



When playing DTS sources, this is only displayed for compatible software.

LFE

Adjust the low-frequency effects level (LFE).

[Variable range] **-10dB** ~ **0dB**



For proper playback of the different program sources, we recommend setting to the values below.

- Dolby Digital sources: "0 dB"
- DTS movie sources: "0 dB"
- DTS music sources: "-10 dB"

CENTER IMAGE

Assign center channel signal to front left and right channels for wider sound.

[Variable range] **0.0** ~ **0.3** ~ **1.0**

PANORAMA

Assign front L/R signal also to surround channels, for wider sound. If the surround effect seems weak, set "PANORAMA" to "ON".

[Selectable items] **ON** **OFF**

DIMENSION

Shift sound image center to front or rear, to adjust playback balance.

[Variable range] **0** ~ **3** ~ **6**

CENTER WIDTH

Assign center channel signal to front left and right channels for wider sound.

[Variable range] **0** ~ **3** ~ **7**

DELAY TIME

Adjust delay time to control sound stage size.

[Variable range] **0 ms** ~ **30 ms** ~ **300 ms**

EFFECT LEVEL

Adjust effect signal level.

[Variable range] **1** ~ **10** ~ **15**



Set to a lower level if the positioning and sense of phase of the surround signals seems unnatural.

ROOM SIZE

Determine size of acoustic environment.

[Selectable items]

- small** : Simulate acoustics of a small room.
- med. s**
- medium**
- med. l**
- large** : Simulate acoustics of a large room.
- 

NOTE

“ROOM SIZE” does not indicate the size of the room in which sources are played.

AFDM (Auto Flag Detect Mode)

Auto-select surround mode by source.

This function only works for software containing a special identification signal.

If the software being played is recorded in Dolby Digital EX or DTS-ES, it is played in 6.1-channels. If not, it is played in 5.1-channels.

[Selectable items] **ON** **OFF**

Example : Playing Dolby Digital software (with EX flag)

- When “AFDM” is set to “ON”, the surround mode is automatically set to the DOLBY + PLIIx CINEMA mode.
- To play in the Dolby Digital EX mode, set “AFDM” to “OFF” and “SB CH OUT” to “MTRX ON”.



Some Dolby Digital EX sources do not include EX flags. If the playback mode does not switch automatically even when “AFDM” is set to “ON”, set “SB CH OUT” to “MTRX ON” or “PLIIx CINEMA”.

SB CH OUT (for Multi-channel sources)

Select playback mode for surround back channels.

[Selectable items]

- OFF** : No signal is played from the surround back channels.
- NON MTRX** : The same signals as those of the surround channels are output from the surround back channels.
- MTRX ON** : The surround channel signals undergo digital matrix processing and are output from the surround back channels.
- PLIIx CINEMA** *1 : Decoded in Dolby Pro Logic IIx Cinema mode, surround back signal played.
- PLIIx MUSIC** *2 : Decoded in Dolby Pro Logic IIx Music mode, surround back signal played.
- ES MTRX** *3 : DTS signal played with digital matrix processing.
- ES DSCRT** *4 : Signal included in DTS-ES Discrete 6.1-channel sources played.

*1: This can be selected when “Surround Back Speaker” is set to “2spkrs” at the menu “Manual Setup” – “Speaker Setup” – “Speaker Configuration” setting (page 26).

*2: This can be selected when “Surround Back Speaker” is set to “2spkrs” or “1spkr” at the menu “Manual Setup” – “Speaker Setup” – “Speaker Configuration” setting.

*3: This can be selected when playing DTS sources.

*4: This can be selected when playing DTS sources including a discrete 6.1-channel signal identification signal.

SB CH OUT (for 2-channel sources)

Determine whether to use surround back speakers.

[Selectable items]

- ON** : The surround back channel signal is played.
- OFF** : The surround back channel signal is not played.

SW ATT (Subwoofer Attenuate)

Attenuate subwoofer level when using EXT. IN mode.

[Selectable items]

- ON** : The input from the subwoofer channel is attenuated.
- OFF** : The input from the subwoofer channel is not attenuated. Usually use in this mode.



Set this to “ON” if the subwoofer channel level seems too high when playing Super Audio CD.

Subwoofer

Turn subwoofer output on and off.

[Selectable items]

- ON** : The subwoofer is used.
- OFF** : The subwoofer is not used.

Default

Resets the settings to the default values.

2 Tone Control

Adjust the tonal quality of the sound.

Tone Defeat

Turn tone adjustments off.

[Selectable items]

ON : Playback without tone adjustment.

OFF : Allow tone adjustment (treble, bass).



The tone cannot be adjusted when in the DIRECT mode.

Bass

Adjust low frequency range (bass).

[Variable range] **-6dB ~ +6dB**

Treble

Adjust high frequency range (treble).

[Variable range] **-6dB ~ +6dB**



"Bass" and "Treble" can be set when "Tone Defeat" is set to "OFF".

3 Room EQ

Select room equalizer for current environment.

[Selectable items]

Audyssey : Optimize frequency response of all speakers to match room acoustics.

Audyssey Byp. L/R : Optimize frequency response of speakers except front speakers to match room acoustics.

Audyssey Flat : Optimize frequency response of all speakers to flat response.

Manual : Apply frequency response set with "Manual EQ" (page 29).

OFF : Turn equalizer off.

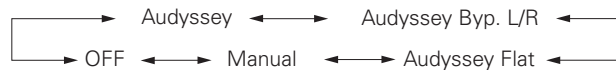

When "Audyssey" is selected, "AUDYSSEY MULTEQ" lights.

When "Audyssey Byp. L/R" or "Audyssey Flat" is selected, or when the auto setup measuring results have changed, "AUDYSSEY MULTEQ" lights.



- "Audyssey", "Audyssey Byp. L/R" and "Audyssey Flat" can be set after the auto setup procedure has been performed.
- If the settings of speakers for which "None" has been determined at "Auto Setup" are changed, "Audyssey", "Audyssey Byp. L/R" and "Audyssey Flat" cannot be selected.
- When using headphones, "Room EQ" is set to "OFF".

4 RESTORER

This function restores compressed audio signals to how they were before compression and corrects the sense of volume of the bass to obtain richer playback sound.

[Selectable items]

OFF : Do not use RESTORER.

Mode1 (RESTORER 64): Optimized mode for compressed sources with very weak highs.

Mode2 (RESTORER 96): Apply suitable bass and treble boost for all compressed sources.

Mode3 (RESTORER HQ): Optimized mode for compressed sources with normal highs. The default setting for "iPod" is "Mode3". All others are set to "OFF".

When set to something other than "OFF", "RESTORER" is displayed.

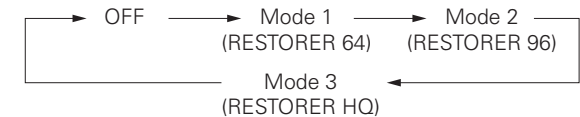

About the RESTORER function

- Such compressed audio formats as MP3, WMA (Windows Media Audio) and MPEG-4 AAC reduce the amount of data by eliminating signal components that are hard for the human ear to hear. The RESTORER function generates the signals eliminated upon compression, restoring the sound to conditions near those of the original sound before compression. It also corrects the sense of volume of the bass to obtain richer sound with compressed audio signals.
- This is displayed on the menu and can be set when the input source is selected to "XM"; or analog signals (including AM/FM signals) or PCM signals (fs = 44.1/48 kHz) are input.



When the surround mode is set to "neural", the "RESTORER" can not be selected.

5 Night Mode

Optimized setting for late-night listening.

[Selectable items]

OFF : Turn night mode off.

LOW : Low setting.

MID : Middle setting.

HIGH : High setting.



Operating from the remote control unit

Press the **NIGHT** button.

The "**NIGHT**" indicator lights when "LOW", "MID" or "HIGH" is selected.

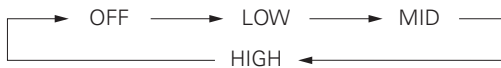

6 Audio Delay

Compensate for mismatched timing between video and audio.

Delay audio.

This sets the delay time for audio signals.

[Variable range] **0 ms** ~ **200 ms**

If you wish to adjust the "Audio Delay" while playing HDMI or component video signals, press Δ to set "OSD" to "OFF". This way the audio delay can be adjusted while watching the picture. (Press Δ again to switch to the on-screen display.)



This cannot be adjusted when playing in the EXT. IN, DIRECT or STEREO mode (with "Front Speaker" set to "Large", "Tone Defeat" to "ON" and "Room EQ" to "OFF".)

Information

Status

Shows information about current settings.

● Menu screen ●

5. Information

- 1. Status
- 2. Audio Input Signal
- 3. HDMI Information
- 4. Auto Surround Mode
- 5. Quick Select
- 6. Preset Station

5-1. Status

Select Source: **PHONO**
 Name: Record
 Surround Mode: STEREO
 Input Mode: ANALOG

1 Main Zone

Shows information about settings for main zone.

The items displayed differ according to the input source.

[Items to be checked]

Select Source Name Surround Mode Input Mode

Rec Select Video Select Source Level Room EQ

Night Mode RESTORER etc.

2 ZONE2

Shows information about settings for multi-zone.

[Items to be checked]

Power Select Source Volume Level

Audio Input Signal

Shows information about audio input signals.

● Menu screen ●

5. Information

- 1. Status
- 2. Audio Input Signal
- 3. HDMI Information
- 4. Auto Surround Mode
- 5. Quick Select
- 6. Preset Station

5-2. Audio Input Signal

Surround Mode: DOLBY DIGITAL EX
 SIGNAL: Dolby Digital
 fs: 48kHz
 Format: 3/2/.1
 Offset: -4dB

[Items to be checked]

Surround Mode : The currently set surround mode is displayed.

SIGNAL : The input signal type is displayed.

fs : The input signal's sampling frequency is displayed.

Format : The number of channels in the input signal (front, surround, LFE) is displayed.

Offset : The dialogue normalization correction value is displayed.

Flag : "MATRIX" is displayed if the input signal has undergone matrix processing, "DISCRETE" if the input signal has undergone discrete processing.

Dialogue normalization function

This is automatically activated when playing Dolby Digital sources. This function automatically corrects the standard signal level for individual program sources.

The correction value can be checked using the **STATUS** button on the main unit.

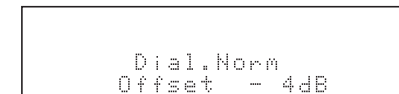

The figure is the correction value when the standard level is corrected.

HDMI Information

Shows information about HDMI input/output signals and monitor.

● Menu screen ●

5. Information

1. Status
2. Audio Input Signal
- ☑ 3. HDMI Information
4. Auto Surround Mode
5. Quick Select
6. Preset Station

5-3. HDMI Signal Info.

Resolution
480i
→ 1080p
Color Space
YCbCr 4:2:2
→ YCbCr 4:4:4
Pixel Depth
8bits
→ 10bits



5-3. HDMI Monitor Info.



Interface
HDMI
Support Resolution
480i/p
576i/p
1080i: 50Hz/60Hz
720p: 50Hz/60Hz
1080p: 50Hz/60Hz
1080p: 24Hz

1 HDMI Signal Information

The HDMI input/output signal information is displayed.

[Items to be checked]

Resolution Color Space Pixel Depth

2 HDMI Monitor Information

The HDMI monitor information is displayed.

[Items to be checked]

Interface Support Resolution

Auto Surround Mode

Shows information about auto surround mode settings.

The surround mode for which the last memory function was used for the different input signal types is displayed.

● Menu screen ●

5. Information

1. Status
2. Audio Input Signal
3. HDMI Information
- ☑ 4. Auto Surround Mode
5. Quick Select
6. Preset Station

5-4. Auto Surround Mode

[Analog] [PCM]
2CH: STEREO

[Multi ch]
: MULTI CH IN

[Digital]
2CH: DOLBY PLIIx Cinema
5. 1CH: DOLBY/DTS SURROUND

[Items to be checked]

Analog/PCM 2CH Multi ch Digital 2CH Digital 5.1CH

Quick Select

Shows information about quick select settings.

● Menu screen ●

5. Information

1. Status
2. Audio Input Signal
3. HDMI Information
4. Auto Surround Mode
- ☑ 5. Quick Select
6. Preset Station

5-5. Quick Select

- ☑ 1. Quick Select 1
2. Quick Select 2
3. Quick Select 3

[Items to be checked]

Name Input Source Input Mode Volume Level

Analog/PCM 2CH Multi ch Digital 2CH Digital 5.1CH



For instructions on storing settings at Quick Select 1 to 3, see page 49.

Preset Station

Shows information about preset stations.

● Menu screen ●

5. Information

1. Status
2. Audio Input Signal
3. HDMI Information
4. Auto Surround Mode
5. Quick Select
- ☑ 6. Preset Station

5-6. Preset Station

A1FM 87.50MHz
A2FM 89.10MHz
A3FM 98.10MHz
A4FM 107.90MHz
A5FM 90.10MHz
A6FM 90.10MHz
A7FM 90.10MHz
A8FM 90.10MHz



[Input source]

TUNER XM

[Items to be checked] A1 ~ G8



When the **STATUS** button on the main unit is pressed, the set's status can be checked on the display.

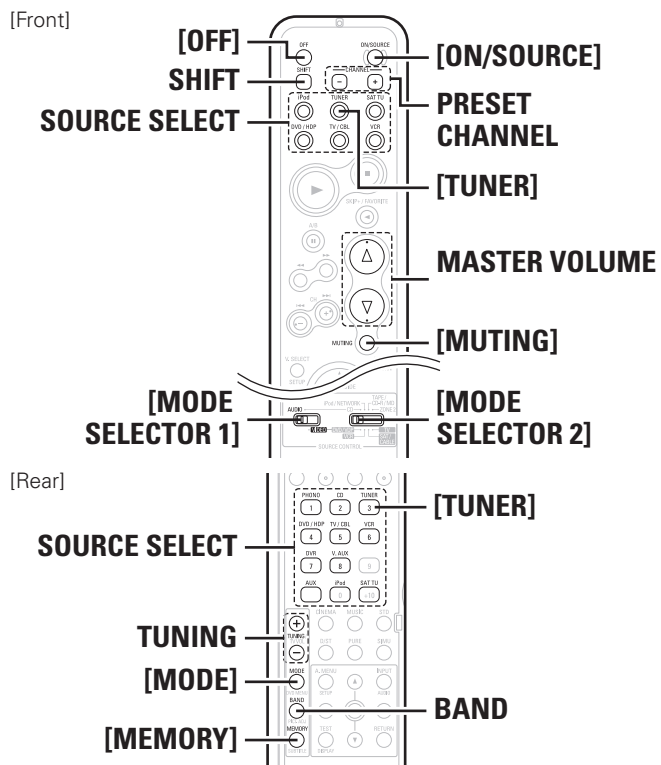
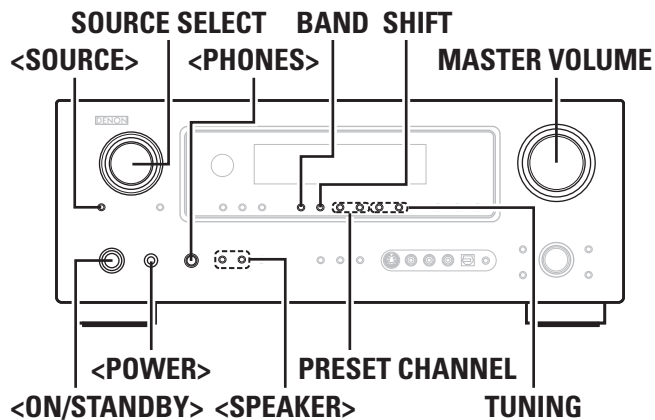

About the button names in these explanations
 < > : Buttons on the main unit
 [] : Buttons on the remote control unit
Button name only:
 Buttons on the main unit and remote control unit

Playback

Preparations

Turning the Power On

- 1 Press <POWER>. The power indicator lights red and the power is set to the standby mode.
- 2 Press <ON/STANDBY> or [ON/SOURCE]. The power indicator flashes green and the power turns on.

Turning the Power Off

- 1 Press <ON/STANDBY> or [OFF]. The power is set to the standby mode.
- 2 Press <POWER>. The power indicator turns off, and so does the power.

NOTE
 Power continues to be supplied to some of the circuitry even when the power is in the standby mode. When leaving home for long periods of time or when traveling, either press <POWER> to turn off the power, or unplug the power cord from the power outlet.

Selecting the input source

Operation on the main unit

Turn <SOURCE SELECT>.

NOTE
 If "Rec Select" is selected for the input source, press <SOURCE> before turning <SOURCE SELECT>.

Operation on the remote control unit

Set [MODE SELECTOR 1] to "AUDIO" then press [SOURCE SELECT]. The desired input source can be selected directly.

Operations During Playback

Adjusting the Master Volume

Either turn <MASTER VOLUME> or press [MASTER VOLUME].

Turning Off the Sound Temporarily (Muting)

Press [MUTING].

NOTE
 To cancel, press [MUTING] again. Muting can also be canceled by adjusting the master volume.

Listening with Headphones

Plug the headphones into <PHONES>.
 The sound from the speakers and pre-out connectors is automatically cut.

NOTE
 Be careful not to set the volume too high when using headphones.

Switching the front speakers

Press <SPEAKER>.

Playing Video and Audio Equipment

Basic Operation

1 Prepare the equipment.

- ① Load the DVD, CD or other software in the player.
(☞ See the operating instructions of the respective devices.)
- ② To play a video device, switch the monitor input.
(☞ See the monitor's operating instructions.)

2 Use SOURCE SELECT to select the input source.

3 Set [MODE SELECTOR 1] to "AUDIO" or "VIDEO".

(☞ page 50 "Remote Control Unit Operations")

4 Set [MODE SELECTOR 2] to the component you want to operate.

5 Start playback.

(☞ See the operating instructions of the respective devices.)

Listening to FM/AM Broadcasts

Basic Operation

1 Either turn <SOURCE SELECT> or press [TUNER] to select "TUNER".

2 Set [MODE SELECTOR 1] to "AUDIO".

(☞ page 50 "Remote Control Unit Operations")

3 Press BAND to select "FM" or "AM".

4 Tune in the desired broadcast station.

- ① **To tune in automatically (Auto Tuning)**
Press [MODE] to light the "AUTO" indicator on the display, then use TUNING to select the station you want to hear.
- ② **To tune in manually (Manual Tuning)**
Press [MODE] to turn off the display's "AUTO" indicator, then use TUNING to select the station you want to hear.



- It is also possible to switch to "FM" or "AM" in step 1 by pressing [TUNER].
- If the desired station cannot be tuned in with auto tuning, tune it in manually.
- When tuning in stations manually, press and hold TUNING to change frequencies continuously.
- The time for which the on-screen display are displayed can be set at "Manual Setup" – "Option Setup" – "On-Screen Display" (☞ page 31).

Presetting Radio Stations (Preset Memory)

Your favorite broadcast stations can be preset so that you can tune them in easily. Up to 56 stations can be preset.

1 Tune in the broadcast station you want to preset.

2 Press [MEMORY].

3 Press SHIFT to select the block (A to G) in which the station is to be preset.

4 Press PRESET CHANNEL to select the preset number (1 to 8).

5 Press [MEMORY] again to complete the setting.



- To preset other stations, repeat steps 1 to 5.
- Stations can be preset automatically at menu "Input Setup" – "Auto Preset" (☞ page 33).

NOTE

Preset stations are erased by overwriting them.

Listening to Preset Stations

1 Press SHIFT to select the memory block (A to G).

2 Press PRESET CHANNEL to select the desired preset channel (1 to 8).

□ Default settings

| Auto tuner presets | |
|--------------------|--|
| A1 ~ A8 | 87.5 / 89.1 / 98.1 / 107.9 / 90.1 / 90.1 / 90.1 / 90.1 MHz |
| B1 ~ B8 | 520 / 600 / 1000 / 1400 / 1500 / 1710 kHz, 90.1 / 90.1 MHz |
| C1 ~ C8 | 90.1 MHz |
| D1 ~ D8 | 90.1 MHz |
| E1 ~ E8 | 90.1 MHz |
| F1 ~ F8 | 90.1 MHz |
| G1 ~ G8 | 90.1 MHz |

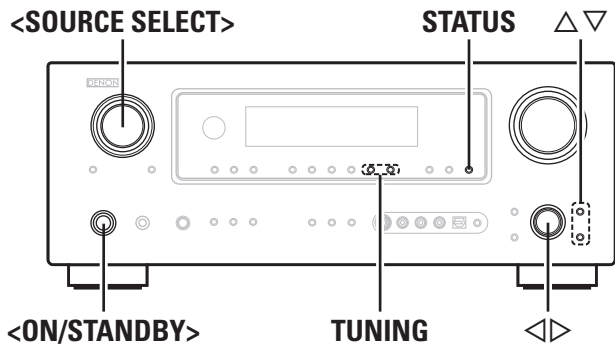

[Front]

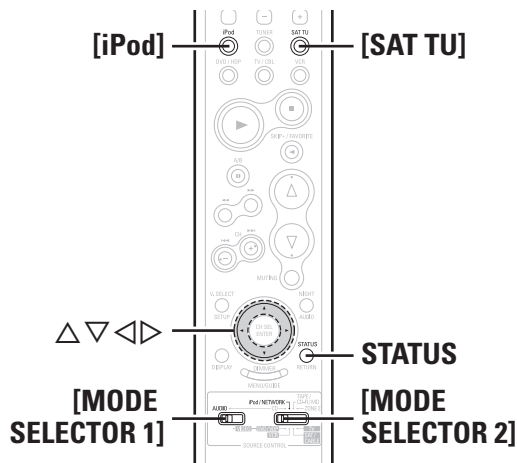

[Rear]

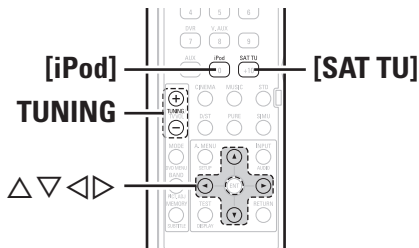

About the button names in these explanations

< > : Buttons on the main unit
[] : Buttons on the remote control unit

Button name only:

Buttons on the main unit and remote control unit

Listening to XM Satellite Radio Programs

About XM Satellite Radio

XM Satellite Radio offers an extraordinary variety of commercial-free music, plus the best in sports, news, talk and entertainment. XM is broadcast in superior digital audio from coast to coast. From rock to reggae, from classical to hip hop, XM has something for every music fan. XM's dedication to playing the richest selection of music is matched by its passion for live sporting events, talk radio, up-to-the-minute news, stand-up comedy, children's programming, and much more. For U.S. customers, information about XM Satellite Radio is available online at www.xmradio.com. For Canadian customers, information about XM Canada is online at www.xmradio.ca.

XM Ready® Legal

Hardware and required monthly subscription sold separately. Other fees and taxes, including a one-time activation fee may apply. Subscription fee is consumer only. All fees and programming subject to change. Channels with frequent explicit language are indicated with an XL. Channel blocking is available for XM radio receivers by calling 1-800-XMRADIO (US residents) and 1-877-GET-XMSR (Canadian residents). For a full listing of the XM commercial-free channels and advertising-supported channels, visit lineup.xmradio.com (US residents) or xmradio.ca (Canadian residents).

Subscriptions subject to Customer Agreement available at xmradio.com (US residents) and xmradio.ca (Canadian residents). Only available in the 48 contiguous United States and Canada. ©2006 XM Satellite Radio Inc. All rights reserved. All other trademarks are the property of their respective owners.

XM Ready® Subscriptions

Once you have installed the XM Mini-Tuner Dock, inserted the XM Mini-Tuner, connected the XM Dock to your XM Ready® home audio system, and installed the antenna, you are ready to subscribe and begin receiving XM programming. There are three places to find your eight character XM Radio ID: on the XM Mini-Tuner, on the XM Mini-Tuner package, and on XM Channel 0. Record the Radio ID in the following eight squares for reference.



Note: The XM Radio ID does not use the letters "I," "O," "S" or "F". Activate your XM Satellite Radio service in the U.S. online at <http://activate.xmradio.com> or call 1-800-XM-RADIO (1-800-967-2346). You will need a major credit card. XM will send a signal from the satellites to activate the full channel lineup. Activation normally takes 10 to 15 minutes, but during peak busy periods you may need to keep your XM Ready home audio system on for up to an hour. When you can access the full channel lineup on your XM Ready home audio system you are done. For more information or to subscribe in Canada, visit XM on the Web at www.xmradio.ca or call XM's Listener Care at 1-877-GET-XMSR (1-877-438-9677).

Basic Operation

- 1** Either turn <SOURCE SELECT> or press [SAT TU] to select "XM".
- 2** Set [MODE SELECTOR 1] to "AUDIO". (☞ page 50 "Remote Control Unit Operations")
- 3** Use TUNING to select the station. When the station is tuned in, the name of the track and artist are displayed.



- The channel switches continuously when TUNING is pressed and held.
- XM Radio stations can be preset using the same procedure as for FM/AM stations (☞ page 44 "Presetting Radio Stations (Preset Memory)" and "Listening to Preset Stations").
- The artist name, track name, category and reception level can be checked by pressing STATUS.
- The time for which the on-screen display are displayed can be set at menu "Manual Setup" – "Option Setup" – "On-Screen Display" (☞ page 31).

Checking the XM Signal Strength and Radio ID

1 Either turn <SOURCE SELECT> or press [SAT TU] to select “XM”.

2 Press STATUS until “SIGNAL” appears on the display.

The display will switch as shown below, depending on the reception conditions.

| Display | Status |
|----------|-----------------------------|
| GOOD | Signal strength is good |
| MARGINAL | Signal strength is marginal |
| WEAK | Signal strength is weak |
| NO | No signal |

3 Adjust the position of the antenna until “SIGNAL: GOOD” is shown on the display.

4 Press STATUS until the station you want to check (example: “XM001”) is displayed.

5 Press TUNING and select channel 0 (XM000).
The radio ID is shown on the display.

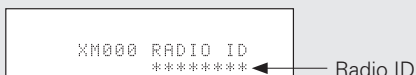

The strength of both the XM satellite and terrestrial signals can be checked at menu “Input Setup” – “Antenna Aiming” (page 36).

Searching Categories

1 Press ◀ ▶.



2 Use ◀ ▶ to select the category, then use ▲ ▼ to select the desired station.

iPod® Playback

The music on an iPod can be played by using the Control Dock for iPod (ASD-1R, ASD-3N or ASD-3W, sold separately). The operation can also be performed using the buttons on the main unit or remote control unit while watching the menus.



iPod is a trademark of Apple Computer, Inc., registered in the U.S. and other countries.

※ The iPod may only be used to copy or play contents that are not copyrighted or contents for which copying or playback is legally permitted for your private use as an individual. Be sure to comply with applicable copyright legislation.

Basic Operation

1 Make the necessary preparations.

- ① Set the iPod in the DENON Control Dock for iPod. (See the Control Dock for iPod's operating instructions.)
- ② Assign the Control Dock for iPod's input.

MENU : “Input Setup” – “Assign” – “iPod dock”
(page 35)

2 Either turn <SOURCE SELECT> or press [iPod] to select the input source assigned in step 1-② above.

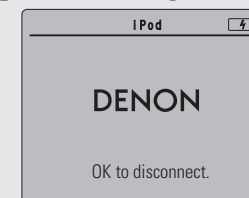

(iPod screen)

※ If the screens above are not displayed, the iPod may not be properly connected. Try connecting again.

3 Set [MODE SELECTOR 1] to “AUDIO” and [MODE SELECTOR 2] to “iPod/NETWORK”.

(page 50 “Remote Control Unit Operations”)



- With the default settings, the iPod can be used connected to the VCR (iPod) connector.
- Use the RESTORER mode to expand the low and high frequency components of compressed audio files and achieve a richer sound. The default setting is “Mode3”.
- Press <ON/STANDBY> and set the AVR-888's power to the standby mode before disconnecting the iPod. Also switch the input source to one to which the menu “iPod dock” is not assigned before disconnecting the iPod.

NOTE

- Depending on the type of iPod and the software version, some functions may not operate.
- DENON will accept no responsibility whatsoever for any loss of iPod data.
- When using an ASD-3N or ASD-3W Control Dock for iPod, refer to the respective manual to operate.

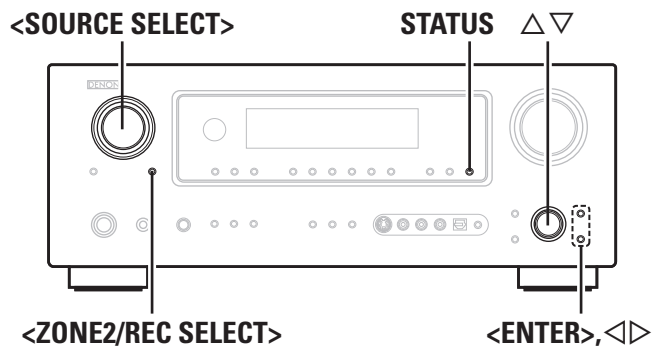

[Front]

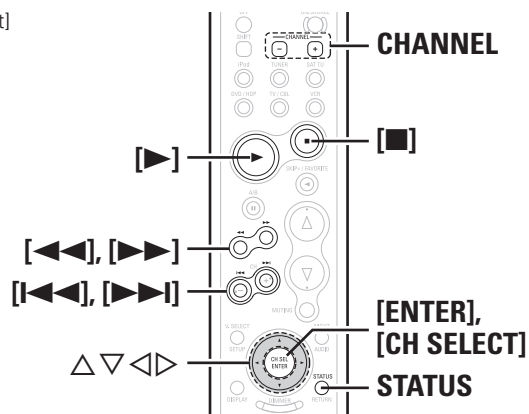

[Rear]

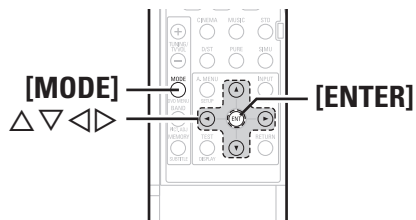

About the button names in these explanations

- < > : Buttons on the main unit
- [] : Buttons on the remote control unit

Button name only:

Buttons on the main unit and remote control unit

Listening to Music

1 Use [Δ ∇] to select the menu, then press [ENTER] or [\triangleright] to select the music file to be played.

2 Press [ENTER] or [\triangleright]. Playback starts.

Stopping playback temporarily

During playback, press [ENTER] or [\triangleright]. Press again to resume playback.

Fast-forwarding or fast-reversing

During playback, either press and hold [Δ] (to fast-reverse) or [∇] (to fast-forward), or press [\ll] or [\gg].

To cue to the beginning of a track

During playback, either press [Δ] (to cue to the previous track) or [∇] (to cue to the next track), or press [\ll] or [\gg].

To stop

During playback, either press and hold [ENTER] or press [■].

Playing repeatedly

Press [CHANNEL -].

[Selectable items] **All** **One** **OFF**

MENU : "Input Setup" - "iPod" - "Repeat" (☞ page 35)

Shuffling playback

Press [CHANNEL +].

[Selectable items] **Albums** **Songs** **OFF**

MENU : "Input Setup" - "iPod" - "Shuffle" (☞ page 35)

To switch between the Browse and Remote modes

Either press and hold [MODE].



- The title name, artist name and album name can be checked by pressing **STATUS** during playback.
- On the AVR-888, folder and file names can be displayed as titles. Any characters that cannot be displayed are replaced with " . (period)".
- The time for which the on-screen display are displayed can be set at menu "Manual Setup" - "Option Setup" - "On-Screen Display" - "iPod Information" (☞ page 31).

Viewing Still Pictures or Videos on the iPod

Photo and video data on the iPod can be viewed on the monitor. Only for iPod equipped with slideshow or video functions. (When using an ASD-1R)

1 Press and hold [MODE] to set the Remote mode.

2 Watching the iPod's screen, use [Δ ∇] to select "Photos" or "Video".

3 Press [ENTER] until the image you want to view is displayed.



"TV Out" at the iPod's "Slideshow Settings" or "Video Settings" must be set to "On" in order to display the iPod's photo data or videos on the monitor. For details, see the iPod's operating instructions.

Other Operations and Functions

Other Operations

Recording on an External Device (REC OUT mode)

You can listen to one program source while recording a different program source.

1 Press **<ZONE2/REC SELECT>**.
“ZONE2 SOURCE” is shown on the display.

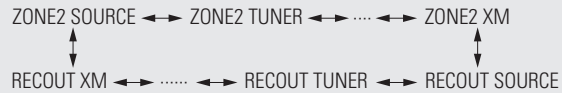

2 Turn **<SOURCE SELECT>** until “RECOUT SOURCE” is displayed.

The “**REC**” indicator lights.

3 Turn **<SOURCE SELECT>** to choose the input source to be recorded.

4 Play the program source.

For operating instructions, refer to the respective equipment’s operating instructions.
To record FM or AM broadcasts, select the broadcast (page 44).

5 Start recording.

For operating instructions, refer to the respective equipment’s operating instructions.



- To cancel, press **<ZONE2/REC SELECT>**, then turn **<SOURCE SELECT>** until “ZONE2 SOURCE” is displayed.
- Make a test recording before starting the actual recording.
- Sources selected with the REC OUT mode are output from ZONE2 as well.
- In the REC OUT mode, the remote control unit’s ZONE2 mode buttons cannot be operated.
- The “XM” digital audio output signals are not output from the OPTICAL2 or OPTICAL3 output connectors.

NOTE

- Recordings you make are for your personal enjoyment and should not be used for other purposes without permission of the copyright holder.
- Input sources for which “Delete” is selected at “Source Delete” cannot be selected.

Convenient Functions

Channel Level

You can adjust the channel level either according to the playback sources or to suit your taste, as described below.

1 Press **<ENTER>** or **[CH SELECT]**.

| Channel Volume | | | |
|------------------|------------|-----|--------|
| FL | ◀ 0.0 dB ▶ | SR | 0.0 dB |
| C | 0.0 dB | SBR | 0.0 dB |
| FR | 0.0 dB | SBL | 0.0 dB |
| SW | 0.0 dB | SL | 0.0 dB |
| Fader | | | |
| FRONT ◀ : ▶ REAR | | | |

2 Use **Δ**, **∇**, **<ENTER>** or **[CH SELECT]** to select the speaker.

The speaker that can be set switches each time one of the buttons is pressed.

3 Use **◀** **▶** to adjust the volume.

※ “OFF” can be set by pressing **◀** when the subwoofer’s volume is set to -12 dB.

Fader Function

This function lets you adjust (fade) the sound from all the front or rear speakers at once.

1 Press **<ENTER>** or **[CH SELECT]**.

2 Press **Δ**, **∇**, **<ENTER>** or **[CH SELECT]** to select “Fader”.

3 Use **◀** **▶** to adjust the volume of the speakers.
(◀: front, ▶: rear)



- The fader function does not affect the subwoofer.
- The fader can be adjusted until the volume of the speaker adjusted to the lowest value is -12 dB.

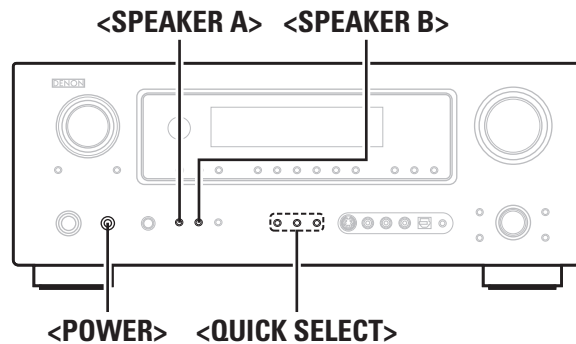

About the button names in these explanations
 < > : Buttons on the main unit
 [] : Buttons on the remote control unit
Button name only:
 Buttons on the main unit and remote control unit

Quick Select Function
 With this function, the currently playing input source, input mode, surround mode, room EQ settings and volume can be stored in the memory.

- 1 Set the input source, input mode, surround mode, room EQ settings and volume to the conditions you want to store.
- 2 Press and hold the desired <QUICK SELECT> until “Memory” appears on the display.

[Quick Select Defaults]

| | Input Source | Volume |
|----------------|--------------|--------|
| Quick Select 1 | DVD | -40 dB |
| Quick Select 2 | TV/CBL | -40 dB |
| Quick Select 3 | VCR | -40 dB |

- To call out the settings, press <QUICK SELECT> at which the desired settings were stored.
- The Quick Select name can be changed (page 32).

NOTE
 Input sources stored with the quick select function cannot be selected if they have been deleted at menu “Manual Setup” – “Option Setup” – “Source Delete” (page 31). In this case, store them again.

Personal Memory Plus Function
 This function sets the settings (input mode, surround mode, etc.) last selected for the individual input sources. When you switch to an input source, the settings are automatically set to the ones that were set the last time that input source was used.

The surround parameters, tone control, room EQ settings and the volumes of the different speakers are stored for the individual surround modes.

Last Function Memory
 This stores the settings as they were directly before the standby mode was set. When the power is turned back on, the settings are restored to as they were directly before the standby mode was set.

Backup Memory
 The various settings are backed up for about 1 week, even if the power is turned off or the power cord is disconnected.

Resetting the Microprocessor
 Perform this procedure if the display is abnormal or if operations cannot be performed. When the microprocessor is reset, all the settings are reset to their default values.

- 1 Turn off the power using <POWER>.
- 2 Press <POWER> while simultaneously pressing <SPEAKER A> and <SPEAKER B>.
- 3 Once the display starts flashing at intervals of about 1 second, release the two buttons.

If in step 3 the display does not flash at intervals of about 1 second, start over from step 1.

Remote Control Unit Operations

[Front]

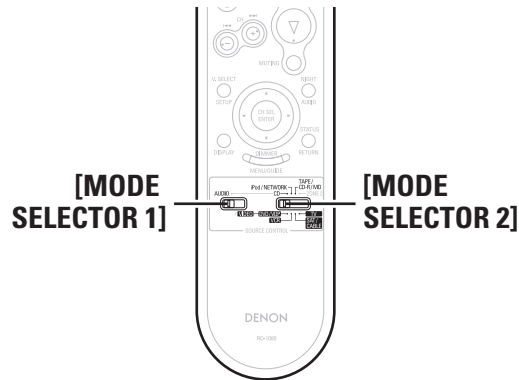

[Rear]

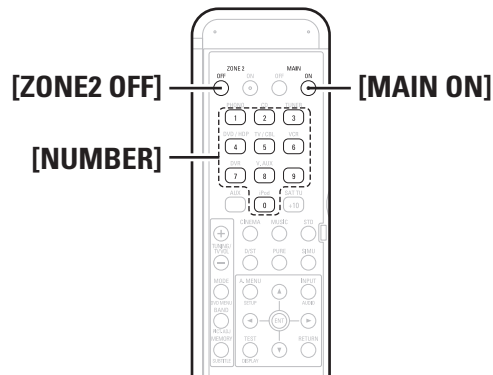

Depending on the model and year of manufacture of your equipment, some buttons may not operate.

Operating DENON Audio Components

1 Set [MODE SELECTOR 1] to “AUDIO”.

2 Set [MODE SELECTOR 2] to the position for the component to be operated (CD, iPod/NETWORK or TAPE/CD-R/MD).

3 Operate the audio component.

- ※ For details, refer to the component’s operating instructions.
- ※ While this remote control is compatible with a wide range of infrared controlled components, it may be the case that some component models cannot be operated with this remote control.

Presetting

- DENON and other makes of components can be operated by setting the preset memory.
- This remote control unit can be used to operate components of other manufacturers without using the learning function by registering the manufacturer of the component as shown in the list of preset codes (End of this manual).
- Operation is not possible for some models.

1 Set [MODE SELECTOR 1] to “AUDIO” or “VIDEO”.

- ※ Set to the AUDIO side for the CD or TAPE/CD-R/MD position, and to the VIDEO side for the DVD/VDP, SAT/CABLE, VCR or TV position.

2 Set [MODE SELECTOR 2] to the component to be registered.

3 Press [ZONE2 OFF] and [MAIN ON] at the same time.
The indicator starts flashing.

4 Referring to the included list of preset codes, press [NUMBER] to input the preset code (a 3-digit number) for the manufacturer of the component whose signals you want to store in the memory.

5 To store the codes of another component in the memory, repeat steps 1 to 4.



- The signals for the pressed buttons are emitted while setting the preset memory. To avoid accidental operation, cover the remote control unit’s transmitting window while setting the preset memory.
- Depending on the model and year of manufacture, this function cannot be used for some models, even if they are of makes listed in the list of preset codes.
- Some manufacturers use more than one type of remote control code. Refer to the included list of preset codes to change the number and verify correct operation.
- The preset memory can be set for one component only among the following: TAPE/CD-R/MD, DVD/VDP and SAT/CABLE.

Operating Preset Components

1 Set [MODE SELECTOR 1] to “AUDIO” or “VIDEO”.

- ※ Set to the AUDIO side for the CD or TAPE/CD-R/MD position, and to the VIDEO side for the DVD/VDP, SAT/CABLE, VCR or TV position.

2 Set [MODE SELECTOR 2] to the component you want to operate.

3 Operate the component.

- ※ For details, refer to the component’s operating instructions.
- ※ Some models cannot be operated with this remote control unit.

Functions of Buttons by Component

□ Front

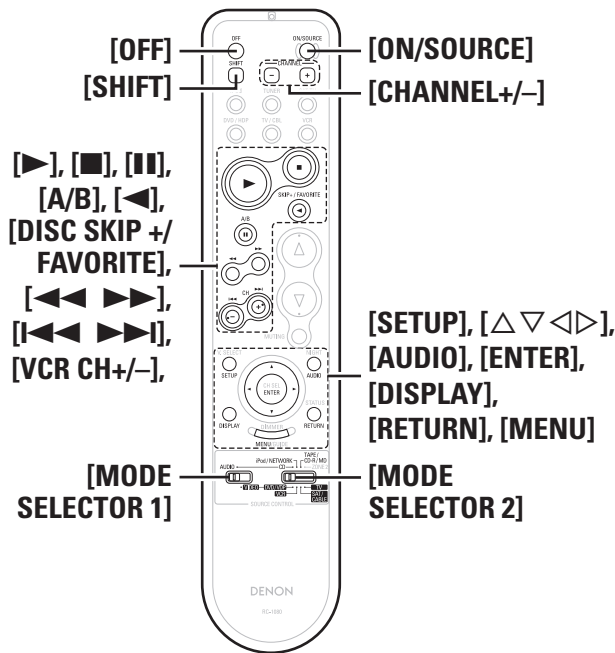

| Device operated | CD Player | iPod | CD Recorder | MD Recorder | Tape Deck | DVD Player | Video disc player | Video Deck | Satellite Receiver | Cable TV | TV (Monitor) |
|---------------------------|---|---|---|---|--------------------------|---|---|---|-----------------------|-----------------------|-----------------------|
| MODE SELECTOR 1 | AUDIO | | | | | VIDEO | | | | | |
| MODE SELECTOR 2 | CD | iPod/ NETWORK | TAPE / CD-R / MD | | | DVD / VDP | | VCR | SAT / CABLE | | TV |
| OFF | – | – | – | – | – | Power off | – | – | – | – | – |
| ON/SOURCE | – | – | – | – | – | Power on | Power on / Standby | Power on / Standby | Power on / Standby | Power on / Standby | Power on / Standby |
| SHIFT | Preset channel selection | Preset channel selection | Preset channel selection | Preset channel selection | Preset channel selection | – | – | – | – | – | – |
| CHANNEL + | Preset channel selection | 1-track/album shuffle play | Preset channel selection | Preset channel selection | Preset channel selection | Switch Channels (+) | Switch Channels (+) | Switch Channels (+) | Switch Channels (+) | Switch Channels (+) | Switch Channels (+) |
| CHANNEL - | Preset channel selection | 1-track/All-track repeat play | Preset channel selection | Preset channel selection | Preset channel selection | Switch Channels (-) | Switch Channels (-) | Switch Channels (-) | Switch Channels (-) | Switch Channels (-) | Switch Channels (-) |
| ▶ | Play | Play / Pause | Play | Play | Play | Play | Play | Play | Punch through | Punch through | Punch through |
| ■ | Stop | Stop | Stop | Stop | Stop | Stop | Stop | Stop | | | |
| ⏏, A/B | Pause | – | Pause | Pause | A/B switching | Pause | Pause | Pause | | | |
| ◀, DISC SKIP + | Disc skip + | ※ | – | – | Reverse play | Disc skip | – | – | | | |
| ◀▶▶▶ | Manual Search (fast-reverse / fast-forward) | Manual Search (fast-reverse / fast-forward) | Manual Search (fast-reverse / fast-forward) | Manual Search (fast-reverse / fast-forward) | Rewind / Fast forward | Manual Search (fast-reverse / fast-forward) | Manual Search (fast-reverse / fast-forward) | Manual Search (fast-reverse / fast-forward) | | | |
| ◀▶▶▶, VCR CH + / - | Auto search (cue) | Auto search (cue) | Auto search (cue) | Auto search (cue) | – | Auto search (cue) | Auto search (cue) | Switch Channels (-, +) | | | |
| SETUP | – | – | – | – | – | Setup | – | – | – | – | – |
| △ ▽ ◀ ▶ | – | Cursor | – | – | – | Cursor operation | – | – | Cursor operation | Cursor operation | Cursor operation |
| AUDIO | – | – | – | – | – | Switching the audio signal | – | – | – | – | – |
| ENTER | – | Enter | – | – | – | Enter setting | – | – | Enter setting | Enter setting | Enter setting |
| DISPLAY | – | – | – | – | – | Switching the display | – | – | Switching the display | Switching the display | Switching the display |
| RETURN | – | – | – | – | – | Return | – | – | Return | Return | Return |
| MENU | – | – | – | – | – | Calling out the menus | – | – | Calling out the menus | Calling out the menus | Calling out the menus |

※ The iPod/NETWORK's **FAVORITE** button can be operated when using a Control Dock for iPod ASD-3W/3N.

□ Rear

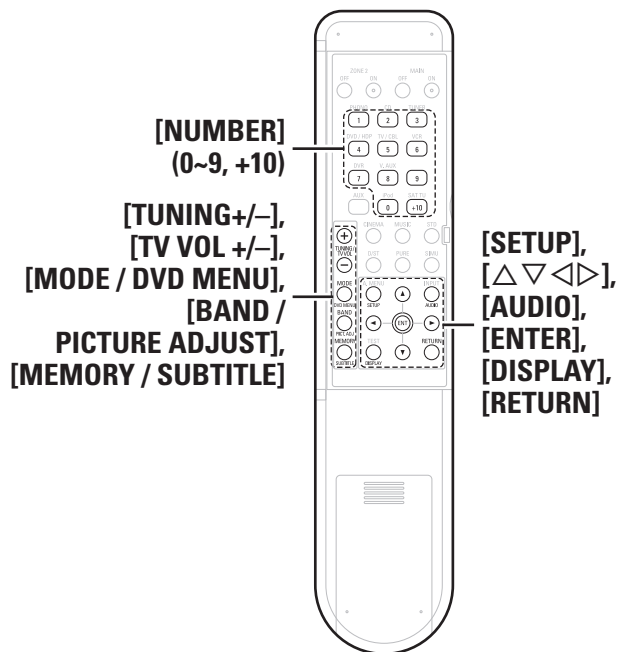

| Device operated | CD Player | iPod | CD Recorder | MD Recorder | Tape Deck | DVD Player | Video disc player | Video Deck | Satellite Receiver | Cable TV | TV (Monitor) |
|--------------------------------------|------------------------|---|-------------------------|------------------------|------------------------|--------------------------------|--------------------------------|-----------------------|-----------------------|-----------------------|-----------------------|
| MODE SELECTOR 1 | AUDIO | | | | | VIDEO | | | | | |
| MODE SELECTOR 2 | CD | iPod/ NETWORK | TAPE / CD-R / MD | | | DVD / VDP | | VCR | SAT / CABLE | | TV |
| NUMBER (0 ~ 9, +10) | - | - | - | - | - | Number input / Track selection | Number input / Track selection | - | Channels | Channels | Channels |
| TUNING (+, -) / TV VOL (+, -) | Tuning (+, -) | Tuning (+, -) | Tuning (+, -) | Tuning (+, -) | Tuning (+, -) | Volume control (+, -) | Volume control (+, -) | Volume control (+, -) | Volume control (+, -) | Volume control (+, -) | Volume control (+, -) |
| MODE / DVD MENU | Switch search modes | Switch search modes / Browse/Remote mode switching (Press and hold) | Switch search modes | Switch search modes | Switch search modes | Calling out the menus | - | - | Calling out the menus | Calling out the menus | Calling out the menus |
| SETUP | - | - | - | - | - | Setup | - | - | - | - | - |
| Δ ▽ ◀ ▶ | - | - | - | - | - | Cursor operation | - | - | Cursor operation | Cursor operation | Cursor operation |
| AUDIO BAND / PICTURE ADJUST | - | - | - | - | - | Audio | - | - | - | - | - |
| AM / FM / XM switching | AM / FM / XM switching | AM / FM / XM switching | AM / FM / XM switching | AM / FM / XM switching | AM / FM / XM switching | Picture adjust | - | - | - | - | - |
| ENTER | - | - | - | - | - | Enter setting | - | - | Enter setting | Enter setting | Enter setting |
| MEMORY / SUBTITLE | Preset memory | Preset memory | Preset memory | Preset memory | Preset memory | Subtitle | - | - | - | - | - |
| DISPLAY | - | - | - | - | - | Switching the display | - | - | Switching the display | Switching the display | Switching the display |
| RETURN | - | - | - | - | - | Return | - | - | Return | Return | Return |
| Default setting (Preset code) | DENON (111) | - | DENON (151) | - | - | DENON (111) | - | HITACHI (108) | - | ABC (007) | HITACHI (134) |
| Special Remarks | ① | - | ① | | | ①, ② | | ① | ①, ③ | | ①, ③ |

[Special Remarks]

- ① Only one device can be set in the preset memory for each mode. Also, when a new code is preset, the previous code is automatically deleted.
- ② For some brands, the DVD remote control buttons may have different function names. Check beforehand.
- ③ One of the following buttons can be assigned to the TV and satellite receiver or cable TV: CD, TAPE/CD-R/MD, VCR, DVD/VDP (page 53 "Punch Through Function").

Getting Started
Connections
Setup
Playback
Remote Control
Multi-Zone
Information
Troubleshooting

[Front]

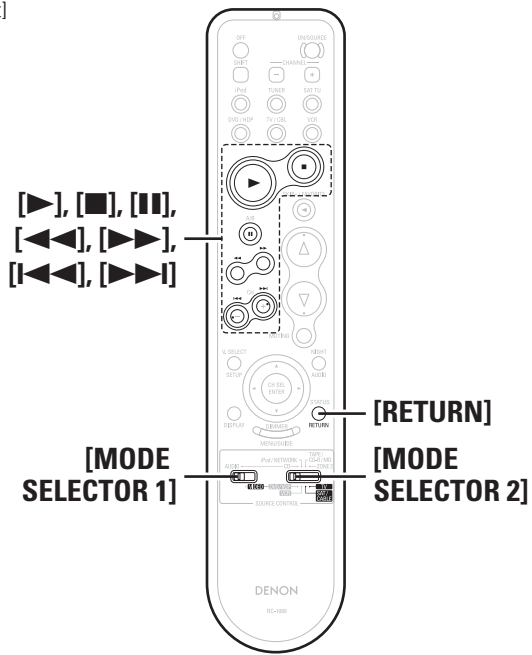

[Rear]

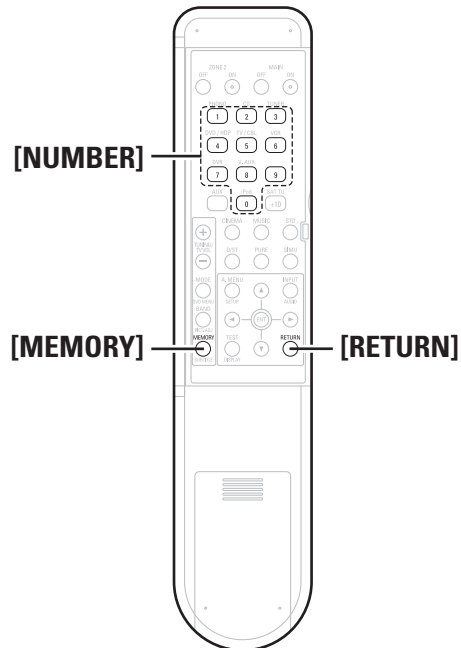

Punch Through Function

“Punch Through” is a function allowing you to operate **▶**, **■**, **⏸**, **⏩**, **⏪**, **⏮** and **⏭** on CD, iPod/NETWORK, TAPE/CD-R/MD, DVD/VDP or VCR components when in the SAT/CABLE or TV mode. By default, nothing is set.

- 1** Set [MODE SELECTOR 1] to “VIDEO”.
- 2** Set [MODE SELECTOR 2] to the component to be registered (SAT/CABLE or TV).
- 3** Press [MEMORY] and [RETURN] at the same time. The indicator starts flashing.
- 4** Input the number of the component you want to set.

| | No. |
|--------------|-----|
| CD | 1 |
| iPod/NETWORK | 2 |
| TAPE/CD-R/MD | 3 |
| DVD/VDP | 4 |
| VCR | 5 |
| No setting | 0 |

Amp Assign / Multi-zone Connections and Operations

The AVR-888 is compatible with the following types of playback:

- **Multi-zone playback (ZONE2)**
- **Bi-amp playback (front speakers)**

NOTE

- For bi-amp playback, use speakers compatible with that type of connection.
- When conducting bi-amp playback, remove the short-circuiting boards (or wires) from the speaker terminals.

Multi-zone Settings with the Amp Assign Function

The amp assign function lets you assign the amplifiers for the different channels built into the AVR-888 to the speaker outputs for the different zones.

Select the desired playback environment from among "Setting 1" to "Setting 4," then set the corresponding "Amp Assign" mode at menu "Manual Setup" – "Option Setup" – "Amp Assign" (page 30).

Connect the speakers as described at "Amp Assign" mode settings and speakers connected to the various speaker terminals.



"Setting 3" is possible to switch the Amp Assign mode between the 5.1-channel mode and 2-channel mode without changing the speaker connections.

Setting 1 :

● Multi-zone playback

- 5.1-channel playback + ZONE2 stereo playback
- 5.1-channel playback + ZONE2 monaural playback

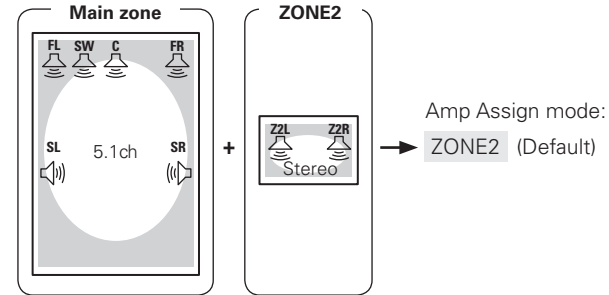

□ Amp Assign mode setting and speakers connected to the various speaker terminals

| Speaker terminal / Amp Assign mode | FRONT | | CENTER | SURR | | SURR. BACK / AMP ASSIGN | |
|------------------------------------|-------|----|--------|------|----|-------------------------|-----|
| | R | L | | R | L | R | L |
| ZONE2 | FR | FL | C | SR | SL | Z2R | Z2L |

Setting 2 :
● **7.1-channel playback**

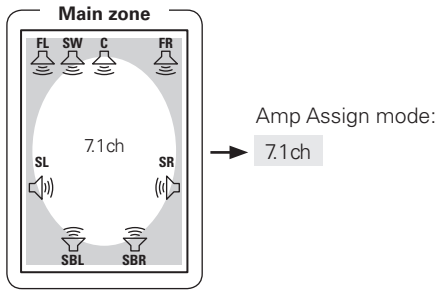

□ **Amp Assign mode setting and speakers connected to the various speaker terminals**

| Speaker terminal / Amp Assign mode | FRONT | | CENTER | SURR | | SURR. BACK / AMP ASSIGN | |
|------------------------------------|-------|----|--------|------|----|-------------------------|-----|
| | R | L | | R | L | R | L |
| 7.1ch | FR | FL | C | SR | SL | SBR | SBL |

Setting 3 : With this setting it is possible to switch between the following two playback modes.
● **5.1-channel playback**
● **2-channel playback**
Switching Surround Mode switching

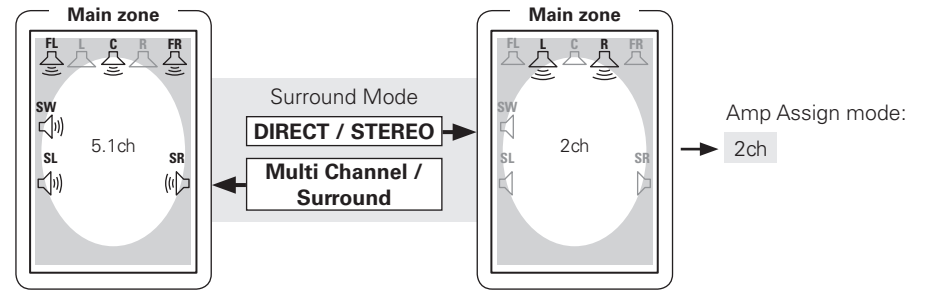

□ **Amp Assign mode setting and speakers connected to the various speaker terminals**

| Speaker terminal / Amp Assign mode | FRONT | | CENTER | SURR | | SURR. BACK / AMP ASSIGN | |
|------------------------------------|-------|----|--------|------|----|-------------------------|----|
| | R | L | | R | L | R | L |
| 2ch | FR | FL | C | SR | SL | FR | FL |

Setting 4 :

- Making bi-amp connections for the FL and FR channels in the main zone and conducting 5.1-channel playback (switching with other modes not possible)

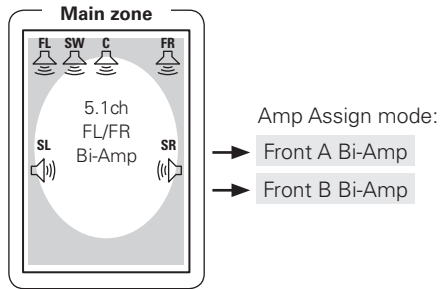

□ Amp Assign mode setting and speakers connected to the various speaker terminals

| Speaker terminal \ Amp Assign mode | FRONT-A | | FRONT-B | | CENTER | SURR | | SURR. BACK / AMP ASSIGN | |
|------------------------------------|---------|------|---------|------|--------|------|----|-----------------------------|----|
| | R | L | R | L | | R | L | R | L |
| Front A Bi-Amp | | | | | | | | FR | FL |
| | FR-A | FL-A | FR-B | FL-B | C | SR | SL | FL-A/FR-A Bi-Amp connection | |
| Front B Bi-Amp | | | | | | | | FR | FL |
| | | | | | | | | FL-B/FR-B Bi-Amp connection | |

Multi-zone Settings and Operations with Zone Output

Prepare pre-main amplifiers for ZONE2.

| | Connectors for audio output | Audio signals |
|-------|-----------------------------|---------------|
| ZONE2 | ZONE2 OUT | Stereo |

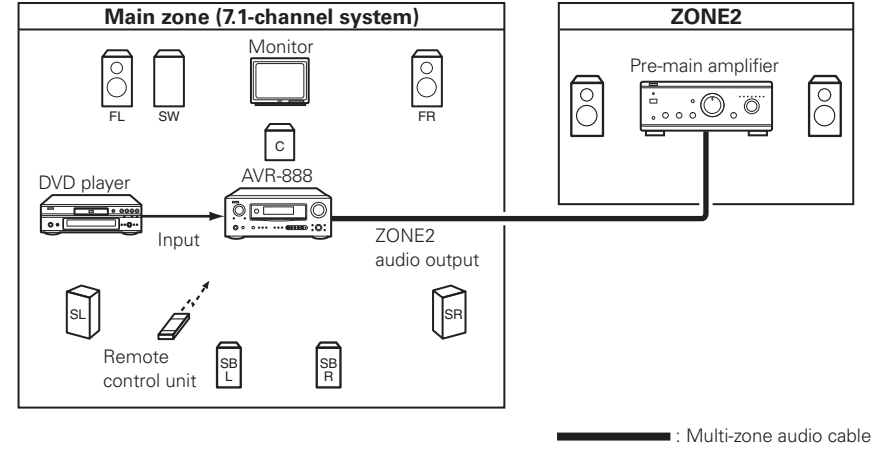

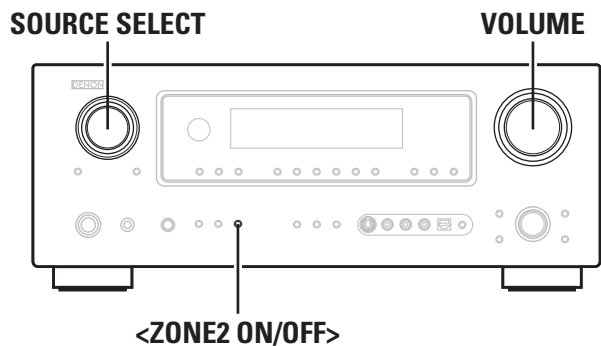

[Front]

[Rear]

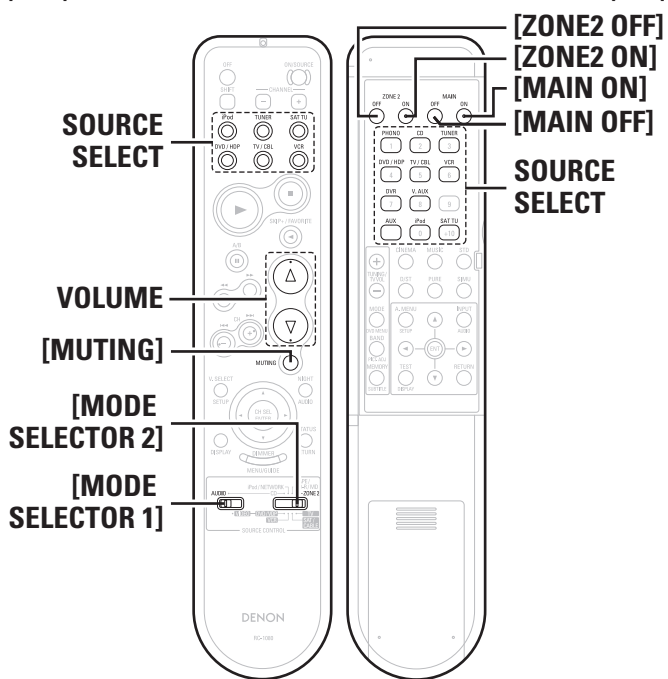

Multi-zone Operations

Turning the Power On and Off

[Operation on the main unit]

Press <ZONE2 ON/OFF> for the zone to be operated.
When the power turns on, the multi-zone indicator (Z2) lights on the display.

[Operation on the remote control unit]

Set [MODE SELECTOR 1] to "AUDIO" and [MODE SELECTOR 2] to "ZONE2".
Press [ZONE2 ON] or [ZONE2 OFF].



When using ZONE2, it is possible to turn the power for the MAIN ZONE only on or off by pressing [MAIN ON] or [MAIN OFF].

Selecting the Input Source

[Operation on the main unit]

Turn <SOURCE SELECT>.

[Operation on the remote control unit]

Set [MODE SELECTOR 1] to "AUDIO" and [MODE SELECTOR 2] to "ZONE2".
Press [SOURCE SELECT].

Adjusting the Volume

[Operation on the main unit]

Turn <VOLUME> to adjust.

[Operation on the remote control unit]

Set [MODE SELECTOR 1] to "AUDIO" and [MODE SELECTOR 2] to "ZONE2".
Press [VOLUME].

[Variable range] --- -70dB ~ -40dB ~ +18dB



- The volume can be increased up to the value set at menu "Manual Setup" - "Zone2 Setup" - "Volume Limit" (page 30).
- The ZONE2 volume can be adjusted only when "ZONE2" is selected at menu "Manual Setup" - "Option Setup" - "Amp Assign" (page 30).

Turning off the Sound Temporarily

Press [MUTING].

The sound is reduced to the level set at menu "Manual Setup" - "Zone2 Setup" - "Mute Level" (page 30).

To cancel, either adjust the volume or press [MUTING] again.
The setting is canceled when the zone's power is turned off.



The source selected for ZONE2 is also output from the recording output connectors.

NOTE

Digital audio signals input from the COAXIAL or OPTICAL connectors cannot be played in multi-zone.

About the button names in these explanations

< > : Buttons on the main unit

[] : Buttons on the remote control unit

Button name only:

Buttons on the main unit and remote control unit

Other Information

About Speaker Installation

Surround back speakers

Sound positioning directly to the rear can be achieved easily by adding a surround back speaker to a 5.1-channel system. In addition, the acoustic image extending between the sides and the rear is narrowed, thus greatly improving the expression of the surround signals for sounds moving from the sides to the back and from the front to the point directly behind the listening position.

Change of positioning and acoustic image with 5.1-channel systems

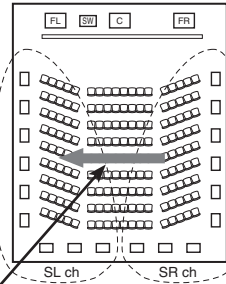

Movement of acoustic image from SR to SL

Change of positioning and acoustic image with 6.1-channel systems

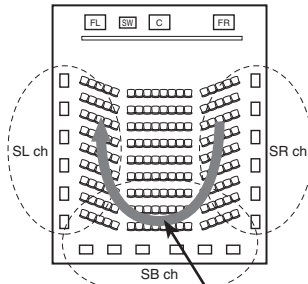

Movement of acoustic image from SR to SB to SL

In addition to sources recorded in 6.1-channels, the surround effect of conventional 2- to 5.1-channel sources can also be enhanced.

Number of surround back speakers

We recommend using 2 speakers. When using dipolar speakers in particular, be sure to use 2 speakers.

Placement of the surround left and right channels when using surround back speakers

We recommend installing the speakers for the surround "L" and "R" channels a bit forward.

Examples of speaker layouts

Below we introduce examples of speaker layouts. Refer to these to arrange your speakers according to their type and how you want to use them.

[1] Using surround back speaker(s)

① When mainly playing movies

Recommended when your surround speakers are single or 2-way speakers.

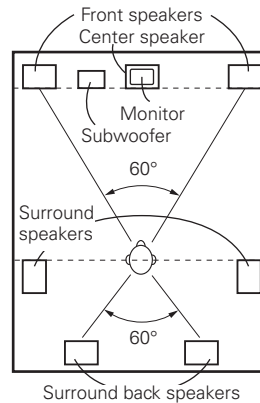

[As seen from above]

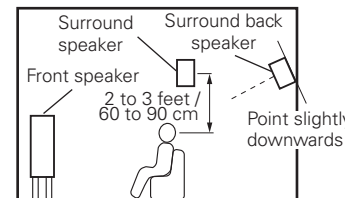

[As seen from the side]

② Setting for primarily watching movies using diffusion type speakers for the surround speakers

For the greatest sense of surround sound envelopment, diffuse radiation speakers such as bipolar types, or dipolar types, provide a wider dispersion than is possible to obtain from a direct radiating speaker (monopolar). Place these speakers at either side of the prime listening position, mounted above ear level.

Path of the surround sound from the speakers to the listening position

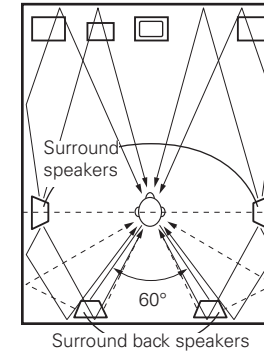

[As seen from above]

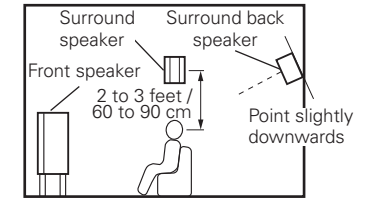

[As seen from the side]

③ When playing movies and music

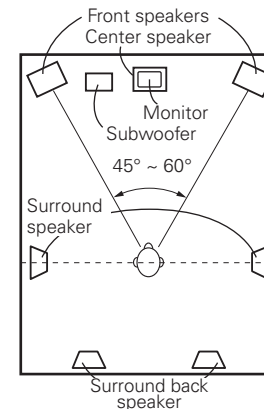

[As seen from above]

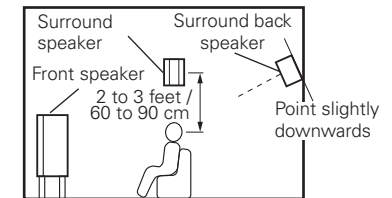

[As seen from the side]

[2] When not using surround back speakers

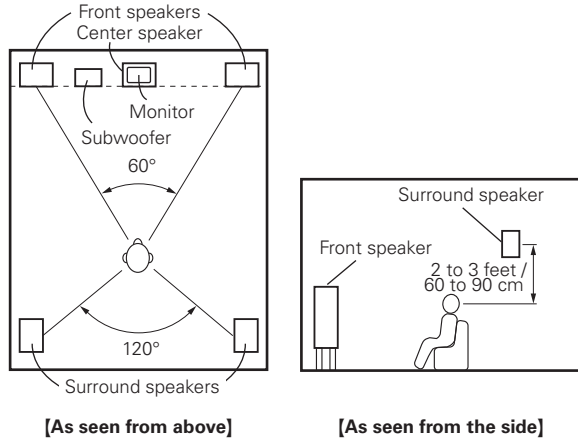

Surround

The AVR-888 is equipped with a digital signal processing circuit that lets you play program sources in the surround mode to achieve the same sense of presence as in a movie theater.

Dolby Surround

Dolby Digital

Dolby Digital is a multichannel digital signal format developed by Dolby Laboratories.

A total of 5.1-channels are played: 3 front channels ("FL", "FR" and "C"), 2 surround channels ("SL" and "SR") and the "LFE" channel for low frequencies.

Because of this, there is no crosstalk between channels and a realistic sound field with a "three-dimensional" feeling (sense of distance, movement and positioning) is achieved.

A real, overpowering sense of presence is achieved when playing movie sources in AV rooms as well.

Dolby Pro Logic II

Dolby Pro Logic II is a matrix decoding technology developed by Dolby Laboratories.

Regular music such as that on CDs is encoded into 5-channels to achieve an excellent surround effect.

The surround channel signals are converted into stereo and full band signals (with a frequency response of 20 Hz to 20 kHz or greater) to create a "three-dimensional" sound image offering a rich sense of presence for all stereo sources.

Dolby Pro Logic IIx

Dolby Pro Logic IIx is a further improved version of the Dolby Pro Logic II matrix decoding technology.

Audio signals recorded in 2-channels are decoded to achieve a natural sound with up to 7.1-channels.

There are 3 modes: "Music" suited for playing music, "Cinema" suited for playing movies, and "Game" which is optimized for playing games.

※ Sources recorded in Dolby Surround

Sources recorded in Dolby Surround are indicated with the following logo marks.

Dolby Surround support mark : 

Manufactured under license from Dolby Laboratories. "Dolby", "Pro Logic" and the double-D symbol are trademarks of Dolby Laboratories.

DTS Surround

DTS Digital Surround

DTS Digital Surround is the standard digital surround format of DTS, Inc., compatible with a sampling frequency of 44.1 or 48 kHz and up to 5.1-channels of digital discrete surround sound.

DTS-ES™ Discrete 6.1

DTS-ES™ Discrete 6.1 is a 6.1-channel discrete digital audio format adding a surround back (SB) channel to the DTS digital surround sound. Decoding of conventional 5.1-channel audio signals is also possible according to the decoder.

DTS-ES™ Matrix 6.1

DTS-ES™ Matrix 6.1 is a 6.1-channel discrete digital audio format inserting a surround back (SB) channel to the DTS digital surround sound through matrix encoding. Decoding of conventional 5.1-channel audio signals is also possible according to the decoder.

DTS NEO:6™ Surround

DTS NEO:6™ is a matrix decoding technology for achieving 6.1-channel surround playback with 2-channel sources. It includes "DTS NEO:6 CINEMA" suited for playing movies and "DTS NEO:6 MUSIC" suited for playing music.

DTS 96/24

DTS 96/24 is a digital audio format enabling high sound quality playback in 5.1-channels with a sampling frequency of 96 kHz and 24 bit quantization on DVD-Video.

Manufactured under license under U.S. Patent #'s: 5,451,942; 5,956,674; 5,974,380; 5,978,762; 6,226,616; 6,487,535; 7,003,467 & other U.S. and worldwide patents issued & pending. DTS, DTS Digital Surround, ES, and Neo:6 are registered trademarks and the DTS logos, Symbol and DTS 96/24 are trademarks of DTS, Inc.© 1996-2007 DTS, Inc. All Rights Reserved.

Neural Surround

Neural Surround™, a breakthrough in audio technology, will bring the excitement of surround music to more of America's listening audience. It provides the rich envelopment and discrete image detail of surround sound in a format 100 % compatible with stereo. With superior spectral resolution and channel separation, Neural Surround™ draws the brain's attention to sonic details in musical instruments, vocals, and ambience that are typically masked by other playback systems. This allows the listener to fully experience the richness and subtleties in recorded performance as never before. As the chosen format for XM Satellite Radio's new XM HD surround programming, Neural Surround will help deliver more surround music to more listeners than any other broadcast format. XM Satellite Radio will be the first radio company to broadcast surround sound on the radio 24 hours a day and will offer three channels fully dedicated to Neural Surround™ music. This alone will amount to more than 25,000 hours of Neural Surround™ music each year.



This product is manufactured under license from Neural Audio Corporation.

D&M Holdings Inc. hereby grants the user a non-exclusive, nontransferable, limited license right exercisable to use the NA SURROUND Technology and other US and World Wide Patents Pending technology.

"Neural" and "Neural Audio" and "Neural Surround" are trademarks of Neural Audio Corporation. All Rights Reserved.

Audyssey MultEQ

Audyssey MultEQ is a technology designed to provide the optimum listening environment for multiple listeners within the listening area. Test data collected from multiple listening points is analyzed comprehensively and equalization that improves the sound quality for the entire listening area is performed.

Audyssey MultEQ not only corrects frequency response problems in large listening areas, it also fully automates the surround system setup.

For a detailed description, see page 24.



Audyssey MultEQ is a trademark of Audyssey Laboratories. It is licensed under US and National Patent Applications 20030235318 and 10/700,220. Additional U.S. and Foreign Patents pending. MultEQ and the Audyssey MultEQ logo are trademarks of Audyssey Laboratories, Inc.. All rights reserved.

HDMI (High-Definition Multimedia Interface)

HDMI is a digital interface standard for next generation TVs based on DVI (Digital Visual Interface) standards and optimized for use in consumer equipment.

Non-compressed digital video and multi-channel audio signals are transmitted with a single connection.

HDMI is also compatible with HDCP (High-bandwidth Digital Contents Protection), a technology for protecting copyrights that encrypts digital video signals in the same way as with DVI.

Deep Color

Eliminates on-screen color banding, for smooth tonal transitions and subtle gradations between colors.

Enables increased contrast ratio.

Can represent many times more shades of gray between black and white.

At 30-bit pixel depth, a four times improvement would be the minimum, and the typical improvement would be eight times or more.

xvYCC

Next-generation "xvYCC" color space supports 1.8 times as many colors as existing HDTV signals.

Lets HDTVs display colors more accurately.

Enables displays with natural, vivid colors.

"HDMI", "HDMI logo" and "High-Definition Multimedia Interface" are trademarks or registered trademarks of HDMI Licensing LLC.

Surround Modes and Parameters

| Surround mode | Signals and adjustability in the different modes | | | | | | | | | | | | | | |
|---------------------|--|--------|--------------|-------------------|-----------|---|--------------------|---------------------|-----------|------------|------------|------------|--------|------------|-----------|
| | Channel output | | | | | Parameter (default values are shown in parentheses) | | | | | | | | | |
| | Front L/R | Center | Surround L/R | Surround Back L/R | Subwoofer | D. COMP * ₁ | LFE * ₂ | AFDM * ₁ | SB CH OUT | CINEMA EQ. | MODE | ROOM SIZE | LEVEL | DELAY TIME | Subwoofer |
| PURE DIRECT, DIRECT | ○ | × | × | × | ⊙ | ○ (OFF) | ○ (0 dB) | × | × | × | × | × | × | × | ○ |
| MULTI CH DIRECT | ○ | ⊙ | ⊙ | ⊙ | ⊙ | × | ○ (0 dB) | ○ (ON) | ○ | × | × | × | × | × | × |
| STEREO | ○ | × | × | × | ⊙ | ○ (OFF) | ○ (0 dB) | × | × | × | × | × | × | × | × |
| EXT. IN | ○ | ⊙ | ⊙ | ⊙ | ⊙ | × | × | × | × | × | × | × | × | × | × |
| MULTI CH IN | ○ | ⊙ | ⊙ | ⊙ | ⊙ | × | ○ (0 dB) | ○ (ON) | ○ | × | × | × | × | × | × |
| DOLBY PRO LOGIC IIx | ○ | ⊙ | ⊙ | ⊙ | ⊙ | ○ (OFF) | × | × | ○ | ○ (NOTE1) | ○ (CINEMA) | × | × | × | × |
| DOLBY PRO LOGIC II | ○ | ⊙ | ⊙ | × | ⊙ | ○ (OFF) | × | × | ○ | ○ (NOTE2) | ○ (CINEMA) | × | × | × | × |
| DTS NEO:6 | ○ | ⊙ | ⊙ | ⊙ | ⊙ | ○ (OFF) | × | × | ○ | ○ (NOTE1) | ○ (CINEMA) | × | × | × | × |
| DOLBY DIGITAL | ○ | ⊙ | ⊙ | ⊙ | ⊙ | ○ (OFF) | ○ (0 dB) | ○ (ON) | ○ | ○ (OFF) | × | × | × | × | × |
| DTS SURROUND | ○ | ⊙ | ⊙ | ⊙ | ⊙ | ○ (OFF) | ○ (0 dB) | ○ (ON) | ○ | ○ (OFF) | × | × | × | × | × |
| neural | ○ | ⊙ | ⊙ | ⊙ | ⊙ | × | × | × | ○ | × | × | × | × | × | × |
| 7CH STEREO | ○ | ⊙ | ⊙ | ⊙ | ⊙ | ○ (OFF) | ○ (0 dB) | × | ○ | × | × | × | × | × | × |
| ROCK ARENA | ○ | ⊙ | ⊙ | ⊙ | ⊙ | ○ (OFF) | ○ (0 dB) | × | ○ | × | × | ○ (medium) | ○ (10) | × | × |
| JAZZ CLUB | ○ | ⊙ | ⊙ | ⊙ | ⊙ | ○ (OFF) | ○ (0 dB) | × | ○ | × | × | ○ (medium) | ○ (10) | × | × |
| MONO MOVIE | ○ | ⊙ | ⊙ | ⊙ | ⊙ | ○ (OFF) | ○ (0 dB) | × | ○ | × | × | ○ (medium) | ○ (10) | × | × |
| VIDEO GAME | ○ | ⊙ | ⊙ | ⊙ | ⊙ | ○ (OFF) | ○ (0 dB) | × | ○ | × | × | ○ (medium) | ○ (10) | × | × |
| MATRIX | ○ | ⊙ | ⊙ | ⊙ | ⊙ | ○ (OFF) | ○ (0 dB) | × | ○ | × | × | × | × | ○ (30 ms) | × |
| VIRTURL | ○ | × | × | × | ⊙ | ○ (OFF) | ○ (0 dB) | × | × | × | × | × | × | × | × |

○ : Signal / Adjustable
 × : No signal / Not adjustable
 ⊙ : Turned on or off by speaker configuration setting

○ : Signal / Adjustable
 × : No signal / Not adjustable
 NOTE1 : This parameter is available when the menu "Parameter" - "Surround Parameter" - "MODE" is set to "CINEMA" (page 38).
 NOTE2 : This parameter is available when the menu "Parameter" - "Surround Parameter" - "MODE" is set to "CINEMA" or "PL" (page 38).
NOTE:
 *1 : When playing Dolby Digital and DTS signals.
 *2 : When playing Dolby Digital, DTS, DVD-Audio and Super Audio CD.

| Surround mode | Signals and adjustability in the different modes | | | | | | | | | |
|---------------------|---|-----------|--------------|-----------------------|--------------|--------------|------------|-----------|----------|--|
| | Parameter (default values are shown in parentheses) | | | | | | | | | |
| | PRO LOGIC II/IIx MUSIC mode only | | | NEO:6 MUSIC mode only | EXT. IN only | Tone Control | Night Mode | Room EQ | RESTORER | |
| | PANORAMA | DIMENSION | CENTER WIDTH | CENTER IMAGE | SW ATT | | | | | |
| PURE DIRECT, DIRECT | × | × | × | × | × | × | ○ (OFF) | ○ (NOTE4) | ○ | |
| MULTI CH DIRECT | × | × | × | × | × | × | ○ (OFF) | ○ (NOTE4) | × | |
| STEREO | × | × | × | × | × | ○ (0 dB) | ○ (OFF) | ○ (OFF) | ○ | |
| EXT. IN | × | × | × | × | ○ | × | × | × | × | |
| MULTI CH IN | × | × | × | × | × | ○ (0 dB) | ○ (OFF) | ○ (OFF) | × | |
| DOLBY PRO LOGIC IIx | ○ (OFF) | ○ (3) | ○ (3) | × | × | ○ (0 dB) | ○ (OFF) | ○ (OFF) | ○ | |
| DOLBY PRO LOGIC II | ○ (OFF) | ○ (3) | ○ (3) | × | × | ○ (0 dB) | ○ (OFF) | ○ (OFF) | ○ | |
| DTS NEO:6 | × | × | × | ○ (0.3) | × | ○ (0 dB) | ○ (OFF) | ○ (OFF) | ○ | |
| DOLBY DIGITAL | × | × | × | × | × | ○ (0 dB) | ○ (OFF) | ○ (OFF) | × | |
| DTS SURROUND | × | × | × | × | × | ○ (0 dB) | ○ (NOTE5) | ○ (OFF) | × | |
| neural | × | × | × | × | × | ○ (0 dB) | ○ (OFF) | ○ (OFF) | × | |
| 7CH STEREO | × | × | × | × | × | ○ (0 dB) | ○ (OFF) | ○ (OFF) | ○ | |
| ROCK ARENA | × | × | × | × | × | ○ (NOTE3) | ○ (OFF) | ○ (OFF) | ○ | |
| JAZZ CLUB | × | × | × | × | × | ○ (0 dB) | ○ (OFF) | ○ (OFF) | ○ | |
| MONO MOVIE | × | × | × | × | × | ○ (0 dB) | ○ (OFF) | ○ (OFF) | ○ | |
| VIDEO GAME | × | × | × | × | × | ○ (0 dB) | ○ (OFF) | ○ (OFF) | ○ | |
| MATRIX | × | × | × | × | × | ○ (0 dB) | ○ (OFF) | ○ (OFF) | ○ | |
| VIRTURL | × | × | × | × | × | ○ (0 dB) | ○ (OFF) | ○ (OFF) | ○ | |

○ : Adjustable

× : Not adjustable

NOTE3 : BASS +6 dB, TREBLE +4 dB

NOTE4 : Can be used according to the "Direct Mode Setup" setting.

NOTE5 : This parameter is invalid during input of the DTS96/24 signal.

Differences in Surround Mode Names Depending on the Input Signals

| Button | Surround mode | Note | Input signals | | | | | | | | | | | | |
|----------------|------------------------------|------|---------------|------------|--------------------------|-------------------------|-------------|-----------|------------------------------|---------------------------------|---------------------------|-----------------------|---------------------|----------------------|-----------------|
| | | | ANALOG | LINEAR PCM | DTS | | | | DOLBY DIGITAL | | | | | DVD-AUDIO | |
| | | | | | DTS ES DSCRT (With Flag) | DTS ES MTRX (With Flag) | DTS (5.1ch) | DTS 96/24 | DOLBY DIGITAL EX (With Flag) | DOLBY DIGITAL EX (With no Flag) | DOLBY DIGITAL (5.1/5/4ch) | DOLBY DIGITAL (4/3ch) | DOLBY DIGITAL (2ch) | DVD-Audio (multi ch) | DVD-Audio (2ch) |
| STANDARD | | | | | | | | | | | | | | | |
| DTS SURROUND | | | | | | | | | | | | | | | |
| | DTS ES DSCRT6.1 | *1 | × | × | ● ◎ | × | × | × | × | × | × | × | × | × | × |
| | DTS ES MTRX6.1 | *1 | × | × | × | ● ◎ | × | × | × | × | × | × | × | × | × |
| | DTS SURROUND | | × | × | ○ | ○ | ● | × | × | × | × | × | × | × | × |
| | DTS 96/24 | | × | × | × | × | ● | × | × | × | × | × | × | × | × |
| | DTS + PLIIx CINEMA | *2 | × | × | ○ | ○ | ○ | ○ | × | × | × | × | × | × | × |
| | DTS + PLIIx MUSIC | *1 | × | × | ○ | ○ | ○ | ○ | × | × | × | × | × | × | × |
| | DTS + NEO:6 | *1 | × | × | × | ○ | ○ | ○ | × | × | × | × | × | × | × |
| | DTS NEO:6 CINEMA | | ○ | ○ | × | × | × | × | × | × | × | × | ○ | × | ○ |
| | DTS NEO:6 MUSIC | | ○ | ○ | × | × | × | × | × | × | × | × | ○ | × | ○ |
| DOLBY SURROUND | | | | | | | | | | | | | | | |
| | DOLBY DIGITAL EX | *1 | × | × | × | × | × | × | ○ | ○ | ○ | ○ | × | × | × |
| | DOLBY DIGITAL | | × | × | × | × | × | × | ○ | ● | ● | ● | × | × | × |
| | DOLBY DIGITAL + PLIIx CINEMA | *2 | × | × | × | × | × | × | ● ◎ | ○ | ○ | ○ | × | × | × |
| | DOLBY DIGITAL + PLIIx MUSIC | *1 | × | × | × | × | × | × | ○ | ○ | ○ | ○ | × | × | × |
| | DOLBY PRO LOGIC IIx CINEMA | | ○ | ○ | × | × | × | × | × | × | × | × | ● | × | ○ |
| | DOLBY PRO LOGIC IIx MUSIC | | ○ | ○ | × | × | × | × | × | × | × | × | ○ | × | ○ |
| | DOLBY PRO LOGIC IIx GAME | | ○ | ○ | × | × | × | × | × | × | × | × | ○ | × | ○ |
| | DOLBY PRO LOGIC II CINEMA | | ○ | ○ | × | × | × | × | × | × | × | × | ○ | × | ○ |
| | DOLBY PRO LOGIC II MUSIC | | ○ | ○ | × | × | × | × | × | × | × | × | ○ | × | ○ |
| | DOLBY PRO LOGIC II GAME | | ○ | ○ | × | × | × | × | × | × | × | × | ○ | × | ○ |
| | DOLBY PRO LOGIC | | ○ | ○ | × | × | × | × | × | × | × | × | ○ | × | ○ |
| neural | | | | | | | | | | | | | | | |
| | neural | | ○ | ○ | × | × | × | × | × | × | × | × | × | × | ○ |
| MULTI CH IN | | | | | | | | | | | | | | | |
| | MULTI CH IN | | × | × | × | × | × | × | × | × | × | × | × | ● | × |
| | MULTI IN + PLIIx CINEMA | *2 | × | × | × | × | × | × | × | × | × | × | × | ○ | × |
| | MULTI IN + PLIIx MUSIC | *1 | × | × | × | × | × | × | × | × | × | × | × | ○ | × |
| | MULTI CH IN 7.1 | | × | × | × | × | × | × | × | × | × | × | × | ○ | × |

NOTE:

*1: This mode is not available when the surround back speaker setup is set to "None".

*2: This mode is not available when the surround back speaker setup is set to "1spkr" or "None".

● : Mode selectable in initial status

◎ : Mode fixed when "AFDM" is "ON"

○ : Selectable mode

× : Non-selectable mode

| Button | Surround mode | Note | Input signals | | | | | | | | | | | | | |
|----------------|-------------------------|------|---------------|------------|--------------------------|-------------------------|-------------|-----------|------------------------------|---------------------------------|---------------------------|-----------------------|---------------------|----------------------|-----------------|---|
| | | | ANALOG | LINEAR PCM | DTS | | | | DOLBY DIGITAL | | | | | DVD-AUDIO | | |
| | | | | | DTS ES DSCRT (With Flag) | DTS ES MTRX (With Flag) | DTS (5.1ch) | DTS 96/24 | DOLBY DIGITAL EX (With Flag) | DOLBY DIGITAL EX (With no Flag) | DOLBY DIGITAL (5.1/5/4ch) | DOLBY DIGITAL (4/3ch) | DOLBY DIGITAL (2ch) | DVD-Audio (multi ch) | DVD-Audio (2ch) | |
| DIRECT | | | | | | | | | | | | | | | | |
| | DIRECT | | ○ | ○ | ○ | ○ | ○ | ○ | ○ | ○ | ○ | ○ | ○ | ○ | × | ○ |
| | MULTI CH DIRECT | | × | × | × | × | × | × | × | × | × | × | × | × | ○ | × |
| | M DIRECT + PLIIx CINEMA | *2 | × | × | × | × | × | × | × | × | × | × | × | × | ○ | × |
| | M DIRECT + PLIIx MUSIC | *1 | × | × | × | × | × | × | × | × | × | × | × | × | ○ | × |
| | M DIRECT 7.1 | | × | × | × | × | × | × | × | × | × | × | × | × | ○ | × |
| PURE DIRECT | | | | | | | | | | | | | | | | |
| | PURE DIRECT | | ○ | ○ | ○ | ○ | ○ | ○ | ○ | ○ | ○ | ○ | ○ | ○ | × | ○ |
| | MULTI CH PURE DIRECT | | × | × | × | × | × | × | × | × | × | × | × | × | ○ | × |
| | M PURE D + PLIIx CINEMA | *2 | × | × | × | × | × | × | × | × | × | × | × | × | ○ | × |
| | M PURE D + PLIIx MUSIC | *1 | × | × | × | × | × | × | × | × | × | × | × | × | ○ | × |
| | M CH PURE DIRECT 7.1 | | × | × | × | × | × | × | × | × | × | × | × | × | ○ | × |
| DSP SIMULATION | | | | | | | | | | | | | | | | |
| | 7CH STEREO | *3 | ○ | ○ | ○ | ○ | ○ | ○ | ○ | ○ | ○ | ○ | ○ | ○ | ○ | ○ |
| | ROCK ARENA | | ○ | ○ | ○ | ○ | ○ | ○ | ○ | ○ | ○ | ○ | ○ | ○ | ○ | ○ |
| | JAZZ CLUB | | ○ | ○ | ○ | ○ | ○ | ○ | ○ | ○ | ○ | ○ | ○ | ○ | ○ | ○ |
| | MONO MOVIE | | ○ | ○ | ○ | ○ | ○ | ○ | ○ | ○ | ○ | ○ | ○ | ○ | ○ | ○ |
| | VIDEO GAME | | ○ | ○ | ○ | ○ | ○ | ○ | ○ | ○ | ○ | ○ | ○ | ○ | ○ | ○ |
| | MATRIX | | ○ | ○ | ○ | ○ | ○ | ○ | ○ | ○ | ○ | ○ | ○ | ○ | ○ | ○ |
| | VIRTUAL | | ○ | ○ | ○ | ○ | ○ | ○ | ○ | ○ | ○ | ○ | ○ | ○ | ○ | ○ |
| STEREO | | | | | | | | | | | | | | | | |
| | STEREO | | ● | ● | ○ | ○ | ○ | ○ | ○ | ○ | ○ | ○ | ○ | ○ | ○ | ● |

NOTE :

- *1: This mode is not available when the surround back speaker setup is set to "None".
- *2: This mode is not available when the surround back speaker setup is set to "1spkr" or "None".
- *3: If the surround back speaker setup is set to "None", then "5CH STEREO" is displayed.
- : Mode selectable in initial status
- : Selectable mode
- ×

Relationship Between Video Signals and Monitor Output

| Video convert | Input signals | | | | MONITOR OUT | | | |
|---------------|-----------------|----------------------------|---------|--------|-------------|-------------|-----------|-----------|
| | HDMI | COMPONENT | S-VIDEO | VIDEO | HDMI | COMPONENT | S-VIDEO | VIDEO |
| ON | × | × | × | × | × | × | × | × |
| | × | × | × | ○ | VIDEO | VIDEO | VIDEO | VIDEO |
| | × | × | ○ | × | S-VIDEO | S-VIDEO | S-VIDEO | S-VIDEO |
| | × | × | ○ | ○ | S-VIDEO | S-VIDEO | S-VIDEO | S-VIDEO |
| | × | ○ (1080p) | × | × | × | COMPONENT | × | × |
| | × | ○ (480p ~ 720p) | × | × | COMPONENT | COMPONENT | × | × |
| | × | ○ (480i / 576i) | × | × | COMPONENT | COMPONENT | COMPONENT | COMPONENT |
| | × | ○ (1080p) | × | ○ | VIDEO | COMPONENT*1 | VIDEO | VIDEO |
| | × | ○ (480p ~ 720p) | × | ○ | COMPONENT*1 | COMPONENT*1 | × | VIDEO |
| | × | ○ (480i / 576i) | × | ○ | COMPONENT*1 | COMPONENT*1 | COMPONENT | VIDEO |
| | × | ○ (1080p) | ○ | × | S-VIDEO | COMPONENT*2 | S-VIDEO | S-VIDEO |
| | × | ○ (480p ~ 720p) | ○ | × | COMPONENT*2 | COMPONENT*2 | S-VIDEO | S-VIDEO |
| | × | ○ (480i / 576i) | ○ | × | COMPONENT*2 | COMPONENT*2 | S-VIDEO | S-VIDEO |
| | × | ○ (1080p) | ○ | ○ | S-VIDEO | COMPONENT*2 | S-VIDEO | S-VIDEO |
| | × | ○ (480p ~ 720p) | ○ | ○ | COMPONENT*2 | COMPONENT*2 | S-VIDEO | S-VIDEO |
| | × | ○ (480i / 576i) | ○ | ○ | COMPONENT*2 | COMPONENT*2 | S-VIDEO | S-VIDEO |
| | ○ | × | × | × | HDMI | × | × | × |
| | ○ | × | × | ○ | HDMI*1 | VIDEO | VIDEO | VIDEO |
| | ○ | × | ○ | × | HDMI*2 | S-VIDEO | S-VIDEO | S-VIDEO |
| | ○ | × | ○ | ○ | HDMI*2 | S-VIDEO | S-VIDEO | S-VIDEO |
| | ○ | ○ (Other than 480i / 576i) | × | × | HDMI | COMPONENT | × | × |
| | ○ | ○ (480i / 576i) | × | × | HDMI | COMPONENT | COMPONENT | COMPONENT |
| | ○ | ○ (1080p) | × | ○ | HDMI*1 | COMPONENT*1 | VIDEO | VIDEO |
| | ○ | ○ (480p ~ 720p) | × | ○ | HDMI*1 | COMPONENT*1 | × | VIDEO |
| | ○ | ○ (480i / 576i) | × | ○ | HDMI*1 | COMPONENT*1 | COMPONENT | VIDEO |
| | ○ | ○ (Other than 480i / 576i) | ○ | × | HDMI*2 | COMPONENT*2 | S-VIDEO | S-VIDEO |
| | ○ | ○ (480i / 576i) | ○ | × | HDMI*2 | COMPONENT*2 | S-VIDEO | S-VIDEO |
| | ○ | ○ (Other than 480i / 576i) | ○ | ○ | HDMI*2 | COMPONENT*2 | S-VIDEO | S-VIDEO |
| ○ | ○ (480i / 576i) | ○ | ○ | HDMI*2 | COMPONENT*2 | S-VIDEO | S-VIDEO | |

○ : Signal input
 × : No signal
 480p ~ 720p: 480p / 576p / 1080i / 720p

× : Not output
 *1 : On-screen display superimposed on video signal and output.
 *2 : On-screen display superimposed on S-Video signal and output.

COMPONENT or HDMI:
 On-screen display only displayed for **MENU** button and the remote control unit's **DISPLAY** button.
 :Video signals are not output when the analog to HDMI convert function is set to "OFF".

- The main zone video conversion function is compatible with the following format: NTSC, PAL, SECAM, NTSC4.43, PAL-N, PAL-M and PAL-60.
- When SECAM signals of video input are up-converted, the signals are output in PAL format from the S-Video connector.
- When the input signal is a component 1080i or 720p signal, the signal upconverted to HDMI is output with that resolution or 1080p.
- When the input signal is a video, S-Video or component 480i, 480p, 576i or 576p signals, the signal up-converted to HDMI is output according to the setting made at "Resolution" under "HDMI Setup" – "HDMI Video Setup" (page 28).
- Signals up-converted to HDMI are output to the HDMI monitor with the resolution at which they are input.

| Video convert | S-VIDEO MONITOR OUT | Input signals | | | | MONITOR OUT | | | |
|---------------|------------------------|---------------|-----------|---------|-------|-------------|-------------|---------|---------|
| | | HDMI | COMPONENT | S-VIDEO | VIDEO | HDMI | COMPONENT | S-VIDEO | VIDEO |
| OFF | — | × | × | × | × | × | × | × | × |
| | — | × | × | × | ○ | × | × | × | VIDEO |
| | — | × | × | ○ | × | × | × | S-VIDEO | × |
| | Used | × | × | ○ | ○ | × | × | S-VIDEO | VIDEO*2 |
| | Not used | × | × | ○ | ○ | × | × | — | VIDEO |
| | — | × | ○ | × | × | × | COMPONENT | × | × |
| | — | × | ○ | × | ○ | × | COMPONENT*1 | × | VIDEO |
| | — | × | ○ | ○ | × | × | COMPONENT*2 | S-VIDEO | × |
| | Used | × | ○ | ○ | ○ | × | COMPONENT*2 | S-VIDEO | VIDEO*2 |
| | Not used | × | ○ | ○ | ○ | × | COMPONENT*1 | — | VIDEO |
| | — | ○ | × | × | × | HDMI | × | × | × |
| | — | ○ | × | × | ○ | HDMI | × | × | VIDEO |
| | — | ○ | × | ○ | × | HDMI | × | S-VIDEO | × |
| | Used | ○ | × | ○ | ○ | HDMI | × | S-VIDEO | VIDEO*2 |
| | Not used | ○ | × | ○ | ○ | HDMI | × | — | VIDEO |
| | — | ○ | ○ | × | × | HDMI | COMPONENT | × | × |
| | — | ○ | ○ | × | ○ | HDMI | COMPONENT*1 | × | VIDEO |
| | — | ○ | ○ | ○ | × | HDMI | COMPONENT*2 | S-VIDEO | × |
| | Used | ○ | ○ | ○ | ○ | HDMI | COMPONENT*2 | S-VIDEO | VIDEO*2 |
| | Not used | ○ | ○ | ○ | ○ | HDMI | COMPONENT*1 | — | VIDEO |

○ : Signal input
 × : No signal

× : Not output
 *1 : On-screen display superimposed on video signal and output.
 *2 : On-screen display superimposed on S-Video signal and output.

COMPONENT or HDMI:
 On-screen display only displayed for **MENU** button and the remote control unit's **DISPLAY** button.

Troubleshooting

If a problem should arise, first check the following:

1. Are the connections correct?
2. Is the set being operated as described in the owner's manual?
3. Are the other components operating properly?

If this unit does not operate properly, check the items listed in the table below. Should the problem persist, there may be a malfunction.

In this case, disconnect the power immediately and contact your store of purchase.

[General]

| Symptom | Cause | Countermeasure | Page |
|---|--|---|------|
| Power does not turn on, or turns off directly after it was turned on. | <ul style="list-style-type: none"> • Connection of the power cord is faulty. | <ul style="list-style-type: none"> • Check that the power plugs are securely inserted into the AVR-888's AC inlet and the wall power outlet. | 19 |
| No sound is produced from speakers. | <ul style="list-style-type: none"> • Connection with the input devices or connection of the speaker cables is faulty. | <ul style="list-style-type: none"> • Check the connections. | 9 |
| | <ul style="list-style-type: none"> • Device you want to play and set input source do not match. | <ul style="list-style-type: none"> • Select an appropriate input source. | 43 |
| | <ul style="list-style-type: none"> • Master volume is turned too low. | <ul style="list-style-type: none"> • Adjust the master volume to an appropriate level. | 43 |
| | <ul style="list-style-type: none"> • Mute mode is set. • Headphones are connected. | <ul style="list-style-type: none"> • Cancel the mute mode. • Disconnect the headphones. | 43 |
| | <ul style="list-style-type: none"> • No digital signals are being input. | <ul style="list-style-type: none"> • Select an input source for which the digital input setting has been made. | 35 |
| | <ul style="list-style-type: none"> • The connectors to which the digital inputs are assigned and the settable input modes do not match. | <ul style="list-style-type: none"> • Set the input mode. | 34 |
| Display is off. | <ul style="list-style-type: none"> • The "Dimmer" setting is set to "OFF". • The PURE DIRECT mode is set. | <ul style="list-style-type: none"> • Set to something other than "OFF". | 32 |
| | | <ul style="list-style-type: none"> • Set a surround mode other than the PURE DIRECT mode. | 37 |
| "DOLBY DIGITAL" indicator does not appear on display. | <ul style="list-style-type: none"> • DVD player's digital audio output setting is not proper. | <ul style="list-style-type: none"> • Check the DVD player's audio output setting. For details, read the DVD player's operating instructions. | - |

| Symptom | Cause | Countermeasure | Page |
|---|---|--|------|
| Power turns off suddenly and power indicator flashes red. | <ul style="list-style-type: none"> • Protection circuit activated due to rise of internal temperature. | <ul style="list-style-type: none"> • Turn off the power, wait for the set to fully cool down, then turn the power back on. | 10 |
| | <ul style="list-style-type: none"> • Core wires of two speakers are touching each other or a core wire is sticking out of the terminal and touching the set's rear panel, activating the protection circuit. | <ul style="list-style-type: none"> • Place the set in a well-ventilated place. • First unplug the power cord, then twist the core wires tightly or terminate the speaker cables, then reconnect. | 10 |
| | <ul style="list-style-type: none"> • Speakers with an impedance other than specified are being used. • Set is damaged. | <ul style="list-style-type: none"> • Use speakers with the specified impedance. • Turn off the power and contact a DENON service center. | 10 |
| | | | - |

[Remote Control Unit]

| Symptom | Cause | Countermeasure | Page |
|---|---|--|------|
| Set does not work properly when remote control unit operated. | <ul style="list-style-type: none"> • Batteries are worn. | <ul style="list-style-type: none"> • Replace with new batteries. | 3 |
| | <ul style="list-style-type: none"> • You are operating outside of the specified range. | <ul style="list-style-type: none"> • Operate within the specified range. | 3 |
| | <ul style="list-style-type: none"> • Obstacle between main unit and remote control unit. | <ul style="list-style-type: none"> • Remove the obstacle. | 3 |
| | <ul style="list-style-type: none"> • The batteries are not inserted in the proper direction, as indicated by the polarity marks in the battery compartment. | <ul style="list-style-type: none"> • Insert the batteries in the proper direction, following the polarity marks in the battery compartment. | 3 |
| | <ul style="list-style-type: none"> • The set's remote control sensor is exposed to strong light (direct sunlight, inverter type fluorescent bulb light, etc.). | <ul style="list-style-type: none"> • Move the set to a place in which the remote control sensor will not be exposed to strong light. | 3 |
| | <ul style="list-style-type: none"> • The remote ID of the main unit and remote control unit do not match. | <ul style="list-style-type: none"> • Set Remote ID for the main unit to "1". | 32 |

[Audio]

| Symptom | Cause | Countermeasure | Page |
|---|---|--|------|
| No sound is produced from center speaker. | • You are playing a monaural source (TV, AM radio broadcast, etc.) in the STANDARD mode. | • The mode is set to something other than "STANDARD". | 36 |
| No sound is produced from surround speakers. | • The surround mode is set to "STEREO", "DIRECT" or "PURE DIRECT". | • Set to a surround playback mode. | 37 |
| No sound is produced from surround back speaker. | • The surround back speaker's power amplifier is assigned to a different channel. • Surround back speaker setting is set to "None". • Surround mode not set to a mode for 6.1- or 7.1-channel playback. | • Check the setting and change it as necessary. | 31 |
| | | • Set to something other than "None". | 26 |
| | | • Select a surround playback mode. | 37 |
| No sound is produced from subwoofer. | • Subwoofer's power not turned on. • The "Subwoofer" setting at "Speaker Configuration" is set to "No". • The subwoofer is not properly connected. • The subwoofer's volume is turned off. | • Turn on the subwoofer's power. | - |
| | | • Set to "Yes". | 26 |
| | | • Check the connections. | 9 |
| | | • Adjust the subwoofer's volume to an appropriate level. | 48 |
| No test tones are produced when remote control unit's TEST button is pressed. | • Surround mode not set to "STANDARD". | • Set to the STANDARD mode. | 36 |
| DTS sound is not output. | • DVD player's audio output setting is not set to bitstream. • DVD player is not compatible with DTS sound playback. • The AVR-888's "Decode Mode" setting is set to "PCM". | • Set the DVD player. For details, refer to the DVD player's operating instructions. | - |
| | | • Use a DTS-compatible player. | - |
| | | • Set to the "Auto" or "DTS" mode. | 34 |
| HDMI audio signals are not output from speakers. | • The "Manual Setup" - "HDMI Setup" - "HDMI Audio Setup" - "HDMI Audio Out" setting is set to "TV". | • Set to "AMP". | 27 |

| Symptom | Cause | Countermeasure | Page |
|--|--|----------------|------|
| No sound is output from the monitor connected with HDMI connections. | • The "Manual Setup" - "HDMI Setup" - "HDMI Audio Setup" - "HDMI Audio Out" setting is set to "AMP". | • Set to "TV". | 27 |

[Video]

| Symptom | Cause | Countermeasure | Page |
|---|---|---|---------|
| No picture appears. | • The connections between the AVR-888 and monitor are faulty. • The monitor's input setting is wrong. • PURE DIRECT mode is set. • The player is connected using the component input connectors, the monitor is connected using the video (yellow) or S-Video output connectors. | • Check the connections. | 11 ~ 19 |
| | | • Set properly. | - |
| | | • Cancel the PURE DIRECT mode. • High definition (1080i/720p) and progressive (480p/576p) video signals are not down-converted. Set the player to interlace (480i/576i) signals. | 37 - |
| No picture appears with HDMI connections. | • The connections to the HDMI connectors are faulty. • HDMI input setting is improper. • The monitor is not compatible with copyright protection (HDCP). • The HDMI format of the player and monitor do not match. | • Check the connections. | 11 |
| | | • Check the HDMI input setting. | 34 |
| | | • Connect a monitor that is compatible with copyright protection (HDCP). • Match the HDMI format of the player and monitor. | 11 |
| Picture cannot be recorded. | • Input source does not match recorder's video connection connector (video or S-Video). | • The video conversion function does not work for the REC OUT connectors. Match the input source and recorder connections. | 15 |
| DVDs cannot be copied on a VCR. | - | • This is not a malfunction. Most movie software includes copy prevention signals and cannot be copied. | - |

[iPod]

| Symptom | Cause | Countermeasure | Page |
|------------------------|---|---|------------------------------|
| iPod cannot be played. | <ul style="list-style-type: none"> The input source assigned to "iPod dock" is not selected. Cable is not properly connected. Control Dock for iPod's AC adapter is not connected to power outlet. | <ul style="list-style-type: none"> Switch to the input source assigned at "iPod dock". Reconnect. Plug the Control Dock for iPod's AC adapter into a power outlet. | <p>35</p> <p>14</p> <p>–</p> |

[XM Satellite Radio]

| Symptom | Cause | Countermeasure | Page |
|--|---|--|--------|
| "CHECK ANTENNA" is displayed in the XM mode. | <ul style="list-style-type: none"> AVR-888's XM connector and the XM Mini-Tuner and Home Dock is not properly connected. | <ul style="list-style-type: none"> Check that the connections are correct. | 17 |
| "NO SIGNAL" is displayed in the XM mode. | <ul style="list-style-type: none"> The signal cannot be received. | <ul style="list-style-type: none"> Reposition your XM Mini-Tuner and Home Dock antenna. | 46 |
| "OFF AIR" is displayed in the XM mode. | <ul style="list-style-type: none"> The selected channel is not currently broadcasting. | <ul style="list-style-type: none"> Select another channel. | 45, 46 |
| Receiving only XM channels 0 and 1. | <ul style="list-style-type: none"> The XM Tuner is not activated. | <ul style="list-style-type: none"> Contact XM Radio. | 45 |

Specifications

Audio section

Power amplifier

| | |
|---------------------------|---|
| Rated output: | Front (A, B): 100 W + 100 W (8 Ω/ohms, 20 Hz ~ 20 kHz with 0.08 % T.H.D.) 135 W + 135 W (6 Ω/ohms, 1 kHz with 0.7 % T.H.D.) Center: 100 W (8 Ω/ohms, 20 Hz ~ 20 kHz with 0.08 % T.H.D.) 135 W (6 Ω/ohms, 1 kHz with 0.7 % T.H.D.) Surround (A + B): 100 W + 100 W (8 Ω/ohms, 20 Hz ~ 20 kHz with 0.08 % T.H.D.) 135 W + 135 W (6 Ω/ohms, 1 kHz with 0.7 % T.H.D.) Surround Back: 100 W + 100 W (8 Ω/ohms, 20 Hz ~ 20 kHz with 0.08 % T.H.D.) 135 W + 135 W (6 Ω/ohms, 1 kHz with 0.7 % T.H.D.) |
| Dynamic power: | 120 W x 2ch (8 Ω/ohms) 170 W x 2ch (4 Ω/ohms) |
| Output connectors: | Front: A or B 6 ~ 16 Ω/ohms A + B 12 ~ 16 Ω/ohms Center, Surround, Surround Back: 6 ~ 16 Ω/ohms |

Analog

| | |
|--|---|
| Input sensitivity / Input impedance: | 200 mV / 47 kΩ/kohms |
| Frequency response: | 10 Hz ~ 100 kHz — +1, -3 dB (DIRECT mode) |
| S/N: | 100 dB (DIRECT mode) |
| Distortion: | 0.008 % (20 Hz ~ 20 kHz) (DIRECT mode) |
| Rated output: | 1.2 V |
| Phono equalizer (PHONO input — REC OUT) | |
| Input sensitivity: | 2.5 mV |
| RIAA deviation: | ±1 dB (20 Hz to 20 kHz) |
| S/N: | 74 dB (A weighting, with 5 mV input) |
| Rated output: | 150 mV |
| Distortion factor: | 0.03 % (1 kHz, 3 V) |

Video section

Standard video connectors

| | |
|--|---|
| Input / output level and impedance: | 1 Vp-p, 75 Ω/ohms |
| Frequency response: | 5 Hz ~ 10 MHz — +0, -3 dB (when video convert set to "OFF") |

S-Video connectors

| | |
|--|---|
| Input / output level and impedance: | Y (brightness) signal — 1 Vp-p, 75 Ω/ohms C (color) signal — 0.286 Vp-p, 75 Ω/ohms |
| Frequency response: | 5 Hz ~ 10 MHz — +0, -3 dB (when video convert set to "OFF") |

Color component video connector

| | |
|--|---|
| Input / output level and impedance: | Y (brightness) signal — 1 Vp-p, 75 Ω/ohms P _B / C _B signal — 0.7 Vp-p, 75 Ω/ohms P _R / C _R signal — 0.7 Vp-p, 75 Ω/ohms |
| Frequency response: | 5 Hz ~ 100 MHz — +0, -3 dB (when video convert set to "OFF") |

Tuner section

| | [FM] | [AM] |
|--|--|--------------------|
| Receiving Range: | (note: μV at 75 Ω/ohms, 0 dBf = 1 × 10 ⁻¹⁵ W) 87.5 MHz ~ 107.9 MHz | 520 kHz ~ 1710 kHz |
| Usable Sensitivity: | 1.0 μV (11.2 dBf) | 18 μV |
| 50 dB Quieting Sensitivity: | MONO 1.6 μV (15.3 dBf) STEREO 23 μV (38.5 dBf) | |
| S/N (IHF-A): | MONO 77 dB STEREO 72 dB | |
| Total harmonic Distortion (at 1 kHz): | MONO 0.15 % STEREO 0.3 % | |

General

| | |
|-------------------------------------|--|
| Power supply: | AC 120 V, 60 Hz |
| Power consumption: | 5.5 A 0.3 W (Standby) |
| Maximum external dimensions: | 434 (W) x 171 (H) x 417 (D) mm (17-3/32" x 6-47/64" x 16-27/64") |
| Weight: | 12.6 kg (27 lbs 12.5 oz) |

Remote control unit (RC-1080)

| | |
|-------------------------------------|---|
| Batteries: | R6P/AA Type (two batteries) |
| Maximum external dimensions: | 52 (W) x 243 (H) x 21 (D) mm (2-3/64" x 9-9/16" x 53/64") |
| Weight: | 184 g (Approx 6.5 oz) (including batteries) |

* For purposes of improvement, specifications and design are subject to change without notice.

List of preset codes / Liste de codes pré-régulés

DVD Player

| | | |
|----------|------------|--------------------|
| A | Aiwa | 009 |
| D | Denon | 014, [111]* |
| H | Hitachi | 010 |
| J | JVC | 006, 011 |
| K | Konka | 012, 013 |
| M | Magnavox | 005 |
| | Mitsubishi | 004 |
| P | Panasonic | 014 |
| | Philips | 005, 015, 016, 017 |
| | Pioneer | 003, 008 |
| S | Sanyo | 018 |
| | Sony | 002, 019, 020 |
| T | Toshiba | 001, 021, 022 |
| Z | Zenith | 023 |

VDP

| | | |
|----------|------------|--------------------|
| D | Denon | 028, 029, 112 |
| M | Magnavox | 026 |
| | Mitsubishi | 028 |
| P | Panasonic | 029, 030 |
| | Philips | 026 |
| | Pioneer | 028, 031 |
| R | RCA | 032 |
| S | Sony | 033, 034, 035, 036 |

VCR

| | | |
|----------|---------------|-----------------------------------|
| A | Admiral | 081 |
| | Aiko | 095 |
| | Aiwa | 009 |
| | Akai | 026, 027, 070, 072, 082, 083, 084 |
| | Alba | 055 |
| | Amstrad | 009 |
| | ASA | 042 |
| | Asha | 087 |
| | Audio Dynamic | 005, 085 |
| | Audiovox | 088 |
| | Beaumarck | 087 |
| | Broksonic | 086, 093 |
| C | Calix | 088 |
| | Candle | 006, 087, 088, 089, 090 |
| | Canon | 049, 057 |
| | Capehart | 025, 055, 056, 071 |
| | Carver | 015 |
| | CCE | 095 |
| | Citizen | 006, 007, 087, 088, 089, 090, 095 |
| | Craig | 007, 087, 088, 091, 115 |

| | | |
|----------|-----------------|--|
| | Curtis Mathes | 006, 049, 073, 080, 087, 090, 092 |
| | Cybernex | 087 |
| D | Daewoo | 025, 055, 059, 074, 089, 093, 095, 096 |
| | Daytron | 025, 055 |
| | DBX | 005, 085 |
| | Dumont | 053 |
| | Dynatech | 009 |
| E | Electrohome | 001, 088, 097 |
| | Electrohome | 088 |
| | Emerson | 001, 009, 017, 027, 086, 088, 089, 092, 093, 097, 100, 101, 102, 103, 104, 117 |
| F | Fisher | 009, 028, 031, 053, 054, 091, 099, 115 |
| G | GE | 007, 011, 049, 050, 051, 052, 073, 080, 087 |
| | Go Video | 047, 048 |
| | Goldstar | 000, 006, 012, 062, 088 |
| | Gradiente | 094 |
| | Grundig | 042 |
| H | Harley Davidson | 094 |
| | Harman Kardon | 040, 062 |
| | Hi-Q | 091 |
| | Hitachi | 009, 013, 023, 026, 058, [108]*, 109, 110, 111 |
| J | JC Penny | 004, 005, 007, 023, 028, 049, 062, 085, 087, 088 |
| | Jensen | 013, 026 |
| | JVC | 004, 005, 006, 026, 029, 043, 044, 045, 046, 085 |
| K | Kenwood | 004, 005, 006, 026, 029, 033, 045, 085, 090 |
| | Kodak | 088 |
| L | Lloyd | 009, 094 |
| | LXI | 088 |
| M | Magnavox | 015, 016, 042, 049, 063, 106 |
| | Magnin | 087 |
| | Marantz | 004, 005, 006, 015, 042, 049, 085, 090 |
| | Marta | 088 |
| | MEI | 049 |
| | Memorex | 009, 033, 049, 053, 060, 081, 087, 088, 091, 094, 115 |
| | Metz | 123, 124, 125, 126, 127, 128 |
| | MGA | 001, 017, 027, 041, 097 |
| | MGN Technology | 087 |
| | Midland | 011 |
| | Minolta | 013, 023 |
| | Mitsubishi | 001, 003, 008, 013, 014, 017, 027, 029, 039, 040, 041, 045, 097 |
| | Motorola | 081 |
| | Montgomery Ward | 001, 002, 007, 009, 049, 063, 081, 115, 117 |
| | MTC | 009, 087, 094 |

| | | |
|----------|-------------|---|
| | Multitech | 007, 009, 011, 087, 090, 094 |
| N | NAD | 038 |
| | NEC | 004, 005, 006, 018, 026, 029, 045, 061, 062, 085 |
| | Nikko | 088 |
| | Noblex | 087 |
| O | Optimus | 081, 088 |
| | Optonica | 021 |
| P | Panasonic | 024, 049, 064, 066, 067, 068, 069, 107 |
| | Perdio | 009 |
| | Pentax | 009, 013, 023, 058, 090 |
| | Philco | 015, 016, 049 |
| | Philips | 015, 021, 042, 049, 105 |
| | Pilot | 088 |
| | Pioneer | 005, 013, 029, 036, 037, 038, 045, 085 |
| | Portland | 025, 055, 090 |
| | Proscan | 063, 080 |
| | Pulsar | 060 |
| Q | Quartz | 033 |
| | Quasar | 034, 035, 049 |
| R | Radio Shack | 001, 002, 021, 081, 087, 088, 091, 094, 097, 098, 115 |
| | Radix | 088 |
| | Randex | 088 |
| | RCA | 007, 013, 019, 023, 058, 063, 064, 065, 073, 080, 082, 087, 089, 021, 031, 033, 049, 053, 081, 087, 088, 091, 094, 097, 098 |
| | Realistic | 055 |
| S | Salora | 033, 041 |
| | Samsung | 007, 011, 051, 059, 070, 083, 087, 089, 113 |
| | Sanky | 081 |
| | Sansui | 005, 026, 029, 045, 061, 085, 114 |
| | Sanyo | 032, 033, 053, 087, 091, 115, 116 |
| | SBR | 042 |
| | Scott | 017, 020, 086, 089, 093, 117 |
| | Sears | 013, 023, 028, 031, 033, 053, 054, 088, 091, 098, 099, 115 |
| | Sentra | 055 |
| | Sharp | 001, 002, 021, 097 |
| | Shogun | 087 |
| | Sony | 075, 076, 077, 078, 079, 121, 122 |
| | STS | 023 |
| | Sylvania | 009, 015, 016, 017, 041, 049, 094 |
| | Symphonic | 009, 094 |
| T | Tandy | 009 |
| | Tashiko | 009, 088 |
| | Tatung | 004, 026, 030 |

| | | |
|----------|------------------|--|
| | Teac | 004, 009, 026, 094 |
| | Technics | 024, 049 |
| | TMK | 087, 092 |
| | Toshiba | 013, 017, 020, 041, 059, 089, 098, 099, 117 |
| | Totevision | 007, 087, 088 |
| U | Unirech | 087 |
| V | Vectror Research | 005, 062, 085, 089, 090 |
| | Victor | 005, 045, 046, 085 |
| | Video Concepts | 005, 027, 085, 089, 090 |
| | Videosonic | 007, 087 |
| W | Wards | 013, 021, 023, 087, 088, 089, 091, 094, 097, 118, 119, 120 |
| X | XR-1000 | 094 |
| Y | Yamaha | 004, 005, 006, 026, 062, 085 |
| Z | Zenith | 060, 078, 079 |

Television

| | | |
|----------|---------------|--|
| A | Admiral | 045, 121 |
| | Adventura | 122 |
| | Aiko | 054 |
| | Akai | 016, 027, 046 |
| | Alleron | 062 |
| | A-Mark | 007 |
| | Amtron | 061 |
| | Anam | 006, 007, 036 |
| | Anam National | 061, 147 |
| | AOC | 003, 007, 033, 038, 039, 047, 048, 049, 133 |
| | Archer | 007 |
| | Audiovox | 007, 061 |
| B | Bauer | 155 |
| | Belcor | 047 |
| | Bell & Howell | 045, 118 |
| | Bradford | 061 |
| | Brockwood | 003, 047 |
| C | Candle | 003, 030, 031, 032, 038, 047, 049, 050, 122 |
| | Capehart | 003 |
| | Celebrity | 046 |
| | Circuit City | 003 |
| | Citizen | 029, 030, 031, 032, 034, 038, 047, 049, 050, 054, 061, 095, 122, 123 |
| | Concerto | 031, 047, 049 |
| | Colortyme | 003, 047, 049, 135 |
| | Contec | 013, 051, 052, 061 |
| | Cony | 051, 052, 061 |
| | Craig | 004, 061 |
| | Crown | 029 |
| | Curtis Mathes | 029, 034, 038, 044, 047, 049, 053, 095, 118 |

| | | |
|----------|----------------|--|
| D | Daewoo | 027, 029, 039, 048, 049, 054, 055, 106, 107, 137 |
| | Daytron | 003, 049 |
| | Dimensia | 044 |
| | Dixi | 007, 015, 027 |
| E | Electroband | 046 |
| | Electrohome | 029, 056, 057, 058, 147 |
| | Elta | 027 |
| | Emerson | 029, 051, 059, 060, 061, 062, 118, 123, 124, 139, 148 |
| | Envision | 038 |
| | Etron | 027 |
| F | Fisher | 014, 021, 063, 064, 065, 118 |
| | Formenti | 155 |
| | Fortress | 012 |
| | Fujitsu | 004, 062 |
| | Funai | 004, 062 |
| | Futuretech | 004 |
| G | GE | 020, 036, 037, 040, 044, 058, 066, 088, 119, 120, 125, 147 |
| | Goldstar | 000, 015, 029, 031, 039, 048, 051, 056, 057, 067, 068, 069, 116 |
| | Grundy | 062 |
| H | Hitachi | 029, 031, 051, 052, 070, 111, 112, 113, 124, [134]* |
| | Hitachi Pay TV | 151 |
| I | Infinity | 017, 071 |
| J | Janeil | 122 |
| | JBL | 017, 071 |
| | JC Penny | 020, 034, 039, 040, 041, 044, 048, 050, 058, 066, 069, 076, 088, 090, 095, 125, 136, 159 |
| | JCB | 046 |
| | JVC | 019, 051, 052, 072, 073, 091, 117, 126 |
| K | Kawasho | 018, 046 |
| | Kenwood | 038, 056, 057 |
| | Kloss | 010, 032 |
| | Kloss Novabeam | 005, 122, 127, 131 |
| | KTV | 074, 123 |
| L | Loewe | 071 |
| | logik | 144 |
| | Luxman | 031 |
| | LXI | 008, 014, 017, 024, 040, 044, 063, 071, 075, 076, 077, 118, 125 |
| M | Magnavox | 005, 010, 017, 030, 033, 038, 050, 056, 071, 078, 079, 085, 089, 108, 109, 110, 127, 131, 132, 145 |
| | Marantz | 015, 017, 071, 080 |
| | Matsui | 027 |
| | Memorex | 014, 027, 045, 083, 118, 144 |
| | Metz | 160, 161, 162, 163 |

| | |
|-------------------|---|
| MGA | 001, 039, 048, 056, 057, 058, 065, 081, 083 |
| Midland | 125 |
| Minutz | 066 |
| Mitsubishi | 001, 016, 039, 048, 056, 057, 058, 065, 081, 082, 083, 105 |
| Montgomery Ward | 011, 020, 144, 145, 146 |
| Motorola | 121, 147 |
| MTC | 031, 034, 039, 048, 095 |
| NAD | 008, 075, 076, 128 |
| National | 002, 036, 061, 147 |
| National Quenties | 002 |
| NEC | 031, 038, 039, 048, 057, 084, 086, 135, 147 |
| Nikko | 054 |
| NTC | 054 |
| Optimus | 128 |
| Optonica | 011, 012, 093, 121 |
| Orion | 004, 139 |
| Panasonic | 002, 009, 017, 036, 037, 071, 141, 143, 147 |
| Philco | 005, 010, 030, 050, 051, 056, 079, 085, 127, 131, 132, 145, 147 |
| Philips | 005, 015, 017, 050, 051, 056, 078, 087, 088, 089, 131, 132, 147 |
| Pioneer | 124, 128, 142 |
| Portland | 054 |
| Price Club | 095 |
| Proscan | 040, 044, 125 |
| Proton | 035, 051, 092, 129 |
| Pulsar | 042 |
| Quasar | 036, 037, 074, 141 |
| Radio Shack | 011, 044, 063, 093, 118 |
| RCA | 040, 044, 125, 130, 137, 151, 152 |
| Realistic | 014, 063, 093, 118 |
| Saisho | 027 |
| Samsung | 003, 015, 034, 053, 055, 057, 094, 095, 136, 153 |
| Sansui | 139 |
| Sanyo | 013, 014, 021, 022, 063, 064, 081, 096 |
| SBR | 015 |
| Schneider | 015 |
| Scott | 062 |
| Sears | 008, 014, 021, 022, 023, 024, 025, 040, 052, 057, 062, 063, 064, 065, 073, 075, 076, 097, 098, 125, 159 |
| Sharp | 011, 012, 013, 026, 093, 099, 100, 104, 121 |
| Siemens | 013 |
| Signature | 045, 144 |
| Simpson | 050 |
| Sony | 043, 046, 138, 146, 150 |
| Soundesign | 030, 050, 062 |
| Spectricon | 007, 033 |

| | |
|----------------|--|
| Squareview | 004 |
| Supre-Macy | 032, 122 |
| Supreme | 046 |
| Sylvania | 005, 010, 017, 030, 078, 079, 085, 089, 101, 127, 131, 132, 145, 155 |
| Symphonic | 004, 148 |
| Tandy | 012, 121 |
| Tatung | 036, 124 |
| Technics | 037 |
| Teknika | 001, 030, 032, 034, 052, 054, 078, 083, 095, 144, 156, 157 |
| Tera | 035, 129 |
| THOMSON | 165, 166 |
| Toshiba | 008, 014, 034, 063, 075, 076, 095, 097, 136, 158, 159 |
| Universal | 020, 066, 088 |
| Victor | 019, 073, 126 |
| Video Concepts | 016 |
| Viking | 032, 122 |
| Wards | 005, 045, 066, 078, 085, 088, 089, 093, 102, 103, 131, 132, 148 |
| Zenith | 042, 114, 115, 140, 144, 149 |
| Zonda | 007 |

Cable

| | |
|--------------------|-------------------------|
| ABC | 006, [007]*, 008, 009 |
| Archer | 010, 011 |
| Century | 011 |
| Citizen | 011 |
| Colour Voice | 012, 013 |
| Comtronic | 014 |
| Eastern | 015 |
| Garrard | 011 |
| Gemini | 030, 033, 034 |
| General Instrument | 030, 031, 032 |
| Hytex | 006 |
| Jasco | 011 |
| Jerrold | 009, 016, 017, 026, 032 |
| Magnavox | 018 |
| Movie Time | 019 |
| NSC | 019 |
| Oak | 000, 006, 020 |
| Panasonic | 001, 005 |
| Philips | 011, 012, 013, 018, 021 |
| Pioneer | 002, 003, 022 |
| RCA | 029 |
| Regency | 015 |
| Samsung | 014, 023 |
| Scientific Atlanta | 004, 024, 025 |
| Signal | 014 |
| SL Marx | 014 |
| Starcom | 009 |

| | |
|----------------|----------|
| Stargate | 014 |
| Televue | 014 |
| Tocom | 007, 016 |
| TV86 | 019 |
| Unika | 011 |
| United Artists | 006 |
| Universal | 010, 011 |
| Viewstar | 018, 019 |
| Zenith | 027, 028 |

Satellite Receiver

| | |
|---------------------|-------------------------|
| Alphastar | 054 |
| Chaparrali | 035, 036 |
| Dishnet | 053 |
| Drake | 037, 038 |
| Echostar Dish | 062, 066 |
| GE | 048, 055, 056 |
| General Instruments | 039, 040, 041 |
| Grundig | 070, 071, 072, 073 |
| Hitachi | 058, 059 |
| Hughes Networkr | 063, 064, 065, 069 |
| JVC | 057 |
| Kathrein | 074, 075, 076, 083 |
| Magnavoxl | 060 |
| Nokia | 070, 080, 084, 085, 086 |
| Philips | 060 |
| Primestar | 051 |
| Proscan | 048, 055, 056 |
| RCA | 048, 055, 056, 068 |
| Realistic | 042 |
| Sierra I | 036 |
| Sierra II | 036 |
| Sierra III | 036 |
| Sony | 049, 067 |
| STS1 | 043 |
| STS2 | 044 |
| STS3 | 045 |
| SRS4 | 046 |
| Technisat | 077, 078, 079, 081, 082 |
| Toshiba | 047, 050 |
| Uniden | 061 |

CD Player

| | |
|----------|--------------------|
| Aiwa | 001, 035, 043 |
| Burmster | 002 |
| Carvery | 003, 035 |
| Denon | [111]*, 044 |
| Emerson | 004, 005, 006, 007 |
| Fisher | 003, 008, 009, 010 |
| JVC | 018, 019 |

| | |
|----------|-------------------------|
| Kenwood | 011, 012, 013, 014, 017 |
| Magnavox | 006, 015, 035 |
| Marantz | 016, 028, 035 |
| MCS | 016, 024 |
| Onkyo | 025, 027 |
| Optimus | 017, 020, 021, 022, 023 |
| Philips | 014, 032, 033, 035 |
| Pioneer | 006, 022, 030 |
| Sears | 006 |
| Sony | 023, 031 |
| Teac | 002, 009, 028 |
| Technics | 016, 029, 036 |
| Wards | 035, 037 |
| Yamaha | 038, 039, 040, 041 |
| Zenith | 042 |

CD Recorder

| | |
|---------|-------------|
| Denon | [151]*, 112 |
| philips | 112 |

MD Recorder

| | |
|---------|----------|
| Kenwood | 053, 054 |
| Onkyo | 057 |
| Sharp | 055 |
| Denon | 113 |
| Sony | 056 |

Tape Deck

| | |
|---------------|---------------|
| Aiwa | 001, 002 |
| Carver | 002 |
| Denon | 111 |
| Harman/Kardon | 002, 003 |
| JVC | 004, 005 |
| Kenwood | 006 |
| Magnavox | 002 |
| Marantz | 002 |
| Onkyo | 016, 018 |
| Optimus | 007, 008 |
| Panasonic | 012 |
| Philips | 002 |
| pioneer | 007, 008, 009 |
| Sony | 013, 014, 015 |
| Technics | 012 |
| Victor | 004 |
| Wards | 007 |
| Yamaha | 010, 011 |

| DVD preset codes / Codes pré-régés DVD | | |
|--|------------------------|----------|
| DENON Model No. / Modèle numéro | 111 (default / défaut) | 014 |
| | DVD-555 | DVD-2910 |
| DVD-755 | DVD-2930CI | DVD-1600 |
| DVD-900 | DVD-3800 | DVD-2000 |
| DVD-910 | DVD-3910 | DVD-2500 |
| DVD-955 | DVD-3930CI | DVD-3000 |
| DVD-1000 | DVD-5900 | DVD-3300 |
| DVD-1200 | DVD-5910 | |
| DVD-1500 | DVD-9000 | |
| DVD-1710 | DVM-715 | |
| DVD-1910 | DVM-1800 | |
| DVD-1930CI | DVM-1805 | |
| DVD-2200 | DVM-1815 | |
| DVD-2800 | DVM-2815 | |
| DVD-2800II | DVM-4800 | |
| DVD-2900 | | |

* [] : Preset codes set upon shipment from the factory.
 : Les codes pré-régés diffèrent en fonction des livraisons de l'usine.





DENON

www.denon.com

Denon Brand Company, D&M Holdings Inc.
Printed in China 00D 511 4670 004