

d i s h w a s h e r

INSTRUCTION BOOK

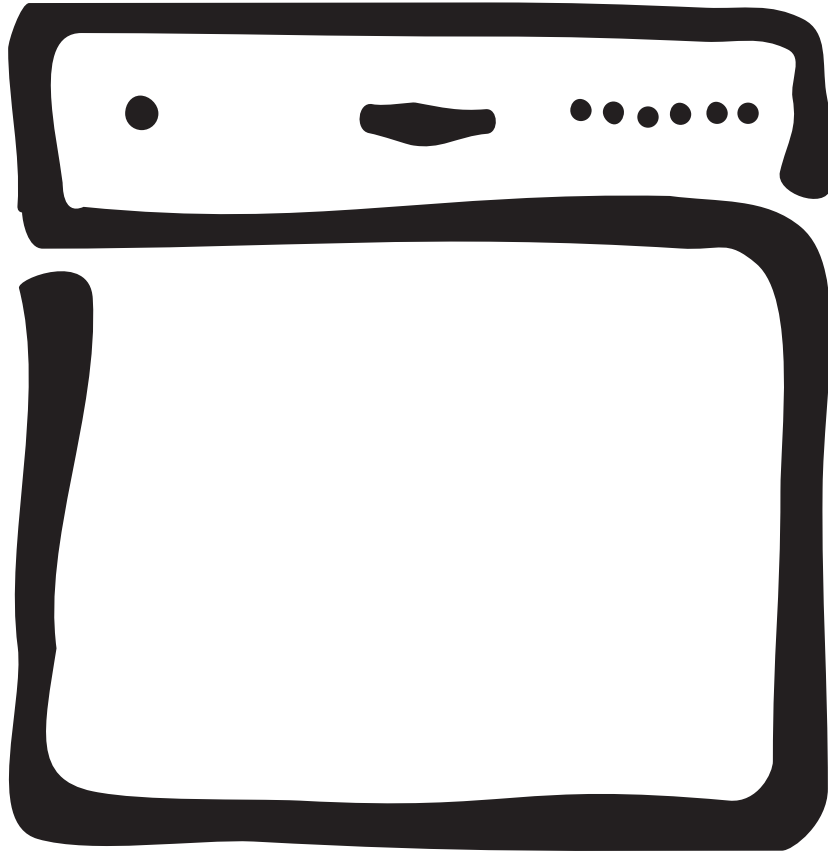

ESF 2440

Contents

For the user

Safety information	3
Description of the appliance	4-5
- Spray arm	
- Coarse filter/microfilter	
- Fine filter	
- Detergent dispenser	
- Rinse aid dispenser	
The control panel	6
- How to set the delayed start	
Programme chart	7
Loading and unloading	8
Using the appliance	9
- Starting the programme	
- Interrupting the programme temporarily	
- Cancelling the programme	
- Pause function	
- Cancelling the drying phase	
- Switching the dishwasher off	
- Cleaning the dishwasher	
In the event of a fault	10-11
Service	12
- Service and spare parts	
Information for test centres	12

For the installer

Technical specifications	13
Unpacking	14
- Damages	
- Use	
- Positioning	
- Protecting the dishwasher against freezing	
Installation	15
- Water inlet	
- Water drainage	
- Electrical connection	

Guide to use the instruction book

The following symbols will be found in the text to guide you throughout the instructions:



Safety information



Step by step instructions



Hints and tips



Environmental information

Safety information

Before installing and first using the dishwasher, read this instruction booklet carefully, including its hints and warnings. To avoid unnecessary mistakes and accidents, it is important to ensure that all people using the dishwasher are thoroughly familiar with its operation and safety features. Save these instructions and make sure they remain with the dishwasher if it is moved or sold, so that everyone using it through its life can be properly informed on appliance use and safety.

Installation and servicing

- All installation and service work done on the product must be carried out by a qualified technician. Work performed by persons with inadequate knowledge may adversely affect the satisfactory functioning of the product and may cause personal injury or damage. Before any work is carried out on the dishwasher, it must be isolated from the electrical supply, by unplugging the power cord or removing the fuse.
- Water connection shall be made via an easily accessible stopcock.
- The power cord must be plugged into an earthed socket, which need to be easily accessible. Permanent installation must only be carried out by an authorised electrician or competent person.
- If the power cord is damaged, it must be replaced by a special cord or assembly available from the manufacturer or its service agent.
- Make sure that the power cord is not nipped or otherwise damaged and that the hoses do not get crushed or kinked when moving the dishwasher in connection with installation or cleaning etc.
- Servicing and possible repairs must be carried out by a service company authorised by the supplier. Use only spare parts supplied by these. Never try to repair the dishwasher yourself.
- Do not place sharp knives with their points upwards. It is much safer to lay them horizontally in the basket.
- Ensure that the door of the dishwasher is always closed when it is not being loaded or unloaded. In this way you will avoid anybody injuring themselves on the open door.
- If you take any dishes out of the dishwasher before the end of the dishwashing cycle, it is extremely important to rinse them thoroughly under running water to remove any remaining detergent.
- The water safety system protects against water damages. The following requirements must be fulfilled:
 - The dishwasher must be electrically connected when it is shut off.
 - The dishwasher must be correctly installed.
 - Always shut off the water supply whenever the dishwasher is left unattended for an extended period.
- In the event of flooding or leakage, shut off the water supply immediately by closing the stopcock and disconnect the power supply by unplugging the power cord or removing the fuse. When removing the electrical plug, grip the plug, not the lead.

Child Safety

- The dishwasher should be used by adults only. Do not let children play with the controls or other parts of it.
- Remember that the plastic bags included in the packaging can be fatal playthings for small children.
- Keep all detergents in safe place out of children's reach.
- Prevent children from sitting, swinging or standing on the open door.

During Use

- This dishwasher is designed solely for washing household utensils suitable for machine washing. Using it for other purposes could lead to physical injury or damage to property and invalidate the guarantee.
- Avoid opening the door while the dishwasher is running, since hot steam may escape.
- Only use detergent specifically designed for use in dishwashers.

Disposal

- packaging:

All materials used in packaging this appliance are environmentally-friendly. The various plastics used are identified and can be recycled:

- PE stands for polyethylene, which is used for the bag around the appliance and the bag in which these instructions were supplied.
- PS stands for polystyrene (moulded), which is used for the sections of packaging needed to cushion the appliance.

The cardboard components of the packaging are made from recyclable paper and should be taken to a collection point for recycling.

- old apparatus:

The symbol  on the product or on its packaging indicates that this product may not be treated as household waste. Instead it shall be handed over to the applicable collection point for the recycling of electrical and electronic equipment. By ensuring this product is disposed of correctly, you will help prevent potential negative consequences for the environment and human health, which could otherwise be caused by inappropriate waste handling of this product. For more detailed information about recycling of this product, please contact your local city office, your household waste disposal service or the shop where you purchased the product.

Description of the appliance

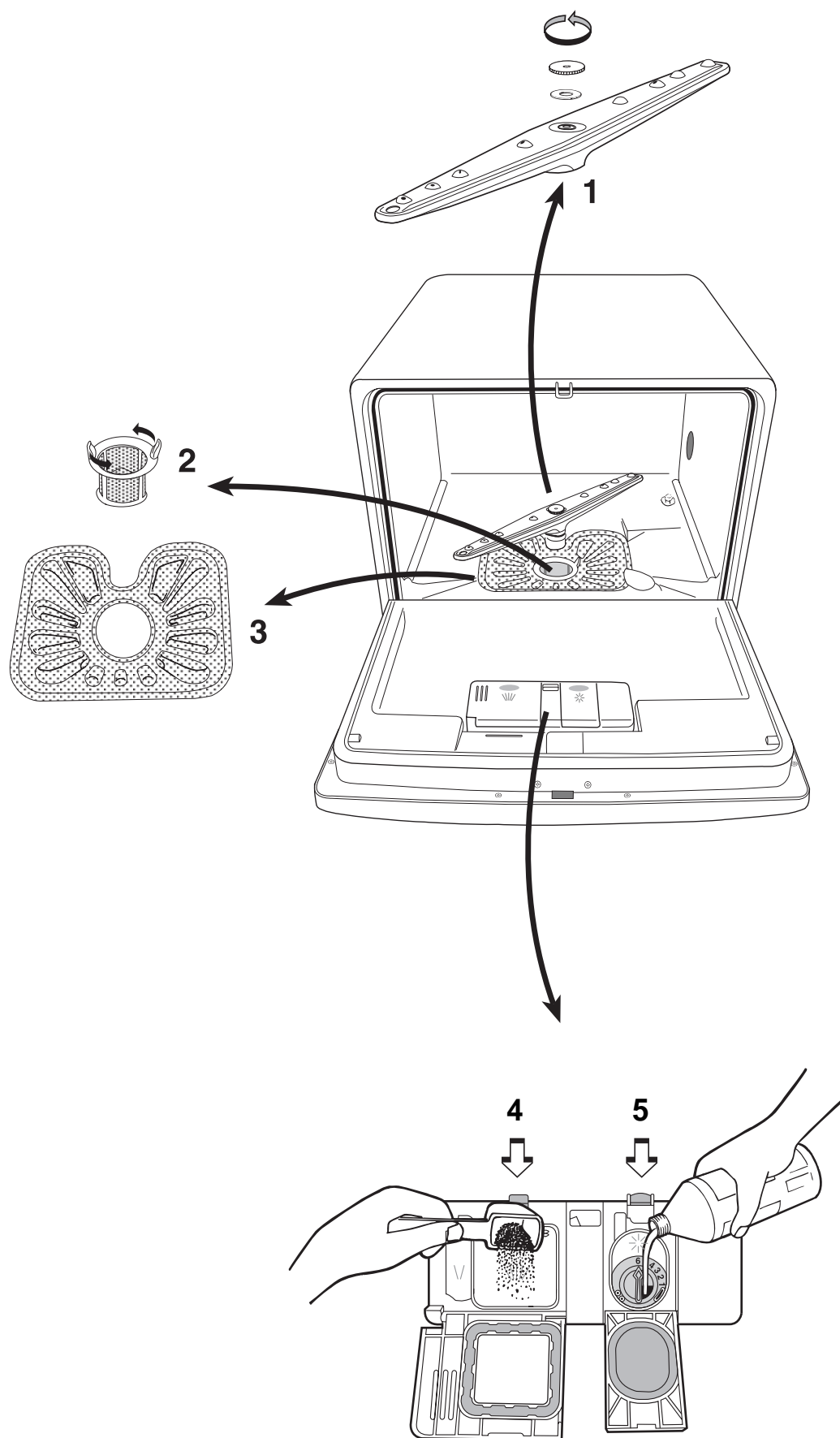

Description of the appliance

Spray arm (1)

It is important to keep all the holes in the spray arm clear. A clogged hole can seriously affect washing efficiency. If the spray arm needs cleaning, unscrew the nut anti-clockwise, remove the washer and lift off the spray arm. Clear the holes and shake out any food remnants.

Coarse filter/microfilter (2)

The purpose of the coarse filter is to catch large objects such as toothpicks and pieces of eggshell. Make sure that the filter is always clean. Turn the coarse filter anti-clockwise. Lift it out and rinse it under running water whenever necessary.

Fine filter (3)

It is just as important to keep this filter clean. A dirty or clogged filter will always impair washing efficiency. The fine filter can easily be lifted out for cleaning when you have removed the coarse filter.

Detergent dispenser (4)

Open the lid to the dispenser by pressing the lid catch towards the compartment. Consult the instructions on the detergent packet, fill the compartment accordingly and close the lid. Remember that the instructions usually refer to full-size dishwashers, for example when using detergent tablets, it is sufficient to use just half a tablet. Pre-wash detergent is poured into the smaller compartment to the left when needed. This detergent is active already at pre-rinsing. Make sure that there is no items that prevents the lid from opening.



Only use detergents specially designed for dishwashers.



Avoid frequent use of liquid detergents, as the long term effects of such detergents create a potential risk of increasing pump noise.

Rinse aid dispenser (5)

Use of rinse aid will result in cleaner and faster drying of the load, since it helps water and soil to run off. Too much rinse aid may result in streakiness, too little may cause white spots. The dispenser holds about 150 ml. This is enough for approx. 60 wash cycles, depending on the dosage setting. Adjust the dosage setting according to the hardness of the water.



You can set the dosage between 1 - 6, equivalent to 1 - 6 ml rinse aid. Factory setting is 1. Begin at the lowest dosage setting and increase if necessary by turning the setting arrow with e.g. the handle of a spoon.

The indicator light  on the control panel is lit when the dispenser requires refilling.



1. Open the lid to the dispenser by pressing the lid catch towards the compartment and lift the lid.
2. Fill up with rinse aid; do not overfill.
3. Wipe off any spillage carefully to prevent excessive foaming during the next wash programme.
4. Close the lid and press until it locks again.



Do not fill the rinse aid dispenser with liquid detergent.

The control panel

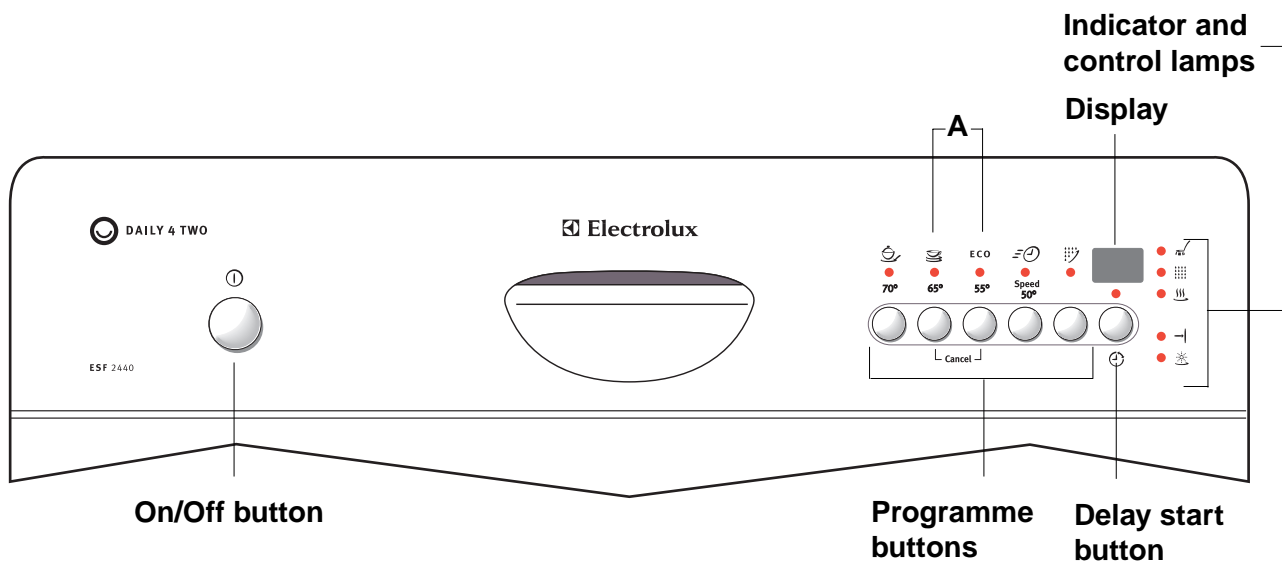



Combination buttons "A":

In addition to selecting a programme, you can by pressing these two buttons cancel a programme in progress.

Indicator lamps:

Shows current phase of the selected programme.

- Wash cycle in progress  top lamp
- Rinse in progress  middle lamp
- Drying in progress  lowest lamp

Control lamps:

Shows that • Programme cycle ended 

- Refilling of the rinse aid dispenser is necessary 

The display can show:

- Which start time is set.
- Remaining time of a programme in progress.
- An error code.

How to set the delayed start

The programme start can be delayed between 1 and 19 hours.

1. Press in the On/Off button.
2. Press the delay start button repeatedly, until the required delay shows on the display. Indicator lamp for the delay start button is lit.
3. Press the button for the required programme.
4. The remaining time to the start is shown in the display. After the set delayed start time has elapsed, the programme starts.





Changing the delayed start:

If the programme has not started, you are still able to change the set time with the delay start button.

Cancelling the delayed start:

If the programme has not started, the delayed start can be cancelled. Press the delay start button repeatedly, until the running time of the selected programme appears on the display. The required programme starts immediately.

Programme chart

Type of dishes	Plates and cooking pots	All types of dishes		Coffee cups, delicate items	All types of dishes
Type of soil:	<ul style="list-style-type: none"> heavily soiled dried-on food remnants especially egg-white and starch 	<ul style="list-style-type: none"> normally soiled dried-on food remnants 	<ul style="list-style-type: none"> normally soiled 	<ul style="list-style-type: none"> lightly soiled 	<ul style="list-style-type: none"> 4)
Suitable programme:	↓	↓	↓	↓	↓
	 INTENSIVE 70° C	 NORMAL 65° C	ECO ENERGY SAVE 55° C ³⁾	 SPEED 50° C	 PRERINSE cold
Programme cycle: ¹⁾	Pre-wash Washing 2 x rinses Final rinse Drying	Pre-wash Washing Rinse Final rinse Drying	Pre-wash Washing Rinse Final rinse Drying	- Washing Rinse Final rinse -	Prerinse - - - -
Consumption figures: ²⁾	↓	↓	↓	↓	↓
Washing time with drying:	107 minutes	84 minutes	159 minutes	36 minutes	7 minutes
Drying time:	13 minutes	13 minutes	54 minutes	—	—
Energy:	1,15 kWh	0,80 kWh	0,63 kWh	0,40 kWh	0,01 kWh
Water:	9 litres	7 litres	7 litres	6 litres	2 litres

1) Different parts of the wash programme may not sound the same, because the wash action is more intensive at some stages.

2) Consumption figures have been calculated for nominal conditions. The figures can vary depending on inlet water temperature and how full the main and cutlery basket are.

3) Consumption figures and performance is according to the Energy Save programme cycle.

4) Prerinse is used if you want to wait until you have a full load. This cycle rinses the load and keeps it moist, making the main wash easier later on. No detergent should be used.

 All programmes begin with a drain.

 **Dishwashing detergent in tablet form is not suitable for use in the Speed programme cycle because some tablets cannot develop their full cleaning power during short programmes.**

Loading and unloading the dishwasher

How to load the dishes

The illustration shows the dishwasher loaded with six place settings. Your own dishes are not likely to be identical to this load, but if you follow the advice below we are sure you will be pleased with the results.

- Always place glasses, cups and bowls upside down.
- Incline deep dishes (soup plates etc.) so that the water can run off when drying.
- Make sure that the dishes do not rest against each other. This is particularly important in regard to the cutlery basket - nested spoons, etc. simply cannot be properly washed. The water must reach all the soiled surfaces.
- Make sure that cutlery with slender handles and other items do not protrude through the openings in the basket and prevent the spray arm from rotating.
- Never put silver and stainless steel objects together. When these metals come into contact with each other a chemical reaction occurs which stains the silver.
- China with a pattern applied on top of the glaze may not be suitable for machine washing as the colours may fade and lose their lustre. The same applies to cutlery with wooden or plastic handles.

i Make sure you always buy articles that are dishwasher proof.

- Silver and aluminum items tend to be discolour when washed. Food remnants from egg and mustard often causes discolourations and stains on silver. Make sure to rinse off and remove food remnants on silver if it is not washed immediately after it has been used.
- Not all plastic articles are machine washable. If you are in doubt as to whether your plasticware can be machine washed, we suggest you check by washing a single item or else wash them by hand.
- When washing delicate items, select the programme with the lower wash temperature.
- Substances such as ketchup containing strong colouring agents can cause temporary discolouration to the interior of the dishwasher.

! Do not place sharp knives with their points upwards. It is much safer to lay them horizontally in the main basket.

Unloading

Hot dishes are sensitive to knocks. Always let the dishes cool down before unloading.

i The dishes dry faster if the door for a short moment is opened completely when the dish-programme is finished and then left ajar.

! Be careful when opening the door, since hot steam may escape.

Baskets

Main basket

Cutlery basket

i The cup shelves can be placed in two different levels.

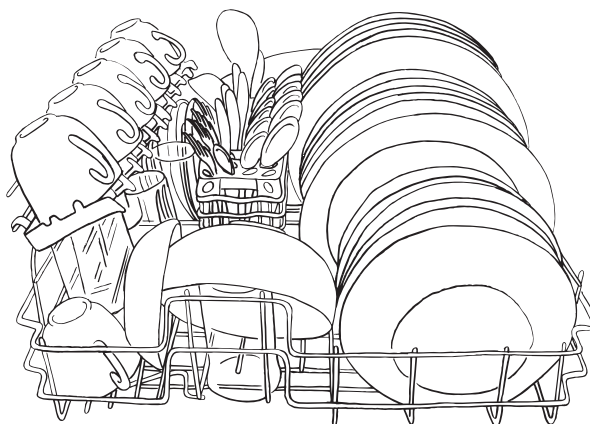

Using the appliance

Starting the programme

-  1. Scrape or rinse off solid food remnants.
2. Load the dishwasher.
(See the basket and loading).
3. Put the correct amount of detergent into the detergent dispenser and close the lid.
4. Close the door.
5. Press in the On/Off button. All programme indicator lamps are lit.
6. Press in the required programme button (see programme chart). All other programme indicator lamps go out. The lamp always indicates which part of the selected cycle the dishwasher is in.
7. Check the filters to see if they need to be cleaned when the dishwasher has finished the programme.

Interrupting the programme temporarily

-  1. Open the door. The programme stops.
2. The programme indicator lamp is lit.
3. Close the door and the programme continues after about six seconds.



Open the door carefully when the dishwasher is running, since hot steam may escape.

Cancelling the programme

-  1. Press and hold in the combination buttons, the machine goes to starting position and all programme indicator lamps are lit.
2. Release the buttons. The programme is now cancelled and a new programme can be selected.



If you switch the dishwasher off with the On/Off button, the selected programme is not finished, it is only disrupted. When you start the dishwasher again, the programme will continue.

Pause function

With the pause function the programme can be interrupted for a short period of time.

-  1. Press in the On/Off button. The programme stops.
2. All lamps goes out.
3. When you want the programme to continue again, you press the On/Off button. The programme continues.



The programme should not be paused for any longer then necessary, because the water inside the dishwasher has cooled down and must be heated again which increases the power consumption.

Cancelling the drying phase

In case you do not want to wait until the drying phase is completed, you can cancel it.

-  1. Press in the On/Off button.
2. Open the door. The drying phase is cancelled.

Switching the dishwasher off

Switch the dishwasher off, when the indicator lamp  for the programme cycle end is lit or the display shows 0.

-  1. Press in the On/Off button.
2. Leave the door slightly ajar.



Be careful if you open the door immediately after the programme is finished, since hot steam may escape.



This dishwasher is equipped with the new flush system called "IMPULSE WASHING". This washing system varies both the revolutions of the pump and the water pressure for more intensive cleaning of the dishes during a programme. That is why different sections of the programme cycle do not sound the same.

Cleaning the dishwasher

Clean the outside surfaces of the appliance using a mild (non-abrasive) household cleaning product. Finish by removing remaining traces of the product with a damp cloth.



Do not use cleaning products which contain alcohol (spirits), thinners and similar substances.

In the event of a fault

Before calling out an engineer, please check through the details below because some faults can be rectified easily without the need to call out an engineer. If an engineer is called to resolve a problem listed below or to repair a fault caused by incorrect installation or mis-use a charge will be made, even if the appliance is under guarantee.

Fault	Check
The programme will not start.	<ul style="list-style-type: none"> • Is the door closed properly? • Have you pressed the On/Off button? • Is the water tap turned on? • Is the dishwasher plugged in? • Has the fuse blown? • Is the delayed start-button pressed in? • Is the previous programme finished? (See "Using the appliance").
The dishwasher is not filling with water.	<ul style="list-style-type: none"> • Is the water tap turned on? • Has your domestic water supply been cut off temporarily? • Is the water inlet hose kinked or squashed? • Is the filter inside the inlet hose blocked? • Is the water pressure too low?
Water not discharged at end of cycle.	<ul style="list-style-type: none"> • Did you open the door before the indicator light → was lit and the programme cycle finished? • Is the previous programme finished? (See "Using the appliance"). • Are the filters clogged?
Dishes not washed satisfactorily.	<ul style="list-style-type: none"> • Has anything prevented the spray arm from rotating? • Are the spray arm holes clogged? • Were the dishes packed too close together? • Are the filters clogged? • Are the filters fitted correctly in place? • Did you use enough detergent? • Did you select a programme with too low temperature? • Is the rinse aid dispenser empty?
Visible lime deposits or white film on the dishes.	<ul style="list-style-type: none"> • Is the rinse aid dispenser adjusted to too low dosage?
The dishwasher is noisy.	<ul style="list-style-type: none"> • Are the dishes rattling against each other? • Is the spray arm knocking against the dishes?
Whistling sound when washing.	<ul style="list-style-type: none"> • This is not a fault, try another brand of detergent.
The dishes are not quite dry and are not shiny.	<ul style="list-style-type: none"> • Is the rinse aid dispenser empty or adjusted to too low dosage? • Have the dishes been left too long inside the dishwasher?
The door is difficult to close.	<ul style="list-style-type: none"> • Is the dishwasher level?

In the event of a fault

With help of the error code on the display, it's possible that you can solve the problem yourself. When the problem is solved, press in the button for the disrupted programme and the programme continues.

For other error codes on the display (, followed by a numbers):

- Interrupt the dishwashing cycle.
- Switch the dishwasher off.
- Select the relevant programme again.

If the problem occurs again, contact your local service centre, stating the error code.

Fault	Check
Indicator for the selected programme flashes: The display shows error code , 10. (Problems with the water supply).	<ul style="list-style-type: none">• Is the water tap turned on?• Is the filter inside the inlet hose blocked?• Is the water inlet hose kinked or squashed?• Are the filters clogged?
Indicator for the selected programme flashes: The display shows error code , 20. (Problems with water drainage).	<ul style="list-style-type: none">• Is the spigot blocked?• Is the water drain hose kinked or squashed?• Are the filters clogged?

- CE** This appliance complies with the following E.E.C. directives:
- 73/23/EEC, dated 19.02.1973 – low-voltage directive.
 - 89/336/EEC, dated 03.05.1989 (incl. amendment
 - 92/31/EEC) – directive on electromagnetic compatibility.

Service

Service and spare parts

Servicing and repairs must be carried out by a service company authorised by the supplier. Use only spare parts supplied by these.

Before calling service, use the trouble shooting table "In the event of a fault" to try to attend to the fault yourself. Note that electrical faults shall always be rectified by a certified electrician.

State the appliance's model designation, product- and serial numbers according to the data plate affixed to the rear of the dishwasher.

You can record these details here:

TYPE.
MOD.
PROD.NO.
SER.NO.
Purchase date.....

Under what circumstances does the fault occur?

 **Never attempt to repair the dishwasher yourself. Repairs carried out by unauthorised or inexperienced persons can cause injury or serious malfunctioning.**

Information for test centres

The salt container and rinse aid dispenser shall be filled in accordance with this instruction manual. Before conducting the measurements the dishwasher shall be operated for one or two complete cycles using detergent and a clean load.

Test standard:	EN 50242 and EN 60704
Rated capacity:	6 place settings accordance EN 50242
Loading of basket:	see chapter "Loading the dishes"
Test program:	energy saving 55° C
Detergent (IEC type B):	9 gram in the dispenser + 5 gram in the pre-wash dispenser
Rinse aid (type III):	setting 3
Feed water pressure:	minimum 0,8 bar, maximum 10 bar
Waste water outlet:	install according to figure below

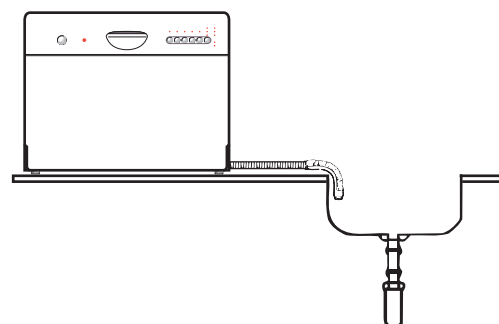

Installation instructions

 Any electrical work required to install this appliance, should be carried out by a qualified electrician or competent person.

 Any plumbing work required to install this appliance, should be carried out by a qualified plumber or competent person.

Technical specifications

Capacity:	6 place settings accordance EN 50242	
Dimensions:	Height	447 mm
	Width	546 mm
	Depth (to the edge of the door)	480 mm
	Depth (to the middle of the door)	507 mm
Weight:	Net	22 kg
Water pressures:	Minimum	80 kPa (0,8 bar)
	Maximum	1000 kPa (10 bar)
Water temperature:	Maximum	65° C
Electrical data:	Power supply	230 V - 50 Hz
	Fuse	10 A
	Heating element	1100 W
	Power rating	1180 W

Unpacking

Damages

If the dishwasher has been damaged during transport, you should immediately notify the company responsible for delivering it.

Check that the dishwasher is undamaged. If you discover any damage, faults or that anything is missing, you should notify the dealer immediately.



Never leave packaging material in a place where children may play with it.

Check that the following accessories are supplied with the dishwasher when you unpack it:

- Elbow for discharge hose

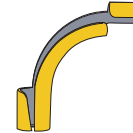

Use

This dishwasher is designed solely for washing household utensils suitable for washing in a dishwasher. Using it for other purposes may damage it and invalidate the guarantee.

Positioning

The dishwasher is intended to be installed on a kitchen drainer, worktop or built-in. To function properly, make sure that the appliance is level. Its height can be adjusted with the adjustable feet (5 mm each). See the illustration for built-in measurements.

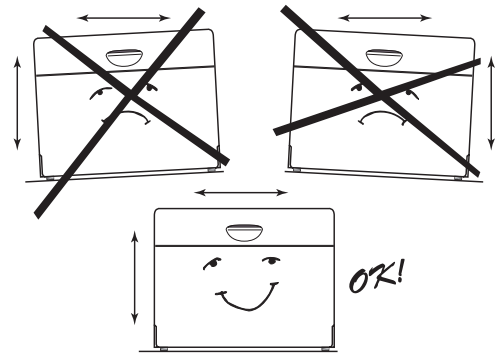

Protecting the dishwasher against freezing



If the dishwasher is placed in an environment where the temperature sometimes fall below 0° C, there is a risk that the small amount of water which remains inside the parts of the dishwasher will freeze and damage it.

To prevent this you should:



1. Turn off the water supply to the dishwasher.
2. Remove the water inlet and discharge hoses.



The appliance is only to be used and stored indoors at normal room temperature. The manufacture is not responsible for any frost damage.

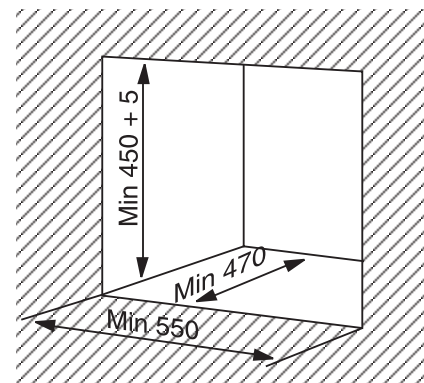

Installation

Water inlet

i The dishwasher is equipped with safety features which are to prevent the water from going back to the fresh water system. These features are according to current water technical safety regulations.

The temperature of the water supply should not exceed 65° C and the pressure should be between 80-1000 kPa (0,8 - 10 bar). It is important to have a tap or stopcock, positioned close to the dishwasher and with easy access. Special mixer taps with dishwasher connections are available, as well as adaptors for older mixer taps. Connect the inlet hose to a tap with a 3/4" pipe thread. If necessary, use the restrictor (1/2") supplied.

The inlet hose must not be joined onto any form of extension hose. If it is too short, the entire hose must be replaced with a longer high-pressure hose, specially designed for the purpose. The end of the hose, which is connected to the dishwasher can be turned in any direction. Loosen the retaining nut, turn the hose, then retighten the nut.

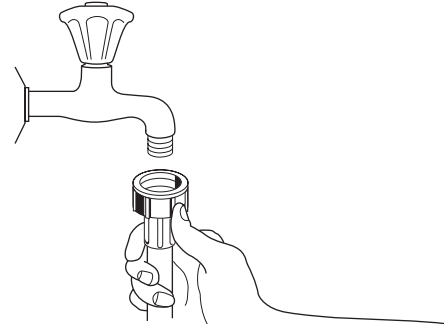

! Check that the nut and all other connections are tight before the machine is moved into position.

! Use only the inlet hose supplied to the dishwasher, do not reuse the old inlet hose.

Water drainage

i To protect the dishwasher against water damage it is equipped with a water safety system. In the event of a fault the drain-pump starts automatically and the remaining water inside the dishwasher is pumped out.

! The water safety system also works when the dishwasher is switched off. However the dishwasher must be connected electrically.

Place the discharge hose over the sink as illustrated. It must not at any point be higher up than 75 cm over the surface which the dishwasher is standing on. If it runs higher, operation of the dishwasher might be impaired.

It is also important to ensure that the inside diameter of the hose is not less than 13 mm at any point. If the discharge hose is too long, it can easily be cut to the right length.

- ✎** 1. Cut the hose to a suitable length, using a sharp knife.
2. Fit the elbow supplied onto the end of the hose.

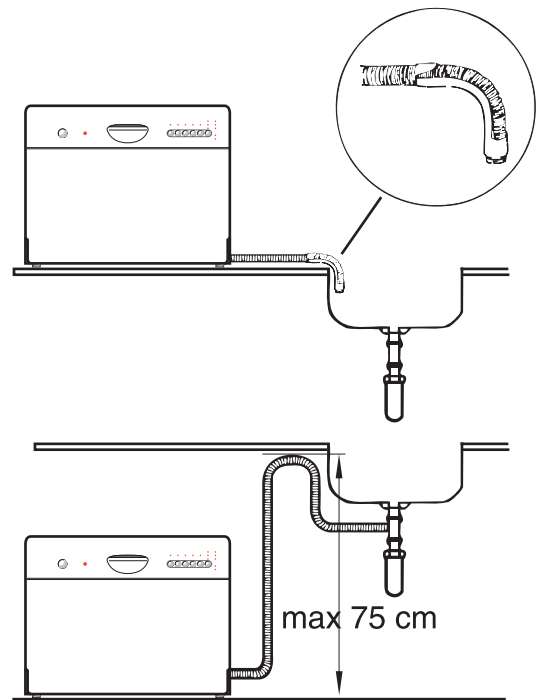

Electrical connection

The dishwasher is supplied with a lead and electrical plug for connection to a 230 V earthed wall socket, which should be easily accessible and protected by a 10 A fuse.

! Before any work is carried out on the dishwasher, it must be isolated from the electric mains supply, for example by removing the plug from the wall socket.

! Permanent electrical installation must be carried out by an authorised electrician or competent person.

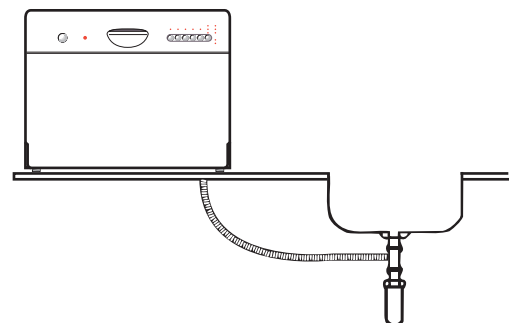

Electrolux

 **The Electrolux Group.** *The world's No.1 choice.*

The Electrolux Group is the world's largest producer of powered appliances for kitchen, cleaning and outdoor use. More than 55 million Electrolux Group products (such as refrigerators, cookers, washing machines, vacuum cleaners, chain saws and lawn mowers) are sold each year to a value of approx. USD 14 billion in more than 150 countries around the world.



Technical changes possible

AGB 05-07