

EMM23M38GB

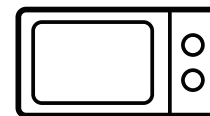

Freestanding microwave

Installation & User manual

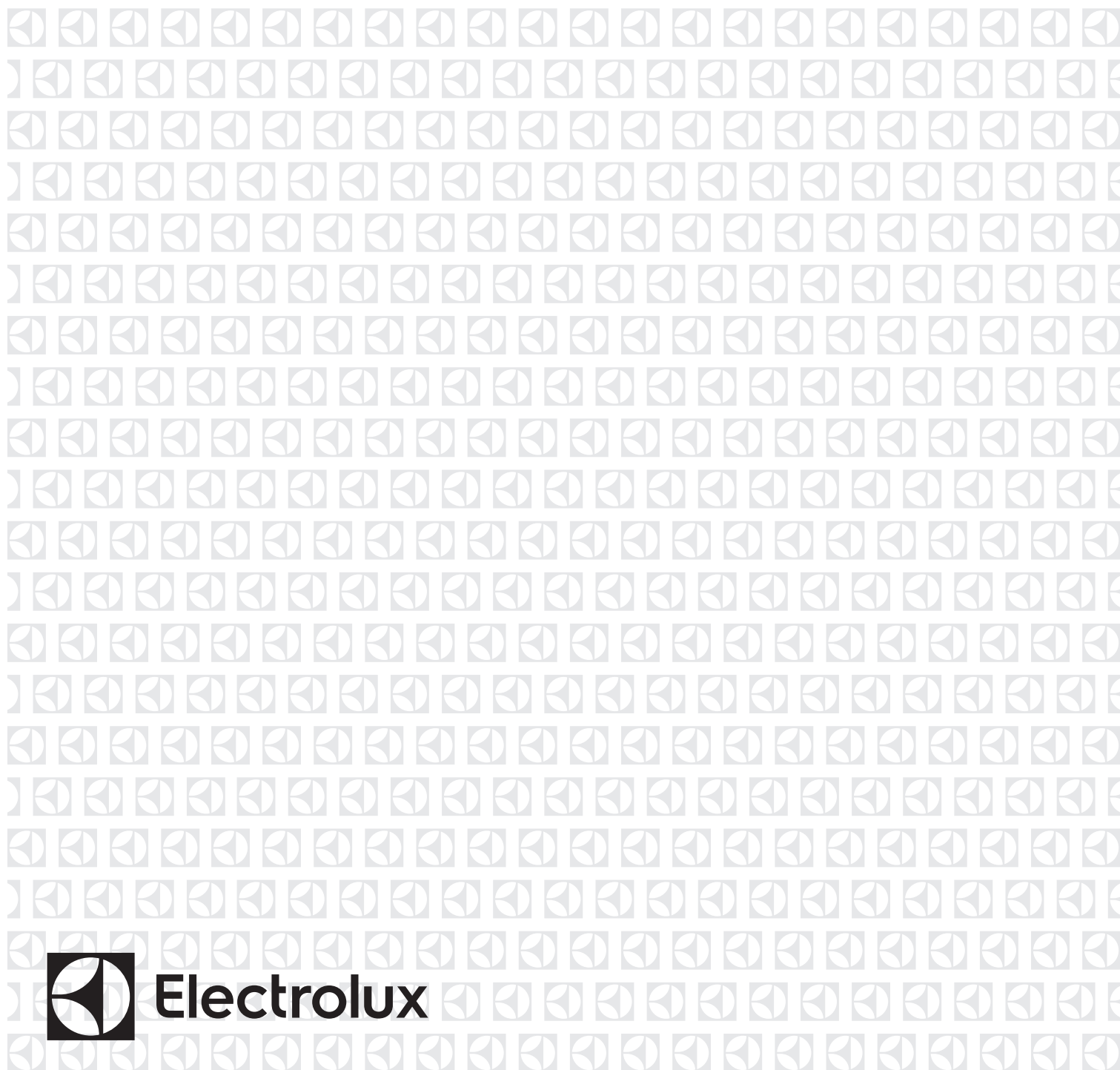

WE'RE THINKING OF YOU

Thank you for purchasing an Electrolux appliance. You've chosen a product that brings with it decades of professional experience and innovation. Ingenious and stylish, it has been designed with you in mind. So whenever you use it, you can be safe in the knowledge that you'll get great results every time. Welcome to Electrolux.

BEFORE USING YOUR APPLIANCE

Check for any damage or marks. If you find the appliance damaged or marked you must report it within 7 days to claim for damages under the manufacturers warranty. This does not affect your statutory rights.

Before you use the appliance, we recommend that you read through the whole user manual which provides the description of the product and its functions. It is important that the product is installed correctly and that you read the safety instructions carefully to avoid misuse and hazards.

For future reference, please store this booklet in a safe place.

CONDITIONS OF USE

This appliance is intended to be used in household and similar applications such as:

- Staff kitchen areas in shops, offices and other working environments.
- Farm houses.
- By clients in hotels, motels and other residential type environments.
- Bed and breakfast type environments.

BEFORE YOU CALL

Please ensure you read the instruction manual fully before you call for service, or a full service fee could be applicable.

RECORD MODEL AND SERIAL NUMBER HERE:

Model: _____

Serial No: _____

IMPORTANT INFORMATION THAT MAY IMPACT YOUR MANUFACTURER'S WARRANTY

Adherence to the directions for use in this manual is extremely important for health and safety. Failure to strictly adhere to the requirements in this manual may result in personal injury, property damage and affect your ability to make a claim under the Electrolux manufacturer's warranty provided with your product. Products must be used, installed and operated in accordance with this manual. You may not be able to claim on the Electrolux manufacturer's warranty in the event that your product fault is due to failure to adhere this manual.

CONTENTS

- General warnings.....3
- Safety instructions4
- Product description5
- Accessories.....5
- Control panel.....5
- Daily use.....7
- Automatic programmes 8
- Using the accessories..... 9
- Additional functions 9
- Helpful hints and tips10
- Care and cleaning.....11
- Troubleshooting11
- Installation12
- Electrical Installation13
- Customer care center14

SYMBOLS



WARNING!

This symbol indicates information concerning your personal safety.



CAUTION!

This symbol indicates information on how to avoid damaging the appliance.



IMPORTANT!

This symbol indicates tips and information about use of the appliance.



ENVIRONMENT!

This symbol indicates tips and information about economical and ecological use of the appliance.

INFORMATION ON DISPOSAL FOR USERS



ENVIRONMENT!

- Most of the packaging materials are recyclable. Please dispose of these materials through your local recycling depot or by placing them in appropriate collection containers.
- If you wish to discard this product, please contact your local authorities and ask for the correct method of disposal.

GENERAL WARNINGS

Important safety instructions, read carefully and keep for future reference. Pass the user manual on to possible new owners of the appliance.

NOTE! You must read these warnings carefully before installing or using the appliance. If you need assistance, contact your Customer Care Department. The manufacturer will not accept liability, should these instructions or any other safety instructions incorporated in this book be ignored.

Children and vulnerable people safety.

WARNING!

Risk of suffocation, injury or permanent disability.

- This appliance is not intended for use by persons (including children) with reduced physical, sensory or mental capabilities, or lack of experience and knowledge, unless they have been given supervision or instruction concerning use of the appliance by a person responsible for their safety.
- Children should be supervised to ensure that they do not play with the appliance.
- Keep all packaging away from children.
- If the appliance has a child safety device, we recommend that you activate it if children are present.
- **WARNING:** Accessible parts may become hot during use. Young children should be kept away.

CAUTION!

Important safety instructions, read carefully and keep for future reference.

General safety

- Internally the appliance becomes hot when in operation. Do not touch the heating elements that are in the appliance. Always use oven gloves to remove or put in accessories or ovenware.
- Do not use a steam cleaner to clean the appliance.
- Before maintenance isolate the power supply.
- If the door or door seals are damaged, the appliance must not be operated until it has been repaired by a competent person.
- The appliance is not intended to be operated by means of an external timer or separate remote-control system.
- Only a competent person can carry out any service or repair operation that involves the removal of a cover which gives protection against exposure to microwave energy.
- Do not heat liquids and other foods in sealed containers. They are liable to explode.
- Only use utensils that are suitable for use in microwave ovens.

- When heating food in plastic or paper containers, keep an eye on the appliance due to the possibility of ignition.
- The appliance is intended for heating food and beverages. Drying of food or clothing and heating of warming pads, slippers, sponges, damp cloth and similar may lead to risk of injury, ignition or fire.
- If smoke is emitted, switch off or unplug the appliance and keep the door closed in order to stifle any flames.
- Microwave heating of beverages can result in delayed eruptive boiling. Care must be taken when handling the container.
- The contents of feeding bottles and baby food jars should be stirred or shaken and the temperature checked before consumption, in order to avoid burns.
- Eggs in their shell and whole hard-boiled eggs should not be heated in the appliance since they may explode, even after microwave heating has ended.
- The appliance should be cleaned regularly and any food deposits removed.
- Failure to maintain the appliance in a clean condition could lead to deterioration of the surface that could adversely affect the life of the appliance and possibly result in a hazardous situation.
- The temperature of accessible surfaces may be high when the appliance is operating.
- This appliance is designed for freestanding application. It must not be installed behind a decorative door or installed in an enclosed cupboard. Please follow the installation requirements in this manual.
- Do not use harsh abrasive cleaners or sharp metal scrapers to clean the glass door since they can scratch the surface, which may result in shattering of the glass.
- If the supply cord is damaged, it must be replaced by the manufacturer or an authorised service agent or similarly qualified persons in order to avoid a hazard.

CAUTION!

In order to avoid a hazard due to inadvertent resetting of the thermal cut-out, this appliance must not be supplied through an external switching device, such as a timer, or connected to a circuit that is regularly switched on and off by the utility.

WARNING!

Ensure that the appliance is switched off before replacing the lamp to avoid the possibility of electric shock.

SAFETY INSTRUCTIONS

Installation

WARNING!

Only a qualified person must install this appliance.

- Remove all the packaging.
- Do not install or use a damaged appliance.
- Obey the installation instructions supplied with the appliance.
- Always be careful when you move the appliance because it is heavy. Always wear safety gloves.
- Keep the minimum distance from the other appliances and units.

Electrical connection

WARNING!

Risk of fire and electrical shock.

- This appliance is supplied with a power cord and 10A power plug suitable for connection to standard 10A power socket. If a power socket needs to be installed, it must be done by a suitably qualified electrician.
- The appliance must be earthed.
- Make sure that the electrical information on the rating plate agrees with the power supply. If not, contact an electrician.
- Connect the mains plug to the mains socket only at the end of the installation. Make sure that there is access to the mains plug after the installation.
- Make sure not to cause damage to the mains plug and to the mains cable. Contact the Service Centre or an electrician to change a damaged mains cable.
- Do not pull the mains cable to disconnect the appliance. Always pull the mains plug.

Use

WARNING!

Risk of injury, burns or electric shock or explosion.

- Use this appliance in a household environment.
- Do not change the specification of this appliance.
- Make sure that the ventilation openings are not blocked.
- Do not leave the appliance unattended during operation.
- Do not apply pressure on the open door.
- Do not use the appliance as a work surface and do not use the cavity for storage purposes.
- Do not operate appliance without food.
- Metallic containers for food and beverages are not allowed during microwave cooking.

Care and cleaning

WARNING!

Risk of injury, fire or damage to the appliance.

- Before maintenance, deactivate the appliance and disconnect the mains plug from the mains socket.
- Regularly clean the appliance to prevent the deterioration of the surface material.
- Do not allow food spills or cleaner residue to accumulate on door sealing surfaces.
- Remaining fat or food in the appliance can cause smoke/fire, particularly on the grill element.
- Clean the appliance with a moist soft cloth. Only use neutral detergents. Do not use abrasive products, abrasive cleaning pads, solvents or metal objects.
- Do not use a steam cleaner to clean this appliance.

Disposal

WARNING!

Risk of injury or suffocation.

- Disconnect the appliance from the mains supply.
- Cut off the mains cable and discard it.

PRODUCT DESCRIPTION

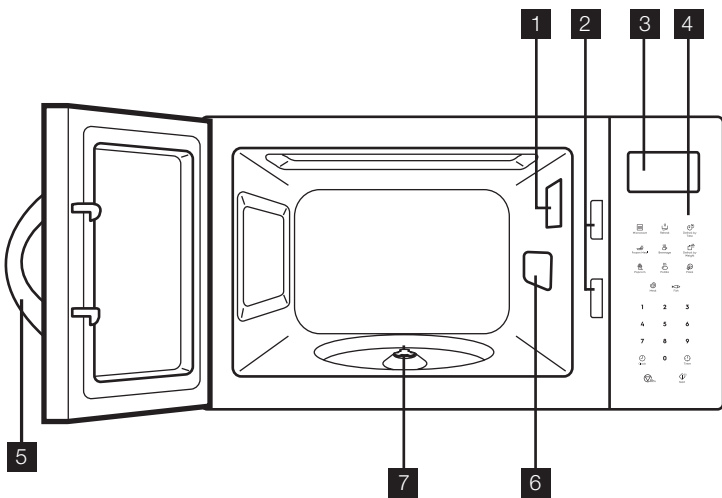

- 1** Lamp
- 2** Safety Interlock system
- 3** Display
- 4** Control panel
- 5** Door opener
- 6** Brown mica sheet
- 7** Turntable shaft

CONTROL PANEL

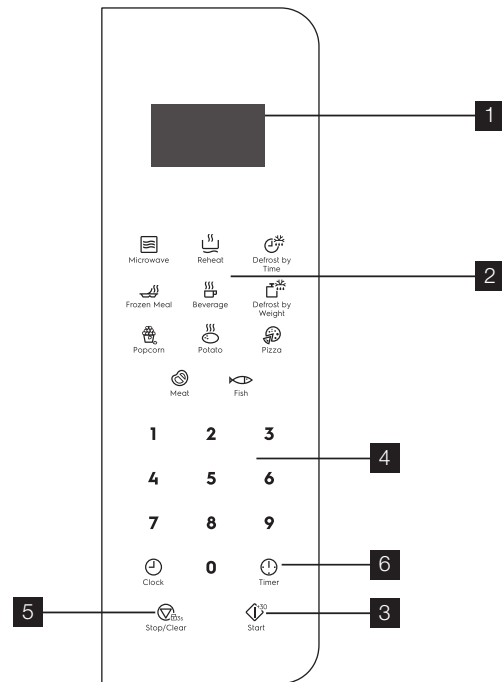

ACCESSORIES

Turntable set

Glass cooking tray and roller guide.

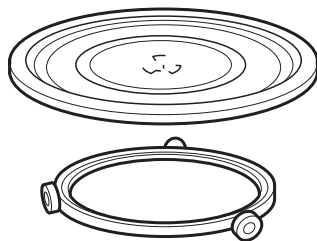

Always use the turntable set to prepare food in the appliance.

Control panel

	Symbol	Function	Description
1	—	Display	Shows the settings and current time.
2		Function pads	To set the microwave / reheat / defrost by weight and time/Frozen meal/ beverage/popcorn/ potato/pizza/meat/fish
3		Start / +30 sec	To start the appliance or increase the cooking time for 30 seconds at full power.
4	0-9	Setting pads	To set the time, weight
5		Cancel	To deactivate the appliance or delete the cooking settings.
6		Timer	Reminder
7		Clock	To set the clock

DAILY USE

Suitable cookware and materials

Cookware / Material	Microwave			Grilling/ Convection
	Defrosting	Heating	Cooking	
Ovenproof glass and porcelain (with no metal components, e.g. Pyrex, heat-proof glass)	■	■	■	■
Non-ovenproof glass and porcelain ¹⁾	■	--	--	--
Glass and glass ceramic made of ovenproof / frost-proof material (e.g. Arcoflam), grill shelf	■	■	■	■
Ceramic ²⁾ , earthenware ²⁾	■	■	■	--
Heat-resistant plastic up to 200°C ³⁾	■	■	■	--
Cardboard, paper	■	--	--	--
Clingfilm	■	--	--	--
Roasting film with microwave safe closure ³⁾	■	■	■	--
Roasting dishes made of metal, e.g. enamel, cast iron	--	--	--	■
Baking tins, black lacquer or silicon coated ³⁾	--	--	--	■
Baking tray	--	--	--	■
Browning cookware, e.g. Crisp pan or Crunch plate	--	■	■	--
Ready meals in packaging ³⁾	■	■	■	■

1) With no silver, gold, platinum or metal plating / decorations.

2) Without quartz or metal components, or glazes which contain metals.

3) You must follow the manufacturer's instructions about the maximum temperatures.

■ suitable

-- not suitable

DAILY USE (CONTINUED)

Power setting table



Press 	Display Icon	Power setting	Approximate percentage of power
1 time	HI	800 Watt	100%
2 times	M-HI	700 Watt	80%
3 times	MED	500 Watt	60%
4 times	M-LO	300 Watt	40%
5 times	M-LO	100 Watt	20%





Quick Start

- Press  to activate the appliance for 30 seconds at full function power. The cooking time increases by 30 seconds with each additional press of the button. The maximum cooking time is 60 minutes.

Defrosting

Weight and time defrosting

- Repeatedly press  to set the desired defrosting function (either weight or time).
- Press the Setting pads to input the desired weight or time.
- Press  to confirm and start the appliance.
- For weight defrosting the display shows the set defrosting time.

Function	Control panel	Display Icon	Procedure
Defrost by time	 Defrost by Time		1. Connect to power
			2. In the standby status, press Defrost by time to choose
			3. Press numeric key to set time
			4. Press Start pad to start
Defrost by weight	 Defrost by Weight		1. Connect to power
			2. In the standby status, press Defrost by weight to choose.
			3. Press numeric key to set weight
			4. Press Start pad to start and LED will count down to show running time
			5. When the program runs to reverse, you will hear "bibi" twice, reminding you to turn over the food, opening the oven door to turn the food over and closing the oven door. Press the "Start" pad to continue thawing until the timer is 0.

AUTOMATIC PROGRAMMES











WARNING!

















Refer to the safety chapters.

Auto Cooking

You can use Auto Cooking function to easily cook food.

1. Repeatedly press function pad to set the desired menu.
2. Press numeric pad to input the weight.
3. To change the set menu for a different one press function pad.
4. Press  to confirm and start the appliance.

Type	Usage
 Reheat	There are 5 choices. (0.2kg,0.4kg,0.6kg,0.8kg,1kg)
 Frozen Meal	There are 2 choices. (1piece, 2 pieces)
 Beverage	There are 3 choices.(1.2.3 cups, each cup is about 250 ml)
 Popcorn	There are 1 choice.(0.1kg)
 Potato	There are 2 choices.(0.45kg.0.65kg)
 Pizza	There are 2 choices.(1.2 pieces, each piece is about 150g)
 Meat	There are 5 choices. (0.1kg.0.2kg.0.3kg.0.4kg.0.5kg)
 Fish	There are 5 choices. (0.1kg.0.2kg.0.3kg.0.4kg.0.5kg)

Function	Control Panel	Display Icon	Procedure
Reheat	 Reheat		<p>Example</p> <ol style="list-style-type: none"> 1.Connect to power and turn on. 2.Press Reheat pad. 3.Press Fish pad to set weight. 4.Press Start pad to begin work, and LED will show the left time.
Frozen meal	 Frozen Meal		
Beverage	 Beverage		
Popcorn	 Popcorn		
Potato	 Potato		
Pizza	 Pizza		
Meat	 Meat		
Fish	 Fish		

USING THE ACCESSORIES

WARNING!

Refer to the safety chapters.

CAUTION!

Do not cook food without the turntable set. Use only the turntable set provided with the appliance.

i

Never cook food directly on the glass cooking tray.

Inserting the turntable set

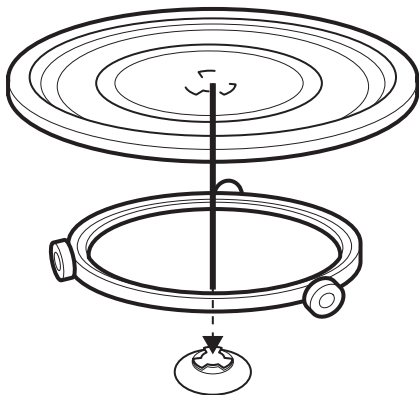



1. Place the roller guide around the turntable shaft.
2. Before first use remove the tape from the centre of the turntable shaft.
3. Place the glass cooking tray on the roller guide.

ADDITIONAL FUNCTIONS

Timer

1. Press .
2. Press the Setting pads to set the time.
3. The Kitchen Timer activates automatically after a few seconds.

When the set time is reached, an acoustic signal sounds. You can set maximum 95 minutes.

 When a function is running and the timer is set you can see the time left or clock if required. Pressing  0 will toggle between function display, timer display or clock display. The timer display will revert back to function after approx. 5 seconds. The clock display will revert back to function after approx. 10 seconds.

 Timer still works when you open the door or pause the appliance. Press  to cancel.

Child Safety Lock

The Child Safety Lock prevents an accidental operation of the appliance.

To activate or deactivate the Child Safety Lock press and hold  for 3 seconds, until an acoustic signal sounds.

When the Child Safety Lock is on, the display shows .

HELPFUL HINTS AND TIPS

Power setting table

Problem	Remedy
You cannot find details for the amount of food prepared.	Look for a similar food. Increase or shorten the length of the cooking times according to the following rule: Double the amount = almost double the time, Half the amount = half the time
The food got too dry.	Set shorter cooking time or select lower microwave power.
The food is not defrosted, hot or cooked after the time came to an end.	Set longer cooking time or set higher power. Note that large dishes need longer time.
After the cooking time comes to an end, the food is overheated at the edge but is still not ready in the middle.	Next time set a lower power and a longer time. Stir liquids halfway through, e.g. soup.

To get better results for rice use a flat, wide dish.

Defrosting

Always defrost roast with the fat side down. Do not defrost covered meat because this may cause cooking instead of defrosting. Always defrost whole poultry breast side down.

Cooking

Always remove chilled meat and poultry from the refrigerator at least 30 minutes before cooking. Let the meat, poultry, fish and vegetables stay covered after cooking.

Brush a little oil or melted butter over the fish. Add 30-45ml of cold water for every 250g of vegetables. Cut the fresh vegetables into even size pieces before cooking. Cook all vegetables with a cover on the container.

Reheating

When you reheat packed ready meals always follow the instructions written on the packaging.

CARE AND CLEANING



WARNING!

Refer to the safety chapters.

Notes on cleaning:

- To clean front panel fingerprint-resistant stainless steel simply wipe with a soft cloth using warm water and a mild detergent. DO NOT use stainless steel cleaners, abrasive cleaners or harsh solvents.
- Clean the appliance interior after each use. Then you can remove dirt more easily and it does not burn on.
- Clean stubborn dirt with a special cleaner.
- Clean all accessories regularly and let them dry. Use a soft cloth with warm water and a cleaning agent.
- To soften hard to remove remains, boil a glass of water at full microwave power for 2 to 3 minutes.
- To remove odours, mix a glass of water with 2 tsp of lemon juice and boil at full microwave power for 5 minutes.

TROUBLESHOOTING



WARNING!

Refer to the safety chapters.

Problem	Possible cause	Remedy
The appliance does not operate.	The appliance is deactivated.	Activate the appliance.
	The appliance is not plugged in.	Plug in the appliance.
	The fuse in the fuse box is blown.	Check the fuse. If the fuse blows more than one time, contact a qualified electrician.
	The door is not closed properly.	Make sure that nothing blocks the door.
The lamp does not operate.	The lamp is defective.	The lamp has to be replaced. Contact the customer service centre.
The display shows  .	The Child Safety Lock is active.	Deactivate the Child Safety Lock. Hold the Cancel button for 3 seconds.
There is sparking in the cavity.	There are metal dishes or dishes with metal trim.	Remove the dish from the appliance.
	There are metal skewers or aluminium foil that touches the interior walls.	Make sure that the skewers and foil does not touch the interior walls.
The turntable set makes scratching or grinding noise or does not rotate smoothly.	There is an object or dirt below the glass cooking tray.	Clean the area below the glass cooking tray including rollers. Check turntable roller assembly and glass are installed correctly.
The appliance stops operating without a clear reason.	There is a malfunction.	Check ventilation of the unit is not obstructed. If this situation repeats with correct installation call the customer service centre.
Microwave runs cooking cycle but food does not heat up.	Internal self-resetting thermostat has activated. The microwave is fitted with a thermostat to protect internal components from overheating.	Once the thermostat's temperature has reduced the unit should function normally. Wait 5 minutes then try the appliance again.
Steam accumulating on microwave oven door or leaking from vents.	Cooking foods with a high moisture content will always produce steam.	This is a normal part of the cooking process.
Smoke during cooking process.	Fat accumulated on cavity grill element.	Ensure inside of unit is cleaned regularly.

If you cannot find a solution to the problem yourself, contact your dealer or the customer service centre.

The necessary data for the customer service centre is on the rating plate on the appliance.

We recommend that you write the data here:

Model (M)

.....

Product number (PNC)

.....

Serial number (S.N.)

.....

INSTALLATION OF EMM23M38GB

! CAUTION!

Do not block the air vents. If you do that, the appliance can overheat.

! CAUTION!

Do not connect the appliance to adapters or extension leads. This can cause overloading and risk of fire.

- Put the appliance far away from steam, hot air and water splashes.
- If the appliance is stored/ transported at sub-zero temperatures, do not activate it immediately after installation. Allow at least two hours for it to be brought up to room temperature before turning on the unit.

Installation

- Remove all packing material and any promotional material from the microwave oven.
- Examine the oven for any damage such as dents or a broken door. Do not install if the oven is damaged. Call the service centre.
- Remove the protective film on the oven cabinet surface. Do not remove the light brown Mica cover that is attached to the right-hand side of the oven cavity to protect the magnetron.
- Do not leave the packing material so that small children can play with it. This can be hazardous.
- Select a flat, level surface that provides enough open space for the intake and outlet vents and that is strong enough to bear the weight of the oven. A minimum clearance of 7.5cm is required between the oven and any adjacent walls. Leave a minimum clearance 30cm above the oven.

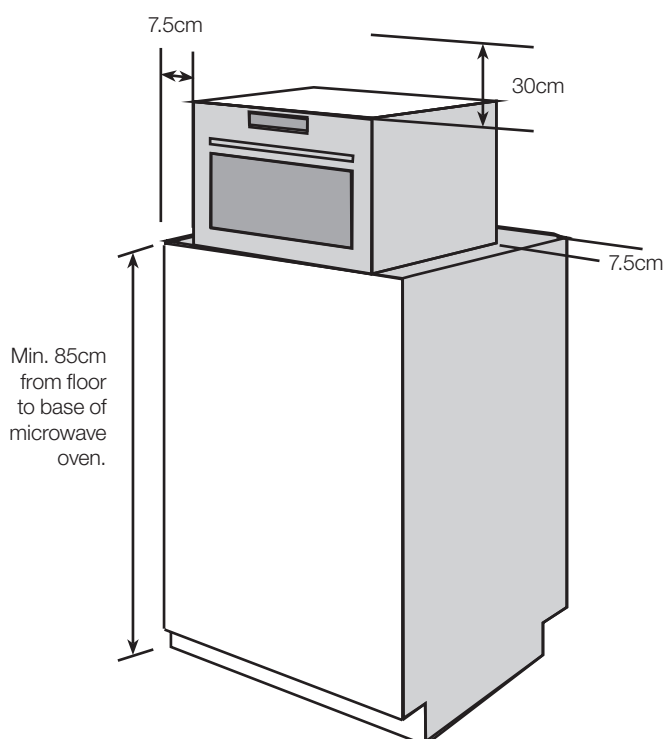

Blocking the intake or outlet vents can damage the oven. If air vents are blocked during operation, the oven may overheat, and this may lead to malfunctioning. Hot air escapes from the vents, so be sure not to obstruct it or let curtains come between the oven and the rear wall.

NOTE: It is recommended to have greater than 7.5cm clearance on at least one of the sides to improve product performance and operation.

- The oven should be placed in a stable position to avoid the possibility of causing vibration or noise.
- Do not remove the legs from the bottom of the oven.
- This oven should only be installed freestanding; not built-in or in a cabinet.
- Keep the oven away from heat and water. Exposure to heat and water can lower the efficiency and lead to malfunctioning.
- Place the oven as far away from radios and TV as possible. Operation of the oven may cause interference to your radio or TV reception.
- When there is interference, it may be reduced or eliminated by taking the following measures:
 - Clean door and sealing surface of the microwave oven.
 - Reorient the receiving antenna of the radio and/or television.
 - Move the microwave oven away from the receiver.
 - Plug the microwave oven into a different outlet so that microwave oven and receiver are on different branch circuits.
- Be sure the voltage and frequency where you connect the microwave oven is the same as specified on the rating plate on the microwave oven. If the microwave oven is connected to the socket via an extension cord, make sure the cord is earthed.

! WARNING!

If installed near or over a heat source, the microwave oven could be damaged.

! WARNING!

This microwave oven must not be used on a non-earth protected power supply. Contact an electrician if you are uncertain regarding electrical connection of the oven or provision of earth protection of the supply.

! WARNING!

If the power cord is damaged, it must be replaced by the manufacturer, its service agent or similarly qualified persons in order to avoid a hazard.

ELECTRICAL INSTALLATION

 **WARNING!**

Only a qualified person must do the electrical installation.



The manufacturer is not responsible if you do not follow the safety precautions from the chapter “Safety Instructions”.

This appliance is supplied with a main cable and main plug.

 **WARNING!**

The microwave oven is fitted with a plug and must be only connected to a properly installed, earthed socket. In accordance with the appropriate regulations, the socket must only be installed and the connecting cable must only be replaced by a qualified electrician. If the plug is no longer accessible following installation an all-pole isolating switch must be present on the installation side with a contact gap of at least 3mm.

Customer care center

<p>Thailand Consumer Care Tel : (+66 2) 725 9000 Electrolux Thailand Co., Ltd. Electrolux Building 14th Floor 1910 New Phetchaburi Road, Bangkapi, Huai Khwang, Bangkok 10310 Office Tel : (+66 2) 7259100 Office Fax : (+66 2) 7259299 Email : customercarethai@electrolux.com</p>	<p>Malaysia Consumer Care Center Tel: 1300-88-11-22 Electrolux Home Appliances Sdn. Bhd. Corporate Office Address: Unit T2-7, 7th Floor, Tower 2, PJ33, No. 3, Jalan Semangat, Seksyen 13, 46200 Petaling Jaya, Selangor. Office Tel : (+60 3) 7843 5999 Office Fax : (+60 3) 7955 5511 Consumer Care Center Address: Lot C6, No. 28, Jalan 15/22, Taman Perindustrian Tiong Nam, 40200 Shah Alam, Selangor Consumer Care Center Fax : (+60 3) 5524 2521 Email : malaysia.customercare@electrolux.com</p>
<p>Indonesia Hotline service: 08041119999 PT. Electrolux Indonesia Electrolux Building Jl.Abdul Muis No.34, Petojo Selatan, Gambir Jakarta Pusat 10160 Email:customercare@electrolux.co.id SMS & WA : 0812.8088.8863</p>	<p>Philippines Consumer Care Center Toll Free : 1-800-10-845-CARE(2273) Consumer Care Hotline : (+63 2) 845-CARE(2273) Electrolux Philippines, Inc. Unit B 12F Cyber Sigma Bldg, Lawton Avenue, McKinley West, Taguig, Philippines 1634 Trunkline: +63 2 737- 4757 Website : www.electrolux.com.ph Email : wecare@electrolux.com</p>
<p>Vietnam Consumer Care Center Toll Free: 1800-58-88-99 Tel: (+84 28) 3910 5465 Electrolux Vietnam Ltd. Floor 9th, A&B Tower 76 Le Lai Street - Ben Thanh Ward - District 1 Ho Chi Minh City , Vietnam Office Tel: (+84 28) 3910 5465 Office Fax: (+84 28) 3910 5470 Email: vncare@electrolux.com</p>	<p>Singapore Consumer Care Center Tel: (+65) 6727 3699 Electrolux S.E.A. Pte Ltd. 1 Fusionopolis Place, #07-10 Galaxis, West Lobby Singapore 138522. Office Fax : (+65) 6727 3611 Email : customer-care.sin@electrolux.com</p>
<p>Hongkong Service Hotline: (+852) 3193 9888 DCH Electrical Appliances Services Centre 5/F, DCH Building, 20 Kai Cheung Road, Kowloon Bay, Hong Kong</p>	

RoHS
Compliant

Conformed to the stipulation on permissible content limitation of some hazardous & restricted chemical substances. (RoHS compliant)

(According to the Circular No. 30/2011/TT-BCT, Vietnam, dated 10th August, 2011)

