

*Thinking of you*

 **Electrolux**

OWNER'S GUIDE  
VERSATILITY  
BAGLESS  
UPRIGHT



## Introduction

Congratulations on your purchase of an Electrolux vacuum cleaner – designed to help you care for your home environment. This Owner’s Guide will help you make the best possible use of your new vacuum cleaner. Please begin by reading it, and keep it for future reference.

**IMPORTANT:** If you have questions about using your vacuum cleaner, call Electrolux’s Customer Service Helpline. Your vacuum cleaner was thoroughly inspected and tested before it left the factory. If you note any shipping damage, call the Helpline immediately.



### **Electrolux Helpline 1-800-896-9756**

Monday – Friday 8 a.m.- 7:30 p.m. (CST)

Saturday – Sunday 10 a.m.- 6:30 p.m. (CST)

## Register your purchase

Please register your purchase at [www.electroluxusa.com](http://www.electroluxusa.com) (USA) or [www.electroluxca.com](http://www.electroluxca.com) (Canada) or by mailing the enclosed product registration card.

## Keep this information

Write the model, type and serial number here:

Date of purchase (keep your receipt) \_\_\_\_\_

Model number and type \_\_\_\_\_

Serial number \_\_\_\_\_

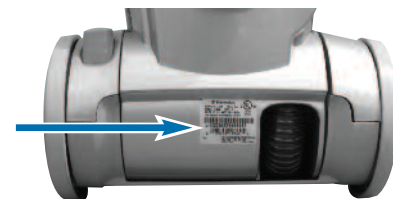

Find these numbers on a label on the lower back side of the vacuum cleaner. Refer to these numbers when ordering parts and accessories or if service is needed.

## For Electrolux service

Authorized Electrolux Service Centers provide maintenance, parts and repair. To find the Service Center nearest you, go to [www.electroluxusa.com](http://www.electroluxusa.com) or call 800-896-9756.

## Contents

Important safeguards and safety features . . . . .	1
Vacuum cleaner parts and accessories . . . . .	2
Vacuuming carpet and hard-surface floors . . . . .	2
Vacuuming with accessories . . . . .	3
Maintenance schedule . . . . .	4
Caring for your vacuum cleaner	
How to clear blockage and replace or clean brush roll . . . . .	5
Troubleshooting . . . . .	6
Electrolux limited warranty. . . . .	7
Owner’s Guide, French . . . . .	8-15
Owner’s Guide, Spanish . . . . .	16-22
Parts list and order forms. . . . .	23-24



# IMPORTANT SAFEGUARDS

When using an electrical appliance, basic precautions should always be followed, including the following:

**READ ALL INSTRUCTIONS BEFORE USING THIS VACUUM CLEANER.**

## WARNING

### To reduce the risk of fire, electric shock, or injury:

- Do not use outdoors or on wet surfaces.
- Do not leave vacuum cleaner when plugged in. Turn off the switch and unplug the electrical cord when not in use and before servicing.
- Do not allow to be used as a toy. Close attention is necessary when used by or near children.
- Use only as described in this manual. Use only manufacturer's recommended attachments.
- Do not use with damaged cord or plug. If vacuum cleaner is not working as it should, has been dropped, damaged, left outdoors, or dropped into water, return it to a service center before using.
- Do not pull or carry by cord, use cord as a handle, close a door on cord, or pull cord around sharp edges or corners. Do not run vacuum cleaner over cord. Keep cord away from heated surfaces.
- Do not use extension cords or outlets with inadequate current-carrying capacity.
- Turn off all controls before unplugging.
- Do not unplug by pulling on cord. To unplug, grasp the plug, not the cord.
- Do not handle plug or vacuum cleaner with wet hands.
- Do not put any object into openings. Do not use with any opening blocked; keep free of dust, lint, hair, and anything that may reduce airflow.
- This vacuum cleaner creates suction and contains a revolving brush roll. Keep hair, loose clothing, fingers, and all parts of body away from openings and moving parts.
- Do not place vacuum on furniture or stairs as the brush roll may cause damage. Use extra care when cleaning on stairs. Place vacuum on floor with the handle in storage position while using attachments.
- Do not pick up anything that is burning or smoking, such as cigarettes, matches, or hot ashes.
- Do not use without dust cup or filter(s) in place.
- Belt pulleys can become hot during normal use. To prevent burns, avoid touching the belt pulley when servicing the drive belt.
- Do not use to pick up flammable or combustible liquids such as gasoline, or use in areas where they may be present.
- Store your vacuum indoors in a cool, dry area.
- Keep your work area well lighted.
- Unplug electrical appliances before vacuuming them.
- Brush roll could suddenly restart. Unplug before servicing.

## SAVE THESE INSTRUCTIONS

### FOR HOUSEHOLD USE ONLY

**To reduce the risk of electric shock**, this appliance has a polarized plug (one blade is wider than the other). This plug will fit in a polarized outlet only one way. If the plug does not fit fully into the outlet, reverse the plug. If it still does not fit, contact a qualified electrician to install the proper outlet. Do not change the plug in any way.

### Thermal cut off

This vacuum cleaner has a special thermostat that protects the vacuum in case of motor overheating. If the vacuum suddenly shuts off, push the on/off switch off (O) and unplug the vacuum. Check the vacuum for a possible source of overheating such as a full dust cup, a blocked hose or clogged filter. If these conditions are found, fix them and wait at least 30 minutes before attempting to use the vacuum. After the 30 minute period, plug the vacuum back in and push the on/off switch on (I). If the vacuum still does not run, then take it to an Electrolux Authorized Service Center for repair.



Follow caution information whenever you see this symbol

# Vacuum cleaner parts and accessories

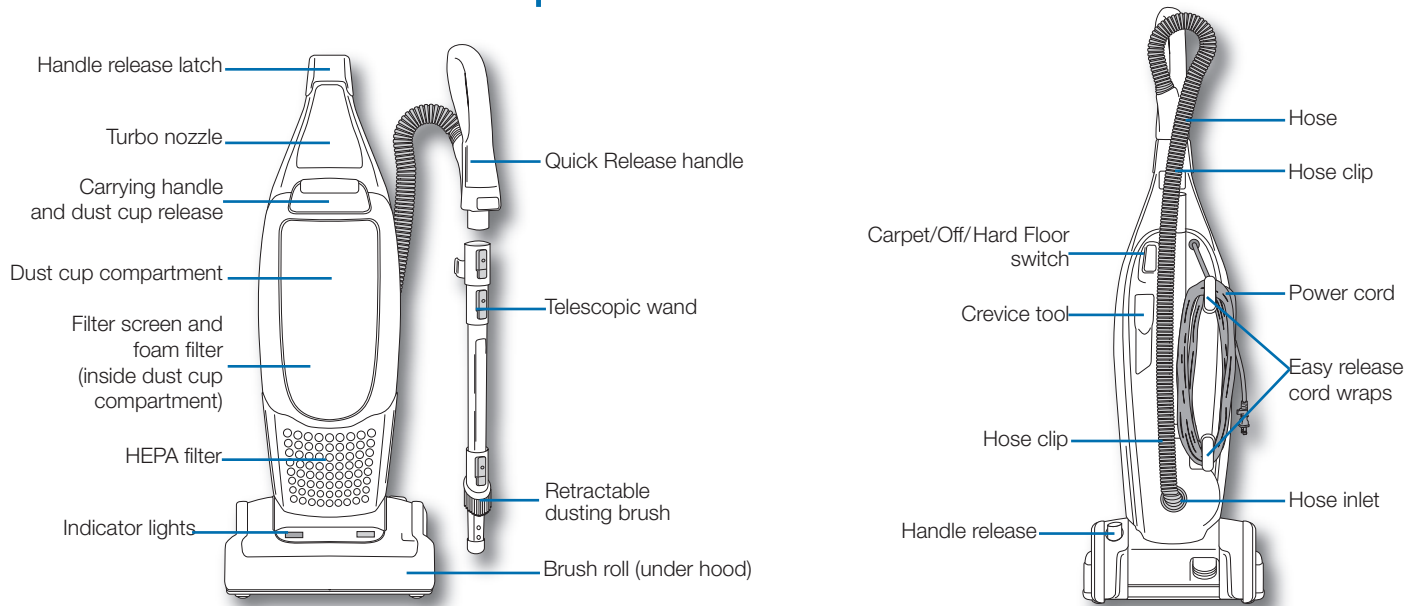

## Vacuuming carpet and hard-surface floors

### Getting started

- Remove wand from back of vacuum; push handle onto wand until it clicks (Fig. 1).
- Reposition end of wand in opening (Fig. 2).
- Align ribs on wand into grooves at top of vacuum (Fig. 3).
- Push down Quick Release handle until it locks into position. Secure hose into hose clip (Fig. 4).
- Plug power cord into outlet.
- Press power switch to select carpet or hard floor (Fig. 5).
- Step on handle release and begin vacuuming (Fig. 6).

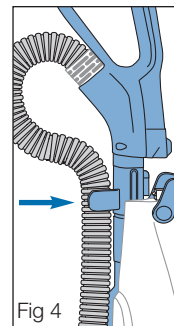
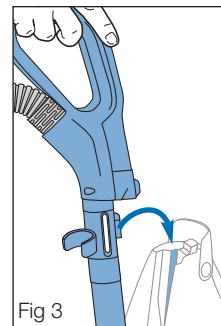
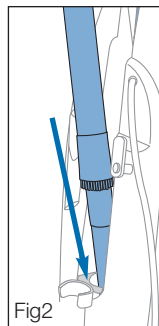
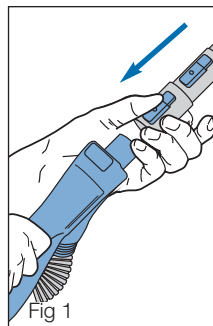

### Hard-surface floors

Use 'hard floor' setting for wood, tile, or other hard-surface floors (Fig. 5). **Do not use** 'carpet' setting for hard-surface floors, as the brush roll could damage delicate surfaces.

### Carpet and rugs

For rugs or carpeted floors, press switch to 'carpet' to engage brush roll (Fig. 5). The brush roll automatically adjusts to carpet height.

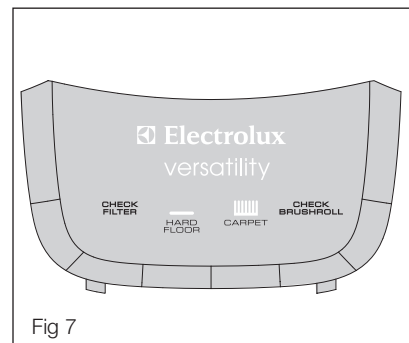
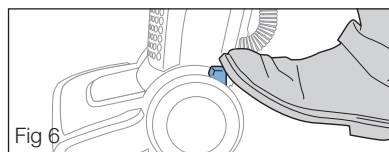
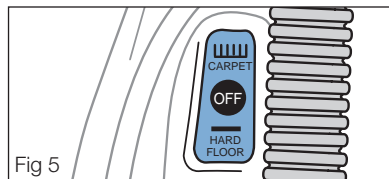

# Vacuumping with accessories



For your safety, turn power switch to 'off' before attaching accessories. Press switch to 'hard floor' setting when using accessories.

To use accessories: With Quick Release handle in upright position, rotate handle release latch forward, then lift handle and pull away from vacuum cleaner body (Fig. 1).

- Extend or shorten the telescopic wand by pressing release button ② (Fig. 2).
- Use crevice tool or turbo nozzle with or without wand. Press button ① to pull wand off handle (Fig. 2).

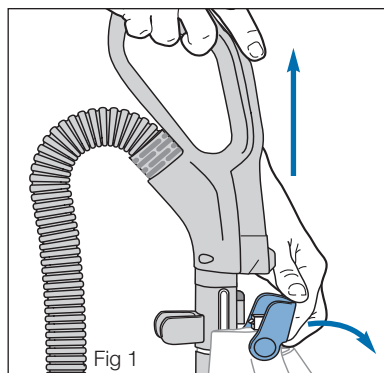

Fig 1

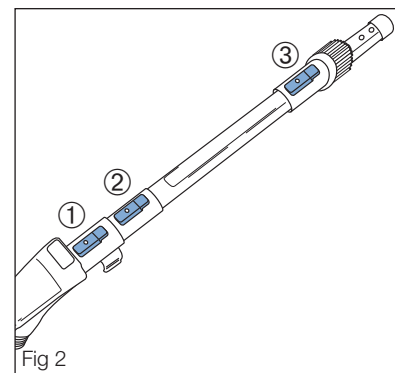

Fig 2

## Dusting brush

Use for baseboards, furniture, vents and blinds (Fig. 4).

- To use, press dusting brush button ③ and slide brush to end of wand until it clicks (Fig. 3).
- After using, slide brush back until it clicks.

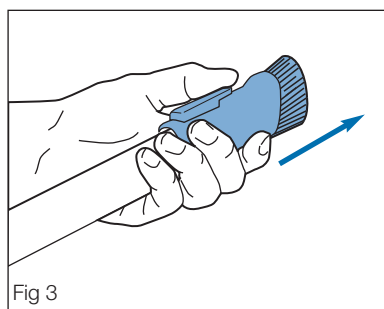

Fig 3

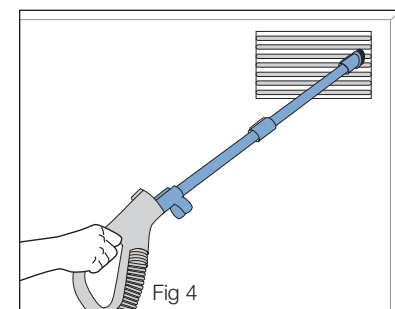

Fig 4

## Crevice tool

Use for grooves, narrow openings, tight spaces (Fig. 5).

- To use, push tool onto handle or wand until snug.
- Store crevice tool on back of vacuum.

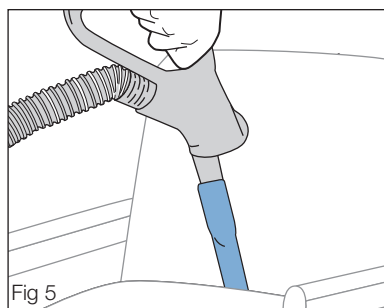

Fig 5

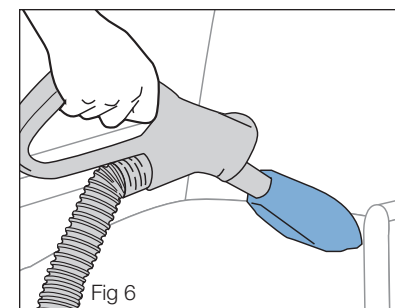

Fig 6

## Turbo nozzle

Use for stairs and upholstered furniture (Fig. 6).

- To use, push nozzle onto handle or wand until snug.
- Store turbo nozzle on front of vacuum.
- Position vacuum cleaner on floor at bottom of stairs, pushed against bottom step (Fig. 7).



For your safety, do not place vacuum at top of stairs or on steps.

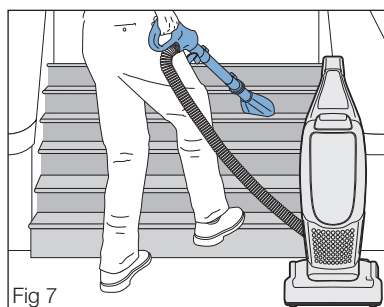

Fig 7

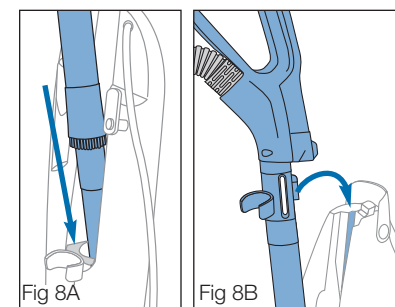

Fig 8A

Fig 8B

## After using accessories

- Press button ② to shorten wand. Press button ③ and slide dusting brush back into storage position (Fig. 2).
- If wand is off, push back onto handle until it clicks.
- Place wand into opening on back of vacuum (Fig. 8A).
- Align ribs on wand into grooves at top of vacuum (Fig 8B). Push down handle until it locks into position.

# Maintenance schedule



Turn power switch to off (O) position and unplug power cord before cleaning filters.  
Do not operate vacuum cleaner without filters in place, as this could cause severe damage to vacuum.

**EACH USE – Empty dust cup after each use OR when debris reaches fill line**

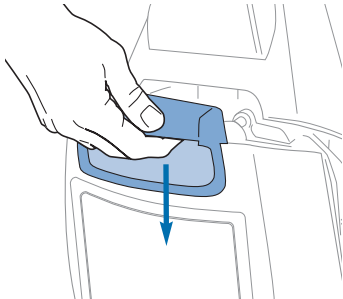

Press down carrying handle and pull out dust cup.

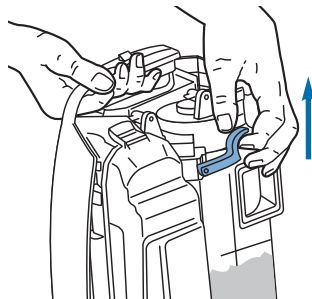

**Hold over waste basket.**  
Pull up orange lever to release lid.

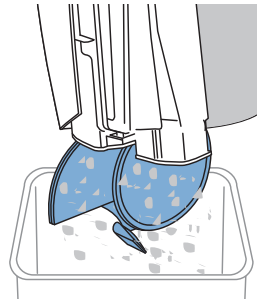

Bottom lid will release; both chambers will empty.

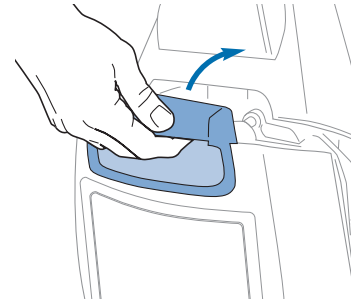

Close bottom lid until it snaps. Put dust cup back in place.

**EACH USE – Check filter screen. Remove and wash screen if debris is visible.**

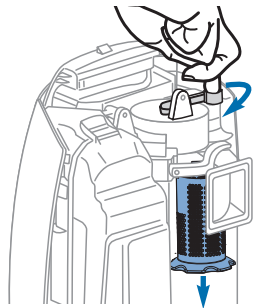

Filter screen is inside dust cup. Pull gray lever to release.

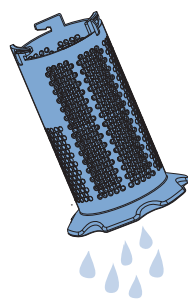

If needed, wash screen with soap and water. Dry thoroughly.

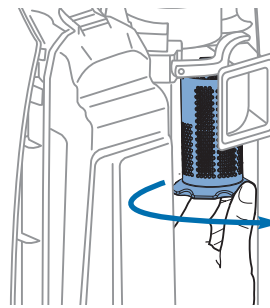

Replace screen. Turn clockwise to fit tabs into grooves and lock.

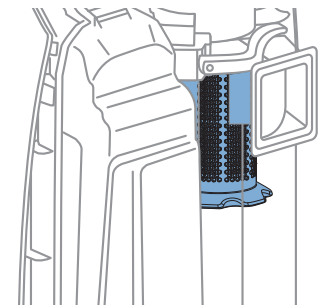

Filter screen must be in place to reinstall dust cup.

**RED INDICATOR LIGHT – Clean foam filter**

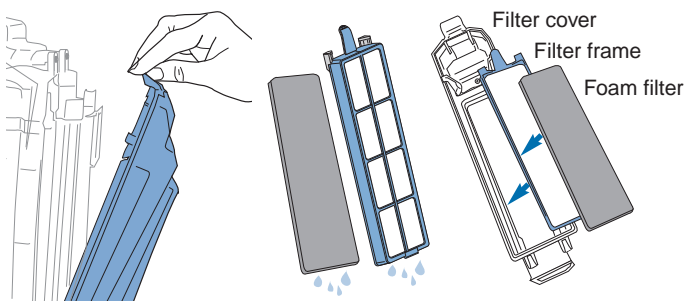

Pull up tab to release filter cover. Wash foam filter and frame. Air dry; reposition in cover. Press firmly at top to snap frame back in place. Filter cover will not close if foam filter and frame are not installed correctly.

**6 MONTHS – Replace HEPA filter**

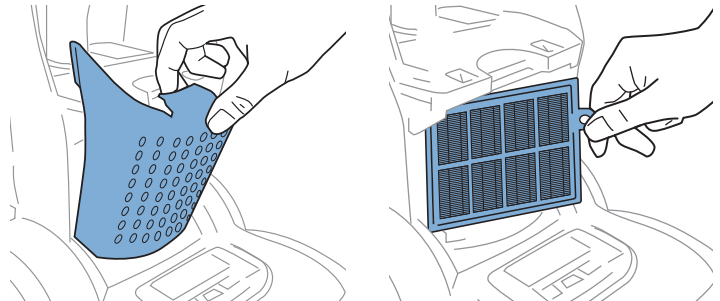

Remove dust cup and set aside. Pull filter cover up and out.

Grasp tab and pull out filter. Replace with new filter.

# Caring for your vacuum cleaner



Turn off vacuum cleaner and unplug power cord. Motor shaft and belt pulley can become hot with normal use. Do not touch motor shaft when checking brush roll.

## How to clear blockage

- Remove Quick Release handle and hose.
- Remove wand from handle. Twist bottom end of hose to remove from vacuum cleaner body (Fig. 1).
- Flex hose to loosen obstruction.
- Use fingers to check for debris in bottom of unit (Fig. 2).
- To replace hose, align tabs, push in and twist until it locks.
- Reattach wand; return handle to position on vacuum.
- To clear inlet hose: Lay vacuum face down. Remove 5 screws (Fig. 4); lift off brush roll cover (Fig. 5). Clear blockage from base hose (Fig. 3). Clear debris from brush roll. Replace cover and 5 screws.

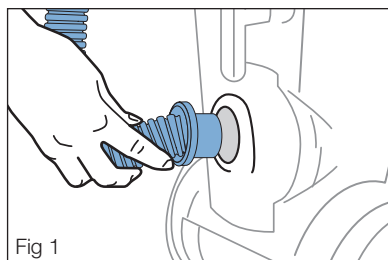

Fig 1

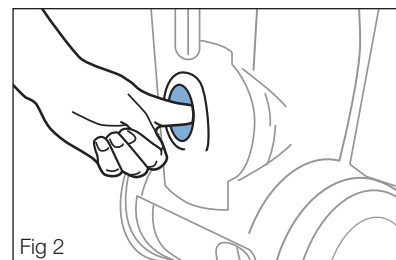

Fig 2

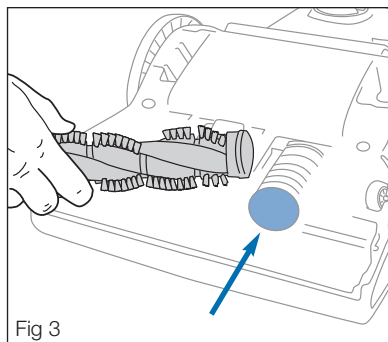

Fig 3

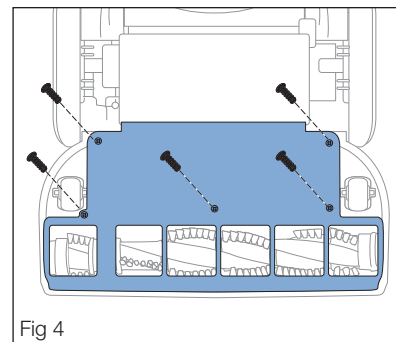

Fig 4



## To remove brush roll

If belt pulley is hot due to recent use, allow to cool before proceeding.

- Press handle release with foot to lower handle flat onto floor.
- Lay vacuum face down; remove 5 screws (Fig. 4).
- Lift off brush roll cover (Fig. 5)
- Lift end of brush roll farther from belt (Fig. 6).
- Lift other end and slip brush roll out of belt.

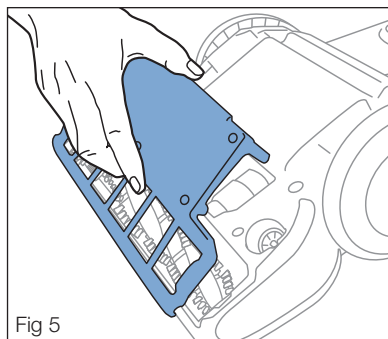

Fig 5

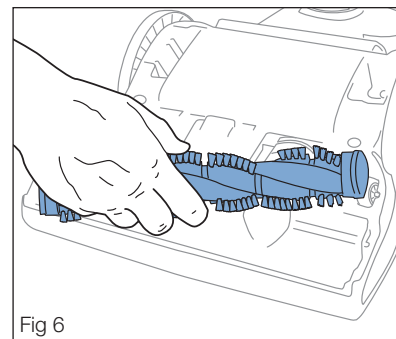

Fig 6

## To replace brush roll or belt

- Place belt onto motor pulley.
- Thread brush roll into belt so belt fits into grooves; align so end cap fits into square opening (Fig. 7).
- Secure opposite end of brush roll.
- Rotate brush roll two turns to center belt.
- Replace brush roll cover and five screws.

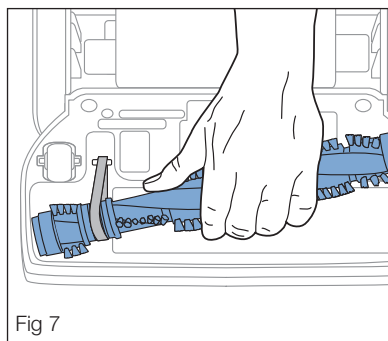

Fig 7

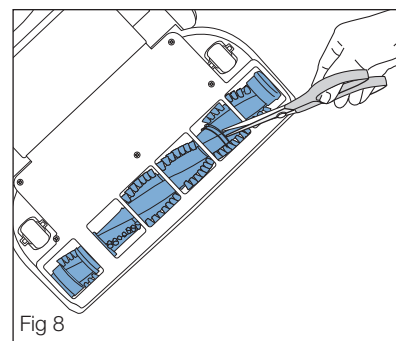

Fig 8

## To clean brush roll

- Press handle release with foot to lower handle flat onto floor.
- Lay vacuum face down; remove any entwined long fibers or hair using scissors (Fig. 8).

# Troubleshooting

 For your safety, turn vacuum cleaner off and unplug power cord before attempting to resolve problems.



Problem	Possible cause	Solution
Motor will not start or suddenly stops	Unit not connected to power source.	<ul style="list-style-type: none"> <li>■ Push plug securely into outlet.</li> <li>■ Try another outlet and check circuit breaker.</li> <li>■ Check plug and cord for damage.</li> </ul>
	Switch not turned on.	<ul style="list-style-type: none"> <li>■ Press power switch to 'carpet' or 'hard floor setting'.</li> </ul>
	Thermal cut-off has operated.	<ul style="list-style-type: none"> <li>■ Correct the cause of motor overheating. See thermal cut-off information page 1.</li> </ul>
No suction; vacuum cleaner does not pick up lint or dirt.	Blockage in hose.	<ul style="list-style-type: none"> <li>■ Remove any obstructions that restrict airflow through hose. See page 5.</li> </ul>
	Dust cup full.	<ul style="list-style-type: none"> <li>■ Empty dust cup. Make sure both chambers are empty. See page 4.</li> </ul>
	Foam filter clogged.	<ul style="list-style-type: none"> <li>■ Remove and clean foam filter. See page 4. Fine dust can block airflow through the foam filter and reduce suction, even if dust cup does not look full.</li> </ul>
	Filter screen clogged	<ul style="list-style-type: none"> <li>■ Remove and clean filter screen. See page 4.</li> <li>■ Make sure filter screen stays in place inside dust cup at all times.</li> </ul>
	Foam filter not in place.	<ul style="list-style-type: none"> <li>■ Foam filter must be in filter frame for correct performance. See page 4.</li> <li>■ Make sure filter frame is installed properly in filter cover for dust cup assembly to fit back into place. See page 4.</li> </ul>
	Switch not on proper setting.	<ul style="list-style-type: none"> <li>■ Use 'carpet' setting for carpeted floors.</li> <li>■ Use 'hard floor' setting for hard-surface floors and when using accessories.</li> </ul>
	Turbo nozzle clogged	<ul style="list-style-type: none"> <li>■ Remove and clean debris from turbo nozzle.</li> </ul>
Dust cup will not lock into vacuum cleaner.	Filter screen not in place.	<ul style="list-style-type: none"> <li>■ Locate filter screen and insert into dust cup. See page 4.</li> </ul>
Quick Release handle will not lock into vacuum cleaner.	Dusting brush and telescopic wand are extended.	<ul style="list-style-type: none"> <li>■ Retract telescopic wand and dusting brush to expose end of wand. See page 3.</li> <li>■ Place end of wand into opening on back of vacuum and align ribs into grooves. See page 2.</li> </ul>
Brush roll will not turn.	Object caught in brush roll.	<ul style="list-style-type: none"> <li>■ Remove the obstruction (such as carpet fringe, string or sock). Note: brush roll overload protector will reset when vacuum is turned off or unplugged.</li> <li>■ Use 'hard floor' setting when vacuuming fringe of rugs.</li> <li>■ Check brush roll for threads and debris; clean if needed. See page 5.</li> </ul>
	Belt and/or brush roll not positioned properly.	<ul style="list-style-type: none"> <li>■ Make sure belt is on motor pulley and fitted into grooves on brush roll. See page 5.</li> <li>■ Make sure both ends of brush roll are free of debris and secured properly so roll can rotate freely. See page 5.</li> </ul>
Red 'check brush roll' or 'check filter' indicator light is on.	Brush roll not operating properly or foam filter is clogged.	<ul style="list-style-type: none"> <li>■ Check brush roll for threads and debris; clean if needed. See page 5.</li> <li>■ Remove and clean foam filter. See page 4.</li> </ul>



# Electrolux Limited Warranty

Your Electrolux vacuum cleaner is warranted to be free from all defects in material and workmanship in normal household use for a period of two years. The warranty is granted only to the original purchaser and members of his or her immediate household. The warranty is subject to the following provisions.

This warranty does not cover parts of the vacuum that require replacement under normal use, such as disposable dust bags, fans, filters, drive belts, brush roll bristles, impellers and cleaning. Any damages or malfunctions caused by negligence, abuse, or use not in accordance with the Owner's Guide are not covered by this warranty. Likewise, any defects or damages caused by unauthorized service or the use of other than Genuine Electrolux parts are not covered.

Electrolux will, at its option, repair or replace a defective vacuum or vacuum part that is covered by this warranty. As a matter of warranty policy, *Electrolux will not refund the consumer's purchase price.*

To register your warranty, please visit [www.electroluxusa.com](http://www.electroluxusa.com) (USA), [www.electroluxca.com](http://www.electroluxca.com) (Canada) or fill out and return the attached warranty registration card.

To obtain warranty service you must return the defective vacuum cleaner or parts along with proof of purchase to any Electrolux Authorized Warranty Station.

For the location of the nearest Electrolux Authorized Warranty Station or for service information in the United States or Canada, please telephone toll free:

**1-800-896-9756**

**You may also visit us online at [www.electroluxusa.com](http://www.electroluxusa.com) (USA)  
or [www.electroluxca.com](http://www.electroluxca.com) (Canada)**

## Further limitations and exclusions are as follows

Any warranty that may be implied in connection with your purchase or use of the vacuum cleaner, including any warranty of Merchantability or any warranty for Fitness For A Particular Purpose is limited to the duration of this warranty. Some states do not allow limitations on how long an implied warranty lasts, so the above limitations may not apply to you.

Your relief for the breach of this warranty is limited to the relief expressly provided above. In no event shall Electrolux be liable for any consequential or incidental damages you may incur in connection with your purchase or use of the vacuum. Some states do not allow the exclusion or limitation of incidental or consequential damages, so the above limitation or exclusion may not apply to you.

This warranty gives you specific legal rights. You may also have other rights which vary by state.

