

Front Load Washers

EIFLW55H MB, EIFLW55H IW

Featuring IQ-Touch™ Electronic Controls

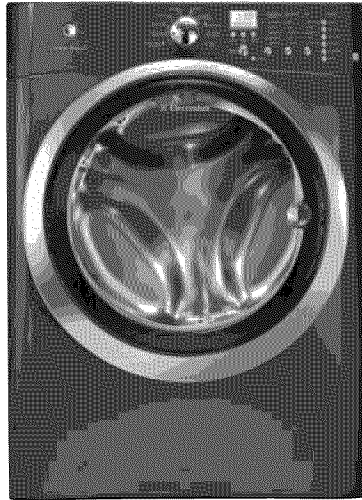

Mediterranean Blue
EIFLW55H MB



Island White
EIFLW55H IW

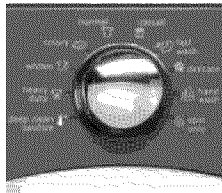

IQ-Touch™ Controls

All the custom wash cycles you'll need. An additional "My Favorite" setting allows user to program a customized cycle.



Largest Capacity Washer¹

Wash the most in one load with our 4.7 cubic foot washer.



Perfect Balance™ System

State-of-the-art technology keeps even oversized loads balanced for smooth, quiet operation. Perfect for installation upstairs, even near bedrooms.

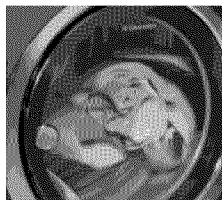

AquaLux™ Wash System

Energy-efficient wash system is gentle on the environment and on clothes. Washers are 75% more energy efficient,² use 56% less water,³ and have the fastest wash time.⁴

27" ELECTRIC FRONT LOAD WASHERS

Capacity IEC	4.7 Cu. Ft.
ENERGY STAR [®]	Yes
NSF [®] Certified	Yes

Features

Signature Soft-Arc Door Design	Yes
IQ-Touch™ Electronic Controls with LCD Display	Yes
Perfect Balance™ System	Yes
Luxury-Quiet™ Sound Package	Yes
Luxury-Design™ Lighting	Yes
Touch-2-Open™/(Close) Door	Yes
Luxury-Glide™ Touch-2-Open™/(Close) Dispenser Drawer	Yes
AquaLux™ Wash System	Yes
Integral Water Heater	Yes
Stainless Steel Wash Drum	Yes
Automatic Temperature Control	Yes
Automatic Water Level Adjustment	Yes
Auto Prewash Detergent Dispenser (Liquid/Powder)	Yes
Auto Bleach Dispenser (Liquid Only)	Yes
Auto Detergent Dispenser (Liquid/Powder)	Yes
Auto Fabric Softener Dispenser	Yes
Tumble Speed (RPM)	48-52 Variable
Spin Speed (RPM)	1,200
Reversible Door	Yes
Adjustable Leveling Legs	Yes

Cycles

Fast Wash, My Favorite (1), Deep Clean Sanitize, Heavy Duty, Whites, Colors, Normal, Casual, Delicates, Hand Wash, Spin Only	11
--	----

Options

Temperature Selections	5
Spin Speed Selections	5
Soil Level Selections	5
Delay Start (Hours)	14
End-of-Cycle Chime	Adjustable

Installation Options

Freestanding	Yes
Under Counter*	Yes
Stacked (Under Dryer)	Yes
Pedestal	Yes
Hidden (In Closet)	Yes
Second Floor	Yes

Accessories

Luxury-Glide™ Touch-2-Open™/(Close) Pedestal – Mediterranean Blue (EPWD15MB), Island White (EPWD15IW)	Optional
Drain Hose Extension Kit – (137098000)	Optional
Mobile Home Installation Kit – (137067200)	Optional

Specifications

Color –	
Mediterranean Blue	MB
Island White	IW
Overall Exterior Dimensions –	
Height (Without 15" Pedestal)	38"
(With 15" Pedestal)	53"
Width	27"
Depth (to Center of Arc Not Including Hose)	31-1/2"
(with 90° Door Open)	50-5/8"
Power Supply/ Water Inlet Location	Top Right Rear/ Top Left Rear
Voltage Rating	120V/60Hz/15A
Connected Load (kW Rating) @ 120 Volts [†]	1.4
Watts @ 120 Volts	1,000
Amps @ 120 Volts	12
Shipping Weight	247 Lbs.

¹Side-by-Side units in under-counter installation require custom-built countertop and/or cabinetry.

²For use on adequately wired 120V, dedicated circuit having 2-wire service with a separate ground wire. Appliance must be grounded for safe operation.

³NOTE: Always consult local and/or national electric codes. Refer to Product Installation Guide for detailed installation instructions on the web at electroluxappliances.com.

Specifications subject to change.

⁴Based on manufacturer specifications.

²Energy efficiency based on current DOE Federal Minimum standard for washers based on MEF.

³Water Savings based on DOE ENERGY STAR[®] energy savings calculator.

⁴Fastest time based on smallest load/Fast Wash cycle selected for various load compositions.



Front Load Washers

EIFLW55H MB, EIFLW55H IW

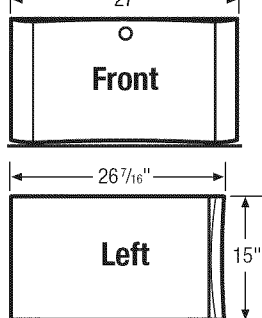
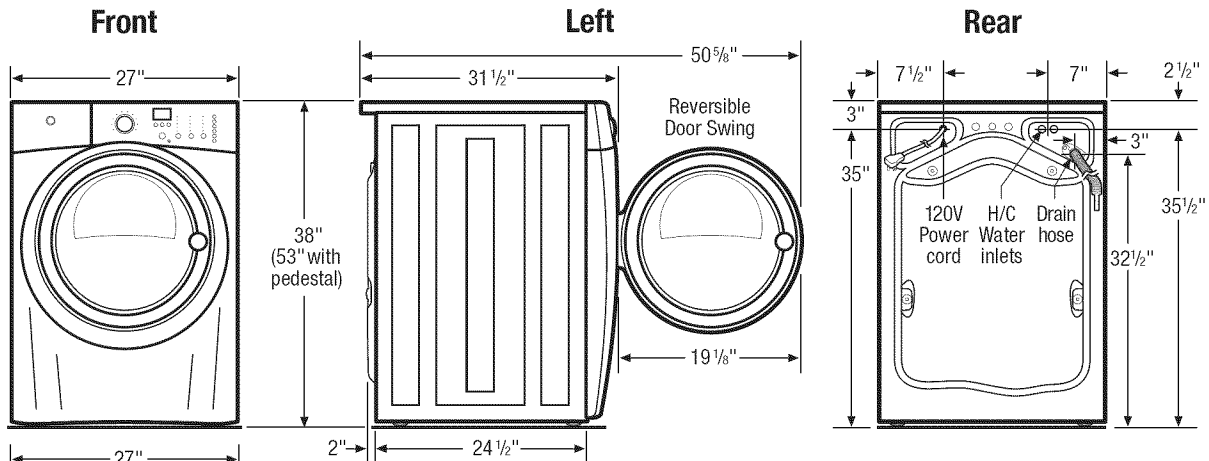

15" Drawer Pedestal Installation

Elevates dryer height to 53". For detailed pedestal installation, refer to instructions included with pedestal or on web. **Note:** Pedestal Installation requires modified utility hookup locations. For details, refer to Product Installation Guide on web.

Built-In Installations

For built-in installations, NO minimum clearance required around sides or backs of units. For closet installation, allow 1" clearance between fronts of units and door. Location of plumbing, exhaust and utility hookups MUST be considered in built-in installations. For additional installation details, refer to Product Installation Guides on web.

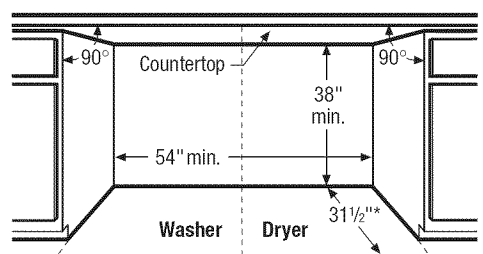

Side-by-Side Units in Under-Counter Installation

Requires custom-built countertop and/or cabinetry. * To achieve minimal depth dimensions or clearances, dryer MUST be vented straight back or with quick-turn 90° elbow.

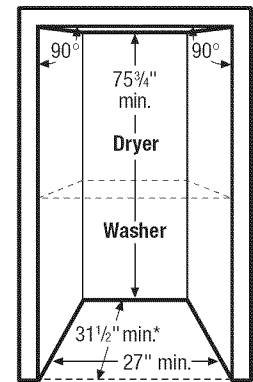

Stacked Units in Recessed or Closet Installation

For detailed stacked installation, refer to instructions included with Stacking Kit or on web. **Note:** Stacked installation requires modified utility hookup locations for dryer. For details, refer to Product Installation Guide on web.

Front Load Washer Specifications

- Product Weight – 237 Lbs.
- An electrical supply with grounded three-prong receptacle is required. The power supply circuit must be installed in accordance with current edition of National Electrical Code (ANSI/NFPA 70) and local codes & ordinances. (Do not use same circuit as dryer.)
- Voltage Rating – 120V/60Hz/15 Amps
- Amps @ 120 Volts = 12 Amps
- Connected Load (kW Rating) @ 120 Volts = 1.4kW
- Equipped with 120V 3-wire power supply cord, approx. 60" long.
- Always consult local and/or national electric & plumbing codes.
- To maximize detergent effectiveness, ambient temperature should never be below 60°F.
- Can be installed alone, with or without optional 15" drawer pedestal, or stacked beneath matching Electrolux Dryer, which requires stacking kit included with dryer. (For installation details, refer to instructions included with optional pedestal or stacking kit or on web.)
- Can be built in with matching Electrolux Dryer in under-counter, recessed or closet installation. Installations requiring countertop and/or cabinetry will require custom building. (Refer to Built-In Installations on this page for cutout dimensions. For additional installation details, refer to Product Installation Guide on web.)
- Closet installation requires vented door with 2 unobstructed louvered openings, minimum 60 sq.in. each, located 3" from top and bottom of door. Full-length 120 sq.in. opening also acceptable. Allow 1" clearance between door and fronts of units.

- Do NOT install in area exposed to dripping water or outdoor weather conditions, or where gasoline or other flammables, including automobiles, are kept or stored.
- Floor MUST be solid with 1" maximum slope. To ensure vibration or movement does not occur, reinforcement of floor may be necessary. Do NOT install on carpeted surface.
- Leveling legs supplied to level washer properly and reduce excessive noise and vibration.
- H/C water faucets MUST be installed within 42" of washer's water inlet and MUST be 3/4" garden hose type, to connect to 48-1/2" inlet hoses.
- Water pressure MUST be between 30 and 120 psi with NOT more than 10 psi pressure difference between hot and cold.
- Drain required with standpipe diameter of 1-1/4" min. and height of 24" min./96" max. capable of eliminating 17 gallons per minute. Attached 59" drain hose can reach 79"-high standpipe.

Note: For planning purposes only. Refer to Product Installation Guide on the web at electroluxappliances.com for detailed instructions.

Optional Accessories

- Drawer Pedestals – Mediterranean Blue (EPWD15MB), Island White (EPWD15IW).
- Drain Hose Extension Kit – (137098000).
- Mobile Home Installation Kit – (137067200).



Electrolux Major Appliances, N.A.

USA • 250 Bobby Jones Expressway • Augusta, GA 30907 • 1-877-4electrolux (1-877-435-3287) • electroluxappliances.com
 CANADA • 5855 Terry Fox Way • Mississauga, ON L5V 3E4 • 1-800-265-8352 • electroluxappliances.ca

High standards of quality at Electrolux Home Products, Inc. mean we are constantly working to improve our products. We reserve the right to change specifications or discontinue models without notice.