

## Welcome to the world of electrolux

Thank you for choosing a first class product from Electrolux, which hopefully will provide you with lots of pleasure in the future. The Electrolux ambition is to offer a wide variety of quality products that make your life more comfortable. You find some examples on the cover in this manual. Please take a few minutes to study this manual so that you can take advantage of the benefits of your new machine. We promise that it will provide a superior User Experience delivering Ease-of-Mind. Good luck!

The symbols you will see on some paragraphs of this booklet have the following meaning:



The warning triangle and/or the key words (Warning!, Caution!) emphasize information that is particularly important for your safety or correct functioning of the appliance.



The information marked with this symbol provides additional instructions and practical tips on the use of the appliance.



Tips and information about economical and ecological use of the machine are marked with this symbol.

Our contribution to the protection of the environment: we use environmentally friendly paper.

## Contents

Safety information .....	<b>5</b>
Product description .....	<b>7</b>
Control panel .....	<b>8</b>
Use .....	<b>9</b>
Washing hints .....	<b>15</b>
International wash code symbols .....	<b>18</b>
Programme information.....	<b>19</b>
Washing programmes.....	<b>20</b>
Care and cleaning .....	<b>22</b>
Something not working .....	<b>25</b>
Technical data .....	<b>29</b>
Installation .....	<b>30</b>
Environment concerns .....	<b>33</b>

## Safety information



**In the interest of your safety and to ensure the correct use, before installing and first using the appliance, read this user manual carefully, including its hints and warnings. To avoid unnecessary mistakes and accidents, it is important to ensure that all people using the appliance are thoroughly familiar with its operation and safety features. Save these instructions and make sure that they remain with the appliance if it is moved or sold, so that everyone using it through its life will be properly informed on appliance use and safety.**

### General safety

- It is dangerous to alter the specifications or attempt to modify this product in anyway.
- During high temperature wash programmes the door glass may get hot. Do not touch it!
- Make sure that small pets do not climb into the drum. To avoid this, please check into the drum before using.
- Any objects such as coins, safety pins, nails, screws, stones or any other hard, sharp material can cause extensive damage and must not be placed into the machine.
- Only use the advised quantities of fabric softener and detergent. Damage to the fabric can ensue if you overfill. Refer to the manufacturer's recommendations of quantities.

- Wash small items such as socks, laces, washable belts etc in a washing bag or pillow case as it is possible for such items to slip down between the tub and the inner drum.
- Do not use your washing machine to wash articles with whalebones, material without hems or torn material.
- Always unplug the appliance and turn off the water supply after use, clean and maintenance.
- Under no circumstances should you attempt to repair the machine yourself. Repairs carried out by inexperienced persons may cause injury or serious malfunctioning. Contact your local Service Centre. Always insist on genuine spare parts.

### Installation

- This appliance is heavy. Care should be taken when moving it.
- When unpacking the appliance, check that it is not damaged. If in doubt, do not use it and contact the Service Centre.
- All packing and transit bolts must be removed before use. Serious damage can occur to the product and to property if this is not adhered to. See relevant section in the user manual.
- After having installed the appliance, check that it is not standing on the inlet and drain hose and the worktop is not pressing the electrical supply cable.
- If the machine is situated on a carpeted floor, please adjust the feet in order to allow air to circulate freely.

## 6 electrolux **safety information**

- Always be sure, that there is no water leakage from hoses and their connections after the installation.
- Any plumbing work required to install this appliance should be carried out by a qualified plumber.
- Any electrical work required to install this appliance should be carried out by a qualified electrician.

### **Use**

- This appliance is designed for domestic use. It must not be used for purposes other than those for which it was designed.
- Only wash fabrics which are designed to be machine washed. Follow the instructions on each garment label.
- Do not overload the appliance. See the relevant section in the user manual.
- Before washing, ensure that all pockets are empty and buttons and zips are fastened. Avoid washing frayed or torn articles and treat stains such as paint, ink, rust, and grass before washing. Underwired bras must NOT be machine washed.
- Garments which have been in contact with volatile petroleum products should not be machine washed. If volatile cleaning fluids are used, care should be taken to ensure that the fluid is removed from the garment before placing in the machine.
- Never pull the power supply cable to remove the plug from the socket; always take hold of the plug itself.
- Never use the washing machine if the power supply cable, the control panel, the working surface or the base are damaged so that the inside of the washing machine is accessible.

### **Child safety**

- This washing machine is not intended for use by young children or infirm persons without supervision.
- Young children should be supervised to ensure that they do not play with the appliance.
- The packaging components (e.g. plastic film, polystyrene) can be dangerous to children - danger of suffocation! Keep them out of children's reach
- Keep all detergents in a safe place out of children's reach.
- Make sure that children or pets do not climb into the drum. To avoid this the machine incorporates special feature. To activate this device, rotate the button (without pressing it) inside the door clockwise until the groove is horizontal. If necessary use a coin.

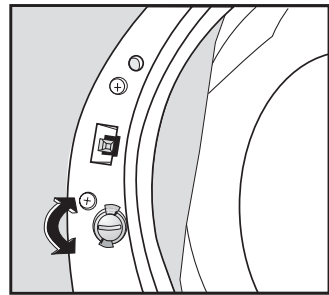

To disable this device and restore the possibility of closing the door, rotate the button anti-clockwise until the groove is vertical.

## Product description

Your new appliance meets all modern requirements for effective treatment of laundry with low water, energy and detergent consumption.

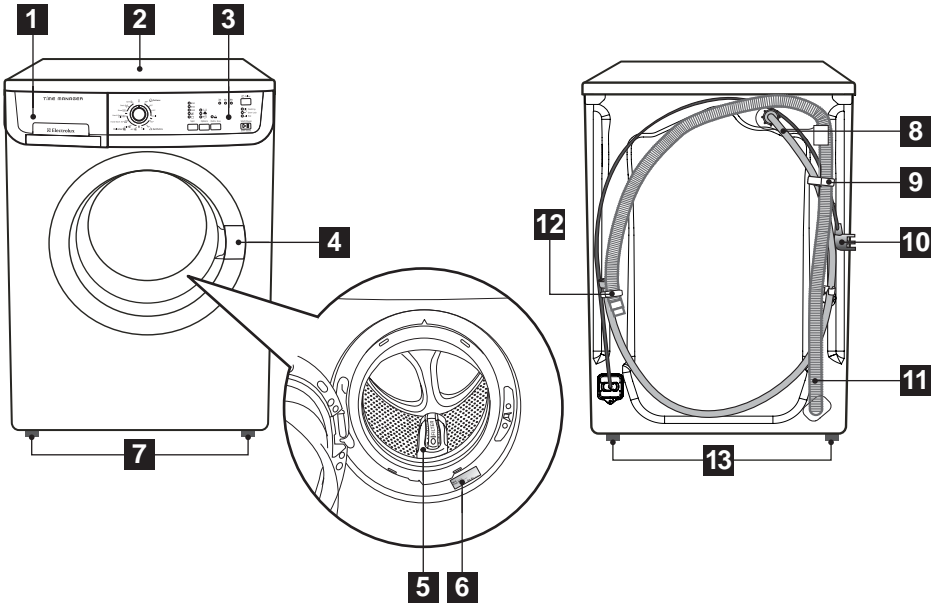

**1** Detergent Dispenser Drawer

**2** Worktop

**3** Control Panel

**4** Door Opening Handle

**5** Drain Filter

**6** Rating Plate

**7** Front Feet

**8** Water Inlet Hose

**9** Drain Hose Support

**10** Mains Cable

**11** Water Drain Hose

**12** Hose Holders

**13** Back Feet

### Detergent dispenser drawer

 Prewash

 Wash

 Fabric Softener

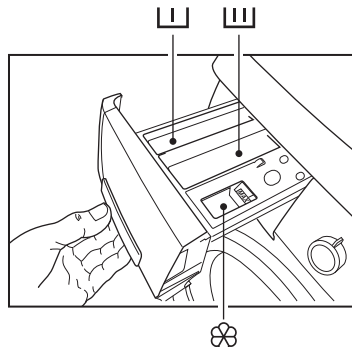

## Control panel

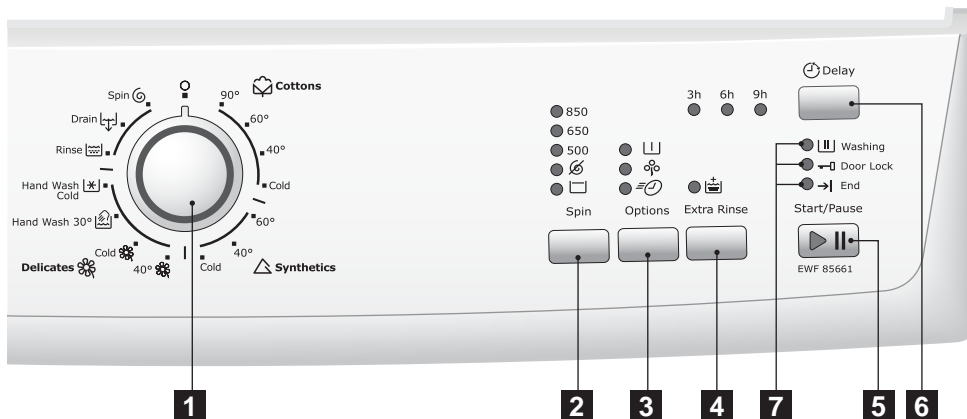

- 1 Programme selector dial**  
See page 10.
- 2 Spin selector button**  
See page 10.
- 3 Options button**  
See page 11.
- 4 Extra Rinse button**  
See page 12.
- 5 Start/Pause button**  
See page 12.
- 6 Delay Start button**  
See page 13.
- 7 Programme progress display**  
See page 13.



## Use

### First Use



- Ensure that the electrical and water connections comply with the installation instructions.
- Run a cotton cycle at 90 °C, without any laundry in the machine, to remove any manufacturing residue from the drum and tub. Pour 1/2 a measure of detergent into the dispenser drawer and start the machine.

### Measure out the detergent and the fabric softener

Pull out the dispenser drawer until it stops. Measure out the amount of detergent required, pour it into the main wash compartment  and, if you wish to carry out the “**prewash**” phase, pour it into the compartment marked .

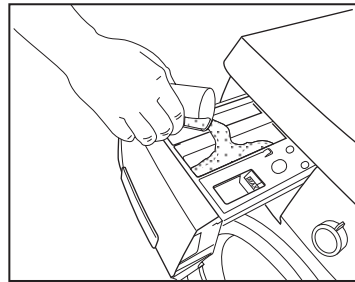

### Daily Use



#### Load the laundry

Open the door by carefully pulling the door handle outwards. Place the laundry in the drum, one item at a time, shaking them out as much as possible. Close the door.

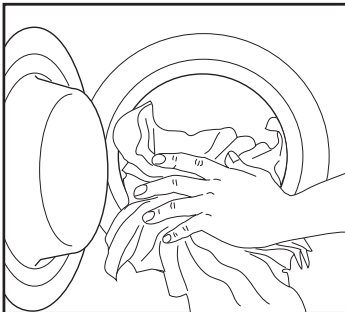

If required, pour fabric softener into the compartment marked  (the amount used must not exceed the “MAX” mark in the drawer). Close the drawer gently.

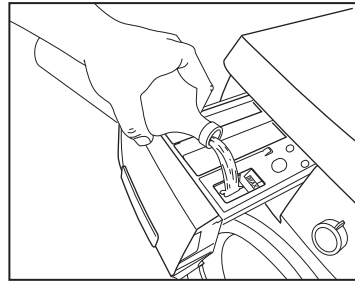

## Select the required programme

Turn the programme selector dial to the required programme.  
The green Start/Pause light starts to flash.

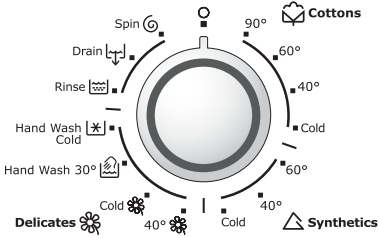

The selector dial is divided into following sections:

- Cottons (☐)
- Synthetics (△)
- Delicates (❁)
- Hand Wash 30° (👉) and Hand Wash Cold (👉)
- Rinses (👉), Drain (👉), Spin (🌀).

The selector dial can be turned either clockwise or anticlockwise. Position **O** to Reset programme/Switching OFF of the machine.

**At the end of the programme the selector dial must be turned to position “O”, to switch the machine off.**

### Attention!

If you turn the programme selector dial to another programme when the machine is working, the **red** Start/Pause pilot light will flash 3 times to indicate a wrong selection. The machine will not perform the new selected programme.

## Programme Option buttons

Depending on the programme, different functions can be combined. These must be selected after choosing the desired programme and before depressing the Start/Pause button.

When these buttons are pressed, the corresponding pilot lights come on. When they are pressed again, the pilot lights go out.

## Select the spin speed or No Spin (🌀) or Rinse Hold (👉) option

● 850

● 650

● 500

● 🌀

● 👉

Spin

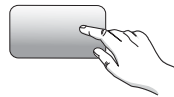

Press the Spin button repeatedly to change the spin speed, if you want your laundry to be spun at a speed different from the one proposed by the washing machine.

The relevant light will light up. Maximum speeds are:

- Cottons ☐, Synthetics △ and Hand Wash: **850 rpm;**
- Delicates ❁ : **650 rpm.**

**🌀 (No Spin):** by selecting this option, the machine will not spin the clothes after drain the water at the last rinse.



**□ (Rinse Hold):** by selecting this option the water of the last rinse is not emptied out to prevent the fabrics from creasing. When the programme has finished the pilot lights →| (End) and →□ (Door Lock) are on, the Start/Pause and the “wash” **□** pilot light are off and the door is locked to indicate that the water must be emptied out.

To do this:

- turn the programme selector dial to “O”.
- select the **□** (Drain), **⊙** (Spin) programme
- reduce the spin speed if needed, by means of the relevant button
- depress **Start/Pause** button
- at the end of programme, only the pilot light →| (End) comes on.

### Select the options: **□** (Prewash) or **⊙** (Economy) or **≠⊙** (Quick)

Press the Options button repeatedly, to select the desired option. The relevant light will light up.

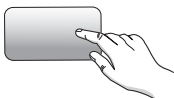
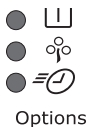

You can select 3 different options:

- **□ (Prewash):** select this option if you wish your laundry to be prewashed at 30° C before the main wash.

**This option can be selected with only Cottons (☁) programme.**

The Prewash ends with a short spin in programmes for cotton fabrics.

- **⊙ (Economy):** select this option if you wish your laundry to be washed is slightly/normally soiled cottons. This programme will obtain good washing results by saving energy.

**This option can be selected with programmes:**

- **Cottons (☁) Cold, 40°, 60° and 90° C**
- **Synthetics (△) Cold, 40° and 60° C**

- **≠⊙ (Quick):** a very short cycle for slightly soiled items that have been used or worn for a short time.

**This option can be selected with programmes:**

- **Cottons (☁) Cold, 40°, 60° and 90° C**
- **Synthetics (△) Cold, 40° and 60° C**
- **Delicates (✿) Cold and 40° C**

The washing time will be reduced according to type of fabric and the selected temperature.

On cottons and synthetics programmes the rinses will be performed with more water.

If an option is chosen that is not allowed with the selected programme, the **red** pilot light of the START/PAUSE button will flash 3 times.

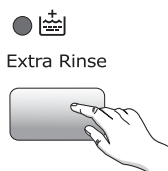

## Select the Extra Rinse ( ) option



This option is recommended for people who are allergic to detergents, and in areas where the water is very soft.

The machine performs some additional rinses.

**This option can be selected with programmes:**



- Cottons (  ) Cold, 40°, 60° and 90° C
- Synthetics (  ) Cold, 40° and 60° C
- Delicates (  ) Cold and 40° C

## Select the Start/Pause

Start/Pause



To start the selected programme, press the **“Start/Pause”** button; the corresponding green pilot light stops flashing.

The **“Washing  ”** and **“Door Lock  ”** lights are on to indicate that the appliance starts operating and the door is locked.

To interrupt a programme which is running, depress the **“Start/Pause”** button; the corresponding green pilot light starts to flash.

To restart the programme from the point at which it was interrupted, **press** the **“Start/Pause”** button again.

If you have chosen a delayed start, the machine will begin the countdown.

If an incorrect option is selected, an integrated red pilot light of the “Start/Pause” button flashes for 3 times.

## Select the Delay start

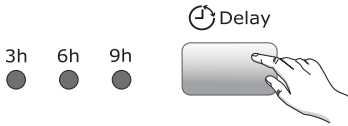

**Before you start the programme**, if you wish to delay the start, press the Delay Start button repeatedly, to select the desired delay. The relevant light illuminates.

This option makes it possible to delay the starting of the washing programme by 3, 6, and 9 hours.

You must select this option after you have set the programme and before you press the Start/Pause button. You can cancel the delay time at any moment, before you press the Start/Pause button.

If you have already pressed the Start/Pause button, and you wish to cancel the delay time, proceed as follows:

- set the washing machine to PAUSE by pressing the Start/Pause button;
- press the Delay Start button once, the light relevant to the selected delay goes off.
- press the Start/Pause button again to start the programme.



### Important!

- The selected delay can be changed only after selecting the washing programme again.
- The door will be locked throughout the delay time. If you need to open the door, you must first set the washing machine to PAUSE by pressing the Start/Pause button and then wait about 2 minutes.

After you have closed the door, press the Start/Pause button again.

- The Delay Start **can not** be selected with **Drain**  programme.

## Programme progress display

-  Washing
-  Door Lock
-  End

After having pressed the Start/Pause button, the **“Washing  ”** pilot lights comes on.

When the pilot light “washing” comes on this means that the machine is performing the washing cycle.

The **“Door Lock  ”** pilot light indicates if the door can be opened:

- on: the door cannot be opened. The appliance is running.
- light off: the door can be opened. The washing programme is finished.
- flashing light: the door is opening.

When the programme has finished, the **“End  ”** pilot light comes on.

## Altering an option or a running programme

It is possible to change any option before the programme carries it out.

Changing a running programme is possible **only by resetting it**. Turn the programme selector dial to **“O”** and then to the new programme position. The washing water in the tub not be emptied out. Start the new programme by depressing the **“Start/Pause”** button again.

## Interrupting a programme

Depress the **“Start/Pause”** button to interrupt a programme which is running, the corresponding light starts to flash. Depress the button again to restart the programme.

## Cancelling a programme

Turn the selector dial to **“O”** to cancel a programme which is running. Now you can select a new programme.



## Opening the door after the programme has started

First set the machine to pause by pressing the **“Start/Pause”** button. If the **“Door Lock →”** light flashes and after 3 minutes goes off, the door can be opened.

If the **“Door Lock →”** light does not switch off, this means that the machine is already heating, that the water level is above the bottom edge of the door or that the drum is turning. In this case the door can not be opened.

If you can not open the door but you need to open it you have to switch the machine off by turning the selector dial to **“O”**. After about 3 minutes the door can be opened (**pay attention to the water level and temperature!**).

## At the end of the programme

The machine stops automatically. If the **Rinse Hold**  or **No Spin**  option has been selected, the phase lights **“End →|”** and **“Door Lock →”** illuminate, the **“Start/Pause”** light goes off and the door remains locked to indicate that the water must be emptied out before opening the door.

## To empty out the water please read the steps on the Rinse Hold option paragraph.

Turn the programme selector dial to **“O”** to switch the machine off. Remove the laundry from the drum and carefully check that the drum is empty. If you do not intend to carry out another wash, close the water tap. Leave the door open to prevent the formation of mildew and unpleasant smells.

## Washing hints



### Sorting the laundry

Follow the wash code symbols on each garment label and the manufacturer's washing instructions. Sort the laundry as follows: whites, coloureds, synthetics, delicates, woollens.

### Temperatures

<b>90°C</b>	for normally soiled white cottons and linen (e.g. tea cloths, towels, tablecloths, sheets...).
<b>40°C 60°C</b>	for normally soiled, colour fast garments (e.g. shirts, night dresses, pyjamas....) in linen, cotton or synthetic fibres and for lightly soiled white cotton (e.g. underwear).
<b>Cold 30°C</b>	for delicate items (e.g. net curtains), mixed laundry including synthetic fibres and woollens bearing the label pure new wool, machine washable, non-shrink.

### Before loading the laundry

Never wash whites and coloureds together. Whites may lose their "whiteness" in the wash.

New coloured items may run in the first wash; they should therefore be washed separately the first time.

### Make sure that no metal objects are left in the laundry (e.g. hair clips, safety pins, pins).

Button up pillowcases, close zip fasteners, hooks and poppers. Tie any belts or long tapes.

Remove persistent stains before washing.

Rub particularly soiled areas with a special detergent or detergent paste. Treat curtains with special care. Remove hooks or tie them up in a bag or net.

### Maximum loads

Recommended loads are indicated in the programme charts. General rules:

<b>Cotton, linen:</b>	drum full but not too tightly packed;
<b>Synthetics:</b>	drum no more than half full;
<b>Delicate fabrics and woollens:</b>	drum no more than one third full.

Washing a maximum load makes the most efficient use of water and energy. For heavily soiled laundry, reduce the load size.

### Laundry weights

The following weights are indicative:

bathrobe	1200 g
napkin	100 g
quilt cover	700 g
sheet	500 g
pillow case	200 g
tablecloth	250 g
towels	200 g
tea cloth	100 g
night dress	200 g
ladies' briefs	100 g
man's work shirt	600 g
man's shirt	200 g
man's pyjamas	500 g
blouse	100 g
men's underpants	100 g

## Removing stains

Stubborn stains may not be removed by just water and detergent. It is therefore advisable to treat them prior to washing.

**Blood:** treat fresh stains with cold water. For dried stains, soak overnight in water with a special detergent then rub in the soap and water.

**Oil based paint:** moisten with benzene stain remover, lay the garment on a soft cloth and dab the stain; treat several times.

**Dried grease stains:** moisten with turpentine, lay the garment on a soft surface and dab the stain with the fingertips and a cotton cloth.

**Rust:** oxalic acid dissolved in hot water or a rust removing product used cold. Be careful with rust stains which are not recent since the cellulose structure will already have been damaged and the fabric tends to hole.

**Mould stains:** treat with bleach, rinse well (whites and fast coloureds only).

**Grass:** soap lightly and treat with bleach (whites and fast coloureds only).

**Ball point pen and glue:** moisten with acetone (\*), lay the garment on a soft cloth and dab the stain.

**Lipstick:** moisten with acetone (\*) as above, then treat stains with methylated spirits. Remove any residual marks from white fabrics with bleach.

**Red wine:** soak in water and detergent, rinse and treat with acetic or citric acid, then rinse. Treat any residual marks with bleach.

**Ink:** depending on the type of ink, moisten the fabric first with acetone (\*), then with acetic acid; treat any residual marks on white fabrics with bleach and then rinse thoroughly.

**Tar stains:** first treat with stain remover, methylated spirits or benzene, then rub with detergent paste.

(\*) do not use acetone on artificial silk.

## Detergents and additives

Good washing results also depend on the choice of detergent and use of the correct quantities to avoid waste and protect the environment. Although biodegradable, detergents contain substances which, in large quantities, can upset the delicate balance of nature.

The choice of detergent will depend on the type of fabric (delicates, woollens, cottons, etc.), the colour, washing temperature and degree of soiling.

Only low suds Front load washer detergents should be used in this appliance:

- powder detergents for all types of fabric.
- powder detergents for delicate fabrics (60 °C max) and woollens,
- liquid detergents, preferably for low temperature wash programmes (60 °C max) for all types of fabric, or special for woollens only.

The detergent and any additives must be placed in the appropriate compartments of the dispenser drawer before starting the wash programme.

If using concentrated powder or liquid detergents, a programme **without** prewash must be selected.

Pour liquid detergent into the dispenser drawer compartment marked  **just before** starting the programme.

Any fabric softener or starching additives must be poured into the compartment marked  before starting the wash programme.

Follow the product manufacturer's recommendations on quantities to use and **do not exceed the MAX mark in the detergent dispenser drawer.**

### Quantity of detergent to be used

The type and quantity of detergent will depend on the type of fabric, load size, degree of soiling and hardness of the water used.

Water hardness is classified in so-called "degrees" of hardness.

Information on hardness of the water in your area can be obtained from the relevant water supply company, or from your local authority.













Follow the product manufacturers' instructions on quantities to use.



Use less detergent if:





- you are washing a small load,
- the laundry is lightly soiled,
- large amounts of foam form during washing

**i International wash code symbols**







These symbols appear on fabric labels, in order to help you choose the best way to treat your laundry.

<p><b>Energetic wash</b></p>   <p><b>Delicate wash</b></p>	 <p>Max.wash temperature 95 °C</p>	 <p>Max.wash temperature 60 °C</p> 	 <p>Max.wash temperature 40 °C</p>  	 <p>Max.wash temperature 30 °C</p> 	 <p>Hand wash</p>	 <p>Do not wash at all</p>
---	---	---	---	---	--	--

 <p><b>Bleaching</b></p>	 <p>Bleach in cold water</p>	 <p>Do not bleach</p>
---	---	--

 <p><b>Ironing</b></p>	 <p>Hot iron max 200 °C</p>	 <p>Warm iron max 150 °C</p>	 <p>Lukewarm iron max 110 °C</p>	 <p>Do not iron</p>
---	--	---	---	--















 <p><b>Dry cleaning</b></p>	 <p>Dry cleaning in all solvents</p>	 <p>Dry cleaning in perchlorethylene, petrol, pure alcohol, R 111 &amp; R 113</p>	 <p>Dry cleaning in petrol, pure alcohol and R 113</p>	 <p>Do not dry clean</p>
--	---	--	---	---

 <p><b>Drying</b></p>	 <p>Flat</p>	 <p>On the line</p>	 <p>On clothes hanger</p>	 <p>high temperature</p>  <p>low temperature</p> <p>Tumble dry</p>	 <p>Do not tumble dry</p>
--	---	--	--	--	--



































































































## Programme information



 <b>Cottons</b>	<p>Washing programme for white and coloured cottons fabrics.</p>
 <b>Synthetics</b>	<p>Washing programme for synthetic or mixed fabrics.</p>
 <b>Delicates</b>	<p>Washing programme for delicate fabrics.</p>
 <b>Hand Wash 30°</b>	<p>Special programme for articles of clothing whose label indicates that they must be hand-washed .</p>
 <b>Hand Wash Cold</b>	<p>When you select this programme, you obtain a particularly delicate washing, suitable for articles of clothing whose label indicates that they must be hand-washed .</p>
 <b>Rinse</b>	<p>With this programme it is possible to rinse and spin cotton garments which have been washed by hand. The machine performs 3 rinses, followed by a final spin at maximum speed. The spin speed can be reduced by pressing Spin button.</p>
 <b>Drain</b>	<p>For emptying out the water of the last rinse in programmes with the Rinse Hold  option. Turn first the programme selector dial to <b>0</b>, then select programme  Drain and press the Start/Pause button.</p>
 <b>Spin</b>	<p>Separate spin for hand washed garments and after programmes with Rinse Hold  option. Before selecting this programme the selector dial must be turned to <b>0</b>. You can choose the speed by means of the relevant button to adapt it to the fabrics to be spun.</p>
 <b>Cancelling/ OFF</b>	<p>To reset a programme and to switch off the machine turn the selector dial to <b>0</b>. Now, a new programme can be selected.</p>

## Washing programmes

Programme/ Temperature	Type of laundry	Description of programme	Options	Max. Load	
				EFW 85661	EFW 85761
 Cottons 90 °C	White cotton(heavy soiled cotton items): e.g. sheets, tablecloths, household linen.	- Main wash at 90 °C - Rinses - Long spin	Spin Red./        	6.5 kg	7.0 kg
 Cottons 60 °C	Fast coloured cottons, normally soiled items, shirts, underwear, towels.	- Main wash at 60 °C - Rinses - Long spin	Spin Red./        	6.5 kg	7.0 kg
 Cottons 40 °C	Non fast coloured cottonlightly soiled, shirts, blouses, underwear.	- Main wash at 40 °C - Rinses - Long spin	Spin Red./        	6.5 kg	7.0 kg
 Cottons Cold	Non fast coloured cotton lightly soiled, dirty use cloths.	- Main wash at cold - Rinses - Long spin	Spin Red./        	6.5 kg	7.0 kg
 Synthetics 60 °C	Synthetic or mixed fabrics, underwear, coloured garments, non-shrink shirts, blouses.	- Main wash at 60 °C - Rinses - Short spin	Spin Red./        	2.0 kg	2.5 kg
 Synthetics 40 °C		- Main wash at 40 °C - Rinses - Short spin	Spin Red./        		
 Synthetics Cold	Synthetic or mixed fabrics, delicate items.	- Main wash at cold - Rinses - Short spin	Spin Red./        	2.0 kg	2.5 kg
 Delicates 40 °C	Delicate fabrics, for example curtains.	- Main wash at 40 °C - Rinses - Short spin	Spin Red.(max 650)/        	2.0 kg	2.5 kg
 Delicates Cold		- Main wash at cold - Rinses - Short spin	Spin Red.(max 650)/        	2.0 kg	2.5 kg

Programme/ Temperature	Type of laundry	Description of programme	Options	Max. Load	
				EFW 85661	EFW 85761
 Hand Wash 30 °C	Special programme for hand washing fabrics.	- Main wash at 30 °C - Rinses - Short spin	Spin Red./   	1.0 kg	2.0 kg
 Hand Wash Cold	Special programme for hand washing delicates cloths, hand curcheif.	- Main wash at cold - Rinses - Short spin	Spin Red./   	1.0 kg	2.0 kg
 Rinse	Separate rinse cycle for hand washed items of cottons.	- Rinses - Long spin	Spin Red./   	6.5 kg	7.0 kg
 Drain	For emptying out the last rinse water in programmes with the Rinse Hold.	- Draining of water		6.5 kg	7.0 kg
 Spin	Separate spin for cottons.	- Drain - Short spin	Spin Red./ 	6.5 kg	7.0 kg

\* Cottons 60 °C programme with Eco option selected is recommended for a full load of normally soiled cottons, and is the water and energy rating label programme (in accordance with TIS11462 (IEC 60456 4th edition)).

## Care and cleaning



You must **DISCONNECT** the appliance from the electricity supply, before you can carry out any cleaning or maintenance work.

### Descaling

The water we use normally contains lime. It is a good idea to periodically use a water softening powder in the machine. Do this separately from any laundry washing, and according to the softening powder manufacturer's instructions. This will help to prevent the formation of lime deposits.

### After each wash

Leave the door open for a while. This helps to prevent mould and stagnant smells forming inside the appliance. Keeping the door open after a wash will also help to preserve the door seal.

### Maintenance Wash

With the use of low temperature washes it is possible to get a build up of residues inside the drum.

We recommend that a maintenance wash be performed on a regular basis.

To run a maintenance wash:

- The drum should be empty of laundry.
- Select the hottest cotton wash programme.
- Use a normal measure of detergent, must be a powder with biological properties.

### External cleaning

Clean the exterior cabinet of the appliance with soap and water only, and then dry thoroughly.

### Cleaning the dispenser drawer

The washing powder and additive dispenser drawer should be cleaned regularly.

Remove the drawer by pressing the catch downwards and by pulling it out. Flush it out under a tap, to remove any traces of accumulated powder.

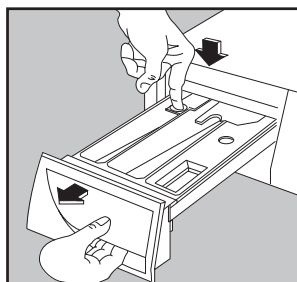

To aid cleaning, the top part of the additive compartment should be removed.

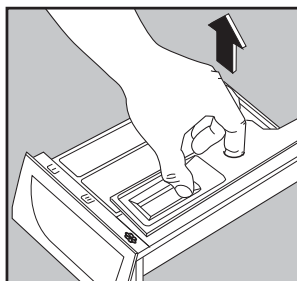

### Cleaning the drawer recess

Having removed the drawer, use a small brush to clean the recess, ensuring that all washing powder residue is removed from the upper and lower part of the recess.

Replace the drawer and run the rinse programme without any clothes in the drum.

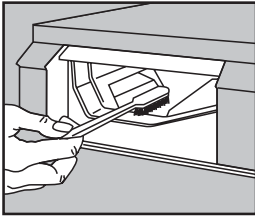

### Cleaning the drain filter

Drain filter permits to hold fluff or foreign bodies left unawares in the laundry.

The pump must be cleaned regularly. To clean the filter, proceed as follows:

- Turn programme selector dial to position Off.
- Unplug the appliance.
- Open the door.
- Turn the drum and align the filter cover (FILTER) with the arrow on the door seal.

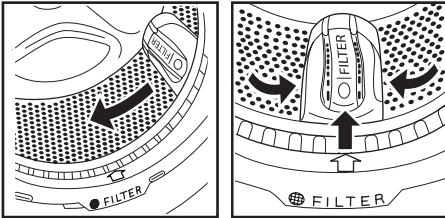

- Open the filter cover by pressing the special hook and by rotating the cover upwards.

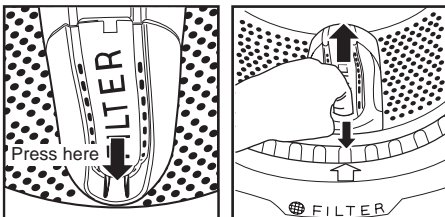

- Hold filter securely and pull upwards to remove it from its position.

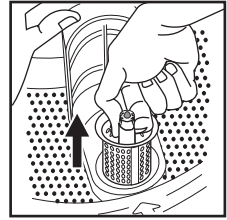

- Remove eliminate the eventual fluff or small objects around the filter.

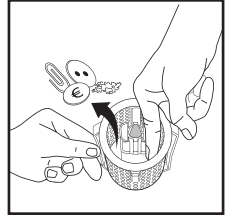

- Clean the filter under the water tap.

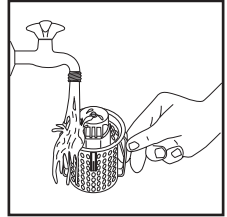

- After cleaning the filter, open the filter cover and insert the filter back to its position.

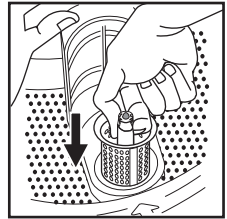

### Important!

The filter is inserted correctly when the indicator on this top is visible and you will hear “Click” sound.

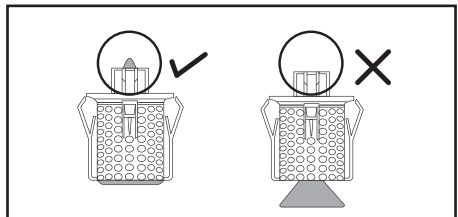

- close the filter cover.

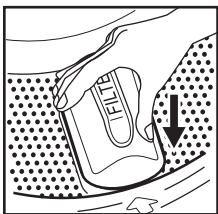

- insert the mains plug again.



**Do not start washing clothes without the filter in its place.**

## **Cleaning the water inlet filter**

If your water is very hard or contains traces of lime deposit, the water inlet filter may become clogged.

It is therefore a good idea to clean it from time to time.

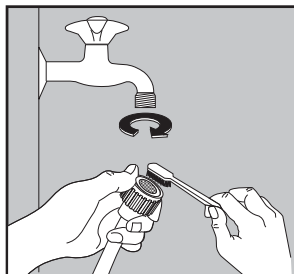

Turn off the water tap. Unscrew the water inlet hose. Clean the filter using a hard bristle brush. Tighten up the inlet hose.



## Something not working

Certain problems are due to lack of simple maintenance or oversights, which can be solved easily without calling out an engineer. Before contacting your local Service Centre, please carry out the checks listed below.

During machine operation it is possible that the **red** Start/Pause pilot light flashes to indicate that the machine is not working.

Once the problem has been eliminated, press the **Start/Pause** button to restart the programme. If after all checks, the problem persists, contact your local Service Centre.

Malfunction	Possible cause	Solution
The washing machine does not start:	<ul style="list-style-type: none"> <li>The door has not been closed. <b>(Red Start/Pause pilot light flashes).</b></li> </ul>	<ul style="list-style-type: none"> <li>Close firmly the door.</li> </ul>
	<ul style="list-style-type: none"> <li>The plug is not properly inserted in the power socket.</li> </ul>	<ul style="list-style-type: none"> <li>Insert the plug into the power socket.</li> </ul>
	<ul style="list-style-type: none"> <li>There is no power at the socket.</li> </ul>	<ul style="list-style-type: none"> <li>Please check your domestic electrical installation.</li> </ul>
	<ul style="list-style-type: none"> <li>The selector dial is not correctly positioned and the Start/Pause button has not been depressed.</li> </ul>	<ul style="list-style-type: none"> <li>Please turn the selector dial and press the Start/Pause button again.</li> </ul>
	<ul style="list-style-type: none"> <li>The delay start has been selected.</li> </ul>	<ul style="list-style-type: none"> <li>If the laundry are to be washed immediately, cancel the delay start.</li> </ul>
The machine does not fill:	<ul style="list-style-type: none"> <li>The water tap is closed. <b>(Red Start/Pause pilot light flashes)</b></li> </ul>	<ul style="list-style-type: none"> <li>Open the water tap.</li> </ul>
	<ul style="list-style-type: none"> <li>The inlet hose is squashed or kinked. <b>(Red Start/Pause pilot light flashes)</b></li> </ul>	<ul style="list-style-type: none"> <li>Check the inlet hose connection.</li> </ul>
	<ul style="list-style-type: none"> <li>The filter in the inlet hose is blocked. <b>(Red Start/Pause pilot light flashes)</b></li> </ul>	<ul style="list-style-type: none"> <li>Clean the water inlet hose filter.</li> </ul>
	<ul style="list-style-type: none"> <li>The door is not properly closed. <b>(Red Start/Pause pilot light flashes)</b></li> </ul>	<ul style="list-style-type: none"> <li>Close firmly the door.</li> </ul>
The machine fills then empties immediately:	<ul style="list-style-type: none"> <li>The end of the drain hose is too low.</li> </ul>	<ul style="list-style-type: none"> <li>Refer to relevant paragraph in "water drainage" section.</li> </ul>

Malfunction	Possible cause	Solution
The machine does not empty and/or does not spin:	<ul style="list-style-type: none"> <li>The drain hose is squashed or kinked. <b>(Red Start/Pause pilot light flashes)</b></li> </ul>	<ul style="list-style-type: none"> <li>Check the drain hose connection.</li> </ul>
	<ul style="list-style-type: none"> <li>The drain pump is clogged. <b>(Red Start/Pause pilot light flashes)</b></li> </ul>	<ul style="list-style-type: none"> <li>Clean the drain filter.</li> </ul>
	<ul style="list-style-type: none"> <li>The option <input type="checkbox"/> or  has been selected.</li> </ul>	<ul style="list-style-type: none"> <li>Disable the option <input type="checkbox"/> or .</li> <li>Select spin programme.</li> </ul>
	<ul style="list-style-type: none"> <li>The laundry is not evenly distributed in the drum.</li> </ul>	<ul style="list-style-type: none"> <li>Redistribute the laundry.</li> </ul>
There is water on the floor:	<ul style="list-style-type: none"> <li>Too much detergent or unsuitable detergent (creates too much foam) has been used.</li> </ul>	<ul style="list-style-type: none"> <li>Reduce the detergent quantity or use another one.</li> </ul>
	<ul style="list-style-type: none"> <li>Check whether there are any leaks from one of the inlet hose fittings. It is not always easy to see this as the water runs down the hose; check to see if it is damp.</li> </ul>	<ul style="list-style-type: none"> <li>Check the water inlet hose connection.</li> </ul>
	<ul style="list-style-type: none"> <li>The drain hose is damaged.</li> </ul>	<ul style="list-style-type: none"> <li>Change it with a new one.</li> </ul>
Unsatisfactory washing results:	<ul style="list-style-type: none"> <li>Too little detergent or unsuitable detergent has been used.</li> </ul>	<ul style="list-style-type: none"> <li>Increase the detergent quantity or use another one.</li> </ul>
	<ul style="list-style-type: none"> <li>Stubborn stains have not been treated prior to washing.</li> </ul>	<ul style="list-style-type: none"> <li>Use commercial products to treat the stubborn stains.</li> </ul>
	<ul style="list-style-type: none"> <li>The correct temperature was not selected.</li> </ul>	<ul style="list-style-type: none"> <li>Check if you have selected the correct temperature.</li> </ul>
	<ul style="list-style-type: none"> <li>Excessive laundry load.</li> </ul>	<ul style="list-style-type: none"> <li>Introduce into the drum less laundry.</li> </ul>
The door will not open:	<ul style="list-style-type: none"> <li>The programme is still running.</li> </ul>	<ul style="list-style-type: none"> <li>Wait the end of washing cycle.</li> </ul>
	<ul style="list-style-type: none"> <li>The door lock has not been released.</li> </ul>	<ul style="list-style-type: none"> <li>Wait about 3 minute.</li> </ul>
	<ul style="list-style-type: none"> <li>There is water in the drum.</li> </ul>	<ul style="list-style-type: none"> <li>Select drain or spin programme to empty out the water.</li> </ul>



Malfunction	Possible cause	Solution
<p>The machine vibrates or is noisy:</p>	<ul style="list-style-type: none"> <li>• The transit bolts and packing have not been removed.</li> </ul>	<ul style="list-style-type: none"> <li>• Check the correct installation of the appliance.</li> </ul>
	<ul style="list-style-type: none"> <li>• The support feet have not been adjusted.</li> </ul>	<ul style="list-style-type: none"> <li>• Check the correct levelling of the appliance.</li> </ul>
	<ul style="list-style-type: none"> <li>• The laundry is not evenly distributed in the drum.</li> </ul>	<ul style="list-style-type: none"> <li>• Redistribute the laundry.</li> </ul>
	<ul style="list-style-type: none"> <li>• Maybe there is very little laundry in the drum.</li> </ul>	<ul style="list-style-type: none"> <li>• Load more laundry.</li> </ul>
	<ul style="list-style-type: none"> <li>• unstable floors eg. wooden floors</li> </ul>	
<p>Spinning starts late or the machine does not spin:</p>	<ul style="list-style-type: none"> <li>• The electronic unbalance detection device has cut in because the laundry is not evenly distributed in the drum. The laundry is redistributed by reverse rotation of the drum. This may happen several times before the unbalance disappears and normal spinning can resume. If, after 10 minutes, the laundry is still not evenly distributed in the drum, the machine will not spin. In this case, redistribute the load manually and select the spin programme.</li> </ul>	<ul style="list-style-type: none"> <li>• Redistribute the laundry.</li> </ul>
<p>The machine makes an unusual noise:</p>	<ul style="list-style-type: none"> <li>• The machine is fitted with a type of motor which makes an unusual noise compared with other traditional motors. This new motor ensures a softer start and more even distribution of the laundry in the drum when spinning, as well as increased stability of the machine.</li> </ul>	
<p>No water is visible in the drum:</p>	<ul style="list-style-type: none"> <li>• Machines based on modern technology operate very economically using very little water without affecting performance.</li> </ul>	

## 28 electrolux **something not working**

If you are unable to identify or solve the problem, contact our service centre. Before telephoning, make a note of the model, serial number and purchase date of your machine: the Service Centre will require this information.

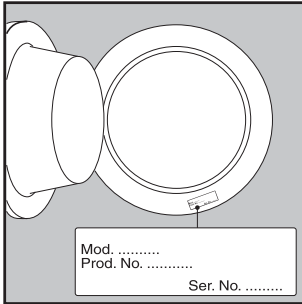

## Technical data

		EWF 85761	EWF 85661
Dimensions	Width	60 cm	60 cm
	Height	85 cm	85 cm
	Depth	65 cm	54 cm
Power supply voltage/frequency		220-240 V/50 Hz	
Total power absorbed		2000 W	
Minimum fuse protection		10A	
Water supply pressure	Minimum	0,05 MPa	
	Maximum	0,8 MPa	
Maximum Load	Cottons	(EWF 85761)	7 kg
		(EWF 85661)	6.5 kg
	Synthetics	(EWF 85761)	2.5 kg
		(EWF 85661)	2 kg
Delicates	(EWF 85761)	2.5 kg	
	(EWF 85661)	2 kg	
Hand Wash	(EWF 85761)	2 kg	
	(EWF 85661)	1 kg	
Spin Speed	Maximum (EWF 85761, EWF 85661)	850 rpm	



## Installation



### Unpacking

All transit bolts and packing must be removed before using the appliance.

You are advised to keep all transit devices so that they can be refitted if the machine ever has to be transported again.

1. Using a spanner, unscrew and remove the two rear bottom screws.

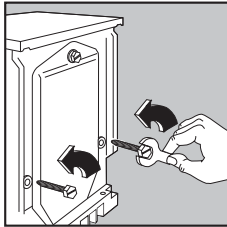

2. Slide out the two plastic pins.

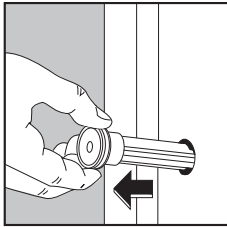

3. Lay the machine on its back ensuring that the hoses are not crushed.

Place one of the polyethylene angle packings under the machine.

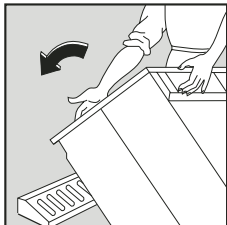

4. Remove the polystyrene block(s) protecting the motor

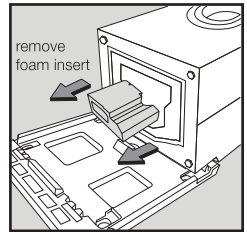

5. Very carefully slide out the polythene bag, removing it towards the downwards, then pull it out. **(If any)**

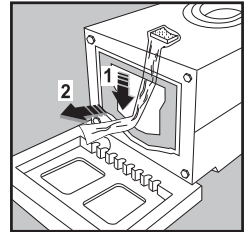

6. With the machine laid on it's back and place the bottom cover as marked in position A, Then push the other end of the cover as directed to close the bottom of washing machine (This is available in selected models only).

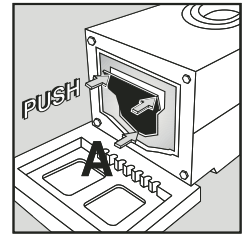

7. Set the machine upright and unscrew the remaining rear screw.

8. Slide out the relevant pin. Cover all the open holes with plugs which are provided with the Instruction booklet.

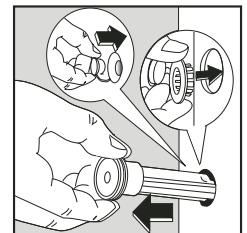

## Positioning

Install the machine on a flat hard floor. Make sure that air circulation around the machine is not impeded by carpets, rugs etc. Check that the machine does not touch the wall or cupboard units.

Carefully level by screwing the adjustable feet in or out.

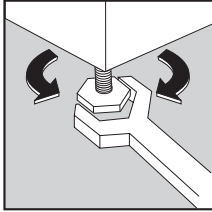

Never place cardboard, wood or similar materials under the machine to compensate for any unevenness in the floor.

## Water inlet

Connect the water inlet hose to a tap with 3/4" BSP thread.

Use the hose supplied with the washing machine. **DO NOT USE OLD HOSES.**

The other end of the inlet hose which connects to the machine can be turned in any direction.

Simply loosen the fitting, rotate the hose and retighten the fitting, making sure there are no water leaks.

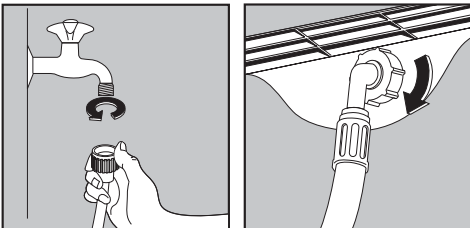

The inlet hose must not be lengthened. If it is too short and you do not wish to move the tap, you will have to purchase a new, longer hose specially designed for this type of use.

## Water drainage

The end of the drain hose can be positioned in three ways:

### Hooked over the edge of a sink using the plastic hose guide supplied with the machine.

In this case, make sure the end cannot come unhooked when the machine is emptying.

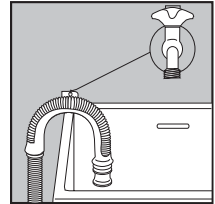

This could be done by tying it to the tap with a piece of string or attaching it to the wall.

**In a sink drain pipe branch.** This branch must be above the trap so that the bend is at least 60 cm above the ground.

**Directly into a drain pipe at a height** of not less than 60 cm and not more than 90 cm.

The end of the drain hose must always be ventilated, i.e. the inside diameter of the drain pipe must be larger than the outside diameter of the drain hose.

The drain hose must not be kinked. Run it along the floor; only the part near the drainage point must be raised.

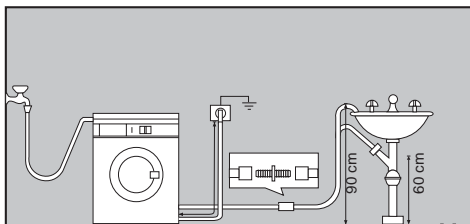

**For the correct functioning of the machine the drain hose must remain hooked on the proper support piece situated on the top part of back side of the appliance.**

## Electrical Connection

This machine is designed to operate on a 220-240 V, single-phase, 50 Hz supply.

Check that your domestic electrical installation can take the maximum load required (2.0 kW), also taking into account any other appliances in use.



### **Connect the machine to an earthed socket.**

The manufacturer declines any responsibility for damage or injury through failure to comply with the above safety precaution. Should the appliance power supply cable need to be replaced, this should be carried out by our Service Centre.



Please ensure that when the appliance is installed the power supply cable is easily accessible.

## Environment concerns

### Packaging materials



The materials marked with the symbol  are recyclable.

>PE<=polyethylene

>PS<=polystyrene

>PP<=polypropylene

This means that they can be recycled by disposing of them properly in appropriate collection containers.

### Old machine

Use authorised disposal sites for your old appliance. Help to keep your country tidy!

The symbol  on the product or on its packaging indicates that this product may not be treated as household waste.

Instead it shall be handed over to the applicable collection point for the recycling of electrical and electronic equipment. By ensuring this product is disposed of correctly, you will help prevent potential negative consequences for the environment and human health, which could otherwise be caused by inappropriate waste handling of this product. For more detailed information about recycling of this product, please contact your local city office, your household waste disposal service or the shop where you purchased the product.

### Ecological hints



To save water, energy and to help protect the environment, we recommend that you follow these tips:

- Normally soiled laundry may be washed without prewashing in order to save detergent, water and time (the environment is protected too!).
- The machine works more economically if it is fully loaded.
- With adequate pre-treatment, stains and limited soiling can be removed; the laundry can then be washed at a lower temperature.
- Measure out detergent according to the water hardness, the degree of soiling and the quantity of laundry being washed.