

**PowerLite® Home Cinema 3010/3010e
Home Theater Projector**

User's Guide

Contents

Introduction	6
Projector Parts	7
Remote Control	9
Optional Accessories	10
Registration and Warranty	10
Using This Manual	11
Setting Up the Projector	12
Choose a Location	12
Installing the Projector	16
Connecting the Cables	18
Connecting Video and Computer Equipment	18
Making Other Connections	20
Installing Batteries in the Remote Control	21
Turning the Projector On and Off	21
Turning On the Projector	21
Turning Off the Projector	22
Selecting the Image Source	22
Positioning the Image	24
Making Basic Adjustments	26
Focusing and Zooming	26
Choosing the Aspect Ratio	27
Viewing 3D images	28
Projecting in Split Screen mode	29
Starting a Slideshow	30
Choosing Slideshow Options	31
Choosing the Color Mode	32

Advanced Color Adjustments	33
Adjusting the Gamma Setting	33
Adjusting RGBCMY	35
Locking the Projector	36

Making Detailed Adjustments **37**

Using the Menu System	37
Changing How the Menus Display	38
Adjusting the Picture Quality	39
Input Brightness Settings	39
Sharpness and Picture Quality Settings	41
Color Settings	43
3D Setup	45
Adjustments for Computer Images	46
WirelessHD Settings	47
Split Screen Setup	48
Selecting Memory Settings and Resetting the Projector	49
Creating Memory Settings	49
Selecting Memory Settings	50
Renaming Memory Settings	50
Deleting Saved Memory Settings	51
Resetting the Projector	51
Customizing Projector Features	52
Image Sizing	52
Screen Options	53
Other Setup Options	54

Using WirelessHD **56**

Placing the WirelessHD Transmitter	56
Setting Up a WirelessHD Connection	57

Using HDMI Link **58**

Setting Up HDMI Link	58
----------------------	-----------

Changing HDMI Link Settings	59
Maintenance	60
Cleaning the Lens	60
Cleaning the 3D Glasses	61
Cleaning the Projector Case	61
Cleaning and Replacing the Air Filter	62
Replacing the Lamp	64
Resetting the Lamp Usage Timer	67
Checking the Projector Status	67
Storing the Projector	68
Transporting the Projector	68
Problem Solving	69
What To Do When the Lights Come On or Flash	69
Solving Picture Problems	71
Solving Remote Control Problems	75
Solving WirelessHD Problems	75
Where to Get Help	77
Specifications	78
General	78
Lamp	78
Remote Control	79
WirelessHD Transmitter (Home Cinema 3010e only)	79
Dimensions	79
Electrical	80
Environmental	80
Safety	80
Compatible Video Formats	81
ESC/VP21 Command Codes	83

Notices	84
Important Safety Information	84
FCC Compliance Statement	86
Copyright Notice	87
A Note Concerning Responsible Use of Copyrighted Materials	87
Trademarks	88

Introduction

The PowerLite® Home Cinema 3010/3010e projector lets you enjoy theater-quality 3D images in the relaxing environment of your own home. Designed especially for home cinema use, it offers these outstanding features:

- Native 1080p (1920 × 1080) resolution, dynamic contrast ratio up to 40,000:1 and up to 2200 lumens of brightness (white light output) for incredibly rich, sharp images in any room lighting
- Auto Iris system that constantly controls the light output based on the gamma and black/white levels of your projected content, for perfectly adjusted images and deepest blacks
- Epson C²Fine® 3LCD technology for reliable picture quality, increased contrast ratio and uniform colors
- 1080Perfect™ video processing for more film-like images free of noise or artifacts
- 10-bit color quality for unmatched color accuracy, with over a billion colors available
- HDMI® (High-Definition Multimedia Interface®) ports for superior, uncompressed digital video
- True 16:9 wide-format projection
- Powerful 10 W per channel stereo speaker system
- Flexible setup configurations, including front projection and ceiling mounted, with horizontal keystone slider for offset placement

Projector Parts

Front

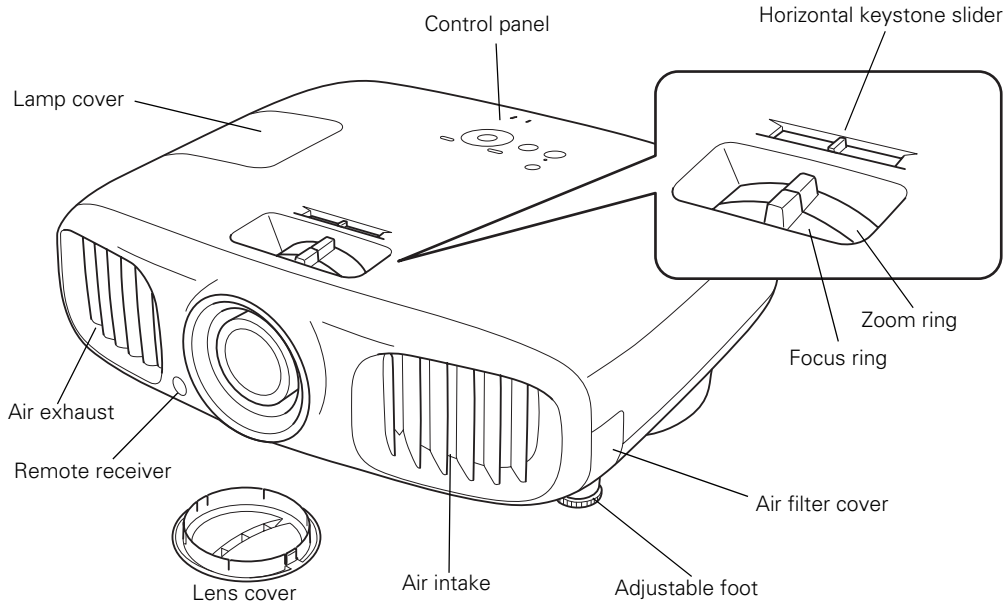

Back

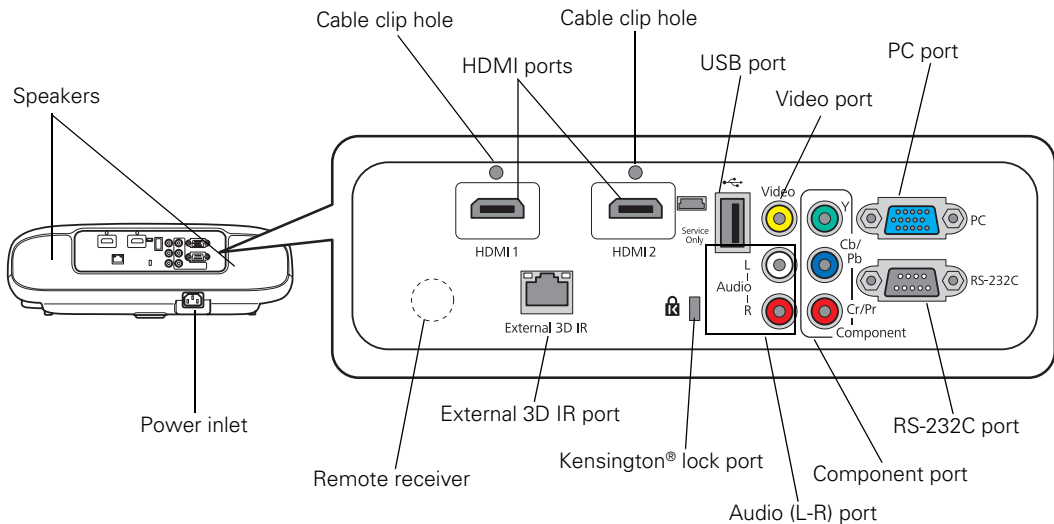

Bottom

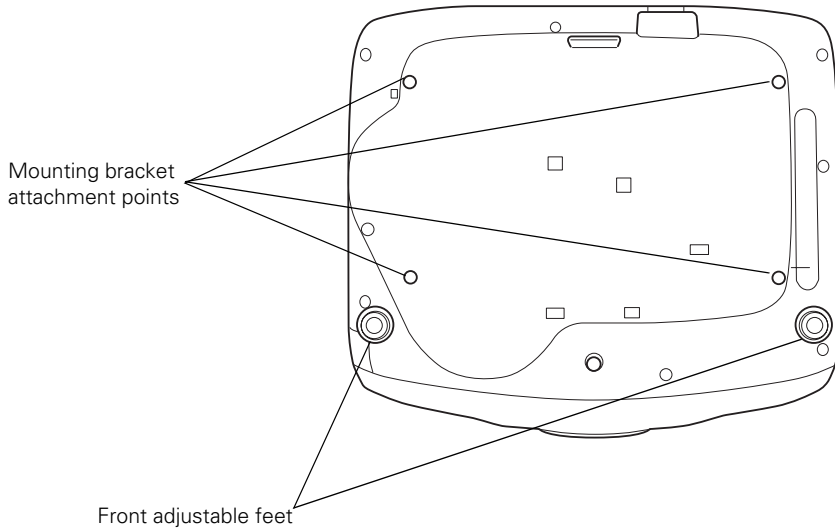

Projector Control Panel

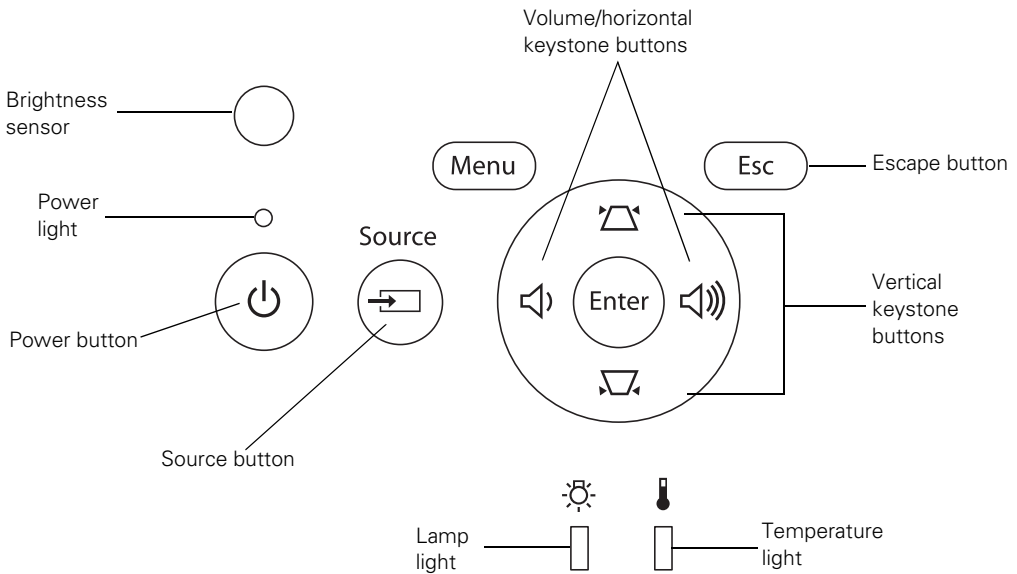

Remote Control

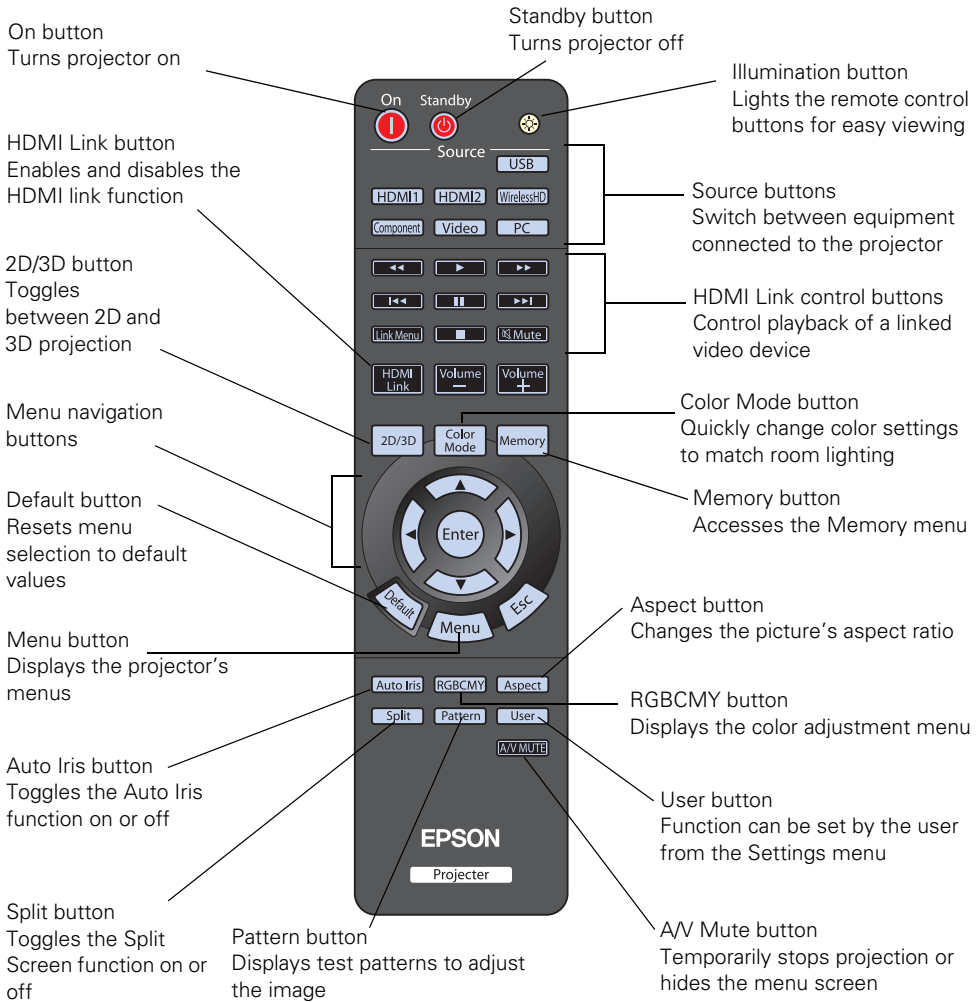

Optional Accessories

Epson provides the following optional accessories for the projector:

Product	Part number
Replacement lamp	V12H010L68
Air filter replacement	V13H134A38
Kensington security lock (anti-theft device)	ELPSL01
Projector mount	V12H003B20
Computer cable (6 feet [1.8 meters])	V12H005C02
3D active shutter glasses	V12H483001
External 3D IR emitter	V12H484001

In addition to the accessories listed above, 1-year and 2-year extended service plans are available. You can purchase these plans and other accessories from an authorized Epson reseller. To find the nearest reseller, please call 800-GO-EPSON (800-463-7766). To purchase online, visit www.epsonstore.com (U.S. sales) or www.epson.ca (Canadian sales).

Registration and Warranty

Your projector comes with a basic two-year carry-in warranty. For details, see the *Quick Setup* sheet.

In addition, Epson offers free Extra CareSM Home Service. In the unlikely event of an equipment failure, you won't have to wait for your unit to be repaired. Instead, Epson will ship you a replacement unit anywhere in the United States, Canada, or Puerto Rico. See your *Extra Care Home Service* brochure for details.

To register, simply follow the registration instructions on the CD, or register online at epson.com/webreg. Registering also lets you receive special updates on new accessories, products, and service.

Using This Manual

This book contains all the information you need to use the projector, in addition to basic setup and maintenance instructions, troubleshooting tips, important safety instructions, specifications, and warranty information.

Please follow these guidelines as you read through the manual:

Warning: Must be followed carefully to avoid bodily injury.

Caution: Must be observed to avoid damage to your equipment.

Note: Contains important information about your projector.

Tip: Contains helpful projection tips.

Need additional help? Take advantage of Epson's automated support services 24 hours a day at epson.com/support (U.S.) or epson.ca/support (Canada). Use this site to view FAQs or product information and e-mail Epson.

If you need more help, you can use the Epson PrivateLine® Support service. Call (800) 637-7661 and enter the PIN on the PrivateLine support card that came with your projector.

Setting Up the Projector

Follow the instructions in this section to choose a location for the projector, connect the cables, and display an image.

Choose a Location

You can install the projector for the viewing setups shown below, as well as rear projection.

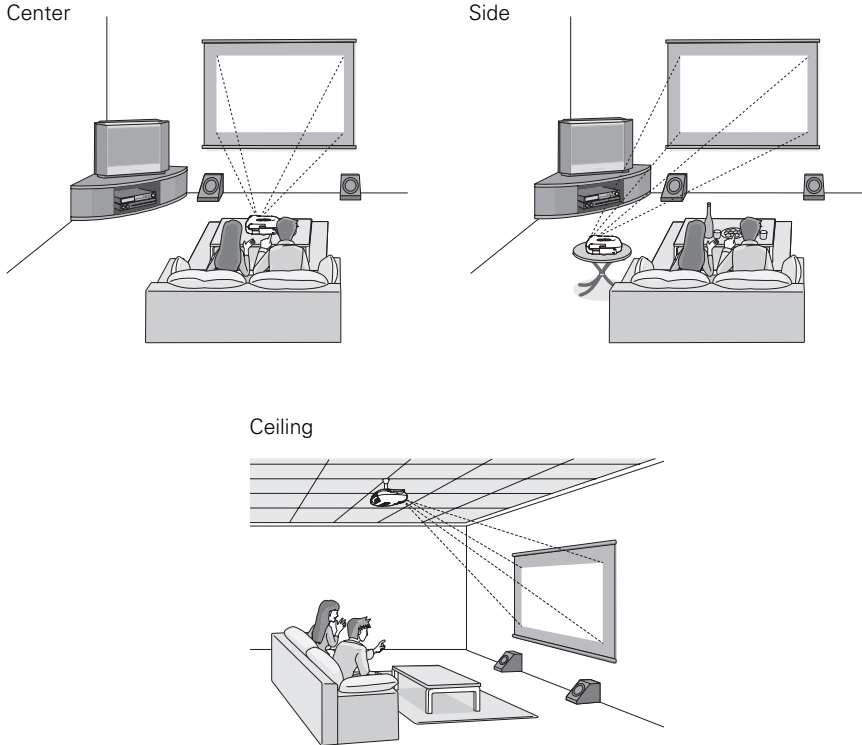

Keep the projector level and place it at a height where its lens is centered between the top and bottom of the screen. If this isn't possible, use the horizontal keystone slider and vertical keystone buttons to adjust the image (see page 24).

Note: Image quality may be reduced if excessive keystone correction is used.

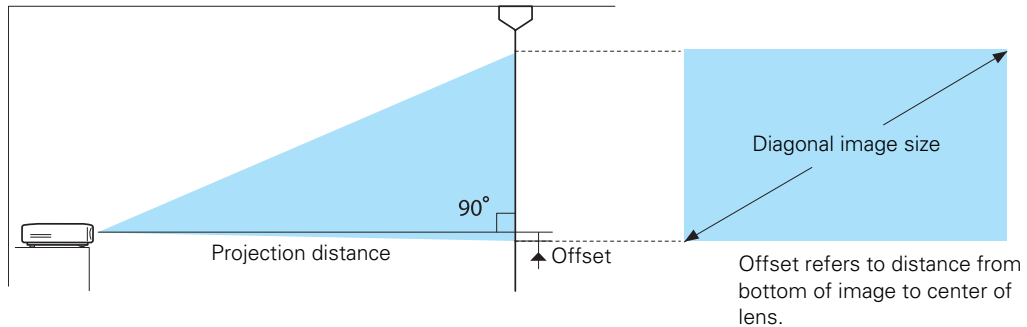

The size of the image is determined by the distance from the projector's lens to the screen. Depending on your display settings and how you use the zoom ring, the actual size may differ. Use these tables as a guide for projector placement:

16:9 aspect ratio

Projection distance	Diagonal image size (width × height)	Offset
3.8 to 6.2 feet 116 to 190 cm	40 in. (35 × 20 in.) 101.6 cm (89 × 50 cm)	0 in. (0 cm)
5.8 to 9.4 feet 176 to 287 cm	60 in. (51 × 30 in.) 152.4 cm (130 × 75 cm)	0 in. (0 cm)
7.7 to 12.6 feet 235 to 383 cm	80 in. (71 × 39 in.) 203.2 cm (180 × 100 cm)	0 in. (0 cm)
9.7 to 15.7 feet 295 to 480 cm	100 in. (87 × 47 in.) 254 cm (220 × 120 cm)	0 in. (0 cm)
11.6 to 18.9 feet 354 to 576 cm	120 in. (106 × 59 in.) 304.9 cm (270 × 150 cm)	0 in. (0 cm)
14.6 to 23.7 feet 444 to 721 cm	150 in. (130 × 75 in.) 361 cm (330 × 190 cm)	0.3 in. (1 cm)
17.5 to 28.4 feet 533 to 866 cm	180 in. (173 × 98 in.) 457 cm (440 × 250 cm)	0.3 in. (1 cm)

4:3 aspect ratio

Projection distance	Diagonal image size (width × height)	Offset
4.7 to 7.6 feet 143 to 233 cm	40 in. (32 × 24 in.) 101.6 cm (81 × 61 cm)	0 in. (0 cm)
7.1 to 11.5 feet 216 to 352 cm	60 in. (47 × 35 in.) 152.4 cm (120 × 90 cm)	0 in. (0 cm)
9.5 to 15.4 feet 289 to 470 cm	80 in. (63 × 47 in.) 203.2 cm (160 × 120 cm)	0 in. (0 cm)
11.8 to 19.3 feet 361 to 588 cm	100 in. (79 × 59 in.) 254 cm (200 × 150 cm)	0 in. (0 cm)
14.2 to 23.2 feet 434 to 706 cm	120 in. (94 × 71 in.) 304.8 cm (240 × 180 cm)	0.3 in. (1 cm)
17.8 to 29 feet 544 to 883 cm	150 in. (118 × 91 in.) 381 cm (300 × 230 cm)	0.3 in. (1 cm)
23.8 to 38.7 feet 726 to 1179 cm	200 in. (161 × 118 in.) 508 cm (410 × 300 cm)	0.3 in. (1 cm)

To determine the exact image size when you know the projection distance (or the exact projection distance when you know the desired image size), you can use the Image Size Calculator. This program is available on the Epson website at epson.com/support (U.S.) or epson.ca/support (Canada).

Also keep these considerations in mind:

- Make sure there is plenty of space for ventilation around and under the projector. Do not set the projector on top of loose materials that could block the vents underneath.
- Make sure the projector is within 9.8 feet (3 m) of a grounded electrical outlet or extension cord.

In order to view 3D images correctly, 3D glasses must be worn within proper range of the projector. Use the image below to determine the ideal distance for 3D projection (the shading represents the 3D viewing area):

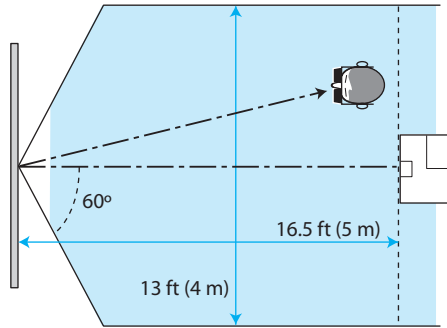

Use the optional external 3D emitter if you cannot view the 3D image normally or if the projector is located more than 16.5 feet (5 m) from the viewing area. See “Optional Accessories” on page 10 for ordering information.

Installing the Projector

To install the projector, you first need to determine the location, based on the size of your screen (maximum diagonal image size). Use the tables on page 13 as a guide to positioning the projector.

To suspend the projector from a ceiling, you will need the optional projector mount designed for the projector. See page 10 for ordering information. Follow the instructions included with the mount to install the projector.

Warning: When installing or adjusting the ceiling mount, do not use adhesives to prevent the screws from loosening and do not use any type of oil or lubricant. These may cause the projector casing to crack and the projector may fall, causing serious injury and serious damage to the projector.

If you install the projector on the ceiling, you will need to invert the picture so that it appears right side up. Follow these steps:

1. Press the **Menu** button on the remote control.
2. Open the **Settings** menu, then select **Projection**.
3. Select **Front/Ceiling**.
4. Press the **Menu** button to exit the menu system.

The following illustrations show the dimensions of the projector:

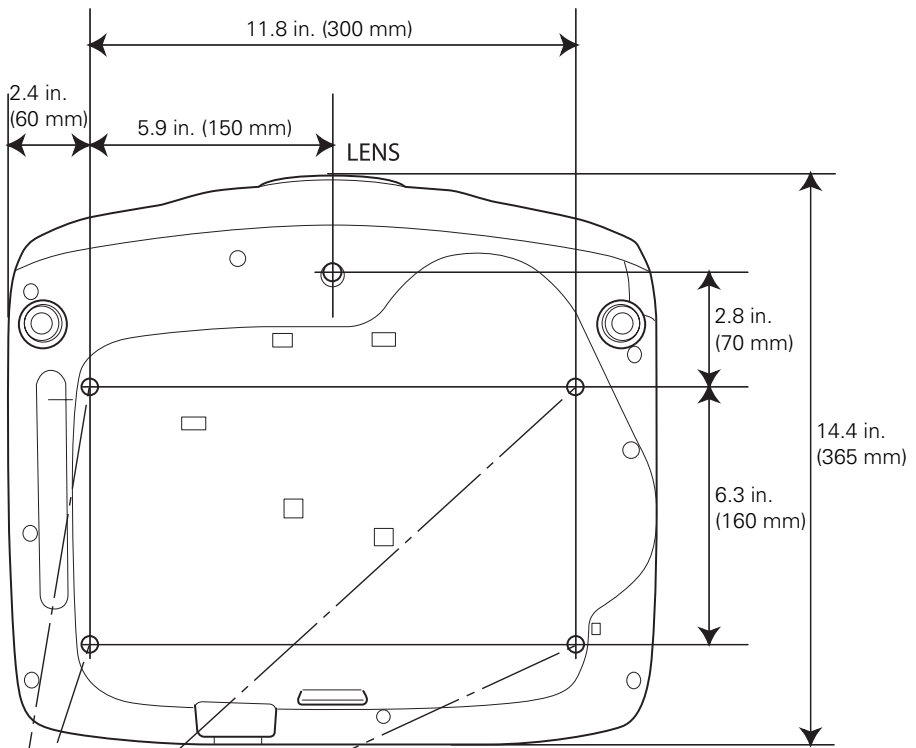
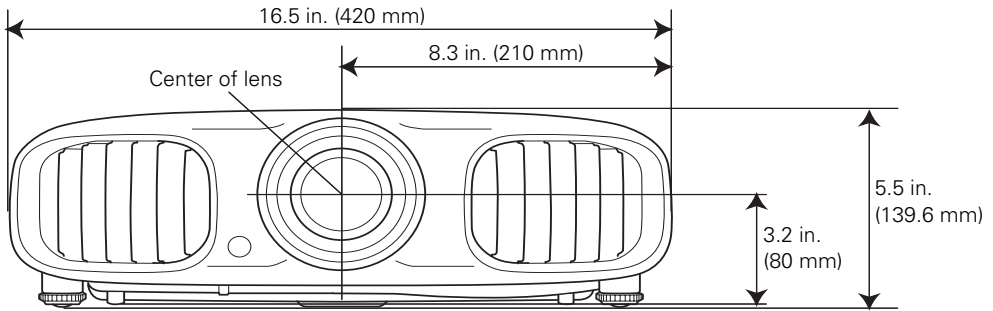

5-M4x9



Connecting the Cables



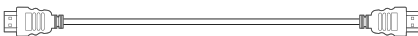
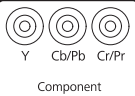

Connecting Video and Computer Equipment

You can connect the projector to many types of video equipment, such as a Blu-ray Disc™/DVD player, digital tuner, cable or satellite box, video game console, camcorder, or digital camera. You can also connect it to a desktop or laptop PC or Apple® Mac® system. For details on compatible video formats, see page 81.

You can connect up to six pieces of equipment at the same time, using any of the commercially available cables shown below:

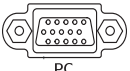
Note: See page 57 for information on connecting with WirelessHD (PowerLite Home Cinema 3010e only).

Port name	Video equipment connection	Computer connection
HDMI 1/ HDMI 2 	Use an HDMI cable: 	
Component 	Use a component video cable (with RCA-style connectors):  Connect the cable to the three component video ports. Match corresponding colors between the cable and the ports. For audio, use a stereo RCA audio cable: 	—

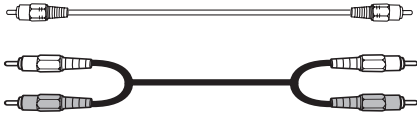
Port name	Video equipment connection	Computer connection
PC 	—	Use a Mini D-sub, 15-pin monitor cable to connect to a computer RGB (monitor) port:  For audio, use a stereo RCA to mini-jack stereo (3.5 mm) audio cable: 
Video 	Use an RCA video and audio cable: 	—

For best results, connect your video equipment to the **HDMI** port, if possible. If your equipment doesn't support HDMI, connect it to either the **Component** (for high quality, component video) or **Video** (for composite video) port.

When you connect an HDMI cable to the projector, it is recommended that you fasten it with the included cable clip. Follow these steps to install the cable clip:

1. Connect the HDMI cable to one of the HDMI ports on the projector.
2. Insert the end of the cable clip anchor into the cable clip hole near the HDMI port, as show below.

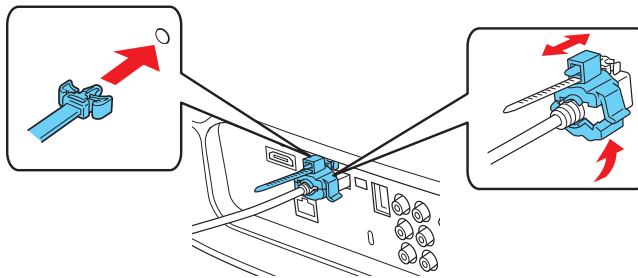

3. Place the open cable clip around the HDMI cable, but don't lock it into place.
4. Slide the cable clip towards the projector and lock the clip onto the HDMI connector.

To remove the cable clip, unlock the clip and disconnect the HDMI cable. Then pinch the side of the cable clip anchor and carefully pull it out of the cable clip hole.

Making Other Connections

Connect the power cable and other cables described below, depending on how you plan to use the projector.

- Plug the power cable into the projector and a grounded electrical outlet.

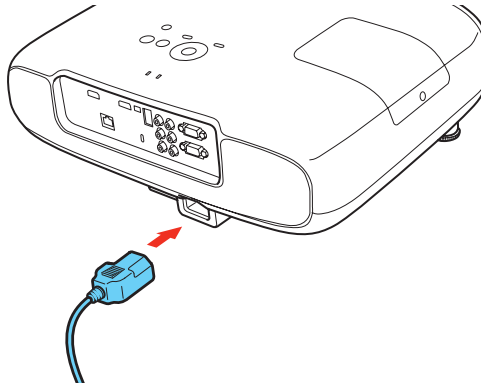

- To use an AV controller with the projector, connect a 9-pin null modem serial cable to the RS-232C port.
- To connect to a digital camera, flash drive, or storage device, connect the USB cable that came with your device to both your device and to the projector's USB port. For information on using the projector's Slideshow feature, see page 30.

Installing Batteries in the Remote Control

The remote control uses two AA batteries.

Warning: Keep batteries away from children. If a battery is swallowed, contact your doctor immediately.

1. Release the tab and lift open the cover.
2. Insert two new AA batteries as shown.
3. Insert the tab on the cover and press it down until it clicks into place.

Aim the remote control at the screen, or at the front or back of the projector. Make sure you are within 32 feet (10 meters) of the projector.

If you suspect the batteries are weak, press the  illumination button. If the buttons do not glow, replace the batteries.

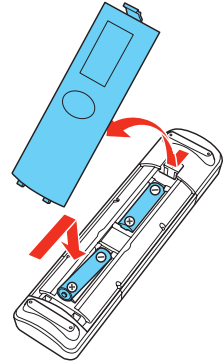

Turning the Projector On and Off

Turning On the Projector

1. Remove the lens cap.
2. Turn on any connected equipment you plan to use.
3. Press the On button on the remote control or the  power button on the projector.

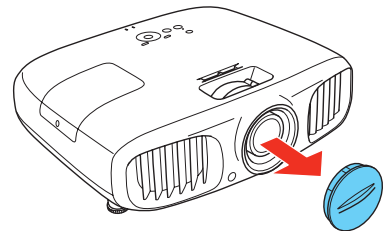

Remote control

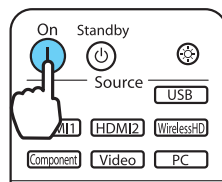

Projector

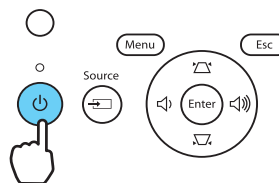

Note: To prevent children from turning on the projector, you can use the Child Lock feature. See page 36 for details.

If you'll be using the projector at an altitude above 4921 feet (1500 meters), turn on High Altitude Mode so the fan can properly cool the projector at the high altitude air pressure. See page 55 for details.

The power light flashes while the projector warms up. If you don't see a picture, you may need to change the image source as described on page 22.

Turning Off the Projector

1. Turn off any equipment connected to the projector.
2. Press the  power button on the projector twice or press the **Standby** button on the remote control and wait for the light to stop flashing.



Caution: Turn off this product when not in use to prolong the life of the projector.

Selecting the Image Source

The source buttons on the projector and remote control let you switch between images from different pieces of equipment connected to the projector (such as a Blu-ray Disc/DVD player, cable or satellite box, or video game console).

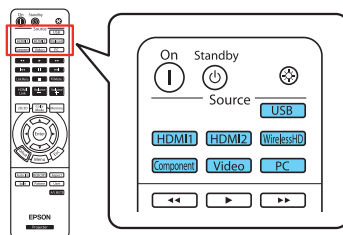
Press the **Source** button on the remote control that corresponds to the port to which your video source is connected.



If you press the  **Source** button on the projector, you see a list of available sources. Press the  **Source** button to move through the list and select the desired source.

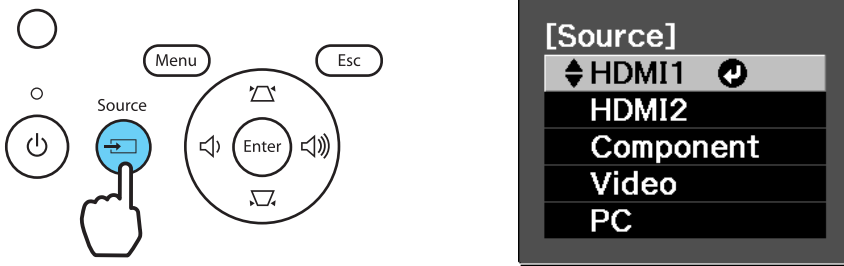

Note: If an image does not appear, see “Problem Solving” on page 69.

To temporarily turn off the image and darken the screen, press the **A/V Mute** button on the remote control. Press the **A/V Mute** button again to return to normal viewing.

Positioning the Image

If the projector is not centered in front of the screen, use the horizontal keystone slider, horizontal keystone buttons, volume buttons on the projector, and vertical keystone buttons to correct the shape of the image.

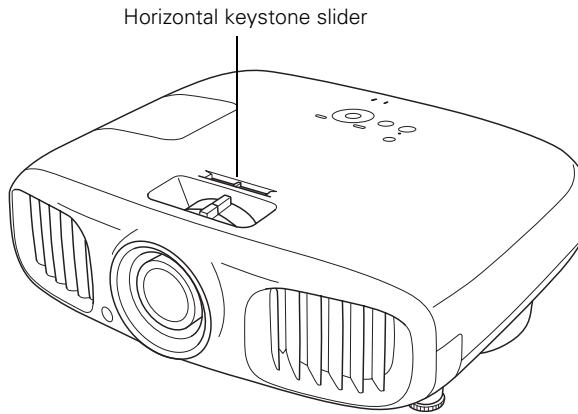

Note: You can display a test pattern to help adjust the image position by pressing the **Pattern** button on the remote control. Press the **Esc** button to turn off the test pattern.

The image can be adjusted up to 30° in either direction with the horizontal keystone slider or buttons:

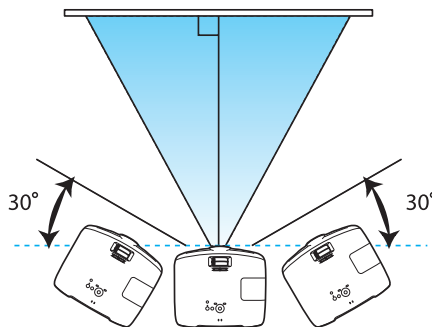

If one side of the image is taller than the other, make sure the projector is parallel to the screen. If necessary, adjust the front feet so that the projector is horizontal.

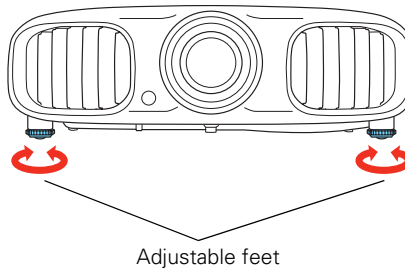

Your projector automatically adjusts images that are wider at the top or bottom, but if necessary, you can also use the vertical keystone buttons on the projector to correct this.

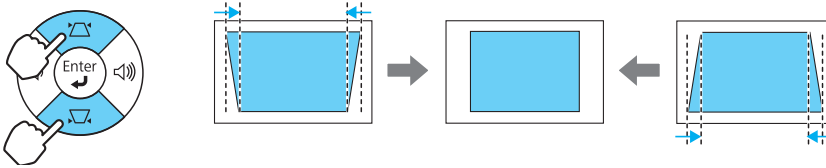

In addition to the horizontal keystone slider, you can use the volume buttons on the projector to adjust images that are wider on the left or right side.

Note: Press either of the vertical keystone buttons to open the H/V-Keystone menu before pressing the volume buttons. The volume buttons won't adjust the H-Keystone setting unless this menu is active.

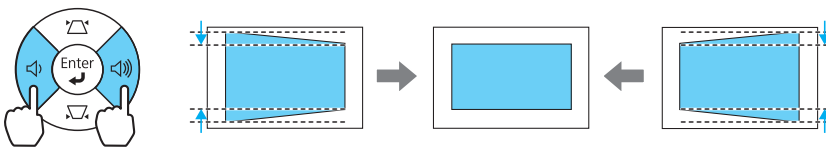

Making Basic Adjustments

Follow the instructions in this chapter to make basic adjustments to the image shape, size, color, and quality. For further refinements, see “Making Detailed Adjustments” on page 37.

Focusing and Zooming

Use the focus ring to sharpen the image.

Use the zoom ring to reduce or enlarge the image.

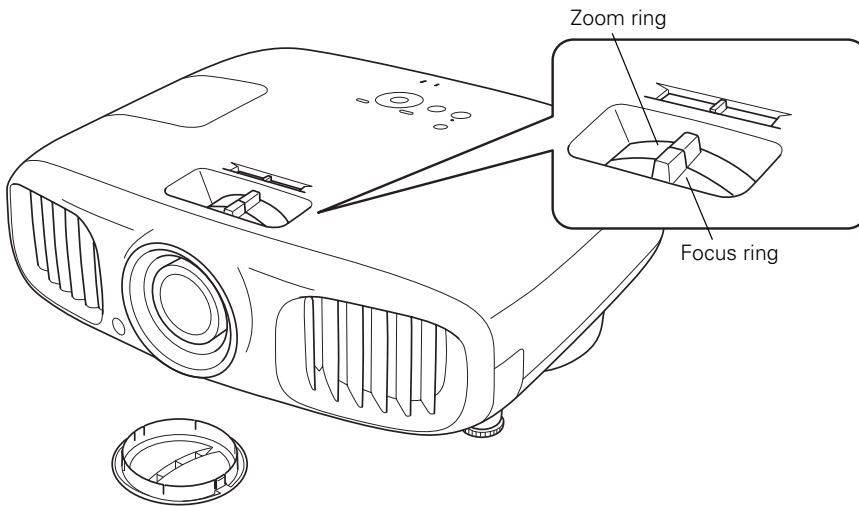

Choosing the Aspect Ratio

In many cases, video signals are automatically resized to fit on your screen when **Auto** is selected as the Aspect setting. You may need to change the size of the image (or aspect ratio) for certain image types by pressing the **Aspect** button on the remote control.

Select one of these settings:

- **Normal** for standard TV broadcasts, computer images, or images with a 4:3 aspect ratio.
- **Full** for images recorded in 16:9 (wide-screen) format and squeeze mode.
- **Zoom** for letterbox images.

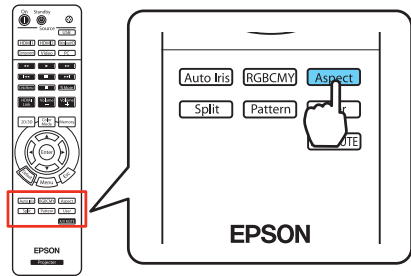

4:3 image using Normal setting



16:9 image using Full setting



- **Wide** for expanding a 4:3 image to 16:9 so it fills the whole screen. This stretches only the right and left sides of the image; the central part is unchanged.

Note: When displaying 720p, 1080i, or 1080p signals through the HDMI or Component video port, the aspect ratio is automatically selected and you cannot change it.

If you display a 4:3 image using the **Zoom** setting, the top and bottom will be cut off. You can use the **Zoom Caption Pos.** option and other settings to resize and reposition the image. For details, see page 53.

For details on how the projector resizes the picture when you choose an **Aspect** setting, see page 81.

Viewing 3D images

To view 3D content, you must first connect a 3D-compatible video device to one of the HDMI ports on your projector. You will also need a pair of Epson or Epson-compatible M-3Di active shutter glasses.

1. Turn on and begin playback on the 3D-compatible video device.
2. Press the 2D/3D button on the remote control, if necessary.
3. Press and hold the power button on your 3D glasses for at least one second.

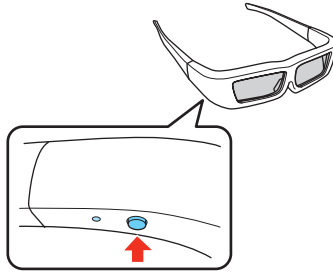

See “Solving Picture Problems” on page 71 for 3D troubleshooting tips.

Projecting in Split Screen mode

You can use the Split Screen feature to simultaneously project two images from different image sources next to each other. You can control the Split Screen feature using the remote control or the projector menus.

Note: While you use the Split Screen feature, other projector features may not be available and some settings may be automatically applied to both images. You also can't access Split Screen mode when USB is the active display source or 3D mode is enabled.

1. Press the **Split** button on the remote control.

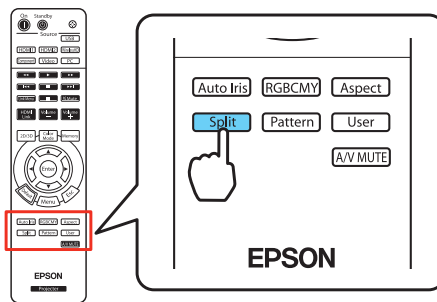

The currently selected input source moves to the left side of the screen.

2. Press the **Menu** button. You see this screen:

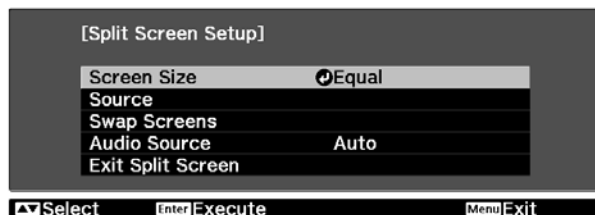

To select an input source for the other image, select the **Source** setting, press **Enter**, select the input source, select **Execute**, and press **Enter**. (You can also change image sources, if necessary.)

Note: You can't access Split Screen mode when USB is the active display source.

3. To switch the images, select the **Swap Screens** setting and press **Enter**.
4. To change the image sizes, select the **Screen Size** setting, press **Enter**, select a sizing option, press **Enter**, and press **Menu** to exit.

Note: Depending on the video input signals, the images may not appear at the same size even if you choose the **Equal** setting.

5. To choose the audio you want to hear, select the **Audio Source** setting, press **Enter**, select an audio option, press **Enter**, and press **Menu** to exit.

Note: Select **Auto** to hear audio from the largest screen or the left screen.

6. To exit the Split Screen feature, press the **Split** or **Esc** button.

Starting a Slideshow

After connecting a USB device to the projector, you can switch to the USB input source and start your slide show.

Note: You can change the Slideshow operation options or add special effects by highlighting **Option** at the bottom of the screen and pressing **Enter**. See “Choosing Slideshow Options” on page 31 for more information.



1. Press the **USB** source button on the projector remote control. The Slideshow screen appears.
2. Do the following as necessary to locate your files:
 - If you need to display files inside a subfolder on your device, press the arrow buttons to highlight the folder and press the **Enter** button.
 - To move back up a folder level on your device, highlight **Back to Top** and press **Enter**.
 - To view additional images in a folder, highlight **Next page** or **Previous page** and press **Enter**.

3. Do one of the following to start your slide show:
 - To display an individual image, press the arrow buttons to highlight the image and press **Enter**. (Press the **Esc** button to return to the file list screen.)
 - To display a slide show of all the images in a folder, press the arrow buttons to highlight the **Slideshow** option at the bottom of the screen and press **Enter**.

Note: If any file names are longer than 8 characters or include unsupported symbols, the file names may be shortened or changed only in the screen display.
4. While projecting, use the following commands to control the display as necessary:
 - To rotate a displayed image, press the up or down arrow button.
 - To move to the next or previous image, press the left or right arrow button.
5. To stop the display, follow the on-screen instructions or press the **Esc** button.

Choosing Slideshow Options

You can select these display options when using the projector's Slideshow feature by highlighting **Option** at the bottom of the Slideshow screen and pressing **Enter**. You see this screen:

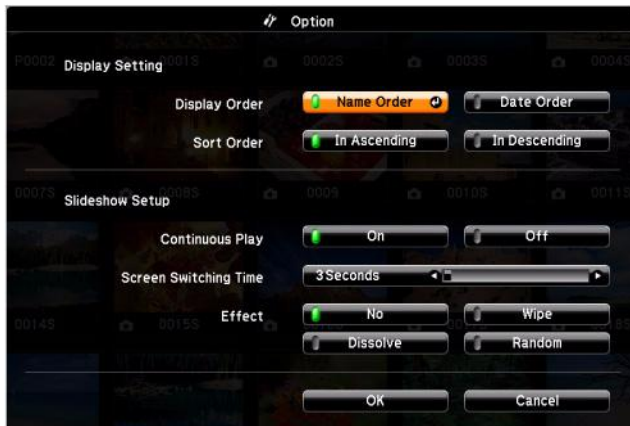

Setting	Options	Description
Display Order	Name Order	Displays files in name order
	Date Order	Displays files in date order

Setting	Options	Description
Sort Order	In Ascending	Sorts files in first-to-last order
	In Descending	Sorts files in last-to-first order
Continuous Play	On	Displays a slide show continuously
	Off	Displays a slide show one time through
Screen Switching Time	No	Does not display the next file automatically
	1 Second to 60 Seconds	Displays files for the selected time and switches to the next file automatically
Effect	Wipe	Transitions between images with a wipe effect
	Dissolve	Transitions between images with a dissolve effect
	Random	Transitions between images using a random variety of effects

Choosing the Color Mode

You can change the Color Mode to automatically adjust brightness, contrast, and color, letting you quickly optimize the projected image for various lighting environments. You can also select a different color mode for each input source—which is useful if you view different types of images from different sources. (For example, you might set the HDMI 1 source to **Living Room** if it's usually used for watching movies in the daytime with the blinds closed, and the PC source to **Dynamic** for playing video games with the blinds open.)

Select the image source you want to adjust, then press the **Color Mode** button on the remote control. Choose from these settings:

- **Auto** for automatically-optimized color settings based on the current lighting environment.

Note: Selecting the **Rear** or **Ceiling** projection settings will disable the **Auto** Color Mode.

- **Cinema** for viewing movies in a dimly lit room.
- **Dynamic** for projecting the brightest picture available.

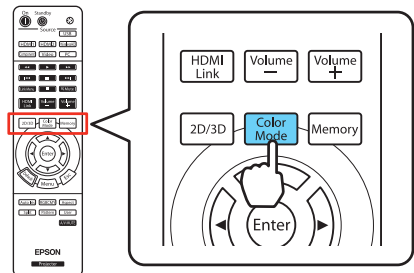

- Living Room for watching television programs during the day.
- Natural for projecting natural, accurate colors in a dimly lit room.
- 3D Dynamic for projecting the brightest 3D picture available (only available when the projector is in 3D Mode).
- 3D Cinema for viewing 3D movies in a dimly lit room (only available when the projector is in 3D Mode).

Advanced Color Adjustments

To further customize the color and image quality, you can adjust the gamma and individual RGBCMY color tones using the RGBCMY button on the remote control (not available when Auto is selected as the Color Mode).

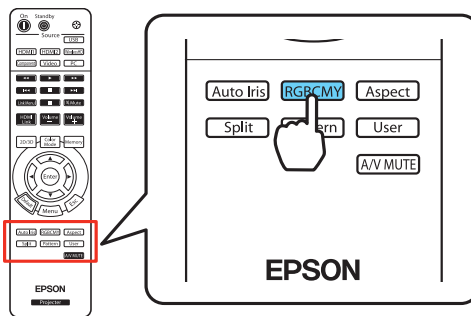

Note: You can fine-tune these and other color and image quality settings using the projector's menu system (see page 37). You can also save combinations of picture settings with the Memory feature for easy recall (see page 49). If you don't like the settings you have selected on a particular menu screen, you can press the Default button to restore the factory settings.

Adjusting the Gamma Setting

You can select from five gamma settings (2.0 to 2.4) or customize your own setting from your image or a displayed graph. Lower values will increase the contrast of dark areas, but tend to blur the bright areas. Higher values will darken the light areas. Gamma presets make minor adjustments to mid-tone values. The larger the gamma preset, the lower the midtone values. Changing these settings affects contrast which can be seen as a blur in bright areas.

Note: This setting cannot be used when the Color Mode is set to **Auto** (see page 32).

1. Press the **Menu** button. Select **Image** from the main menu. Select **Advanced** and then **Gamma**. You see the following displayed on the screen:

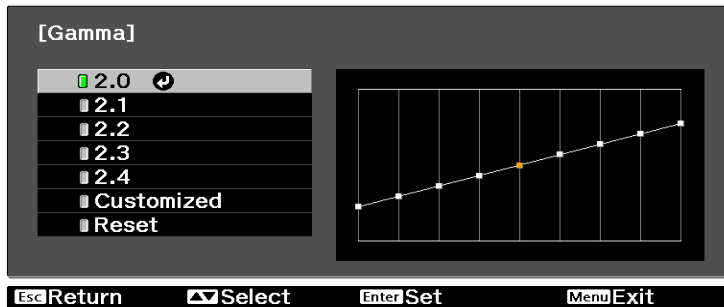

2. Do one of the following:
 - Select one of the numeric correction values using the ▲ or ▼ button on the remote control and press the **Enter** button. You see the setting reflected in the graph on the right. The horizontal axis represents the input signal level, and the vertical axis represents the output signal level. Press the **Esc** button to exit.
 - Select **Customized**. Then continue with the next step.
3. Do one of the following:
 - Select **Adjust it from the image**. You see a gamma icon on the projected image. Use the arrow buttons to move the icon to the area of brightness you want to adjust, then press **Enter**. The custom gamma graph appears with the channel selected for adjustment. Press the ▲ or ▼ button to adjust and then press **Enter** to save your setting and exit.
 - Select **Adjust it from the graph**. When the gamma graph appears, use the ◀ or ▶ button to select the point on the graph that you want to adjust, and then use the ▲ or ▼ button to adjust the settings. Press **Enter** to save your setting and exit.
4. Press the **Menu** button to close the menu screen when you're done.

Adjusting RGBCMY

Use this feature to adjust the hue, saturation, and brightness for each of the red (R), green (G), blue (B), cyan (C), magenta (M), and yellow (Y) color components (not available when **Auto** is selected as the Color Mode).

1. Press the RGBCMY button. You see the following displayed on the screen:

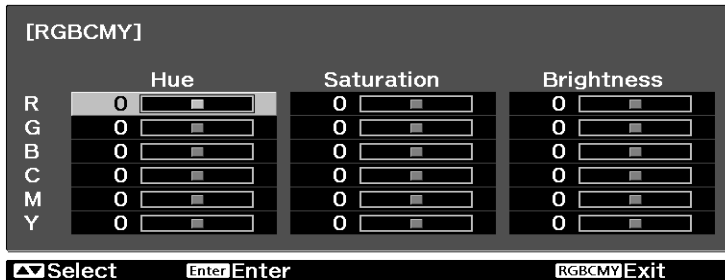

2. Use the ▲ or ▼ button on the remote control to select the color you want to adjust, and press the Enter button.
3. Select the Hue, Saturation, or Brightness for that color, and use the ◀ or ▶ button to make the adjustment.
4. Press Esc to adjust another color, or press RGBCMY to exit.

Note: You can also adjust the offset and gain using the RGB setting in the projector's menu system (see page 44).



Locking the Projector

The projector includes two lock settings to prevent the image from being accidentally changed once it's adjusted, and to keep children from turning on the projector without adult supervision.

To access the lock settings, follow these steps:

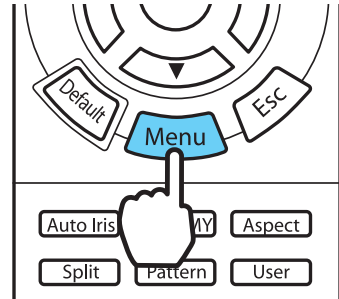
1. Press the **Menu** button on the remote control.
2. Select **Settings** and press the **OK** button.
3. Select **Lock Setting** and press the **OK** button.
4. Choose from these options:



- **Child Lock** to disable the  power button on the projector's control panel unless it is pressed for about 3 seconds. Since you can still use the remote control to turn on the projector, you may want to keep it away from children's reach.
 - **Control Panel Lock** to disable all the buttons on the projector's control panel except the  power button. A lock icon appears on the screen whenever you press a button with Control Panel Lock turned on. To operate the projector, you must use the remote control. To cancel Control Panel Lock, press and hold the **Enter** button on the projector's control panel for at least 7 seconds.
5. Press **Menu** to exit the menu system.

If you turned on the Control Panel Lock, the projector buttons are now locked.

If you turned on the Child Lock, turn off the projector and let it cool down. The Child Lock takes effect after the cool-down period.

Making Detailed Adjustments

You can use the projector's on-screen menus to make detailed adjustments to the image quality—such as the brightness, contrast, sharpness, and color. You can also change the menu display, sleep mode settings, and other projector features.

Using the Menu System

You can access the menu system either from the remote control or the buttons on the projector's control panel. You can access the full menu or a line menu that lets you change selected settings. You can also change the menu language and control how the menus display (see page 38).

To display the full menu, press the **Menu** button on the projector or remote control. You see a display like this one:

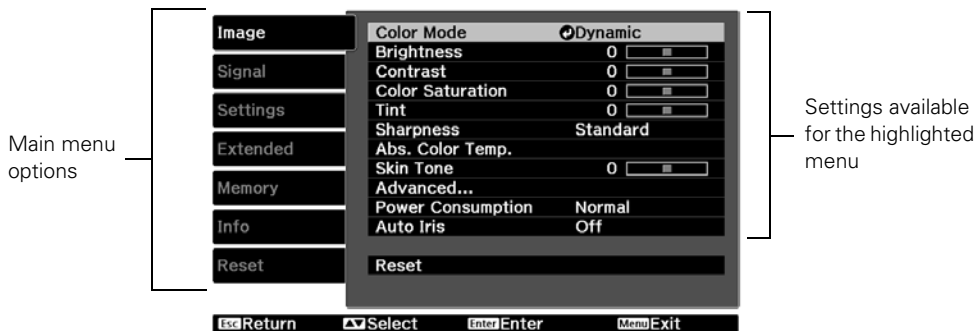

Note: You may see different options, depending on your projector model and how your equipment is connected to it.

1. Press the ▲ or ▼ button to highlight a main menu option (Image, Signal, Extended, Settings, Memory, Info or Reset), then press the Enter button to select it.
2. Press the ▲ or ▼ button to highlight a setting, then press the Enter button.
3. Press the ▲, ▼, ◀, or ▶ button to change settings as necessary. You may have to press the Enter button to confirm your choice.

4. When you're finished, press the **Esc** button to return to the previous menu or press the **Menu** button to exit the menu system.

To display one of the line menus, press the **Enter** button. You see a display like this at the bottom of the image:

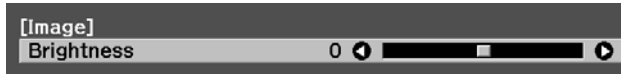

- Press the ◀ or ▶ button to adjust the setting.
- Press the **Menu** or **Esc** button to close the line menu when you're done.

Note: When a line menu is displayed, you can press **Default** on the remote control to reset the menu to its factory setting.

Changing How the Menus Display

Use these options to control how the menus display.

- **Language**

Extended > Language

Select from 21 languages to use in the menu system.

- **Menu Position**

Extended > Display > Menu Position

Use the arrow buttons to choose a position on the screen for displaying the menu.

- **Menu Color**

Extended > Display > Menu Color

Select a color scheme for displaying the menus.

Adjusting the Picture Quality

Before fine-tuning the image using these adjustments, make sure you have already selected the best Color Mode for your picture and viewing environment, as described on page 32. Then use the settings in this section to finish adjusting the picture to your liking.

Most image quality settings are saved independently for each input source (Video, HDMI, Component, PC) and color mode. After you finish adjusting the settings for one input source, switch to the other input sources you'll be using and make any necessary adjustments.

Note: These features are not available when **Auto** is selected as the Color Mode.

Input Brightness Settings

If the signal from connected equipment is weak and images appear dark, you can adjust the Brightness and Contrast settings. You can adjust brightness and contrast for each image source and color mode.

The Brightness setting controls how much light is produced by the projector, and the Contrast setting adjusts the difference between the bright and dark areas of the projected image. The other settings in this section control how the projector interprets the light and dark areas of the picture.

■ Brightness

Image > Brightness

Adjust the brightness so it's suitable for your viewing conditions. For example, if you're projecting in a brightly lit room or onto an especially large screen, you may need to increase the brightness. Decrease the brightness for dark rooms or small screens; this also reduces power consumption and fan noise, and helps to prolong the life of the lamp.

■ Contrast

Image > Contrast

This setting adjusts the difference between bright and dark areas.

■ Auto Iris

Image > Auto Iris

Note: This setting cannot be used when the Color Mode is set to **Auto** (see page 32).

When this setting is on, the light output is automatically adjusted according to the brightness of the image. Select either **Normal** or **High Speed** to indicate how quickly you would like the projector to respond to changes in the brightness of the image. The setting is stored separately for each image source and color mode.

■ Setup Level

Signal > Advanced > Setup Level

Note: This setting can be used only when an NTSC signal is being input through the Video port, or when a video signal is being input through the Component video ports.

This setting adjusts the threshold at which dark areas of the image are rendered black (0 IRE). For compatibility with most DVD and video equipment sold in the United States, leave this setting at 0%. Check your video equipment's specifications to be sure of the correct setting.

■ EPSON Super White

Signal > Advanced > EPSON Super White

Note: This setting can be used only when the signal is input through the HDMI 1 or HDMI 2 ports with the Color Mode set to **Natural** or **Cinema** (see page 32).

If bright parts of the image are washed out or overexposed (when the input signal contains values over 100 IRE), turn this setting on to compensate.

■ HDMI Video Range

Signal > Advanced > HDMI Video Range

Note: This setting can be used only when HDMI 1 or HDMI 2 is selected as the image source (see page 22). This setting cannot be used when the Color Mode is set to **Auto** (see page 32) or **Epson Super White** is set to **On**.

If your video equipment has an HDMI port and you've connected it to the projector using an HDMI cable, set the level of the projector to match that of the video equipment.

■ Power Consumption

Image > Power Consumption

This setting controls the light output from the projector. On **Normal**, the projector produces a brighter image and the lamp uses more power. To save power and extend the life of the lamp, select **ECO**.

Sharpness and Picture Quality Settings

If the image looks fuzzy, or if it contains noise or flickering, you can use these settings to correct it.

■ Sharpness

Image > Sharpness

Use this function to make lines and edges appear more distinct in the image. This setting is stored separately for each image source and color mode setting. You can select **Standard** to adjust the sharpness of the entire image, or select **Advanced** to access the following submenu:



Note: The Advanced setting cannot be used with a signal input through the PC port.

Choose **Thin-Line Enhancement** to sharpen details such as hair and clothing. Choose **Thick-Line Enhancement** to sharpen large contours and backgrounds. Choose **Vert. Line Enhancement** to increase vertical image sharpness. Choose **Horiz. Line Enhancement** to increase horizontal image sharpness.

■ Progressive

Signal > Progressive

Converts interlaced to progressive signals. The projector uses 3D DigiScan™ HD Circuitry Processing for video-sourced images.

Leave the setting on **Film/Auto** for viewing movies on a player that produces interlaced output. Select **Video** for watching videos captured with a video camera. Set to **Off** when viewing images with a large amount of movement.

Note: This setting can be used only when viewing a composite video signal, or 480i or 576i, or 1080i signals input through the Component, HDMI 1, or HDMI 2 ports (see page 81).

■ Motion Detection

Signal > Motion Detection

This setting specifies how signals are converted to progressive signals. Select a lower setting for slow-moving or still images (**S**) or select a higher number for video images (**M**).

Note: This setting can be used only when viewing a composite video signal, or 480i or 576i, or 1080i signals input through the Component, HDMI 1, or HDMI 2 ports (see page 81).

■ Noise Reduction

Signal > Advanced > Noise Reduction

Note: This setting may not be available when the Color Mode is set to Auto (see page 32) or with a signal input through the PC port.

This setting reduces flickering of analog images. You can select from 3 levels of noise reduction.

■ 2-2 Pull-down

Signal > Advanced > 2-2 Pull-down

Note: This setting can be used only when viewing a 1080p/24Hz signal input through the Component, HDMI 1, or HDMI 2 ports (see page 81). This setting cannot be used when the Color Mode is set to **Auto** (see page 32) or with a signal input through the PC port.

This setting allows you to select whether images are projected with 2-2 Pull-down detection or 2-3 Pull-down detection. Select **On** for 2-2 Pull-down detection.

Color Settings

If the image colors don't look correct, you can adjust them using these settings. Use the first three settings described below to make the most visible changes. If you only need to make slight adjustments, you can fine-tune the picture with the remaining settings. Most color settings are stored separately for each image source and color mode.

■ Color Saturation

Image > Color Saturation

Note: This setting cannot be used when the Color Mode is set to **Auto** (see page 32) or with a signal input through the PC port.

Adjusts the color intensity of the image.

■ Tint

Image > Tint

Note: This setting cannot be used when the Color Mode is set to **Auto** (see page 32) or with a signal input through the PC port.

Shifts the color balance between magenta and green.

■ Abs. Color Temp.

Image > Abs. Color Temp.

Note: This setting cannot be used when the Color Mode is set to **Auto** (see page 32).

Shifts the color balance between red and blue, making the image appear warmer or cooler.

■ Skin Tone

Image > Skin Tone

Note: This setting cannot be used when the Color Mode is set to **Auto** (see page 32).

Makes fine adjustments to the tint and controls the amount of magenta or green in the image. Also useful for correcting black-and-white images, if they look tinted.

■ RGB

Image > Advanced > RGB

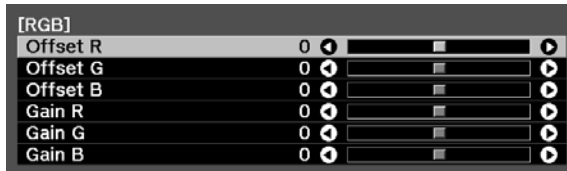

Note: This setting cannot be used when the Color Mode is set to **Auto** (see page 32).

Use the RGB settings to fine-tune the color of the image. You can adjust the offset and gain for each signal color (red, green, and blue). Use **Offset** to adjust darker shades and **Gain** for the lightest shades.

■ RGBCMY

Image > Advanced > RGBCMY

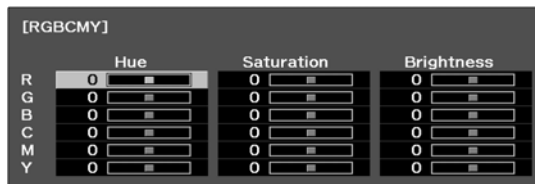

Note: This setting cannot be used when the Color Mode is set to **Auto** (see page 32).

Use the RGBCMY settings to adjust the hue, saturation, and brightness of the six color components (red, green, blue, cyan, magenta, yellow). After adjusting each color, press **Esc** to move to another menu option. You can also access this setting by pressing the RGBCMY button on the remote control. See page 35 for more information.

■ Gamma

Image > Advanced > Gamma

Note: This setting cannot be used when the Color Mode is set to **Auto** (see page 32).

You can select from five gamma settings (2.0 to 2.4) or customize your own setting from your image or a displayed graph. Lower values will increase the contrast of dark areas, but tend to blur the bright areas. Higher values will darken the light areas. See page 33 for more information.

3D Setup

Use this menu to adjust 3D brightness, the 3D display format and other 3D settings.

Note: You should only adjust the **3D Format** and **Inverse 3D Glasses** settings if 3D images aren't displaying correctly. Changing these settings unnecessarily may cause problems with 3D projection.

■ 3D Display

Signal > 3D Setup > 3D Display

Enables or disables 3D mode. You can also change this setting by pressing the **2D/3D** button on the remote control.

■ 3D Format

Signal > 3D Setup > 3D Format

Use this setting to select the 3D format supported by your video device. In most cases, the projector will correctly detect the 3D format when this option is set to **Auto**. You should only select the **2D**, **Side by Side**, or **Top and Bottom** formats when your projector doesn't properly display 3D images. See your video source documentation for information on which mode to select.

■ 3D Brightness

Signal > 3D Setup > 3D Brightness

Adjusts the brightness of 3D images. Select the **Medium** or **High** settings if the 3D display is too dark.

Note: This setting is not available when 3D Format is set to **Auto**.

■ Inverse 3D Glasses

Signal > 3D Setup > Inverse 3D Glasses

Reverses the timing for the left and right shutters on the 3D active shutter glasses. Only enable this function if 3D images are not displaying correctly.

Note: This setting is not available when 3D Format is set to **Auto**.

■ 3D IR Emitter

Signal > 3D Setup > 3D IR Emitter

Select **External** if you've connected an external 3D IR emitter (see "Optional Accessories" on page 10 for ordering information).

■ 3D Viewing Notice

Signal > 3D Setup > 3D Viewing Notice

Enables or disables the viewing notice that is displayed when 3D mode is activated.

Adjustments for Computer Images

In addition to the settings described previously, you can adjust the Tracking and Sync settings for analog RGB computer images. Normally, these settings are adjusted automatically by the projector. If you notice that the image is blurry or contains dark vertical bands, you may need to adjust the settings yourself.

■ Auto Setup

Signal > Auto Setup

Leave this setting on so that the projector automatically adjusts the tracking, sync, and position of the image.

■ Tracking

Signal > Tracking

Adjust the tracking to eliminate vertical bands. It is easiest to adjust the tracking when the image contains a lot of fine detail (such as black text on a white background).

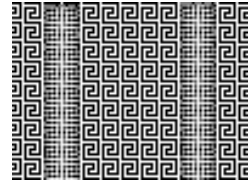

■ Sync.

Signal > Sync.

Adjust the synchronization to eliminate blurriness. For best results, make sure the tracking is properly adjusted first.

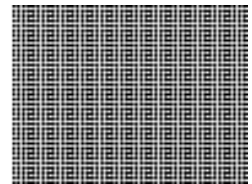

WirelessHD Settings

Use these options to manage the WirelessHD connection and access the WirelessHD reception monitor.

■ Device Connections

Settings > WirelessHD > Device Connections

Select this option to display a list of available WirelessHD devices.

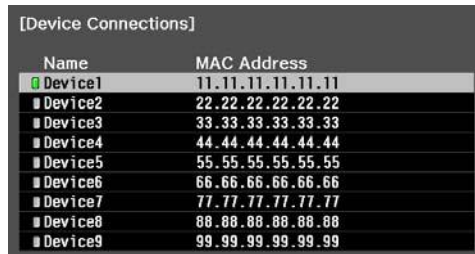

Name	MAC Address
Device1	11.11.11.11.11.11
Device2	22.22.22.22.22.22
Device3	33.33.33.33.33.33
Device4	44.44.44.44.44.44
Device5	55.55.55.55.55.55
Device6	66.66.66.66.66.66
Device7	77.77.77.77.77.77
Device8	88.88.88.88.88.88
Device9	99.99.99.99.99.99

Use the arrow keys to navigate the menu and press **Enter** to select a device.

■ WirelessHD

Settings > WirelessHD > WirelessHD

Enables or disables the projector's WirelessHD connection.

■ Reception

Settings > WirelessHD > Reception

Select this option to display the WirelessHD reception monitor.



■ Rename Device Name

Settings > WirelessHD > Rename Device Name

Use this option to rename the devices displayed in the WirelessHD Device Connections menu.

■ Erase Device Name

Settings > WirelessHD > Erase Device Name

Use this option to delete the names of devices displayed in the WirelessHD Device Connections menu and return them to their default values.

■ Reset

Settings > WirelessHD

Select this option to reset all WirelessHD settings and return them to their default values.

Split Screen Setup

Press the **Menu** button while in Split Screen mode to access this menu.

■ Screen Size

Split Screen Setup > Screen Size

Adjusts the size of the two screens. Choose **Larger Left** to increase the size of the left screen, **Larger Right** to increase the size of the right screen, or **Equal** to split the display evenly between the two screens.

Note: Depending on the source and resolution of each input, the two screens may not appear to be of equal size when the **Equal** option is selected.

■ Source

Split Screen Setup > Source

Select this option to open the Source menu and select which inputs should be displayed in split screen mode.

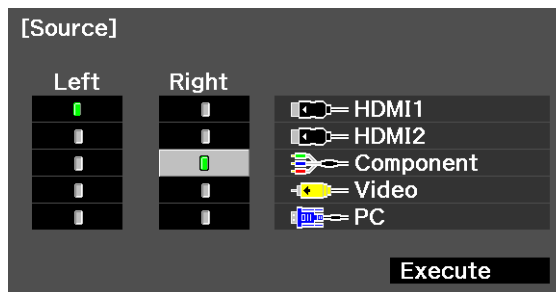

The Left and Right columns represent the left and right screens. Use the arrow buttons on the remote control to highlight **Left** or **Right** for the source you want to display. Press **Enter** on the remote control to select an option.

Once you have finished making your selections for both screens, select **Execute** to exit the Source menu and apply these settings.

Note: Certain combinations of sources can't be selected. Invalid input combinations will be grayed out.

■ Swap Screens

Split Screen Setup > Swap Screens

Select this option to quickly switch the images on the left and right sides of the split screen display.

■ Audio Source

Split Screen Setup > Audio Source

Use this setting to select which screen's audio you want to hear while in split screen mode.

Note: Select **Auto** to hear audio from either the largest screen or the screen on the left (depending on the **Screen Size** setting).

Selecting Memory Settings and Resetting the Projector

Your projector comes with 8 memory locations that are reserved for color mode calibration by installers. In addition, there are 2 memory locations where you can save other customized settings to obtain the best picture quality for each of your video inputs.

Note: Certain menu options may not be available when **Auto** is selected as the Color Mode.

Creating Memory Settings

Memory settings can be used to store most of the picture quality settings on page 41 and color settings on page 43. Before saving them to memory, adjust the settings to the desired levels.

1. Press the **Memory** button on the remote control.
2. Select **Save Memory**.
3. Select the memory name you want to use, then press the **Enter** button to save your settings.

Note: Saved settings are indicated by a green highlight  next to the memory name. If you select a name that is already in use, the existing settings will be erased and new ones saved in their place.

Selecting Memory Settings

You can easily recall the memory settings by using the **Memory** button on the remote control.

1. Press the **Memory** button on the remote control.
2. Select **Load Memory**.
3. Use the arrow buttons to select the desired setting, then press the **Enter** button.

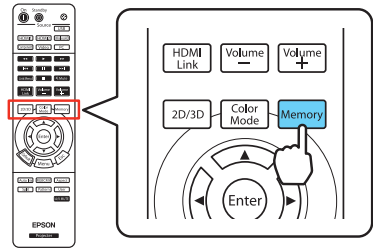

After a moment, the image appears on the screen using the retrieved settings. Certain settings may not be applied, depending on the input signal.

Renaming Memory Settings

You can rename memory settings so that they are easier for you to recognize.

1. Press the **Memory** button on the remote control.
2. Select **Rename Memory**.
3. Select the memory name you want to change, then press the **Enter** button. The name selection screen is displayed.
4. Do one of the following:
 - To select a name from the displayed preset names, select the desired name and press the **Enter** button.
 - To create your own name, select **Customized** and use the keyboard screen to enter the name. Use the arrow buttons to select a character, then press the **Enter** button. When you have selected all of the characters in your name, select **Finish** and press the **Enter** button.

Deleting Saved Memory Settings

You can clear all your memory settings at once.

1. Press the **Menu** button on the remote control.
2. Open the **Reset** menu, then select **Reset Memory**.
3. Select **Yes**, then press the **Enter** button to delete the memory settings.

Note: You can delete memory settings one at a time with the **Erase Memory** setting under the **Memory** menu.

Resetting the Projector

If the image quality isn't what you expect, one or more settings may be adjusted improperly. If necessary, you can restore the projector to its factory-default (original) settings.

To restore the settings in a specific menu (such as the Image or Settings menu), open that menu, select **Reset**, and confirm as needed. The example below shows how to reset the Image menu settings:

Open the Image menu . . .

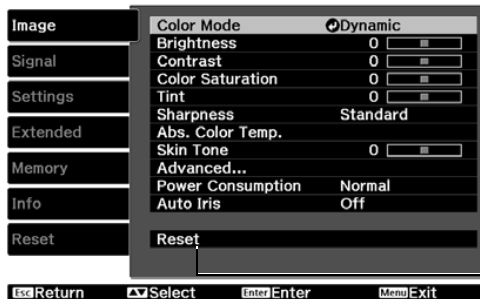

and select Reset

You can also reset the lamp usage timer or restore all the projector settings to their original values. Follow these steps:

1. Press the **Menu** button on the remote control.
2. Open the **Reset** menu.

3. Do one of the following:
 - Select **Reset Lamp Hours** to clear the lamp usage timer and reset it to zero. You should reset the lamp timer only when you install a new projector lamp. See page 67 for more information.
 - Select **Reset Memory** to clear all memory settings.
 - Select **Reset All** to return all projector settings to their original defaults (except Input Signal, User Button, Language, and Lamp Hours).

Customizing Projector Features

Use the settings in this section to adjust the image size and position, suppress on-screen text, and select basic setup options.

Image Sizing

Before adjusting any of these settings, make sure you have already selected an appropriate aspect ratio for the type of picture you're viewing (see page 27).

■ Overscan

Signal > Advanced > Overscan

For component and HDMI video formats, this setting lets you see the edges of the image that are not normally visible in the picture (see page 81). If you see interference when you set **Overscan** to **Off**, try adjusting the **Position** as described below.

Note: The **Auto** setting is only available when the input source is HDMI1, HDMI2, or WirelessHD.

■ Position

Signal > Position

Note: This setting cannot be used with a signal input through the HDMI 1 or HDMI 2 port or the WirelessHD connection (PowerLite Home Cinema 3010e only).

Use the arrow buttons to fine-tune the position of the image on the screen.

■ Aspect

Signal > Aspect

This setting lets you change the aspect ratio of your image, and works the same as pressing the **Aspect** button on the remote control. See page 27 for more information.

Note: When displaying 720p, 1080i, or 1080p signals through the HDMI or Component video port, the aspect ratio is automatically selected and you cannot change it.

If you display a 4:3 image using the Zoom setting, the top and bottom will be cut off. You can use the Zoom Caption Pos. option and other settings to resize and reposition the image.

For details on how the projector resizes the picture when you choose an Aspect setting, see page 81.

■ Zoom Caption Pos.

Signal > Zoom Caption Pos.

Lets you adjust the shape and position of the image so that subtitles are visible (available only if the Aspect setting has been set to **Zoom**). Adjust Overscan before changing the zoom position.

Screen Options

■ Messages

Extended > Display > Messages

Turn this setting off if you want to prevent on-screen messages from appearing (such as the no-signal message, or the identifying text that appears when you switch between image sources or color modes).

■ Startup Screen

Extended > Display > Startup Screen

Turn this setting off if you want to prevent the startup screen from appearing while the projector is warming up.

■ Display Background

Extended > Display > Display Background

Changes the screen that's used when the projector is not receiving a signal or when you press the **A/V Mute** button to temporarily stop projection.

Other Setup Options

■ Projection

Settings > Projection

You can select different options for projecting the image: **Front**, **Front/Ceiling**, **Rear**, **Rear/Ceiling**.

Note: Only the **Front** option is available when the Color Mode is set to **Auto**.

■ Direct Power On

Extended > Operation > Direct Power On

Sets projection to start without pressing the  power button on the projector or the **On** button on the remote control.

Note: When Direct Power On is enabled, power surges that occur after a power outage can cause the projector to turn on.

■ Video Signal

Extended > Input Signal > Video Signal

Leave this setting on **Auto** so the projector can automatically interpret the format, such as NTSC or PAL (for standard TV formats).

■ Component

Extended > Input Signal > Component

Change this setting to match the type of equipment connected to the Component port. For component video, select **Auto** to let the projector automatically interpret the signal; or select **YCbCr** or **YPbPr** to manually select your video equipment's signal.

■ Illumination

Extended > Operation > Illumination

Turn off this setting to deactivate the lights on the projector's  power button and power light. Use this setting if you find the lights distracting in a darkened room.

■ Sleep Mode

Extended > Operation > Sleep Mode

Turn off this setting if you don't want the projector to enter sleep mode. (Sleep mode shuts the projector off automatically when there is no video signal.)

Select 5min., 10min., or 30min. as the length of time before shutoff; decreasing the time conserves power and extends the life of the lamp. 30min. is the default setting.

To turn the projector back on, press the  power button on the projector or the On button on the remote control.

■ Child Lock

Settings > Lock Setting > Child Lock

Lets you lock the  power button on the projector's control panel to make it more difficult for a child to turn on the projector. See page 36 for more information.

■ Control Panel Lock

Settings > Lock Settings > Control Panel Lock

Lets you disable all the buttons on the projector's control panel to prevent the image from being accidentally changed once it is adjusted. See page 36 for more information.

■ High Altitude Mode

Extended > Operation > High Altitude Mode

Adjusts the speed of the fan so it can properly cool the projector at higher altitudes. Turn this setting on if you are using the projector at an altitude of 4921 feet (1500 meters) or higher.

Note: The maximum operating altitude is 7500 feet (2286 meters).

Using WirelessHD

You can use the included WirelessHD Transmitter (PowerLite Home Cinema 3010e only) to wirelessly stream HD content from a video device to the projector.

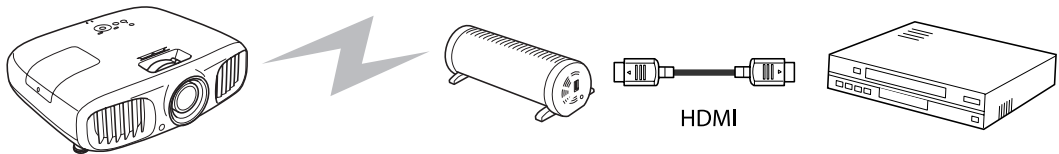

Placing the WirelessHD Transmitter

Place the WirelessHD Transmitter so that the unit's lights face the front of the projector. Make sure the transmitter is within 32 feet (10 meters) of the projector and is located in the same room.

Note: The wireless transmission range may vary depending on the placement and size of surrounding objects. Avoid placing the transmitter in an area with many large or metal objects and do not place the transmitter on a metal surface, as this may interfere with the signal.

Use the images below to determine the best placement for the WirelessHD Transmitter (the shaded areas represent the WirelessHD transmission area):

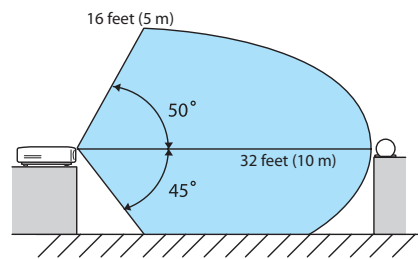
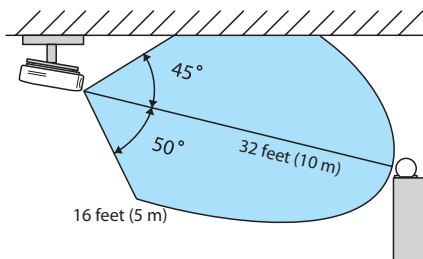

Setting Up a WirelessHD Connection

To prepare your device to work with the **WirelessHD** button, follow these steps:

1. Follow the instructions on the previous page and place the transmitter within range of the projector.
2. Plug the AC adapter into the transmitter and an electrical outlet.
3. Connect an HDMI cable to your video device and the HDMI port on the side of the **WirelessHD** Transmitter.
4. Turn on the power switch on the back of the transmitter.
5. Turn on your source device and begin playback.
6. Turn on the projector.
7. Press the **WirelessHD** button on the projector remote control.

Your projector should now display content from your video device. If it doesn't, see "Solving **WirelessHD** Problems" on page 75.

Using HDMI Link

When you connect HDMI CEC-compatible devices to the projector with HDMI cables, you can control them using the HDMI Link control buttons on the projector's remote control. This lets you use just one remote control to operate many commonly used features on all your devices.

In a typical configuration, your DVD player may be connected to the projector through an amplifier or home theater system. Even if the amplifier does not conform to the HDMI CEC standard, you can still use the projector's HDMI Link control buttons to operate the DVD player as long as the DVD player conforms to the HDMI CEC standard.

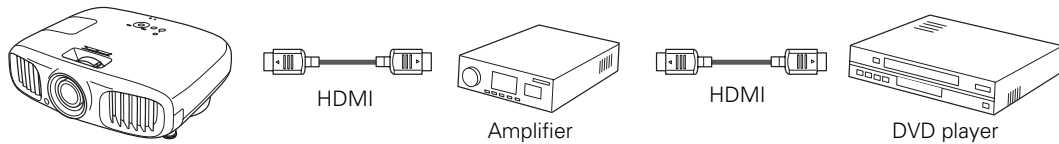

Note: Some HDMI CEC functions may not operate, depending on the connected product's design and compliance with the HDMI CEC standard.

Setting Up HDMI Link

To prepare your devices to work with the HDMI Link control buttons, follow these steps:

1. Press the HDMI Link button on the projector's remote control.
2. Select HDMI Link and set it to On.

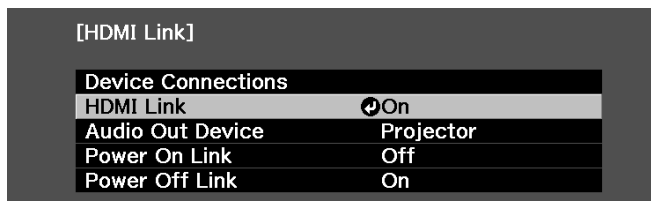

3. Press the HDMI Link button to exit the menu system.

4. Set up your connected devices so their HDMI CEC-compatible functions are enabled. For details, refer to the device manufacturer's documentation.

Changing HDMI Link Settings

1. Press the HDMI Link button on the projector's remote control.
2. Select Device Connections. You see this screen:

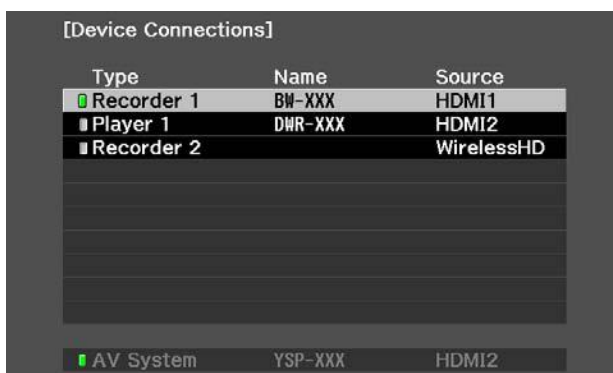

Type	Name	Source
■ Recorder 1	BW-XXX	HDMI1
■ Player 1	DWR-XXX	HDMI2
■ Recorder 2		WirelessHD
■ AV System	YSP-XXX	HDMI2

3. Use the ▲ and ▼ arrow buttons to select the device you want to operate, then press **Enter**. Devices are listed by type (Player, Recorder, AV System, or Tuner) and by name, if the model number is available.
4. Once the device is selected, use the HDMI Link control buttons on the remote control to operate it. You can also use the **On** and **Standby** buttons, arrow buttons, **Enter**, and **Esc**. Commonly available functions include turning on the device when it's in standby mode, starting playback, adjusting the volume, and operating the device's link menu.

In addition, HDMI Link allows your projector and other devices to be turned on and off together:

- If you turn on a connected device, the projector automatically turns on and switches to the correct input source.
- If you turn on the projector, connected devices such as an amplifier and DVD player are turned on. If multiple video devices are connected, the one last used is turned on. When you turn off the projector, the connected devices are turned off.

Note: For this to work, the CEC power link function of the connected devices must be enabled.

Maintenance

Your projector needs little maintenance. All you need to do on a regular basis is keep the lens clean. You also may need to clean the air filter to prevent overheating.

Warning: Before you clean any part of the projector, turn it off and unplug the power cord. Never open any cover on the projector, except the lamp and filter covers. Dangerous electrical voltages in the projector can injure you severely. Do not try to service this product yourself, except as specifically explained in this *User's Guide*.

The only parts you should replace are the air filter and the lamp. If another part needs replacing, contact your dealer or a qualified servicer.

Cleaning the Lens

Clean the lens whenever you notice dirt or dust on the surface.

- Use a blower brush that is designed for camera equipment to remove dust from the lens.
- To remove dirt or smears, use a lens cloth or tissue. If necessary, moisten the cloth with lens cleaner and gently wipe the lens surface.

Caution: Never rub the lens with abrasive materials. Use only lens cleaning fluids that are designed for cleaning optics.

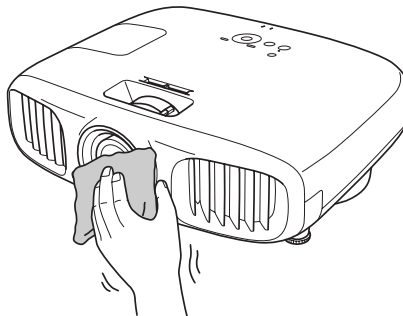

Cleaning the 3D Glasses

Use the included lint-free cloth (do not use paper towels) to gently wipe the 3D glasses whenever you notice dust or dirt on the surface.

Caution: Never rub the 3D glasses with abrasive materials.

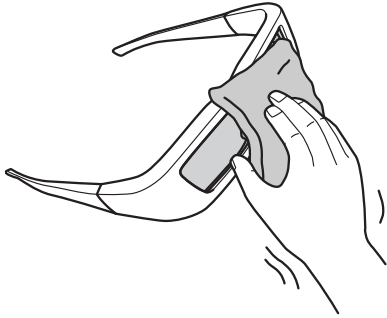

Cleaning the Projector Case

Before you clean the case, turn off the projector and unplug the power cord.

- To remove dirt or dust, wipe the case with a soft, dry, lint-free cloth.
- To remove stubborn dirt or stains, moisten a soft cloth with water and a neutral detergent. Then wipe the case and dry it with a dry cloth.

Caution: Never use wax, alcohol, benzene, thinner, or other chemical detergents. These can damage the case.

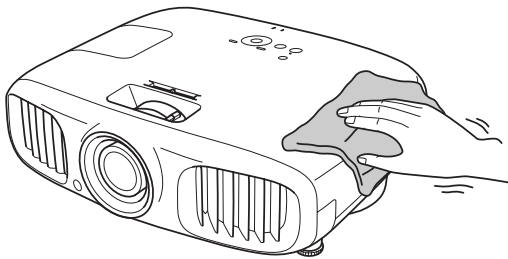

Cleaning and Replacing the Air Filter

Your projector includes an air filter to ensure the best performance. If dust collects on the air filter, clean it as described below. Dust clogs prevent proper ventilation and cause overheating and damage to the projector.

You can replace the air filter while the projector is mounted to the ceiling, if necessary. The illustrations here show the projector placed on a table.

1. Press the  power button on the projector twice or the **Standby** button on the remote control and wait for the power light to stop flashing. The projector cools down.
2. Unplug the power cord.
3. Pull straight out on the filter holder to remove it.

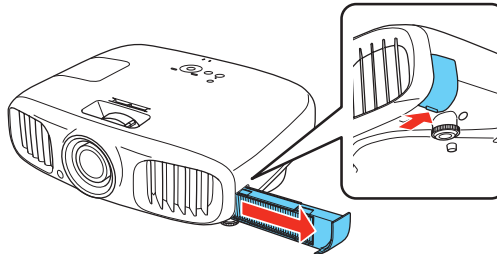

4. Remove the air filter as shown.

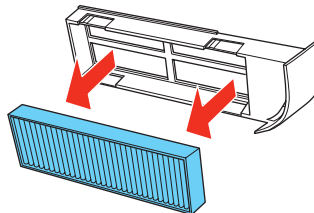

5. Gently tap both sides of the air filter against a hard surface four or five times to remove loose dust from the air filter.

Note: Do not use excessive force when tapping the air filter, or it may crack and become unusable. Do not rinse the air filter in water, or use any detergent or solvent to clean it. Do not use canned air, or the gases may leave a residue.

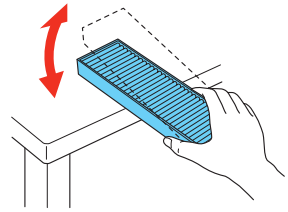

6. Use a small vacuum cleaner that is designed for computers and other office equipment to remove any remaining dust from the surface of the filter. If you don't have one, gently clean the filter using a very soft brush (such as a clean artist's paintbrush).

If the dirt is difficult to remove or the filter is broken, replace it. You can purchase air filter part number V13H134A38 from an authorized Epson reseller. To find the nearest reseller, please call 800-GO-EPSON (800-463-7766). To purchase online, visit www.epsonstore.com (U.S. sales) or www.epson.ca (Canadian sales).

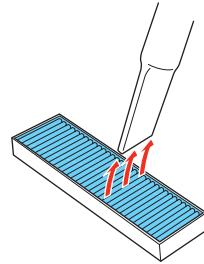

7. Insert the air filter as shown.

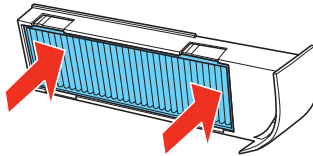

8. Slide the air filter holder back into place.

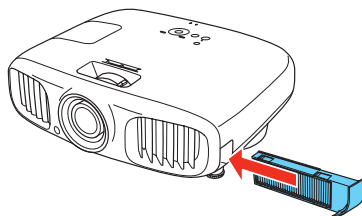

Replacing the Lamp

The projection lamp lasts for up to 4000 hours in Normal mode. You can use the **Info** menu to check how long it's been in use (see page 67). It's time to replace the lamp when:

- The projected image gets darker or starts to deteriorate.
- The projector's lamp light flashes orange or red at half-second intervals.
- The message **Replace the lamp** appears on the screen when you start projecting.

Note: Lamp life results will vary depending on mode selected, environmental conditions, and usage.

Turn off this product when not in use to prolong the life of the projector.

You can purchase lamp part number V12H010L68 from an authorized Epson reseller. To find the nearest reseller, please call 800-GO-EPSON (800-463-7766). To purchase online, visit www.epsonstore.com (U.S. sales) or www.epson.ca (Canadian sales).

Be sure to read the “Important Safety Information” on page 84 before replacing the lamp.

Warning: Let the lamp cool fully (about 1 hour) before replacing it. In the unlikely event that the lamp has broken, small glass fragments may be present and should be removed carefully to avoid injury.

Caution: Never touch the glass portion of the lamp with your bare hands; the invisible residue left by the oil on your hands may shorten the lamp life. Use a cloth or glove to handle the new lamp.

Follow these steps to replace the lamp:

1. If the projector is on, press the **⏻** power button on the projector twice or the **Standby** button on the remote control and wait for the light to stop flashing.
2. Unplug the power cord and any cables.
3. Wait about an hour to make sure the lamp is no longer hot.
4. Loosen the screw securing the lamp cover.

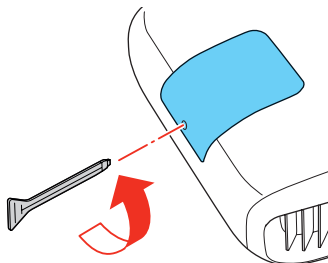

5. Remove the lamp cover as shown.

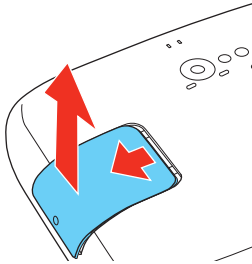

6. Loosen the screws securing the lamp (they don't come all the way out).

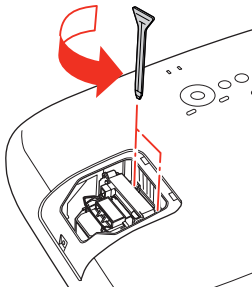

7. Lift up the lamp handle and gently pull the lamp out of the projector.

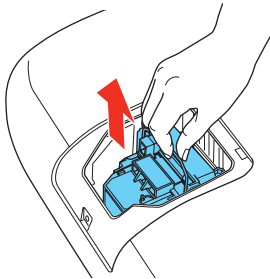

Warning:  The lamp(s) in this product contain mercury. Please consult your state and local regulations regarding disposal or recycling. Do not put in the trash.

8. Gently insert the new lamp into the projector and press the handle down. Tighten the screws.

Caution: Don't touch the glass portion of the lamp assembly. Touching the glass could result in premature lamp failure.



9. Replace the lamp cover. (The projector won't work if the lamp cover is open or loose.)

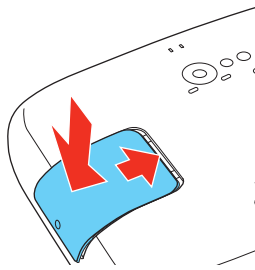

10. Tighten the lamp cover screw.

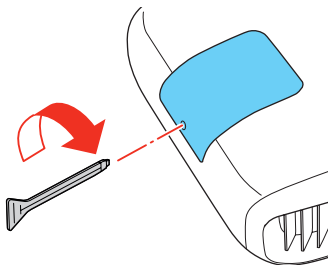

11. Reset the lamp usage timer, as described on page 67.

Resetting the Lamp Usage Timer

After replacing the lamp, plug the projector back in and press the  power button on the projector or the On button on the remote control. Then follow these steps to reset the lamp usage timer:

1. Press the **Menu** button on the projector or remote control.
2. Use the menu navigation buttons to open the **Reset** menu, then select **Reset Lamp Hours**.
3. When you see a confirmation prompt, highlight **Yes** and press the **Enter** button.
4. When you're finished, press the **Menu** button to exit.

The lamp usage timer shows 0H until you've used the lamp for at least 10 hours.

Checking the Projector Status

You can use the Info menu to view information about the current display settings and how long the projection lamp has been in use. To access the Info menu:

1. Press the **Menu** button on the projector or remote control.
2. Use the menu navigation buttons to open the **Info** menu. The following information appears:

- | | |
|----------------|------------------------------|
| ■ Lamp Hours | ■ 3D Format |
| ■ Source | ■ Sync Info |
| ■ Input Signal | ■ Video Signal |
| ■ Resolution | ■ Deep Color (color depth) |
| ■ Scan Mode | ■ Status (error information) |
| ■ Refresh Rate | ■ Serial Number |

Note: The information displayed depends on the currently selected image source. The Lamp Hours shows 0H until you've used the lamp for at least 10 hours.

The resolution indicates the total number of scan lines in the source signal. The number of visible scan lines depends on the signal format standard and selected display settings (see page 81).

Storing the Projector

If you need to store the projector for an extended time, do the following:

- Make sure the temperature of the storage area is within 14 to 140 °F (–10 to 60 °C).
- Attach the lens cover and retract the feet.
- Remove the batteries from the remote control.
- Pack the projector in its original packaging or equivalent.

Transporting the Projector

Note: Epson shall not be liable for any damages incurred during transportation.

The projector contains many glass and precision parts. When shipping the projector for repairs, use the original packaging material if possible. If you do not have the original packaging, use equivalent materials. Do not use materials that can become lodged in the projector vents. Be sure the carrier is capable of transporting fragile equipment and is aware that the projector is fragile.

Problem Solving

This section explains how to interpret the projector's status lights, solve problems with the picture and remote control, and contact technical support.

What To Do When the Lights Come On or Flash

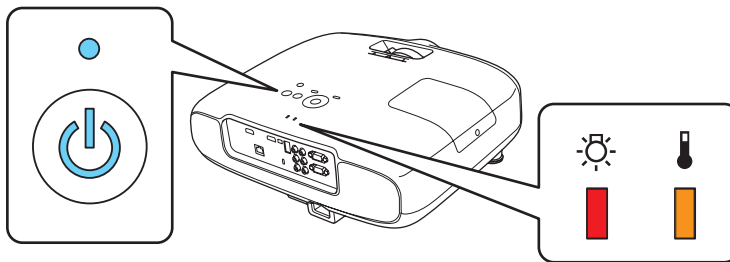

The lights on top of the projector indicate the projector's status and let you know when a problem occurs.





If the projector isn't working correctly, first press the  power button, let the projector cool down, and unplug the power cord. Then plug the power cord back in and turn on the projector. If this doesn't solve the problem, check the status lights on top of the projector.

Note: If the  power button and light don't come on, they may have been turned off using the Illumination setting (see page 54).









Lights indicating normal operation

Light state	Cause and solution
All lights are off	The projector is turned off. If necessary, connect the power cord.
 Power button is on, power light is off	The projector is in standby mode. Press the  power button on the projector or the On button on the remote control to turn it on.



Lights indicating normal operation

Light state	Cause and solution
 Power button is on, power light flashes blue	<p>The projector is warming up. Wait for the picture to appear.</p> <p>The projector is cooling down. Wait until the power light stops flashing and remains off. Then unplug the projector, or press the  power button on the projector or the On button on the remote control to turn it back on.</p>
 Power button and power light are on	<p>Projection is in progress.</p>

Lights indicating a problem



Light state	Cause and solution
All lights are off	<p>The projector is not receiving power. Make sure the power cord is connected securely at both ends.</p>
  The temperature light flashes orange	<p>High-speed cooling is in progress. If the temperature rises further, projection will stop automatically. Make sure there is plenty of space around the projector for ventilation. Clean or replace the air filter if necessary (see page 62).</p> <p>If you are using the projector at an altitude above 4921 feet (1500 meters), turn on High Altitude Mode so the fan can cool the projector properly (see page 55).</p>
  The temperature light is red	<p>The projector is too hot, which turns off the lamp automatically. Let the projector cool for five minutes, then turn it back on. Make sure there is plenty of space around the projector for ventilation. Also, clean or replace the filter if necessary (see page 62).</p> <p>If you are using the projector at an altitude above 4921 feet (1500 meters), turn on High Altitude Mode so the fan can cool the projector properly (see page 55).</p>
  The lamp light flashes orange	<p>The lamp needs to be replaced.</p>
  The lamp light flashes red	<p>There is a problem with the lamp. If you just replaced the lamp, make sure the lamp and its cover are securely installed (see page 64). Turn off the projector and unplug it from the electrical outlet. Wait for the lamp to cool. then remove the lamp and check it for cracks. If the lamp isn't cracked, reinstall it, plug the projector into an outlet, and turn the power on. If this doesn't fix the problem, or if the lamp is cracked, contact Epson for assistance (see page 77).</p>

Lights indicating a problem



Light state	Cause and solution
 The temperature light flashes red	There is a fan or sensor problem. Turn off the projector and unplug it from the electrical outlet. Then contact Epson for assistance (see page 77).
 Both warning lights are flashing red	There is an internal problem. Turn off the projector and unplug it from the electrical outlet. Then contact Epson for assistance (see page 77).

Solving Picture Problems

You cannot turn on the projector.

- Make sure the power cord is connected. Then wait a moment for the  power button to light up before pressing the  power button on the projector or the On button on the remote control.
- If you've set the **Control Panel Lock**, the control panel buttons are disabled; you must use the remote control to turn on the projector (see page 36).
- If you've set the **Child Lock**, you have to press the  power button on the projector for 3 seconds to turn on the projector, or use the remote control (see page 36).

No picture appears on the screen or you see the No Signal message displayed.

- Press one of the **Source** buttons on the remote control, or press the  **Source** button on the projector, to select the correct input source. Allow a few seconds for the projector to sync up after pressing the button.
- Press the **A/V Mute** button on the remote control to make sure the picture hasn't been turned off temporarily.
- Check that the power light is on and not flashing, and the lens cover is off.
- The projector may be in standby (or sleep) mode. If the  power button is lit and the power light is off, press the  power button to turn the projector back on.
- Make sure your video equipment is turned on.
- Make sure your cable(s) are connected correctly (see page 18).

3D content does not display or does not display correctly.

- Press the **2D/3D** button on the remote control to switch to 3D viewing mode, if necessary.
- Make sure that you are within the 3D viewing range (see page 12).
- Check that your video device and media are both 3D-compatible. Refer to the documentation that came with your video device for more information.
- Press the **Menu** button on the remote control, select the **Signal** menu, then **3D Setup**, then select **3D Format**. Make sure that the **Auto** option is selected.
- Make sure that the **Inverse 3D Glasses** option is set to **No** (see page 45).
- If your video device is connected with the WirelessHD Transmitter (PowerLite Home Cinema 3010e only), see page 75.

Only part of the picture is displayed, or the picture is distorted.

- Press the **Aspect** button on the remote control to select a different aspect ratio (see page 27).
- If the **Aspect** is set to **Zoom**, you may need to use the **Zoom Caption Pos.** option to see the top or bottom section of the screen so that subtitles are visible (see page 53).
- Check the **Overscan** to make sure it's adjusted correctly (see page 52).
- Use the **Position** setting to reposition the image on the screen (see page 52).
- If you've connected a computer and you see only half the image, make sure the computer's **Dual Display** setting is turned off.
- If part of the image is cut off, reset the projector settings (see page 51).
- If your video device is connected with the WirelessHD Transmitter (PowerLite Home Cinema 3010e only), make sure you are within the wireless transmission range (see page 56).

You're using a computer and no picture appears on the screen.

If you're using a Windows® laptop:

- Press the function key that lets you display on an external monitor. It's often labeled with an icon such as , but it may also be labeled **CRT/LCD**. You may have to hold down the **Fn** key while pressing it. Check your laptop's manual or online help.

On most systems, the  key lets you toggle between the LCD screen and the projector, or display on both at the same time. Allow a few seconds for the projector to sync up after pressing it.

- If the function key doesn't let you display simultaneously on both screens, you might need to use the Display utility in the Windows Control Panel to make sure that both the LCD screen and external monitor port are enabled. From the Windows Control Panel, open the Display utility. In the Display Properties dialog box, click the **Settings** tab, then click **Advanced**. The method for adjusting the setting varies from computer to computer; you may need to click a **Monitor** tab, then make sure the external Monitor port is set as your primary display or enabled. See your computer manual or online help for details.





If you're using Mac OS X:

1. Open the **System Preferences** utility and select **Displays**.
2. Select the **VGA Display** or **Color LCD** option, if necessary.
3. Click the **Arrange** or **Arrangement** tab.
4. Check the **Mirror Displays** checkbox. (See your computer manual for details.)

The picture is upside-down or reversed.

Change the **Projection** setting in the Settings menu (see page 54).

The picture isn't rectangular.

- If the image looks like  or , the projector has been placed off to one side of the screen and angled toward it. Face the projector straight ahead (instead of at the center of the screen), then use the horizontal keystone slider to correct the image (see page 24).
- If the image looks like  or , make sure the projector is not tilted up or down, then use the vertical keystone buttons to adjust the image (see page 24).

The picture contains static or noise.

- Make sure the **Input Signal** is set correctly for your connected video equipment (see page 54).
- If you're viewing still images and you notice flickering or horizontal lines, turn on the **Progressive** setting (see page 42).
- Make sure your cables are securely connected at both ends.
- If you're using an extension cable, you may pick up interference if the cable is not adequately shielded. You may need to use a signal amplifier for longer cables.
- If you're displaying the same image on your computer and projector screen, try turning off your laptop's LCD display (see page 72).

The picture is blurry.

- Make sure the **Input Signal** is set correctly for your video equipment (see page 54).
- There may be dirt on the lens. Clean the lens as described on page 60.
- Adjust the focus (see page 26).
- Make sure the lens is not fogged by condensation. If you've just moved the projector from a cold environment, wait a couple of minutes before using it.
- Adjust the **Sharpness** setting (see page 41).
- If you're projecting from a computer, you may need to adjust the **Tracking** and **Sync** settings (see page 46).

The colors on the screen don't look right.

- Make sure the **Input Signal** is set correctly for your connected video equipment (see page 54).
- Press the **Color Mode** button on the remote control to select a different color mode (see page 32).
- Check the brightness and contrast settings (see page 39).
- Fine-tune the colors with the settings listed on page 43.
- If the picture looks dark, you may need to replace the lamp. Check the lamp usage timer to see how long the lamp has been in use (see page 67). Replace the lamp if it's close to the end of its service life (see page 64).

Solving Remote Control Problems

The projector doesn't respond to remote control commands.

- Make sure you're within about 32 feet (10 m) of the projector, and the remote control is aimed at the projector's front or back sensor within the ranges shown below.

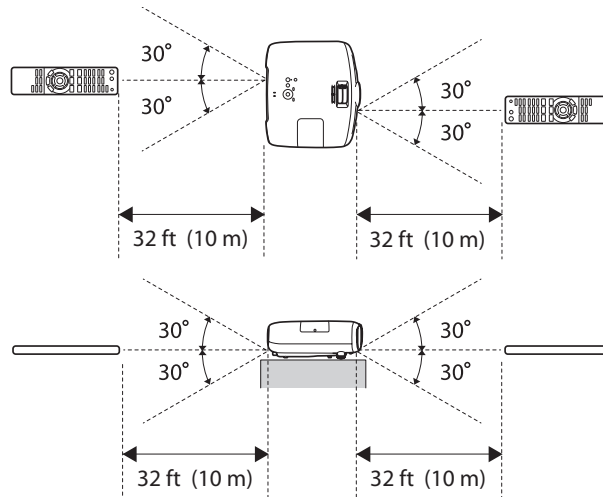

- You may need to replace the remote control batteries (see page 21). Press the  illumination button and check if the buttons glow. If they don't, replace the batteries.
- Dim the room lights and turn off any fluorescent lights. Make sure the projector is not in direct sunlight.
- Turn off nearby equipment that emits infrared energy, such as a radiant room heater.
- Make sure there are no objects between the remote control and the IR receiver.

Solving WirelessHD Problems

The projector cannot display images from the WirelessHD Transmitter.

- Open the WirelessHD reception monitor and check the strength of the WirelessHD signal (see page 47). If the signal is weak, you may need to move the transmitter closer to the projector or remove any large objects located between the transmitter and the projector.

- Make sure that your projector is connected to the correct WirelessHD device. See “WirelessHD Settings” on page 47 for more information.
- You may need to reset the WirelessHD connection. Turn off both the WirelessHD Transmitter and the projector. Start playback on your video device, then turn on the WirelessHD Transmitter and the projector. Wait 10 seconds, then press the **Setup** button on the back of the transmitter.
- Make sure the WirelessHD Transmitter is not placed on a metal surface, as this may interfere with the signal.
- If the green and orange lights on the transmitter are flashing, the unit may be overheating. Make sure the vents on the back of the transmitter are not blocked and that the room temperature does not exceed 95 °F (35 °C).

WirelessHD images are displayed, but the picture quality is low.

The resolution and overall image quality are automatically adjusted based on the strength of the WirelessHD signal. Check the WirelessHD reception (see page 47) and adjust the position of the transmitter, if necessary.

Where to Get Help

Internet Support

Epson provides technical assistance 24 hours a day at epson.com/support (U.S.) or epson.ca/support (Canada). Here you can access troubleshooting information, download product documentation, and receive technical advice through email.

Speak to a Support Representative

To use the Epson PrivateLine Support service, call (800) 637-7661 and enter the PIN on the Epson PrivateLine Support card that came with your projector. This is the fastest way of speaking to a live representative, and it's free. This service is available 6 AM to 6 PM, Pacific Time, Monday through Friday, for the duration of your warranty period.

You may also speak with a projector support specialist by dialing one of these numbers:

- U.S.: (562) 276-4394, 6 AM to 8 PM, Pacific Time, Monday through Friday, and 7 AM to 4 PM, Pacific Time, Saturday
- Canada: (905) 709-3839, 6 AM to 8 PM, Pacific Time, Monday through Friday

Days and hours of support are subject to change without notice. Toll or long distance charges may apply.

Before you call, please have the following information ready:

- Product name (PowerLite Home Cinema 3010 or PowerLite Home Cinema 3010e)
- Product serial number (located on the bottom of the projector or in the projector's Info menu)
- Computer configuration, if you're connected to a computer
- Description of the problem

Purchase Supplies and Accessories

You can purchase screens, carrying cases, or other accessories from an authorized Epson reseller. To find the nearest reseller, call 800-GO-EPSON (800-463-7766). To purchase online, visit www.epsonstore.com (U.S. sales) or www.epson.ca (Canadian sales).

Specifications

General

Type of display	Poly-silicon TFT active matrix
Size of LCD panels	0.61 inch (15.5 mm) wide
Lens	F=1.51 to 1.99
Resolution (native format)	1920 × 1080 pixels, 1080p
Brightness	Normal mode: White light output up to 2200 lumens (ISO 21118 standard) Color light output up to 2200 lumens ECO mode: White light output up to 1000 lumens
Dynamic contrast ratio	2D: Up to 40,000:1 3D: Up to 1,600:1
Image size	30 to 300 inches (0.76 to 7.62 m)
Projection distance	2.85 to 47.57 feet (0.87 to 14.50 m)
Zoom ratio	1 to 1.6
Aspect ratio	16:9 (supports 4:3 to 16:10)
Internal sound system	10 W per channel (stereo)
Fan noise level	Normal mode: 32 dB ECO mode: 24 dB

Lamp

Note: Lamp life will vary depending on mode selected, environmental conditions, and usage. Brightness decreases over time.

Turn off this product when not in use to prolong the life of the projector.

Type	UHE (Ultra High Efficiency), E-TORL
------	-------------------------------------

Power consumption	230 W
Lamp life	4000 hours (Normal mode) 5000 hours (ECO mode)
Part number	V12H010L68

Remote Control

Range	Approximately 32 feet (10 m)
Batteries	AA × 2

WirelessHD Transmitter (Home Cinema 3010e only)

Usable frequency	60 GHz band (2 – 3 ch)
AC adapter	4.75 – 5.25 V DC
Transmission range	32 feet (10 m)
WirelessHD standards	Conforms to WirelessHD Ver. 1.0a
Power consumptions	During operation: 5.6 W During standby: 0.71 W
Operating temperature	41 to 95 °F (5 to 35 °C)
Copyright protection	HDCP compatible
Dimensions	Height: 2.3 inches (59 mm) Width: 6.1 inches (157 mm) Depth: 2.4 inches (61 mm)
Weight	Approx. 0.4 lb (0.2 kg)

Dimensions

Height	5.4 inches (137.3 mm), not including adjustable feet
Width	14.4 inches (365 mm)
Depth	16.5 inches (420 mm); not including lens protrusion
Weight	13.2 lb (6.0 kg) (Home Cinema 3010) 13.7 lb (6.2 kg) (Home Cinema 3010e)

Electrical

Rated frequency	50/60 Hz AC
Power supply	100 to 120 V AC: 3.7 A 200 to 240 V AC: 1.7 A
Power consumption	100 to 120 V AC: Operating: 372 W (Normal mode) 285 W (ECO mode) Standby: 0.25 W (with HDMI Link enabled) 220 to 240 V AC: Operating: 358 W (Normal mode) 274 W (ECO mode) Standby: 0.35 W (with HDMI Link enabled)

Environmental

Temperature	Operating: 41 to 95 °F (5 to 35 °C) Storage: 14 to 140 °F (–10 to 60 °C)
Humidity	Operating: 20 to 80% RH, non-condensing Storage: 10 to 90% RH, non-condensing
Operating altitude	Up to 7500 feet (2286 meters); over 4921 feet (1500 meters), enable High Altitude mode in the Operation menu (see page 55)

Safety

United States	FCC Part 15B Class B (DoC) UL60950-1 2 nd edition
Canada	ICES-003 Class B CSA C22.2 No. 60950-1-07



Pixelworks DNX™ ICs are used in this projector.

Compatible Video Formats

The projector supports analog video in NTSC, PAL, and SECAM formats, and it automatically adjusts to the incoming signal. It can receive these formats as composite or component video—which it accepts through the Video and Component ports, respectively.

The projector also supports digital video (SDTV, HDTV) and various monitor display formats. Digital video is accepted by the HDMI and Component video ports. The PC port accepts analog RGB computer monitor signals.

If necessary, you can select a different Aspect setting to optimize the image. The resolution at which the image displays for a given setting depends on the currently active picture source, as listed in the following tables.

Composite video

Format	Refresh rate (Hz)	Resolution
NTSC	60	720 × 480
PAL	50/60	720 × 576
SECAM	50	720 × 576

Component video

Format/ Signal	Refresh rate (Hz)	Resolution
SDTV		
480i	60	720 × 480
576i	50	720 × 576
480p	60	720 × 480
576p	50	720 × 576
HDTV		
720p	50/60	1280 × 720
1080i	50/60	1920 × 1080
1080p	50/60	1920 × 1080

Analog RGB (computer display)

Signal	Refresh rate (Hz)	Resolution
VGA	60/72/75/85	640 × 480
SVGA	56/60/72/ 75/85	800 × 600
XGA	60/70/75/85	1024 × 768
SXGA	70/75/85	1152 × 864
	60/75/85	1280 × 960
	60/75/85	1280 × 1024
WXGA	60	1280 × 768
	60	1360 × 768
	60/75/85	1280 × 800

HDMI

Signal	Refresh rate (Hz)	Resolution
VGA	60	640 × 480
SDTV 480i 576i 480p 576p	60	720 × 480
	50	720 × 576
	60	720 × 480
	50	720 × 576
HDTV 720p 1080i 1080p	50/60	1280 × 720
	50/60	1920 × 1080
	24/50/60	1920 × 1080

3D mode

Signal	Refresh rate (Hz)	Resolution
HDTV 720p 1080i 1080p	50/60	1280 × 720
	50/60	1920 × 1080
	24/50/60	1920 × 1080
		1920 × 1080

WirelessHD

Signal	Refresh rate (Hz)	Resolution
VGA	60	640 × 480
SDTV 480i 576i 480p 576p	60	720 × 480
	50	720 × 576
	60	720 × 480
	50	720 × 576

Signal	Refresh rate (Hz)	Resolution
HDTV 720p	50/60	1280 × 720
1080i	50/60	1920 × 1080
1080p	24/50/60	1920 × 1080

ESC/VP21 Command Codes

You can use an AV controller with a 9-pin null modem serial cable to control the projector. You can download the complete *ESC/VP 21 Communication Manual* for home theater projectors from the Epson website at epson.com/support (U.S.) or epson.ca/support (Canada).

Notices

Important Safety Information

Follow these safety instructions when setting up and using the projector:

- Never look into the projector lens when the lamp is turned on; the bright light can damage your eyes. Never let children look into the lens when it is on.
- If you or any viewer experiences the following symptoms or other major discomfort from viewing 3D video images, immediately stop viewing and contact your health care provider: convulsions, eye or muscle twitching, loss of awareness, altered vision, involuntary movements, disorientation, eye strain, nausea/vomiting, dizziness, headaches, fatigue, or blurry/double vision that lasts longer than a few seconds. Do not engage in any potentially hazardous activity (such as driving a vehicle or operating machinery) until your symptoms have completely gone away. If the symptoms persist, discontinue use and do not resume stereoscopic 3D viewing without discussing your symptoms with a health care provider / physician.
- Some viewers may experience a seizure or blackout when exposed to flashing images or lights contained in certain 3D content. Anyone who has a history of seizures, loss of awareness, symptoms linked to an epileptic condition, or has a family history of epilepsy, should contact a health care provider before using the 3D function. It is recommended that all viewers take regular breaks while watching 3D video images or playing stereoscopic 3D games. The suggested breaks are, at least 5 to 15 minutes after every 30 to 60 minutes of stereoscopic 3D content viewing.*

*Based on the guidelines issued by the 3D Consortium revised December 10, 2008. The length and frequency of necessary breaks will vary from person to person. If you experience any discomfort, you should immediately stop watching the 3D video images or playing stereoscopic 3D games until the discomfort ends; consult a health care provider / physician if necessary.

- Due to the possible impact on vision development, viewers of 3D video images should be age 6 or older. Children and teenagers may be more susceptible to health issues associated with viewing in 3D and should be closely supervised to avoid prolonged viewing without rest.
- Watching the screen while sitting too close for an extended period of time may cause eye strain. Consult your projector manual to determine the ideal viewing distance.
- Viewing 3D content may cause dizziness and disorientation for some viewers. Therefore, to avoid injury do not place your projector or screen near open stairwells, balconies, or wires, and do not sit near objects that could be broken if accidentally hit.

- The following people should limit 3D content viewing:
 - People with a history of photosensitivity
 - People with heart disease
 - People in poor health
 - People who are sleep deprived
 - People who are physically tired
 - People under the influence of drugs or alcohol
 - Anyone who has ever experienced epileptic seizures or sensory disturbances triggered by flashing light effects
- SOME LIGHT PATTERNS MAY INDUCE SEIZURES IN PERSONS WITH NO PRIOR HISTORY OF EPILEPSY.
- Never open any cover on the projector, except the lamp and filter covers. Dangerous electrical voltages inside the projector can severely injure you.
 - Except as specifically explained in this *User's Guide*, do not attempt to service this product yourself. Refer all servicing to qualified service personnel.
 - The projector and its accessories come packaged in plastic bags. Keep plastic bags away from small children to avoid any risk of suffocation.
 - Don't place the projector on an unstable cart, stand, or table. Also, don't use the projector near water or sources of heat.
 - Use the type of power source indicated on the projector. If you're not sure of the power available, consult your dealer or power company.
 - Place the projector near a wall outlet where the plug can be easily unplugged.
 - Don't insert the plug into an outlet with dust present, and insert the plug firmly into the outlet. Failure to do so could result in sparks or fire.
 - Don't overload wall outlets, extension cords, or integral convenience receptacles. This can cause fire or electric shock.
 - Don't block the slots and openings in the projector case. They provide ventilation and prevent the projector from overheating. Don't operate the projector on a sofa, rug, or other soft surface, or in a closed-in cabinet unless proper ventilation is provided.
 - Never push objects through the cabinet slots or spill liquid into the projector.
 - Unplug the projector from the wall outlet and refer servicing to qualified service personnel under the following conditions: when the power cord or plug is damaged or frayed; if liquid has been spilled into the projector, or if it has been exposed to rain or water; if it doesn't operate normally when you follow the operating instructions, or if it exhibits a distinct change in performance, indicating a need for service; if it has been dropped or the housing has been damaged.
 - Don't place the projector where the cord can be walked on. This may result in fraying or damage to the plug.
 - Unplug the projector from the wall outlet before cleaning. Use a damp cloth for cleaning. Do not use liquid or aerosol cleaners.
 - (Hg) The lamp(s) in this product contain mercury. Please consult your state and local regulations regarding disposal or recycling. Do not put in the trash.

- Allow the lamp to cool for one hour before replacing it.
- Unplug the projector during lightning storms or when not in use for extended periods.
- Don't place the projector or remote control on top of heat-producing equipment.
- If you use the projector in a country other than where you purchased it, use the correct power cord for that country.
- Don't stand on the projector or place heavy objects on it.
- Don't use the projector outside of the required temperature range of 41 to 95 °F (5 to 35 °C). Doing so may cause an unstable display and could lead to projector damage.
- Don't store the projector outside of the required temperature range of 14 to 140 °F (–10 to 60 °C) or in direct sunlight for long periods of time. Doing so may cause damage to the case.

WARNING: The cords included with this product contain chemicals, including lead, known to the State of California to cause birth defects or other reproductive harm. *Wash hands after handling.* (This notice is provided in accordance with Proposition 65 in Cal. Health & Safety Code § 25249.5 and following.)

FCC Compliance Statement

For United States Users

This equipment has been tested and found to comply with the limits for a Class B digital device, pursuant to Part 15 of the FCC Rules. These limits are designed to provide reasonable protection against harmful interference in a residential installation. This equipment generates, uses, and can radiate radio frequency energy and, if not installed and used in accordance with the instructions, may cause harmful interference to radio or television reception. However, there is no guarantee that interference will not occur in a particular installation. If this equipment does cause interference to radio and television reception, which can be determined by turning the equipment off and on, the user is encouraged to try to correct the interference by one or more of the following measures:

- Reorient or relocate the receiving antenna.
- Increase the separation between the equipment and receiver.
- Connect the equipment into an outlet on a circuit different from that to which the receiver is connected.
- Consult the dealer or an experienced radio/TV technician for help.

WARNING

The connection of a non-shielded equipment interface cable to this equipment will invalidate the FCC Certification of this device and may cause interference levels which exceed the limits established by the FCC for this equipment. It is the responsibility of the user to obtain and use a shielded equipment

interface cable with this device. If this equipment has more than one interface connector, do not leave cables connected to unused interfaces. Changes or modifications not expressly approved by the manufacturer could void the user's authority to operate the equipment.

For Canadian Users

This Class B digital apparatus meets all requirements of the Canadian Interference-Causing Equipment Regulations.

Cet appareil numérique de la classe B respecte toutes les exigences du Règlement sur le matériel brouilleur du Canada.

Copyright Notice

All rights reserved. No part of this publication may be reproduced, stored in a retrieval system, or transmitted in any form or by any means, electronic, mechanical, photocopying, recording, or otherwise, without the prior written permission of Seiko Epson Corporation. The information contained herein is designed only for use with this Epson product. Epson is not responsible for any use of this information as applied to other products.

Neither Seiko Epson Corporation nor its affiliates shall be liable to the purchaser of this product or third parties for damages, losses, costs, or expenses incurred by purchaser or third parties as a result of: accident, misuse, or abuse of this product or unauthorized modifications, repairs, or alterations to this product, or (excluding the U.S.) failure to strictly comply with Seiko Epson Corporation's operating and maintenance instructions.

Seiko Epson Corporation shall not be liable for any damages or problems arising from the use of any options or any consumable products other than those designated as Original Epson Products or Epson Approved Products by Seiko Epson Corporation.

A Note Concerning Responsible Use of Copyrighted Materials

Epson encourages each user to be responsible and respectful of copyright laws when using any Epson product. While some countries' laws permit limited copying or reuse of copyrighted material in certain circumstances, those circumstances may not be as broad as some people assume. Contact your legal advisor for any questions regarding copyright law.

Trademarks

Epson, PowerLite, and C²Fine are registered trademarks, 1080Perfect is a trademark, and Epson Exceed Your Vision is a registered logomark of Seiko Epson Corporation.

PrivateLine is a registered trademark, DigiScan and AccuCinema are trademarks, and Extra Care and Epson Connection are service marks of Epson America, Inc.

HDMI, the HDMI logo, and High-Definition Multimedia Interface are registered trademarks of HDMI Licensing, LLC.



WirelessHD is a registered trademark of WirelessHD LLC.



General Notice: Other product names used herein are for identification purposes only and may be trademarks of their respective owners. Epson disclaims any and all rights in those marks.

This information is subject to change without notice.