

DIGITAL CAMERA

FINEPIX AX200 Series FINEPIX AV100 Series

Owner's Manual

Thank you for your purchase of this product. This manual describes how to use your FUJIFILM FinePix AX200 series, AV100 series digital camera and the supplied software. Be sure that you have read and understood its contents before using the camera.

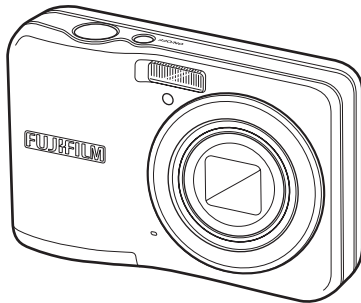

For information on related products, visit our website at
http://www.fujifilm.com/products/digital_cameras/index.html



Before You Begin

First Steps

Basic Photography and Playback

More on Photography

More on Playback

Movies

Connections

Menus

Technical Notes

Troubleshooting

Appendix

IMPORTANT SAFETY INSTRUCTIONS

- **Read Instructions:** All the safety and operating instructions should be read before the appliance is operated.
- **Retain Instructions:** The safety and operating instructions should be retained for future reference.
- **Heed Warnings:** All warnings on the appliance and in the operating instructions should be adhered to.
- **Follow Instructions:** All operating and use instructions should be followed.

Installation

Power Sources: This video product should be operated only from the type of power source indicated on the marking label. If you are not sure of the type of power supply to your home, consult your appliance dealer or local power company. For video products intended to operate from battery power, or other sources, refer to the operating instructions.

Grounding or Polarization: This video product is equipped with a polarized alternating-current line plug (a plug having one blade wider than the other). This plug will fit into the power outlet only one way. This is a safety feature. If you are unable to insert the plug fully into the outlet, try reversing the plug. If the plug should still fail to fit, contact your electrician to replace

your obsolete outlet. Do not defeat the safety purpose of the polarized plug.

Alternate Warnings: This video product is equipped with a 3-wire grounding-type plug, a plug having a third (grounding) pin. This plug will only fit into a grounding-type power outlet. This is a safety feature. If you are unable to insert the plug into the outlet, contact your electrician to replace your obsolete outlet. Do not defeat the safety purpose of the grounding-type plug.

Overloading: Do not overload wall outlets and extension cords as this can result in a risk of fire or electric shock.

Ventilation: Slots and openings in the cabinet are provided for ventilation and to ensure reliable operation of the video product and to protect it from overheating, and these openings must not be blocked or covered. The openings should never be blocked by placing the video product on a bed, sofa, rug, or other similar surface. This video product should not be placed in a built-in installation such as a bookcase or rack unless proper ventilation is provided or the

manufacturer's instructions have been adhered to. This video product should never be placed near or over a radiator or heat register.

Attachments: Do not use attachments not recommended by the video product manufacturer as they may cause hazards.

Water and Moisture: Do not use this video product near water – for example, near a bath tub, wash bowl, kitchen sink, or laundry tub, in a wet basement, or near a swimming pool, and the like.

Power-Cord Protection: Power-Supply cords should be routed so that they are not likely to be walked on or pinched by items placed upon or against them, paying particular attention to cords at plugs, convenience receptacles, and the point where they exit from the appliance.

Accessories: Do not place this video product on an unstable cart, stand, tripod, bracket, or table. The video product may fall, causing serious injury to a child or adult, and serious damage to the appliance. Use only with a cart, stand, tripod, bracket, or table recommended by the manufacturer, or sold with the video product. Any mounting

of the appliance should follow the manufacturer's instructions, and should use a mounting accessory recommended by the manufacturer.

An appliance and cart combination should be moved with care. Quick stops, excessive force, and uneven surfaces may cause the appliance and cart combination to overturn.



Antennas

Outdoor Antenna Grounding: If an outside antenna or cable system is connected to the video product, be sure the antenna or cable system is grounded so as to provide some protection against voltage surges and built-up static charges. Section 810 of the National Electrical Code, ANSI/NFPA No. 70, provides information with respect to proper grounding of the mast and supporting structure, grounding of the lead-in wire to an antennadischarge unit, size of grounding conductors, location of antenna-discharge unit, connection to grounding electrodes, and requirements for the grounding electrode.

Power Lines: An outside antenna system should not be located in the vicinity of overhead power lines or other electric light or power circuits, or where it can fall into such power lines or circuits. When installing an outside antenna system, extreme care should be taken to keep from touching such power lines or circuits as contact with them might be fatal.

EXAMPLE OF ANTENNA GROUNDING AS PER NATIONAL ELECTRICAL CODE

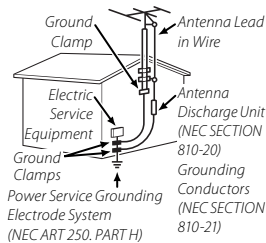

Use

Cleaning: Unplug this video product from the wall outlet before cleaning. Do not use liquid cleaners or aerosol cleaners. Use a damp cloth for cleaning.

Object and Liquid Entry: Never push objects of any kind into this video product through openings as they may touch dangerous voltage points or shortout parts that could result in a fire or electric shock.

Never spill liquid of any kind on the video product.

Lightning: For added protection for this video product receiver during a lightning storm, or when it is left unattended and unused for long periods of time, unplug it from the wall outlet and disconnect the antenna or cable system. This will prevent damage to the video product due to lightning and power-line surges.

Service

Servicing: Do not attempt to service this video product yourself as opening or removing covers may expose you to dangerous voltage or other hazards. Refer all servicing to qualified service personnel.

Damage Requiring Service: Unplug this video product from the wall outlet and refer servicing to qualified service personnel under the following conditions:

- When the power-supply cord or plug is damaged.
- If liquid has been spilled, or objects have fallen into the video product.
- If the video product has been exposed to rain or water.
- If the video product has been dropped or the cabinet has been damaged.
- If the video product does not operate normally by following the operating instructions. Adjust only

those controls that are covered by the operating instructions as an improper adjustment of other controls may result in damage and will often require extensive work by a qualified technician to restore the video product to its normal operation.

When the video product exhibits a distinct change in performance - this indicates a need for service.

Replacement Parts: When replacement parts are required, be sure the service technician has used replacement parts specified by the manufacturer or have the same characteristics as the original part. Unauthorized substitutions may result in fire, electric shock or other hazards.

Safety Check: Upon completion of any service or repairs to this video product, ask the service technician to perform safety checks to determine that the video product is in proper operating condition.

Be sure to read this notes before using

Safety Notes

- Make sure that you use your camera correctly. Read these Safety Notes and your Owner's Manual carefully before use.
- After reading these Safety Notes, store them in a safe place.

About the Icons

- The icons shown below are used in this document to indicate the severity of the injury or damage that can result if the information indicated by the icon is ignored and the product is used incorrectly as a result.



WARNING

This icon indicates that death or serious injury can result if the information is ignored.



CAUTION

This icon indicates that personal injury or material damage can result if the information is ignored.

The icons shown below are used to indicate the nature of the information which is to be observed.



Triangular icons tell you that this information requires attention ("important").



Circular icons with a diagonal bar tell you that the action indicated is prohibited ("Prohibited").



Filled circles with an exclamation mark tell you an action that must be performed ("Required").

WARNING



Unplug from power socket

If a problem arises, turn the camera off, remove the battery, disconnect and unplug the AC power adapter.

Continued use of the camera when it is emitting smoke, is emitting any unusual odor, or is in any other abnormal state can cause a fire or electric shock.

- Contact your FUJIFILM dealer.



Do not allow water or foreign objects to enter the camera.

If water or foreign objects get inside the camera, turn the camera off, remove the battery and disconnect and unplug the AC power adapter. Continued use of the camera can cause a fire or electric shock.

- Contact your FUJIFILM dealer.



Do not use in the bathroom or shower

Do not use the camera in the bathroom or shower.

This can cause a fire or electric shock.



Do not disassemble

Never attempt to change or take apart the camera. (Never open the casing.) Do not use the camera when it has been dropped or the casing is damaged.

This can cause a fire or electric shock.

- Contact your FUJIFILM dealer.



Do not change, heat or unduly twist or pull the connection cord and do not place heavy objects on the connection cord.

These actions could damage the cord and cause a fire or electric shock.

- If the cord is damaged, contact your FUJIFILM dealer.



Do not place the camera on an unstable surface.

This can cause the camera to fall or tip over and cause injury.



Never attempt to take pictures while in motion.

Do not use the camera while you are walking or driving a vehicle. This can result in you falling down or being involved in a traffic accident.



Do not touch any metal parts of the camera during a thunderstorm.

This can cause an electric shock due to induced current from the lightning discharge.



Do not use the battery except as specified.

Load the battery as aligned with the indicator.

⚠ WARNING

Do not heat, change or take apart the battery. Do not drop or subject the battery to impacts. Do not store the battery with metallic products. Do not use chargers other than the specified model to charge the battery.

Any of these actions can cause the battery to burst or leak and cause fire or injury as a result.



Use only the battery or AC power adapters specified for use with this camera. Do not use voltages other than the power supply voltage shown.

The use of other power sources can cause a fire.



If the battery leaks and fluid gets in contact with your eyes, skin or clothing. Flush the affected area with clean water and seek medical attention or call an emergency number right away.



Do not use the charger to charge batteries other than those specified here.

The Ni-MH battery charger is designed for Fujifilm HR-AA Ni-MH batteries. Using the charger to charge conventional batteries or other types of rechargeable batteries can cause the battery to leak fluid, overheat or burst.



When carrying the battery, install it in a digital camera or keep it in the hard case. When storing the battery, keep it in the hard case. When discarding, cover the battery terminals with insulation tape.

Contact with other metallic objects or battery could cause the battery to ignite or burst.



Keep Memory Cards out of the reach of small children.

Because Memory Cards are small, they can be swallowed by children. Be sure to store Memory Cards out of the reach of small children. If a child swallows a Memory Card, seek medical attention or call an emergency number.

⚠ CAUTION

Do not use this camera in locations affected by oil fumes, steam, humidity or dust.

This can cause a fire or electric shock.



Do not leave this camera in places subject to extremely high temperatures.

Do not leave the camera in locations such as a sealed vehicle or in direct sunlight. This can cause a fire.

⚠ CAUTION

Keep out of the reach of small children.

This product could cause injury in the hands of a child.



Do not place heavy objects on the camera.

This can cause the heavy object to tip over or fall and cause injury.



Do not move the camera while the AC power adapter is still connected. Do not pull on the connection cord to disconnect the AC power adapter.

This can damage the power cord or cables and cause a fire or electric shock.



Do not use the AC power adapter when the plug is damaged or the plug socket connection is loose.

This could cause a fire or electric shock.



Do not cover or wrap the camera or the AC power adapter in a cloth or blanket.

This can cause heat to build up and distort the casing or cause a fire.



When you are cleaning the camera or you do not plan to use the camera for an extended period, remove the battery and disconnect and unplug the AC power adapter.

Failure to do so can cause a fire or electric shock.



When charging ends, unplug the charger from the power socket.

Leaving the charger plugged into the power socket can cause a fire.



Using a flash too close to a person's eyes may temporarily affect the eyesight.

Take particular care when photographing infants and young children.



When an xD-Picture Card is removed, the card could come out of the slot too quickly. Use your finger to hold it and gently release the card.



Request regular internal testing and cleaning for your camera.

Build-up of dust in your camera can cause a fire or electric shock.

- Contact your FUJIFILM dealer to request internal cleaning every 2 years.
- Please note this is not a free of charge service.

Power Supply and Battery

* Confirm your battery type before reading the following descriptions.

The following explains proper use of batteries and how to prolong their life. Incorrect use of batteries can cause shorter battery life, as well as leakage, excessive heat, fire or explosion.

1 Camera uses the Rechargeable Lithium-ion Battery

- * When shipped, the battery is not fully charged. Always charge the battery before using it.
- * When carrying the battery, install it in a digital camera or keep it in the soft case.

Battery Features

- The battery gradually loses its charge even when not used. Use a battery that has been charged recently (in the last day or two) to take pictures.
- To maximize the life of the battery, turn the camera off as quickly as possible when it is not being used.
- The number of available frames will be lower in cold locations or at low temperatures. Take along a spare fully charged battery. You can also increase the amount of power produced by putting the battery in your pocket or another warm place to heat it and then loading it into the camera just before you take a picture. If you are using a heating pad,

take care not to place the battery directly against the pad. The camera may not operate if you use a depleted battery in cold conditions.

Charging the Battery

- You can charge the battery using the battery charger (included).
- The battery can be charged at ambient temperatures between 0°C and +40°C (+32°F and +104°F). Refer to the OWNER'S MANUAL for the time of charging battery.
- You should charge the battery at an ambient temperature between +10°C and +35°C (+50°F and +95°F). If you charge the battery at a temperature outside this range, charging takes longer because the performance of the battery is impaired.
- You cannot charge the battery at temperatures of 0°C (+32°F) or below.
- The Rechargeable Lithium-ion Battery does not need to be fully discharged or exhausted flat before being charged.
- The battery may feel warm after it has been charged or immediately after being used. This is perfectly normal.
- Do not recharge a fully charged battery.

Battery Life

At normal temperatures, the battery can be used at least 300 times. If the time for which the battery provides power shortens markedly, this indicates that the battery has reached the end of its effective life and should be replaced.

Notes on storage

- If a battery is stored for long periods while charged, the performance of the battery can be impaired. If the battery will not be used for some time, run the battery out before storing it.
- If you do not intend to use the camera for a long period of time, remove the battery from the camera.
- Store the battery in a cool place.
 - The battery should be stored in a dry location with an ambient temperature between +15°C and +25°C (+59°F and +77°F).
 - Do not leave the battery in hot or extremely cold places.
- **Handling the Battery Cautions for Your Safety:**
 - Do not carry or store battery with metal objects such as necklaces or hairpins.
 - Do not heat the battery or throw it into a fire.
 - Do not attempt to take apart or change the battery.
 - Do not recharge the battery with chargers other than those specified.

- Dispose of used battery promptly.
- Do not drop the battery or otherwise subject it to strong impacts.
- Do not expose the battery to water.
- Always keep the battery terminals clean.
- Do not store batteries in hot places. Also, if you use the battery for a long period, the camera body and the battery itself will become warm. This is normal. Use the AC power adapter if you are taking pictures or viewing images for a long period of time.

2 Camera uses AA-size alkaline or Ni-MH (nickelmetal hydride) rechargeable batteries

- * For details on the batteries that you can use, refer to the OWNER'S MANUAL of your camera.
- **Cautions for Using Battery**
 - Do not heat the batteries or throw them into a fire.
 - Do not carry or store batteries with metal objects such as necklaces or hairpins.
 - Do not expose the batteries to water, and keep batteries from getting wet or stored in moist locations.
 - Do not attempt to take apart or change the batteries, including battery casings.
 - Do not subject the batteries to strong impacts.

- Do not use batteries that are leaking, deformed, discolored.
- Do not store batteries in warm or humid places.
- Keep the batteries out of reach of babies and small children.
- Make sure that the battery polarity (⊕ and ⊖) is correct.
- Do not use new with used batteries. Do not use charged and discharged batteries together.
- Do not use different types or brands of batteries at the same time.
- If you do not intend to use the camera for a long period of time, remove the batteries from the camera. Note if the camera is left with the batteries removed, the time and date settings are cleared.
- The batteries feel warm right after being used. Before removing the batteries, turn the camera off and wait for the batteries to cool down.
- Since batteries do not work well in cold weather or locations, warm the batteries by placing them inside your garments before use. Batteries do not work well when cold. They will work again when the temperature returns to normal.
- Soil (such as fingerprints) on the battery terminals makes the batteries charge less reducing the number of images. Carefully wipe the battery terminals with a soft dry cloth before loading.



If any liquid at all leaks from the batteries, wipe the battery compartment thoroughly and then load new batteries.



If any battery fluid comes into contact with your hands or clothing, flush the area thoroughly with water. Note that battery fluid can cause loss of eyesight if it gets into your eyes. If this occurs, do not rub your eyes. Flush the fluid out with clean water and contact your physician for treatment.

■ Using the AA-size Ni-MH batteries correctly

- Ni-MH batteries left unused in storage for long periods can become “deactivated”. Also, repeatedly charging Ni-MH batteries that are only partially discharged can cause them to suffer from the “memory effect”. Ni-MH batteries that are “deactivated” or affected by “memory” suffer from the problem of only providing power for a short time after being charged. To prevent this problem, discharge and recharge them several times using the camera’s “Discharging rechargeable batteries” function. Deactivation and memory are specific to Ni-MH batteries and are not in fact battery faults. See OWNER’S MANUAL for the

procedure for “Discharging rechargeable batteries”.

⚠ CAUTION

Do not use the “Discharging rechargeable batteries” function when alkaline batteries being used.

- To charge Ni-MH batteries, use the quick battery charger (sold separately). Refer to the instructions supplied with the charger to make sure that the charger is used correctly.
- Do not use the battery charger to charge other batteries.
- Note that the batteries feel warm after being charged.
- Due to the way the camera is constructed, a small amount of current is used even when the camera is turned off. Note in particular that leaving Ni-MH batteries in the camera for a long period will overdischarge the batteries and may render them unusable even after recharging.
- Ni-MH batteries will self-discharge even when not used, and the time for which they can be used may be shortened as a result.
- Ni-MH batteries will deteriorate rapidly if overdischarged (e.g. by discharging the batteries in a flashlight). Use the “Discharging rechargeable batteries” function provided in the camera to discharge the batteries.
- Ni-MH batteries have a limited service life. If a battery can only be

used for a short time even after repeated discharge-charge cycles, it may have reached the end of its service life.

■ Disposing of Batteries

- When disposing of batteries, do so in accordance with your local waste disposal regulations.

3 Notes on both models (1, 2)

■ AC Power Adapter

Always use the AC Power Adapter with the camera. The use of an AC Power adapter other than FUJIFILM AC Power Adapter can be damaged to your digital camera.

For details on the AC power adapter, refer to the OWNER’S MANUAL of your camera.

- Use the AC power adapter for indoor use only.
- Plug the connection cord plug securely into the DC input terminal.
- Turn off the FUJIFILM Digital camera before disconnecting the cord from the DC input terminal. To disconnect, pull out the plug gently. Do not pull on the cord.
- Do not use the AC power adapter with any device other than your camera.
- During use, the AC power adapter will become hot to the touch. This is normal.

- Do not take apart the AC power adapter. Doing so could be dangerous.
- Do not use the AC power adapter in a hot and humid place.
- Do not subject the AC power adapter to strong shocks.
- The AC power adapter may emit a humming. This is normal.
- If used near a radio, the AC power adapter may cause static. If this happens, move the camera away from the radio.

Before Using the Camera

■ Test Shots Prior to Photography

For important photographs (such as weddings and overseas trips), always take a test shot and view the image to make sure that the camera is working normally.

- FUJIFILM Corporation cannot accept liability for any incidental losses (such as the costs of photography or the loss of income from photography) incurred as a result of faults with this product.

■ Notes on Copyright

Images recorded using your digital camera system cannot be used in ways that infringe copyright laws without the consent of the owner, unless intended only for personal use. Note that some restrictions apply to the photographing of stage performances, entertainments and exhibits, even when intended

purely for personal use. Users are also asked to note that the transfer of Memory Card containing images or data protected under copyright laws is only permissible within the restrictions imposed by those copyright laws.

■ Handling Your Digital Camera

To ensure that images are recorded correctly, do not subject the camera to impact or shock while an image is being recorded.

■ Liquid Crystal

If the LCD monitor is damaged, take particular care with the liquid crystal in the monitor. If any of the following situations arise, take the urgent action indicated.

- If liquid crystal comes in contact with your skin:
Wipe the area with a cloth and then wash thoroughly with soap and running water.
- If liquid crystal gets into your eye:
Flush the affected eye with clean water for at least 15 minutes and then seek medical assistance.
- If liquid crystal is swallowed:
Flush your mouth thoroughly with water. Drink large quantities of water and induce vomiting. Then seek medical assistance.

■ Trademark Information

-  and **xD-Picture Card™** are trademarks of FUJIFILM Corporation.

- IBM PC/AT is a registered trademark of International Business Machines Corp. of the U.S.A.
- Macintosh, Quick-Time, and Mac OS are trademarks of Apple Inc. in the U.S.A. and other countries.
- Windows 7, Windows Vista and the Windows logo are trademarks of the Microsoft group of companies.
- IrSimple™ Trademark is owned by the Infrared Data Association®.
- IrSS™ Trademark or IrSimpleShot™ Trademark is owned by the Infrared Data Association®.
- SDHC logo is a trademark.
- HDMI logo is a trademark.
- YouTube is a trademark of Google Inc.
- Other company or product names are trademarks or registered trademarks of the respective companies.

■ Notes on Electrical Interference

If the camera is to be used in hospitals or aircrafts, please note that this camera may cause interference to other equipment in the hospital or aircraft. For details, please check with the applicable regulations.

■ Explanation of Color Television System

NTSC: National Television System Committee, color television telecasting specifications adopted mainly in the U.S.A., Canada and Japan.

PAL: Phase Alternation by Line, a color television system adopted mainly by European countries and China.

■ Exif Print (Exif ver. 2.2)

Exif Print Format is a newly revised digital camera file format that contains a variety of shooting information for optimal printing.

About This Manual

Before using the camera, read this Owner's Manual and the other supplied documents. For information on specific topics, consult the sources below.

✓ **Camera Q & A** pg. x

Know what you want to do but don't know the name for it? Find the answer in "Camera Q & A."

✓ **Table of Contents** pg. xiii

The "Table of Contents" gives an overview of the entire manual. The principal camera operations are listed here.

✓ **Troubleshooting** pg. 83

Having a specific problem with the camera? Find the answer here.

✓ **Warning Messages and Displays** pg. 89

Find out what's behind that flashing icon or error message in the monitor.

✓ **Glossary** pg. 93

The meanings of some technical terms may be found here.

✓ **Restrictions on Camera Settings**

See another supplied document for restrictions on the options available in each shooting mode.

 **Memory Cards**

Pictures can be stored in the camera's internal memory or on optional SD and SDHC memory cards. In this manual, SD memory cards are referred to as "memory cards." For more information, see page 5.



Camera Q & A

Find items by task.

Camera Setup

Question	Key phrase	See page
How do I set the camera clock?	Date and time	10
Can I set the clock to local time when I travel?	Time difference	75
How do I keep the monitor from turning off automatically?	Auto power off	78
How do I stop the camera beeping and clicking?	Silent mode	30
	Operation and shutter volume	73
What are the parts of the camera called?	Parts of the camera	2
What do the icons in the monitor mean?	Monitor	3
How do I use the menus?	Menus	56
What's behind that flashing icon or error message in the monitor?	Messages and displays	89
How much charge is left in the battery?	Battery level	12
Can I increase the capacity of rechargeable Ni-MH batteries?	Discharge	79

Taking Pictures

Question	Key phrase	See page
How many pictures can I take?	Memory capacity	94
Is there a quick and easy way to take snapshots?	 mode	19
How can I make good portraits?	Intelligent Face Detection	23
Can the camera automatically select the most suitable mode?	 mode	12
Is there a simple way to adjust settings for different scenes?	Shooting mode	18
How do I shoot a panorama?	 mode	20
How do I shoot close-ups?	Macro mode (Close-ups)	27
How do I keep the flash from firing?	Flash mode	28
How do I stop my subjects' eyes glowing red when I use the flash?		
How do I "fill-in" shadows on back-lit subjects?		
How do I take a series of pictures in a single burst?	Continuous shooting mode	62
How do I take a group portrait that includes the photographer?	Self-timer mode	31
How do I frame pictures with the subject off to one side?	Focus lock	25
How do I adjust exposure?	Exposure compensation	60
How do I shoot movies?	Recording movies	40









Viewing Pictures

























Question	Key phrase	See page
How do I view my pictures?	Single-frame playback	33
Is there a simple way to delete one image?	Deleting pictures	17
How do I delete one or all images at once?	Erase	38
Can I zoom in on pictures during playback?	Playback zoom	34
How do I view a lot of pictures at once?	Multi-frame playback	35
How do I find pictures?	Image search	36
Can I protect my pictures from accidental deletion?	Protect	67
Can I hide the icons in the monitor when viewing my pictures?	Choosing a display format	33
Can I view my pictures in a slide show?	Slide show	65
Can I crop unwanted elements out of my pictures?	Crop	68
Can I make small copies of pictures?	Resize	69
Can I copy pictures from internal memory to a memory card?	Copy	70
How do I view my pictures on TV?	Viewing pictures on TV	43

Sharing Pictures

Question	Key phrase	See page
Can I print pictures on my home printer?	Printing pictures	44
Can I copy my pictures to my computer?	Viewing pictures on a computer	50

Table of Contents

Notes and Cautions	ii
IMPORTANT SAFETY INSTRUCTIONS	ii
Safety Notes	iv
About This Manual	ix
Camera Q & A	x
Camera Setup	x
Taking Pictures	xi
Viewing Pictures	xii
Sharing Pictures	xii
Before You Begin	
Introduction	1
Symbols and Conventions	1
Supplied Accessories	1
Parts of the Camera	2
The Monitor	3
First Steps	
Inserting the Batteries	4
Inserting a Memory Card	5
Turning the Camera on and off	9
Shooting Mode	9
Playback Mode	9
Basic Setup	10
Basic Photography and Playback	
Taking Pictures in  (SCENE RECOGNITION) Mode	12
Viewing Pictures	17
More on Photography	
 Shooting Mode	18
Selecting a Shooting Mode	18
Shooting Modes	19
Intelligent Face Detection	23
Focus Lock	25
 Macro mode (Close-ups)	27
 Using the Flash (Intelligent Flash)	28
 Using the Self-Timer	31
More on Playback	
Single-Frame Playback	33
Playback Zoom	34
Multi-Frame Playback	35
 Image Search	36
Image Search based on categories	36
Using Playback Menu with Image Search	37
 Deleting Pictures	38
Movies	
 Recording Movies	40
 Viewing Movies	42
Connections	
Viewing Pictures on TV	43
Printing Pictures via USB	44
Connecting the Camera	44
Printing Selected Pictures	44
Printing the DPOF Print Order	45
Creating a DPOF Print Order	47

Viewing Pictures on a Computer	50	The Setup Menu	72
Installing the Software.....	50	Using the Setup Menu	72
Windows: Installing MyFinePix Studio.....	50	Setup Menu Options.....	73
Macintosh: Installing FinePixViewer.....	52	 TIME DIFFERENCE.....	75
Connecting the Camera	54	 FORMAT	76
Menus		 IMAGE DISP.	76
The Shooting Menu	56	 FRAME NO.	77
Using the Shooting Menu.....	56	 PLAYBACK VOLUME.....	77
Shooting Menu Options.....	57	 LCD BRIGHTNESS.....	78
 ISO.....	58	 LCD MODE.....	78
 IMAGE SIZE	58	 AUTO POWER OFF.....	78
 IMAGE QUALITY	59	 DIGITAL ZOOM	79
 EXP. COMPENSATION	60	 BATTERY TYPE.....	79
 WHITE BALANCE.....	61	 DISCHARGE (Ni-MH Batteries Only)	79
 CONTINUOUS (Continuous shooting).....	62	Technical Notes	
The Playback Menu	63	Optional Accessories	81
Using the Playback Menu	63	Accessories from Fujifilm.....	82
Playback Menu Options.....	64	Troubleshooting	
 SLIDE SHOW	65	Troubleshooting	83
 RED EYE REMOVAL.....	66	Warning Messages and Displays	89
 PROTECT	67	Appendix	
 CROP	68	Glossary	93
 RESIZE	69	Internal Memory/Memory Card Capacity	94
 IMAGE ROTATE	69	Specifications	96
 COPY	70	Caring for the Camera	102

Introduction

Symbols and Conventions

The following symbols are used in this manual:

 **Caution:** This information should be read before use to ensure correct operation.

 **Note:** Points to note when using the camera.

 **Tip:** Additional information that may be helpful when using the camera.

Menus and other text in the camera monitor are shown in bold. In the illustrations in this manual, the monitor display may be simplified for explanatory purposes.

Supplied Accessories

The following items are included with the camera:

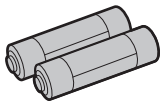

AA alkaline (LR6) batteries (x2)

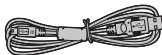

USB cable



CD-ROM

Attaching the Strap

Attach the strap as shown.

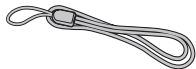

Strap

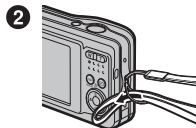
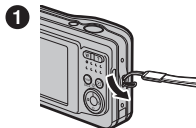

*Owner's Manual
(may be distributed
on CD in some
countries or regions)*

Parts of the Camera

For more information, refer to the page listed to the right of each item.

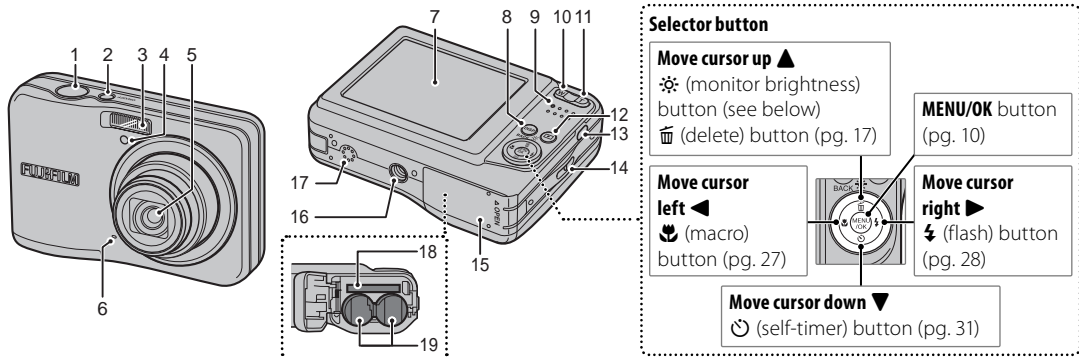

1	Shutter button.....	15–16	8	DISP (display)/BACK button.....	15, 30	14	Strap eyelet.....	1
2	ON/OFF button.....	9		OFF (silent mode) button.....	30	15	Battery-chamber cover.....	4
3	Flash.....	28	9	Indicator lamp.....	16	16	Tripod mount.....	
4	Self-timer lamp.....	31	10	W (zoom out) button.....	14, 35	17	Speaker.....	42
5	Lens and lens cover.....		11	T (zoom in) button.....	14, 34	18	Memory card slot.....	5
6	Microphone.....	40	12	▶ (playback) button.....	33	19	Battery-chamber.....	4
7	Monitor.....	3	13	USB multi-connector.....	43, 44, 54			

Tip: Monitor Brightness

Pressing the ☼ button briefly increases monitor brightness, making the display easier to see in bright light. Normal brightness is restored when a photograph is taken.

The Monitor

The following indicators may appear in the monitor during shooting and playback:

Shooting

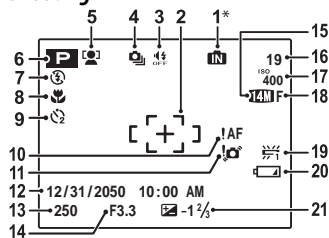

* **IN**: indicates that no memory card is inserted and that pictures will be stored in the camera's internal memory (pg. 5).

1	Internal memory indicator*	11	Blur warning.....	28
2	Focus frame.....	12	Date and time.....	10
3	Silent mode indicator.....	13	Shutter speed	
4	Continuous shooting mode.....	14	Aperture	
5	Intelligent Face Detection indicator.....	15	Image size.....	58
6	Shooting mode.....	16	Number of available frames.....	94
7	Flash mode.....	17	Sensitivity.....	58
8	Macro (close-up) mode.....	18	Image quality.....	59
9	Self-timer indicator.....	19	White balance.....	61
10	Focus warning.....	20	Battery level.....	12
		21	Exposure compensation.....	60

Playback

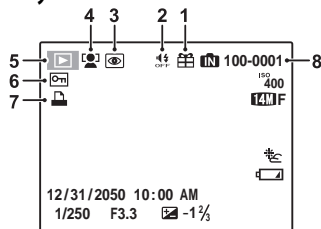

1	Gift image.....	33	5	Playback mode indicator.....	33, 35
2	Silent mode indicator.....	30	6	Protected image.....	67
3	Red-eye removal indicator.....	29	7	DPOF print indicator.....	47
4	Intelligent Face Detection indicator.....	24, 34	8	Frame number.....	77

Inserting the Batteries

The camera takes two AA alkaline (LR6) batteries (supplied) or two AA rechargeable Ni-MH batteries (sold separately). Insert the batteries in the camera as described below.

1 Open the battery-chamber cover.

Note

Be sure the camera is off before opening the battery-chamber cover.

Cautions

- Do not open the battery-chamber cover when the camera is on. Failure to observe this precaution could result in damage to image files or memory cards.
- Do not use excessive force when handling the battery-chamber cover.

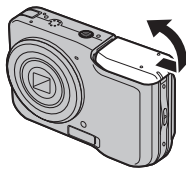

2 Insert the batteries.

Insert the batteries in the orientation shown by the “+” and “-” marks inside the battery chamber.

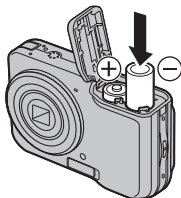

3 Close the battery-chamber cover.

Cautions

- Insert the batteries in the correct orientation.
- **Never use batteries with peeling or damaged casing or mix old and new batteries, batteries with different charge levels, or batteries of different types.** Failure to observe these precautions could result in the batteries leaking or overheating.
- **Never use manganese or Ni-Cd.** Replace AA alkaline batteries with batteries of the same make and grade as those supplied with the camera.
- **If the battery-chamber cover can not be latched easily, confirm the battery orientation first. Do not use excessive force to latch it.**

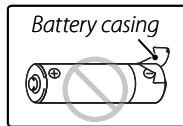
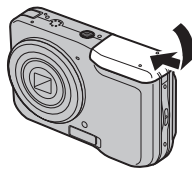

Inserting a Memory Card

Although the camera can store pictures in internal memory, SD memory cards (sold separately) can be used to store additional pictures.

When no memory card is inserted,  appears in the monitor and internal memory is used for recording and playback. Note that because camera malfunction could cause internal memory to become corrupted, the pictures in internal memory should periodically be transferred to a computer and saved on the computer hard disk or on removable media such as CDs or DVDs. The pictures in internal memory can also be copied to a memory card (see page 70). To prevent internal memory from becoming full, be sure to delete pictures when they are no longer needed.

When a memory card is inserted as described below, the card will be used for recording and playback.

■ **Compatible Memory Cards**

SanDisk SD and SDHC memory cards have been tested and approved for use in the camera. Use a card with a class 4 write speed (4 MB/s) or better when shooting HD movies. A complete list of approved memory cards is available at http://www.fujifilm.com/products/digital_cameras/index.html. Operation is not guaranteed with other cards. The camera can not be used with MultiMediaCard (MMC) or *xD-Picture* cards.

Caution

Memory cards can be locked, making it impossible to format the card or to record or delete images. Before inserting a memory card, slide the write-protect switch to the unlocked position.

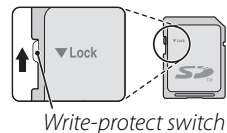

■ Inserting a Memory Card

- 1 Turn the camera off, and open the battery-chamber cover.

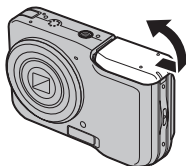

- 2 Insert the memory card firmly until you hear (feel) a click.

Holding the memory card in the orientation shown below, slide it all the way in.

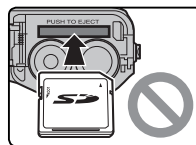
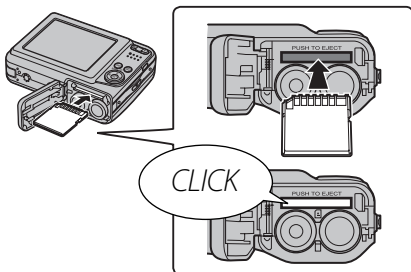

Be sure card is in correct orientation; do not insert at an angle or use force. If the memory card is not inserted correctly, **IN** will appear in the monitor and images will be recorded to internal memory.

- 3 Close the battery-chamber cover.

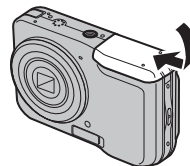

Removing Memory Cards

Be sure the camera is off before opening the battery-chamber cover. Press the card in and then release it slowly. The card can now be removed by hand.

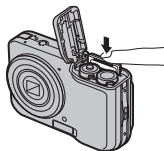

Cautions

- The memory card may spring out if you remove your finger immediately after pushing the card in.
- Memory cards may be warm to the touch after being removed from the camera. This is normal and does not indicate a malfunction.

Cautions

- Format memory cards before first use, and be sure to reformat all memory cards after using them in a computer or other device. For more information on formatting memory cards, see page 76.
- Memory cards are small and can be swallowed; keep out of reach of children. If a child swallows a memory card, seek medical assistance immediately.
- Do not turn the camera off or remove the memory card while the memory card is being formatted or data are being recorded to or deleted from the card. Failure to observe this precaution could damage the card.
- miniSD or microSD adapters that are larger or smaller than the standard dimensions of an SD card may not eject normally; if the card does not eject, take the camera to an authorized service representative. Do not forcibly remove the card.
- Do not affix labels to memory cards. Peeling labels can cause camera malfunction.
- Movie recording may be interrupted with some types of memory card.
- The data in internal memory may be erased or corrupted when the camera is repaired. Please note that the repairer will be able to view pictures in internal memory.
- Formatting a memory card or internal memory in the camera creates a folder in which pictures are stored. Do not rename or delete this folder or use a computer or other device to edit, delete, or rename image files. Always use the camera to delete pictures from memory cards and internal memory; before editing or renaming files, copy them to a computer and edit or rename the copies, not the originals.

Turning the Camera on and off

Shooting Mode

Press the **ON/OFF** button to turn the camera on. The lens will extend and the lens cover will open.

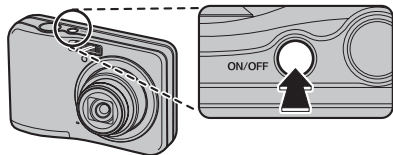

Press **ON/OFF** again to turn the camera off.

Tip: Switching to Playback Mode

Press the  button to start playback. Press the shutter button halfway to return to shooting mode.

Cautions

- Pictures can be affected by fingerprints and other marks on the lens. Keep the lens clean.
- The **ON/OFF** button does not completely disconnect the camera from its power supply.

Tip: Auto Power Off

The camera will turn off automatically if no operations are performed for the length of time selected in the **AUTO POWER OFF** menu (see page 78).

Playback Mode

To turn the camera on and begin playback, press the  button for about a second.

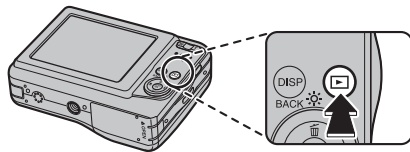

Press the  button again to turn the camera off.

Tip: Switching to Shooting Mode

To exit to shooting mode, press the shutter button halfway. Press the  button to return to playback.

Basic Setup

A language-selection dialog is displayed the first time the camera is turned on. Set up the camera as described below (for information on resetting the clock or changing languages, see page 72).

1 Choose a language.

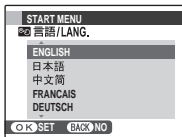

1.1 Press the selector up or down to highlight a language.



1.2 Press **MENU/OK**.



2 Set the date and time.

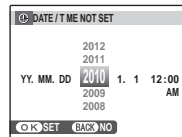

2.1 Press the selector left or right to highlight the year, month, day, hour, or minute and press up or down to change. To change the order in which the year, month, and day are displayed, highlight the date format and press the selector up or down.



2.2 Press **MENU/OK**.





3 Check the battery type.

A confirmation message for the battery type to be used appears. Alkaline batteries are selected by default.

← Note

Go to the setup menu if you try to set the language, date or battery type again (pg. 72).

📖 Tips: The Camera Clock

- If the batteries are removed for an extended period,  **DATE/TIME** and  **BATTERY TYPE** will be cleared and the language-selection dialog will be displayed. Set up the camera again.
- If the batteries have been left in the camera for about 2 hours or more, the batteries can be removed for about 24 hours without resetting the clock.

Taking Pictures in (SCENE RECOGNITION) Mode

This section describes how to take pictures in  mode.

- 1 Turn the camera on.**
Press the **ON/OFF** button to turn the camera on.

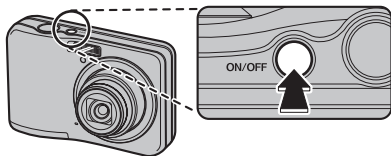

Tip: SCENE RECOGNITION

Simply by pointing the camera to the subject, the camera automatically analyzes and selects the most appropriate setting using scene recognition.

- 2 Check the battery level.**
Check the battery level in the monitor.

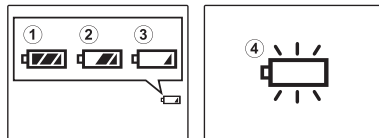







Indicator	Description
① (white)	Batteries partially discharged.
② (white)	Batteries more than half discharged.
③ (red)	Batteries are low. Replace as soon as possible.
④ (blinks red)	Batteries are exhausted. Turn camera off and replace batteries.

3 Frame a picture using the zoom control.

The camera analyzes a subject based on scene recognition, then an icon appears in the bottom left of the monitor.





(The illustration shows when the camera analyzed subject(s) in portrait.)

Subject	Icon	Description
PORTRAIT		For soft-toned portraits with natural skin tones.
LANDSCAPE		For crisp, clear daylight shots of buildings and landscapes.
NIGHT		For night and twilight scenes, using a high sensitivity setting to minimize blurring.
MACRO		For clear close-ups of flowers, etc.
BACKLIT PORTRAIT		For a subject backlit against the sun, preventing the background from becoming dim.
NIGHT PORTRAIT		For a subject in a dim place, reducing blur.

Tip

When a subject can not be analyzed by the camera,  **AUTO** mode will be set.

Notes

-  Intelligent Face Detection is turned on automatically.
- The camera continuously adjusts focus on a face, or the center area of the monitor.
- Continuous auto focus will be audible and will increase battery drain.
- Macro mode is set when  is set.

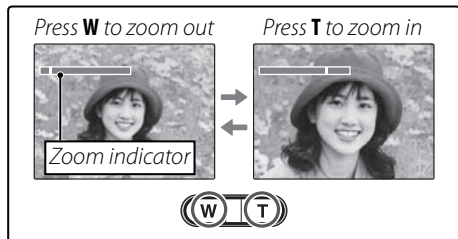
How to use the zoom control**Holding the Camera**

Hold the camera steady with both hands and brace your elbows against your sides. Shaking or unsteady hands can blur your shots.

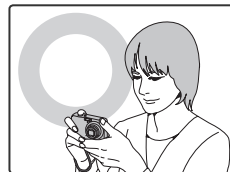

To prevent pictures that are out of focus or too dark (underexposed), keep your fingers and other objects away from the lens and flash.

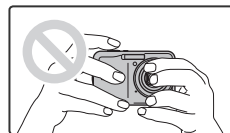
** DIGITAL IS**

If the subject is poorly lit, blurring caused by camera shake can be reduced by activating the  **DIGITAL IS** (pg. 72). Note that blurring may still occur depending on the scene or shooting conditions.

Note

When the setting is off,  is displayed.

Framing Guideline (Best Framing)

The images change as shown below if you press the **DISP/BACK** button.

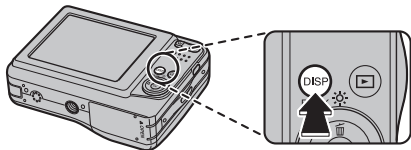

INFORMATION
ON



INFORMATION
OFF



BEST FRAMING

- **Best Framing:** To use the best framing, position the main subject at the intersection of two lines or along one of the horizontal lines with the horizon.

4 Focus.

Press the shutter button halfway to focus.



If the camera is able to focus, it will beep twice and the indicator lamp will glow green.

If the camera is unable to focus, the red colored focus frame and **!AF** will appear in the monitor, and the indicator lamp will blink green. Change the composition or use focus lock (pg. 25).

Note

The lens may make a noise when the camera focuses. This is normal.

5 Shoot.

Smoothly press the shutter button the rest of the way down to take the picture.



Tip: The Shutter Button

The shutter button has two positions. Pressing the shutter button halfway (①) sets focus and exposure; to shoot, press the shutter button the rest of the way down (②).

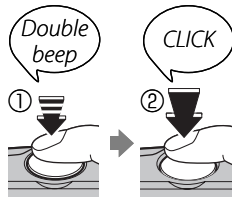

Note

If the subject is poorly lit, the flash may fire when the picture is taken. To take pictures without the flash, choose another flash mode (pg. 28).

The Indicator Lamp

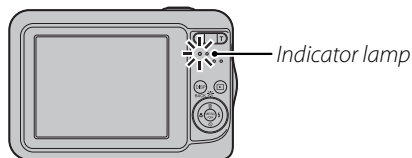

The indicator lamp shows camera status as follows:

Indicator lamp	Camera status
Glows green	Focus locked.
Blinks green	Camera shake warning, AF warning, or AE warning (ready to shoot)
Blinks green and orange	Recording pictures. Additional pictures can be taken.
Glows orange	Recording pictures. No additional pictures can be taken at this time.
Blinks orange	Flash charging; flash will not fire when picture is taken.
Blinks red	Recording or lens error.

Tip: Warnings

Detailed warnings appear in the monitor. See pages 89–92 for more information.

Viewing Pictures

Pictures can be viewed in the monitor. When taking important photographs, take a test shot and check the results.

- 1 Press the  button.

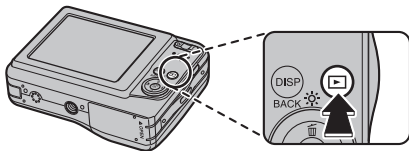

The most recent picture will be displayed in the monitor.



- 2 View additional pictures.

Press the selector right to view pictures in the order recorded, left to view pictures in reverse order.



Press the shutter button to exit to shooting mode.

Deleting Pictures

To delete the picture currently displayed in the monitor, press the selector up (). The following dialog will be displayed.

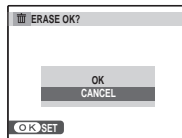
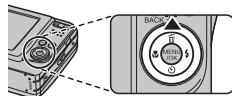

To delete the picture, highlight **OK** and press **MENU/OK**. To exit without deleting the picture, highlight **CANCEL** and press **MENU/OK**.



Tip: The Playback Menu

Pictures can also be deleted from the playback menu (pg. 38).

Shooting Mode

Choose a shooting mode according to the scene or type of subject.

Selecting a Shooting Mode

- 1 Press **MENU/OK** to display the shooting menu.

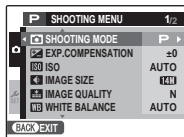

- 2 Press the selector up or down to highlight ** SHOOTING MODE**.

- 3 Press the selector right to display shooting mode options.

- 4 Press the selector up or down to highlight the desired mode.

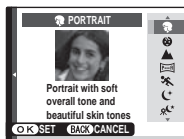

- 5 Press **MENU/OK** to select the highlighted option.



← Note

See the restrictions in another supplied document for flash mode setting.

Shooting Modes

SCENE RECOGNITION

Simply by pointing the camera to the subject, the camera automatically analyzes and selects the most appropriate setting using scene recognition.

See “Taking Pictures in  (SCENE RECOGNITION) mode” (pg. 12).

AUTO

Choose for crisp, clear snapshots. This mode is recommended in most situations.

P PROGRAM AE

Program AE sets both shutter speed and lens aperture. The camera lets you control camera settings such as exposure compensation (pg. 60), white balance (pg. 61), and ISO sensitivity (pg. 58).

NATURAL &

This mode helps ensure good results with backlit subjects and in other situations with difficult lighting. Each time the shutter button is pressed, the camera takes two shots: one shot without the flash to preserve natural lighting, followed immediately by a second shot with the flash. Do not move the camera until shooting is complete.

Notes

- Do not use where flash photography is prohibited. The flash will fire even in silent mode.
- Only available if memory remains for two pictures.

NATURAL LIGHT

Capture natural light indoors, under low light, or where the flash can not be used. The flash turns off and sensitivity is raised to reduce blur.

PORTRAIT

Choose this mode for soft-toned portraits with natural skin tones.

BABY MODE

Choose for natural skin tones when taking portraits of infants. The flash turns off automatically.

LANDSCAPE

Choose this mode for crisp, clear daylight shots of buildings and landscapes.

PANORAMA

In this mode, you can take up to three pictures and join them together to form a panorama. Use of a tripod is recommended to assist in composing overlapping shots.

1 Select .

2 Press the selector up to select a frame, and press the selector left or right to highlight a pan direction and press **MENU/OK**.



3 Take a photograph.
Exposure and white balance for the panorama are set with the first shot.



4 Press **MENU/OK**.
An edge of the picture you have just taken will be displayed at one side of the frame.

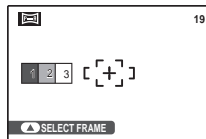

5 Frame the next shot to overlap with the previous picture.

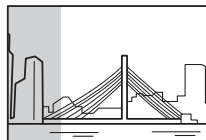

6 Take the second shot as described in steps 3-4 (to create a panorama from only two frames, press the selector up after the second shot).

- 7 Take the last shot, framing it to overlap the second picture.



- 8 Press **MENU/OK** to complete the panorama.



- 9 Press **MENU/OK** to save the picture (the individual shots are not saved).



Printing Pictures Taken in Panorama Mode

Depending on the number of photographs they contain, panoramas may not print correctly on some sizes of paper. Part of the image may not be printed or the image may print with unusually wide margins at the top and bottom or left and right.

SPORT

Choose this mode when photographing moving subjects. Priority is given to faster shutter speeds.

NIGHT

A high sensitivity setting is selected automatically to minimize blurring for recording night and twilight scenes.

NIGHT (TRIPOD)

Slow shutter speeds are used to record night scenes. Use of a tripod is recommended to prevent camera shake.

FIREWORKS

Slow shutter speeds are used to capture the expanding burst of light from a firework. Press the selector left or right to choose a shutter speed. Use of a tripod is recommended to prevent blur. The flash turns off automatically.

 **SUNSET**

Choose this mode to record the vivid colors in sunrises and sunsets.

 **SNOW**

Choose for crisp, clear shots that capture the brightness of scenes dominated by shining white snow.

 **BEACH**

Choose for crisp, clear shots that capture the brightness of sunlit beaches.

 **PARTY**

Capture indoor background lighting under low-light conditions.

 **FLOWER**

Choose for vivid close-ups of flowers. The camera focuses in the macro range and the flash turns off automatically.

 **TEXT**

Take clear pictures of text or drawings in print. The camera focuses in the macro range.

Intelligent Face Detection

Intelligent Face Detection allows the camera to automatically detect human faces and set focus and exposure for a face anywhere in the frame for shots that emphasize portrait subjects. Choose for group portraits to prevent the camera from focusing on the background. Intelligent Face Detection also offers a red-eye removal option for removing “red-eye” effects caused by the flash.

1 Turn Intelligent Face Detection on.

- 1.1 Press **MENU/OK** to display the shooting menu.

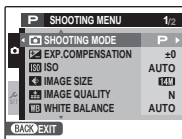

- 1.2 Press the selector up or down to highlight **FACE DETECTION**.



- 1.3 Press the selector right to display Intelligent Face Detection options.



- 1.4 Press the selector up or down to highlight the desired option.



- 1.5 Press **MENU/OK** to select the highlighted option and return to shooting mode.



 icon appears in monitor when Intelligent Face Detection is on.



Note

When removing red-eye effect, select **ON** for  **RED EYE REMOVAL** in the setup menu (pg. 74).

2 Frame the picture.

If a face is detected, it will be indicated by a green border. If there is more than one face in the frame, the camera will select the face closest to the center; other faces are indicated by white borders.



Green border

3 Focus.

Press the shutter button halfway to set focus and exposure for the subject in the green border.



⚠ Cautions

- If no face is detected when the shutter button is pressed halfway (pg. 85), the camera will focus on the subject at the center of the display and red-eye will not be removed.
- In each shooting mode, the camera will detect and focus on faces but exposure will be optimized for the entire scene rather than the selected portrait subject.

4 Shoot.

Press the shutter button all the way down to shoot.



⚠ Caution

If the subject moves as the shutter button is pressed, their face may not be in the area indicated by the green border when the picture is taken.

📖 Tip: Red-Eye Removal

Select **ON** for the **SAVE ORG IMAGE** option in the setup menu (pg. 72) to save unprocessed copies of pictures created with red-eye removal.

● Intelligent Face Detection

Intelligent Face Detection is recommended when using the self-timer for group- or self-portraits (pp. 31–32).



The following functions can be used with Intelligent Face Detection.

RED EYE REMOVAL (pg. 66)/**IMAGE SEARCH** (pg. 36)/**SLIDE SHOW** (pg. 65)/**IMAGE DISP. > ZOOM (CONTINUOUS)** (pg. 76)/**PRINT ORDER (DPOF)** (pg. 45)/**CROP** (pg. 68)

Focus Lock

To compose photographs with off-center subjects:

1 Position the subject in the focus frame.



2 Focus.

Press the shutter button halfway to set focus and exposure. Focus and exposure will remain locked while the shutter button is pressed halfway (AF/AE lock).



*Press
halfway*



Repeat steps 1 and 2 as desired to refocus before taking the picture.

3 Recompose the picture.

Keeping the shutter button pressed halfway, recompose the picture.



4 Shoot.



Press the shutter-release button the rest of the way down to take the picture.



*Press the rest of
the way down*

Autofocus

Although the camera boasts a high-precision autofocus system, it may be unable to focus on the subjects listed below. If the camera is unable to focus using autofocus, use focus lock (pg. 25) to focus on another subject at the same distance and then recompose the photograph.

- Very shiny subjects such as mirrors or car bodies.
- 
- Fast-moving subjects.
- 
- Subjects photographed through a window or other reflective object.
 - Dark subjects and subjects that absorb rather than reflect light, such as hair or fur.
 - Insubstantial subjects, such as smoke or flame.
 - Subjects that show little contrast with the background (for example, subjects in clothing that is the same color as the background).
 - Subjects positioned in front of or behind a high-contrast object that is also in the focus frame (for example, a subject photographed against a backdrop of highly contrasting elements).

Macro mode (Close-ups)

For close-ups, press the selector left (). The selection changes each time the selector is pressed.

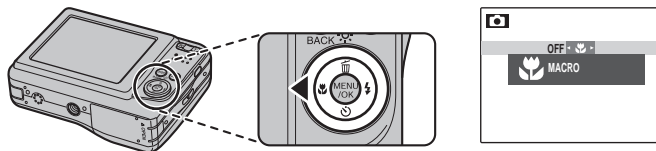

When macro mode is in effect, the camera focuses on subjects near the center of the monitor. Use the zoom buttons to frame pictures.

Note

Use of a tripod is recommended to prevent blur caused by camera shake.

⚡ Using the Flash (Intelligent Flash)

When the flash is used, the camera's *Intelligent Flash* system instantly analyzes the scene based on such factors as the brightness of the subject, its position in the frame, and its distance from the camera. Flash output and sensitivity are adjusted to ensure that the main subject is correctly exposed while preserving the effects of ambient background lighting, even in dimly-lit indoor scenes. Use the flash when lighting is poor, for example when shooting at night or indoors under low light.

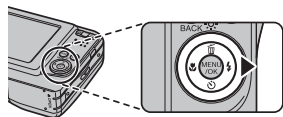

1 Choose a flash mode.

Press the selector right (➡). The flash mode changes each time the selector is pressed; in modes other than **AUTO**, the current mode is indicated by an icon in the display. Choose from the following options:



Mode	Description
AUTO (AUTO FLASH)	The flash fires when required. Recommended in most situations.
⚡ (FORCED FLASH)	The flash fires whenever a picture is taken. Use for backlit subjects or for natural coloration when shooting in bright light.
ⓧ (SUPPRESSED FLASH)	The flash does not fire even when the subject is poorly lit. 📷 will appear in the monitor at slow shutter speeds to warn that pictures may be blurred. Use of a tripod is recommended.
S ⚡ (SLOW SYNCHRO)	Capture both the main subject and the background under low light (note that brightly lit scenes may be overexposed).

2 Focus.

Press the shutter button halfway to focus. If the flash will fire,  will be displayed when the shutter button is pressed halfway. At slow shutter speeds,  will appear in the display to warn that pictures may be blurred; use of a tripod is recommended.



3 Shoot.





Press the shutter button the rest of the way down to shoot.

Caution

The flash may fire several times with each shot. Do not move the camera until shooting is complete.



Red-Eye Removal



When Intelligent Face Detection is active (pg. 23), and **ON** is selected for  **RED EYE REMOVAL** in the setup menu (pg. 72), red-eye removal is available in  **AUTO**,  **FLASH**, and  **SLOW**. Red-eye removal minimizes "*red-eye*" caused when light from the flash is reflected from the subject's retinas as shown in the illustration at right.

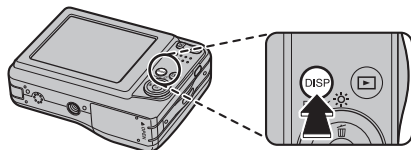

 **Silent Mode**

In situations in which camera sounds or light from the flash may be unwelcome, press the **DISP/BACK** button until  is displayed in the monitor.



The camera speaker, shooting indicator, flash, and indicator and self-timer lamps turn off (note that the flash will still fire in  mode). Flash and volume settings (pg. 77) can not be adjusted while silent mode is in effect. To restore normal operation, press the **DISP/BACK** button until the  icon is no longer displayed.

🕒 Using the Self-Timer

The camera offers a ten-second timer that allows photographers to appear in their own photographs, and a two-second timer that can be used to avoid blur caused by the camera moving when the shutter button is pressed.

1 Set the timer.

Press the selector down (🕒). The selection changes each time the selector is pressed. The current self-timer mode is displayed in the monitor.

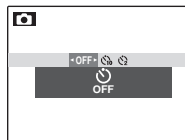
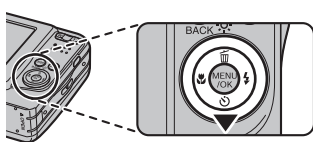

Choose from (self-timer off),
 (10 s delay), or (2 s delay)

2 Focus.

Press the shutter button halfway to focus.

Caution

Stand behind the camera when using the shutter button. Standing in front of the lens can interfere with focus and exposure.



3 Start the timer.

Press the shutter button the rest of the way down to start the timer. The display in the monitor shows the number of seconds remaining until the shutter is released. To stop the timer before the picture is taken, press **DISP/BACK**.

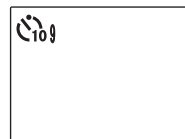

The self-timer lamp on the front of the camera will blink immediately before the picture is taken. If the two-second timer is selected, the self-timer lamp will blink as the timer counts down.

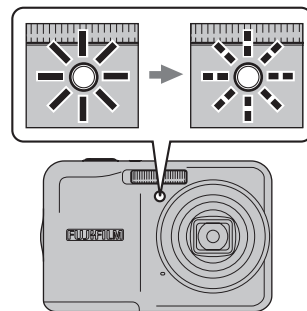

●● Intelligent Face Detection

Because it ensures that the faces of portrait subjects will be in focus, Intelligent Face Detection (pg. 23) is recommended when using the self-timer for group portraits or self-portraits. To use the self-timer with Intelligent Face Detection, set the timer as described in Step 1 and then press the shutter button all the way down to start the timer. The camera will detect faces while the timer is counting down and adjust focus and exposure immediately before the shutter is released. Be careful not to move until the picture has been recorded.

Single-Frame Playback

To view the most recent picture in the monitor, press the  button.

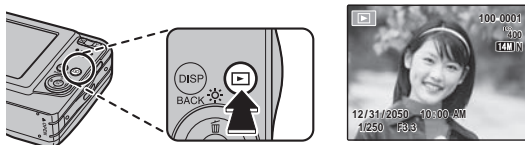

Press the selector right to view pictures in the order recorded, left to view pictures in reverse order. Keep the selector pressed to scroll rapidly to the desired frame.



Choosing a Display Format

In playback mode, press **DISP/BACK** to select a playback display format.

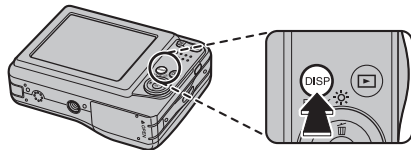

The selection changes each time **DISP/BACK** is pressed.

INFORMATION ON



INFORMATION OFF



Note

Pictures taken using other cameras are indicated by a  ("gift image") icon during playback.

Playback Zoom

Press **T** to zoom in on images displayed in single-frame playback; press **W** to zoom out.

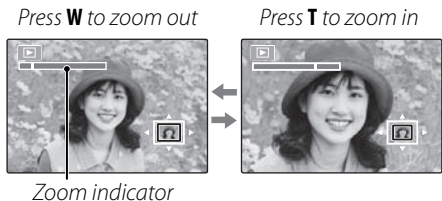

When the picture is zoomed in, the selector can be used to view areas of the image not currently visible in the display.





Navigation window shows portion of image currently displayed in monitor

Press **DISP/BACK** to exit zoom.

Notes

- The maximum zoom ratio varies with image size.
- Playback zoom is not available with images saved or cropped at the size of **03M**, or copies created with **RESIZE** (pg. 69).

Intelligent Face Detection

Pictures taken with Intelligent Face Detection (pg. 23) are indicated by a  icon. Press the  button to zoom in on the subject selected with Intelligent Face Detection. You can then use the zoom control to zoom in and out.



Multi-Frame Playback

To change the number of images displayed, press **W** when a picture is shown full-frame in the monitor.



Press **W** to increase the number of pictures displayed to one frame with previous and next, two, nine, and a hundred.



Press **T** to reduce the number of images displayed.

Use the selector to highlight images and press **MENU/OK** to view the highlighted image full frame. In the nine- and hundred-frame displays, press the selector up or down to view more pictures.

Tip: Two-Frame Display

Two-frame display can be used to compare pictures taken in  mode.



Image Search

Image Search based on categories

Search for pictures by date, subject, scene, and file type.

1 Press **MENU/OK** to display the playback menu.



2 Press the selector up or down to highlight  **IMAGE SEARCH**.



3 Press **MENU/OK** to display the search category.



4 Press the selector up or down to highlight the desired search category.



Option	Description
BY DATE	Show images based on the specified date.
BY FACE	Show images based on specified face information.
BY SCENE	Show images based on the specified scene mode.
BY TYPE OF DATA	Show images based on whether still pictures or movies.

5 Press **MENU/OK** to select the highlighted search category. A detailed search list will be displayed.



6 Select a category in the list. Specified Images will be displayed.

Using Playback Menu with Image Search

Three playback menus can be performed with image search mode.

- 1 Press **MENU/OK** while the search results are displayed.
The playback menu will be displayed.



- 2 Press the selector up or down to highlight the desired menu item.





- 3 Press **MENU/OK** to select the highlighted menu.



Tips

- For each operation, refer to the page listed.

Option	See Page
 ERASE	38
 PROTECT	67
 SLIDE SHOW	65

- Select **EXIT SEARCH** to go back to the normal playback mode.

Deleting Pictures

The **ERASE** option in the playback menu can be used to delete still pictures and movies, increasing the amount of space available on the memory card or in internal memory (for information on deleting pictures in single-frame playback, see page 17). *Note that deleted pictures can not be recovered. Copy important pictures to a computer or other storage device before proceeding.*

- 1 Press **MENU/OK** to display the playback menu.

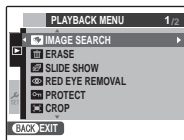

- 2 Press the selector up or down to highlight **ERASE**.



- 3 Press the selector right to display delete options.

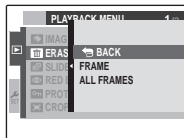

- 4 Press the selector up or down to highlight **FRAME** or **ALL FRAMES**.



- 5 Press **MENU/OK** to display options for the selected item (see pg. 39).



Tips: Deleting Pictures

- When a memory card is inserted, pictures will be deleted from the memory card; otherwise, pictures will be deleted from internal memory.
- Protected pictures can not be deleted. Remove protection from any pictures you wish to delete (pg. 67).
- If a message appears stating that the selected images are part of a DPOF print order, press **MENU/OK** to delete the pictures.

■ FRAME: *Deleting Selected Images*

Selecting **FRAME** displays the dialog shown at right.

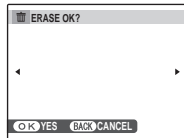

Press the selector left or right to scroll through pictures and press **MENU/OK** to delete the current picture (the picture is deleted immediately; be careful not delete the wrong picture).



Press **DISP/BACK** to exit when all the desired pictures have been deleted.

■ ALL FRAMES: *Deleting All Images*

Selecting **ALL FRAMES** displays the confirmation shown at right.

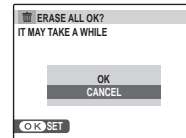

Highlight **OK** and press **MENU/OK** to delete all unprotected pictures.



The dialog shown at right is displayed during deletion. Press **DISP/BACK** to cancel before all pictures have been deleted (any pictures deleted before the button was pressed can not be recovered).

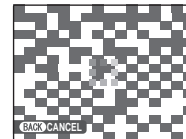

Recording Movies

Shoot short movies with sound. Sound is recorded via the built-in microphone; do not cover the microphone during recording.

- 1 Press **MENU/OK** to display the shooting menu and select **MOVIE** for **SHOOTING MODE** (pg. 18).

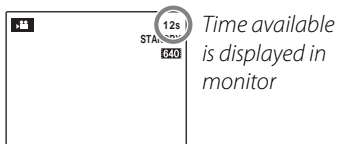

Choosing the Frame Size

To choose the frame size, press **MENU/OK** and select **QUALITY**.

Choose a pixel size in the following:

- **HD: 1280** (1280 × 720) for high definition movies
- **640** (640 × 480) for standard definition movies
- **320** (320 × 240) for longer movies

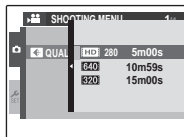

- 2 Frame the scene using the zoom buttons.

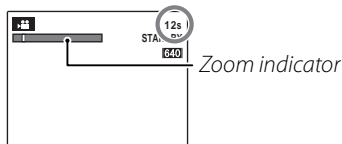

Zoom control during movie recording

The camera lets you zoom in and out during movie recording. Select the type of zoom available in movie mode from the setup menu (pg. 72).

OPTICAL: sounds will not be recorded during zoom operation.

DIGITAL: it may produce lower quality images than optical zoom.

- 3** Press the shutter button all the way down to start recording.

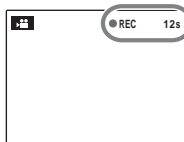

REC and time remaining are displayed in monitor

Notes

- Focus is set when recording begins; exposure and white balance are adjusted automatically throughout recording. The color and brightness of the image may vary from that displayed before recording begins.
- Some operating noise of the camera may be recorded during movie shooting.

- 4** Press the shutter button to end recording. Recording ends automatically when the movie reaches maximum length or memory is full.



Tip

There is no need to keep the shutter button pressed during recording.

Caution

Vertical or horizontal streaks may appear in movies containing very bright subjects. This is normal and does not indicate a malfunction.

▶ Viewing Movies

During playback (pg. 33), movies are displayed in the monitor as shown at right. The following operations can be performed while a movie is displayed:

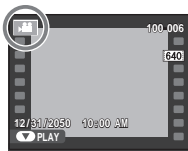

Progress is shown in the monitor during playback.

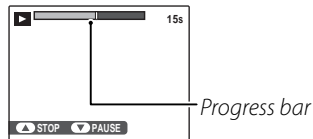

⚠ Caution

Do not cover the speaker during playback.

Operation	Description
Start/pause playback	Press the selector down to start playback. Press again to pause.
End playback/delete	Press the selector up to end playback. If playback is not in progress, pressing the selector up will delete the current movie.
Advance/rewind	Press the selector right to advance, left to rewind. If playback is paused, the movie will advance or rewind one frame each time the selector is pressed.
Adjust volume	Press MENU/OK to pause playback and display volume controls. Press the selector up or down to adjust the volume; press MENU/OK again to resume playback.

Viewing Pictures on TV

Connect the camera to a TV and tune the television to the video channel to show pictures to a group. Connect an A/V cable (optional), as shown below.

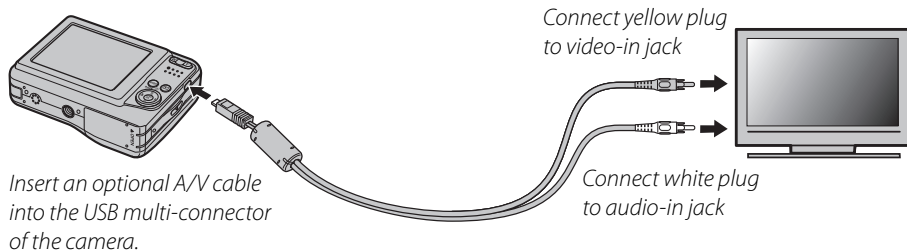

Press **▶** for about a second to turn the camera on. The camera monitor turns off and pictures and movies are played back on the TV. Note that the camera volume controls have no effect on sounds played on the TV; use the television volume controls to adjust the volume.

← Notes

- Use fully charged batteries for extended playback.
- Image quality drops during movie playback.

⚠ Cautions

- When making the A/V cable connection, be sure the connectors are fully inserted.
- HD movies are played back as standard definition movies on the TV if using an optional A/V cable.
- To play back High Definition movies on HDTV, optional accessories are required. For more information, please refer to the following URL.

http://www.fujifilm.com/products/digital_cameras/index.html

Printing Pictures via USB

If the printer supports PictBridge, the camera can be connected directly to the printer and pictures can be printed without first being copied to a computer. Note that depending on the printer, not all the functions described below may be supported.



Connecting the Camera

- 1 Connect the supplied USB cable as shown and turn the printer on.

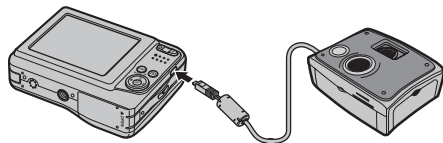

- 2 Press the button for about a second to turn the camera on. **USB** will be displayed in the monitor, followed by the PictBridge display shown below at right.

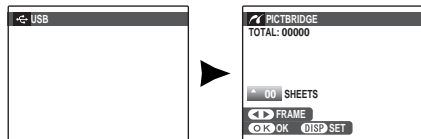

Printing Selected Pictures

- 1 Press the selector left or right to display a picture you wish to print.
- 2 Press the selector up or down to choose the number of copies (up to 99).
- 3 Repeat steps 1–2 to select additional pictures. Press **MENU/OK** to display a confirmation dialog when settings are complete.

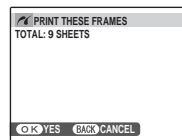

- 4 Press **MENU/OK** to start printing.



Tip: Printing the Date of Recording

To print the date of recording on pictures, press **DISP/BACK** in steps 1–2 to display the PictBridge menu (see “Printing the DPOF Print Order” on page 45). Press the selector up or down to highlight **PRINT WITH DATE**  and press **MENU/OK** to return to the PictBridge display (to print pictures without the date of recording, select **PRINT WITHOUT DATE**). The date will not be printed if the camera clock was not set when the picture was taken.

Note

If no pictures are selected when the **MENU/OK** button is pressed, the camera will print one copy of the current picture.

Printing the DPOF Print Order

To print the print order created with  **PRINT ORDER (DPOF)** in the playback menu (pg. 63):

- 1 In the PictBridge display, press **DISP/BACK** to open the PictBridge menu.

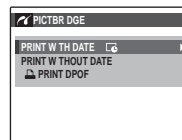

- 2 Press the selector up or down to highlight  **PRINT DPOF**.
- 3 Press **MENU/OK** to display a confirmation dialog.

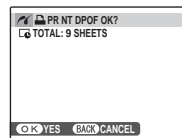



4 Press **MENU/OK** to start printing.

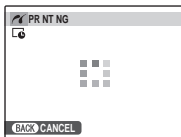

● ● **During Printing**

The message shown at right is displayed during printing. Press **DISP/BACK** to cancel before all pictures are printed (depending on the printer, printing may end before the current picture has printed).



If printing is interrupted, press  to turn the camera off and then on again.

● ● **Disconnecting the Camera**

Confirm that "PRINTING" is not displayed in the monitor and press  to turn the camera off. Disconnect the USB cable.

← **Notes**

- Use fully charged batteries to power the camera for extended periods.
- Print pictures from internal memory or a memory card that has been formatted in the camera.
- If the printer does not support date printing, the **PRINT WITH DATE**  option will not be available in the PictBridge menu and the date will not be printed on the pictures in the DPOF print order.
- When pictures are printed via direct USB connection, page size, print quality, and border selections are made using the printer.

Creating a DPOF Print Order



The  **PRINT ORDER (DPOF)** option in the playback menu can be used to create a digital “print order” for PictBridge-compatible printers (pg. 44) or devices that support DPOF.

DPOF

DPOF (Digital Print Order Format) is standard that allows pictures to be printed from “print orders” stored in internal memory or on a memory card. The information in the order includes the pictures to be printed and the number of copies of each picture.



■ WITH DATE / WITHOUT DATE

To modify the DPOF print order, select  **PRINT ORDER (DPOF)** in the playback menu and press the selector up or down to highlight **WITH DATE ** or **WITHOUT DATE**.

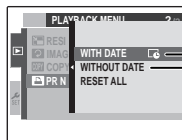

WITH DATE : Print date of recording on pictures.

WITHOUT DATE: Print pictures without date.

Press **MENU/OK** and follow the steps below.

- 1 Press the selector left or right to display a picture you wish to include in or remove from the print order.



- 2 Press the selector up or down to choose the number of copies (up to 99). To remove a picture from the order, press the selector down until the number of copies is 0.

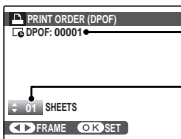

Total number of prints

Number of copies

 **Tip: Intelligent Face Detection**

If the current picture was created with Intelligent Face Detection, pressing ▼ sets the number of copies to the number of faces detected.

- 3 Repeat steps 1–2 to complete the print order. Press **MENU/OK** to save the print order when settings are complete, or **DISP/BACK** to exit without changing the print order.



- 4 The total number of prints is displayed in the monitor. Press **MENU/OK** to exit.



The pictures in the current print order are indicated by a  icon during playback.



← Notes

- Remove the memory card to create or modify a print order for the pictures in internal memory.
- Print orders can contain a maximum of 999 pictures.
- If a memory card is inserted containing a print order created by another camera, the message shown at right will be displayed. Pressing **MENU/OK** cancels the print order; a new print order must be created as described above.
- Whether **WITH DATE**  / **WITHOUT DATE** is available may depend on the printer setting. Check the printer.

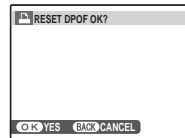

■ RESET ALL

To cancel the current print order, select **RESET ALL** in the  **PRINT ORDER (DPOF)** menu. The confirmation shown at right will be displayed; press **MENU/OK** to remove all pictures from the order.

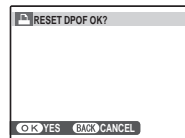

Viewing Pictures on a Computer

The supplied software can be used to copy pictures to a computer, where they can be stored, viewed, organized, and printed. Before proceeding, install the software as described below. **Do NOT connect the camera to the computer until installation is complete.**

Installing the Software

Two applications are supplied: MyFinePix Studio for Windows and FinePixViewer for the Macintosh. Installation instructions for Windows are on pages 50–51, those for the Macintosh on pages 52–53.

Windows: Installing MyFinePix Studio

1 Confirm that the computer meets the following system requirements:

	Windows 7*	Windows Vista*	Windows XP*
CPU	3 GHz Pentium 4 or better		2 GHz Pentium 4 or better
RAM	1 GB or more		512 MB or more
Free disk space	15 GB or more		2 GB or more
Video	<ul style="list-style-type: none">• 1,024 × 768 pixels or more with 24-bit color or better• A graphics processing unit (GPU) that supports DirectX 7 or later		
Other	<ul style="list-style-type: none">• Built-in USB port recommended. Operation is not guaranteed other USB ports.• Internet connection (56 kbps or faster recommended) required to use FinePix Internet Service; Internet connection and e-mail software required to use e-mail option.		

* Other versions of Windows are not supported. Only pre-installed operating systems are supported; operation is not guaranteed on home-built computers or computers that have been upgraded from earlier versions of Windows.

- 2 Start the computer. Log in to an account with administrator privileges before proceeding.
- 3 Exit any applications that may be running and insert the installer CD in a CD-ROM drive.

Windows 7/Windows Vista

If an AutoPlay dialog is displayed, click **SETUP.EXE**. A “User Account Control” dialog will then be displayed; click **Yes** (Windows 7) or click **Allow** (Windows Vista).

The installer will start automatically; click **Installing MyFinePix Studio** and follow the on-screen instructions to install MyFinePix Studio.

If the Installer Does Not Start Automatically

If the installer does not start automatically, select **Computer** or **My Computer** from the Start menu, then double-click the **FINEPIX** CD icon to open the FINEPIX CD window and double-click **SETUP** or **SETUP.EXE**.

- 4 If prompted to install Windows Media Player or DirectX, follow the on-screen instructions to complete installation.
- 5 Remove the installer CD from the CD-ROM drive when installation is complete. Store the installer CD in a dry location out of direct sunlight in case you need to re-install the software. The version number is printed at the top of the CD label for reference when updating the software or contacting customer support.

Installation is now complete. Proceed to “Connecting the Camera” on page 54.

Macintosh: Installing FinePixViewer

1 Confirm that the computer meets the following system requirements:

CPU	PowerPC or Intel
OS	Pre-installed versions of Mac OS X version 10.3.9–10.6 (for the latest information, visit http://www.fujifilm.com/)
RAM	256 MB or more
Free disk space	A minimum of 200 MB required for installation with 400 MB available when FinePixViewer is running
Video	800 × 600 pixels or more with thousands of colors or better
Other	<ul style="list-style-type: none"> • Built-in USB port recommended. Operation is not guaranteed other USB ports. • Internet connection (56 kbps or faster recommended) required to use FinePix Internet Service; Internet connection and e-mail software required to use e-mail option.

2 After starting the computer and quitting any applications that may be running, insert the installer CD in a CD-ROM drive and double-click **Installer for Mac OS X**.

3 An installer dialog will be displayed; click **Installing FinePixViewer** to start installation. Enter an administrator name and password when prompted and click **OK**, then follow the on-screen instructions to install FinePixViewer. Click **Exit** to quit the installer when installation is complete.

- 4 Remove the installer CD from the CD-ROM drive. Note that you may be unable to remove the CD if Safari is running; if necessary, quit Safari before removing the CD. Store the installer CD in a dry location out of direct sunlight in case you need to re-install the software. The version number is printed at the top of the CD label for reference when updating the software or contacting customer support.
- 5 **Mac OS X 10.5 or earlier:** Open the “Applications” folder, start Image Capture, and select **Preferences...** from the Image Capture application menu. The Image Capture preferences dialog will be displayed. Choose **Other...** in the **When a camera is connected, open** menu, then select **FPVBridge** in the “Applications/FinePixViewer” folder and click **Open**. Quit Image Capture.
Mac OS X 10.6: Connect the camera and turn it on. Open the “Applications” folder and start Image Capture. The camera will be listed under **DEVICES**; select the camera and choose **FPVBridge** from the **Connecting this camera opens** menu and click **Open**. Quit Image Capture.

Installation is now complete. Proceed to “Connecting the Camera” on page 54.

Connecting the Camera

- 1 If the pictures you wish to copy are stored on a memory card, insert the card into the camera (pg. 6). If no card is inserted, pictures will be copied from internal memory.

← Note

Windows users may require the Windows CD when starting the software for the first time.

⚠ Caution

Loss of power during transfer could result in loss of data or damage to internal memory or the memory card. Use fully charged batteries.

- 2 Turn the camera off and connect the supplied USB cable as shown, making sure the connectors are fully inserted. Connect the camera directly to the computer; do not use a USB hub or keyboard.

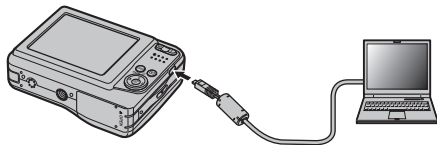

- 3 Press the **▶** button for about a second to turn the camera on. MyFinePix Studio or FinePixViewer will start automatically; follow the on-screen instructions to copy pictures to the computer. To exit without copying pictures, click **Cancel**.

⚠ Caution

If the software does not start automatically, the software may not be correctly installed. Disconnect the camera and reinstall the software.

For more information on using the supplied software, start the application and select the appropriate option from the **Help** menu.

 **Cautions**

- If a memory card containing a large number of images is inserted, there may be a delay before the software starts and you may be unable to import or save images. Use a memory card reader to transfer pictures.
- Make sure that the computer does not display a message stating that copying is in progress and that the indicator lamp is out before turning the camera off or disconnecting the USB cable (if the number of images copied is very large, the indicator lamp may remain lit after the message has cleared from the computer display). Failure to observe this precaution could result in loss of data or damage to internal memory or the memory card.
- Disconnect the camera before inserting or removing memory cards.
- In some cases, it may not be possible to access pictures saved to a network server using the supplied software in the same way as on a standalone computer.
- The user bears all applicable fees charged by the phone company or Internet service provider when using services that require an Internet connection.

 **Disconnecting the Camera**

After confirming that the indicator lamp is out, follow the on-screen instructions to turn the camera off and disconnect the USB cable.

 **Uninstalling the Supplied Software**

Only uninstall the supplied software when it is no longer required or before beginning reinstallation. After quitting the software and disconnecting the camera, drag the “FinePixViewer” folder from “Applications” into the Trash and select **Empty Trash** in the **Finder** menu (Macintosh), or open the control panel and use “Programs and Features” (Windows 7/Windows Vista) or “Add or Remove Programs” (Windows XP) to uninstall MyFinePix Studio. Under Windows, one or more confirmation dialogs may be displayed; read the contents carefully before clicking **OK**.

The Shooting Menu

The shooting menu is used to adjust settings for a wide range of shooting conditions.

Using the Shooting Menu

- 1 Press **MENU/OK** to display the shooting menu.

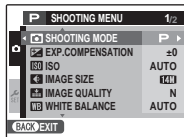

- 2 Press the selector up or down to highlight the desired menu item.



- 3 Press the selector right to display options for the highlighted item.



- 4 Press the selector up or down to highlight the desired option.



- 5 Press **MENU/OK** to select the highlighted option.



- 6 Press **DISP/BACK** to exit from the menu.



ISO ISO

Control the camera's sensitivity to light. Higher values can be used to reduce blur when lighting is poor; note, however, that mottling may appear in pictures taken at high sensitivities. If **AUTO** is selected, the camera will adjust sensitivity automatically in response to shooting conditions.

Settings other than **AUTO** are shown by an icon in the display.

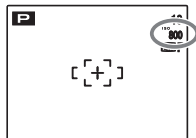
**IMAGE SIZE**

Choose the size and quality at which still pictures are recorded. Large pictures can be printed at large sizes with no drop in quality; small pictures require less memory, allowing more pictures to be recorded.

Option	Prints at sizes up to
14M, 12M, 11M, 10M	31 × 23 cm (12 × 9 in.) or 31 × 21 cm (12 × 8 in.)
9M, 7M, 6M	22 × 16 cm (8.5 × 6.5 in.)
3M	17 × 13 cm (7 × 5 in.)
2M	14 × 10 cm (5.3 × 4 in.)
03M	5 × 4 cm (2 × 1.5 in.). Suited to e-mail or the web.

The number of pictures that can be taken at current settings (pg. 94) is displayed to the top right in the monitor.

●● Aspect Ratio

Pictures with an aspect ratio of 4:3 have the same proportions as the camera display. Pictures with an aspect ratio of 3:2 have the same proportions as a frame of 35-mm film, while an aspect ratio of 16:9 is suited to display on High Definition (HD) devices.



4:3



3:2



16:9

📷 IMAGE QUALITY

Choose how much image files are compressed. Select **FINE** (low compression) for higher image quality, **NORMAL** (high compression) to increase the number of pictures that can be stored.

👉 Note

Image quality is not reset when the camera is turned off or another shooting mode is selected.

EXP. COMPENSATION

Use exposure compensation when photographing very bright, very dark, or high-contrast subjects.

Choose positive (+) values to increase exposure



Choose negative (-) values to reduce exposure



Choosing an Exposure Compensation Value

- **Backlit subjects:** choose values from $+2/3$ EV to $+1 2/3$ EV (for an explanation of the term “EV”, see the Glossary on page 93)



- **Highly reflective subjects or very bright scenes** (e.g., snowfields): +1 EV









- **Scenes that are mostly sky:** +1 EV
- **Spotlit subjects** (particularly if photographed against dark backgrounds): $-2/3$ EV
- **Subjects with low reflectivity** (pine trees or dark-colored foliage): $-2/3$ EV

Note

At settings other than ± 0 , a  icon is displayed in the monitor. Exposure compensation is not reset when the camera is turned off; to restore normal exposure control, choose a value of ± 0 .

WB WHITE BALANCE

For natural colors, choose a setting that matches the light source (for an explanation of “white balance,” see the Glossary on page 93).

Option	Description
AUTO	White balance adjusted automatically.
	For subjects in direct sunlight.
	For subjects in the shade.
	Use under “daylight” fluorescent lights.
	Use under “warm white” fluorescent lights.
	Use under “cool white” fluorescent lights.
	Use under incandescent lighting.

If **AUTO** does not produce the desired results (for example, when taking close-ups), choose the option that matches the light source.

← Note

Results vary with shooting conditions. Play pictures back after shooting to check colors in the monitor.

CONTINUOUS (Continuous shooting)

Capture motion in a series of pictures. The camera takes up to three pictures while the shutter-release button is pressed.

Notes

- Frame rate varies with shutter speed.
- Focus and exposure are determined by the first frame in each series.
- The number of pictures that can be recorded depends on the memory available.
Additional time may be required to record pictures when shooting ends. The pictures are displayed in the monitor while recording is in progress.



The Playback Menu

The playback menu is used to manage the pictures in internal memory or on the memory card.

Using the Playback Menu

1 Press  to enter playback mode (pg. 33).



2 Press **MENU/OK** to display the playback menu.

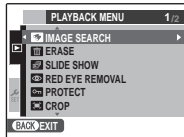

3 Press the selector up or down to highlight the desired menu item.



4 Press the selector right to display options for the highlighted item.

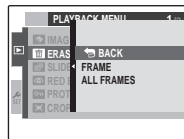

5 Press the selector up or down to highlight the desired option.













6 Press **MENU/OK** to select the highlighted option.



Playback Menu Options

The following options are available:

Option	Description
 IMAGE SEARCH	Search images based on categories (pg. 36).
 ERASE	Delete all or selected pictures (pg. 38).
 SLIDE SHOW	View pictures in a slide show (pg. 65).
 RED-EYE REMOVAL	Create copies with reduced red eye (pg. 66).
 PROTECT	Protect pictures from accidental deletion (pg. 67).
 CROP	Create cropped copies of pictures (pg. 68).
 RESIZE	Create small copies of pictures (pg. 69).
 IMAGE ROTATE	Rotate pictures (pg. 69).
 COPY	Copy pictures between internal memory and a memory card (pg. 70).
 PRINT ORDER (DPOF)	Select pictures for printing on DPOF- and PictBridge-compatible devices (pg. 45).

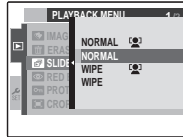

SLIDE SHOW

View pictures in an automated slide show. Choose the type of show and press **MENU/OK** to start. Press **DISP/BACK** at any time during the show to view on-screen help. When a movie is displayed, movie playback will begin automatically, and the slide show will continue when the movie ends. The show can be ended at any time by pressing **MENU/OK**.





Note

The camera will not turn off automatically while a slide show is in progress.

Option	Description
NORMAL	Press selector left or right to go back or skip ahead one frame. Select WIPE for wipe transitions between frames.
WIPE	
NORMAL 	As above, except that camera automatically zooms in on faces selected with Intelligent Face detection (pg. 23).
WIPE 	

RED EYE REMOVAL

This option is used with pictures taken using Intelligent Face Detection to create copies that have been processed to remove red eye.



- 1 Play the picture back in the monitor (pictures taken with Intelligent Face Detection are indicated by a  icon) and select  **RED EYE REMOVAL** in the playback menu (pg. 63).

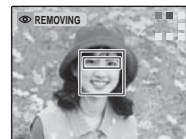
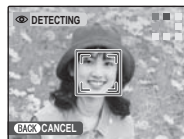

- 2 Press **MENU/OK**. The message shown below at left will be displayed while the camera analyses the image; if red-eye is detected, the message shown below at right will be displayed while the camera processes the image to create a copy with reduced red-eye.



Notes

- Red eye may not be removed if the camera is unable to detect a face or the face is in profile. Results may differ depending on the scene. Red eye can not be removed from pictures that have already been processed using red-eye removal or pictures created with other devices.
- The amount of time needed to process the image varies with the number of faces detected.
- Copies created with  **RED EYE REMOVAL** are indicated by a  icon during playback.

PROTECT

Protect pictures from accidental deletion. The following options are available.

■ FRAME

Protect selected pictures.

- 1 Press the selector left or right to display the desired picture.

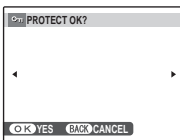

Picture not protected

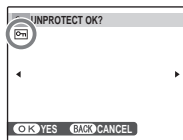

Protected picture

- 2 Press **MENU/OK** to protect the picture. If the picture is already protected, pressing **MENU/OK** will remove protection from the image.



- 3 Repeat steps 1–2 to protect additional images. Press **DISP/BACK** to exit when the operation is complete.



■ SET ALL

Press **MENU/OK** to protect all pictures, or press **DISP/BACK** to exit without changing picture status.

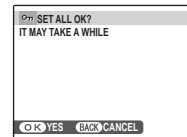

■ RESET ALL

Press **MENU/OK** to remove protection from all pictures, or press **DISP/BACK** to exit without changing picture status.

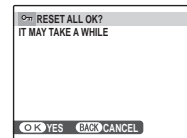

If the number of pictures affected is very large, the display at right will appear in the monitor while the operation is in progress.

Press **DISP/BACK** to exit before the operation is complete.

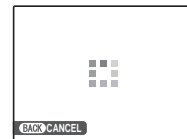

Caution

Protected pictures will be deleted when the memory card or internal memory is formatted (pg. 76).



CROP

To create a cropped copy of a picture, play the picture back and select  **CROP** in the playback menu (pg. 63).

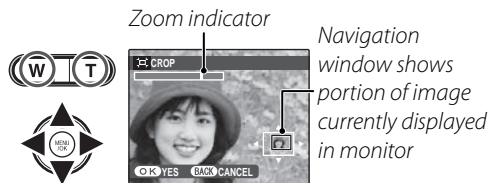
- 1 Press the zoom buttons to zoom in and out and use the selector to scroll the picture until the desired portion is displayed (to exit to single-frame playback without creating a cropped copy, press **DISP/BACK**).



Tip: Intelligent Face Detection

If the picture was shot with Intelligent Face Detection (pg. 23),  will be displayed in the monitor. Press the  button to zoom in on the selected face.



- 2 Press **MENU/OK**. A confirmation dialog will be displayed.

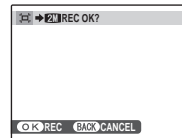

Copy size is shown at the top; if the size is **03M**, **OK** is displayed in yellow. Larger crops produce larger copies; all copies have an aspect ratio of 4:3.

- 3 Press **MENU/OK** to save the cropped copy to a separate file.



RESIZE

To create a small copy of a picture, play the picture back and select **RESIZE** in the playback menu.

- 1 Press the selector up or down to highlight **640 STANDARD** or **320 SMALL**.
- 2 Press **MENU/OK** to select the highlighted option.
- 3 Press **MENU/OK** to copy the picture at the selected size.

**IMAGE ROTATE**

By default, pictures taken in tall orientation are displayed in wide orientation. Use this option to display pictures in the correct orientation in the monitor. It has no effect on pictures displayed on a computer or other device.

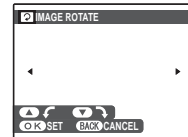
**Notes**

- Protected pictures can not be rotated. Remove protection before rotating pictures (pg. 67).
- The camera may not be able to rotate pictures created with other devices.

To rotate a picture, play the picture back and select **IMAGE ROTATE** in the playback menu (pg. 63).

- 1 Press the selector down to rotate the picture 90° clockwise, up to rotate the picture 90° counterclockwise.



- 2 Press **MENU/OK** to confirm the operation (to exit without rotating the picture, press **DISP/BACK**).



The next time the picture is played back, it will automatically be rotated.

COPY COPY

Copy pictures between internal memory and a memory card.

- 1 Press the selector up or down to highlight **IN INTERNAL MEMORY**
 → **SD CARD** (copy pictures from internal memory to the memory card) or
SD CARD → **IN INTERNAL MEMORY** (copy pictures from a memory card to internal memory).



- 2 Press the selector right to display options for the highlighted item.

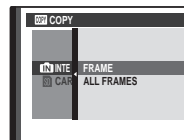

- 3 Press the selector up or down to highlight **FRAME** or **ALL FRAMES**.



- 4 Press **MENU/OK**.



Tip: Copying Pictures Between Memory Cards

To copy pictures between two memory cards, insert the source card and copy the pictures to internal memory, then remove the source card, insert the destination card, and copy the pictures from internal memory.

FRAME

Copy selected frames.

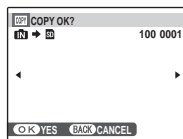

- 1 Press the selector left or right to display the desired picture.
- 2 Press **MENU/OK** to copy the picture.
- 3 Repeat steps 1–2 to copy additional images. Press **DISP/BACK** to exit when the operation is complete.

**ALL FRAMES**

Press **MENU/OK** to copy all pictures, or press **DISP/BACK** to exit without copying pictures.

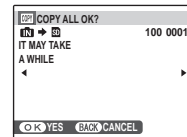
**Cautions**

- Copying ends when the destination is full.
- DPOF print information is not copied (pg. 47).

The Setup Menu

Using the Setup Menu

1 Display the setup menu.

1.1 Press **MENU/OK** to display the menu for the current mode.



1.2 Press the selector left to highlight a left tab.



1.3 Press the selector up or down to select **SET**.
The setup menu appears.

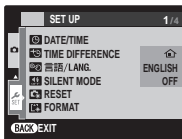

2 Adjust settings.

2.1 Press the selector right to activate the setup menu.



2.2 Press the selector up or down to highlight a menu item.

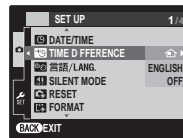

2.3 Press the selector right to display options for the highlighted item.



2.4 Press the selector up or down to highlight an option.



2.5 Press **MENU/OK** to select the highlighted option.













2.6 Press **DISP/BACK** to exit from the menu.



Setup Menu Options

	Menu item	Description	Options	Default
1/4	DATE/TIME	Set the camera clock.	—	—
	TIME DIFFERENCE	Set the clock to local time (pg. 75).	/	
	言語/LANG.	Choose a language.	See page 99	ENGLISH
	SILENT MODE	Turn off the speaker, flash, and self-timer lamp.	ON / OFF	OFF
	RESET	Reset all settings except Frame number , DATE/TIME , TIME DIFFERENCE , VIDEO SYSTEM , and BATTERY TYPE to default values. A confirmation dialog will be displayed, press the selector left or right to highlight OK and press MENU/OK .	—	—
	FORMAT	Format internal memory or memory cards (pg. 76).	—	—
2/4	IMAGE DISP.	Choose how long pictures are displayed after shooting (pg. 76).	3 SEC / 1.5 SEC / ZOOM (CONTINUOUS) / OFF	1.5 SEC
	FRAME NO.	Choose how files are named (pg. 77).	CONTINUOUS / RENEW	CONTINUOUS
	OPERATION VOL.	Adjust the volume of camera controls.	(high) / (mid) / (low) / OFF (mute)	
	SHUTTER VOLUME	Adjust the volume of the shutter sound.		
	PLAYBACK VOLUME	Adjust the volume for movie playback (pg. 77).	—	7
LCD BRIGHTNESS	Control the brightness of the display (pg. 78).	—	0	

	Menu item	Description	Options	Default
3/4	 LCD MODE	Enable or disable monitor power saving (pg. 78).	ON / OFF	ON
	 AUTO POWER OFF	Choose the auto power off delay (pg. 78).	5 MIN / 2 MIN / OFF	2 MIN
	 DIGITAL IS	Reduces camera shake and moving-subject blur.	AUTO / OFF	OFF
	 RED EYE REMOVAL	Remove "red-eye" effects caused by the flash.	ON / OFF	ON
	 DIGITAL ZOOM	Enable or disable digital zoom (pg. 79).	ON / OFF	OFF
4/4	 MOVIE ZOOM TYPE	Choose the zoom type when recording movies.	DIGITAL / OPTICAL	DIGITAL
	 SAVE ORG IMAGE	Choose whether to save unprocessed copies of pictures taken using red-eye removal.	ON / OFF	OFF
	 GUIDANCE DISPLAY	Choose whether to display tool tips.	ON / OFF	ON
	 VIDEO SYSTEM	Choose a video mode for connection to a TV (pg. 43).	NTSC / PAL	—
	 BATTERY TYPE	Specify the type of battery used in the camera (pg. 79).	ALKALINE / Ni-MH	ALKALINE
	 DISCHARGE	Discharge rechargeable Ni-MH batteries (pg. 79).	—	—

TIME DIFFERENCE

When traveling, use this option to switch the camera clock instantly from your home time zone to the local time at your destination.

1 Specify the difference between local time and your home time zone.

1.1 Press the selector up or down to highlight **← LOCAL**.



1.2 Press the selector right to display the time difference.

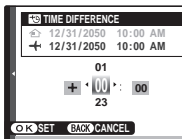

1.3 Press the selector left or right to highlight **+**, **-**, hours, or minutes; press up or down to edit. The minimum increment is 15 minutes.



1.4 Press **MENU/OK** when settings are complete.



2 Switch between local time and your home time zone.

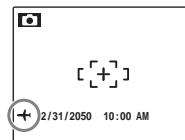

To set the camera clock to local time, highlight **← LOCAL** and press **MENU/OK**.

To set the clock to the time in your home time zone, select **HOME**. If **← LOCAL** is selected, **←** will be displayed in the monitor for three seconds after the camera enters shooting mode, and the date will be displayed in yellow.



After changing time zones, check that the date and time are correct.

FORMAT

Format internal memory or a memory card. If a memory card is inserted in the camera,  will be displayed in the dialog shown at right and this option will format the memory card. If no memory card is inserted,  will be displayed and this option will format internal memory. Highlight **OK** and press **MENU/OK** to begin formatting.

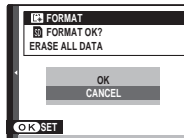

Cautions



- All data—including protected pictures—will be deleted. Be sure important files have been copied to a computer or other storage device.
- Do not open the battery cover during formatting.

IMAGE DISP.

Choose how long pictures are displayed in the monitor after shooting.

- **3 SEC:** Pictures are displayed for about 3 s before being recorded to the memory card.
- **1.5 SEC:** Pictures are displayed for about 1.5 s before being recorded to the memory card.
- **ZOOM (CONTINUOUS):** Pictures are displayed until the **MENU/OK** button is pressed. Pictures can be zoomed in to check fine details.

When the picture is zoomed in, the selector can be used to view areas of the image not currently visible in the display.

When the picture was taken with  **FACE DETECTION** turned on, detected face is zoomed. When more than one face was detected, you can move to the next face by pressing .

ZOOM (CONTINUOUS) is disabled in the following case:

-  is selected in the shooting mode.
- An option other than **OFF** is selected for

 **CONTINUOUS.**

← Notes

- Pictures taken in continuous shooting modes are always displayed after shooting.
- The colors displayed at settings of **1.5 SEC** and **3 SEC** may differ from those in the final picture.

FRAME NO.

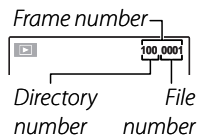

New pictures are stored in image files named using a four-digit file number assigned by adding one to the last file number used.



The file number is displayed during playback as shown at right. **FRAME NO.** controls whether file numbering is reset to 0001 when a new memory card is inserted or the current memory card or internal memory is formatted.

- **CONTINUOUS:** Numbering continues from the last file number used or the first available file number, whichever is higher. Choose this option to reduce the number of pictures with duplicate file names.
- **RENEW:** Numbering is reset to 0001 after formatting or when a new memory card is inserted.

← Notes

- If the frame number reaches 999-9999, the shutter release will be disabled (pg. 91).
- Selecting  **RESET** (pg. 73) resets  **FRAME NO.** to **CONTINUOUS** but does not reset frame numbering.
- Frame numbers for pictures taken with other cameras may differ.

PLAYBACK VOLUME

Press the selector up or down to choose volume for movie playback and press **MENU/OK** to select.

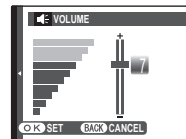

LCD BRIGHTNESS

Press the selector up or down to choose monitor brightness and press **MENU/OK** to select.

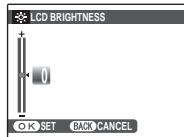

LCD MODE

If **ON** is selected, the monitor will dim to save power if no operations are performed for several seconds. Full brightness can be restored by pressing the shutter button halfway. The monitor does not dim in movie mode or during playback.

AUTO POWER OFF

Choose the length of time before the camera turns off automatically when no operations are performed. Shorter times increase battery life; if **OFF** is selected, the camera must be turned off manually. Note that regardless of the option selected, the camera will not turn off automatically when connected to a printer (pg. 44) or computer (pg. 54) or when a slide show is in progress (pg. 65).

Tip: Reactivating the Camera

To reactivate the camera after it has turned off automatically, use the **ON/OFF** button or press the  button for about a second (pg. 9).

Note

Although **OFF** is selected for  **AUTO POWER OFF**, the camera will turn off automatically if no operations are performed for five minutes in the following case:

- **STANDBY** is displayed in .
-  is displayed in the shooting mode.

DIGITAL ZOOM

If **ON** is selected, pressing **T** at the maximum optical zoom position will trigger digital zoom, further magnifying the image. To cancel digital zoom, zoom out to the minimum digital zoom position and press **W**.

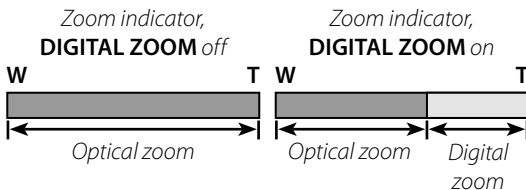
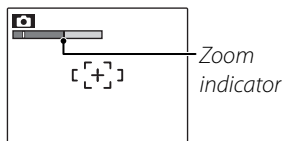

Caution



Digital zoom produces lower quality images than optical zoom.

BATTERY TYPE

After replacing the batteries with batteries of a different type, select the battery type to ensure that the battery level is displayed correctly and the camera does not turn off unexpectedly.

- **ALKALINE:** AA alkaline (LR6) battery
- **Ni-MH:** AA Ni-MH (nickel-metal hydride) battery

DISCHARGE (Ni-MH Batteries Only)

The capacity of rechargeable Ni-MH batteries may be temporarily reduced when new, after long periods of disuse, or if they are repeatedly recharged before being fully discharged. Capacity can be increased by repeatedly discharging the batteries using the  **DISCHARGE** option and recharging them in a battery charger (sold separately). Do not use  **DISCHARGE** with non-rechargeable batteries.

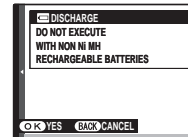

- 1 Selecting  **DISCHARGE** displays the message shown above. Press **MENU/OK**.

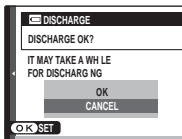

- 2 Press the selector up or down to highlight **OK**.



- 3 Press **MENU/OK** to begin discharging the batteries. When the batteries are fully discharged, the battery level indicator will blink red and the camera will turn off. To cancel the process before the batteries are fully discharged, press **DISP/BACK**.



Optional Accessories

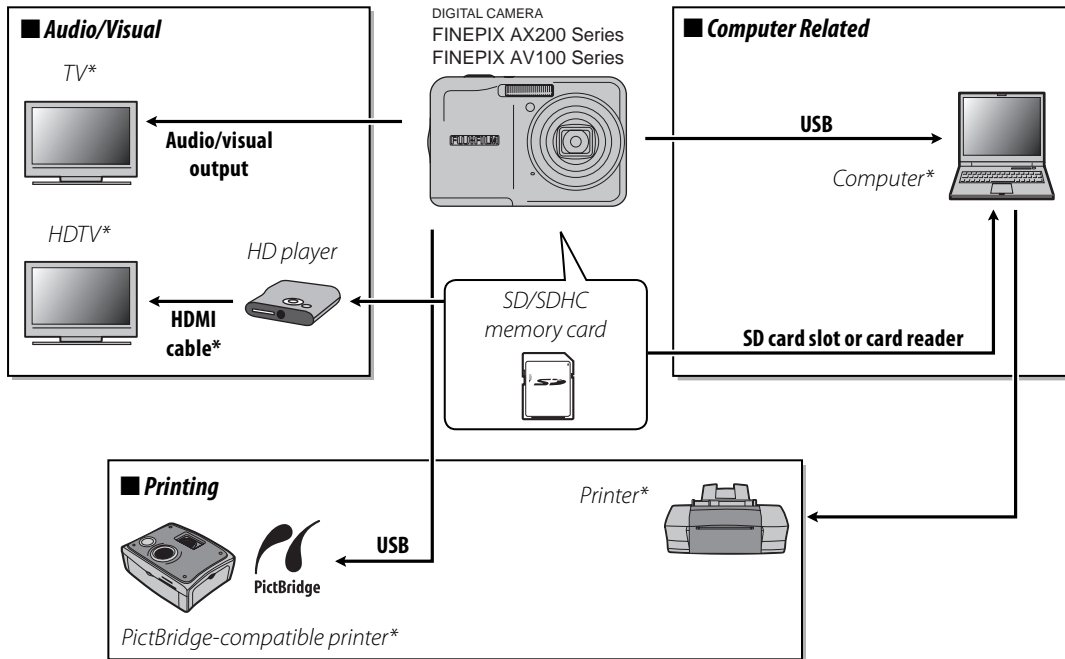

The camera supports a wide range of accessories from FUJIFILM and other manufacturers.



* Available from third-party suppliers.



Accessories from Fujifilm

The following optional accessories were available from FUJIFILM. For the latest information on the accessories available in your region, check with your local Fujifilm representative or visit http://www.fujifilm.com/products/digital_cameras/index.html.

A/V cable	AV-C1	Connects the camera and a TV.	
HD player	HDP-L1	Still pictures and movies in SD card can be viewed by HDTV (requires HDMI cable, available from third-party suppliers).	

Troubleshooting

Power and Battery

	Problem	Possible cause	Solution	Page
Power supply	The camera does not turn on.	The batteries are exhausted.	Insert fresh or fully-charged spare batteries.	4
		The batteries are not in the correct orientation.	Re-insert the batteries in the correct orientation.	4
	The batteries run down quickly.	The batteries are cold.	Warm the batteries by placing them in a pocket or other warm place and re-insert them in the camera immediately before taking a picture.	—
		There is dirt on the battery terminals.	Clean the terminals with a soft, dry cloth.	—
		The camera is in  mode.	Choose a different shooting mode.	13
		The batteries are new, have been left unused for an extended period, or have been recharged without first being fully discharged (rechargeable Ni-MH batteries only).	Discharge Ni-MH batteries using the  DISCHARGE option and recharge them in a battery charger (sold separately). If the batteries do not hold a charge after repeated discharging and recharging, they have reached the end of their service life and must be replaced.	74
		The camera turns off suddenly.	The batteries are exhausted.	Insert fresh or fully-charged spare batteries.



Menus and Displays

Problem	Possible cause	Solution	Page
Menus and displays are not in English.	English is not selected for the  言語/LANG.	Select ENGLISH .	10

Shooting

Problem	Possible cause	Solution	Page	
Taking pictures	No picture is taken when the shutter button is pressed.	Memory is full.	Insert a new memory card or delete pictures.	5, 38
		Memory is not formatted.	Format the memory card or internal memory.	76
		There is dirt on the memory card contacts.	Clean the contacts with a soft, dry cloth.	6
		The memory card is damaged.	Insert a new memory card.	5
		The batteries are exhausted.	Insert fresh or fully-charged spare batteries.	4
		The camera has turned off automatically.	Turn the camera on.	9, 78
	The monitor goes dark after shooting.	The flash has fired.	The monitor may darken while the flash charges. Wait for the flash to charge.	28
Focus	The camera does not focus.	The subject is close to the camera.	Select macro mode.	27
		The subject is far away from the camera.	Cancel macro mode.	
		The subject is not suited to autofocus.	Use focus lock.	25

	Problem	Possible cause	Solution	Page
	Face detection not available.	The camera is in a shooting mode which makes Intelligent Face Detection unavailable.	Choose a different shooting mode.	18
Intelligent Face Detection	No face is detected.	The subject's face is obscured sunglasses, a hat, long hair, or other objects.	Remove the obstructions.	23
		The subject's face occupies only a small area of the frame.	Change the composition so that the subject's face occupies a larger area of the frame.	
		The subject's head is tilted or horizontal.	Ask the subject to hold their head straight.	
		The camera is tilted.	Hold the camera straight.	14
	The subject's face is poorly lit.	Shoot in bright light.	—	
	Wrong subject selected.	The selected subject is closer to the center of the frame than the main subject.	Recompose the picture or turn face detection off and frame the picture using focus lock.	25
Close-ups	Macro mode is not available.	The camera is in a shooting mode which makes macro (close-up) mode unavailable.	Choose a different shooting mode.	18

	Problem	Possible cause	Solution	Page
Flash	The flash does not fire.	The flash is charging.	Wait for the flash to charge.	16
		The camera is in a shooting mode in which the flash does not fire.	Choose a different shooting mode.	18
		The batteries are exhausted.	Insert fresh or fully-charged spare batteries.	4
		The camera is in continuous mode.	Select OFF for  CONTINUOUS .	62
		The camera is in silent mode.	Turn silent mode off.	30
		The flash is off (🔴).	Choose a different flash mode.	28
	Some flash modes are not available.	The camera is in a shooting mode which makes some flash modes unavailable.	Choose a different shooting mode.	18
		The camera is in silent mode.	Turn silent mode off.	30
	The flash does not fully light the subject.	The subject is not in range of the flash.	Position the subject in range of the flash.	98
		The flash window is obstructed.	Hold the camera correctly.	14
Problem images	Pictures are blurred.	The lens is dirty.	Clean the lens.	102
		The lens is blocked.	Keep objects away from the lens.	14
		!AF is displayed during shooting and the focus frame is displayed in red.	Check focus before shooting.	15, 89
		 is displayed during shooting.	Use the flash or a tripod.	28
	Pictures are mottled.	The ambient temperature is high and the subject is poorly lit.	This is normal and does not indicate a malfunction. Choose a lower sensitivity.	58
	Smear appears in pictures.	The sun or another bright object was in the frame.	White or purple vertical lines may appear when a very bright object is framed in the display. This is normal and does not indicate a malfunction. Smear is not recorded in photographs but may appear in movies. If possible, avoid shooting movies with bright objects in or close to the frame.	41

Playback

	Problem	Possible cause	Solution	Page
Pictures	Pictures are grainy.	The pictures were taken with a different make or model of camera.	—	—
	Playback zoom unavailable.	The pictures were taken at an image size of 03M or with a different make or model of camera.	—	—
		Pictures were saved or cropped at the size of 03M , or copies created with RESIZE .	—	68, 69
Audio	No sound in movie playback.	Playback volume is too low.	Adjust playback volume.	42, 77
		The microphone was obstructed.	Hold the camera correctly during recording.	40
		The speaker is obstructed.	Hold the camera correctly during playback.	42
Deletion	Selected pictures are not deleted.	Some of the pictures selected for deletion are protected.	Remove protection using the device with which it was originally applied.	64
Frame no.	File numbering is unexpectedly reset.	The battery-chamber cover was opened while the camera was on.	Turn the camera off before opening the battery-chamber cover to replace the battery or insert a memory card.	9, 77

Connections

	Problem	Possible cause	Solution	Page
TV	Monitor is off.	The camera is connected to a TV.	View pictures on the TV.	43
		The camera is not properly connected.	Connect the camera correctly.	43
	No picture or sound.	The optional A/V cable was connected during movie playback.	Connect the camera once movie playback has ended.	42, 43
		Input on the television is set to "TV."	Set input to "VIDEO."	—
		The camera is not set to the correct video standard.	Match the camera VIDEO SYSTEM setting to the TV.	43, 74
		The volume on the television is too low.	Adjust the volume.	—



Problem		Possible cause	Solution	Page
TV	No color.	The camera is not set to the correct video standard.	Match the camera  VIDEO SYSTEM setting to the TV.	43, 74
Computer	The computer does not recognize the camera.	The camera is not properly connected.	Connect the camera correctly.	54
PictBridge	Pictures can not be printed.	The camera is not properly connected.	Connect the camera correctly.	44
		The printer is off.	Turn the printer on.	—
	Only one copy is printed. The date is not printed.	The printer is not PictBridge-compatible.	—	—



Miscellaneous

Problem		Possible cause	Solution	Page
Nothing happens when the shutter button is pressed.	Temporary camera malfunction.	Remove and reinsert the batteries.	4	
	The batteries are exhausted.	Insert fresh or fully-charged spare batteries.	4	
The camera does not function as expected.	Temporary camera malfunction.	Remove and reinsert the batteries. If the problem persists, contact your FUJIFILM dealer.	4	
No sound.	The camera is in silent mode.	Turn silent mode off.	30	

Warning Messages and Displays

The following warnings are displayed in the monitor:

Warning	Description	Solution
 (red)	Batteries are low.	Insert fresh or fully-charged spare batteries.
 (blinks red)	Batteries are exhausted.	
	Slow shutter speed. Picture may be blurred.	Use the flash or mount the camera on a tripod.
!AF (displayed in red with red focus frame)	The camera can not focus.	<ul style="list-style-type: none"> • Use focus lock to focus on another subject at the same distance, then recompose the picture (pg. 25). • If the subject is poorly lit, try focusing at a distance of about 2 m (6 ft. 7 in.). • Use macro mode to focus when taking close-ups.
Aperture or shutter speed shown in red	The subject is too bright or too dark. The picture will be over- or under-exposed.	If the subject is dark, use the flash.
FOCUS ERROR TURN OFF THE CAMERA AND TURN ON AGAIN	Camera malfunction.	Turn the camera off and then on again, taking care not to touch the lens. If the message persists, contact a FUJIFILM dealer.
	The lens barrel is touched.	
NO CARD	No memory card inserted when COPY is selected in the playback menu.	Insert a memory card.
CARD NOT INITIALIZED	The memory card or internal memory is not formatted.	Format the memory card or internal memory (pg. 76).
	The memory card contacts require cleaning.	Clean the contacts with a soft, dry cloth. If the message is repeated, format the memory card (pg. 76). If the message persists, replace the memory card.
	Camera malfunction.	Contact a FUJIFILM dealer.
PROTECTED CARD	The memory card is locked.	Unlock the memory card (pg. 5).
BUSY	The memory card is incorrectly formatted.	Use the camera to format the memory card (pg. 76).

Warning	Description	Solution
CARD ERROR	The memory card is not formatted for use in the camera.	Format the memory card (pg. 76).
	The memory card contacts require cleaning or the memory card is damaged.	Clean the contacts with a soft, dry cloth. If the message is repeated, format the memory card (pg. 76). If the message persists, replace the memory card.
	Camera malfunction.	Contact a FUJIFILM dealer.
 MEMORY FULL	The memory card or internal memory is full; pictures can not be recorded or copied.	Delete pictures or insert a memory card with more free space.
 MEMORY FULL		
INTERNAL MEMORY IS FULL INSERT A NEW CARD		
WRITE ERROR	Not enough memory remaining to record additional pictures.	Delete pictures or insert a memory card with more free space.
	The memory card or internal memory is not formatted.	Format the memory card or internal memory (pg. 76).
	Memory card error or connection error.	Re-insert the memory card or turn the camera off and then on again. If the message persists, contact a FUJIFILM dealer.
READ ERROR	The file is corrupt or was not created with the camera.	The file can not be played back.
	The memory card contacts require cleaning.	Clean the contacts with a soft, dry cloth. If the message is repeated, format the memory card (pg. 76). If the message persists, replace the memory card.
	Camera malfunction.	Contact a FUJIFILM dealer.

Warning	Description	Solution
FRAME NO. FULL	The camera has run out of frame numbers (current frame number is 999-9999).	Format the memory card and select RENEW for the FRAME NO. option in the SETUP menu. Take a picture to reset frame numbering to 100-0001, then return to the FRAME NO. menu and select CONTINUOUS .
TOO MANY FRAMES	An attempt was made to execute IMAGE SEARCH over too many pictures.	IMAGE SEARCH cannot process 5,000 pictures or more.
PROTECTED FRAME	An attempt was made to delete or rotate a protected picture.	Remove protection before deleting or rotating pictures.
NO IMAGE	The source device selected in the playback COPY menu contains no pictures.	Select a different source.
NO IMAGE		
CAN NOT CROP	An attempt was made to crop a picture.	These pictures can not be cropped.
CAN NOT CROP	An attempt was made to crop a picture.	
CAN NOT CROP	An attempt was made to crop a picture.	
CAN NOT CROP	The picture selected for cropping is damaged or was not created with the camera.	
CANNOT EXECUTE	An attempt was made to resize a picture.	These pictures can not be resized.
CANNOT EXECUTE	An attempt was made to resize a picture.	
DPOF FILE ERROR	The DPOF print order on the current memory card contains more than 999 images.	Copy the pictures to internal memory and create a new print order.
CAN NOT SET DPOF	The picture can not be printed using DPOF.	—
CAN NOT SET DPOF	Movies can not be printed using DPOF.	—
CAN NOT ROTATE	The picture is protected.	Remove protection before rotating pictures (pg. 67).
CAN NOT ROTATE	Movies can not be rotated.	—

Warning	Description	Solution
PRESS AND HOLD THE DISP BUTTON TO DEACTIVATE SILENT MODE	An attempt was made to choose a flash mode or adjust the volume with the camera in silent mode.	Exit silent mode before choosing a flash mode or adjusting the volume.
COMMUNICATION ERROR	A connection error occurred while pictures were being printed or copied to a computer or other device.	Confirm that the device is turned on and that the USB cable is connected.
PRINTER ERROR	Printer out of paper or ink, or other printer error.	Check printer (see printer manual for details). To resume printing, turn the printer off and then turn it back on.
PRINTER ERROR RESUME?		Check printer (see printer manual for details). If printing does not resume automatically, press MENU/OK to resume.
CAN NOT BE PRINTED	An attempt was made to print a movie, a picture not created with the camera, or a picture in a format not supported by the printer.	Movies and some pictures created with other devices can not be printed. If the picture was created with the camera, check the printer manual to confirm that the printer supports the JFIF-JPEG or Exif-JPEG format. If it does not, the pictures can not be printed.

Glossary

Digital zoom: Unlike optical zoom, digital zoom does not increase the amount of visible detail. Instead, details visible using optical zoom are simply enlarged, producing a slightly “grainy” image.

Discharge: The capacity of rechargeable Ni-MH batteries will drop if they are repeatedly charged without first being fully discharged. Full capacity can be restored by repeatedly discharging the batteries using the  **DISCHARGE** option in the camera setup menu and recharging them using a battery charger (sold separately).

DPOF (Digital Print Order Format): A standard that allows pictures to be printed from “print orders” stored in internal memory or on a memory card. The information in the order includes the pictures to be printed and the number of copies of each picture.



EV (Exposure Value): The exposure value is determined by the sensitivity of the image sensor and the amount of light that enters the camera while the image sensor is exposed. Each time the amount of light doubles, EV increases by one; each time the amount of light is halved, EV decreases by one. The amount of light entering the camera can be controlled by adjusting aperture and shutter speed.

Exif Print: A standard that allows information stored with pictures to be used for optimal color reproduction during printing.

JPEG (Joint Photographic Experts Group): A compressed file format for color images. The higher the compression rate, the greater the loss of information and more noticeable drop in quality when the picture is displayed.

Motion JPEG: An AVI (Audio Video Interleave) format that stores images and sound in a single file, with the images recorded in JPEG format. Motion JPEG files can be played in QuickTime 3.0 or later.

Smear: A phenomenon specific to CCDs which causes white streaks to appear when very bright light sources, such as the sun or reflected sunlight, appear in the frame.

WAV (Waveform Audio Format): A standard Windows audio file format. WAV files have the extension “*.WAV” and may be compressed or uncompressed. The camera uses uncompressed WAV. WAV files can be played using Windows Media Player or QuickTime 3.0 or later.

White balance: The human brain automatically adapts to changes in the color of light, with the result that objects that appear white under one light source still appear white when the color of the light source changes. Digital cameras can mimic this adjustment by processing images according to the color of the light source. This process is known as “white balance.”

Internal Memory/Memory Card Capacity

The following table shows the recording time or number of pictures available at different image qualities. All figures are approximate; file size varies with the scene recorded, producing wide variations in the number of files that can be stored. The number of exposures or length remaining may not diminish at an even rate. You can take a few pictures for trial without a memory card.

■ FinePix AX290/AX280/AX260/AX250/AV190/AV180/AV160/AV150

	Still Pictures (FINE)								Movies		
	14M	12M 3:2	10M 16:9	7M	3M	2M 16:9	2M	03M	HD 1280*	640i*	320*
Internal memory (approx. 24 MB)	3	3	4	6	15	22	23	96	5 s	19 s	41 s
1 GB	130	150	180	270	580	850	920	3650	4 min.	13 min.	28 min.
2 GB	270	310	370	540	1170	1710	1850	7310	8 min.	27 min.	57 min.
4 GB	550	630	750	1090	2350	3430	3700	14620	17 min.	54 min.	114 min.
8 GB	1110	1270	1500	2180	4700	6870	7400	29250	35 min.	108 min.	228 min.
16 GB	2220	2550	3010	4370	9410	13740	14800	58520	70 min.	216 min.	456 min.

* Individual movies cannot exceed 2GB in size, regardless of capacity of memory card.

■ FinePix AX240/AX230/AX210/AX200/AV140/AV130/AV110/AV100

	Still Pictures (FINE)								Movies		
	12M	11M 3:2	9M 16:9	6M	3M	2M 16:9	2M	03M	HD 1280*	640*	320*
Internal memory (approx. 9 MB)	1	1	1	2	5	8	8	36	3 s	6 s	14 s
1 GB	160	180	210	360	580	850	920	3650	7 min.	13 min.	28 min.
2 GB	320	360	430	730	1170	1710	1850	7310	14 min.	27 min.	57 min.
4 GB	650	730	860	1470	2350	3430	3700	14620	29 min.	54 min.	114 min.
8 GB	1300	1460	1730	2940	4700	6870	7400	29250	58 min.	108 min.	228 min.
16 GB	2610	2920	3460	5880	9410	13740	14800	58520	117 min.	216 min.	456 min.

* Individual movies cannot exceed 2GB in size, regardless of capacity of memory card.

Specifications

System	
Model	FinePix AX290/AX280/AX260/AX250/AV190/AV180/AV160/AV150
Effective pixels	14 million
CCD	½.3-in., square-pixel CCD with primary color filter
Storage media	<ul style="list-style-type: none"> • Internal memory Approx. 24 MB • SD/SDHC memory cards (see page 5)
File system	Compliant with Design Rule for Camera File System (DCF), Exif 2.2, and Digital Print Order Format (DPOF)
File format	<ul style="list-style-type: none"> • Still pictures: Exif 2.2 JPEG (compressed) • Movies: Motion JPEG AVI
Image size (pixels)	<ul style="list-style-type: none"> • 14M 4,288 × 3,216 • 10M 16:9 4,288 × 2,416 • 3M 2,048 × 1,536 • 2M 1,600 × 1,200 • 12M 3:2 4,288 × 2,864 • 7M 3,072 × 2,304 • 2M 16:9 1,920 × 1,080 • 03M 640 × 480 • 12M 4,000 × 3,000 • 9M 16:9 4,000 × 2,248 • 3M 2,048 × 1,536 • 2M 1,600 × 1,200 • 11M 3:2 4,000 × 2,666 • 6M 2,816 × 2,112 • 2M 16:9 1,920 × 1,080 • 03M 640 × 480
Lens	FinePix AX290/AX280/AX260/AX250/AX240/AX230/AX210/AX200
Focal length	Fujinon 5 × optical zoom lens, F3.6 (wide angle)-F5.9 (telephoto) f=5.0 mm-25.0 mm (35-mm format equivalent: 28 mm-140 mm)
	FinePix AV190/AV180/AV160/AV150/AV140/AV130/AV110/AV100
	Fujinon 3 × optical zoom lens, F2.9 (wide angle)-F5.2 (telephoto) f=5.7 mm-17.1 mm (35-mm format equivalent: 32 mm-96 mm)

System	
Digital zoom	FinePix AV190/AV180/AV160/AV150 Approx. 6.7 × (up to 20.1 × when combined with optical zoom)
	FinePix AV140/AV130/AV110/AV100 Approx. 6.3 × (up to 18.9 × when combined with optical zoom)
	FinePix AX290/AX280/AX260/AX250 Approx. 6.7 × (up to 33.5 × when combined with optical zoom)
	FinePix AX240/AX230/AX210/AX200 Approx. 6.3 × (up to 31.5 × when combined with optical zoom)
Aperture	FinePix AX290/AX280/AX260/AX250/AX240/AX230/AX210/AX200 F3.6/F8.0 (wide angle), F5.9/F13.0 (telephoto), uses Neutral Density (ND) filter
	FinePix AV190/AV180/AV160/AV150/AV140/AV130/AV110/AV100 F2.9/F8.8 (wide angle), F5.2/F16.0 (telephoto), uses Neutral Density (ND) filter
Focus range (distance from front of lens)	FinePix AX290/AX280/AX260/AX250/AX240/AX230/AX210/AX200 Approx. 45 cm (1.5 ft.) -infinity (wide angle); 80 cm (2.6 ft.) -infinity (telephoto) Macro mode: approx. 10 cm-80 cm/3.9 in.-2.6 ft. (wide angle); 60 cm-100 cm/2.0 ft.-3.3 ft. (telephoto)
	FinePix AV190/AV180/AV160/AV150/AV140/AV130/AV110/AV100 Approx. 60 cm (2.0 ft.) -infinity Macro mode: approx. 10 cm-70 cm/3.9 in.-2.3 ft. (wide angle); 35 cm-70 cm/1.2 ft.-2.3 ft. (telephoto)
Sensitivity	Equivalent to ISO 100, 200, 400, 800, 1600, 3200*; AUTO (Standard Output Sensitivity) * max. number of recorded pixels: 3.1M
Metering	256-segment through-the-lens (TTL) metering
Exposure control	Programmed autoexposure
Exposure compensation	-2EV - +2EV in increments of 1/3 EV (P mode)
Scene modes	(NATURAL & LIGHT), (NATURAL LIGHT), (PORTRAIT), (BABY MODE), (LANDSCAPE), (PANORAMA), (SPORT), (NIGHT), (NIGHT (TRIPOD)), (FIREWORKS), (SUNSET), (SNOW), (BEACH), (PARTY), (FLOWER), (TEXT)
Image stabilization	Available

System	
Intelligent Face Detection	Available
Shutter speed	1/4 s–1/1,400 s (AUTO mode); 8 s–1/1,400 s (other modes); combined mechanical and electronic shutter
Continuous	FinePix AX290/AX280/AX260/AX250/AV190/AV180/AV160/AV150 Up to 1.2 fps; max. 3 frames
	FinePix AX240/AX230/AX210/AX200/AV140/AV130/AV110/AV100 Up to 1.6 fps; max. 3 frames
Focus	<ul style="list-style-type: none"> • Mode: Single AF • Autofocus system: Contrast-detect TTL AF • Focus-area selection: AF CENTER
White balance	Automatic scene detection; six manual preset modes for direct sunlight, shade, daylight fluorescent, warm white fluorescent, cool white fluorescent, and incandescent lighting
Self-timer	Approx. 2 s and approx. 10 s
Flash	FinePix AX290/AX280/AX260/AX250/AX240/AX230/AX210/AX200 Auto flash; effective range when sensitivity is set to AUTO is approx. 60 cm–3.0 m/2.0 ft.–9.8 ft. (wide angle), 60 cm–2.0 m/2.0 ft.–6.6 ft. (telephoto), 30 cm–80 cm/1.0 ft.–2.6 ft. (macro)
	FinePix AV190/AV180/AV160/AV150/AV140/AV130/AV110/AV100 Auto flash; effective range when sensitivity is set to AUTO is approx. 60 cm–3.5 m/2.0 ft.–11.5 ft. (wide angle), 60 cm–2.0 m/2.0 ft.–6.6 ft. (telephoto), 30 cm–80 cm/1.0 ft.–2.6 ft. (macro)
Flash modes	Auto, forced flash, off, slow synchro (red-eye removal off); auto with red-eye removal, forced flash with red-eye removal, off, slow synchro with red-eye removal (red-eye removal on)
Monitor	FinePix AX290/AX280/AX240/AX230/AV190/AV180/AV140/AV130 3.0-in., 230k-dot color LCD monitor; frame coverage approx. 96%
	FinePix AX260/AX250/AX210/AX200/AV160/AV150/AV110/AV100 2.7-in., 230k-dot color LCD monitor; frame coverage approx. 96%
Movies	FinePix AX290/AX280/AX260/AX250/AV190/AV180/AV160/AV150 Frame size 1,280 × 720, 640 × 480 or 320 × 240 pixels; 30 fps; monaural sound
	FinePix AX240/AX230/AX210/AX200/AV140/AV130/AV110/AV100 Frame size 1,280 × 720 pixels; 24 fps; monaural sound Frame size 640 × 480 or 320 × 240 pixels; 30 fps; monaural sound

System	
Shooting options	Scene recognition, Intelligent Face Detection, best framing, and frame number memory
Playback options	Intelligent Face Detection, micro thumbnail, multi-frame playback, image search, cropping (still pictures only), slide show, red-eye removal, resize, and image rotation
Other options	PictBridge, Exif Print, language selection (Japanese / English / French / German / Spanish / Italian / Simplified Chinese / Korean / Dutch / Portuguese / Russian / Thai / Turkish / Traditional Chinese / Czech / Hungarian / Polish / Swedish / Slovak / Danish / Norwegian / Finnish / Arabic / Farsi / Greek / Lithuanian / Ukraine), time difference, discharge option for rechargeable Ni-MH batteries
Input/output terminals	
A/V OUT (audio/video output)	NTSC or PAL with monaural sound
Digital input/output	USB 2.0 High Speed; shares A/V OUT connector
Power supply/other	
Power sources	<ul style="list-style-type: none"> • AA alkaline batteries (x2) • AA rechargeable nickel-metal hydride (Ni-MH) batteries (x2; sold separately)
Battery life	<p>(AUTO mode) Approx. 180 frames (alkaline batteries of the type supplied with the camera) or 400 frames (2,700 mAh Ni-MH batteries).</p> <p>According to the CIPA (Camera & Imaging Products Association) standard procedure for measuring digital still camera battery consumption (extract):When using batteries, use the batteries supplied with the camera. The storage media should be SD memory card.</p> <p>Note that the number of shots that can be taken varies with battery make and charge state, temperature, and shooting conditions.</p>
Camera dimensions	93.0 mm x 60.2 mm x 27.8 mm / 3.7 in. x 2.4 in. x 1.1 in. (W x H x D)

Power supply/other**Camera weight****FinePix AX290/AX280/AX240/AX230**

Approx. 120 g/4.2 oz., excluding battery, accessories, and memory cards

FinePix AX260/AX250/AX210/AX200

Approx. 115 g/4.1 oz., excluding battery, accessories, and memory cards

FinePix AV190/AV180/AV140/AV130

Approx. 123 g/4.3 oz., excluding battery, accessories, and memory cards

FinePix AV160/AV150/AV110/AV100

Approx. 119 g/4.2 oz., excluding battery, accessories, and memory cards

Shooting weight**FinePix AX290/AX280/AX240/AX230**

Approx. 167 g/5.9 oz., including batteries and memory card

FinePix AX260/AX250/AX210/AX200

Approx. 163 g/5.7 oz., including batteries and memory card

FinePix AV190/AV180/AV140/AV130

Approx. 171 g/6.0 oz., including batteries and memory card

FinePix AV160/AV150/AV110/AV100

Approx. 167 g/5.9 oz., including batteries and memory card

Operating conditions

- **Temperature:** 0°C – +40 °C/+32°F – +104 °F
- **Humidity:** 85% or less (no condensation)

Color Television Systems

NTSC (National Television System Committee) is a color television telecasting specification adopted mainly in the U.S.A., Canada, and Japan. PAL (Phase Alternation by Line) is a color television system adopted mainly in European countries and China.

Notices

- Specifications subject to change without notice. FUJIFILM shall not be held liable for damages resulting from errors in this manual.
- Although the monitor is manufactured using advanced high-precision technology, small bright points and anomalous colors (particularly in the vicinity of text) may appear. This is normal for this type of monitor and does not indicate a malfunction; images recorded with the camera are unaffected.
- Digital cameras may malfunction when exposed to strong radio interference (e.g., electric fields, static electricity, or line noise).
- Due to the type of lens used, some distortion may occur at the periphery of images. This is normal.

Caring for the Camera

To ensure continued enjoyment of the product, observe the following precautions.

Storage and Use

If the camera will not be used for an extended period, remove the batteries and memory card. Do not store or use the camera in locations that are:

- exposed to rain, steam, or smoke
- very humid or extremely dusty
- exposed to direct sunlight or very high temperatures, such as in a closed vehicle on a sunny day
- extremely cold
- subject to strong vibration
- exposed to strong magnetic fields, such as near a broadcasting antenna, power line, radar emitter, motor, transformer, or magnet
- in contact with volatile chemicals such as pesticides
- next to rubber or vinyl products

Water and Sand

Exposure to water and sand can also damage the camera and its internal circuitry and mechanisms. When using the camera at the beach or seaside, avoid exposing the camera to water or sand. Do not place the camera on a wet surface.

Condensation

Sudden increases in temperature, such as occur when entering a heated building on a cold day, can cause condensation inside the camera. If this occurs, turn the camera off and wait an hour before turning it on again. If condensation forms on the memory card, remove the card and wait for the condensation to dissipate.

Cleaning

Use a blower to remove dust from the lens and monitor, then gently wipe with a soft, dry cloth. Any remaining stains can be removed by wiping gently with a piece of FUJIFILM lens-cleaning paper to which a small amount of lens-cleaning fluid has been applied. Care should be taken to avoid scratching the lens or monitor. The camera body can be cleaned with a soft, dry cloth. Do not use alcohol, thinner, or other volatile chemicals.

Traveling

Keep the camera in your carry-on baggage. Checked baggage may suffer violent shocks that could damage the camera.

FUJIFILM

FUJIFILM Corporation

7-3, AKASAKA 9-CHOME, MINATO-KU, TOKYO 107-0052, JAPAN

<http://www.fujifilm.com/>