

FUJIFILM

BL00881-201 **EN**

DIGITAL CAMERA

FINEPIX

J 27 / J 28 / J 29

J 30 / J 32 / J 37 / J 38

Owner's Manual

Thank you for your purchase of this product. This manual describes how to use your FUJIFILM FinePix J27, J28, J29, J30, J32, J37 or J38 digital camera and the supplied software. Be sure that you have read and understood its contents before using the camera.

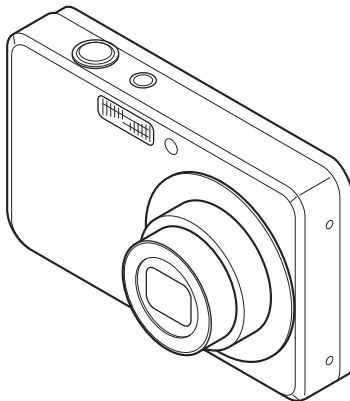

For information on related products, visit our website at <http://www.fujifilm.com/products/index.html>

Exif Print



Before You Begin

First Steps

Basic Photography and Playback

More on Photography

More on Playback

Movies

Connections

Menus

Technical Notes

Troubleshooting

Appendix



Camera Q & A

Find items by task.

Camera Setup

Question	Key phrase	See page
How do I set the camera clock?	Date and time	13
Can I set the clock to local time when I travel?	Time difference	77
How do I keep the monitor from turning off automatically?	Auto power off	76
How do I stop the camera beeping and clicking?	Silent mode	25
	Operation and shutter volume	73
What are the parts of the camera called?	Parts of the camera	2
What do the icons in the monitor mean?	Monitor	3
How do I use the menus?	Menus	56
What's behind that flashing icon or error message in the monitor?	Messages and displays	86
How much charge is left in the battery?	Battery level	14

Taking Pictures

Question	Key phrase	See page
How many pictures can I take?	Memory capacity	91
Is there a quick and easy way to take snapshots?	 mode	14
How can I make good portraits?	Intelligent Face Detection	19
Can the camera automatically select the most suitable mode?	 mode	29
Is there a simple way to adjust settings for different scenes?	Shooting mode	28
How do I shoot a panorama?	 mode	30
How do I shoot close-ups?	Macro mode (Close-ups)	23

Question	Key phrase	See page
How do I keep the flash from firing?	Flash mode	24
How do I stop my subjects' eyes glowing red when I use the flash?		
How do I "fill-in" shadows on back-lit subjects?		
How do I take a group portrait that includes the photographer?	Self-timer mode	26
How do I frame pictures with the subject off to one side?	Focus lock	21
How do I shoot movies?	Recording movies	39

Viewing Pictures

Question	Key phrase	See page
How do I view my pictures?	Single-frame playback	33
Is there a simple way to delete one image?	Deleting pictures	18
How do I delete one or all images at once?	Erase	37
Can I zoom in on pictures during playback?	Playback zoom	34
How do I view a lot of pictures at once?	Multi-frame playback	35
How do I view all pictures taken on the same day?	Sort by date	36
Can I protect my pictures from accidental deletion?	Protect	67
Can I hide the icons in the monitor when viewing my pictures?	Choosing a display format	33
How do I view my pictures on TV?	Viewing pictures on TV	42

Sharing Pictures

Question	Key phrase	See page
Can I print pictures on my home printer?	Printing pictures	43
Can I copy my pictures to my computer?	Viewing pictures on a computer	49

Table of Contents

Camera Q & A.....	ii	🕒 Using the Self-Timer.....	26
Camera Setup.....	ii	📷 Shooting Mode.....	28
Taking Pictures.....	ii	Selecting a Shooting Mode.....	28
Viewing Pictures.....	iii	Shooting Modes.....	29
Sharing Pictures.....	iii	SR SCENE RECOGNITION.....	29
About This Manual.....	vi		
Before You Begin			
Introduction 1			
Symbols and Conventions.....	1		
Supplied Accessories.....	1		
Parts of the Camera.....	2		
The Monitor.....	3		
First Steps			
Inserting the Battery.....	4		
Charging the Battery.....	6		
Inserting a Memory Card.....	8		
Turning the Camera on and Off.....	12		
Shooting Mode.....	12		
Playback Mode.....	12		
Basic Setup.....	13		
Basic Photography and Playback			
Taking Pictures in 📷 (Auto) Mode.....	14		
Viewing Pictures.....	18		
More on Photography			
Intelligent Face Detection.....	19		
Focus Lock.....	21		
📷 Macro mode (Close-ups).....	23		
⚡ Using the Flash.....	24		
More on Playback			
Single-Frame Playback.....	33		
Playback Zoom.....	34		
Multi-Frame Playback.....	35		
Sort by Date.....	36		
🗑️ Deleting Pictures.....	37		
Movies			
🎥 Recording Movies.....	39		
▶️ Viewing Movies.....	41		
Connections			
Viewing Pictures on TV.....	42		
Printing Pictures via USB.....	43		
Connecting the Camera.....	43		
Printing Selected Pictures.....	43		
Printing the DPOF Print Order.....	44		
Creating a DPOF Print Order.....	46		
Viewing Pictures on a Computer.....	49		
Installing FinePixViewer.....	49		
Installing FinePixViewer S: Windows.....	49		
Installing FinePixViewer: Macintosh.....	52		
Connecting the Camera.....	54		

Menus

The Shooting Menu	56
Using the Shooting Menu	56
Shooting Menu Options	57
ISO	58
QUALITY	59
EXP. COMPENSATION	60
WHITE BALANCE	61
CONTINUOUS (Continuous shooting)	62
The Playback Menu	63
Using the Playback Menu	63
Playback Menu Options	64
RED EYE REMOVAL	65
SLIDE SHOW	66
PROTECT	67
COPY	68
IMAGE ROTATE	70
TRIMMING	71
The Setup Menu	72
Using the Setup Menu	72
Setup Menu Options	73
IMAGE DISP.	74
FRAME NO.	74
DIGITAL ZOOM	75
LCD POWER SAVE	75
PLAYBACK VOLUME	75
LCD BRIGHTNESS	75
FORMAT	76
AUTO POWER OFF	76
TIME DIFFERENCE	77

Technical Notes

Optional Accessories	78
Accessories from Fujifilm	79

Troubleshooting

Troubleshooting	80
Warning Messages and Displays	86

Appendix

Glossary	90
Internal Memory/Memory Card Capacity	91
Specifications	93
Caring for the Camera	98

About This Manual

This manual is for use with the following FinePix cameras: the J27, J28, J29, J30, J32, J37 and J38. All operations are identical; save where otherwise noted, the illustrations in this manual show the J30.

Model	Effective pixels	Image size (pixels)
FinePix J27 / J28 / J29	10.2 million	10M F / 10M N / 9M 3:2 / 5M / 3M / 2M / 03M
FinePix J30 / J32 / J37* / J38	12.2 million	12M F / 12M N / 11M 3:2 / 6M / 3M / 2M / 03M

*FinePix J37 has a 3.0-inch monitor and the others each have a 2.7-inch monitor.

Before using the camera, read this Owner's Manual and the other supplied documents. For information on specific topics, consult the sources below.

✓ **Camera Q & A** pg. ii

Know what you want to do but don't know the name for it? Find the answer in "Camera Q & A."

✓ **Table of Contents** pg. iv

The "Table of Contents" gives an overview of the entire manual. The principal camera operations are listed here.

✓ **Troubleshooting** pg. 80

Having a specific problem with the camera? Find the answer here.

✓ **Warning Messages and Displays** pg. 86

Find out what's behind that flashing icon or error message in the monitor.

✓ **Glossary** pg. 90

The meanings of some technical terms may be found here.

✓ **Restrictions on Camera Settings**

See another supplied document for restrictions on the options available in each shooting mode.

Memory Cards

Pictures can be stored in the camera's internal memory or on optional SD and SDHC memory cards. In this manual, SD memory cards are referred to as "memory cards." For more information, see page 8.

Introduction

Symbols and Conventions

The following symbols are used in this manual:

 **Caution:** This information should be read before use to ensure correct operation.

 **Note:** Points to note when using the camera.

 **Tip:** Additional information that may be helpful when using the camera.

Menus and other text in the camera monitor are shown in bold. In the illustrations in this manual, the monitor display may be simplified for explanatory purposes.

Supplied Accessories

The following items are included with the camera:

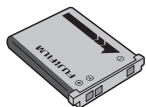

*NP-45A rechargeable
battery*



Strap

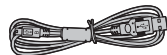

USB cable



FinePix software CD

AC adapter
(The type of the plug depends on the country or region where you purchased the camera.)

Attaching the Strap

Attach the strap as shown.

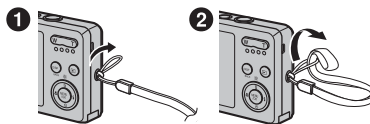

*Owner's Manual
(may be distributed
on CD in some
countries or regions)*

Parts of the Camera

For more information, refer to the page listed to the right of each item.

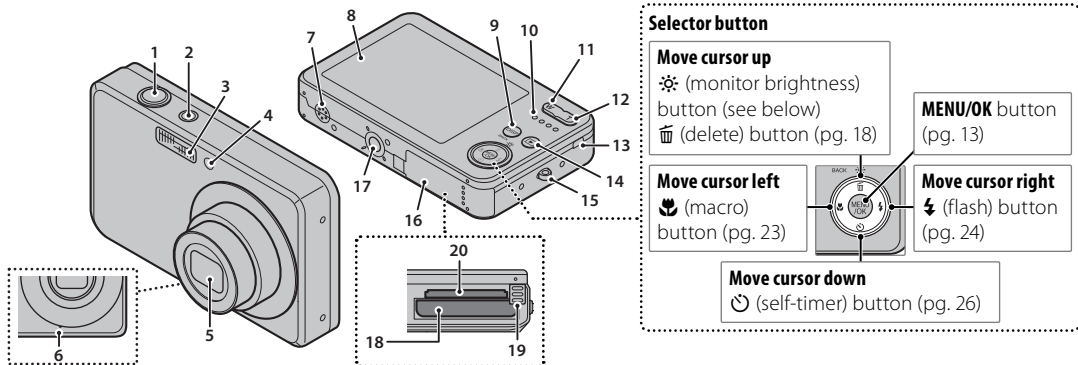

1	Shutter button.....	16–17	8	Monitor.....	3	14	▶ (playback) button.....	33
2	ON/OFF button.....	12	9	DISP (display)/ BACK button.....	16, 33	15	Strap eyelet.....	1
3	Flash.....	24		📷 (silent mode) button.....	25	16	Battery-chamber cover.....	4
4	Self-timer lamp.....	26	10	Indicator lamp.....	17	17	Tripod mount.....	
5	Lens and lens cover.....		11	W (zoom out) button.....	15, 35	18	Battery chamber.....	4
6	Microphone.....	39	12	T (zoom in) button.....	15, 34	19	Battery latch.....	4
7	Speaker.....	41	13	USB multi-connector.....	6, 42, 43, 54	20	Memory card slot.....	9

Tip: Monitor Brightness

Pressing the ☀ button briefly increases monitor brightness, making the display easier to see in bright light. Normal brightness is restored when a photograph is taken.

The Monitor

The following indicators may appear in the monitor during shooting and playback:

Shooting

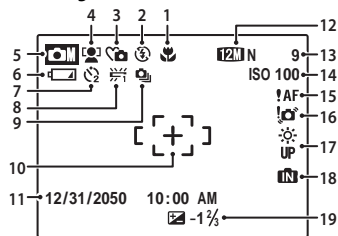

1	Macro (close-up) mode.....	23	11	Date and time.....	13
2	Flash mode.....	24	12	Quality.....	39, 59
3	Silent mode	25	13	Number of available frames....	91
4	Intelligent Face Detection indicator.....	19	14	Sensitivity.....	58
5	Shooting mode.....	28	15	Focus warning	16
6	Battery level.....	14	16	Blur warning.....	24
7	Self timer indicator.....	26	17	Bright monitor indicator.....	2
8	White balance	61	18	Internal memory indicator*	
9	Continuous mode	62	19	Exposure compensation.....	60
10	Focus frame	16			

* Indicates that no memory card is inserted and that pictures will be stored in the camera's internal memory (pg. 8).

Playback

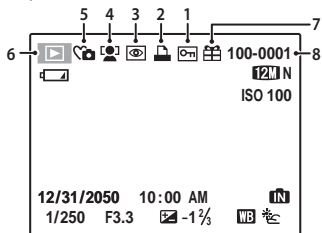

1	Protected image.....	67	5	Silent mode indicator.....	25
2	DPOF print indicator.....	46	6	Playback mode indicator	33
3	Red-eye removal indicator* ..	65	7	Gift image	33
4	Intelligent Face Detection indicator.....	19	8	Frame number.....	74

* This icon appears when playing back an image processed using the red-eye removal function in the playback menu, although the camera does not have the function in the shooting mode.

Inserting the Battery

The following explains how to insert the battery into the camera.

1 Open the battery-chamber cover.

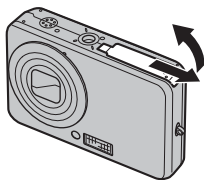

Note

Be sure the camera is off before opening the battery-chamber cover.

Cautions

- Do not open the battery-chamber cover when the camera is on. Failure to observe this precaution could result in damage to image files or memory cards.
- Do not use excessive force when handling the battery-chamber cover.

2 Insert the battery.

Face the gold contacts downward and insert the battery into the battery-chamber as shown by the marks \ominus , T and \oplus inside the battery-chamber, pressing the battery latch with the battery in the direction shown below. Confirm that the battery is securely latched.

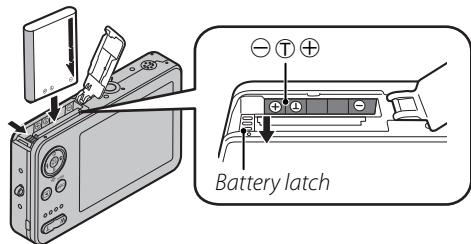

Caution

Insert the battery in the correct orientation. **Do NOT use force or attempt to insert the battery upside down or backwards.** The camera will not function if the battery is inserted backwards or upside down.

3 Close the battery-chamber cover.

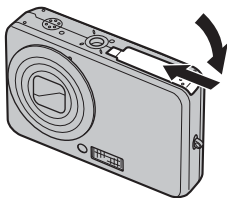

Removing the Battery

After turning the camera off, open the battery-chamber cover, press the battery latch to the top, and slide the battery out of the camera as shown.

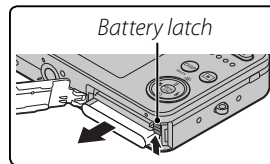

Caution

Turn the camera off before removing the battery.

Charging the Battery

The battery is not charged at shipment. Charge the battery before use.

- 1** Connect the supplied AC adapter into the USB multi-connector.

Confirm that the camera is off.

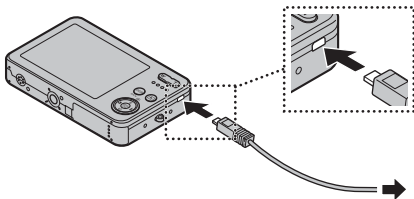

- 2** Plug the AC adapter in.

Plug the AC adapter into a power outlet. The Indicator Lamp will light up red (pg. 17). The Indicator Lamp will turn off when the battery is fully charged.

← Note

The camera operates in external power mode if you plug the AC adapter in with the camera powered on.

⚠ Cautions: Caring for the Battery

- The only types of batteries you can use are NP-45A (supplied) and NP-45 (optional).
- Use only the camera to charge NP-45A. Failure to observe this precaution could result in product malfunction.
- Do not affix stickers or other objects to the battery. Failure to observe this precaution could make it impossible to remove the battery from the camera.
- Do not short the battery terminals. The battery could overheat.
- Do not remove the labels from the battery or attempt to split or peel the outer casing.
- The battery gradually loses its charge when not in use. Charge the battery one or two days before use.
- Read the supplied documentation for additional cautions concerning battery use.

⚠ Caution: Battery Life

A noticeable decrease in the length of time the battery will hold a charge indicates that it has reached the end of its service life and should be replaced.

⚠ Cautions: Charging the Battery

- Remove dirt from the battery terminals with a clean, dry cloth. Failure to observe this precaution could prevent the battery from charging.
- Charging times increase at low temperatures.

Inserting a Memory Card

Although the camera can store pictures in internal memory, SD memory cards (sold separately) can be used to store additional pictures.

When no memory card is inserted,  appears in the monitor and internal memory is used for recording and playback. Note that because camera malfunction could cause internal memory to become corrupted, the pictures in internal memory should periodically be transferred to a computer and saved on the computer hard disk or on removable media such as CDs or DVDs. The pictures in internal memory can also be copied to a memory card (see page 68). To prevent internal memory from becoming full, be sure to delete pictures when they are no longer needed.

When a memory card is inserted as described below, the card will be used for recording and playback.

■ **Compatible Memory Cards**

SanDisk SD and SDHC memory cards have been tested and approved for use in the camera. A complete list of approved memory cards is available at http://www.fujifilm.com/products/digital_cameras/index.html. Operation is not guaranteed with other cards. The camera can not be used with MultiMediaCard (MMC) or *xD-Picture* cards.

Caution

Memory cards can be locked, making it impossible to format the card or to record or delete images. Before inserting a memory card, slide the write-protect switch to the unlocked position.

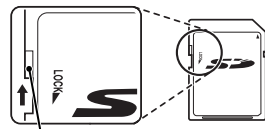

Write-protect switch

■ **Inserting a Memory Card**

1 Open the battery-chamber cover.

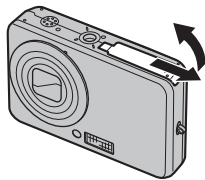

2 Insert the memory card.
Holding the memory card in the orientation shown below, slide it all the way in.

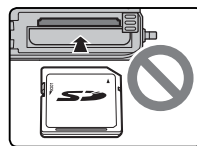
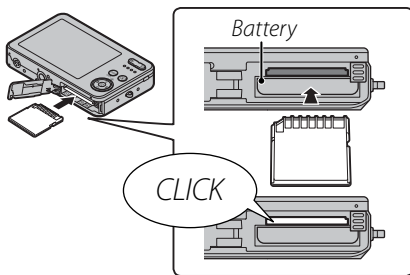

Be sure card is in correct orientation; do not insert at an angle or use force.

3 Close the battery-chamber cover.

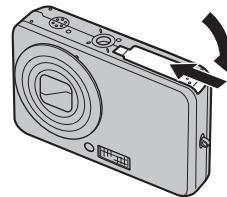

Removing Memory Cards

Be sure the camera is off before opening the battery-chamber cover. Press the card in and then release it slowly. The card can now be removed by hand.

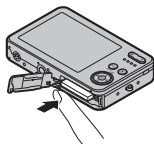

Cautions

- The memory card may spring out if you remove your finger immediately after pushing the card in.
- Memory cards may be warm to the touch after being removed from the camera. This is normal and does not indicate a malfunction.

Cautions

- Format memory cards before first use, and be sure to reformat all memory cards after using them in a computer or other device. For more information on formatting memory cards, see page 76.
- Memory cards are small and can be swallowed; keep out of reach of children. If a child swallows a memory card, seek medical assistance immediately.
- Do not use miniSD or microSD adapters that expose the back of the card. Failure to observe this precaution may cause damage or malfunction. Adapters that are larger or smaller than the standard dimensions of an SD card may not eject normally; if the card does not eject, take the camera to an authorized service representative. Do not forcibly remove the card.
- Do not turn the camera off or remove the memory card while the memory card is being formatted or data are being recorded to or deleted from the card. Failure to observe this precaution could damage the card.
- Do not affix labels to memory cards. Peeling labels can cause camera malfunction.
- Movie recording may be interrupted with some types of memory card.
- The data in internal memory may be erased or corrupted when the camera is repaired. Please note that the repairer will be able to view pictures in internal memory.
- Formatting a memory card or internal memory in the camera creates a folder in which pictures are stored. Do not rename or delete this folder or use a computer or other device to edit, delete, or rename image files. Always use the camera to delete pictures from memory cards and internal memory; before editing or renaming files, copy them to a computer and edit or rename the copies, not the originals.

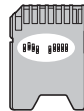

Turning the Camera on and Off

Shooting Mode

Press the **ON/OFF** button to turn the camera on. The lens will extend and the lens cover will open.

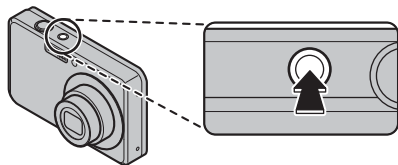

Press **ON/OFF** again to turn the camera off.

Tip: Switching to Playback Mode

Press the **▶** button to start playback. Press the shutter button halfway to return to shooting mode.

Cautions

- Pictures can be affected by fingerprints and other marks on the lens. Keep the lens clean.
- The **ON/OFF** button does not completely disconnect the camera from its power supply.

Tip: Auto Power Off

The camera will turn off automatically if no operations are performed for the length of time selected in the **AUTO POWER OFF** menu (see page 76).

Playback Mode

To turn the camera on and begin playback, press the **▶** button for about a second.

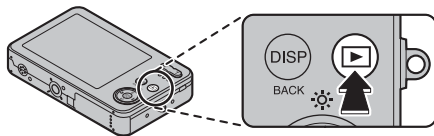

Press the **▶** button again to turn the camera off.

Tip: Switching to Shooting Mode

To exit to shooting mode, press the shutter button halfway. Press the **▶** button to return to playback.

Basic Setup

A language-selection dialog is displayed the first time the camera is turned on. Set up the camera as described below (for information on resetting the clock or changing languages, see page 72).

1 Choose a language.



1.1 Press the selector up, down, left, or right to highlight a language.



1.2 Press **MENU/OK**.



2 Set the date and time.

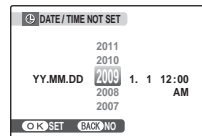

2.1 Press the selector left or right to highlight the year, month, day, hour, or minute and press up or down to change. To change the order in which the year, month, and day are displayed, highlight the date format and press the selector up or down.



2.2 Press **MENU/OK**.



← Note

Go to the setup menu if you try to set the language and date again (pg. 72).

📖 Tip: The Camera Clock

If the battery is removed for an extended period, the camera clock will be reset when the camera is turned on. If the battery has been left in the camera for about 2 hours or more, the battery can be removed for about 24 hours without resetting the clock.

Taking Pictures in (Auto) Mode

This section describes how to take pictures in  mode.

- 1 Turn the camera on.**
Press the **ON/OFF** button to turn the camera on.

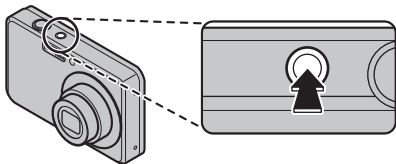

Tip: Intelligent Face Detection

The first time the camera is turned on, Intelligent Face Detection is automatically activated and the camera is optimized for taking portrait photographs. For more information on using Intelligent Face Detection, see page 19.

- 2 Check the battery level.**
Check the battery level in the monitor.

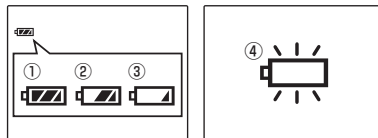

Indicator	Description
① (white)	Battery partially discharged.
② (white)	Battery more than half discharged.
③ (red)	Low battery. Charge as soon as possible.
④ (blinks red)	Battery exhausted. Turn camera off and charge battery.

3 Frame the picture.

Position the main subject in the focus area and use the zoom buttons to frame the picture in the monitor.

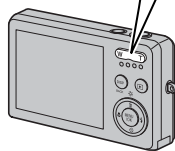
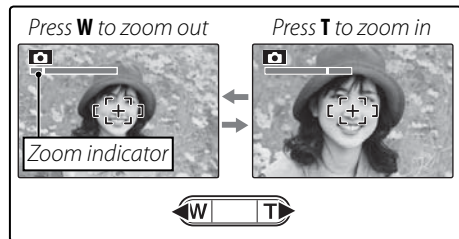

Zoom in using optical zoom, or use digital zoom (pg. 75) to zoom in closer.

Holding the Camera

Hold the camera steady with both hands and brace your elbows against your sides. Shaking or unsteady hands can blur your shots.

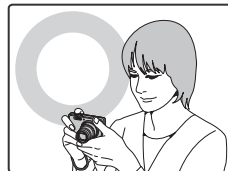

To prevent pictures that are out of focus or too dark (underexposed), keep your fingers and other objects away from the lens and flash.

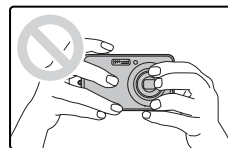

Tip: Focus Lock

Use focus lock (pg. 21) to focus on subjects that are not in the focus frame.

Framing Guideline

The images change as shown below if you press the **DISP/BACK** button.

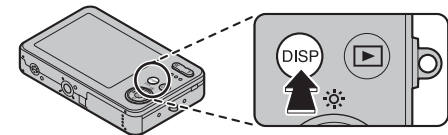

Indicators
displayed



Indicators
hidden

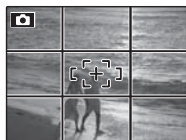

Best framing

To use the best framing, position the main subject at the intersection of two lines or align one of the horizontal lines with the horizon. Use focus lock (pg. 21) to focus on subjects that will not be in the center of the frame in the final photograph.

4 Focus.

Press the shutter button halfway to focus on the main subject in the focus frame.



Focus frame



Camera selects small
focus frame and
focuses on subject

 Press
halfway

If the camera is able to focus, it will beep twice and the indicator lamp will glow green.

If the camera is unable to focus, the focus frame will turn red, a **!AF** indicator will appear in the monitor, and the indicator lamp will blink green. Change the composition or use focus lock (pg. 21).

Note

The lens may make a noise when the camera focuses. This is normal.

5 Shoot.

Smoothly press the shutter button the rest of the way down to take the picture.



Tip: The Shutter Button

The shutter button has two positions. Pressing the shutter button halfway (①) sets focus and exposure; to shoot, press the shutter button the rest of the way down (②).

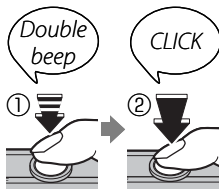

Note

If the subject is poorly lit, the flash may fire when the picture is taken. To take pictures without the flash, choose another flash mode (pg. 24).

The Indicator Lamp

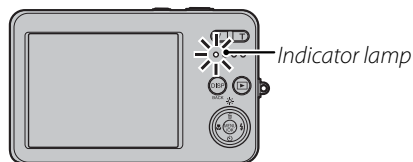

The indicator lamp shows camera status as follows:

Indicator lamp	Camera status
Glows green	Focus locked.
Blinks green	Camera shake warning, AF warning, or AE warning (ready to shoot)
Blinks green and orange	Recording pictures. Additional pictures can be taken.
Glows orange	Recording pictures. No additional pictures can be taken at this time.
Blinks orange	Flash charging; flash will not fire when picture is taken.
Glows red	Battery charging while camera is off.
Blinks red	Recording or lens error.

Tip: Warnings

Detailed warnings appear in the monitor. See pages 86–89 for more information.

Viewing Pictures

Pictures can be viewed in the monitor. When taking important photographs, take a test shot and check the results.

- 1 Press the  button.

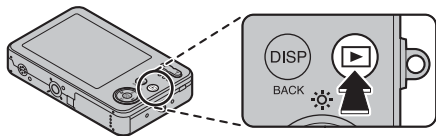

The most recent picture will be displayed in the monitor.



- 2 View additional pictures.

Press the selector right to view pictures in the order recorded, left to view pictures in reverse order.



Press the shutter button to exit to shooting mode.

Deleting Pictures

To delete the picture currently displayed in the monitor, press the selector up (). The following dialog will be displayed.

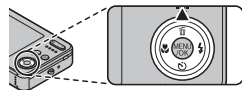

To delete the picture, press the selector left to highlight **OK** and press **MENU/OK**. To exit without deleting the picture, highlight **CANCEL** and press **MENU/OK**.



Tip: The Playback Menu

Pictures can also be deleted from the playback menu (pg. 37).

Intelligent Face Detection

Intelligent Face Detection allows the camera to automatically detect human faces and set focus and exposure for a face anywhere in the frame for shots that emphasize portrait subjects. Choose for group portraits to prevent the camera from focusing on the background.

1 Turn Intelligent Face Detection on.

- 1.1 Press **MENU/OK** to display the shooting menu.

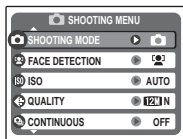

- 1.2 Press the selector up or down to highlight **FACE DETECTION**.



- 1.3 Press the selector right to display Intelligent Face Detection options.



- 1.4 Press the selector up or down to highlight the desired option.



- 1.5 Press **MENU/OK** to select the highlighted option and return to shooting mode.



 icon appears in monitor when Intelligent Face Detection is on.



2 Frame the picture.

If a face is detected, it will be indicated by a green border. If there is more than one face in the frame, the camera will select the face closest to the center; other faces are indicated by white borders.



Green border

3 Focus.

Press the shutter button halfway to set focus and exposure for the subject in the green border.



Cautions

- If no face is detected when the shutter button is pressed halfway (pg. 82), the camera will focus on the subject at the center of the monitor.
- In each shooting mode, the camera will detect and focus on faces but exposure will be optimized for the entire scene rather than the selected portrait subject.

4 Shoot.

Press the shutter button all the way down to shoot.



Caution

If the subject moves as the shutter button is pressed, their face may not be in the area indicated by the green border when the picture is taken.

Intelligent Face Detection

Intelligent Face Detection is recommended when using the self-timer for group- or self-portraits (pp. 26–27).



- The camera can zoom in on pictures taken with Intelligent Face Detection during slide shows (pg. 66).
- Red-eye removal () is available in the playback menu (pg. 65).

Focus Lock

To compose photographs with off-center subjects:

1 Position the subject in the focus frame.



2 Focus.

Press the shutter button halfway to set focus and exposure. Focus and exposure will remain locked while the shutter button is pressed halfway (AF/AE lock).



*Press
halfway*



Repeat steps 1 and 2 as desired to refocus before taking the picture.

3 Recompose the picture.

Keeping the shutter button pressed halfway, recompose the picture.



4 Shoot.



Press the shutter-release button the rest of the way down to take the picture.



*Press the rest of
the way down*

Autofocus

Although the camera boasts a high-precision autofocus system, it may be unable to focus on the subjects listed below. If the camera is unable to focus using autofocus, use focus lock (pg. 21) to focus on another subject at the same distance and then recompose the photograph.

- Very shiny subjects such as mirrors or car bodies.
- 
- Fast-moving subjects.
- 
- Subjects photographed through a window or other reflective object.
 - Dark subjects and subjects that absorb rather than reflect light, such as hair or fur.
 - Insubstantial subjects, such as smoke or flame.
 - Subjects that show little contrast with the background (for example, subjects in clothing that is the same color as the background).
 - Subjects positioned in front of or behind a high-contrast object that is also in the focus frame (for example, a subject photographed against a backdrop of highly contrasting elements).

Macro mode (Close-ups)

To select macro mode, press the selector left ()

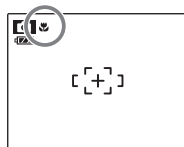
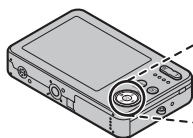

 icon appears in monitor when camera is in macro mode

When macro mode is in effect, the camera focuses on subjects near the center of the monitor. Use the zoom buttons to frame pictures.

To exit macro mode, press the selector left () . Macro mode can also be cancelled by turning the camera off or selecting another shooting mode.

Note

Use of a tripod is recommended to prevent blur caused by camera shake.

⚡ Using the Flash

Use the flash when lighting is poor, for example when shooting at night or indoors under low light.

To choose a flash mode, press the selector right (⚡). The flash mode changes each time the selector is pressed; in modes other than AUTO, the current mode is indicated by an icon in the monitor. Choose from the following options (some options are not available in all shooting modes; see the restrictions in another supplied document):

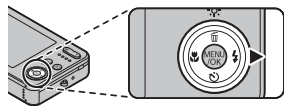

Mode	Description
AUTO (no icon)	The flash fires when required. Recommended in most situations.
👁️ (red eye reduction)	Recommended to take a portrait shot in the dark. Red-eye can be reduced.
⚡ (fill flash)	The flash fires whenever a picture is taken. Use for backlit subjects or for natural coloration when shooting in bright light.
🚫 (suppressed flash)	The flash does not fire even when the subject is poorly lit. 🚫 will appear in the monitor at slow shutter speeds to warn that pictures may be blurred. Use of a tripod is recommended.
⚡ (slow sync) 👁️ SLOW (red eye reduction + slow sync)	Capture both the main subject and the background when shooting at night (note that brightly lit scenes may be overexposed). If 🚫 is selected for 📷 SHOOTING MODE, shutter speed may be slow. Use a tripod. In 👁️ SLOW mode, red-eye can be reduced.

If the flash will fire, ⚡ will be displayed in the monitor when the shutter button is pressed halfway.

⚠️ Caution

The flash may fire several times with each shot. Do not move the camera until shooting is complete.

 **Silent Mode**

In situations in which camera sounds or light from the flash may be unwelcome, press the **DISP/BACK** button until  is displayed in the monitor.

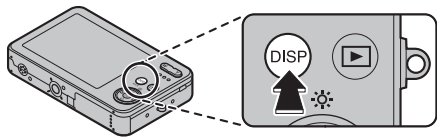

The camera speaker, shooting indicator, flash, and indicator and self-timer lamps turn off. Flash and volume settings (pg. 75) can not be adjusted while silent mode is in effect. To restore normal operation, press the **DISP/BACK** button until the  icon is no longer displayed.

🕒 Using the Self-Timer

The camera offers a ten-second timer that allows photographers to appear in their own photographs, and a two-second timer that can be used to avoid blur caused by the camera moving when the shutter button is pressed.

1 Set the timer.

The current self-timer mode is displayed in the monitor. To choose a different setting, press the selector down (🕒). The selection changes each time the selector is pressed.

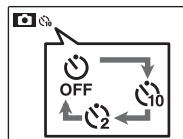
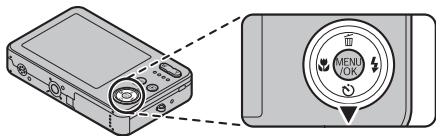

The current self-timer mode is displayed in the monitor.

🕒₁₀ : The picture is taken after 10 seconds.

🕒₂ : The picture is taken after 2 seconds.

2 Focus.

Press the shutter button halfway to focus.

⚠ Caution

Stand behind the camera when using the shutter button. Standing in front of the lens can interfere with focus and exposure.



3 Start the timer.

Press the shutter button the rest of the way down to start the timer. The display in the monitor shows the number of seconds remaining until the shutter is released. To stop the timer before the picture is taken, press **DISP/BACK**.

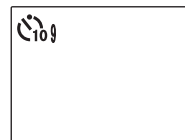

The self-timer lamp on the front of the camera will blink immediately before the picture is taken. If the two-second timer is selected, the self-timer lamp will blink as the timer counts down.

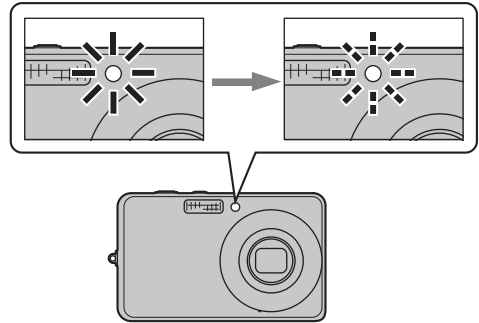

Intelligent Face Detection

Because it ensures that the faces of portrait subjects will be in focus, Intelligent Face Detection (pg. 19) is recommended when using the self-timer for group portraits or self-portraits. To use the self-timer with Intelligent Face Detection, set the timer as described in Step 1 and then press the shutter button all the way down to start the timer. The camera will detect faces while the timer is counting down and adjust focus and exposure immediately before the shutter is released. Be careful not to move until the picture has been recorded.

Shooting Mode

Choose a shooting mode according to the scene or type of subject.

Selecting a Shooting Mode

- 1** Press **MENU/OK** to display the shooting menu.

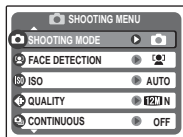

- 2** Press the selector up or down to highlight **SHOOTING MODE**.



- 3** Press the selector right to display shooting mode options.

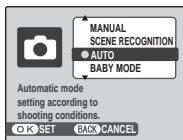

- 4** Press the selector up or down to highlight the desired mode.



- 5** Press **MENU/OK** to select the highlighted option.



← Note

See the restrictions in another supplied document for flash mode setting.

Shooting Modes

MANUAL

Choose this mode for complete control of shooting settings, including exposure compensation (pg. 61) and white balance (pg. 62).

SCENE RECOGNITION

Simply by pointing the camera to the subject, the camera automatically analyzes and selects the most appropriate setting using scene recognition.



The camera analyzes a subject based on scene recognition, then an icon appears in the bottom left of the monitor (The illustration shows when the camera analyzed subject(s) in portrait.)

Subject	Icon	Description
PORTRAIT	👤	For soft-toned portraits with natural skin tones.
LANDSCAPE	🏞️	For crisp, clear daylight shots of buildings and landscapes.
NIGHT	🌃	For night and twilight scenes, a using high sensitivity setting to minimize blurring.
MACRO	🌸	For clear close-ups of flowers, etc.
BACKLIT PORTRAIT	👤	For a subject backlit against the sun, preventing the background from becoming dim.
NIGHT PORTRAIT	🌃	For a subject in a dim place, reducing blur.

Tip

When a subject can not be analyzed by the camera, **AUTO** mode will be set.

Notes

- Intelligent Face Detection is turned on automatically.
- The camera continuously adjusts focus on a face, or the center area of the monitor.
- Continuous auto focus will be audible and will increase battery drain.
- Macro mode is set when is set.

AUTO

Choose for crisp, clear snapshots (pg. 14). This mode is recommended in most situations.

BABY MODE

Choose for natural skin tones when taking portraits of infants. The flash turns off automatically.

PICTURE STABILIZATION

Choose this mode for fast shutter speeds that reduce blur caused by camera shake or subject movement.

PORTRAIT

Choose this mode for soft-toned portraits with natural skin tones.

LANDSCAPE

Choose this mode for crisp, clear daylight shots of buildings and landscapes.

PANORAMA

In this mode, you can take up to three pictures and join them together to form a panorama. Use of a tripod is recommended to assist in composing overlapping shots.

1 Select .

2 Press the selector up to select a frame, and press the selector left or right to highlight a pan direction and press **MENU/OK**.



3 Take a photograph. Exposure and white balance for the panorama are set with the first shot.



4 Press **MENU/OK**.

An edge of the picture you have just taken will be displayed at one side of the frame.

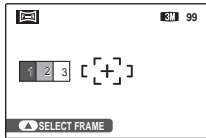

5 Frame the next shot to overlap with the previous picture.

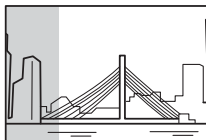

6 Take the second shot as described in steps 3-4 (to create a panorama from only two frames, press the selector up after the second shot).

7 Take the last shot, framing it to overlap the second picture.



8 Press **MENU/OK** to complete the panorama.



9 Press **MENU/OK** to save the picture (the individual shots are not saved).



SPORT

Choose this mode when photographing moving subjects. Priority is given to faster shutter speeds.

NIGHT

A high sensitivity setting is selected automatically to minimize blurring for recording night and twilight scenes.

NIGHT (TRIPOD)

Slow shutter speeds are used to record night scenes. Use of a tripod is recommended to prevent camera shake.



NATURAL LIGHT

Capture natural light indoors, under low light, or where the flash can not be used. The flash turns off and sensitivity is raised to reduce blur.

BEACH

Choose for crisp, clear shots that capture the brightness of sunlit beaches.

SNOW

Choose for crisp, clear shots that capture the brightness of scenes dominated by shining white snow.

FIREWORKS

Slow shutter speeds are used to capture the expanding burst of light from a firework. Press the selector left or right to choose a shutter speed. Use of a tripod is recommended to prevent blur. The flash turns off automatically.

SUNSET

Choose this mode to record the vivid colors in sunrises and sunsets.

FLOWER

Choose for vivid close-ups of flowers. The camera focuses in the macro range and the flash turns off automatically.

PARTY

Capture indoor background lighting under low-light conditions.

TEXT

Take clear pictures of text or drawings in print. The camera focuses in the macro range.

Single-Frame Playback

To view the most recent picture in the monitor, press the  button.

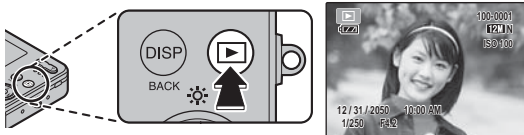

Press the selector right to view pictures in the order recorded, left to view pictures in reverse order. Keep the selector pressed to scroll rapidly to the desired frame.



Choosing a Display Format

Press the **DISP/BACK** button to cycle through playback display formats as shown below.

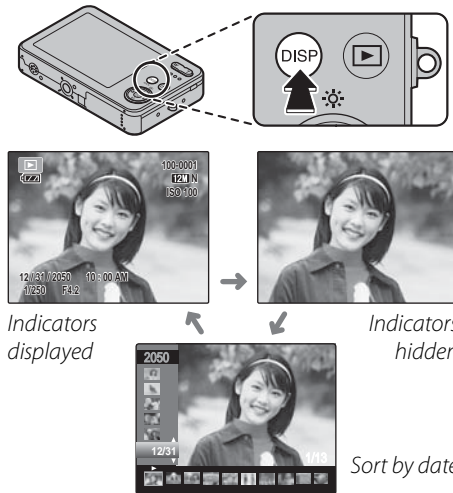

Note

Pictures taken using other cameras are indicated by a  ("gift image") icon during playback.

Playback Zoom

Press **T** to zoom in on images displayed in single-frame playback; press **W** to zoom out.



Press **W** to zoom out

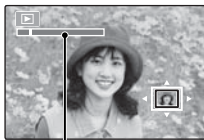

Zoom indicator

Press **T** to zoom in



When the picture is zoomed in, the selector can be used to view areas of the image not currently visible in the display.



Navigation window shows portion of image currently displayed in monitor

Press **DISP/BACK** to exit zoom.

Note

The maximum zoom ratio varies with image size. Playback zoom is not available with pictures taken at an image size of **03M**.

Multi-Frame Playback

To change the number of images displayed, press **W** when a picture is shown full-frame in the monitor.



*Press the **W** button to increase the number of pictures displayed to two, nine, or a hundred.*

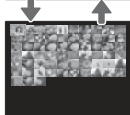

*Press **T** to reduce the number of images displayed.*

Use the selector to highlight images and press **MENU/OK** to view the highlighted image full frame. In the nine- and hundred-frame displays, press the selector up or down to view more pictures.

Sort by Date

- 1** In single-frame playback, press **DISP/BACK** until the sort-by-date screen is displayed.



The picture displayed in the single-frame playback remains selected.



- 2** Press the selector up or down to select a date.



- 3** Press the selector left or right to select a picture.



Tips: Rapid Scroll

- Press and hold the selector up or down to scroll dates rapidly.
- Press and hold the selector left or right to rapidly scroll pictures taken on the same date.

Deleting Pictures

The **ERASE** option in the playback menu can be used to delete still pictures and movies, increasing the amount of space available on the memory card or in internal memory (for information on deleting pictures in single-frame playback, see page 18). *Note that deleted pictures can not be recovered. Copy important pictures to a computer or other storage device before proceeding.*

- 1** Press **MENU/OK** to display the playback menu.

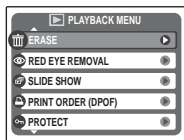

- 2** Press the selector up or down to highlight **ERASE**.



- 3** Press the selector right to display delete options.

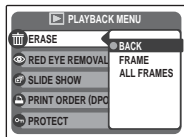

- 4** Press the selector up or down to highlight **FRAME** or **ALL FRAMES**.



- 5** Press **MENU/OK** to display options for the selected item (see pg. 38).



Tips: Deleting Pictures

- When a memory card is inserted, pictures will be deleted from the memory card; otherwise, pictures will be deleted from internal memory.
- Protected pictures can not be deleted. Remove protection from any pictures you wish to delete (pg. 67).
- If a message appears stating that the selected images are part of a DPOF print order, press **MENU/OK** to delete the pictures.

■ FRAME: *Deleting Selected Images*

Selecting **FRAME** displays the dialog shown at right.

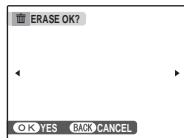

Press the selector left or right to scroll through pictures and press **MENU/OK** to delete the current picture (the picture is deleted immediately; be careful not delete the wrong picture).



Press **DISP/BACK** to exit when all the desired pictures have been deleted.

■ ALL FRAMES: *Deleting All Images*

Selecting **ALL FRAMES** displays the confirmation shown at right.

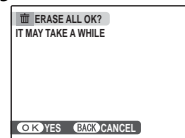

Press **MENU/OK** to delete all unprotected pictures.



The dialog shown at right is displayed during deletion. Press **DISP/BACK** to cancel before all pictures have been deleted (any pictures deleted before the button was pressed can not be recovered).

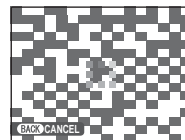

Recording Movies

Shoot short movies at 30 frames per second. Sound is recorded via the built-in microphone; do not cover the microphone during recording.

- 1 Press **MENU/OK** to display the shooting menu and select **MOVIE** for **SHOOTING MODE** (pg. 28).

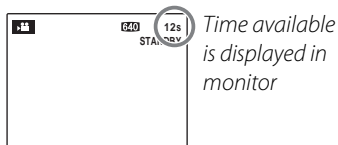

Choosing the Frame Size

To choose the frame size, press **MENU/OK** and select **QUALITY**. Choose **640** (640×480 pixels) for better quality, **320** (320×240 pixels) for longer movies. Press **MENU/OK** to return to movie recording mode.

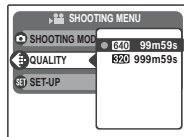

- 2 Frame the scene using the zoom buttons.

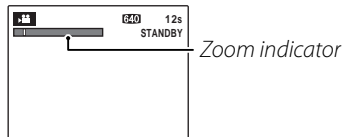

- 3** Press the shutter button all the way down to start recording.

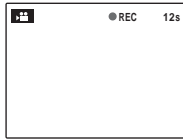

REC and time remaining are displayed in monitor

← Notes

- Focus is set when recording begins; exposure and white balance are adjusted automatically throughout recording. The color and brightness of the image may vary from that displayed before recording begins.
- Some operating noise of the camera may be recorded during movie shooting.

- 4** Press the shutter button to end recording. Recording ends automatically when the movie reaches maximum length or memory is full.



Tip

There is no need to keep the shutter button pressed during recording.

▶ Viewing Movies

During playback (pg. 33), movies are displayed in the monitor as shown at right. The following operations can be performed while a movie is displayed:

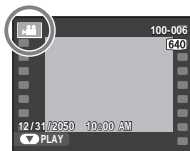

Progress is shown in the monitor during playback.

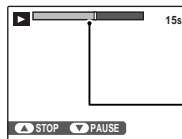

Progress bar

Operation	Description
Start/pause playback	Press the selector down to start playback. Press again to pause.
End playback/delete	Press the selector up to end playback. If playback is not in progress, pressing the selector up will delete the current movie.
Advance/rewind	Press the selector right to advance, left to rewind. If playback is paused, the movie will advance or rewind one frame each time the selector is pressed.
Adjust volume	Press MENU/OK to pause playback and display volume controls. Press the selector up or down to adjust the volume; press MENU/OK again to resume playback.

⚠ Cautions

- Do not cover the speaker during playback.
- Vertical or horizontal streaks may appear in movies containing very bright subjects. This is normal and does not indicate a malfunction.

Viewing Pictures on TV

Connect the camera to a TV and tune the television to the video channel to show pictures to a group. Connect an A/V cable (optional), as shown below.

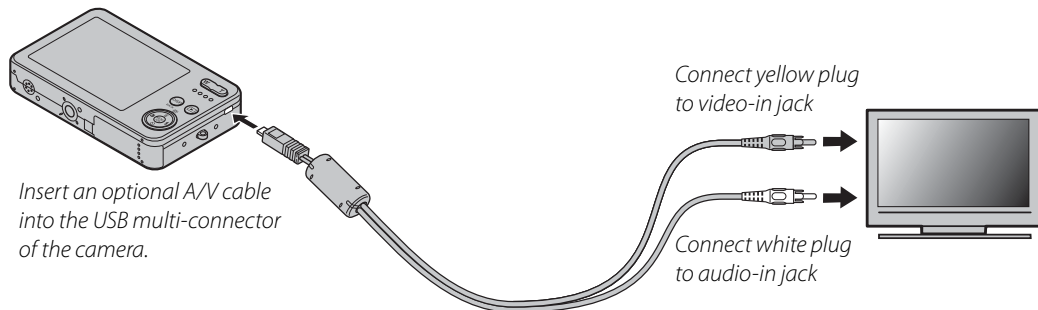

Press  for about a second to turn the camera on. The camera monitor turns off and pictures and movies are played back on the TV. Note that the camera volume controls have no effect on sounds played on the TV; use the television volume controls to adjust the volume.

Note

Image quality drops during movie playback.

Caution

When making the A/V cable connection, be sure the connectors are fully inserted.

Printing Pictures via USB

If the printer supports PictBridge, the camera can be connected directly to the printer and pictures can be printed without first being copied to a computer. Note that depending on the printer, not all the functions described below may be supported.



Connecting the Camera

- 1 Connect the supplied USB cable as shown and turn the printer on.

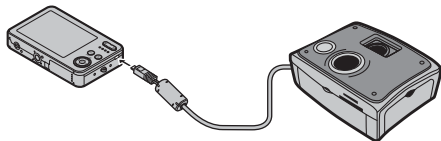

- 2 Press the button for about a second to turn the camera on. **USB** will be displayed in the monitor, followed by the PictBridge display shown below at right.

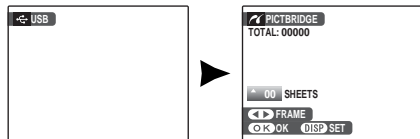

Printing Selected Pictures

- 1 Press the selector left or right to display a picture you wish to print.
- 2 Press the selector up or down to choose the number of copies (up to 99).
- 3 Repeat steps 1–2 to select additional pictures. Press **MENU/OK** to display a confirmation dialog when settings are complete.

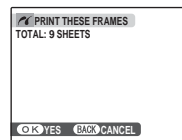

- 4 Press **MENU/OK** to start printing.



Tip: Printing the Date of Recording

To print the date of recording on pictures, press **DISP/BACK** in steps 1–2 to display the PictBridge menu (see “Printing the DPOF Print Order” on page 44). Press the selector up or down to highlight **PRINT WITH DATE**  and press **MENU/OK** to return to the PictBridge display (to print pictures without the date of recording, select **PRINT WITHOUT DATE**). The date will not be printed if the camera clock was not set when the picture was taken.

Note

If no pictures are selected when the **MENU/OK** button is pressed, the camera will print one copy of the current picture.

Printing the DPOF Print Order

To print the print order created with  **PRINT ORDER (DPOF)** in the playback menu (pg. 64):

- 1 In the PictBridge display, press **DISP/BACK** to open the PictBridge menu.

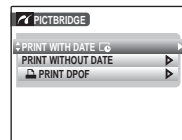

- 2 Press the selector up or down to highlight  **PRINT DPOF**.
- 3 Press **MENU/OK** to display a confirmation dialog.

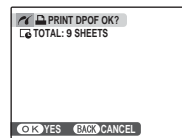



4 Press **MENU/OK** to start printing.

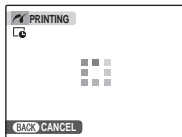

● ● **During Printing**

The message shown at right is displayed during printing. Press **DISP/BACK** to cancel before all pictures are printed (depending on the printer, printing may end before the current picture has printed).



If printing is interrupted, press  to turn the camera off and then on again.

● ● **Disconnecting the Camera**

Confirm that "PRINTING" is not displayed in the monitor and press  to turn the camera off. Disconnect the USB cable.

← **Notes**

- Print pictures from internal memory or a memory card that has been formatted in the camera.
- If the printer does not support date printing, the **PRINT WITH DATE**  option will not be available in the PictBridge menu and the date will not be printed on the pictures in the DPOF print order.
- Default printer page size and print quality settings are used when printing via direct USB connection.

Creating a DPOF Print Order



The  **PRINT ORDER (DPOF)** option in the playback menu can be used to create a digital “print order” for PictBridge-compatible printers (pg. 43) or devices that support DPOF.

DPOF

DPOF (Digital Print Order Format) is standard that allows pictures to be printed from “print orders” stored in internal memory or on a memory card. The information in the order includes the pictures to be printed and the number of copies of each picture.



■ **WITH DATE** / **WITHOUT DATE**

To modify the DPOF print order, select  **PRINT ORDER (DPOF)** in the playback menu and press the selector up or down to highlight **WITH DATE**  or **WITHOUT DATE**.

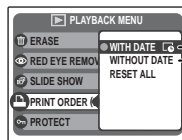

WITH DATE : *Print date of recording on pictures.*

WITHOUT DATE: *Print pictures without date.*

Press **MENU/OK** and follow the steps below.

- 1 Press the selector left or right to display a picture you wish to include in or remove from the print order.



- 2 Press the selector up or down to choose the number of copies (up to 99). To remove a picture from the order, press the selector down until the number of copies is 0.

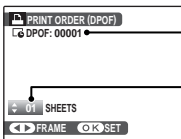

Total number of prints

Number of copies

- 3 Repeat steps 1–2 to complete the print order. Press **MENU/OK** to save the print order when settings are complete, or **DISP/BACK** to exit without changing the print order.



- 4 The total number of prints is displayed in the monitor. Press **MENU/OK** to exit.



The pictures in the current print order are indicated by a  icon during playback.

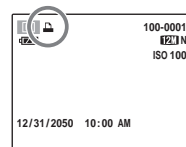

■ RESET ALL

To cancel the current print order, select **RESET ALL** in the **PRINT ORDER (DPOF)** menu. The confirmation shown at right will be displayed; press **MENU/OK** to remove all pictures from the order.

👉 Notes

- Remove the memory card to create or modify a print order for the pictures in internal memory.
- Print orders can contain a maximum of 999 pictures.
- If a memory card is inserted containing a print order created by another camera, the message shown at right will be displayed. Pressing **MENU/OK** cancels the print order; a new print order must be created as described above.

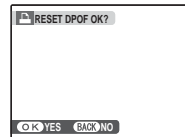
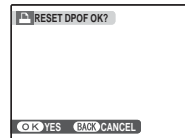

Viewing Pictures on a Computer

The supplied FinePixViewer software can be used to copy pictures to a computer, where they can be stored, viewed, organized, and printed. Before proceeding, install FinePixViewer as described below. The latest FinePixViewer is available at <http://www.fujifilm.com/>. **Do NOT connect the camera to the computer until installation is complete.**

Installing FinePixViewer

FinePixViewer is available in a Windows version (FinePixViewer S) and a Macintosh version (FinePixViewer). Installation instructions for Windows are on pages 49–51, those for the Macintosh on pages 52–53.

Installing FinePixViewer S: Windows

1 Confirm that the computer meets the following system requirements:

OS	Preinstalled versions of Windows Vista, Windows XP Home Edition, Windows XP Professional (Service Pack 2), or Windows 2000 Professional (Service Pack 4)*
CPU	<ul style="list-style-type: none">• Windows Vista: 800 MHz Pentium 4 or better (3 GHz Pentium 4 or better recommended)• Windows XP: 800 MHz Pentium 4 or better (2 GHz Pentium 4 or better recommended)• Windows 2000: 200 MHz Pentium or better
RAM	<ul style="list-style-type: none">• Windows Vista: 512 MB or more (1 GB or more recommended)• Windows XP: 512 MB or more• Windows 2000: 128 MB or more
Free disk space	A minimum of 450 MB required for installation with 600 MB available when FinePixViewer is running (15 GB or more recommended under Windows Vista, 2 GB or more recommended under Windows XP)
Video	800×600 pixels or more with 16-bit color or better (1,024×768 pixels or more with 32-bit color recommended)
Other	<ul style="list-style-type: none">• Built-in USB port recommended. Operation is not guaranteed other USB ports.• Internet connection (56 kbps or faster recommended) required to use FinePix Internet Service; Internet connection and e-mail software required to use e-mail option

* To check if FinePixViewer is Windows® 7-compliant, please visit <http://www.fujifilm.com/support/download/camera/software/>.

 **Caution**

Other versions of Windows are not supported. Operation is not guaranteed on home-built computers or computers that have been upgraded from earlier versions of Windows.

- 2 Start the computer. Log in to an account with administrator privileges before proceeding.
- 3 Exit any applications that may be running and insert the installer CD in a CD-ROM drive.

 **Windows Vista**

If an AutoPlay dialog is displayed, click **SETUP.exe**. A “User Account Control” dialog will then be displayed; click **Allow**.

The installer will start automatically; click **Installing FinePixViewer** and follow the on-screen instructions to install FinePixViewer S. Note that the Windows CD may be required during installation.

 **If the Installer Does Not Start Automatically**

If the installer does not start automatically, select **Computer** or **My Computer** from the Start menu (Windows Vista/XP) or double-click the **My Computer** icon on the desktop (Windows 2000), then double-click the **FINEPIX** CD icon to open the FINEPIX CD window and double-click **SETUP** or **SETUP.exe**.

- 4** If prompted to install Windows Media Player or DirectX, follow the on-screen instructions to complete installation.
- 5** When prompted, remove the installer CD from the CD-ROM drive and click **Restart** to restart the computer. Store the installer CD in a dry location out of direct sunlight in case you need to re-install the software. The version number is printed at the top of the CD label for reference when updating the software or contacting customer support.

Installation is now complete. Proceed to “Connecting the Camera” on page 54.

Installing FinePixViewer: Macintosh

1 Confirm that the computer meets the following system requirements:

CPU	PowerPC or Intel
OS	Preinstalled versions of Mac OS X 10.3.9-10.5 (visit http://www.fujifilm.com/ for more information)
RAM	256 MB or more
Free disk space	A minimum of 200 MB required for installation with 400 MB available when FinePixViewer is running
Video	800×600 pixels or more with thousands of colors or better
Other	<ul style="list-style-type: none"> • Built-in USB port recommended. Operation is not guaranteed other USB ports. • Internet connection (56 kbps or faster recommended) required to use FinePix Internet Service; Internet connection and e-mail software required to use e-mail option

2 After starting the computer and quitting any applications that may be running, insert the installer CD in a CD-ROM drive. Double-click the **FinePix CD** icon on the desktop and double-click **Installer for Mac OS X**.

3 An installer dialog will be displayed; click **Installing FinePixViewer** to start installation. Enter an administrator name and password when prompted and click **OK**, then follow the on-screen instructions to install FinePixViewer. Click **Exit** to quit the installer when installation is complete.

- 4** Remove the installer CD from the CD-ROM drive. Note that you may be unable to remove the CD if Safari is running; if necessary, quit Safari before removing the CD. Store the installer CD in a dry location out of direct sunlight in case you need to re-install the software. The version number is printed at the top of the CD label for reference when updating the software or contacting customer support.
- 5** Select **Applications** in the Finder **Go** menu to open the applications folder. Double-click the **Image Capture** icon and select **Preferences...** from the Image Capture application menu.



The Image Capture preferences dialog will be displayed. Choose **Other...** in the **When a camera is connected, open** menu, then select **FPVBridge** in the “Applications/FinePixViewer” folder and click **Open**.



Select **Quit Image Capture** from the Image Capture application menu.

Installation is now complete. Proceed to “Connecting the Camera” on page 54.

Connecting the Camera

1 If the pictures you wish to copy are stored on a memory card, insert the card into the camera (pg. 8). If no card is inserted, pictures will be copied from internal memory.

⚠ Caution

Loss of power during transfer could result in loss of data or damage to internal memory or the memory card. Check the battery level.

2 Turn the camera off and connect the supplied USB cable as shown, making sure the connectors are fully inserted. Connect the camera directly to the computer; do not use a USB hub or keyboard.

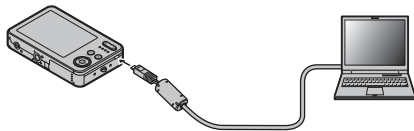

⚡ Note

The camera will not turn off automatically while connected to a computer.

3 Press the **▶** button for about a second to turn the camera on. FinePixViewer will start automatically and the “Save Image Wizard” will be displayed. Follow the on-screen instructions to copy pictures to the computer. To exit without copying pictures, click

CANCEL.

⚠ Caution

If FinePixViewer does not start automatically, the software may not be correctly installed. Disconnect the camera and reinstall the software.

For more information on using FinePixViewer, select **How to Use FinePixViewer** in the FinePixViewer **Help** menu.

 **Cautions**

- Use only memory cards that have been formatted in the camera and contain pictures taken with the camera. If a memory card containing a large number of images is inserted, there may be a delay before FinePixViewer starts and FinePixViewer may be unable to import or save images. Use a memory card reader to transfer pictures.
- Make sure the indicator lamp is out before turning the camera off, disconnecting the USB cable or pulling the memory card out. Failure to observe this precaution could result in loss of data or damage to internal memory or the memory card.
- Disconnect the camera before inserting or removing memory cards.
- In some cases, it may not be possible to access pictures saved to a network server using FinePixViewer in the same way as on a standalone computer.
- The user bears all applicable fees charged by the phone company or Internet service provider when using services that require an Internet connection.

 **Disconnecting the Camera**

After confirming that the indicator lamp is out, follow the on-screen instructions to turn the camera off and disconnect the USB cable.

 **Uninstalling FinePixViewer**

Only uninstall FinePixViewer before reinstalling the software or when it is no longer required. After quitting FinePixViewer and disconnecting the camera, drag the “FinePixViewer” folder from “Applications” into the Trash and select **Empty Trash** in the **Finder** menu (Macintosh), or open the control panel and use “Programs and Features” (Windows Vista) or “Add/Remove Programs” (other versions of Windows) to uninstall FinePixViewer. Under Windows, one or more confirmation dialogs may be displayed; read the contents carefully before clicking **OK**.

The Shooting Menu

The shooting menu is used to adjust settings for a wide range of shooting conditions.

Using the Shooting Menu

- 1 Press **MENU/OK** to display the shooting menu.

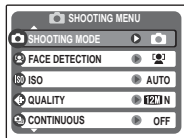

← Note

The options displayed in the shooting menu vary depending on the shooting mode.

- 2 Press the selector up or down to highlight the desired menu item.



- 3 Press the selector right to display options for the highlighted item.

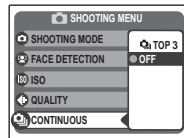



















- 4 Press the selector up or down to highlight the desired option.



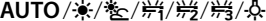

- 5 Press **MENU/OK** to select the highlighted option.



Shooting Menu Options

Menu item	Description	Options	Default	
 SHOOTING MODE	Choose a shooting mode according to the type of subject (pg. 28).			
 FACE DETECTION	Turn Intelligent Face Detection on or off (pg. 19).	 ON / OFF	 ON	
 ISO	Adjust ISO sensitivity (pg. 59). Choose higher values when the subject is poorly lit.	AUTO / 3200 / 1600 / 800 / 400 / 200 / 100	AUTO	
 QUALITY	Choose image size and quality (pg. 60).	FinePix J27 / FinePix J28 / FinePix J29		
		FinePix J30 / FinePix J32 / FinePix J37 / FinePix J38		
 EXP. COMPENSATION	Adjust exposure for bright, dark, or high-contrast scenes (pg. 61).	-2 EV to +2 EV in increments of 1/3 EV	±0	
 WHITE BALANCE	Adjust color for different light sources (pg. 62).	AUTO / 	AUTO	
 CONTINUOUS	Shoot a series of pictures (pg. 63).	 / OFF	OFF	
 SET-UP	Perform basic camera setup such as choosing a language and setting the time and date (pg. 72).		—	

ISO ISO

Control the camera's sensitivity to light with . Higher values can be used to reduce blur when lighting is poor; note, however, that mottling may appear in pictures taken at high sensitivities. If **AUTO** is selected, the camera will adjust sensitivity automatically in response to shooting conditions. Settings other than **AUTO** are shown by an icon in the monitor if you use .

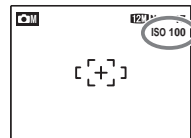

QUALITY

Choose the size and quality at which still pictures are recorded. Large pictures can be printed at large sizes with no drop in quality; small pictures require less memory, allowing more pictures to be recorded.

Option	Prints at sizes up to
12M F , 10M F , 12M N , 10M N	31 × 23 cm/12 × 9 in. (10M) or 31 × 21 cm/12 × 8 in. (11M 3:2 / 9M 3:2).
11M 3:2 , 9M 3:2	Choose 12M F / 10M F for high-quality prints, 11M 3:2 / 9M 3:2 for an aspect ratio of 3:2.
6M , 5M	22 × 16 cm (8.5 × 6.5 in.)
3M	17 × 13 cm (7 × 5 in.)
2M	14 × 10 cm (5.3 × 4 in.)
03M	5 × 4 cm (2 × 1.5 in.). Suited to e-mail or the web.

The number of pictures that can be taken at current settings (pg. 91) is displayed to the right of the image quality icon in the monitor. See the shooting menu for the options of image quality that the camera can record (see page 58).

Aspect Ratio

Pictures taken at an image quality setting of **11M 3:2**/**9M 3:2** have an aspect ratio of 3:2, the same as a frame of 35-mm film. Pictures taken at other settings have an aspect ratio of 4:3.



4:3



3:2

Note

Image quality is not reset when the camera is turned off or another shooting mode is selected.

EXP. COMPENSATION

Use exposure compensation when photographing very bright, very dark, or high-contrast subjects.

Choose positive (+) values to increase exposure



Choose negative (-) values to reduce exposure

Choosing an Exposure Compensation Value

- **Backlit subjects:** choose values from $+2/3$ EV to $+1 2/3$ EV (for an explanation of the term “EV”, see the Glossary on page 90)



- **Highly reflective subjects or very bright scenes (e.g., snowfields):** +1 EV









- **Scenes that are mostly sky:** +1 EV
- **Spotlit subjects** (particularly if photographed against dark backgrounds): $-2/3$ EV
- **Subjects with low reflectivity** (pine trees or dark-colored foliage): $-2/3$ EV

Note

At settings other than ± 0 , a  icon is displayed in the monitor. Exposure compensation is not reset when the camera is turned off; to restore normal exposure control, choose a value of ± 0 .

WB WHITE BALANCE

For natural colors, choose a setting that matches the light source (for an explanation of “white balance,” see the Glossary on page 90).

Option	Description
AUTO	White balance adjusted automatically.
	For subjects in direct sunlight.
	For subjects in the shade.
	Use under “daylight” fluorescent lights.
	Use under “warm white” fluorescent lights.
	Use under “cool white” fluorescent lights.
	Use under incandescent lighting.

If **AUTO** does not produce the desired results (for example, when taking close-ups), choose the option that matches the light source.

← Note

Results vary with shooting conditions. Play pictures back after shooting to check colors in the monitor.

☹ CONTINUOUS (Continuous shooting)

Select  **TOP 3** to capture motion in a series of pictures. The camera takes up to three pictures while the shutter-release button is pressed.

👉 Notes

- Frame rate varies with shutter speed.
- Focus and exposure are determined by the first frame in each series.
- The number of pictures that can be recorded depends on the memory available. Additional time may be required to record pictures when shooting ends. The pictures are displayed in the monitor while recording is in progress.



The Playback Menu

The playback menu is used to manage the pictures in internal memory or on the memory card.

Using the Playback Menu

1 Press  to enter playback mode (pg. 33).



2 Press **MENU/OK** to display the playback menu.

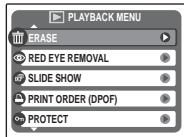

3 Press the selector up or down to highlight the desired menu item.



4 Press the selector right to display options for the highlighted item.

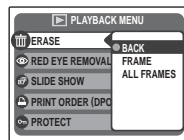

5 Press the selector up or down to highlight the desired option.











6 Press **MENU/OK** to select the highlighted option.



Playback Menu Options

The following options are available:

Option	Description
 ERASE	Delete all or selected pictures (pg. 37).
 RED EYE REMOVAL	Create copies with reduced red eye (pg. 65).
 SLIDE SHOW	View pictures in a slide show (pg. 66).
 PRINT ORDER (DPOF)	Select pictures for printing on DPOF- and PictBridge-compatible devices (pg. 44).
 PROTECT	Protect pictures from accidental deletion (pg. 67).
 COPY	Copy pictures between internal memory and a memory card (pg. 68).
 IMAGE ROTATE	Rotate pictures (pg. 70).
 TRIMMING	Create cropped copies of pictures (pg. 71).
 SET-UP	Perform basic camera setup (pg. 72).

👁️ RED EYE REMOVAL

This option is used with pictures taken using Intelligent Face Detection to create copies that have been processed to remove red eye.

- 1 Play the picture back in the monitor (pictures taken with Intelligent Face Detection are indicated by a 👤 icon) and select 👁️ **RED EYE REMOVAL** in the playback menu (pg. 63).



- 2 Press **MENU/OK**. The message shown below at left will be displayed while the camera analyses the image; if red-eye is detected, the message shown below at right will be displayed while the camera processes the image to create a copy with reduced red-eye.

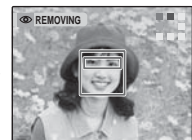
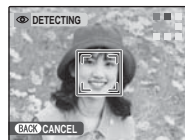

👉 Notes

- Red eye may not be removed if the camera is unable to detect a face or the face is in profile. Results may differ depending on the scene. Red eye can not be removed from pictures that have already been processed using red-eye removal or pictures created with other devices.
- The amount of time needed to process the image varies with the number of faces detected.
- Copies created with 👁️ **RED EYE REMOVAL** are indicated by a 👁️ icon during playback.

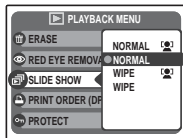

SLIDE SHOW

View pictures in an automated slide show. Choose the type of show and press **MENU/OK** to start. Press **DISP/BACK** at any time during the show to view on-screen help. When a movie is displayed, movie playback will begin automatically, and the slide show will continue when the movie ends. The show can be ended at any time by pressing **MENU/OK**.



Note

The camera will not turn off automatically while a slide show is in progress.

Option	Description
NORMAL	Press selector left or right to go back or skip ahead one frame. Select WIPE for wipe transitions between frames.
WIPE	
NORMAL 	As above, except that camera automatically zooms in on faces selected with Intelligent Face detection (pg. 19).
WIPE 	

PROTECT

Protect pictures from accidental deletion. The following options are available.

■ FRAME

Protect selected pictures.

- 1 Press the selector left or right to display the desired picture.

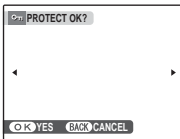

Picture not protected

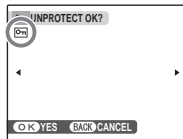

Protected picture

- 2 Press **MENU/OK** to protect the picture. If the picture is already protected, pressing **MENU/OK** will remove protection from the image.



- 3 Repeat steps 1–2 to protect additional images. Press **DISP/BACK** to exit when the operation is complete.



■ SET ALL

Press **MENU/OK** to protect all pictures, or press **DISP/BACK** to exit without changing picture status.

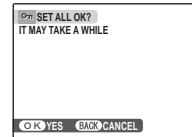

■ RESET ALL

Press **MENU/OK** to remove protection from all pictures, or press **DISP/BACK** to exit without changing picture status.

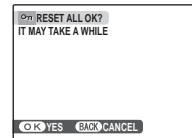

If the number of pictures affected is very large, the display at right will appear in the monitor while the operation is in progress.

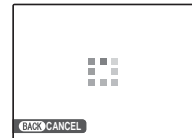

Press **DISP/BACK** to exit before the operation is complete.

Caution

Protected pictures will be deleted when the memory card or internal memory is formatted (pg. 76).

COPY

Copy pictures between internal memory and a memory card.

- 1 Press the selector up or down to highlight **INTERNAL MEMORY** → **SD CARD** (copy pictures from internal memory to the memory card) or **SD CARD** → **INTERNAL MEMORY** (copy pictures from a memory card to internal memory).



- 2 Press the selector right to display options for the highlighted item.

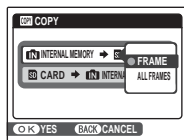

- 3 Press the selector up or down to highlight **FRAME** or **ALL FRAMES**.



- 4 Press **MENU/OK**.

**Tip: Copying Pictures Between Memory Cards**

To copy pictures between two memory cards, insert the source card and copy the pictures to internal memory, then remove the source card, insert the destination card, and copy the pictures from internal memory.

■ FRAME

Copy selected frames.

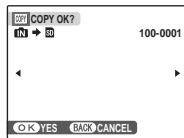

1 Press the selector left or right to display the desired picture.



2 Press **MENU/OK** to copy the picture.



3 Repeat steps 1–2 to copy additional images. Press **DISP/BACK** to exit when the operation is complete.



■ ALL FRAMES

Press **MENU/OK** to copy all pictures, or press **DISP/BACK** to exit without copying pictures.

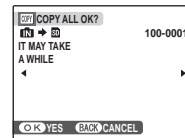

⚠ Cautions

- Copying ends when the destination is full.
- DPOF print information is not copied (pg. 46).

🔄 IMAGE ROTATE

By default, pictures taken in tall orientation are displayed in wide orientation. Use this option to display pictures in the correct orientation in the monitor. It has no effect on pictures displayed on a computer or other device.

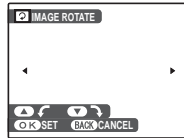

👉 Notes

- Protected pictures can not be rotated. Remove protection before rotating pictures (pg. 67).
- The camera may not be able to rotate pictures created with other devices.

To rotate a picture, play the picture back and select 🔄 **IMAGE ROTATE** in the playback menu (pg. 63).

- 1 Press the selector down to rotate the picture 90° clockwise, up to rotate the picture 90° counterclockwise.



- 2 Press **MENU/OK** to confirm the operation (to exit without rotating the picture, press **DISP/BACK**).



The next time the picture is played back, it will automatically be rotated.

TRIMMING

To create a cropped copy of a picture, play the picture back and select **TRIMMING** in the playback menu (pg. 63).

- 1 Press the zoom buttons to zoom in and out and use the selector to scroll the picture until the desired portion is displayed (to exit to single-frame playback without creating a cropped copy, press **DISP/BACK**).

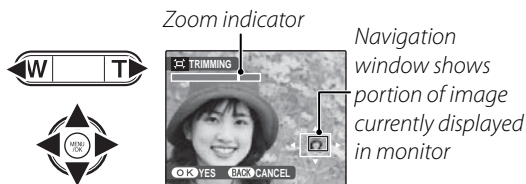

- 2 Press **MENU/OK**. A confirmation dialog will be displayed.

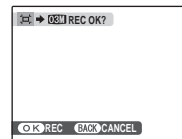

Copy size is shown at the top; if the size is **03M**, **OK** is displayed in yellow. Larger crops produce larger copies; all copies have an aspect ratio of 4:3.

- 3 Press **MENU/OK** to save the cropped copy to a separate file.



The Setup Menu

Using the Setup Menu

1 Display the setup menu.

1.1 Press **MENU/OK** to display the menu for the current mode.



1.2 Press the selector up or down to highlight **SET SET-UP**.



1.3 Press the selector right to display the setup menu.

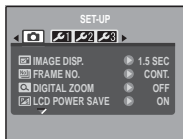

2 Choose a page.

2.1 Press the selector left or right to choose a page.



2.2 Press the selector down to enter the menu.



3 Adjust settings.

3.1 Press the selector up or down to highlight a menu item.



3.2 Press the selector right to display options for the highlighted item.

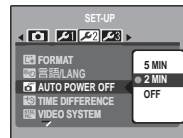

3.3 Press the selector up or down to highlight an option.



3.4 Press **MENU/OK** to select the highlighted option.



Setup Menu Options

	Menu item	Description	Options	Default
	IMAGE DISP.	Choose how long pictures are displayed after shooting (pg. 74).	3 SEC / 1.5 SEC / OFF	1.5 SEC
	FRAME NO.	Choose how files are named (pg. 74).	CONTINUOUS / RENEW	CONTINUOUS
	DIGITAL ZOOM	Enable or disable digital zoom (pg. 75).	ON / OFF	OFF
	LCD POWER SAVE	Enable or disable monitor power saving (pg. 75).	ON / OFF	ON
	DATE/TIME	Set the camera clock (pg. 13).	—	—
	OPERATION VOL.	Adjust the volume of camera controls.	(high) / (mid) / (low) / OFF (mute)	
	SHUTTER VOLUME	Adjust the volume of the shutter sound.		
	PLAYBACK VOLUME	Adjust the volume for movie playback (pg. 75).	—	7
	LCD BRIGHTNESS	Control the brightness of the monitor (pg. 75).	—	0
	FORMAT	Format internal memory or memory cards (pg. 76).	—	—
	言語 / LANG.	Choose a language (pg. 13).	See page 94	ENGLISH
	AUTO POWER OFF	Choose the auto power off delay (pg. 76).	5 MIN / 2 MIN / OFF	2 MIN
	TIME DIFFERENCE	Set the clock to local time (pg. 77).		
	VIDEO SYSTEM	Choose a video mode for connection to a TV (pg. 42).	NTSC / PAL	—
	RESET	Reset all settings except Frame number, DATE/TIME , TIME DIFFERENCE , and VIDEO SYSTEM to default values. A confirmation dialog will be displayed, press the selector left or right to highlight OK and press MENU/OK .	—	—

☑ IMAGE DISP.

Choose an option other than **OFF** to display pictures in the monitor after shooting. Pictures can be displayed for 1.5 seconds (**1.5 SEC**) or 3 seconds (**3 SEC**).

📄 FRAME NO.

New pictures are stored in image files named using a four-digit file number assigned by adding one to the last file number used. The file number is displayed during playback as shown at right. **FRAME NO.** controls whether file numbering is reset to 0001 when a new memory card is inserted or the current memory card or internal memory is formatted.

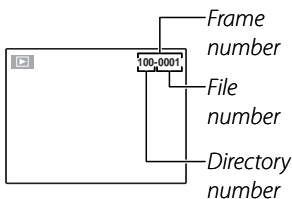

- **CONTINUOUS:** Numbering continues from the last file number used or the first available file number, whichever is higher. Choose this option to reduce the number of pictures with duplicate file names.

- **RENEW:** Numbering is reset to 0001 after formatting or when a new memory card is inserted.

👉 Notes

- If the frame number reaches 999-9999, the shutter release will be disabled (pg. 88).
- Selecting **⊞ RESET** (pg. 73) does not reset frame numbering.
- Frame numbers for pictures taken with other cameras may differ.

DIGITAL ZOOM

If **ON** is selected, pressing **T** at the maximum optical zoom position will trigger digital zoom, further magnifying the image. To cancel digital zoom, zoom out to the minimum digital zoom position and press **W**.

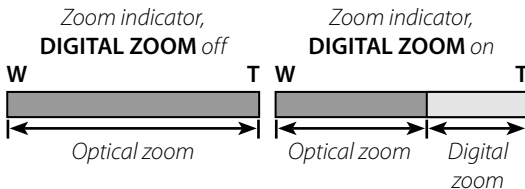
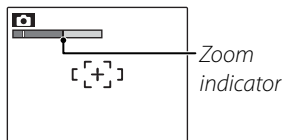

Caution

Digital zoom produces lower quality images than optical zoom.

LCD POWER SAVE

If **ON** is selected, the monitor will dim to save power if no operations are performed for several seconds. Full brightness can be restored by pressing the shutter button halfway. The monitor does not dim in movie mode or during playback.

PLAYBACK VOLUME

Press the selector up or down to choose volume for movie playback and press **MENU/OK** to select.

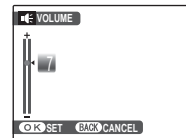

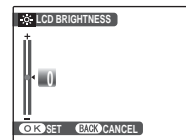

LCD BRIGHTNESS

Press the selector up or down to choose monitor brightness and press **MENU/OK** to select.



FORMAT

Format internal memory or a memory card. If a memory card is inserted in the camera,  will be displayed in the dialog shown at right and this option will format the memory card. If no memory card is inserted,  will be displayed and this option will format internal memory. Press the selector left to highlight **OK** and press **MENU/OK** to begin formatting.

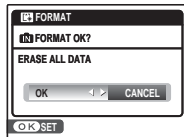

Cautions

- All data—including protected pictures—will be deleted. Be sure important files have been copied to a computer or other storage device.
- Do not open the battery cover during formatting.

AUTO POWER OFF

Choose the length of time before the camera turns off automatically when no operations are performed. Shorter times increase battery life; if **OFF** is selected, the camera must be turned off manually. Note that regardless of the option selected, the camera will not turn off automatically when connected to a printer (pg. 43) or computer (pg. 54) or when a slide show is in progress (pg. 66).

Tip: Reactivating the Camera

To reactivate the camera after it has turned off automatically, press the **ON/OFF** button or press the  button for about a second (pg. 12).

TIME DIFFERENCE

When traveling, use this option to switch the camera clock instantly from your home time zone to the local time at your destination.

1 Specify the difference between local time and your home time zone.

1.1 Press the selector up or down to highlight **← LOCAL**.



1.2 Press the selector right to display the time difference.

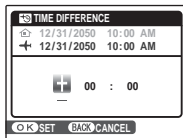

1.3 Press the selector left or right to highlight **+**, **-**, hours, or minutes; press up or down to edit. The minimum increment is 15 minutes.



1.4 Press **MENU/OK** when settings are complete.



2 Switch between local time and your home time zone.

To set the camera clock to local time, highlight **← LOCAL** and press **MENU/OK**.

To set the clock to the time in your home time zone, select **HOME**. If **← LOCAL** is selected, **←** will be displayed in the monitor for three seconds after the camera enters shooting mode, and the date will be displayed in yellow.

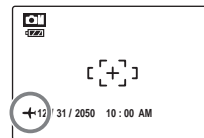

After changing time zones, check that the date and time are correct.

Optional Accessories

The camera supports a wide range of accessories from FUJIFILM and other manufacturers.

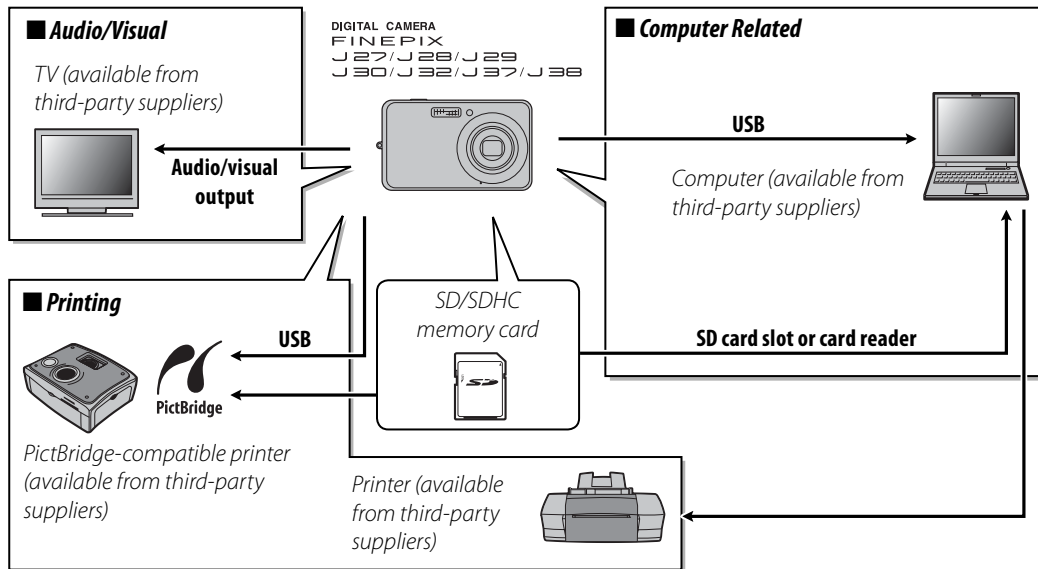

Accessories from Fujifilm

The following optional accessories were available from FUJIFILM. For the latest information on the accessories available in your region, check with your local Fujifilm representative or visit http://www.fujifilm.com/products/digital_cameras/index.html.

- **NP-45 rechargeable Li-ion battery:** Additional NP-45 slimline batteries can be purchased as required.
- **AV-C1 A/V cable:** Connects the camera and a TV.

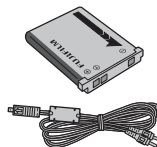

Troubleshooting

Power and Battery

	Problem	Possible cause	Solution	Page
Power supply	The camera does not turn on.	The battery is exhausted.	Charge the battery or insert a fully-charged spare battery.	4, 6
		The battery is not in the correct orientation.	Re-insert the battery in the correct orientation.	4
	The battery runs down quickly.	The battery is cold.	Warm the battery by placing it in a pocket or other warm place and re-insert it in the camera immediately before taking a picture.	—
		There is dirt on the battery terminals.	Clean the terminals with a soft, dry cloth.	—
		The camera is in  mode.	Choose a different shooting mode.	29
		The battery has been charged many times.	The battery has reached the end of its charging life. Purchase a new battery.	—
The camera turns off suddenly.	The battery is exhausted.	Charge the battery or insert a fully-charged spare battery.	4, 6	
Battery charger	Charging does not start.	The battery is not correctly inserted.	Re-insert the battery in the charger.	4
		The battery is not in the correct orientation.	Re-insert the battery in the correct orientation.	4
		There is dirt on the battery terminals.	Clean the terminals with a soft, dry cloth.	—
		The battery has been charged many times.	The battery has reached the end of its charging life. Purchase a new battery. If the battery still fails to charge, contact your FUJIFILM dealer.	—
	Charging is slow.	The temperature is low.	Charge the battery at room temperature.	7





Menus and Displays

Problem	Possible cause	Solution	Page
Menus and displays are not in English.	English is not selected for the  言語/LANG.	Select ENGLISH .	13

Shooting

Problem	Possible cause	Solution	Page
Taking pictures	Memory is full.	Insert a new memory card or delete pictures.	8, 37
	Memory is not formatted.	Format the memory card or internal memory.	76
	There is dirt on the memory card contacts.	Clean the contacts with a soft, dry cloth.	9
	The memory card is damaged.	Insert a new memory card.	8
	The battery is exhausted.	Charge the battery or insert a fully-charged spare battery.	4, 6
	The camera has turned off automatically.	Turn the camera on.	12, 76
The monitor goes dark after shooting.	The flash has fired.	The monitor may darken while the flash charges. Wait for the flash to charge.	24
Focus	The subject is close to the camera.	Select macro mode.	23
	The subject is far away from the camera.	Cancel macro mode.	
	The camera does not focus.	The subject is not suited to autofocus.	Use focus lock.



	Problem	Possible cause	Solution	Page
	Face detection not available.	The camera is in a shooting mode which makes Intelligent Face Detection unavailable.	Choose a different shooting mode.	28
Intelligent Face Detection	No face is detected.	The subject's face is obscured sunglasses, a hat, long hair, or other objects.	Remove the obstructions.	19
		The subject's face occupies only a small area of the frame.	Change the composition so that the subject's face occupies a larger area of the frame.	
		The subject's head is tilted or horizontal.	Ask the subject to hold their head straight.	
		The camera is tilted.	Hold the camera straight.	15
		The subject's face is poorly lit.	Shoot in bright light.	—
	Wrong subject selected.	The selected subject is closer to the center of the frame than the main subject.	Recompose the picture or turn face detection off and frame the picture using focus lock.	21
Close-ups	Macro mode is not available.	The camera is in a shooting mode which makes macro (close-up) mode unavailable.	Choose a different shooting mode.	28

	Problem	Possible cause	Solution	Page
Flash	The flash does not fire.	The flash is charging.	Wait for the flash to charge.	17
		The camera is in a shooting mode in which the flash does not fire.	Choose a different shooting mode.	28
		The battery is exhausted.	Charge the battery or insert a fully-charged spare battery.	4, 6
		The camera is in continuous mode.	Select OFF for  CONTINUOUS .	62
		The camera is in silent mode.	Turn silent mode off .	25
		The flash is off ().	Choose a different flash mode.	24
	Some flash modes are not available.	The camera is in a shooting mode which makes some flash modes unavailable.	Choose a different shooting mode.	28
		The camera is in silent mode.	Turn silent mode off .	25
	The flash does not fully light the subject.	The subject is not in range of the flash.	Position the subject in range of the flash.	94
		The flash window is obstructed.	Hold the camera correctly.	15
Problem images	Pictures are blurred.	The lens is dirty.	Clean the lens.	98
		The lens is blocked.	Keep objects away from the lens.	15
		 AF is displayed during shooting and the focus frame is displayed in red.	Check focus before shooting.	16, 21, 86
		 is displayed during shooting.	Use the flash or a tripod.	24
	Pictures are mottled.	The ambient temperature is high and the subject is poorly lit.	This is normal and does not indicate a malfunction. Choose a lower sensitivity.	58

Playback

	Problem	Possible cause	Solution	Page
Pictures	Pictures are grainy.	The pictures were taken with a different make or model of camera.	—	—
	Playback zoom unavailable.	The pictures were taken at an image size of 03M or with a different make or model of camera.	—	—
Audio	No sound in movie playback.	Playback volume is too low.	Adjust playback volume.	41, 75
		The microphone was obstructed.	Hold the camera correctly during recording.	39
		The speaker is obstructed.	Hold the camera correctly during playback.	41
Deletion	Selected pictures are not deleted.	Some of the pictures selected for deletion are protected.	Remove protection using the device with which it was originally applied.	67
Frame no.	File numbering is unexpectedly reset.	The battery-chamber cover was opened while the camera was on.	Turn the camera off before opening the battery-chamber cover to replace the battery or insert a memory card.	12, 74

Connections

	Problem	Possible cause	Solution	Page
TV	No picture or sound.	The camera is not properly connected.	Connect the camera correctly.	42
		The optional A/V cable was connected during movie playback.	Connect the camera once movie playback has ended.	41, 42
		Input on the television is set to "TV".	Set input to "VIDEO".	—
		The camera is not set to the correct video standard.	Match the camera  VIDEO SYSTEM setting to the TV.	42, 73
		The volume on the television is too low.	Adjust the volume.	—
	No color.	The camera is not set to the correct video standard.	Match the camera  VIDEO SYSTEM setting to the TV.	42, 73



	Problem	Possible cause	Solution	Page
Computer	The computer does not recognize the camera.	The camera is not properly connected.	Connect the camera correctly.	54
PictBridge	Pictures can not be printed.	The camera is not properly connected.	Connect the camera correctly.	43
		The printer is off.	Turn the printer on.	—
	Only one copy is printed. The date is not printed.	The printer is not PictBridge-compatible.	—	—



Miscellaneous











	Problem	Possible cause	Solution	Page
Nothing happens when the shutter button is pressed.		Temporary camera malfunction.	Remove and reinsert the battery.	4
		The battery is exhausted.	Charge the battery or insert a fully-charged spare battery.	4, 6
The camera does not function as expected.		Temporary camera malfunction.	Remove and reinsert the battery. If the problem persists, contact your FUJIFILM dealer.	4
No sound.		The camera is in silent mode.	Turn silent mode off.	25

Warning Messages and Displays

The following warnings are displayed in the monitor:

Warning	Description	Solution
 (red)	Low battery.	Charge the battery or insert a fully-charged spare battery.
 (blinks red)	Battery exhausted.	
	Slow shutter speed. Picture may be blurred.	Use the flash or mount the camera on a tripod.
!AF (displayed in red with red focus frame)	The camera can not focus.	<ul style="list-style-type: none">• Use focus lock to focus on another subject at the same distance, then recompose the picture (pg. 21).• If the subject is poorly lit, try focusing at a distance of about 2 m (6 ft. 7 in.).• Use macro mode to focus when taking close-ups.
!AE (blinks red)	The subject is too bright or too dark. The picture will be over- or under-exposed.	If the subject is dark, use the flash.
FOCUS ERROR	Camera malfunction.	Turn the camera off and then on again, taking care not to touch the lens. If the message persists, contact a FUJIFILM dealer.
ZOOM ERROR		
NO CARD	No memory card inserted when COPY is selected in the playback menu.	Insert a memory card.
CARD NOT INITIALIZED	The memory card or internal memory is not formatted.	Format the memory card or internal memory (pg. 76).
	The memory card contacts require cleaning.	Clean the contacts with a soft, dry cloth. If the message is repeated, format the memory card (pg. 76). If the message persists, replace the memory card.
	Camera malfunction.	Contact a FUJIFILM dealer.
PROTECTED CARD	The memory card is locked.	Unlock the memory card (pg. 8).
BUSY	The memory card is incorrectly formatted.	Use the camera to format the memory card (pg. 76).

Warning	Description	Solution
CARD ERROR	The memory card is not formatted for use in the camera.	Format the memory card (pg. 76).
	The memory card contacts require cleaning or the memory card is damaged.	Clean the contacts with a soft, dry cloth. If the message is repeated, format the memory card (pg. 76). If the message persists, replace the memory card.
	Camera malfunction.	Contact a FUJIFILM dealer.
 MEMORY FULL	The memory card or internal memory is full; pictures can not be recorded or copied.	Delete pictures or insert a memory card with more free space.
 MEMORY FULL		
INTERNAL MEMORY IS FULL INSERT A NEW CARD		
WRITE ERROR	Not enough memory remaining to record additional pictures.	Delete pictures or insert a memory card with more free space.
	The memory card or internal memory is not formatted.	Format the memory card or internal memory (pg. 76).
	Memory card error or connection error.	Re-insert the memory card or turn the camera off and then on again. If the message persists, contact a FUJIFILM dealer.
READ ERROR	The file is corrupt or was not created with the camera.	The file can not be played back.
	The memory card contacts require cleaning.	Clean the contacts with a soft, dry cloth. If the message is repeated, format the memory card (pg. 76). If the message persists, replace the memory card.
	Camera malfunction.	Contact a FUJIFILM dealer.

Warning	Description	Solution
FRAME NO. FULL	The camera has run out of frame numbers (current frame number is 999-9999).	Format the memory card and select RENEW for the  FRAME NO. option in the  SETUP menu. Take a picture to reset frame numbering to 100-0001, then return to the  FRAME NO. menu and select CONTINUOUS .
TOO MANY FRAMES	Date for which more than 4,999 pictures exist selected in sort-by-date view.	Choose a different date.
CAN NOT EXECUTE	Red-eye removal can not be applied to the selected picture or movie.	—
 CAN NOT EXECUTE		
PROTECTED FRAME	An attempt was made to delete or rotate a protected picture.	Remove protection before deleting or rotating pictures.
 NO IMAGE	The source device selected in the playback COPY menu contains no pictures.	Select a different source.
 NO IMAGE		
 CAN NOT TRIM	An attempt was made to crop a  picture.	These pictures can not be cropped.
CAN NOT TRIM	The picture selected for cropping is damaged or was not created with the camera.	
DPOF FILE ERROR	The DPOF print order on the current memory card contains more than 999 images.	Copy the pictures to internal memory and create a new print order.
CAN NOT SET DPOF	The picture can not be printed using DPOF.	—
 CAN NOT SET DPOF	Movies can not be printed using DPOF.	—
CAN NOT ROTATE	The picture can not be rotated.	—
 CAN NOT ROTATE	Movies can not be rotated.	—
PRESS AND HOLD THE DISP BUTTON TO DEACTIVATE SILENT MODE	An attempt was made to choose a flash mode or adjust the volume with the camera in silent mode.	Exit silent mode before choosing a flash mode or adjusting the volume.
COMMUNICATION ERROR	A connection error occurred while pictures were being printed or copied to a computer or other device.	Confirm that the device is turned on and that the USB cable is connected.

Warning	Description	Solution
PRINTER ERROR	Printer out of paper or ink, or other printer error.	Check printer (see printer manual for details). To resume printing, turn the printer off and then turn it back on.
PRINTER ERROR RESUME?		Check printer (see printer manual for details). If printing does not resume automatically, press MENU/OK to resume.
CAN NOT BE PRINTED	An attempt was made to print a movie, a picture not created with the camera, or a picture in a format not supported by the printer.	Movies and some pictures created with other devices can not be printed. If the picture was created with the camera, check the printer manual to confirm that the printer supports the JFIF-JPEG or Exif-JPEG format. If it does not, the pictures can not be printed.

Glossary

Digital zoom: Unlike optical zoom, digital zoom does not increase the amount of visible detail. Instead, details visible using optical zoom are simply enlarged, producing a slightly “grainy” image.

DPOF (Digital Print Order Format): A standard that allows pictures to be printed from “print orders” stored in internal memory or on a memory card. The information in the order includes the pictures to be printed and the number of copies of each picture.



EV (Exposure Value): The exposure value is determined by the sensitivity of the image sensor and the amount of light that enters the camera while the image sensor is exposed. Each time the amount of light doubles, EV increases by one; each time the amount of light is halved, EV decreases by one. The amount of light entering the camera can be controlled by adjusting aperture and shutter speed.

Exif Print: A standard that allows information stored with pictures to be used for optimal color reproduction during printing.

JPEG (Joint Photographic Experts Group): A compressed file format for color images. The higher the compression rate, the greater the loss of information and more noticeable drop in quality when the picture is displayed.

Motion JPEG: An AVI (Audio Video Interleave) format that stores images and sound in a single file, with the images recorded in JPEG format. Motion JPEG files can be played in QuickTime 3.0 or later.

Smear: A phenomenon specific to CCDs which causes white streaks to appear when very bright light sources, such as the sun or reflected sunlight, appear in the frame.

WAV (Waveform Audio Format): A standard Windows audio file format. WAV files have the extension “*.WAV” and may be compressed or uncompressed. The camera uses uncompressed WAV. WAV files can be played using Windows Media Player or QuickTime 3.0 or later.

White balance: The human brain automatically adapts to changes in the color of light, with the result that objects that appear white under one light source still appear white when the color of the light source changes. Digital cameras can mimic this adjustment by processing images according to the color of the light source. This process is known as “white balance.”

Internal Memory/Memory Card Capacity

The following table shows the recording time or number of pictures available at different image qualities. All figures are approximate; file size varies with the scene recorded, producing wide variations in the number of files that can be stored. The number of exposures or length remaining may not diminish at an even rate.

■ *FinePix J27 / FinePix J28 / FinePix J29*

	10M F	10M N	9M 3:2	5M	3M	2M	03M	640	320	
Image size (pixels)	3664 × 2748		3664 × 2442	2592 × 1944	2048 × 1536	1600 × 1200	640 × 480	640 × 480	320 × 240	
File size	4.9 MB	2.5 MB	2.2 MB	1.3 MB	970 KB	720 KB	190 KB	—	—	
Internal memory (approx. 10 MB)	1	3	4	7	10	14	53	7 s	16 s	
SD card	512 MB	95	190	210	370	510	690	2540	6 min.	12 min.
	1 GB	180	360	410	710	970	1310	4850	12 min.	28 min.
	2 GB	370	730	820	1430	1950	2630	9710	25 min.	57 min.
SDHC card	4 GB	750	1470	1650	2860	3900	5270	19430	50 min.*	116 min.*
	8 GB	1510	2950	3300	5720	7800	10550	38860	100 min.*	229 min.*
	16 GB	3020	5910	6620	11450	15600	21110	77730	204 min.*	467 min.*
	32 GB	6050	11830	13240	22910	31210	42220	99990	406 min.*	927 min.*

* Total length of all movie files. Individual movies can not exceed 2GB in size.

■ FinePix J30 / FinePix J32 / FinePix J37 / FinePix J38

	12M F	12M N	11M 3:2	6M	3M	2M	0.3M	640	320	
Image size (pixels)	4000×3000		4000×2666	2816×2112	2048×1536	1600×1200	640×480	640×480	320×240	
File size	5.8 MB	2.9 MB	2.6 MB	1.5 MB	970 KB	720 KB	190 KB	—	—	
Internal memory (approx. 10 MB)	1	3	3	6	10	14	53	7 s	16 s	
SD card	512 MB	85	160	180	320	510	690	2540	6 min.	12 min.
	1 GB	160	310	350	610	970	1310	4850	12 min.	28 min.
	2 GB	320	630	710	1230	1950	2630	9710	25 min.	57 min.
SDHC card	4 GB	650	1270	1430	2470	3900	5270	19430	50 min.*	116 min.*
	8 GB	1300	2550	2860	4950	7800	10550	38860	100 min.*	229 min.*
	16 GB	2610	5110	5730	9900	15600	21110	77730	204 min.*	467 min.*
	32 GB	5220	10230	11470	19810	31210	42220	99990	406 min.*	927 min.*

* Total length of all movie files. Individual movies can not exceed 2 GB in size.

Specifications

System	
Model	FinePix J27 / FinePix J28 / FinePix J29
Effective pixels	10.2 million
CCD	½.3-in., square-pixel CCD with primary color filter
Storage media	• Internal memory (approx. 10 MB) • SD/SDHC memory cards (see page 8)
File system	Compliant with Design Rule for Camera File System (DCF), Exif 2.2, and Digital Print Order Format (DPOF)
File format	• Still pictures: Exif 2.2 JPEG (compressed) • Movies: Motion JPEG AVI
Image size (pixels)	<ul style="list-style-type: none"> <li style="width: 50%;">• 10M F: 3,664 × 2,748 <li style="width: 50%;">• 10M N: 3,664 × 2,748 <li style="width: 50%;">• 12M F: 4,000 × 3,000 <li style="width: 50%;">• 12M N: 4,000 × 3,000 <li style="width: 50%;">• 9M 3:2: 3,664 × 2,442 <li style="width: 50%;">• 5M: 2,592 × 1,944 <li style="width: 50%;">• 11M 3:2: 4,000 × 2,666 <li style="width: 50%;">• 6M: 2,816 × 2,112 <li style="width: 50%;">• 3M: 2,048 × 1,536 <li style="width: 50%;">• 2M: 1,600 × 1,200 <li style="width: 50%;">• 3M: 2,048 × 1,536 <li style="width: 50%;">• 2M: 1,600 × 1,200 <li style="width: 50%;">• 03M: 640 × 480 <li style="width: 50%;">• 03M: 640 × 480
File size	See page 91
Lens	Fujinon 3 × optical zoom lens, F2.9 (wide angle) – F5.2 (telephoto)
Focal length	f=5.7 mm–17.1 mm (35-mm format equivalent: 32 mm–96 mm)
Digital zoom	Approx. 5.7 × (up to 17.1 × when combined with optical zoom)
Aperture	Two steps
Focus range (distance from front of lens)	Approx. 60 cm (2.0 ft.)–infinity (wide angle); 60 cm (2.0 ft.)–infinity (telephoto) Macro mode: approx. 10 cm–70 cm/3.9 in.–2.3 ft. (wide angle); 35 cm–70 cm/1.1 ft.–2.3 ft. (telephoto)
Sensitivity	Equivalent to ISO 100, 200, 400, 800, 1600, 3200*; AUTO (Standard Output Sensitivity) * max. number of recorded pixels: 3M
Metering	256-segment through-the-lens (TTL) metering
Exposure control	Programmed autoexposure
Exposure compensation	–2 EV – +2 EV in increments of ½ EV (CAM mode)
Scene modes	☺ (BABY MODE), 👤 (PORTRAIT), ▲ (LANDSCAPE), 🖼️ (PANORAMA), 🏃 (SPORT), 🌃 (NIGHT), 🌃 (NIGHT (TRIPOD)), 🌞 (NATURAL LIGHT), 🏖️ (BEACH), ❄️ (SNOW), 🎆 (FIREWORKS), 🌅 (SUNSET), 🌸 (FLOWER), 🍷 (PARTY), 📄 (TEXT)
Image Stabilization	Available
Intelligent Face Detection	Available

System	
Shutter speed	1/4 s–1/1,400 s (AUTO mode); 8 s–1/1,400 s (other modes); combined mechanical and electronic shutter
Continuous	Up to three frames at a maximum of approximately 1 fps
Focus	<ul style="list-style-type: none"> • Mode: Single AF • Autofocus system: Contrast-detect TTL AF • Focus-area selection: AF CENTER
White balance	Automatic scene detection; six manual preset modes for direct sunlight, shade, daylight fluorescent, warm white fluorescent, cool white fluorescent, and incandescent lighting
Self-timer	Approx. 2 s and approx. 10 s
Flash	Flash type: Auto flash Effective range: (60): AUTO Wide-angle: approx. 60 cm - 3.5 m (2.0 ft. - 11.5 ft.) Telephoto: approx. 60 cm - 2.0 m (2.0 ft. - 6.6 ft.) Macro: approx. 30 cm - 80 cm (11.8 in. - 2.6 ft.)
Flash modes	Auto, red eye reduction, fill flash, off, slow sync, slow sync with red-eye reduction
Monitor	2.7-in., 230k-dot color LCD monitor; frame coverage approx. 96% (FinePix J37) 3.0-in., 230k-dot color LCD monitor; frame coverage approx. 96%
Movies	Camera can record movies with monaural sound and a frame size of 640×480 (640) or 320×240 (320) at a frame rate of 30 fps
Shooting options	Scene recognition, Intelligent Face Detection, best framing, and frame number memory
Playback options	Intelligent Face Detection, red-eye removal, micro thumbnail, multi-frame playback, sort-by-date, cropping (still pictures only), slide show, and image rotation
Other options	PictBridge, Exif Print, language selection (Japanese / English / French / German / Spanish / Italian / Simplified Chinese / Korean / Dutch / Portuguese / Russian / Thai / Turkish / Traditional Chinese / Czech / Hungarian / Polish / Swedish / Slovak / Danish / Norwegian / Finnish / Arabic), time difference

Input/output terminals

A/V OUT (audio/video output)	NTSC or PAL with monaural sound
Digital input/output	USB 2.0 Full Speed with MTP/PTP connection

Power supply/other

Power sources	NP-45A rechargeable battery
----------------------	-----------------------------

Guide to the number of available frames for battery operation

Battery Type	Number of frames
NP-45A	Approx. 165 frames

According to the CIPA (Camera & Imaging Products Association) standard procedure for measuring digital still camera battery consumption (extract):

When using a battery, use the battery supplied with the camera. The storage media should be SD memory card.

Note that the number of shots that can be taken with a fully-charged battery varies with temperature and shooting conditions.

Charging time	Approx. 155 minutes
----------------------	---------------------

Camera dimensions	92.0 mm x 55.9 mm x 20.0 mm/3.6 in. x 2.2 in. x 0.8 in. (W x H x D), excluding projections
--------------------------	--

Camera weight	Approx. 113 g/4.0 oz., excluding battery, accessories, and memory cards
----------------------	---

Shooting weight	Approx. 130 g/4.6 oz., including battery and memory card
------------------------	--

Operating conditions	<ul style="list-style-type: none"> • Temperature: 0°C – +40°C/+32°F – +104°F • Humidity: 85% or less (no condensation)
-----------------------------	--

NP-45A rechargeable battery

Nominal voltage	DC 3.7V
Nominal capacity	720mAh
Operating temperature	0°C – +40°C/+32°F – +104°F
Dimensions (W × H × D)	31 mm × 39.4 mm × 5.7 mm/1.2 in. × 1.6 in. × 0.2 in.
Weight	Approx. 15 g/0.5 oz.

AC power adapter AC-5VA

Rated input	100 – 240V AC, 50/60Hz
Input capacity	10 VA (100V)/20 VA (240V)
Rated output	5.0V DC, 1 A
Dimensions (W × H × D)	25 mm × 49 mm × 40.8 mm/1.0 in. × 1.9 in. × 1.6 in.
Weight	Approx. 58 g/2 oz.
Operating temperature	0°C – +40°C/+32°F – +104°F

The weight and dimensions vary with the country or region of sale.

Color Television Systems

NTSC (National Television System Committee) is a color television telecasting specification adopted mainly in the U.S.A., Canada, and Japan. PAL (Phase Alternation by Line) is a color television system adopted mainly in European countries and China.

Notices

- Specifications subject to change without notice. FUJIFILM shall not be held liable for damages resulting from errors in this manual.
- Although the monitor is manufactured using advanced high-precision technology, small bright points and anomalous colors (particularly in the vicinity of text) may appear. This is normal for this type of monitor and does not indicate a malfunction; images recorded with the camera are unaffected.
- Digital cameras may malfunction when exposed to strong radio interference (e.g., electric fields, static electricity, or line noise).
- Due to the type of lens used, some distortion may occur at the periphery of images. This is normal.

Caring for the Camera

To ensure continued enjoyment of the product, observe the following precautions.

Storage and Use

If the camera will not be used for an extended period, remove the battery and memory card. Do not store or use the camera in locations that are:

- exposed to rain, steam, or smoke
- very humid or extremely dusty
- exposed to direct sunlight or very high temperatures, such as in a closed vehicle on a sunny day
- extremely cold
- subject to strong vibration
- exposed to strong magnetic fields, such as near a broadcasting antenna, power line, radar emitter, motor, transformer, or magnet
- in contact with volatile chemicals such as pesticides
- next to rubber or vinyl products

Water and Sand

Exposure to water and sand can also damage the camera and its internal circuitry and mechanisms. When using the camera at the beach or seaside, avoid exposing the camera to water or sand. Do not place the camera on a wet surface.

Condensation

Sudden increases in temperature, such as occur when entering a heated building on a cold day, can cause condensation inside the camera. If this occurs, turn the camera off and wait an hour before turning it on again. If condensation forms on the memory card, remove the card and wait for the condensation to dissipate.

Cleaning

Use a blower to remove dust from the lens and monitor, then gently wipe with a soft, dry cloth. Any remaining stains can be removed by wiping gently with a piece of FUJIFILM lens-cleaning paper to which a small amount of lens-cleaning fluid has been applied. Care should be taken to avoid scratching the lens or monitor. The camera body can be cleaned with a soft, dry cloth. Do not use alcohol, thinner, or other volatile chemicals.

Traveling

Keep the camera in your carry-on baggage. Checked baggage may suffer violent shocks that could damage the camera.

FUJIFILM

FUJIFILM Corporation

7-3, AKASAKA 9-CHOME, MINATO-KU, TOKYO 107-0052, JAPAN

http://www.fujifilm.com/products/digital_cameras/index.html