

DIGITAL CAMERA

FINEPIX S1500

Owner's Manual

Thank you for your purchase of this product. This manual describes how to use your FUJIFILM FinePix S1500 digital camera and the supplied software. Be sure that you have read and understood its contents before using the camera.

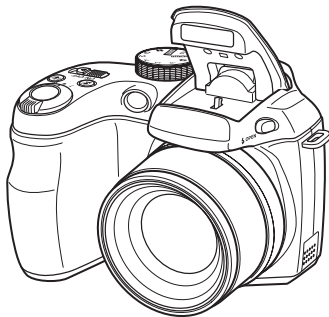

For information on related products, visit our website at <http://www.fujifilm.com/products/index.html>

Before You Begin

First Steps

Basic Photography and Playback

More on Photography

More on Playback

Movies

Connections

Menus

Technical Notes

Troubleshooting

Appendix



IMPORTANT SAFETY INSTRUCTIONS

- **Read Instructions:** All the safety and operating instructions should be read before the appliance is operated.
- **Retain Instructions:** The safety and operating instructions should be retained for future reference.
- **Heed Warnings:** All warnings on the appliance and in the operating instructions should be adhered to.
- **Follow Instructions:** All operating and use instructions should be followed.

Installation

Power Sources: This video product should be operated only from the type of power source indicated on the marking label. If you are not sure of the type of power supply to your home, consult your appliance dealer or local power company. For video products intended to operate from battery power, or other sources, refer to the operating instructions.

Grounding or Polarization: This video product is equipped with a polarized alternating-current line plug (a plug having one blade wider than the other). This plug will fit into the power outlet only one way. This is a safety feature. If you are unable to insert the plug fully into the outlet, try reversing the plug. If the plug should still fail to fit, contact your electrician to replace your obsolete outlet. Do not defeat the safety purpose of the polarized plug.

Alternate Warnings: This video product is equipped with a three-wire grounding-type plug, a plug having a third (grounding) pin. This plug will only fit into a grounding-type power outlet. This is a safety feature. If you are unable to insert the plug into the outlet, contact your electrician to replace your obsolete outlet. Do not defeat the safety purpose of the grounding type plug.

Overloading: Do not overload wall outlets and extension cords as this can result in a risk of fire or electric shock.

Ventilation: Slots and openings in the cabinet are provided for ventilation, to ensure reliable operation of the video product and to protect it from overheating, and these openings must not be blocked or covered. The openings should never be blocked by placing the video product on a bed, sofa, rug, or other similar surface.

This video product should not be placed in a built-in installation such as a bookcase or rack unless proper ventilation is provided or the manufacturer's instructions have been adhered to. This video product should never be placed near or over a radiator or heat register.

Attachments: Do not use attachments not recommended by the video product manufacturer as they may cause hazards.

Water and Moisture: Do not use this video product near water—for example, near a bath tub, wash bowl, kitchen sink, or laundry tub, in a wet basement, or near a swimming pool, and the like.

Power-Cord Protection: Power-supply cords should be routed so that they are not likely to be walked on or pinched by items placed upon or against them, paying particular attention to cords at plugs, convenience receptacles, and the point where they exit from the appliance.

Accessories: Do not place this video product on an unstable cart, stand, tripod, bracket, or table. The video product may fall, causing serious injury to a child or adult, and serious damage to the appliance. Use only with a cart, stand, tripod, bracket, or table recommended by the manufacturer, or sold with the video product. Any mounting of the appliance should follow the manufacturer's instructions, and should use a mounting accessory recommended by the manufacturer.

An appliance and cart combination should be moved with care. Quick stops, excessive force, and uneven surfaces may cause the appliance and cart combination to overturn.

Antennas

Outdoor Antenna Grounding: If an outside antenna or cable system is connected to the video product, be sure the antenna or cable system is grounded so as to provide some protection against voltage surges and built-up static charges. Section 810 of the National Electrical Code, ANSI/NFPA No. 70, provides information with respect to proper grounding of the mast and supporting structure, grounding of the lead-in wire to an antenna discharge unit, size of grounding conductors, location of antenna discharge unit, connection to grounding electrodes, and requirements for the grounding electrode.

EXAMPLE OF ANTENNA GROUNDING AS PER NATIONAL ELECTRICAL CODE

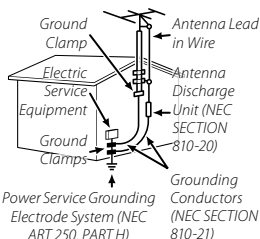

Power Lines: An outside antenna system should not be located in the vicinity of overhead power lines or other electric light or power circuits,

or where it can fall into such power lines or circuits. When installing an outside antenna system, extreme care should be taken to keep from touching such power lines or circuits as contact with them might be fatal.

Use

Cleaning: Unplug this video product from the wall outlet before cleaning. Do not use liquid cleaners or aerosol cleaners. Use a damp cloth for cleaning.

Object and Liquid Entry: Never push objects of any kind into this video product through openings as they may touch dangerous voltage points or short out parts that could result in a fire or electric shock. Never spill liquid of any kind on the video product.

Lightning: For added protection for this video product receiver during a lightning storm, or when it is left unattended and unused for long periods of time, unplug it from the wall outlet and disconnect the antenna or cable system. This will prevent damage to the video product due to lightning and power-line surges.

Service

Servicing: Do not attempt to service this video product yourself as opening or removing covers may expose you to dangerous voltage or other hazards. Refer all servicing to qualified service personnel.

Damage Requiring Service: Unplug this video product from the wall outlet

and refer servicing to qualified service personnel under the following conditions:

- When the power-supply cord or plug is damaged.
- If liquid has been spilled, or objects have fallen into the video product.
- If the video product has been exposed to rain or water.
- If the video product has been dropped or the cabinet has been damaged.

If the video product does not operate normally follow the operating instructions. Adjust only those controls that are covered by the operating instructions as an improper adjustment of other controls may result in damage and will often require extensive work by a qualified technician to restore the video product to its normal operation.

When the video product exhibits a distinct change in performance—this indicates a need for service.

Replacement Parts: When replacement parts are required, be sure the service technician has used replacement parts specified by the manufacturer or have the same characteristics as the original part. Unauthorized substitutions may result in fire, electric shock or other hazards.

Safety Check: Upon completion of any service or repairs to this video product, ask the service technician to perform safety checks to determine that the video product is in proper operating condition.



Be sure to read these notes before use

Safety Notes



- Make sure that you use your camera correctly. Read these safety notes and your *Owner's Manual* carefully before use.
- After reading these safety notes, store them in a safe place.

About the Icons



The icons shown below are used in this document to indicate the severity of the injury or damage that can result if the information indicated by the icon is ignored and the product is used incorrectly as a result.













	WARNING	This icon indicates that death or serious injury can result if the information is ignored.
	CAUTION	This icon indicates that personal injury or material damage can result if the information is ignored.

The icons shown below are used to indicate the nature of the instructions which are to be observed.

	Triangular icons tell you that this information requires attention ("Important").
	Circular icons with a diagonal bar tell you that the action indicated is prohibited ("Prohibited").
	Filled circles with an exclamation mark indicate an action that must be performed ("Required").

WARNING

	If a problem arises, turn the camera off, remove the batteries, and disconnect and unplug the AC power adapter. Continued use of the camera when it is emitting smoke, is emitting any unusual odor, or is in any other abnormal state can cause a fire or electric shock. Contact your FUJIFILM dealer.
	Do not allow water or foreign objects to enter the camera. If water or foreign objects get inside the camera, turn the camera off, remove the batteries, and disconnect and unplug the AC power adapter. Continued use of the camera can cause a fire or electric shock. Contact your FUJIFILM dealer.

 WARNING	
	Do not use the camera in the bathroom or shower. This can cause a fire or electric shock.
	Never attempt to change or take apart the camera. (Never open the casing.) Do not use the camera when it has been dropped or the casing is damaged. This can cause a fire or electric shock. Contact your FUJIFILM dealer.
	Do not change, heat or unduly twist or pull the connection cord and do not place heavy objects on the connection cord. These actions could damage the cord and cause a fire or electric shock. If the cord is damaged, contact your FUJIFILM dealer.
	Do not place the camera on an unstable surface. This can cause the camera to fall or tip over and cause injury.
	Never attempt to take pictures while in motion. Do not use the camera while you are walking or driving a vehicle. This can result in you falling down or being involved in a traffic accident.
	Do not touch any metal parts of the camera during a thunderstorm. This can cause an electric shock due to induced current from the lightning discharge.
	Do not use the batteries except as specified. Load the batteries as shown by the indicator.
	Do not heat, change or take apart the batteries. Do not drop or subject the batteries to impacts. Do not store the batteries with metallic products. Any of these actions can cause the batteries to burst or leak and cause fire or injury as a result.
	Use only the batteries or AC power adapters specified for use with this camera. Do not use voltages other than the power supply voltage shown. The use of other power sources can cause a fire.
	If the batteries leak and fluid gets in contact with your eyes, skin or clothing, flush the affected area with clean water and seek medical attention or call an emergency number right away.
	When carrying the batteries, install them in a digital camera or keep them in the hard case. When storing the batteries, keep them in the hard case. When discarding, cover the battery terminals with insulation tape. Contact with other metallic objects or batteries could cause the batteries to ignite or burst.
	Keep memory cards out of the reach of small children. Because memory cards are small, they can be swallowed by children. Be sure to store memory cards out of the reach of small children. If a child swallows a memory card, seek medical attention or call an emergency number.

 CAUTION	
	Do not use this camera in locations affected by oil fumes, steam, humidity or dust. This can cause a fire or electric shock.
	Do not leave this camera in places subject to extremely high temperatures. Do not leave the camera in locations such as a sealed vehicle or in direct sunlight. This can cause a fire.
	Keep out of the reach of small children. This product could cause injury in the hands of a child.
	Do not place heavy objects on the camera. This can cause the heavy object to tip over or fall and cause injury.
	Do not move the camera while the AC power adapter is still connected. Do not pull on the connection cord to disconnect the AC power adapter. This can damage the power cord or cables and cause a fire or electric shock.
	Do not cover or wrap the camera or the AC power adapter in a cloth or blanket. This can cause heat to build up and distort the casing or cause a fire.
	When you are cleaning the camera or you do not plan to use the camera for an extended period, remove the batteries and disconnect and unplug the AC power adapter. Failure to do so can cause a fire or electric shock.
	When charging ends, unplug the charger from the power socket. Leaving the charger plugged into the power socket can cause a fire.
	Using a flash too close to a person's eyes may temporarily affect the eyesight. Take particular care when photographing infants and young children.
	When a memory card is removed, the card could come out of the slot too quickly. Use your finger to hold it and gently release the card.
	Request regular internal testing and cleaning for your camera. Build-up of dust in your camera can cause a fire or electric shock. Contact your FUJIFILM dealer to request internal cleaning every two years. Please note that this service is not free of charge.
Using Batteries	

The following describes the proper use of batteries and how to prolong their life. Incorrect use can shorten battery life or cause leakage, overheating, fire, or explosion.

Compatible Batteries

The camera takes AA alkaline, rechargeable Ni-MH (nickel-metal hydride), or UL-certified lithium batteries. Do not use manganese, nickel-cadmium (Ni-Cd), or non-UL certified lithium batteries, as the heat generated by these batteries could damage the camera or cause malfunction.

Battery capacity varies with make and storage conditions. Some commercially-available batteries may have less capacity than the batteries provided with the camera.

Cautions: Handling Batteries

- Do not use batteries that are leaking, deformed, or discolored. **Warning:** If the batteries leak, clean the battery compartment thoroughly before inserting new batteries. If fluid from the battery comes into contact with skin or clothing, flush the affected area with water. **If fluid enters your eyes, immediately flush the affected area with water and seek medical attention. Do not rub your eyes. Failure to observe this precaution could result in loss of eyesight.**
- Do not transport or store with metal objects such as necklaces or hairpins.
- Do not disassemble or modify the batteries or battery casing.
- Do not expose to strong physical shocks.
- Do not expose to water, flame, or heat, or store in warm or humid conditions.
- Keep out of reach of infants and small children.
- Insert in the correct orientation.
- Do not mix old and new batteries, batteries with different charge levels, or batteries of different types.
- If the camera will not be used for an extended period, remove the batteries. Note that the camera clock will be reset (pg. 14).
- The batteries may be warm to the touch immediately after use. Turn

the camera off and allow the batteries to cool before handling.

- Battery capacity tends to decrease at low temperatures. Keep spare batteries in a pocket or other warm place and exchange as necessary. Cold batteries may recover some of their charge when warmed.
- Fingerprints and other foreign matter on the battery terminals can reduce battery performance. Thoroughly clean the terminals with a soft, dry cloth before inserting the batteries in the camera.

Ni-MH Batteries

The capacity of Ni-MH batteries may be temporarily reduced when new, after long periods of disuse, or if they are repeatedly recharged before being fully discharged. This is normal and does not indicate a malfunction. Capacity can be increased by repeatedly discharging the batteries using the  **DISCHARGE** option in the camera setup menu (pg. 94) and recharging them using a battery charger (sold separately). Do not use this option with alkaline batteries.

The camera draws a small amount of current even when off. Ni-MH batteries that have been left in the camera for an extended period may be drawn down to the point that they no longer hold a charge. Battery performance may also drop if the batteries are run down in a device such as a flashlight. Use the  **DISCHARGE** option in the camera setup menu to discharge Ni-MH batteries. Batteries that no longer

hold a charge even after repeatedly being discharged and recharged have reached the end of their service life and must be replaced.

Ni-MH batteries can be recharged in a battery charger (sold separately). Batteries may become warm to the touch after charging. Refer to the instructions provided with the charger for more information. Use the charger with compatible batteries only.

Ni-MH batteries gradually lose their charge when not in use.

Disposal

Dispose of used batteries in accord with local regulations.

AC Adapters (Available Separately)

Use only FUJIFILM AC adapters designated for use with this camera. Other adapters could damage the camera.

- The AC adapter is for indoor use only.
- Be sure the DC plug is securely connected to the camera.
- Turn the camera off before disconnecting the adapter. Disconnect the adapter by the plug, not the cable.
- Do not use with other devices.
- Do not disassemble.
- Do not expose to high heat and humidity.
- Do not subject to strong physical shocks.
- The AC adapter may hum or become hot to the touch during use. This is normal.
- If the AC adapter causes radio interference, reorient or relocate the receiving antenna.

Using the Camera

To ensure that images are recorded correctly, do not subject the camera to impact or physical shocks while images are being recorded.

Electrical Interference

This camera may interfere with hospital or aviation equipment. Consult with hospital or airline staff before using the camera in a hospital or on an aircraft.

Liquid Crystal

In the event that the monitor or electronic viewfinder is damaged, care should be taken to avoid contact with liquid crystal. Take the urgent action indicated should any of the following situations arise:

- If liquid crystal comes in contact with your skin,** clean the area with a cloth and then wash thoroughly with soap and running water.
- If liquid crystal enters your eyes,** flush the affected eye with clean water for at least 15 minutes and then seek medical assistance.
- If liquid crystal is swallowed,** rinse your mouth thoroughly with water. Drink large quantities of water and induce vomiting, then seek medical assistance.

Take Test Shots

Before taking photographs on important occasions (such as at weddings or before taking the camera on a trip), take a test shot and view the result to ensure that the camera is functioning normally. FUJIFILM Corporation can not accept liability for damages or lost profits incurred as a result of product malfunction.

NOTICES

To prevent fire or shock hazard, do not expose the unit to rain or moisture.

Please read the "Safety Notes" (pages iii–v) and make sure you understand them before using the camera.

Perchlorate Material—special handling may apply. See <http://www.dts.ca.gov/hazardouswaste/perchlorate>.

For Customers in the U.S.A.

Tested To Comply With FCC Standards
FOR HOME OR OFFICE USE

FCC Statement

This device complies with Part 15 of the FCC Rules. Operation is subject to the following two conditions: (1) This device may not cause harmful interference, and (2) this device must accept any interference received, including interference that may cause undesired operation.

CAUTION

This equipment has been tested and found to comply with the limits for a Class B digital device, pursuant to Part 15 of the FCC Rules. These limits are designed to provide reasonable protection against harmful interference in a residential installation. This equipment generates, uses, and can radiate radio frequency energy and, if not installed and used in accordance with the instructions, may cause harmful interference to radio communications. However, there is no guarantee that interference will not occur in a particular installation. If this equipment does cause harmful interference to radio or television reception, which can be determined by turning the equipment off and on, the user is encouraged to try to correct the interference by one or more of the following measures:

- Reorient or relocate the receiving antenna.
- Increase the separation between the equipment and receiver.
- Connect the equipment into an outlet on a circuit different from that to which the receiver is connected.
- Consult the dealer or an experienced radio/TV technician for help.

You are cautioned that any changes or modifications not expressly approved in this manual could void the user's authority to operate the equipment.

Notes on the Grant

To comply with Part 15 of the FCC Rules, this product must be used with a FUJIFILM-specified ferrite-core A/V cable, USB cable, and DC supply cord.

For Customers in Canada

CAUTION: This Class B digital apparatus complies with Canadian ICES-003.

EC Declaration of Conformity

We

Name: FUJIFILM Electronic Imaging Europe GmbH
Address: Benzstrasse 2
 47533 Kleve, Germany

declare that the product

Product Name: FUJIFILM DIGITAL CAMERA FinePix S1500
Manufacturer's Name: FUJIFILM Corporation
Manufacturer's Address: 7-3, AKASAKA 9-CHOME, MINATO-KU,
 TOKYO 107-0052 JAPAN

conforms to the following Standards:

Safety: EN60065:2002 + A1:2006
EMC: EN55022:1998 + A1:2000 + A2:2003 Class B
 EN55024:1998 + A1:2001 + A2:2003
 EN61000-3-2:2000 + A2:2005
 EN61000-3-3:1995 + A1:2001 + A2:2005

following the provision of the EMC Directive (2004/108/EC) and Low Voltage Directive (2006/95/EC).



Kleve, Germany February 1, 2009

Place

Date

Signature, Managing Director

Disposal of Electrical and Electronic Equipment in Private Households**Disposal of Used Electrical and Electronic Equipment (Applicable in the European Union, Norway, Iceland and Liechtenstein)**

This symbol on the product, or in the manual and in the warranty, and/or on its packaging indicates that this product shall not be treated as household waste.

Instead it should be taken to an applicable collection point for the recycling of electrical and electronic equipment.



By ensuring this product is disposed of correctly, you will help prevent potential negative consequences to the environment and human health, which could otherwise be caused by inappropriate waste handling of this product.



This symbol on the batteries or accumulators indicates that those batteries shall not be treated as household waste.

If your equipment contains easy removable batteries or accumulators please dispose these separately according to your local requirements.

The recycling of materials will help to conserve natural resources. For more detailed information about recycling this product, please contact your local city office, your household waste disposal service or the shop where you purchased the product.

In Countries Outside the European Union, Norway, Iceland and Liechtenstein

If you wish to discard this product, including the batteries or accumulators, please contact your local authorities and ask for the correct way of disposal.

Notes on Copyright

Unless intended solely for personal use, images recorded using your digital camera system cannot be used in ways that infringe copyright laws without the consent of the owner. Note that some restrictions apply to the photographing of stage performances, entertainments, and exhibits, even when intended purely for personal use. Users are also asked to note that the transfer of memory cards containing images or data protected under copyright laws is only permissible within the restrictions imposed by those copyright laws.

Trademark Information

Macintosh, Power Macintosh, Power Mac, PowerBook, QuickTime, and Mac OS are trademarks of Apple Inc. in the U.S.A. and other countries. Microsoft, Windows, the Windows logo, Windows Vista and the Windows Vista logo are trademarks or registered trademarks of Microsoft Corporation in the United States and/or other countries. "Windows" is an abbreviation used in reference to the Microsoft Windows operating system. Adobe and Adobe Reader are either trademarks or registered trademarks of Adobe Systems Incorporated in the U.S.A. and/or other countries. The SDHC logo is a trademark.

Note: The "Designed for Microsoft® Windows® XP" and "CERTIFIED FOR Windows Vista™" logos apply only to the camera and camera hardware driver.

About This Manual

Before using the camera, read this manual and the warnings on pages ii–vii. For information on specific topics, consult the sources below.

✓ **Camera Q & Apg. ix**

Know what you want to do but don't know the name for it? Find the answer in "Camera Q & A."

✓ **Troubleshootingpg. 98**

Having a specific problem with the camera? Find the answer here.

✓ **Glossarypg. 108**

The meanings of some technical terms may be found here.

✓ **Table of Contentspg. xii**

The "Table of Contents" gives an overview of the entire manual. The principal camera operations are listed here.

✓ **Warning Messages and Displayspg. 104**

Find out what's behind that flashing icon or error message in the monitor or electronic viewfinder.

 **Memory Cards**

Pictures can be stored in the camera's internal memory or on optional SD and SDHC memory cards. In this manual, SD memory cards are referred to as "memory cards." For more information, see page 10.

Camera Q & A

Find items by task.

Camera Setup

Question	Key phrase	See page
How do I set the camera clock?	Date and time	14
Can I set the clock to local time when I travel?	Time difference	93
How do I keep the display from turning off automatically?	Auto power off	92
How do I make the display brighter or darker?	LCD brightness	91
How do I stop the camera beeping and clicking?	Operation and shutter volume	88
	Silent mode	18
Can I change the sound the shutter makes?	Shutter sound	88
What are the parts of the camera called?	Parts of the camera	2
What do the icons in the display mean?	Displays	4
How do I use the menus?	Menus	64
What's behind that flashing icon or error message?	Messages and displays	104
How much charge is left in the battery?	Battery level	15
Can I increase the capacity of rechargeable Ni-MH batteries?	Discharge	94

Sharing Pictures

Question	Key phrase	See page
Can I print pictures on my home printer?	Printing pictures	53
Can I copy my pictures to my computer?	Viewing pictures on a computer	58

Taking Pictures

Question	Key phrase	See page
How many pictures can I take?	Memory capacity	109
Is there a quick and easy way to take snapshots?	 mode	15
How can I avoid blurred pictures?	Dual IS mode	17, 90
How can I make good portraits?	Intelligent Face Detection	21
Can the camera automatically adjust settings for different scenes?	SRAUTO mode	32
Can I choose my own settings for different scenes?	Scene position	32
How do I shoot close-ups?	Macro mode (close-ups)	25
How do I keep the flash from firing?	Flash mode	26
How do I stop my subjects' eyes glowing red when I use the flash?		
How do I "fill-in" shadows on back-lit subjects?		
How do I take a series of pictures in a single burst?	Continuous Shooting mode	28
How do I take a group portrait that includes the photographer?	Self-timer mode	70
How do I shoot a panorama?	PANORAMA mode	34
How do I turn off the lamp on the front of the camera?	AF-assist illuminator	24
How do I frame pictures with the subject off to one side?	Focus lock	23
Can I choose shutter speed and aperture?	P, S, A, and M modes	36
Can I save and recall camera settings?	C mode	40
How do I adjust exposure?	Exposure compensation	41
How do I shoot movies?	Recording movies	49
How do I frame pictures in the viewfinder?	EVF/LCD button	5

Viewing Pictures

Question	Key phrase	See page
How do I view my pictures?	Single-frame playback	43
How do I delete the current picture?	The  button	20
Can I select other pictures for deletion?	Deleting pictures	47
Can I zoom in on pictures during playback?	Playback zoom	44
How do I view a lot of pictures at once?	Multi-frame playback	46
How do I view all pictures taken on the same day?	Sort by date	46
Can I protect my pictures from accidental deletion?	Protect	81
Can I hide the icons in the display when viewing my pictures?	Choosing a display format	43
Can I view my pictures in a slide show?	Slide show	77
Can I add a short voice memo to my pictures?	Voice memo	84
Can I crop unwanted elements out of my pictures?	Crop (trimming)	86
Can I copy pictures from internal memory to a memory card?	Copy	82
How do I view my pictures on TV?	Viewing pictures on TV	52

Table of Contents

For Your Safety	ii
IMPORTANT SAFETY INSTRUCTIONS	ii
Safety Notes	iii
NOTICES	vi
About This Manual	viii
Camera Q & A	ix

Before You Begin

Introduction	1
Symbols and Conventions	1
Supplied Accessories	1
Parts of the Camera	2
Camera Displays	4
The Mode Dial	6









First Steps

The Strap and Lens Cap	7
Inserting the Batteries	8
Inserting a Memory Card	10
Turning the Camera on and Off	13
Shooting Mode	13
Playback Mode	13
Basic Setup	14

Basic Photography and Playback

Taking Pictures in  (Auto) Mode	15
Viewing Pictures	20

More on Photography

Intelligent Face Detection and Red-Eye Removal	21
Focus Lock	23
 Macro and Super Macro Modes (Close-ups)	25
 Using the Flash	26
 Continuous Shooting (Burst Mode)	28
 Instant Zoom	30
Shooting Mode	32
 AUTO	32
SR  SCENE RECOGNITION	32
SP SCENE POSITION	32
Scene Descriptions	33
 PANORAMA MODE	34
P, S, A, and M Modes	36
C: CUSTOM MODE	40
 Exposure Compensation	41

More on Playback

Playback Options.....	43
Playback Zoom.....	44
Viewing Photo Information.....	45
Multi-Frame Playback.....	46
Sort by Date.....	46
 Deleting Pictures.....	47

Movies











 Recording Movies.....	49
 Viewing Movies.....	51

Connections

Viewing Pictures on TV.....	52
Printing Pictures via USB.....	53
Connecting the Camera.....	53
Printing Selected Pictures.....	53
Printing the DPOF Print Order.....	54
Creating a DPOF Print Order.....	56
Viewing Pictures on a Computer.....	58
Installing FinePixViewer.....	58
Connecting the Camera.....	62

Menus

Using the Menu: Shooting Mode.....	64
Using the <i>F</i> -Mode Menu.....	64
<i>F</i> -Mode Menu Options.....	65
ISO ISO.....	65
QUALITY.....	66
FINEPIX COLOR.....	67
Using the Shooting Menu.....	68
Shooting Menu Options.....	69
SELF-TIMER.....	70
PHOTOMETRY.....	71
WHITE BALANCE.....	72
HIGH-SPEED SHOOTING.....	73
FOCUSING.....	73
AF MODE.....	74
SHARPNESS.....	75
FLASH.....	75
BRACKETING.....	75
Using the Menu: Playback Mode.....	76
Using the <i>F</i> -Mode Menu.....	76
<i>F</i> -Mode Menu Options.....	77
SLIDE SHOW.....	77
Using the Playback Menu.....	78
Playback Menu Options.....	79
RED EYE REMOVAL.....	79
IMAGE ROTATE.....	80
PROTECT.....	81
COPY.....	82
VOICE MEMO.....	84
TRIMMING.....	86

The Setup Menu	87
Using the Setup Menu	87
Setup Menu Options.....	88
 IMAGE DISP.	89
 FRAME NO.	90
 DUAL IS MODE.....	90
 DIGITAL ZOOM	91
 PLAYBACK VOLUME.....	91
 LCD BRIGHTNESS.....	91
 FORMAT.....	92
 AUTO POWER OFF	92
 TIME DIFFERENCE	93
 DISCHARGE (Ni-MH Batteries Only)	94
Technical Notes	
Optional Accessories	95
Accessories from FUJIFILM	96
Caring for the Camera	97
Troubleshooting	
Troubleshooting	98
Warning Messages and Displays	104
Appendix	
Glossary	108
Internal Memory/Memory Card Capacity	109
Specifications	110
FUJIFILM Digital Camera Worldwide Network	114

Introduction

Symbols and Conventions

The following symbols are used in this manual:

 **Caution:** This information should be read before use to ensure correct operation.

 **Note:** Points to note when using the camera.

 **Tip:** Additional information that may be helpful when using the camera.

Menus and other text in the camera monitor are shown in bold. In the illustrations in this manual, the monitor display may be simplified for explanatory purposes.

Supplied Accessories

The following items are included with the camera:

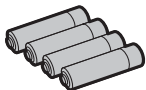

AA alkaline (LR6) batteries
(x4)

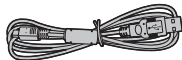

USB cable



A/V cable

Owner's Manual
(this manual)



Strap



Lens cap



FinePix software CD
(IMPORTANT: read license agreement on the last page of this manual before opening)

Parts of the Camera

For more information, refer to the page listed to the right of each item.

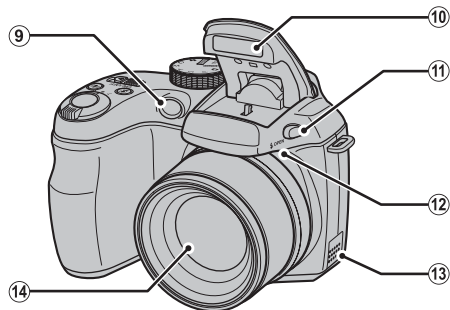
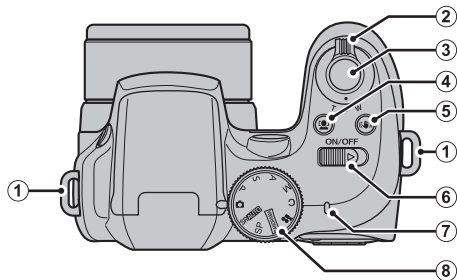

1	Strap eyelet.....	7	6	ON/OFF switch.....	13	11	⚡ (flash pop-up) button.....	26
2	Zoom control.....	16, 44	7	Indicator lamp.....	19	12	Microphone.....	84
3	Shutter button.....	19	8	Mode dial.....	6	13	Speaker.....	85
4	👤 (Intelligent Face Detection/ red-eye removal) button.....	21	9	AF-assist illuminator.....	24	14	Lens.....	13
5	👉 (dual IS) button.....	17	10	Flash.....	26			

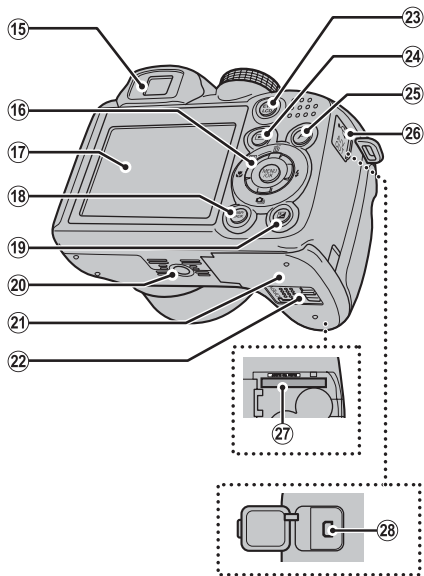

15	Electronic viewfinder	5	23	EVF/LCD (display selection) button	5
16	Selector button (see below)		24	▶ (playback) button	43
17	Monitor	4	25	F (photo mode) button	64
18	DISP (display)/BACK button	17, 43	26	Terminal cover	52
19	☒ (exposure compensation/photo info) button	41, 45	27	Memory card slot	11
20	Tripod mount		28	Connector for A/V cable	52
21	Battery-chamber cover	8		Connector for USB cable	53
22	Battery-chamber latch	8			

The Selector Button

Move cursor up

- ⏏ (instant zoom) button (pg. 30)
- 🗑 (delete) button (pg. 20)

MENU/OK button (pg. 14)

Move cursor left

- 🔍 (macro) button (pg. 25)

Move cursor right
⚡ (flash) button (pg. 26)

Move cursor down

- 📷 (continuous shooting) button (pg. 28)

Camera Displays

The following indicators may appear during shooting and playback. The indicators displayed vary with camera settings.

Shooting

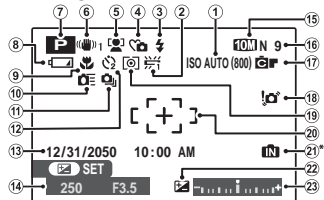

* **IN**: indicates that no memory card is inserted and that pictures will be stored in the camera's internal memory (pg. 10).

1	Sensitivity.....	65	13	Date and time.....	14
2	White balance	72	14	Shutter speed and aperture	36
3	Flash mode.....	26	15	Quality.....	49, 66
4	Silent mode	18	16	Number of available frames.....	109
5	Intelligent Face Detection indicator.....	21	17	FinePix color	67
6	Dual IS mode	90	18	Blur warning.....	26, 104
7	Shooting mode.....	32	19	Metering	71
8	Battery level.....	15	20	Focus frame.....	18
9	Macro (close-ups) mode	25	21	Internal memory indicator*	10
10	High-speed mode.....	73	22	Exposure compensation indicator.....	41
11	Continuous shooting mode.....	28	23	Exposure indicator	40
12	Self-timer indicator	70			

Playback

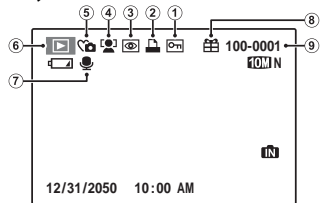

1	Protected image.....	81	5	Silent mode indicator.....	18
2	DPOF print indicator.....	54	6	Playback mode indicator	43
3	Red-eye removal indicator	79	7	Voice memo indicator.....	84
4	Intelligent Face Detection indicator.....	21	8	Gift image	43
			9	Frame number	90

The Electronic Viewfinder (EVF)

The electronic viewfinder provides the same information as the monitor, and can be used when bright lighting conditions make the display in the monitor difficult to see. To switch between the monitor and electronic viewfinder, press the **EVF/LCD** button (your selection remains in effect when the camera is turned off or the mode dial is rotated to another setting).

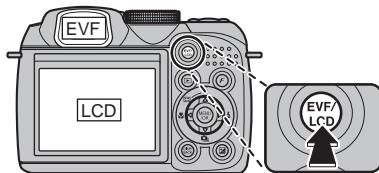

The Mode Dial

To select a shooting mode, align the mode icon with the mark next to the mode dial.

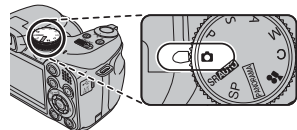

📷 (AUTO): A simple “point-and-shoot” mode recommended for first-time users of digital cameras (pg. 15).

SR/AUTO (SCENE RECOGNITION): A “point-and-shoot” mode in which the camera automatically adjusts settings to suit the scene (pg. 32).

SP (SCENE POSITION): Choose a scene suited to the subject or shooting conditions and let the camera do the rest (pg. 32).

P, S, A, M: Select for full control over camera settings, including aperture (**M** and **A**) and/or shutter speed (**M** and **S**; pg. 36).

C (CUSTOM): Recall stored settings for modes **P**, **S**, **A**, and **M** (pg. 40).

🎥 (MOVIE): Record movies with sound (pg. 49).

PANORAMA (PANORAMA): Take a series of photographs and combine them to form a panorama (pg. 34).

The Strap and Lens Cap

Attaching the Strap

Attach the strap to the two strap eyelets as shown below.

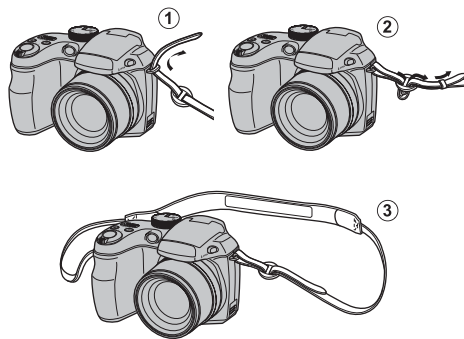

Caution

To avoid dropping the camera, be sure the strap is correctly secured.

The Lens Cap

Attach the lens cap as shown.

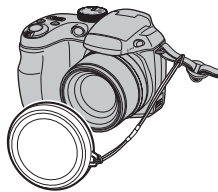

To avoid losing the lens cap, pass the supplied string through the eyelet (1) and secure the lens cap to the strap (2).

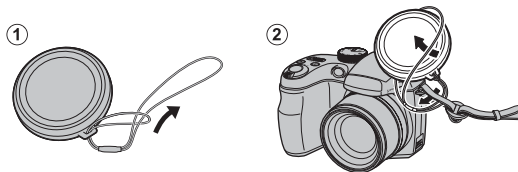

Inserting the Batteries

The camera takes four AA alkaline, lithium, or rechargeable Ni-MH batteries. A set of four alkaline batteries is supplied with the camera. Insert the batteries in the camera as described below.

1 Open the battery-chamber cover.

Slide the battery-chamber latch in the direction shown and open the battery-chamber cover.

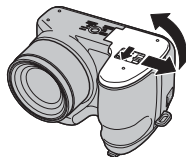

Note

Be sure the camera is off before opening the battery-chamber cover.

Cautions

- Do not open the battery-chamber cover when the camera is on. Failure to observe this precaution could result in damage to image files or memory cards.
- Do not use excessive force when handling the battery-chamber cover.

2 Insert the batteries.

Insert the batteries in the orientation shown by the “+” and “-” marks inside the battery chamber.

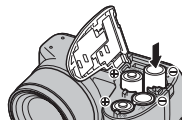

Cautions

- Insert the batteries in the correct orientation.

- **Never use batteries with peeling or damaged casing or mix old and new batteries, batteries with different charge levels, or batteries of different types.**

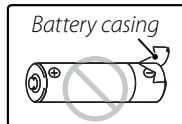

Failure to observe these precautions could result in the batteries leaking or overheating.



- **Never use manganese or Ni-Cd batteries.**
- The capacity of alkaline batteries varies with the manufacturer and drops at temperatures below 10°C/32°F; Ni-MH batteries are recommended.
- Fingerprints and other soil on the battery terminals can shorten battery life.

3 Close the battery-chamber cover.

Close the battery-chamber cover and slide it in until the latch clicks into place.

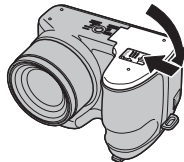

Caution

Do not use force. If the battery-chamber cover does not close, check that the batteries are in the correct orientation and try again.

Tip: Using an AC Adapter

The camera can be powered by an optional AC adapter and DC coupler (sold separately).

Choosing the Battery Type

After replacing the batteries with batteries of a different type, select the battery type using the  **BATTERY TYPE** option in the setup menu (pg. 88) to ensure that the battery level is displayed correctly and the camera does not turn off unexpectedly.

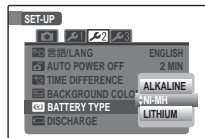

Inserting a Memory Card

Although the camera can store pictures in internal memory, SD memory cards (sold separately) can be used to store additional pictures.

When no memory card is inserted,  appears in the monitor and internal memory is used for recording and playback. Note that because camera malfunction could cause internal memory to become corrupted, the pictures in internal memory should periodically be transferred to a computer and saved on the computer hard disk or on removable media such as CDs or DVDs. The pictures in internal memory can also be copied to a memory card (see page 82). To prevent internal memory from becoming full, be sure to delete pictures when they are no longer needed.

When a memory card is inserted as described below, the card will be used for recording and playback.

■ **Compatible Memory Cards**

SanDisk SD and SDHC memory cards have been approved for use in the camera. A complete list of approved memory cards is available at http://www.fujifilm.com/products/digital_cameras/index.html. Operation is not guaranteed with other cards. The camera can not be used with MultiMediaCard (MMC) or *xD-Picture Cards*.

Caution

Memory cards can be locked, making it impossible to format the card or to record or delete images. Before inserting a memory card, slide the write-protect switch to the unlocked position.

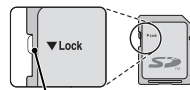

*Write-protect
switch*

■ Inserting a Memory Card

1 Open the battery-chamber cover.

← Note

Be sure the camera is off before opening the battery-chamber cover.

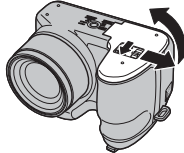

2 Insert the memory card.

Holding the memory card in the orientation shown below, slide it all the way in.

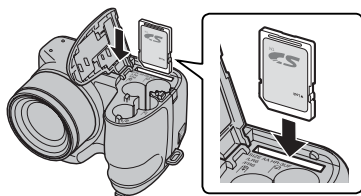

Be sure card is in correct orientation; do not insert at an angle or use force.

3 Close the battery-chamber cover.

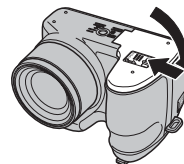

● Removing Memory Cards

After confirming that the camera is off, press the card in and then release it slowly. The card can now be removed by hand.

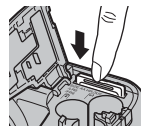

⚠ Cautions

- The memory card may spring out if you remove your finger immediately after pushing the card in.
- Memory cards may be warm to the touch after being removed from the camera. This is normal and does not indicate a malfunction.

⚠ Cautions

- **Do not turn the camera off or remove the memory card while the memory card is being formatted or data are being recorded to or deleted from the card.** Failure to observe this precaution could damage the card.
- Format memory cards before first use, and be sure to reformat all memory cards after using them in a computer or other device. For more information on formatting memory cards, see page 92.
- Memory cards are small and can be swallowed; keep out of reach of children. If a child swallows a memory card, seek medical assistance immediately.
- Do not use miniSD or microSD adapters that expose the back of the card. Failure to observe this precaution may cause damage or malfunction. Adapters that are larger or smaller than the standard dimensions of an SD card may not eject normally; if the card does not eject, take the camera to an authorized service representative. Do not forcibly remove the card.
- Do not affix labels to memory cards. Peeling labels can cause camera malfunction.
- Movie recording may be interrupted with some types of memory card.
- The data in internal memory may be erased or corrupted when the camera is repaired. Please note that the repairer will be able to view pictures in internal memory.
- Formatting a memory card or internal memory in the camera creates a folder in which pictures are stored. Do not rename or delete this folder or use a computer or other device to edit, delete, or rename image files. Always use the camera to delete pictures from memory cards and internal memory; before editing or renaming files, copy them to a computer and edit or rename the copies, not the originals.

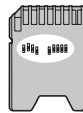

Turning the Camera on and Off

Shooting Mode

Slide the **ON/OFF** switch in the direction shown below. The lens will extend automatically.

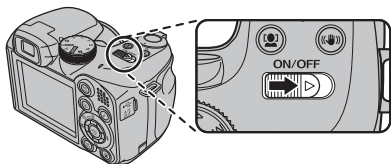

Slide the **ON/OFF** switch to turn the camera off.

Tip: Switching to Playback Mode

Press the  button to start playback. Press the shutter button halfway to return to shooting mode.

Cautions

- Forcibly preventing the lens from extending could cause damage or product malfunction.
- Pictures can be affected by fingerprints and other marks on the lens. Keep the lens clean.
- The **ON/OFF** button does not completely disconnect the camera from its power supply.

Tip: Auto Power Off

The camera will turn off automatically if no operations are performed for the length of time selected in the **AUTO POWER OFF** menu (see page 92). To turn the camera on, use the **ON/OFF** switch or press the  button for about a second.

Playback Mode

To turn the camera on and begin playback, press the  button for about a second.

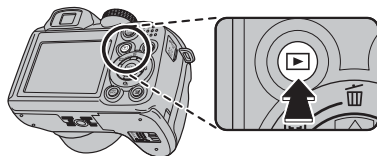

Press the  button again to turn the camera off.

Tip: Switching to Shooting Mode

To exit to shooting mode, press the shutter button halfway. Press the  button to return to playback.

Basic Setup

A language-selection dialog is displayed the first time the camera is turned on. Set up the camera as described below (for information on resetting the clock or changing languages, see page 88).

1 Choose a language.



1.1 Press the selector up, down, left, or right to highlight a language.



1.2 Press **MENU/OK**.



2 Set the date and time.

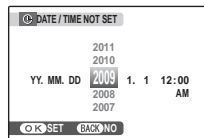

2.1 Press the selector left or right to highlight the year, month, day, hour, or minute and press up or down to change. To change the order in which the year, month, and day are displayed, highlight the date format and press the selector up or down.



2.2 Press **MENU/OK**.



Tip: The Camera Clock



If the batteries are removed for an extended period, the camera clock will be reset and the language-selection dialog will be displayed when the camera is turned on. If the batteries are left in the camera or an optional AC adapter connected for about 10 hours, the battery can be removed for about 24 hours without resetting the clock or language selection.

Taking Pictures in (Auto) Mode

This section describes how to take pictures in  (auto) mode.

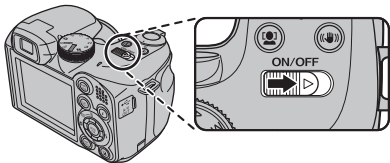
- 1 Turn the camera on.**
Slide the **ON/OFF** switch to turn the camera on.



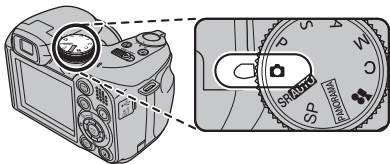

- 2 Select  mode.**
Rotate the mode dial to .

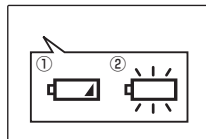

- 3 Check the battery level.**
Check the battery level in the display.



Indicator	Description
NO ICON	Batteries are partially discharged.
①  (red)	Batteries are low. Replace as soon as possible.
②  (blinks red)	Batteries are exhausted. Turn camera off and replace batteries.

Note

A battery warning may not be displayed before the camera turns off, particularly if batteries are reused after having once been exhausted. Power consumption varies greatly from mode to mode; the low battery warning () may not be displayed or may be displayed only briefly before the camera turns off in some modes or when switching from shooting to playback mode.

4 Frame the picture.

Position the main subject in the focus frame and use the zoom control to frame the picture in the display.

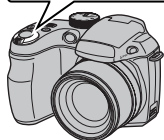
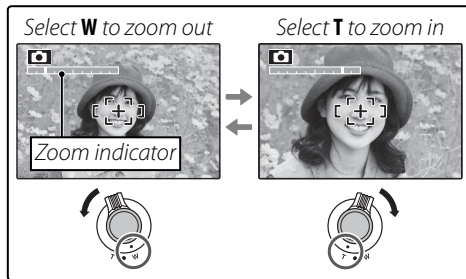

By default setting, the camera uses optical zoom only. If desired, digital zoom (pg. 91) can be used to zoom in closer.

Holding the Camera

Hold the camera steady with both hands and brace your elbows against your sides. Shaking or unsteady hands can blur your shots.

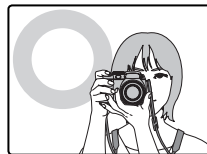

To prevent pictures that are out of focus or too dark (underexposed), keep your fingers and other objects away from the lens and flash.



Tip: Focus Lock

Use focus lock (pg. 23) to focus on subjects that are not in the focus frame.

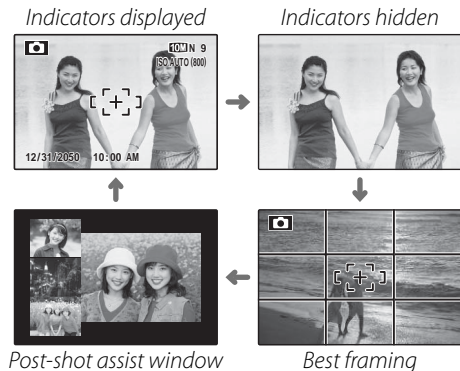

Framing Guideline and Post-Shot Assist Window

To choose the shooting information and guides displayed, press the **DISP/BACK** button.



- **Best framing:** To use the best framing, position the main subject at the intersection of two lines or align one of the horizontal lines with the horizon. Use focus lock (pg. 23) to focus on subjects that will not be in the center of the frame in the final photograph.
- **Post-shot assist window:** The previous three pictures are displayed on the left, with the most recent picture at the bottom. Use for reference when taking multiple pictures of the same subject.

Avoiding Blurred Pictures

If the subject is poorly lit, blurring caused by camera shake can be reduced by pressing the  button. In  mode, pressing the  button also reduces blur caused by subject movement (dual IS mode).

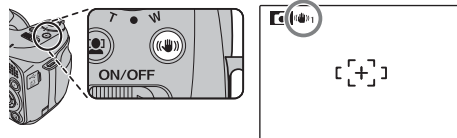



Press  to turn dual IS on or off. Icon appears in monitor when dual IS is on (icon displayed depends on option selected for  **DUAL IS MODE**; see pg. 90).

Sensitivity is raised when dual IS is in effect. Note that blurring may still occur depending on the scene.

Silent Mode

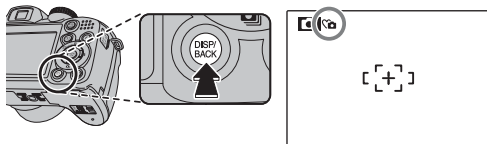
In situations in which camera sounds or lights may be unwelcome, hold the **DISP/BACK** button down until  is displayed (note that silent mode is not available during movie or voice memo playback).



The camera speaker and AF-assist illuminator/self-timer lamp turn off and volume (pg. 91) can not be adjusted. To restore normal operation, press the **DISP/BACK** button until the  icon is no longer displayed.

5 Focus.

Press the shutter button halfway to focus on the main subject in the focus frame.

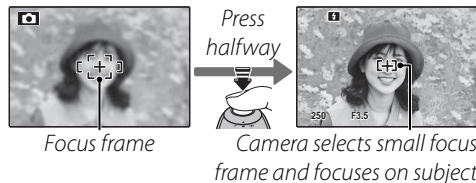

Note

The lens may make a noise when the camera focuses. This is normal.

If the camera is able to focus, it will beep twice and the indicator lamp will glow green.

If the camera is unable to focus, the focus frame will turn red, **!AF** will be displayed, and the indicator lamp will blink green. Change the composition or use focus lock (pg. 23).

6 Shoot.

Smoothly press the shutter button the rest of the way down to take the picture.



Tip: The Shutter Button

The shutter button has two positions. Pressing the shutter button halfway (①) sets focus and exposure; to shoot, press the shutter button the rest of the way down (②).

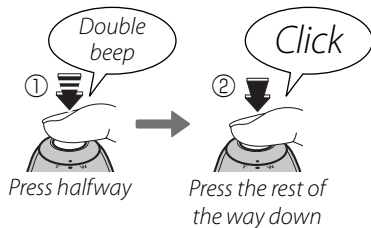

Note

If the subject is poorly lit, the AF-assist illuminator may light to assist focus (pg. 24). For information on using the flash when lighting is poor, see page 26.

The Indicator Lamp

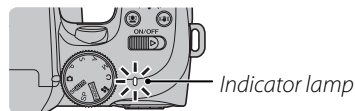

The indicator lamp shows camera status as follows:

Indicator lamp	Camera status
Glows green	Focus locked.
Blinks green	Blur, focus, or exposure warning. Picture can be taken.
Blinks green and orange	Recording pictures. Additional pictures can be taken.
Glows orange	Recording pictures. No additional pictures can be taken at this time.
Blinks orange	Flash charging; flash will not fire when picture is taken.
Blinks red	Lens or memory error (internal memory or memory card full or not formatted, format error, or other memory error).

Tip: Warnings

Detailed warnings appear in the display. See pages 104–107 for more information.

Viewing Pictures

Pictures can be viewed in the monitor. When taking important photographs, take a test shot and check the results.

- 1 Press the  button for about a second.

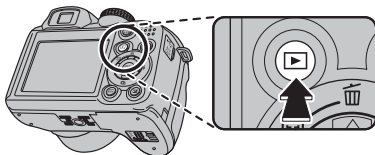

The most recent picture will be displayed in the monitor.





- 2 View additional pictures.
Press the selector right to view pictures in the order recorded, left to view pictures in reverse order.



Press the shutter button to exit to shooting mode.

Deleting Pictures

To delete the picture currently displayed in the monitor, press the selector up () (). The following dialog will be displayed.

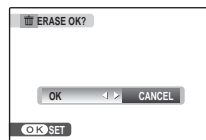

To delete the picture, press the selector left to highlight **OK** and press **MENU/OK**. To exit without deleting the picture, highlight **CANCEL** and press **MENU/OK**.



Tip: The Playback Menu

Pictures can also be deleted from the playback menu (pg. 47).





Intelligent Face Detection and Red-Eye Removal

Intelligent Face Detection allows the camera to automatically detect human faces and set focus and exposure for a face anywhere in the frame for shots that emphasize portrait subjects. Choose for group portraits (in horizontal or vertical orientations) to prevent the camera from focusing on the background. Intelligent Face Detection also offers a red-eye removal option for removing “red-eye” effects caused by the flash.

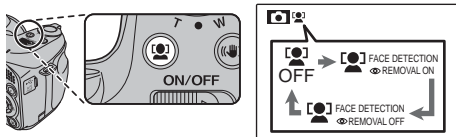
1 Turn Intelligent Face Detection on.

Press the  button to cycle through settings as shown below.



Option	Description
 OFF	Intelligent Face Detection and red-eye removal off.
 FACE DETECTION  REMOVAL ON	Intelligent Face Detection and red-eye removal on. Use with the flash.
 FACE DETECTION  REMOVAL OFF	Intelligent Face Detection on; red-eye removal off.

2 Frame the picture.

If a face is detected, it will be indicated by a green border. If there is more than one face in the frame, the camera will select the face closest to the center; other faces are indicated by white borders.



Green border

3 Focus.

Press the shutter button halfway to set focus and exposure for the subject in the green border.



Caution

If no face is detected when the shutter button is pressed halfway (pg. 100), the camera will focus on the subject at the center of the display and red-eye will not be removed.

4 Shoot.

Press the shutter button all the way down to shoot.



Caution

If the subject moves as the shutter button is pressed, their face may not be in the area indicated by the green border when the picture is taken.

If  **FACE DETECTION**

 **REMOVAL ON** is selected, the picture will be processed to reduce red-eye before it is recorded.

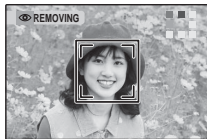

Intelligent Face Detection

Intelligent Face Detection is recommended when using the self-timer for group- or self-portraits (pg. 70).

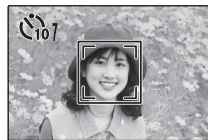

When a picture taken with Intelligent Face Detection is displayed, the camera can automatically select faces for red-eye removal (pg. 79), playback zoom (pg. 44), slide shows (pg. 77), printing (pg. 53), and cropping (pg. 86).

Focus Lock

To compose photographs with off-center subjects:

1 Position the subject in the focus frame.



2 Focus.

Press the shutter button halfway to set focus and exposure. Focus and exposure will remain locked while the shutter button is pressed halfway (AF/AE lock).



*Press
halfway*



Repeat steps 1 and 2 as desired to refocus before taking the picture.

3 Recompose the picture.

Keeping the shutter button pressed halfway, recompose the picture.



4 Shoot.

Press the shutter-release button the rest of the way down to take the picture.



*Press the rest of
the way down*

Autofocus

Although the camera boasts a high-precision autofocus system, it may be unable to focus on the subjects listed below. If the camera is unable to focus using autofocus, use focus lock (pg. 23) to focus on another subject at the same distance and then recompose the photograph.

- Very shiny subjects such as mirrors or car bodies.
- Fast-moving subjects.

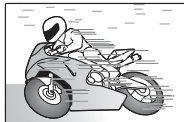

- Subjects photographed through a window or other reflective object.
- Dark subjects and subjects that absorb rather than reflect light, such as hair or fur.
- Insubstantial subjects, such as smoke or flame.
- Subjects that show little contrast with the background (for example, subjects in clothing that is the same color as the background).
- Subjects positioned in front of or behind a high-contrast object that is also in the focus frame (for example, a subject photographed against a backdrop of highly contrasting elements).

The AF-Assist Illuminator

If the subject is poorly lit, the AF-assist illuminator will light to assist the focus operation when the shutter button is pressed halfway.



Notes

- Avoid shining the AF-assist illuminator directly into your subject's eyes. See page 88 for information on disabling the AF-assist illuminator.
- The camera may be unable to focus using the AF-assist illuminator in some cases. If the camera is unable to focus in macro mode (pg. 25), try increasing the distance to the subject.
- The AF-assist illuminator is not available in silent mode.

Macro and Super Macro Modes (Close-ups)

For close-ups, press the selector left () to choose from the macro options shown below.

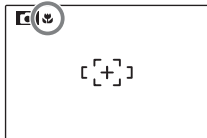
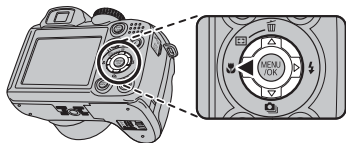

Choose from  (macro mode),
 (super macro mode), or
 OFF (macro mode off)

When macro mode is in effect, the camera focuses on subjects near the center of the frame. Use the zoom control to compose pictures. In super macro mode, zoom can not be adjusted and the flash can not be used.

To exit macro mode, press the selector left () until  OFF is displayed.

Notes

- Use of a tripod is recommended to prevent blur caused by camera shake.
- Flash compensation may be required when using the flash (pg. 75).

⚡ Using the Flash

Use the flash when lighting is poor, for example when shooting at night or indoors under low light.

1 Raise the flash.

Press the flash pop-up button to raise the flash.

● Turning the Flash Off

Lower the flash where flash photography is prohibited or to capture natural lighting under dim light. At slow shutter speeds,  will be displayed to warn that pictures may be blurred; use of a tripod is recommended.

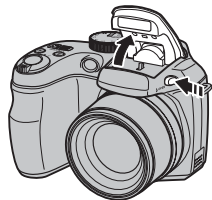

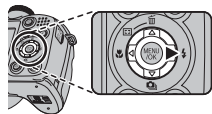

2 Choose a flash mode.

Press the selector right (). The flash mode changes each time the selector is pressed.



Mode	Description
AUTO (AUTO FLASH)	The flash fires when required. Recommended in most situations.
⚡ (FORCED FLASH)	The flash fires whenever a picture is taken. Use for backlit subjects or for natural coloration when shooting in bright light.
S⚡ (SLOW SYNCHRO)	Capture both the main subject and the background under low light (note that brightly lit scenes may be overexposed).

3 Focus.

Press the shutter button halfway to focus. If the flash will fire,  will be displayed when the shutter button is pressed halfway. At slow shutter speeds,  will appear in the display to warn that pictures may be blurred; use of a tripod is recommended.



4 Shoot.







Press the shutter button the rest of the way down to shoot.

Caution

The flash may fire several times with each shot. Do not move the camera until shooting is complete.



Red-Eye Removal

When  **FACE DETECTION**  **REMOVAL ON** is selected for Intelligent Face Detection (pg. 22), red-eye removal () is available in AUTO () , FORCED FLASH () , and SLOW SYNCHRO () modes. Red-eye removal minimizes “red-eye” caused when light from the flash is reflected from the subject’s retinas as shown in the illustration at right.









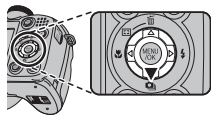

Continuous Shooting (Burst Mode)

Capture motion in a series of pictures.

1 Choose a continuous shooting mode.

Press the selector down (). The continuous shooting mode changes each time the selector is pressed.



Mode	Description
 (TOP 15 2M)	The camera takes up to 15 pictures while the shutter button is pressed. Quality and sensitivity are automatically adjusted for the highest possible burst rate.*
 (TOP 6 5M)	The camera takes up to 6 pictures while the shutter button is pressed. Quality and sensitivity are automatically adjusted for a high burst rate.*
 (LONG PERIOD)	The camera takes pictures while the shutter button is pressed. Shooting ends when the shutter button is released or memory is full. To view pictures as they are taken, use the post-shot assist window (pg. 17).
 (LAST 3)	The camera takes up to 40 pictures while the shutter button is pressed, but only the last three frames are recorded.
 (BRACKETING)	Each time the shutter-release button is pressed, the camera takes three shots: one using the metered value for exposure, the second overexposed by the amount selected for  BRACKETING in the shooting menu (pg. 75), and the third underexposed by the same amount (the camera may not be able to use the selected bracketing increment if the amount of over- or under-exposure exceeds the limits of the exposure metering system).
 (TOP 3)	The camera takes up to three pictures while the shutter button is pressed.
OFF	Continuous shooting mode off. One picture is taken each time the shutter button is pressed.

* Settings that have been altered from the value selected by the user are displayed in yellow; the original setting will be restored when another continuous shooting option is selected.

2 Focus.

Press the shutter button halfway to focus.









3 Shoot.

Pictures will be taken while the shutter button is pressed. Shooting ends when the shutter button is released, memory is full, or the selected number of shots has been taken.



← Notes

- In all continuous shooting modes except , focus and exposure are determined by the first frame in each series. The flash turns off automatically (pg. 26); the previously-selected flash mode is restored when continuous shooting is turned off.
- Frame rate varies with shutter speed.
- If the self-timer is used when  and  are selected, only one picture will be taken when the shutter button is pressed.
- At a setting of , white lines may appear in bright areas of the image; these can be avoided by choosing  mode.
- The number of pictures that can be recorded depends on the memory available. Bracketing is only available if there is sufficient memory for three pictures. In all continuous shooting modes except , additional time may be required to record pictures when shooting ends. The pictures are displayed in the monitor while recording is in progress.



Instant Zoom

Instant zoom offers a quick way to compose pictures.

■ **Optical Zoom**

- 1 Position the subject in the focus frame.**
Use the zoom control to frame the subject in the center of the display.



- 2 Choose a frame.**

Press the selector up () to cycle through framing options as shown below.

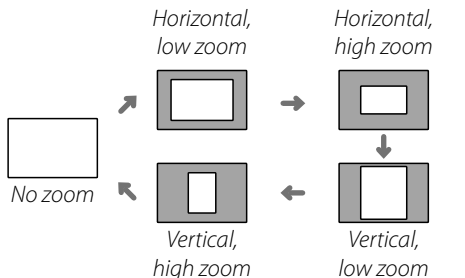

The frame is displayed as shown at right. The composition can be adjusted using the zoom control.



- 3 Focus and shoot.**



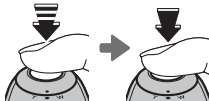

The framed area will be enlarged to create a full-sized picture.



Intelligent Face Detection

Intelligent Face Detection will not detect faces outside the selected frame.

Caution

Only horizontal (landscape-orientation) framing is available when , , or  is selected for continuous shooting mode. The maximum number of shots that can be taken when  or  is selected decreases if vertical orientation framing is used.

■ Digital Zoom

- 1 Enable digital zoom.
Select **ON** for the  **DIGITAL ZOOM** option in the setup menu (pg. 91).
- 2 Choose a subject.
Frame the subject in the center of the display.



- 3 Zoom to the digital zoom position.
- 4 Press the selector up ()
The camera will zoom to the maximum optical zoom position with the area that will be recorded using digital zoom indicated by a frame at the center of the display.

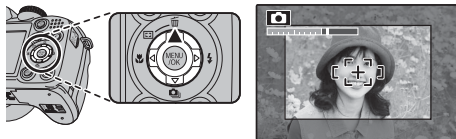

- 5 Frame the picture.
Use the zoom control to choose the area that will be included in the final photograph.

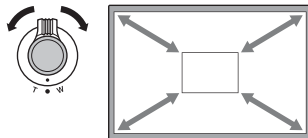

- 6 Focus and shoot.
The framed area will be enlarged to create a full-sized picture.

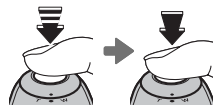

Caution

Pictures taken using the instant zoom are lower quality than pictures taken using normal zoom.

Shooting Mode







Choose a shooting mode according to the scene or type of subject. To choose a shooting mode, rotate the mode dial to the desired setting (pg. 6). The following modes are available:

AUTO

Choose for crisp, clear snapshots (pg. 15). This mode is recommended in most situations.

SRAUTO SCENE RECOGNITION

In this mode, the camera automatically analyzes the composition and selects the appropriate scene mode according to the subject and shooting conditions. The selected mode is displayed when the shutter button is pressed halfway.

Mode	Type of subject or scene detected
	Portrait: Human portrait subject.
	Landscape: Man-made or natural landscape.
	Night landscape: Poorly lit landscape.
	Macro: Subject close to camera.
	Back-lit portrait: Back-lit portrait subject.
	Night portrait: Poorly lit portrait subject.

Notes: SRAUTO

-  (**AUTO**) will be selected if the subject does not match the scenes listed above.
- The camera focuses continuously on the faces of portrait subjects or on subjects near the center of the frame. This increases the drain on the battery, and the sound of the camera focusing may be audible.

SP SCENE POSITION

The camera offers a choice of “scenes,” each adapted to particular shooting conditions or a specific type of subject, which can be assigned to the **SP** position on the mode dial:

- 1 Rotate the mode dial to **SP**.



- 2 Press **MENU/OK** to display the shooting menu.



3 Press the selector up or down to highlight  **SCENE POSITION**.



4 Press the selector right to display a list of scenes.



5 Press the selector up or down to highlight a scene (pg. 33).



6 Press **MENU/OK** to select the highlighted option.



















Until the setting is changed as described above, the chosen scene will be selected whenever the mode dial is rotated to **SP**. The default selection is .

← Note: Scene Position

F-CHROME can not be selected for the **FINEPIX COLOR** option in the shooting menu (pg. 67).

Scene Descriptions

Scene	Description
 PORTRAIT	Choose this mode for soft-toned portraits with natural skin tones.
 LANDSCAPE	Choose this mode for crisp, clear daylight shots of buildings and landscapes. The flash turns off automatically.
 SPORT	Choose this mode when photographing moving subjects.  HIGH-SPEED SHOOTING turns on automatically and priority is given to faster shutter speeds.
 NIGHT	Choose this mode for poorly lit twilight or night scenes. Sensitivity is automatically raised to reduce blur caused by camera shake.
 NIGHT (TRIPOD)	Choose this mode for slow shutter speeds when shooting at night. Use a tripod to prevent blur.
 NATURAL LIGHT	Capture natural light indoors, under low light, or where the flash can not be used. The flash turns off and sensitivity is raised to reduce blur.
 FIREWORKS	Slow shutter speeds are used to capture the expanding burst of light from a firework. Press the  button to display a shutter-speed selection dialog and press the selector up and down to choose a shutter speed. The flash turns off automatically.

Scene	Description
 SUNSET	Choose this mode to record the vivid colors in sunrises and sunsets.
 SNOW	Choose for crisp, clear shots that capture the brightness of scenes dominated by shining white snow.
 BEACH	Choose for crisp, clear shots that capture the brightness of sunlit beaches.
 MUSEUM	Choose where flash photography is prohibited or the sound of the shutter may be unwelcome. The flash, speaker, and AF-assist illuminator/self-timer lamp turn off automatically.
 PARTY	Capture indoor background lighting under low-light conditions.
 FLOWER	Choose for vivid close-ups of flowers. The camera focuses in the macro range and the flash turns off automatically.
 TEXT	Take clear pictures of text or drawings in print. The camera focuses in the macro range.

PANORAMA MODE

In this mode, you can take up to three pictures and join them together to form a panorama. Use of a tripod is recommended to assist in composing overlapping shots.

- 1 Rotate the mode dial to .



- 2 Press the selector up to select a frame, and press the selector left or right to highlight a pan direction and press **MENU/OK**.



- 3 Take a photograph. Exposure and white balance for the panorama are set with the first shot.



- 4** Press **MENU/OK**. An edge of the picture you have just taken will be displayed at one side of the frame.

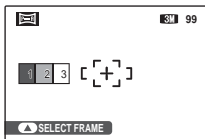

- 5** Frame the next shot to overlap with the previous picture.

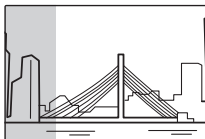

- 6** Take the second shot as described in steps 3–4 (to create a panorama from only two frames, press the selector up after the second shot).

- 7** Take the last shot, framing it to overlap the second picture. Press **MENU/OK** to complete the panorama (the individual shots are not saved).



- 8** Press **MENU/OK** to save the picture.

P, S, A, and M Modes

P, **S**, **A**, and **M** modes provide full access to the shooting and **F**-mode menus. **S**, **A**, and **M** modes also offer control over shutter speed and/or aperture.

Mode	Description
P (PROGRAM AE; pg. 37)	The camera sets exposure automatically.
S (SHUTTER PRIORITY AE; pg. 37)	You choose the shutter speed, letting the camera set aperture for optimal exposure.
A (APERTURE PRIORITY AE; pg. 38)	You choose the aperture, letting the camera set shutter speed for optimal exposure.
M (MANUAL; pg. 39)	You choose both shutter speed and aperture.

Shutter Speed and Aperture

Choose fast shutter speeds to freeze motion, slow shutter speeds to suggest motion by blurring moving objects.



Fast shutter speed



Slow shutter speed

Small apertures bring objects behind and in front of the main subject into focus, while large apertures emphasize the main subject by blurring background and foreground objects.

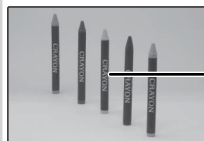

*Small aperture
(high F-number)*

*Main
subject*

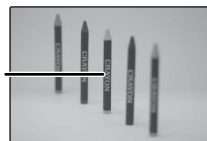

*Large aperture
(low F-number)*

P: PROGRAM AE

In this mode, the camera sets exposure automatically.

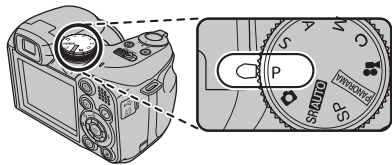
**Caution**

If the subject is outside the metering range of the camera, the shutter speed and aperture displays will show “---”. Press the shutter button halfway to measure exposure again.

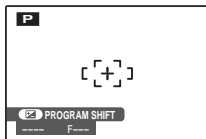
**S: SHUTTER PRIORITY AE**

In this mode, you choose the shutter speed while the camera adjusts aperture for optimal exposure.

- 1 Rotate the mode dial to **S**.



- 2 Press the  button. Shutter speed and aperture will be displayed.

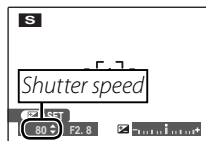

- 3 Press the selector up or down to choose the shutter speed.



- 4** Take pictures. If the correct exposure can not be achieved at the selected shutter speed, aperture will be displayed in red when the shutter button is pressed halfway. Adjust shutter speed until the correct exposure can be achieved.

Caution

If the subject is outside the metering range of the camera, the shutter speed and aperture displays will show “---”. Press the shutter button halfway to measure exposure again.

A: APERTURE PRIORITY AE

In this mode, you choose the aperture while the camera adjusts shutter speed for optimal exposure.

- 1** Rotate the mode dial to **A**.



- 2** Press the  button. Shutter speed and aperture will be displayed.

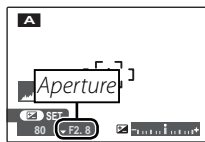

- 3** Press the selector up or down to choose the aperture.



- 4** Take pictures. If the correct exposure can not be achieved at the selected aperture, shutter speed will be displayed in red when the shutter button is pressed halfway. Adjust aperture until the correct exposure can be achieved.

Caution

If the subject is outside the metering range of the camera, the shutter speed and aperture displays will show "----". Press the shutter button halfway to measure exposure again.

M: MANUAL

In this mode, you choose both shutter speed and aperture. If desired, exposure can be altered from the value suggested by the camera.

- 1** Rotate the mode dial to **M**.



- 2** Press the  button. Shutter speed and aperture will be displayed.

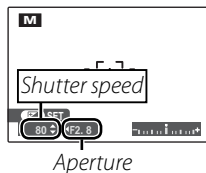

- 3** Press the selector up or down to choose the shutter speed.
- 4** Press the selector left or right to choose the aperture.
- 5** Take pictures.



The Exposure Indicator

The amount the picture will be under- or over-exposed at current settings is shown by the exposure indicator. Pictures taken with the indicator to the left of center (“-”) will be underexposed, pictures taken with the indicator to the right of center (“+”), overexposed.

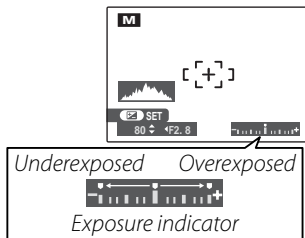

C: CUSTOM MODE

In **P**, **S**, **A**, and **M** modes, the **C** CUSTOM SET option in the shooting menu (pg. 68) can be used

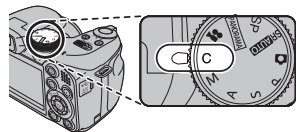

to save current camera and menu settings. These settings are recalled whenever the mode dial is rotated to **C** (custom mode).

Type of menu	Settings can be saved
F-mode menu	ISO ISO, QUALITY QUALITY, FINEPIX COLOR
Shooting menu	PHOTOMETRY , WHITE BALANCE , HIGH-SPEED SHOOTING , FOCUSING , AF MODE , SHARPNESS , FLASH , BRACKETING
Setup menu	IMAGE DISP. , DUAL IS MODE , AF ILLUMINATOR , DIGITAL ZOOM , EVF/LCD MODE
Other	shooting mode (P , S , A , or M), continuous shooting mode, Intelligent Face Detection, instant zoom, macro mode, exposure compensation, flash mode, display type (EVF/LCD), indicators/framing guideline/post-shot assist window

Exposure Compensation

Use exposure compensation when photographing very bright, very dark, or high-contrast subjects.

- 1 Press the  button.**
The exposure indicator will be displayed.

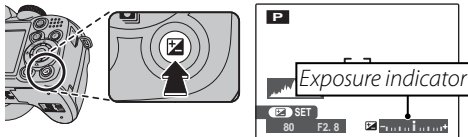

- 2 Choose a value.**
Press the selector left or right. The effect is visible in the display.

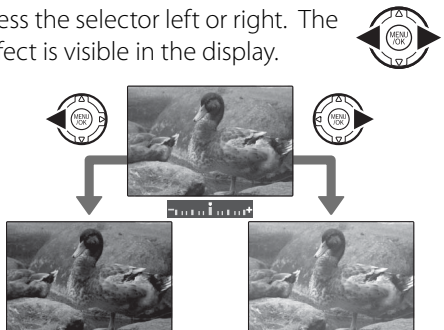

Choose negative values
to reduce exposure
("–" sign turns yellow)

Choose positive values to
increase exposure
("+" sign turns yellow)

- 3 Return to shooting mode.**
Press the  button to return to shooting mode.
- 4 Take pictures.**

Note

A  icon and exposure indicator are displayed at settings other than ± 0 . Exposure compensation is not reset when the camera is turned off; to restore normal exposure control, choose a value of ± 0 .

Choosing an Exposure Compensation Value

- **Backlit subjects:** choose values from $+\frac{2}{3}$ EV to $+1\frac{2}{3}$ EV (for an explanation of the term “EV”, see the Glossary on page 108)
- **Highly reflective subjects or very bright scenes** (e.g., snowfields): +1 EV
- **Scenes that are mostly sky:** +1 EV
- **Spotlit subjects** (particularly if photographed against dark backgrounds): $-\frac{2}{3}$ EV
- **Subjects with low reflectivity** (pine trees or dark-colored foliage): $-\frac{2}{3}$ EV



Playback Options

To view the most recent picture in the monitor, press the  button for about a second.



Press the selector right to view pictures in the order recorded, left to view pictures in reverse order. Keep the selector pressed to scroll rapidly to the desired frame.



Choosing a Display Format

Press the **DISP/BACK** button to cycle through playback display formats as shown below.

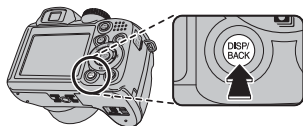

Indicators displayed

Indicators hidden



Sort by date

Note

Pictures taken using other cameras are indicated by a  ("gift image") icon during playback.

Playback Zoom

Select **T** to zoom in on pictures displayed in single-frame playback; select **W** to zoom out. When the picture is zoomed in, the selector can be used to view areas of the image not currently visible in the display.

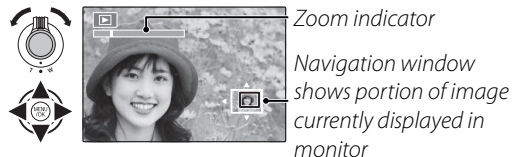



Press **DISP/BACK** to exit zoom.

← Note

The maximum zoom ratio varies with image size. Playback zoom is not available with pictures taken at an image size of **03M**.

● Intelligent Face Detection

Pictures taken with Intelligent Face Detection (pg. 21) are indicated by a  icon. Press the  button to zoom in on the subject selected with Intelligent Face Detection. You can then use the zoom control to zoom in and out.



Viewing Photo Information

To view or hide the photo information listed below in single-frame playback, press .

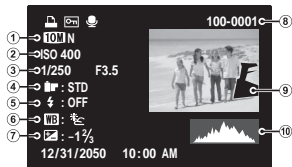
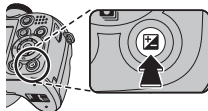

- ① Image quality, ② Sensitivity, ③ Shutter speed/aperture, ④ FinePix color, ⑤ Flash mode, ⑥ White balance, ⑦ Exposure compensation, ⑧ Frame number, ⑨ Picture (overexposed areas blink on and off), ⑩ Histogram

Histograms

Histograms show the distribution of tones in the image. Brightness is shown by the horizontal axis, the number of pixels by the vertical axis.

Optimal exposure: Pixels are distributed in an even curve throughout the tone range.



Overexposed: Pixels are clustered at the right side of the graph.



Underexposed: Pixels are clustered at the left side of the graph.



Multi-Frame Playback

To change the number of images displayed, select **W** when a picture is shown full-frame in the monitor.

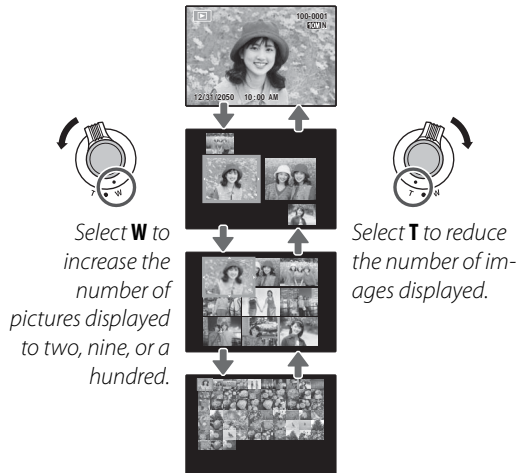

Use the selector to highlight images and press **MENU/OK** to view the highlighted image full frame. In the nine- and hundred-frame displays, press the selector up or down to view more pictures.

Sort by Date

Choose sort-by-date mode to view pictures taken on a selected date.

- 1 Press **DISP/BACK** until the sort-by-date screen is displayed.



- 2 Use the selector up or down to highlight a date. Keep the selector pressed to scroll rapidly to the desired date.



- 3 Press the selector left or right to scroll through the pictures taken on the highlighted date. Keep the selector pressed to scroll rapidly to the desired frame.



Deleting Pictures

The **ERASE** option in the playback menu can be used to delete still pictures and movies, increasing the amount of space available on the memory card or in internal memory (for information on deleting pictures in single-frame playback, see page 20). *Note that deleted pictures can not be recovered. Copy important pictures to a computer or other storage device before proceeding.*

- 1** Press **MENU/OK** to display the playback menu.

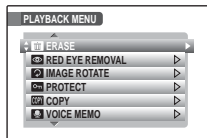

- 2** Press the selector up or down to highlight **ERASE**.



- 3** Press the selector right to display delete options.

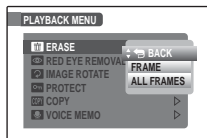

- 4** Press the selector up or down to highlight **FRAME** or **ALL FRAMES**.



- 5** Press **MENU/OK** to display options for the selected item (see following page).



Tips: Deleting Pictures

- When a memory card is inserted, pictures will be deleted from the memory card; otherwise, pictures will be deleted from internal memory.
- Protected pictures can not be deleted. Remove protection from any pictures you wish to delete (pg. 81).
- If a message appears stating that the selected images are part of a DPOF print order, press **MENU/OK** to delete the pictures.

■ FRAME: *Deleting Selected Images*

Selecting **FRAME** displays the dialog shown at right.

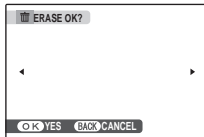

Press the selector left or right to scroll through pictures and press **MENU/OK** to delete the current picture (the picture is deleted immediately; be careful not delete the wrong picture).

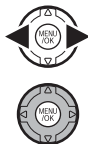

Press **DISP/BACK** to exit when all the desired pictures have been deleted.

■ ALL FRAMES: *Deleting All Images*

Selecting **ALL FRAMES** displays the confirmation shown at right.

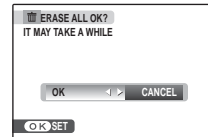

Highlight **OK** and press **MENU/OK** to delete all unprotected pictures.



The dialog shown at right is displayed during deletion. Press **DISP/BACK** to cancel before all pictures have been deleted (any pictures deleted before the button was pressed can not be recovered).

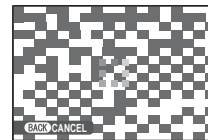

Recording Movies

Shoot short movies at 30 frames per second. Sound is recorded via the built-in microphone; do not cover the microphone during recording.

- 1 Rotate the mode dial to  (movie mode).

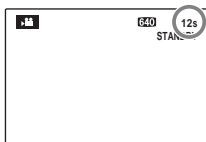

*Time available
is displayed in
monitor*

- 2 Press the **F** button and select a frame size from the **QUALITY** menu (pg. 66). Choose **640** (640×480 pixels) for higher quality or **320** (320×240 pixels) for longer movies. Press **MENU/OK** to exit to movie mode.

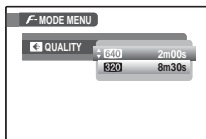

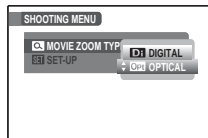

- 3 Press **MENU/OK** to display the shooting menu and select the type of zoom available in movie mode from the **MOVIE ZOOM TYPE** menu. Choose **Opt OPTICAL** to enable optical zoom and allow the camera to continue to focus during recording (note that sounds made by the camera may be recorded). Choose **Df DIGITAL** to enable digital zoom and turn focusing off during recording (note that digital zoom may produce lower quality images than optical zoom). Press **MENU/OK** exit to movie mode.



Note

Image quality and movie zoom options are stored when the camera is turned off or another mode is selected, and are restored when the mode dial is rotated to .

Camera Shake

The effects of camera shake can be reduced by pressing the  button to turn image stabilization on. Regardless of the option selected for  **DUAL IS** in the setup menu, continuous stabilization is used in movie mode. A  icon is displayed when image stabilization is on.

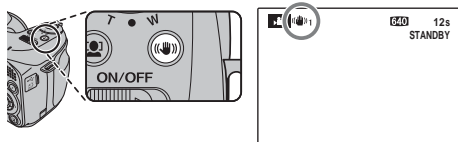

- 4** Press the shutter button all the way down to start recording.

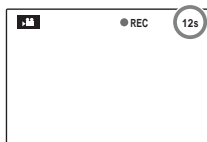

REC and time remaining are displayed in monitor

Note

Exposure and white balance are adjusted automatically throughout recording. The color and brightness of the image may vary from that displayed before recording begins.

Tip

There is no need to keep the shutter button pressed during recording.

- 5** Press the shutter button halfway to end recording. Recording ends automatically when the movie reaches maximum length or memory is full.



Caution

The indicator lamp lights while movies are being recorded. Do not open the battery chamber during shooting or while the indicator lamp is lit. Failure to observe this precaution could prevent the movie from being played back.

Notes

- Other cameras may not be able to display movies recorded with this camera.
- The  **EVF/LCD MODE** option in the setup menu is fixed at **30 fps** in movie mode.

▶ Viewing Movies

During playback (pg. 43), movies are displayed in the monitor as shown at right. The following operations can be performed while a movie is displayed:

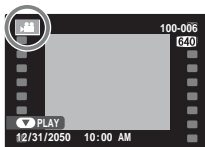

Progress is shown in the monitor during playback.

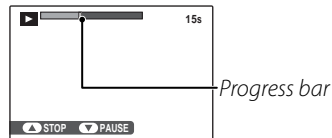

Tip: Viewing Movies on a Computer

Copy movies to the computer before viewing.

⚠ Cautions

- Do not cover the speaker during playback.
- Vertical or horizontal streaks may appear in movies containing very bright subjects. This is normal and does not indicate a malfunction.

Operation	Description
Start/pause playback	Press the selector down to start playback. Press again to pause.
End playback/delete	Press the selector up to end playback. If playback is not in progress, pressing the selector up will delete the current movie.
Advance/rewind	Press the selector right to advance, left to rewind. If playback is paused, the movie will advance or rewind one frame each time the selector is pressed.
Adjust volume	Press MENU/OK to pause playback and display volume controls. Press the selector up or down to adjust the volume; press MENU/OK again to set the volume.

Viewing Pictures on TV

Connect the camera to a TV and tune the television to the video channel to show pictures to a group. The supplied A/V cable connects as shown below. Turn the camera off before connecting the cable.

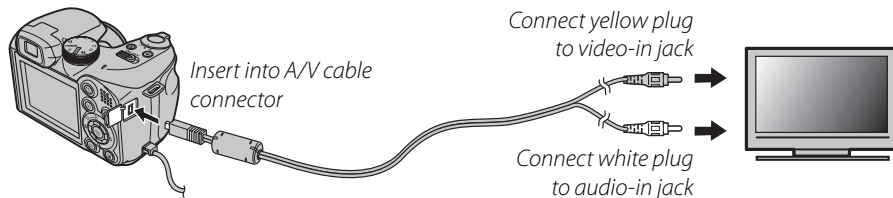

Press  for about a second to turn the camera on. The camera monitor turns off and pictures and movies are played back on the TV. Note that the camera volume controls have no effect on sounds played on the TV; use the television volume controls to adjust the volume.

Note

Image quality drops during movie playback.

Caution

When connecting the cable, be sure the connectors are fully inserted.

Printing Pictures via USB

If the printer supports PictBridge, the camera can be connected directly to the printer and pictures can be printed without first being copied to a computer. Note that depending on the printer, not all the functions described below may be supported.



Connecting the Camera

- 1 Connect the supplied USB cable as shown and turn the printer on.

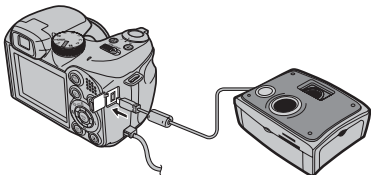

- 2 Press the button for about a second to turn the camera on. **USB** will be displayed in the monitor, followed by the PictBridge display shown below at right.

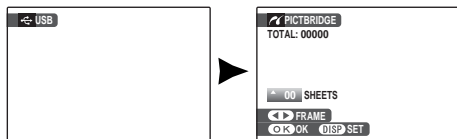

Printing Selected Pictures

- 1 Press the selector left or right to display a picture you wish to print.
- 2 Press the selector up or down to choose the number of copies (up to 99).
- 3 Repeat steps 1–2 to select additional pictures. Press **MENU/OK** to display a confirmation dialog when settings are complete.

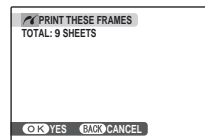

- 4 Press **MENU/OK** to start printing.



Tip: Printing the Date of Recording

To print the date of recording on pictures, press **DISP/BACK** in steps 1–2 to display the PictBridge menu (see “Printing the DPOF Print Order,” below). Press the selector up or down to highlight **PRINT WITH DATE**  and press **MENU/OK** to return to the PictBridge display (to print pictures without the date of recording, select **PRINT WITHOUT DATE**). To ensure that the date is correct, set the camera clock before taking pictures.

Note

If no pictures are selected when the **MENU/OK** button is pressed, the camera will print one copy of the current picture.

Printing the DPOF Print Order

To print the print order created with  **PRINT ORDER (DPOF)** in the playback **F-MODE** menu (pg. 77):

- 1 In the PictBridge display, press **DISP/BACK** to open the PictBridge menu.

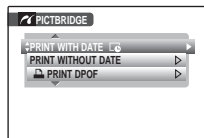

- 2 Press the selector up or down to highlight  **PRINT DPOF**.



- 3 Press **MENU/OK** to display a confirmation dialog.

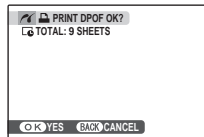



4 Press **MENU/OK** to start printing.

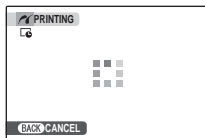

● **During Printing**

The message shown at right is displayed during printing. Press **DISP/BACK** to cancel before all pictures are printed (depending on the printer, printing may end before the current picture has printed).



If printing is interrupted, press  to turn the camera off and then on again.

● **Disconnecting the Camera**

Confirm that "PRINTING" is not displayed in the monitor and turn the camera off. Disconnect the USB cable.

← **Notes**

- Print pictures from internal memory or a memory card that has been formatted in the camera.
- If the printer does not support date printing, the **PRINT WITH DATE**  option will not be available in the PictBridge menu and the date will not be printed on the pictures in the DPOF print order.
- Default printer page size and print quality settings are used when printing via direct USB connection.

Creating a DPOF Print Order

The **PRINT ORDER (DPOF)** option in the playback **F-MODE** menu can be used to create a digital “print order” for PictBridge-compatible printers (pg. 54) or devices that support DPOF.

DPOF

DPOF (Digital Print Order Format) is standard that allows pictures to be printed from “print orders” stored in internal memory or on a memory card. The information in the order includes the pictures to be printed and the number of copies of each picture.



WITH DATE / WITHOUT DATE

To modify the DPOF print order, select **PRINT ORDER (DPOF)** in the playback **F-MODE** menu and press the selector up or down to highlight **WITH DATE ** or **WITHOUT DATE**.

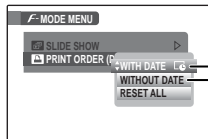

WITH DATE : Print date of recording on pictures.

WITHOUT DATE: Print pictures without date.

Press **MENU/OK** and follow the steps below.

- 1 Press the selector left or right to display a picture you wish to include in or remove from the print order.



- 2 Press the selector up or down to choose the number of copies (up to 99). To remove a picture from the order, press the selector down until the number of copies is 0.

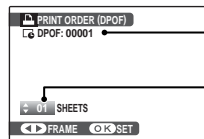

Total number of prints

Number of copies

- 3 Repeat steps 1–2 to complete the print order. Press **MENU/OK** to save the print order when settings are complete, or **DISP/BACK** to exit without changing the print order.



- 4** The total number of prints is displayed in the monitor. Press **MENU/OK** to exit.



The pictures in the current print order are indicated by a  icon during playback.



■ RESET ALL

To cancel the current print order, select **RESET ALL** in the  **PRINT ORDER (DPOF)** menu. The confirmation shown at right will be displayed; press **MENU/OK** to remove all pictures from the order.

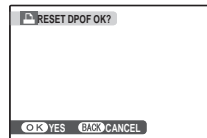

← Notes

- Remove the memory card to create or modify a print order for the pictures in internal memory.
- Print orders can contain a maximum of 999 pictures.
- If a memory card is inserted containing a print order created by another camera, the message shown at right will be displayed. Pressing **MENU/OK** cancels the print order; a new print order must be created as described above.

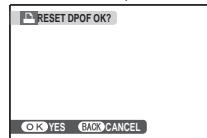

Viewing Pictures on a Computer

The supplied FinePixViewer software can be used to copy pictures to a computer, where they can be stored, viewed, organized, and printed. Before proceeding, install FinePixViewer as described below. *Do NOT connect the camera to the computer until installation is complete.*

Installing FinePixViewer

FinePixViewer is available in Windows and Macintosh versions. Installation instructions for Windows are on pages 58–59, those for the Macintosh on pages 60–61.

Installing FinePixViewer: Windows

1 Confirm that the computer meets the following system requirements:

OS	Preinstalled versions of Windows Vista, Windows XP Home Edition (Service Pack 2), Windows XP Professional (Service Pack 2), or Windows 2000 Professional (Service Pack 4)
CPU	<ul style="list-style-type: none">• Windows Vista: 800 MHz Pentium 4 or better (3 GHz Pentium 4 or better recommended)• Windows XP: 800 MHz Pentium 4 or better (2 GHz Pentium 4 or better recommended)• Windows 2000: 200 MHz Pentium or better
RAM	<ul style="list-style-type: none">• Windows Vista: 512 MB or more (1 GB or more recommended)• Windows XP: 512 MB or more• Windows 2000: 128 MB or more
Free disk space	A minimum of 450 MB required for installation with 600 MB available when FinePixViewer is running (15 GB or more recommended under Windows Vista, 2 GB or more recommended under Windows XP)
Video	800 × 600 pixels or more with 16-bit color or better (1,024 × 768 pixels or more with 32-bit color recommended)
Other	<ul style="list-style-type: none">• Built-in USB port recommended. Operation is not guaranteed other USB ports.• Internet connection (56 kbps or faster recommended) required to use FinePix Internet Service; Internet connection and e-mail software required to use e-mail option.

Caution

Other versions of Windows are not supported. Operation is not guaranteed on home-built computers or computers that have been upgraded from earlier versions of Windows.

- 2 Start the computer. Log in to an account with administrator privileges before proceeding.
- 3 Exit any applications that may be running and insert the installer CD in a CD-ROM drive.

Windows Vista

If an AutoPlay dialog is displayed, click **SETUP.exe**. A “User Account Control” dialog will then be displayed; click **Allow**.

The installer will start automatically; click **Installing FinePixViewer** and follow the on-screen instructions to install FinePixViewer. Note that the Windows CD may be required during installation.

If the Installer Does Not Start Automatically

If the installer does not start automatically, select **Computer** or **My Computer** from the Start menu (Windows Vista/XP) or double-click the **My Computer** icon on the desktop (Windows 2000), then double-click the **FINEPIX** CD icon to open the FINEPIX CD window and double-click **SETUP** or **SETUP.exe**.

- 4 If prompted to install Windows Media Player, QuickTime, or DirectX, follow the on-screen instructions to complete installation.
- 5 When prompted, remove the installer CD from the CD-ROM drive and click **Restart** to restart the computer. Store the installer CD in a dry location out of direct sunlight in case you need to re-install the software. The version number is printed at the top of the CD label for reference when updating the software or contacting customer support.

Installation is now complete. Proceed to “Connecting the Camera” on page 62.

Installing FinePixViewer: Macintosh

1 Confirm that the computer meets the following system requirements:

CPU	PowerPC or Intel
OS	Pre-installed versions of Mac OS X version 10.3.9–10.4 (for the latest information, visit http://www.fujifilm.com/)
RAM	256 MB or more
Free disk space	A minimum of 200 MB required for installation with 400 MB available when FinePixViewer is running
Video	800 × 600 pixels or more with thousands of colors or better
Other	<ul style="list-style-type: none"> • Built-in USB port recommended. Operation is not guaranteed other USB ports. • Internet connection (56 kbps or faster recommended) required to use FinePix Internet Service; Internet connection and e-mail software required to use e-mail option.

2 After starting the computer and quitting any applications that may be running, insert the installer CD in a CD-ROM drive. Double-click the **FinePix CD** icon on the desktop and double-click **Installer for Mac OS X**.

3 An installer dialog will be displayed; click **Installing FinePixViewer** to start installation. Enter an administrator name and password when prompted and click **OK**, then follow the on-screen instructions to install FinePixViewer. Click **Exit** to quit the installer when installation is complete.

- 4** Remove the installer CD from the CD-ROM drive. Note that you may be unable to remove the CD if Safari is running; if necessary, quit Safari before removing the CD. Store the installer CD in a dry location out of direct sunlight in case you need to re-install the software. The version number is printed at the top of the CD label for reference when updating the software or contacting customer support.
- 5** Select **Applications** in the Finder **Go** menu to open the applications folder. Double-click the **Image Capture** icon and select **Preferences...** from the Image Capture application menu.

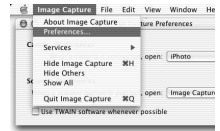

The Image Capture preferences dialog will be displayed. Choose **Other...** in the **When a camera is connected, open** menu, then select **FPVBridge** in the "Applications/FinePixViewer" folder and click **Open**.

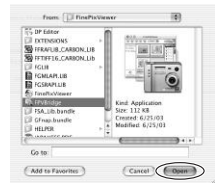

Select **Quit Image Capture** from the Image Capture application menu.

Installation is now complete. Proceed to "Connecting the Camera" on page 62.

Connecting the Camera

1 If the pictures you wish to copy are stored on a memory card, insert the card into the camera (pg. 11). If no card is inserted, pictures will be copied from internal memory.

⚠ Caution

Loss of power during transfer could result in loss of data or damage to internal memory or the memory card. Charge the battery before connecting the camera.

2 Turn the camera off and connect the supplied USB cable as shown, making sure the connectors are fully inserted. Connect the camera directly to the computer; do not use a USB hub or keyboard.

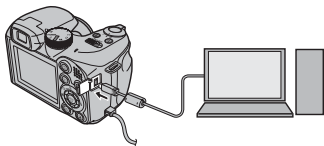

3 Press the **▶** button for about a second to turn the camera on. FinePixViewer will start automatically and the “Save Image Wizard” will be displayed. Follow the on-screen instructions to copy pictures to the computer. To exit without copying pictures, click **Cancel**.

⚠ Caution

If FinePixViewer does not start automatically, the software may not be correctly installed. Disconnect the camera and reinstall the software.

For more information on using FinePixViewer, select **How to Use FinePixViewer** in the FinePixViewer **Help** menu.

← Note

The camera will not turn off automatically while connected to a computer.

Cautions

- Use only memory cards that have been formatted in the camera and contain pictures taken with the camera. If a memory card containing a large number of images is inserted, there may be a delay before FinePixViewer starts and FinePixViewer may be unable to import or save images. Use a memory card reader to transfer pictures.
- Make sure the indicator lamp is out before turning the camera off or disconnecting the USB cable. Failure to observe this precaution could result in loss of data or damage to internal memory or the memory card.
- Disconnect the camera before inserting or removing memory cards.
- Use FinePixViewer to copy voice memos.
- In some cases, it may not be possible to access pictures saved to a network server using FinePixViewer in the same way as on a standalone computer.
- The user bears all applicable fees charged by the phone company or Internet service provider when using services that require an Internet connection.

Disconnecting the Camera

After confirming that the indicator lamp is out, follow the on-screen instructions to turn the camera off and disconnect the USB cable.

Updating FinePixViewer

The latest version of FinePixViewer can be downloaded from <http://www.fujifilm.com/>.

Uninstalling FinePixViewer

Only uninstall FinePixViewer before reinstalling the software or when it is no longer required. After quitting FinePixViewer and disconnecting the camera, drag the “FinePixViewer” folder from “Applications” into the Trash and select **Empty Trash** in the **Finder** menu (Macintosh), or open the control panel and use “Programs and Features” (Windows Vista) or “Add or Remove Programs” (other versions of Windows) to uninstall FinePixViewer, FinePix Resource, and FinePix Studio. Under Windows, one or more confirmation dialogs may be displayed; read the contents carefully before clicking **OK**.

Using the Menus: Shooting Mode

The **F**-mode and shooting menu contain settings for a wide range of shooting conditions.

Using the **F**-Mode Menu

- 1 Press the **F** button to display the **F-MODE** menu.

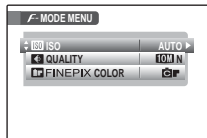

- 2 Press the selector up or down to highlight the desired menu item.



- 3 Press the selector right to display options for the highlighted item.

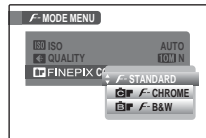

- 4 Press the selector up or down to highlight the desired option.



- 5 Press **MENU/OK** to select the highlighted option.



F-Mode Menu Options

Menu item	Description	Options	Default
ISO ISO	Adjust ISO sensitivity. Choose higher values when the subject is poorly lit.	AUTO / AUTO (800) / AUTO (400) / 6400 (3M) / 3200 (3M) / 1600 / 800 / 400 / 200 / 100 / 64	AUTO
QUALITY	Choose image size and quality (pg. 66).	10M F / 10M N / 9M 3:2 / 5M / 3M / 2M / 03M	10M N
FINEPIX COLOR	Shoot pictures in standard or saturated color or in black-and-white (pg. 67).	F-STANDARD / c / B	F-STANDARD

ISO ISO

Control the camera's sensitivity to light. Higher values can be used to reduce blur when lighting is poor; note, however, that mottling may appear in pictures taken at high sensitivities, particularly at settings of **3200 (3M)** and **6400 (3M)**. If **AUTO**, **AUTO (800)**, or **AUTO (400)** is selected, the camera will adjust sensitivity automatically in response to shooting conditions. The maximum values that will be selected by the camera at settings of **AUTO (800)** and **AUTO (400)** are 800 and 400 respectively. At settings of **3200 (3M)** and **6400 (3M)**, image sizes larger than **3M** (pg. 66) are automatically set to **3M**. Settings that have been altered from the value selected by the user are displayed in yellow. The previous image quality will be restored when another sensitivity is selected.

Settings other than **AUTO** are shown by an icon in the display.

Note

Sensitivity is not reset when the camera is turned off or another shooting mode is selected.

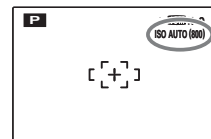

QUALITY

Choose the size and quality at which still pictures are recorded. Large pictures can be printed at large sizes with no drop in quality; small pictures require less memory, allowing more pictures to be recorded.

Option	Prints at sizes up to
10M F (3,648 × 2,736)	31 × 23 cm (12 × 9 in.). Choose 10M F for high-quality prints.
10M N (3,648 × 2,736)	
9M 3:2 (3,648 × 2,432)	31 × 21 cm (12 × 8 in.). Aspect ratio is 3:2.
5M (2,592 × 1,944)	22 × 16 cm (8.5 × 6.5 in.)
3M (2,048 × 1,536)	17 × 13 cm (7 × 5 in.)
2M (1,600 × 1,200)	14 × 10 cm (5.3 × 4 in.)
03M (640 × 480)	5 × 4 cm (2 × 1.5 in.). Suited to e-mail or the web.

The number of pictures that can be taken at current settings (pg. 109) is shown to the right of the image quality icon in the display.

Aspect Ratio

Pictures taken at an image quality setting of **9M 3:2** have an aspect ratio of 3:2, the same as a frame of 35-mm film. Pictures taken at other settings have an aspect ratio of 4:3.



4:3





3:2

Notes

- Image quality is not reset when the camera is turned off or another shooting mode is selected.
- Sensitivity (pg. 65) is automatically lowered at high qualities; settings that have been altered from the value selected by the user are shown in yellow. The previous sensitivity will be restored when another image quality option is selected.



FINEPIX COLOR

Enhance contrast and color saturation or take pictures in black and white.

Option	Description
F-STANDARD	Standard contrast and saturation. Recommended in most situations.
 F-CHROME	Vivid contrast and color. Choose for vivid shots of flowers or enhanced greens and blues in landscapes.
 F-B&W	Take pictures in black and white.

Settings other than **F-STANDARD** are shown by an icon in the display.

Notes

- **FINEPIX COLOR** is not reset when the camera is turned off or another shooting mode is selected.
- The effects of  **F-CHROME** vary from scene to scene and may be difficult to discern with some subjects. Depending on the subject, the effects of  **F-CHROME** may not be visible in the display.

Using the Shooting Menu

- 1 Press **MENU/OK** to display the shooting menu.

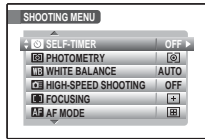

← Note

The options displayed in the shooting menu vary depending on the shooting mode.

- 2 Press the selector up or down to highlight the desired menu item.



- 3 Press the selector right to display options for the highlighted item.

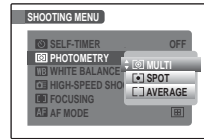

- 4 Press the selector up or down to highlight the desired option.



- 5 Press **MENU/OK** to select the highlighted option.



SELF-TIMER

Choose the duration for the self-timer. The self-timer is available in all shooting modes.

- **10SEC:** Choose for self-portraits or for group portraits that include the photographer.
- **2SEC:** Choose to avoid blur caused by the camera moving when the shutter button is pressed.
- **OFF:** Self-timer off.

To use the self-timer, choose **10SEC** or **2SEC** from the self-timer menu and follow the steps below.

1 Focus.

Press the shutter button halfway to focus.



Caution

Stand behind the camera when using the shutter button. Standing in front of the lens can interfere with focus and exposure.

2 Start the timer.

Press the shutter button the rest of the way down to start the timer. The display shows the number of seconds remaining until the shutter is released. To stop the timer before the picture is taken, press **DISP/BACK**.

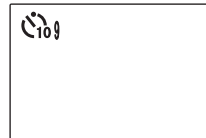

The self-timer lamp on the front of the camera will blink immediately before the picture is taken. If the two-second timer is selected, the self-timer lamp will blink as the timer counts down.

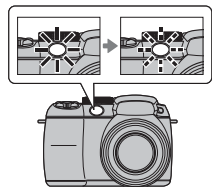

Intelligent Face Detection



Because it ensures that the faces of portrait subjects will be in focus, Intelligent Face Detection (pg. 22) is recommended when using the self-timer for group portraits or self-portraits. To use the self-timer with Intelligent Face Detection, select **10SEC** or **2SEC** in the self-timer menu and then press the shutter button all the way down to start the timer. The camera will detect faces while the timer is counting down and adjust focus and exposure immediately before the shutter is released. Be careful not to move until the picture has been recorded.

Note

The self-timer turns off automatically when the picture is taken, a different shooting mode is selected, playback mode is selected, or the camera is turned off.







PHOTOMETRY

Choose how the camera meters exposure when Intelligent Face Detection is off.

-  **MULTI:** Automatic scene recognition is used to adjust exposure for a wide range of shooting conditions.
-  **SPOT:** The camera meters lighting conditions at the center of the frame. Recommended when the background is much brighter or darker than the main subject. Can be used with focus lock (pg. 23) to meter off-center subjects.
-  **AVERAGE:** Exposure is set to the average for the entire frame. Provides consistent exposure across multiple shots with the same lighting, and is particularly effective for landscapes and portraits of subjects dressed in black or white.

WB WHITE BALANCE

For natural colors, choose a setting that matches the light source (for an explanation of “white balance,” see the Glossary on page 108).

Option	Description
AUTO	White balance adjusted automatically.
	Measure a value for white balance.
	For subjects in direct sunlight.
	For subjects in the shade.
	Use under “daylight” fluorescent lights.
	Use under “warm white” fluorescent lights.
	Use under “cool white” fluorescent lights.
	Use under incandescent lighting.

If **AUTO** does not produce the desired results (for example, when taking close-ups), select  and measure a value for white balance or choose the option that matches the light source.

← Notes

- At settings other than , auto white balance is used with the flash. Lower the flash (pg. 26) to take pictures at other settings.
- Results vary with shooting conditions. Play pictures back after shooting to check colors in the monitor.

■ : Custom White Balance

Choose  to adjust white balance for unusual lighting conditions. The options at right will be displayed; frame a white object so that it fills the monitor and press the shutter button all the way down to measure white balance.

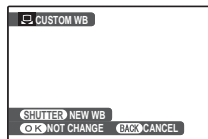

If **“COMPLETED!”** is displayed, press **MENU/OK** to set white balance to the measured value. This value is stored even when the battery is removed and can be reselected by pressing **MENU/OK** when custom white balance options are displayed.

If **“UNDER”** is displayed, raise exposure compensation (pg. 41) and try again.

If **“OVER”** is displayed, lower exposure compensation and try again.

 Tip

To give a deliberate color cast to your photographs, measure a value for custom white balance using a colored instead of a white object.

HIGH-SPEED SHOOTING



Selecting **ON** reduces focusing time, ensuring a quick shutter response.

Notes

- Choosing **ON** increases the drain on the battery. Choose **OFF** to save battery power.
- The  **EVF/LCD MODE** option in the setup menu is automatically set to **60 fps** when high-speed shooting is on (pg. 88).



FOCUSING

Choose how the camera focuses.

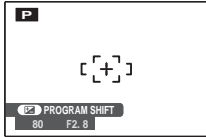

-  **CONTINUOUS AF**: The camera continually adjusts focus to reflect changes in the distance to the subject while the shutter button is pressed halfway (note that this increases the drain on the battery). Intelligent Face Detection turns off automatically and **AF AF MODE** is fixed at  **CENTER**. Choose for moving subjects.
-  **SINGLE AF**: Focus locks while the shutter button is pressed halfway. Choose for stationary subjects.

AF AF MODE

This option controls how the camera selects the focus area when Intelligent Face Detection is off (pg. 22). Regardless of the option selected, the camera will focus on the subject in the center of the monitor when macro mode is on (pg. 25).

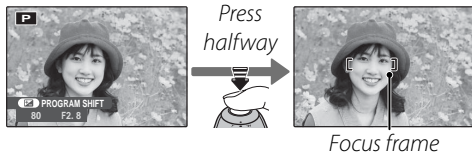
-  **CENTER:** The camera focuses on the subject in the center of the frame. This option can be used with focus lock.
 
-  **MULTI:** When the shutter button is pressed halfway, the camera detects high-contrast subjects near the center of the frame and selects the focus area automatically (if the focus frame is not displayed, select  **CENTER** and use focus lock; pg. 23).

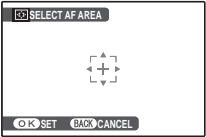

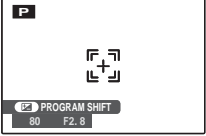
-  **AREA:** The focus position can be chosen manually by pressing the selector up, down, left, or right and pressing **MENU/OK** when the focus brackets are in the desired position. Choose for precise focus when the camera is mounted on a tripod. Note that exposure is set for the subject in the center of the frame; to meter an off-center subject, use AF/AE lock (pg. 23).
 
-  **TRACKING:** Position the subject in the center focus area and press the shutter button halfway to focus. Keep the shutter button pressed to track the subject as it moves through the frame. Choose for erratically moving subjects.
 

SHARPNESS

Choose whether to sharpen or soften outlines.

- **HARD:** Use for sharp outlines when photographing such subjects as buildings and text.
- **STANDARD:** Standard sharpness. Best choice in most situations.
- **SOFT:** Use for soft outlines in portraits and similar subjects.

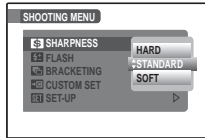

FLASH

Adjust flash brightness. Choose from values between $+\frac{2}{3}$ EV and $-\frac{2}{3}$ EV. The default setting is ± 0 . Note that the desired results may not be achieved depending on shooting conditions and the distance to the subject.

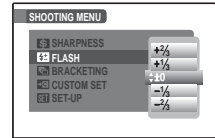

BRACKETING

Choose the size of the exposure bracketing increment used when  (bracketing) is selected in continuous shooting mode. Choose from increments of $\pm\frac{1}{3}$ EV, $\pm\frac{2}{3}$ EV, and ± 1 EV (for an explanation of the term "EV," see the Glossary on page 108).

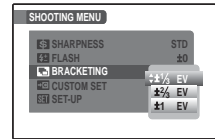

Using the Menus: Playback Mode

The **F-MODE** and playback menus are used to manage the pictures in internal memory or on the memory card.

Using the **F-Mode** Menu

1 Press the  button for about a second to enter playback mode (pg. 43).



2 Press the **F** button to display the **F-MODE** menu.

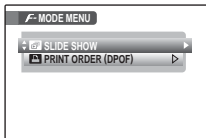

3 Press the selector up or down to highlight the desired menu item.



4 Press the selector right to display options for the highlighted item.

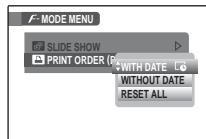



5 Press the selector up or down to highlight the desired option.



6 Press **MENU/OK** to select the highlighted option.





F-Mode Menu Options

Option	Description
 SLIDE SHOW	View pictures in a slide show (pg. 77).
 PRINT ORDER (DPOF)	Select pictures for printing on DPOF- and PictBridge-compatible devices (pg. 54).

SLIDE SHOW

View pictures in an automated slide show. Choose the type of show and press **MENU/OK** to start. Press **DISP/BACK** at any time during the show to view on-screen help. When a movie is displayed, movie playback will begin automatically, and the slide show will continue when the movie ends. The show can be ended at any time by pressing **MENU/OK**.

Option	Displayed in
NORMAL	Press selector left or right to go back or skip ahead one frame. Select FADE-IN for fade transitions between frames.
FADE-IN	
NORMAL 	As above, except that camera automatically zooms in on faces selected with Intelligent Face detection.
FADE-IN 	
MULTIPLE	Display several pictures at once.
CLOCK	A slide show with a changing pattern of dots that counts off the seconds in the top left corner of the display.

Note

The camera will not turn off automatically while a slide show is in progress.

Using the Playback Menu

1 Press  to enter playback mode (pg. 43).



2 Press **MENU/OK** to display the playback menu.

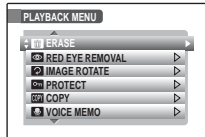

3 Press the selector up or down to highlight the desired menu item.



4 Press the selector right to display options for the highlighted item.

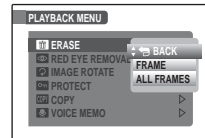

5 Press the selector up or down to highlight the desired option.



6 Press **MENU/OK** to select the highlighted option.



Playback Menu Options

The following options are available:

Option	Description
ERASE	Delete all or selected pictures (pg. 47).
RED-EYE REMOVAL	Create copies with reduced red eye (pg. 79).
IMAGE ROTATE	Rotate pictures (pg. 80).
PROTECT	Protect pictures from accidental deletion (pg. 81).
COPY	Copy pictures between internal memory and a memory card (pg. 82).
VOICE MEMO	Add voice memos to pictures (pg. 84).
TRIMMING	Create cropped copies of pictures (pg. 86).
SET-UP	Perform basic camera setup (pg. 87).

RED EYE REMOVAL

If the current picture is marked with a icon to indicate that it was taken with Intelligent Face Detection, this option can be used to remove red-eye. The camera will analyze the image; if red-eye is detected, the image will be processed to create a copy with reduced red-eye.

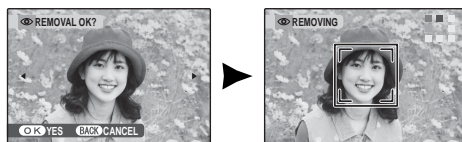

Notes

- Red eye may not be removed if the camera is unable to detect a face or the face is in profile. Results may differ depending on the scene. Red eye can not be removed from pictures that have already been processed using red-eye removal or pictures created with other devices.
- The amount of time needed to process the image varies with the number of faces detected.
- Copies created with **RED EYE REMOVAL** are indicated by a icon during playback.

🔍 IMAGE ROTATE

By default, pictures taken in tall orientation are displayed in wide orientation. Use this option to display pictures in the correct orientation in the monitor. It has no effect on pictures displayed on a computer or other device.

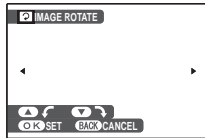

👉 Notes

- Protected pictures can not be rotated. Remove protection before rotating pictures (pg. 81).
- The camera may not be able to rotate pictures created with other devices.

To rotate a picture, play the picture back and select **🔍 IMAGE ROTATE** in the playback menu (pg. 78).

- 1 Press the selector down to rotate the picture 90° clockwise, up to rotate the picture 90° counterclockwise.



- 2 Press **MENU/OK** to confirm the operation (to exit without rotating the picture, press **DISP/BACK**).



The next time the picture is played back, it will automatically be rotated.

PROTECT

Protect pictures from accidental deletion. The following options are available.

FRAME

Protect selected pictures.

- 1 Press the selector left or right to display the desired picture.

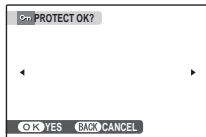

Picture not protected

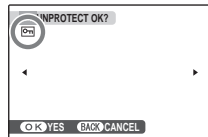

Protected picture

- 2 Press **MENU/OK** to protect the picture. If the picture is already protected, pressing **MENU/OK** will remove protection from the image.



- 3 Repeat steps 1–2 to protect additional images. Press **DISP/BACK** to exit when the operation is complete.



SET ALL

Press **MENU/OK** to protect all pictures, or press **DISP/BACK** to exit without changing picture status.

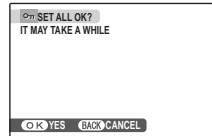

RESET ALL

Press **MENU/OK** to remove protection from all pictures, or press **DISP/BACK** to exit without changing picture status.



If the number of pictures affected is very large, the display at right will appear in the monitor while the operation is in progress. Press **DISP/BACK** to exit before the operation is complete.



Caution

Protected pictures will be deleted when the memory card or internal memory is formatted (pg. 92).

COPY COPY

Copy pictures between internal memory and a memory card.

- 1 Press the selector up or down to highlight **INTERNAL MEMORY** → **SD CARD** (copy pictures from internal memory to the memory card) or **SD CARD** → **INTERNAL MEMORY** (copy pictures from a memory card to internal memory).



- 2 Press the selector right to display options for the highlighted item.

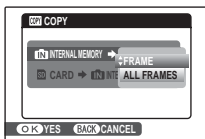

- 3 Press the selector up or down to highlight **FRAME** or **ALL FRAMES**.



- 4 Press **MENU/OK**.



Tip: Copying Pictures Between Memory Cards

To copy pictures between two memory cards, insert the source card and copy the pictures to internal memory, then remove the source card, insert the destination card, and copy the pictures from internal memory.

■ FRAME

Copy selected frames.

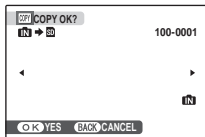

1 Press the selector left or right to display the desired picture.



2 Press **MENU/OK** to copy the picture.



3 Repeat steps 1–2 to copy additional images. Press **DISP/BACK** to exit when the operation is complete.



■ ALL FRAMES

Press **MENU/OK** to copy all pictures, or press **DISP/BACK** to exit without copying pictures.

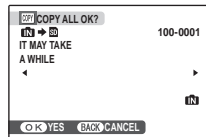

⚠ Cautions

- Copying ends when the destination is full.
- DPOF print information is not copied (pg. 54).

VOICE MEMO

To add a voice memo to a still picture, select  **VOICE MEMO** after displaying the picture in playback mode.

Note

Voice memos can not be added to movies or protected pictures. Remove protection from pictures before recording voice memos (pg. 81).

- 1 Hold the camera at a distance of about 20 cm (8 in.) and face the microphone.

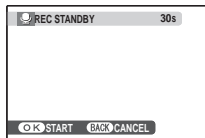

- 2 Press **MENU/OK** to start recording.

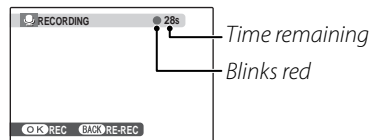

- 3 Press **MENU/OK** again to end recording. Recording ends automatically after 30 seconds.

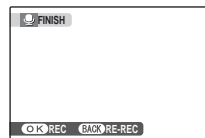

Notes

- If a voice memo already exists for the current picture, the options at right will be displayed. Select **RE-REC** to replace the existing memo.
- Voice memos are recorded as PCM-format WAV files (pg. 108).

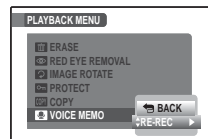

Playing Voice Memos

Pictures with voice memos are indicated by a  icon during playback. To play the voice memo, press the selector down. To pause, press the selector down again; to end playback, press the selector up. Press the selector left to rewind, right to fast forward. Volume controls can be displayed by pressing the **MENU/OK** button; press the selector up or down to adjust the volume, and press **MENU/OK** again to resume playback.

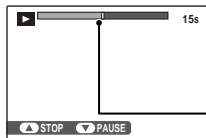

Progress is shown in the monitor.

Progress bar

Note

The camera may not play voice memos recorded with other devices.

Caution

Do not cover the speaker during playback.

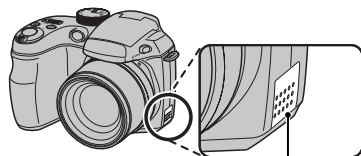

Speaker

TRIMMING

To create a cropped copy of a picture, play the picture back and select **TRIMMING** in the playback menu (pg. 78).

- Use the zoom control to zoom in and out and use the selector to scroll the picture until the desired portion is displayed (to exit to single-frame playback without creating a cropped copy, press **DISP/BACK**).

Zoom indicator

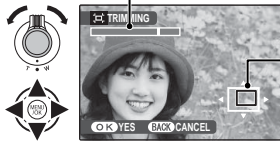

Navigation window shows portion of image currently displayed in monitor

If the size of the final copy will be **03M**, **OK** will be displayed in yellow.

Tip: Intelligent Face Detection

If the picture was shot with Intelligent Face Detection (pg. 22), **IFD** will be displayed in the monitor. Press the **IFD** button to zoom in on the selected face.



- Press **MENU/OK**. A confirmation dialog will be displayed.

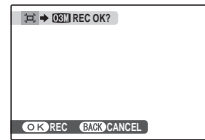

Copy size (**5M**, **3M**, **2M**, or **03M**; see page 66) is shown at the top. Larger crops produce larger copies; all copies have an aspect ratio of 4:3.

- Press **MENU/OK** to save the cropped copy to a separate file.



The Setup Menu

Using the Setup Menu

1 Display the setup menu.

1.1 Press **MENU/OK** to display the menu for the current mode.



1.2 Press the selector up or down to highlight **SET SET-UP**.



1.3 Press the selector right to display the setup menu.

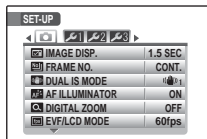

2 Choose a page.

2.1 Press the selector left or right to choose a page.



2.2 Press the selector down to enter the menu.



3 Adjust settings.

3.1 Press the selector up or down to highlight a menu item.



3.2 Press the selector right to display options for the highlighted item.

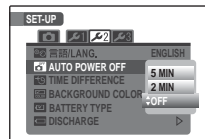

































3.3 Press the selector up or down to highlight an option.



3.4 Press **MENU/OK** to select the highlighted option.



Setup Menu Options

	Menu item	Description	Options	Default
	 IMAGE DISP.	Choose how long pictures are displayed after shooting (pg. 89).	CONTINUOUS / 3 SEC / 1.5 SEC / ZOOM (CONTINUOUS) / OFF	1.5 SEC
	 FRAME NO.	Choose how files are named (pg. 90).	CONTINUOUS / RENEW	CONTINUOUS
	 DUAL IS MODE	Choose when image stabilization is performed (pg. 90).	 1 CONTINUOUS /  2 SHOOTING ONLY	 1
	 AF ILLUMINATOR	Turn the AF-assist illuminator on or off (pg. 24).	ON / OFF	ON
	 DIGITAL ZOOM	Enable or disable digital zoom (pg. 91).	ON / OFF	OFF
	 EVF/LCD MODE	Choose 30 fps to increase battery life, 60 fps for improved display quality.	30 fps / 60 fps	30 fps
	 DATE/TIME	Set the camera clock (pg. 14).	—	—
	 OPERATION VOL.	Adjust the volume of camera controls.	 1 (high) /  1 (mid) /	 1
	 SHUTTER VOLUME	Adjust the volume of the shutter sound.	 1 (low) /  OFF (mute)	 1
	 PLAYBACK VOLUME	Adjust the volume for movie and voice memo playback (pg. 91).	—	7
	 LCD BRIGHTNESS	Control the brightness of the display (pg. 91).	-5 - +5	0
	 FORMAT	Format internal memory or memory cards (pg. 92).	—	—
	 言語/LANG.	Choose a language (pg. 14).	See page 112	ENGLISH
	 AUTO POWER OFF	Choose the auto power off delay (pg. 92).	5 MIN / 2 MIN / OFF	2 MIN
	 TIME DIFFERENCE	Set the clock to local time (pg. 93).	 / 	
	 BACKGROUND COLOR	Choose a color scheme.	—	—
	 BATTERY TYPE	Specify the type of battery used in the camera (pg. 9).	ALKALINE / NI-MH / LITHIUM	ALKALINE
	 DISCHARGE	Discharge rechargeable Ni-MH batteries (pg. 94).	—	—





Menu item	Description	Options	Default
 VIDEO SYSTEM	Choose a video mode for connection to a TV (pg. 52).	NTSC/PAL	—
 RESET	Reset all settings except DATE/TIME , TIME DIFFERENCE , BACKGROUND COLOR , BATTERY TYPE , and VIDEO SYSTEM to default values. A confirmation dialog will be displayed, press the selector left or right to highlight OK and press MENU/OK .	—	—
 CUSTOM RESET	Reset all settings for mode C . A confirmation dialog will be displayed, press the selector left or right to highlight OK and press MENU/OK .	—	—

IMAGE DISP.

Choose an option other than **OFF** to display pictures in the monitor after shooting. Pictures can be displayed for 1.5 s (**1.5 SEC**), 3 s (**3 SEC**), or until the **MENU/OK** button is pressed (**CONTINUOUS** and **ZOOM (CONTINUOUS)**). If **CONTINUOUS** is selected, the  button can be used to check exposure (pg. 45). If **ZOOM (CONTINUOUS)** is selected, photos taken at qualities larger than **03M** can be zoomed in to check focus and other fine details (see page 44). Note that **ZOOM (CONTINUOUS)** is disabled in continuous shooting mode (pg. 28), and that the colors displayed at settings of **1.5 SEC** and **3 SEC** may differ from those in the final picture.

Note

Pictures taken in continuous shooting modes other than  are always displayed after shooting. Pictures taken in  mode are recorded without being displayed.

Ⓜ FRAME NO.

New pictures are stored in image files named using a four-digit file number assigned by adding one to the last file number used. The file number is displayed during playback as shown at right. **FRAME NO.** controls whether file numbering is reset to 0001 when a new memory card is inserted or the current memory card or internal memory is formatted.

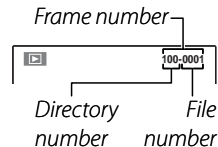

- **CONTINUOUS:** Numbering continues from the last file number used or the first available file number, whichever is higher. Choose this option to reduce the number of pictures with duplicate file names.
- **RENEW:** Numbering is reset to 0001 after formatting or when a new memory card is inserted.

← Notes

- If the frame number reaches 999-9999, the shutter release will be disabled (pg. 106).
- Selecting **Ⓜ RESET** (pg. 89) resets **Ⓜ FRAME NO.** to **CONTINUOUS** but does not reset frame numbering.
- Frame numbers for pictures taken with other cameras may differ.

📷 DUAL IS MODE

Choose whether image stabilization is performed at all times when the camera is in shooting mode (**1 CONTINUOUS**), or only when the shutter button is pressed halfway (**2 SHOOTING ONLY**).

DIGITAL ZOOM

If **ON** is selected, selecting **T** at the maximum optical zoom position will trigger digital zoom, further magnifying the image. To cancel digital zoom, zoom out to the minimum digital zoom position and select **W**.

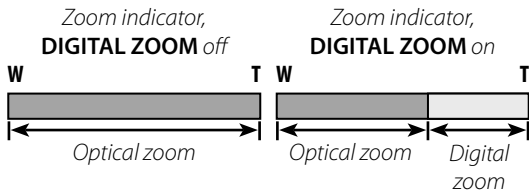
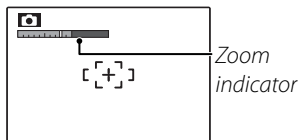

Caution

Digital zoom produces lower quality images than optical zoom.

PLAYBACK VOLUME

Press the selector up or down to choose volume for movie and voice memo playback and press **MENU/OK** to select.

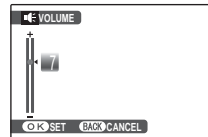

LCD BRIGHTNESS

Press the selector up or down to choose display brightness and press **MENU/OK** to select.

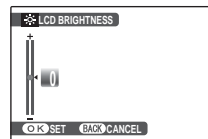

FORMAT

Format internal memory or a memory card. If a memory card is inserted in the camera, **SD** will be displayed in the dialog shown at right and this option will format the memory card. If no memory card is inserted, **IN** will be displayed and this option will format internal memory. Press the selector left to highlight **OK** and press **MENU/OK** to begin formatting.

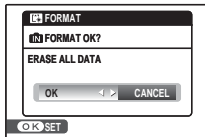

Cautions

- All data—including protected pictures—will be deleted. Be sure important files have been copied to a computer or other storage device.
- Do not open the battery cover during formatting.

AUTO POWER OFF

Choose the length of time before the camera turns off automatically when no operations are performed. Shorter times increase battery life; if **OFF** is selected, the camera must be turned off manually. Note that regardless of the option selected, the camera will not turn off automatically when connected to a printer (pg. 53) or computer (pg. 62) or when a slide show is in progress (pg. 77).

Tip: Reactivating the Camera

To reactivate the camera after it has turned off automatically, use the **ON/OFF** switch or press the  button for about a second (pg. 13).

TIME DIFFERENCE

When travelling, use this option to switch the camera clock instantly from your home time zone to the local time at your destination.

1 Specify the difference between local time and your home time zone.

1.1 Press the selector up or down to highlight **← LOCAL**.



1.2 Press the selector right to display the time difference.

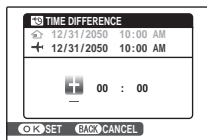

1.3 Press the selector left or right to highlight **+**, **-**, hours, or minutes; press up or down to edit. The minimum increment is 15 minutes.



1.4 Press **MENU/OK** when settings are complete.



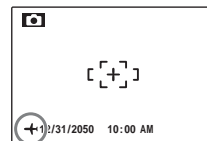

2 Switch between local time and your home time zone.

To set the camera clock to local time, highlight **← LOCAL** and press **MENU/OK**. To set the clock to the time in your home time zone, select **HOME**. If **← LOCAL** is selected, **←** will be displayed in the monitor for three seconds after the camera enters shooting mode, and the date will be displayed in yellow.



After changing time zones, check that the date and time are correct.

DISCHARGE (Ni-MH Batteries Only)

The capacity of rechargeable Ni-MH batteries may be temporarily reduced when new, after long periods of disuse, or if they are repeatedly recharged before being fully discharged. Capacity can be increased by repeatedly discharging the batteries using the  **DISCHARGE** option and recharging them in a battery charger (sold separately). Do not use  **DISCHARGE** with non-rechargeable batteries, and note that the batteries will not discharge if the camera is powered by an optional AC adapter and DC coupler.

- 1 Selecting  **DISCHARGE** displays the message shown above. Press **MENU/OK**.

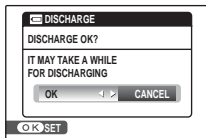

- 2 Press the selector left or right to highlight **OK**.



- 3 Press **MENU/OK** to begin discharging the batteries. When the batteries are fully discharged, the battery level indicator will blink red and the camera will turn off. To cancel the process before the batteries are fully discharged, press **DISP/BACK**.



Optional Accessories

The camera supports a wide range of accessories from FUJIFILM and other manufacturers.

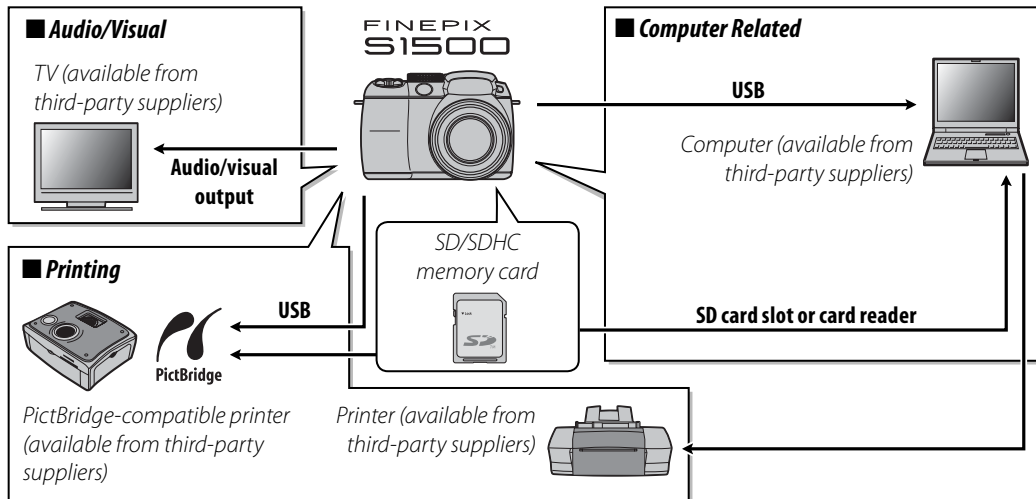

Accessories from FUJIFILM

The following optional accessories are available from FUJIFILM. For the latest information on the accessories available in your region, check with your local FUJIFILM representative or visit http://www.fujifilm.com/products/digital_cameras/index.html.

- **AC power adapter AC-5VX** (requires DC Coupler CP-04): Use for extended playback or when copying pictures to a computer (shape of adapter and plug vary with region of sale).
- **DC Coupler CP-04**: Connect the AC power adapter AC-5VX to the camera.

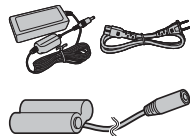

Caring for the Camera

To ensure continued enjoyment of the product, observe the following precautions.

Storage and Use

If the camera will not be used for an extended period, remove the battery and memory card. Do not store or use the camera in locations that are:

- exposed to rain, steam, or smoke
- very humid or extremely dusty
- exposed to direct sunlight or very high temperatures, such as in a closed vehicle on a sunny day
- extremely cold
- subject to strong vibration
- exposed to strong magnetic fields, such as near a broadcasting antenna, power line, radar emitter, motor, transformer, or magnet
- in contact with volatile chemicals such as pesticides
- next to rubber or vinyl products

Water and Sand

Exposure to water and sand can also damage the camera and its internal circuitry and mechanisms. When using the camera at the beach or seaside, avoid exposing the camera to water or sand. Do not place the camera on a wet surface.

Condensation

Sudden increases in temperature, such as occur when entering a heated building on a cold day, can cause condensation inside the camera. If this occurs, turn the camera off and wait an hour before turning it on again. If condensation forms on the memory card, remove the card and wait for the condensation to dissipate.

Cleaning





Use a blower to remove dust from the lens and monitor, then gently wipe with a soft, dry cloth. Any remaining stains can be removed by wiping gently with a piece of FUJIFILM lens-cleaning paper to which a small amount of lens-cleaning fluid has been applied. Care should be taken to avoid scratching the lens or monitor. The camera body can be cleaned with a soft, dry cloth. Do not use alcohol, thinner, or other volatile chemicals.

Traveling

Keep the camera in your carry-on baggage. Checked baggage may suffer violent shocks that could damage the camera.

Troubleshooting

Power and Battery

Problem	Possible cause	Solution	Page
The camera does not turn on.	The batteries are exhausted.	Insert fresh or fully-charged spare batteries.	8
	The batteries are not in the correct orientation.	Re-insert the batteries in the correct orientation.	8
	The battery-chamber cover is not latched.	Latch the battery-chamber cover.	9
	The AC adapter and DC coupler are not connected properly.	Make sure that the AC adapter and DC coupler are properly connected.	—
	The camera has been left for an extended period with no batteries inserted and the AC adapter/DC coupler unplugged.	After inserting the batteries or connecting the AC adapter/DC coupler, wait a few moments before turning the camera on.	—
Power supply The batteries run down quickly.	The batteries are cold.	Warm the batteries by placing them in a pocket or other warm place and re-insert them in the camera immediately before taking a picture.	v
	There is dirt on the battery terminals.	Clean the terminals with a soft, dry cloth.	—
	The camera is in SR/AUTO mode.	Select another shooting mode.	13, 32
	The batteries are new, have been left unused for an extended period, or have been recharged without first being fully discharged (rechargeable Ni-MH batteries only).	Discharge Ni-MH batteries using the  DISCHARGE option and recharge them in a battery charger (sold separately). If the batteries do not hold a charge after repeated discharging and recharging, they have reached the end of their service life and must be replaced.	94
	 HIGH SPEED SHOOTING is on.	Turn  HIGH SPEED SHOOTING off to reduce the drain on the battery.	—
	 CONTINUOUS AF is selected for  FOCUSING .	Select a different focusing option.	73
The camera turns off suddenly.	The batteries are exhausted.	Insert fresh or fully-charged spare batteries.	8
	The AC adapter or DC coupler has been disconnected.	Make sure that the AC adapter and DC coupler are properly connected.	—



Menus and Displays

Problem	Possible cause	Solution	Page
Menus and displays are not in English.	English is not selected for the  言語/LANG.	Select ENGLISH .	14

Shooting

Problem	Possible cause	Solution	Page
Taking pictures	Memory is full.	Insert a new memory card or delete pictures.	11, 47
	Memory is not formatted.	Format the memory card or internal memory.	92
	There is dirt on the memory card contacts.	Clean the contacts with a soft, dry cloth.	11
	The memory card is damaged.	Insert a new memory card.	10
	The batteries are exhausted.	Insert fresh or fully-charged spare batteries.	8
	The camera has turned off automatically.	Turn the camera on.	13
The monitor goes dark after shooting.	The flash has fired.	The monitor may darken while the flash charges. Wait for the flash to charge.	26
Focus	The subject is close to the camera.	Select macro mode.	25
	The subject is far away from the camera.	Cancel macro mode.	
	The subject is not suited to autofocus.	Use focus lock.	23



	Problem	Possible cause	Solution	Page
Intelligent Face Detection	Face detection not available.	Intelligent Face Detection is not available in the current shooting mode.	Choose a different shooting mode.	32
	No face is detected.	The subject's face is obscured by sunglasses, a hat, long hair, or other objects.	Remove the obstructions.	21
		The subject's face occupies only a small area of the frame.	Change the composition so that the subject's face occupies a larger area of the frame.	
		The subject's head is tilted or horizontal.	Ask the subject to hold their head straight.	
		The camera is tilted.	Hold the camera straight.	16
		The subject's face is poorly lit.	Shoot in bright light.	—
Wrong subject selected.	The selected subject is closer to the center of the frame than the main subject.	Recompose the picture or turn face detection off and frame the picture using focus lock.	21, 23	
Close-ups	Macro mode is not available.	Macro mode is not available in the current shooting mode.	Choose a different shooting mode.	25, 32
Flash	The flash does not fire.	The flash is lowered.	Raise the flash.	26
		The flash is charging.	Wait for the flash to charge.	26
		The flash is not available in the current shooting mode.	Choose a different shooting mode.	32
		The batteries are exhausted.	Insert fresh or fully-charged spare batteries.	8
		The camera is in super macro or continuous shooting mode.	Turn super macro and continuous shooting modes off.	25, 28
	Flash mode not available.	The desired flash mode is not available in the current shooting mode.	Choose a different shooting mode.	32
	The flash does not fully light the subject.	The subject is not in range of the flash.	Position the subject in range of the flash.	111
The flash window is obstructed.		Hold the camera correctly.	16	
		Fast shutter speed selected.	Choose a slower shutter speed.	36

	Problem	Possible cause	Solution	Page
Problem images	Pictures are blurred.	The lens is dirty.	Clean the lens.	97
		The lens is blocked.	Keep objects away from the lens.	16
		!AF is displayed during shooting and the focus frame is displayed in red.	Check focus before shooting.	104
		! is displayed during shooting.	Use the flash or a tripod.	27
	Pictures are mottled.	The ambient temperature is high and the subject is poorly lit.	This is normal and does not indicate a malfunction. Choose a lower sensitivity.	65
		Slow shutter speed selected and the subject is poorly lit.	Choose a faster shutter speed.	37, 39
	Vertical lines appear in pictures.	The camera has been used continuously at high temperatures.	Turn the camera off and wait for it to cool down.	—
	Smear appears in pictures.	Fast shutter speed selected and the subject is brightly lit.	Choose a slower shutter speed.	37, 39
Recording	Pictures are not recorded.	Power was interrupted during shooting.	Turn the camera off before connecting the AC adapter/DC coupler. Leaving the camera on can result in corrupted files or damage to the memory card or internal memory.	—
Continuous shooting mode	Only one picture is taken.	The self timer is on and an option  and  are selected in continuous shooting mode.	Turn the self-timer off.	70

Playback

Problem		Possible cause	Solution	Page
Pictures	Pictures are grainy.	The pictures were taken with a different make or model of camera.	—	—
	Playback zoom unavailable.	The pictures were taken at an image size of OSM or with a different make or model of camera.	—	66
Audio	No sound in voice memo and movie playback.	The camera is in silent mode.	Turn silent mode off.	18
		Playback volume is too low.	Adjust playback volume.	91
		The microphone was obstructed.	Hold the camera correctly during recording.	84
		The speaker is obstructed.	Hold the camera correctly during playback.	84
Deletion	Selected pictures are not deleted.	Some of the pictures selected for deletion are protected.	Remove protection using the device with which it was originally applied.	81
Frame no.	File numbering is unexpectedly reset.	The battery-chamber cover was opened while the camera was on.	Turn the camera off before opening the battery-chamber cover.	8

Connections

Problem		Possible cause	Solution	Page
TV	No picture or sound.	The camera is not properly connected.	Connect the camera correctly.	52
		An A/V cable was connected during movie playback.	Connect the camera once movie playback has ended.	51, 52
		Input on the television is set to "TV".	Set input to "VIDEO".	—
		The camera is not set to the correct video standard.	Match the camera  VIDEO SYSTEM setting to the TV.	89
		The volume on the television is too low.	Adjust the volume.	—
	No color.	The camera is not set to the correct video standard.	Match the camera  VIDEO SYSTEM setting to the TV.	89





	Problem	Possible cause	Solution	Page
Computer	The computer does not recognize the camera.	The camera is not properly connected.	Connect the camera correctly.	62
PictBridge	Pictures can not be printed.	The camera is not properly connected.	Connect the camera correctly.	53
		The printer is off.	Turn the printer on.	—
	Only one copy is printed.	The printer is not PictBridge-compatible.	—	—
The date is not printed.				



Miscellaneous

	Problem	Possible cause	Solution	Page
	Nothing happens when the shutter button is pressed.	Temporary camera malfunction.	Remove and reinsert the batteries or disconnect and reconnect the AC adapter/DC coupler.	8
		The batteries are exhausted.	Insert fresh or fully-charged spare batteries.	8
	The camera does not function as expected.	Temporary camera malfunction.	Remove and reinsert the batteries or disconnect and reconnect the AC adapter/DC coupler. If the problem persists, contact your FUJIFILM dealer.	8, 114

Warning Messages and Displays

The following warnings are displayed in the monitor:

Warning	Description	Solution
 (red)	Batteries are low.	Insert fresh or fully-charged spare batteries.
 (blinks red)	Batteries are exhausted.	
	Slow shutter speed. Picture may be blurred.	Use the flash or mount the camera on a tripod.
!AF (displayed in red with red focus frame)	The camera can not focus.	<ul style="list-style-type: none"> • Use focus lock to focus on another subject at the same distance, then recompose the picture (pg. 23). • If the subject is poorly lit, try focusing at a distance of about 2 m (6.6 ft.). • Use macro mode to focus when taking close-ups.
Aperture or shutter speed shown in red	The subject is too bright or too dark. The picture will be over- or under-exposed.	If the subject is dark, use the flash.
FOCUS ERROR	Camera malfunction.	Turn the camera off and then on again, taking care not to touch the lens. If the message persists, contact a FUJIFILM dealer (pg. 114).
ZOOM ERROR		
LENS CONTROL ERROR		
NO CARD	No memory card inserted when COPY is selected in the playback menu.	Insert a memory card.
CARD NOT INITIALIZED	The memory card or internal memory is not formatted or the memory card was formatted in a computer or other device.	Format the memory card or internal memory using the  FORMAT option in the camera setup menu (pg. 92).
	The memory card contacts require cleaning.	Clean the contacts with a soft, dry cloth. If the message is repeated, format the memory card (pg. 92). If the message persists, replace the memory card.
	Camera malfunction.	Contact a FUJIFILM dealer (pg. 114).
PROTECTED CARD	The memory card is locked.	Unlock the memory card (pg. 10).
BUSY	The memory card is incorrectly formatted.	Use the camera to format the memory card (pg. 92).

Warning	Description	Solution
CARD ERROR	The memory card is not formatted for use in the camera.	Format the memory card (pg. 92).
	The memory card contacts require cleaning or the memory card is damaged.	Clean the contacts with a soft, dry cloth. If the message is repeated, format the memory card (pg. 92). If the message persists, replace the memory card.
	Incompatible memory card.	Use a compatible memory card.
	Camera malfunction.	Contact a FUJIFILM dealer (pg. 114).
 MEMORY FULL	The memory card or internal memory is full; pictures can not be recorded or copied.	Delete pictures or insert a memory card with more free space.
 MEMORY FULL		
INTERNAL MEMORY IS FULL INSERT A NEW CARD		
WRITE ERROR	Memory card error or connection error.	Re-insert the memory card or turn the camera off and then on again. If the message persists, contact a FUJIFILM dealer (pg. 114).
	Not enough memory remaining to record additional pictures.	Delete pictures or insert a memory card with more free space.
	The memory card or internal memory is not formatted.	Format the memory card or internal memory (pg. 92).
READ ERROR	The file is corrupt or was not created with the camera.	The file can not be played back.
	The memory card contacts require cleaning.	Clean the contacts with a soft, dry cloth. If the message is repeated, format the memory card (pg. 92). If the message persists, replace the memory card.
	Camera malfunction.	Contact a FUJIFILM dealer (pg. 114).

Warning	Description	Solution
FRAME NO. FULL	The camera has run out of frame numbers (current frame number is 999-9999).	Format the memory card and select RENEW for the FRAME NO. option in the SET-UP menu. Take a picture to reset frame numbering to 100-0001, then return to the FRAME NO. menu and select CONTINUOUS .
TOO MANY FRAMES	Date for which more than 4,999 pictures exist selected in sort-by-date view.	Choose a different date.
CAN NOT EXECUTE	Red-eye removal can not be applied to the selected picture or movie.	—
PROTECTED FRAME	An attempt was made to delete, rotate, or add a voice memo to a protected picture.	Remove protection before deleting, rotating, or adding voice memos to pictures.
ERROR	Voice memo file is corrupt. Camera malfunction.	The voice memo can not be played back. Contact a FUJIFILM dealer (pg. 114).
NO IMAGE NO IMAGE	The source device selected in the playback COPY menu contains no pictures.	Select a different source.
CAN NOT TRIM	An attempt was made to crop a picture.	These pictures can not be cropped.
CAN NOT TRIM	The picture selected for cropping is damaged or was not created with the camera.	These pictures can not be cropped.
DPOF FILE ERROR	The DPOF print order on the current memory card contains more than 999 images.	Copy the pictures to internal memory and create a new print order.
CAN NOT SET DPOF	The picture can not be printed using DPOF.	—
CAN NOT SET DPOF	Movies can not be printed using DPOF.	—
CAN NOT ROTATE	The picture can not be rotated.	—
CAN NOT ROTATE	Movies can not be rotated.	—

Warning	Description	Solution
PRESS AND HOLD THE DISP BUTTON TO DEACTIVATE SILENT MODE	An attempt was made to adjust the volume with the camera in silent mode.	Exit silent mode before adjusting the volume.
COMMUNICATION ERROR	A connection error occurred while pictures were being printed or copied to a computer or other device.	Confirm that the device is turned on and that the USB cable is connected.
PRINTER ERROR	Printer out of paper or ink, or other printer error.	Check printer (see printer manual for details). To resume printing, turn the printer off and then turn it back on.
PRINTER ERROR RESUME?		Check printer (see printer manual for details). If printing does not resume automatically, press MENU/OK to resume.
CAN NOT BE PRINTED	An attempt was made to print a movie, a picture not created with the camera, or a picture in a format not supported by the printer.	Movies and some pictures created with other devices can not be printed. If the picture was created with the camera, check the printer manual to confirm that the printer supports the JFIF-JPEG or Exif-JPEG format. If it does not, the pictures can not be printed.

Glossary

Digital zoom: Unlike optical zoom, digital zoom does not increase the amount of visible detail. Instead, details visible using optical zoom are simply enlarged, producing a slightly “grainy” image.

DPOF (Digital Print Order Format): A standard that allows pictures to be printed from “print orders” stored in internal memory or on a memory card. The information in the order includes the pictures to be printed and the number of copies of each picture.



EV (Exposure Value): The exposure value is determined by the sensitivity of the image sensor and the amount of light that enters the camera while the image sensor is exposed. Each time the amount of light doubles, EV increases by one; each time the amount of light is halved, EV decreases by one. The amount of light entering the camera can be controlled by adjusting aperture and shutter speed.

Exif Print: A standard that allows information stored with pictures to be used for optimal color reproduction during printing.

JPEG (Joint Photographic Experts Group): A compressed file format for color images. The higher the compression rate, the greater the loss of information and more noticeable drop in quality when the picture is displayed.

Motion JPEG: An AVI (Audio Video Interleave) format that stores sound and JPEG images in a single file. Motion JPEG files can be played in Windows Media Player (requires DirectX 8.0 or later) or QuickTime 3.0 or later.

Smear: A phenomenon specific to CCDs which causes white streaks to appear when very bright light sources, such as the sun or reflected sunlight, appear in the frame.

WAV (Waveform Audio Format): A standard Windows audio file format. WAV files have the extension “*.WAV” and may be compressed or uncompressed. The camera uses uncompressed WAV. WAV files can be played using Windows Media Player or QuickTime 3.0 or later.

White balance: The human brain automatically adapts to changes in the color of light, with the result that objects that appear white under one light source still appear white when the color of the light source changes. Digital cameras can mimic this adjustment by processing images according to the color of the light source. This process is known as “white balance.”

Internal Memory/Memory Card Capacity

The following table shows the recording time or number of pictures available at different image qualities. All figures are approximate; file size varies with the scene recorded, producing wide variations in the number of files that can be stored. The number of exposures or length remaining may not diminish at an even rate.

	10M F	10M N	9M 3:2	5M	3M	2M	03M	640	320	
Image size (pixels)	3648×2736		3648×2432	2592×1944	2048×1536	1600×1200	640×480	640×480 (VGA)	320×240 (QVGA)	
File size	5.0MB	2.5MB	2.3MB	1.3MB	810KB	650KB	160KB	—	—	
Internal memory (approx. 23 MB)	4	8	9	17	28	35	147	28 sec.	51 sec.	
SD card	512 MB	95	190	220	380	600	750	3090	9 min.	17 min.
	1 GB	200	390	440	770	1210	1510	6190	19 min.	35 min.
	2 GB	400	790	880	1540	2380	2950	12400	39 min.	71 min.
SDHC card	4 GB	800	1590	1770	3100	4770	5900	24820	79 min.*	143 min.*
	8 GB	1610	3190	3550	6220	9570	11850	49800	160 min.*	288 min.*
	16 GB	3240	6400	7130	12480	19200	23780	99880	321 min.*	577 min.*

* Total length of all movie files. Individual movies can not exceed 2GB, regardless of capacity of memory card.

Specifications

System	
Model	Digital Camera FinePix S1500
Effective pixels	10 million
CCD	½.3-in., square-pixel Bayer CCD with primary color filter
Storage media	• Internal memory (approx. 23 MB) • SD/SDHC memory cards (see page 10)
File system	Compliant with Design Rule for Camera File System (DCF), Exif 2.2, and Digital Print Order Format (DPOF)
File format	• Still pictures: Exif 2.2 JPEG (compressed) • Movies: AVI-format Motion JPEG • Audio: WAV
Image size (pixels)	• 10M F: 3,648 × 2,736 • 10M N: 3,648 × 2,736 • 9M 3:2: 3,648 × 2,432 • 5M: 2,592 × 1,944 • 3M: 2,048 × 1,536 • 2M: 1,600 × 1,200 • 03M: 640 × 480
File size	See page 109
Lens	Fujinon 12 × optical zoom lens, F/2.8 (wide angle) – 5 (telephoto)
Focal length	f=5.9 mm–70.8 mm (35-mm format equivalent: 33 mm–396 mm)
Digital zoom	• Still pictures: Approx. 5.7 × (up to 68.4 × when combined with optical zoom) • Movies: 2 ×
Aperture	F2.8–F6.4 (wide angle), F5.0–F8.0 (telephoto), 1/3 EV increments Manual/Auto selectable
Focus range (distance from front of lens)	Approx. 40 cm (1.3 ft.)–infinity (wide angle); 1.5 m (4.9 ft.)–infinity (telephoto) Macro: approx. 5 cm–3 m/0.2 ft.–9.8 ft. (wide angle); 80 cm–3 m/2.6 ft.–9.8 ft. (telephoto) Super macro: approx. 2 cm–100 cm/0.1 ft.–3.3 ft. (wide angle) High-speed shooting: approx. 100 cm (3.3 ft.)–infinity (wide angle); 2.5 m (8.2 ft.)–infinity (telephoto)
Sensitivity	Standard output sensitivity equivalent to ISO 100, 200, 400, 800, 1600, 3200, 6400 (3200 and 6400 available only at image sizes 3M or smaller); AUTO , AUTO (400) , AUTO (800)
Metering	256-segment through-the-lens (TTL) metering; MULTI, SPOT, AVERAGE
Exposure control	Programmed, shutter-priority, and aperture-priority, auto exposure; manual exposure
Exposure compensation	–2 EV – +2 EV in increments of ½ EV (P , S , A , and M modes)

System	
Scene modes	(PORTRAIT), (LANDSCAPE), (SPORT), (NIGHT), (NIGHT (TRIPOD)), (NATURAL LIGHT), (FIREWORKS), (SUNSET), (SNOW), (BEACH), (MUSEUM), (PARTY), (FLOWER), (TEXT)
Scene recognition	Available (camera automatically selects , , , , , or)
Picture stabilization	Optical stabilization, CCD shift
Intelligent Face Detection	Available
Shutter speed	<ul style="list-style-type: none"> • SR/AUTO, , , , , , , , , , , , : 1/4 s – 1/2,000 s • P, A, S, M: 8 s – 1/2,000 s • : 1/8 s – 1/2,000 s • : 3 s – 1/2,000 s • : 8 s – 1/2 s
Continuous	<ul style="list-style-type: none"> • : up to 1.4 fps; max. 3 frames • : up to 1.4 fps; maximum number of frames varies with image size and available memory • : up to 1.4 fps; last 3 frames recorded • : up to 7.5 fps; max. 15 frames; up to 12M pixels • : up to 1.4 fps; max. 3 frames • : up to 3.3 fps; max. 6 frames; up to 5M pixels
Bracketing	±1/3 EV, ±2/3 EV, ±1 EV
Focus	<ul style="list-style-type: none"> • Mode: Single AF, continuous AF • Focus-area selection: CENTER, MULTI, AREA, TRACKING • Autofocus system: Contrast-detect TTL AF with AF-assist illuminator (effective range approx. 2 m/6.6 ft.)
White balance	Automatic scene detection; six manual preset modes for direct sunlight, shade, daylight fluorescent, warm white fluorescent, cool white fluorescent, and incandescent lighting; custom white balance
Self-timer	Off, 2 sec, 10 sec
Flash	Auto flash with CCD flash control (using monitor pre-flashes) and manual pop-up; effective range when sensitivity is set to AUTO is approx. 40 cm–8.7 m/1.3 ft.–29 ft. (wide angle), 1.5 m–4.8 m/4.9 ft.–16 ft. (telephoto), or 30 cm–3 m/1 ft.–9.8 ft. (macro mode)
Flash modes	Auto, forced flash, off, slow synchro (red-eye removal off); auto with red-eye removal, forced flash with red-eye removal, off, slow sync with red-eye removal (red-eye removal on)

System	
Electronic viewfinder (EVF)	0.2-in., 200k-dot color LCD monitor
Frame coverage	Approx. 94% (shooting), 100% (playback)
Monitor	2.7-in., 230k-dot low-temperature polysilicon high-transmission (WV film) TFT color LCD monitor
Frame coverage	Approx. 97% (shooting), 100% (playback)
Movies	Camera can record movies with monaural sound and a frame size of VGA (640 ; 640×480) or QVGA (320 ; 320×240) at a frame rate of 30 fps
Shooting options	Instant zoom, Intelligent Face Detection with red-eye removal, high-speed shooting, framing guideline, post-shot assist, frame number memory, and histogram display
Playback options	Intelligent Face Detection, red-eye removal, micro thumbnail, multi-frame playback, sort-by-date, trimming, slide show, image rotation, voice memo, histogram display, and exposure warning
Other options	PictBridge, Exif Print, FinePix COLOR, language selection (Simplified Chinese, Traditional Chinese, Czech, Dutch, English, French, German, Hungarian, Italian, Japanese, Korean, Polish, Portuguese, Russian, Spanish, Swedish, Thai, and Turkish), time difference, battery discharge
Input/output terminals	
A/V OUT (audio/video output)	8-pin multi-connector for NTSC or PAL output with monaural sound
Digital input/output	USB 2.0 High Speed; shares A/V OUT connector
DC IN	For use with DC Coupler CP-04 connected to AC power adapter AC-5VX (AC adapter and DC coupler sold separately)
Power supply/other	
Power sources	<ul style="list-style-type: none"> • AA alkaline batteries (x4) • AA lithium batteries (x4; available from third-party suppliers) • AA rechargeable nickel-metal hydride (Ni-MH) batteries (x4; available from third-party suppliers) • AC power adapter AC-5VX and DC Coupler CP-04 (sold separately)

Power supply/other	
Battery life	Approx. 300 frames (alkaline batteries of the type supplied with the camera), 700 frames (lithium batteries), or 500 frames (Ni-MH batteries), based on CIPA (Camera and Imaging Products Association) standard; measured at 23°C (73°F) with the monitor on, pictures recorded to an SD memory card, the camera zoomed from widest angle to maximum zoom and back once every 30 s, the flash fired at full power with every other shot, and the camera turned off and then on again every 10 shots. Note that the number of shots that can be taken varies with battery make and charge state, temperature, and shooting conditions.
Camera dimensions	102.5 mm × 73 mm × 67.8 mm/4.0 in. × 2.9 in. × 2.7 in. (W × H × D), excluding batteries and accessories
Camera weight	Approx. 324 g/11.4 oz., excluding batteries, accessories, and memory cards
Shooting weight	Approx. 419 g/14.8 oz., including batteries and memory card
Operating conditions	<ul style="list-style-type: none"> • Temperature: 0°C – +40°C/+32°F – +104°F • Humidity: 80% or less (no condensation)

Color Television Systems

NTSC (National Television System Committee) is a color television telecasting specification adopted mainly in the U.S.A., Cada, and Japan. PAL (Phase Altertion by Line) is a color television system adopted mainly in European countries and China.

Notices

- Specifications subject to change without notice. FUJIFILM shall not be held liable for damages resulting from errors in this manual.
- Although the monitor is manufactured using advanced high-precision technology, small bright points and anomalous colors (particularly in the vicinity of text) may appear. This is normal for this type of monitor and does not indicate a malfunction; images recorded with the camera are unaffected.
- Digital cameras may malfunction when exposed to strong radio interference (e.g., electric fields, static electric-ity, or line noise).
- Due to the type of lens used, some distortion may occur at the periphery of images. This is normal.

FUJIFILM Digital Camera Worldwide Network

Contact your local distributor (see list below) for repairs and technical support. Please present the warranty and purchase receipt when requesting repairs; refer to the warranty card for the conditions of the warranty. Technical support may not be available for models not handled by the local distributor. The following information is subject to change without notice.

NORTH AMERICA			
Canada	FUJIFILM Canada Inc.	Technical support	TEL 1-866-818-FUJI (3854) http://www.fujihelp.ca
		Repair service	TEL 1-800-263-5018 http://www.fujihelp.ca
U.S.A.	FUJIFILM U.S.A., Inc.	Technical support	TEL 800-800-3854 digitalinfo@fujifilm.com
		Repair service	TEL 800-659-3854
CENTRAL AND SOUTH AMERICA			
Argentina	Imagen e informacion S.A.	Technical support & repairs	TEL +54-11-4836-1000 servtec@imagineinformacion.com.ar
Bolivia	Reifschneider Bolivia Ltda.	Technical support & repairs	TEL +591 33 44 1129 gciagral@bibosi.scz.entelnet.bo
Brazil	FUJIFILM do Brasil Ltda.	Technical support & repairs	TEL 0800-12-8600 camarasdigitais@fujifilm.com.br
Chile	Reifschneider SA	Technical support & repairs	TEL 56-2-6781200 serviciotecnico@reifschneider.cl
Colombia	Animex de Colombia Ltda.	Technical support & repairs	TEL +57 1 338-0299 animex@etb.net.co
Ecuador	Espacri Cia Ltda	Technical support & repairs	TEL 593-72-835526
		Importaciones Espacri Cia. Ltda.	Technical support & repairs
Mexico	Fujifilm de Mexico, S.A. de C.V.	Technical support	TEL (52-55) 5263-55000 eizquierdo@fujifilm.com.mx
		Repair service	TEL (52-55) 5366-5150/56/57 cpalma@fujifilm.com.mx
Paraguay	Errece S.R.L.	Technical support & repairs	TEL +595 21 444256 jmarbulo@fujifilm.com.py
Peru	Procesos de Color S.A.	Technical support & repairs	TEL +51 14 33 5563 jalvarado@fujifilm.com.pe
Uruguay	Fotocamara S.R.L.	Technical support & repairs	TEL +598-2-9002004 fotocam@adinet.com.uy
		Kiel S.A.	Technical support & repairs
Venezuela	C. Hellmund & Cia Sa	Technical support & repairs	TEL 0212-2022300 hellmund@hellmund.com
EUROPE			
Austria	Fuji Film Oesterreich	Technical support & repairs	TEL 0043 1 6162606/51 or 52 kamera.service@fujifilm.at
Belgium	Belgian Fuji Agency	Technical support & repairs	TEL 3210242090 info@fuji.be
Croatia	I&I d.o.o.	Technical support	TEL 38512319060 dsaravanja@fujifilm.hr
		Repair service	TEL 38512316228 info@fujifilm.hr

EUROPE

Cyprus	PMS IMAGING LTD	Technical support & repairs	TEL 35722746746 mariosashiotis@fujifilm.com.cy
	Doros Neophytou CAMERA REPAIRS	Technical support & repairs	TEL 35722314719 dorosn@logosnet.cy.net
Czech Republic	Fujifilm Cz., s.r.o.	Technical support	TEL 00420 234 703 411 petr.barta@fujifilm.cz
	AWH servis	Repair service	TEL 00420 222 721 525 awh@awh.cz
Denmark	Fujifilm Danmark A/S	Technical support & repairs	TEL 0045 45662244 fujifilm@fujifilm.dk
Finland	Fuji Finland Oy	Technical support & repairs	TEL +358 9 825951 www.fuji.fi fuji@fuji.fi
France	FUJIFILM France	Technical support & repairs	direction.technique@pm2s.fr
Germany	FUJIFILM Electronic Imaging Europe GmbH	Technical support & repairs	Tel 0180 / 589 89 80* service@fujifilm-digital.com *0,14 EUR pro Minute aus dem deutschen Festnetz, abweichende Preise aus Mobilfunknetzen möglich, Stand bei Drucklegung.
Greece	FUJIFILM HELLAS S.A.	Technical support & repairs	TEL 0030 210 9404100 fujifilm@fujifilm.gr
Hungary	Fujifilm Hungary Ltd.	Technical support	TEL 3612389410 fujifilm@fujifilm.hu
		Repair service	TEL 3613633777
Iceland	Icephoto (Ljosmyndavorur)	Technical support & repairs	TEL 354 568 0450 framkollun@fujifilm.is
Italy	FujiFilm Italia S.r.l.	Call center	TEL 039-0267978181 info@fujifilm.it
		Repair service	TEL 039-6058294 FAX 039-6058295
Lithuania	Fujifilm Lithuania	Technical support & repairs	TEL 370-5-2130121 info@fujifilm.lt
Malta	Ciancio (1913) Co.Ltd.	Technical support & repairs	TEL 0356-21-480500 info@fujifilm.com.mt
Norway	Fujifilm Norge AS	Technical support	TEL 0047-02273 http://www.fujifilm.no/ mailto:post@fujifilm.no
		Repair service	TEL 0047-55393880 http://www.camera.no/mailto:service@camera.no
		Technical support	TEL +48-22-517-66-00 fujifilm@fujifilm.pl
Poland	Fujifilm Polska Distribution Sp. z o.o.	Repair service	TEL +48-22-886-94-40 serwis@fujifilm.pl
		Technical support	TEL (351) 226 194 237 finepix@fujifilm.pt
Portugal	Fujifilm Portugal, Lda	Repair service	TEL (351) 226 194 200 cameras@fujifilm.pt
Romania	CTS-Cardinal Top Systems Ltd	Technical support & repairs	TEL 4021-230-09-82 cts_tirla@hotmail.com
Russia	Fujifilm Electronic Imaging Europe GmbH	Technical support & repairs	TEL 8 800 200 3854 (Для бесплатных звонков из России) *Для звонков из других стран набирайте +7 800 200 3854 http://www.fujifilm-digital.ru/ info@fujifilm-digital.ru
Slovakia	Fujifilm Slovakia s.r.o.	Technical support	TEL 00421 2 33 595 107 fujifilm@fujifilm.sk
		Repair service	TEL 00421 2 33 595 119 servis@fujifilm.sk
Spain	Fujifilm Espana S.A.	Technical support & repairs	TEL 902012535 http://www.fujifilm.es/soporte/ tallersat@fujifilm.es

EUROPE

Sweden	Fujifilm Sverige AB	Technical support Repair service	TEL 46 8 506 141 70 <i>kamera@fujifilm.se</i> TEL 46 8 506 141 00 <i>kameraverkstaden@fujifilm.se</i>
Switzerland / Liechtenstein	Fujifilm (Switzerland) AG	Technical support & repairs	TEL +41 44 855 5154 <i>RepairCenter@fujifilm.ch</i>
The Netherlands	FUJIFILM Electronic Imaging Nederland	Technical support Repair service	TEL +31(0)102812500 <i>helpdesk@fujifilm-digital.nl</i> TEL +31(0)102812520 <i>camerareparaties@fujifilm-digital.nl</i>
Turkey	Fujifilm Turkiye Sinfo A.S.	Technical support Repair service	TEL +90 212 696 5090 <i>csarp@fujifilm.com.tr</i> TEL +90 212 696 5090 <i>servis@fujifilm.com.tr</i>
U.K.	FUJIFILM UK Ltd.	Technical support Repair service	TEL +44 (0)8700 841310 <i>fujitec@fuji.co.uk</i> TEL +44 (0)8700 841314 <i>fujitec@fuji.co.uk</i>
Ukraine	Image Ukraine CJSC	Technical support & repairs	TEL +380-44-4909075 <i>d@fujifilm.ua</i>

MIDDLE EAST

Iran	Tehran Fuka Co.	Technical support & repairs	TEL (+98-21)2254810-19 <i>fuka@neda.net</i>
Israel	Shimone Group Ltd.	Technical support Repair service	TEL (+) 972 3 9250666 <i>digital@fujifilm.co.il</i> TEL (+) 972 3 9250666 <i>khaim@shimone.com</i>
Jordan	Grand Stores Al- Abdali, Amman / Jordan	Technical support & repairs	TEL 009626-4646387 <i>gstores@go.com.jo</i>
Lebanon	Fototek S.A.R.L.	Technical support & repairs	TEL +961 1 252474 <i>fototek@antakiholding.com</i>
Qatar	Techno Blue	Technical support	TEL 00974 44 66 175 <i>prabu@techno-blue.com</i>
Saudi Arabia	Emam Distribution Co. Ltd.	Technical support	TEL 96626978756 <i>service@fujifilm.com.sa</i>
Syria	Film Trading Company	Technical support Repair service	TEL + 963 11 2218049 <i>f.t.c@Net.SY</i> TEL + 963 21 4641903 <i>filmtradin@Net.SY</i>
U.A.E.	Grand Stores	Technical support & repairs	TEL + 971-4-2823700 <i>photography@grandstores.ae</i>
Yemen	Al-Haidary Trading	Technical support Repair service	TEL 00967-1-503980 TEL 00967-1-503977

AFRICA

Egypt	Foto Express Egypt	Technical support & repairs	TEL (202) 7762062 <i>fotoegypt@access.com.eg</i>
Kenya	Fuji Kenya Ltd	Repair service	TEL (254-20)4446265-8 <i>info@fujifilm.co.ke</i>
South Africa	Cameratek CC.	Technical support & repairs	TEL +27 11 251 2400 <i>www.cameratek.co.za</i>

OCEANIA

Australia	FUJIFILM Australia Pty Ltd	Technical support & repairs	TEL 1800 226 355 <i>digital@fujifilm.com.au</i>
Fiji	Brijjal & Co. Ltd	Technical support & repairs	TEL (679)3304133 <i>kapadia@connect.com.fj</i>
New Caledonia	Phocidis SARL	Technical support & repairs	TEL (00 687) 25-46-35 <i>phocidis@phocidis.nc</i>

OCEANIA

New Zealand	Fujifilm NZ Ltd	Technical support & repairs	TEL +64-9-4140400 glenn.beaumont@fujifilm.co.nz
Papua New Guinea	Oceania PNG Limited	Technical support	TEL +675 3256411 oceania@daltron.com.pg

ASIA

Hong Kong	Fuji Photo Products Co., Ltd.	Technical support & repairs	TEL (852)2406 3287 rsd@chinahkphoto.com.hk
Indonesia	PT. Modern Internasional, Tbk.	Technical support & repairs	TEL +62 021 45867187 assd_kmrsrv@modernphoto.co.id
Malaysia	FUJIFILM (Malaysia) Sdn. Bhd.	Technical support Repair service	TEL 603-55698388 technical@fujifilm.com.my TEL 603-55698388 camera@fujifilm.com.my
Philippines	YKL Development & Trdg. Corp.	Technical support Repair service	TEL 632-7436601~06 info@yklcolor.com digital@yklcolor.com TEL 632-7436601~06 techop_services@yklcolor.com
Singapore	FUJIFILM (Singapore) Pte Ltd	Technical support & repairs	TEL 65-6380 5557 service@fujifilm.com.sg
South Korea	Korea Fujifilm Co., Ltd.	Technical support	TEL +82-2-3282-7363 photo@fujifilm.co.kr
	Yonsan AS Center (Fujidigital)	Repair service	TEL +82-2-701-1472 1bowl@hanmail.net
	Kangnam AS Center (Digitalgallery)	Repair service	TEL +82-2-2203-1472 nurijili@hanmail.net
	Busan AS Center (Digital-Sewon)	Repair service	TEL +82-51-806-1472 merahan@yahoo.co.kr
Taiwan	Hung Chong Corp.	Technical support & repairs	TEL 886-2-6602-8988 dah@mail.hungchong.com.tw
Thailand	FUJIFILM (Thailand) Ltd.	Technical support Repair service	TEL +662-2706000 ext. 751,752 Dusit_Suriyong@fujifilm.co.th yaowarat@fujifilm.co.th TEL +662-2706000 ext.761,762 warin@fujifilm.co.th
Vietnam	International Minh Viet Co., Ltd.	Technical support & repairs	TEL +84-8-4135740 ext. 322 diep.phanthithanh@imv.com.vn

IMPORTANT NOTICE: Read Before Using the Software

BEFORE OPENING THE CD-ROM PROVIDED BY FUJIFILM CORPORATION, PLEASE READ THIS END USER LICENSE AGREEMENT CAREFULLY. YOU SHOULD USE THE SOFTWARE ON THE CD-ROM ONLY IF YOU CONSENT TO THIS AGREEMENT. BY OPENING THE PACKAGE, YOU ACCEPT AND AGREE TO BE BOUND BY THIS AGREEMENT.

End User License Agreement

This End User License Agreement ("Agreement") is an agreement between FUJIFILM Corporation ("FUJIFILM") and you, which sets forth the terms and conditions of the license granted for you to use the software provided by FUJIFILM.

The CD-ROM contains third-party software. In case a separate agreement is provided by a third party supplier for its software, the provisions of such separate agreement shall apply to the use of such third party software, prevailing over those of this Agreement.

1. Definitions.

- "Media" means the CD-ROM titled "Software for FinePix" which is provided to you together with this Agreement.
- "Software" means the software which is recorded on Media.
- "Documentation" means the operation manuals of Software and other related written materials which are provided to you together with Media.
- "Product" means Media (including Software) and Documentation collectively.

2. Use of Software.

FUJIFILM grants to you a nontransferable, nonexclusive license:

- to install one copy of Software onto one computer in binary machine executable form;
- to use Software on the computer onto which Software is installed; and
- to make one backup copy of Software.

3. Restrictions.

- You shall not distribute, rent, lease or otherwise transfer all or any part of Software, Media or Documentation to any third party without FUJIFILM's prior written consent. You also shall not sublicense, assign or otherwise transfer all or any part of the rights granted to you by FUJIFILM under this Agreement without FUJIFILM's prior written consent.
- Except as expressly granted by FUJIFILM hereunder, you shall not copy or reproduce all or any part of Software or Documentation.
- You shall not modify, adapt or translate Software or Documentation. You also shall not alter or remove copyright and other proprietary notices that appear on or in Software or Documentation.
- You shall not, or shall not have any third party, reverse-engineer, decompile, or disassemble Software.

4. Ownership.

All copyrights and other proprietary rights to Software and Documentation are owned and retained by FUJIFILM or the third party suppliers as indicated on or in Software or Documentation. Nothing contained herein shall be construed, expressly or implicitly, as transferring or granting any right, license, or title to you other than those explicitly granted under this Agreement.

5. Limited Warranty.

FUJIFILM warrants to you that Media is free from any defect in material and workmanship under normal use for ninety (90) days from the date of your receipt of Media. Should Media not meet the foregoing warranty, FUJIFILM shall replace such defective Media with other Media bearing no defect. FUJIFILM's entire liability and your sole and exclusive remedy with regard to any defect in Media shall be expressly limited to such FUJIFILM's replacement of Media as provided herein.

6. DISCLAIMER OF WARRANTY.

EXCEPT AS PROVIDED IN SECTION 5 HEREIN, FUJIFILM PROVIDES PRODUCT "AS IS" AND WITHOUT WARRANTIES OF ANY KIND, EXPRESS OR IMPLIED. FUJIFILM SHALL MAKE NO WARRANTY, EXPRESS, IMPLIED OR STATUTORY, AS TO ANY OTHER MATTERS, INCLUDING, BUT NOT LIMITED TO NON-INFRINGEMENT OF ANY COPYRIGHT, PATENT, TRADE SECRET, OR ANY OTHER PROPRIETARY RIGHTS OF ANY THIRD PARTY, MERCHANTABILITY, OR FITNESS FOR ANY PARTICULAR PURPOSE.

7. LIMITATION OF LIABILITY.

IN NO EVENT SHALL FUJIFILM HAVE ANY LIABILITY FOR ANY GENERAL, SPECIAL, DIRECT, INDIRECT, CONSEQUENTIAL, INCIDENTAL, OR OTHER DAMAGES (INCLUDING DAMAGES FOR LOSS OF PROFITS OR LOST SAVINGS) INCURRED FROM THE USE OF OR INABILITY TO USE PRODUCT EVEN IF FUJIFILM HAS BEEN ADVISED OF THE POSSIBILITY OF SUCH DAMAGES.

8. No export.

You acknowledge that neither Software nor any part thereof, will be transferred, or exported to any country or used in any manner in violation of any export control laws and regulations to which Software is subject.

9. Termination.

In case you breach any of the terms and conditions hereof, FUJIFILM may immediately terminate this Agreement without any notice.

10. Term.

This Agreement is effective until the date when you cease to use Software, unless earlier terminated in accordance with Section 9 hereof.

11. Obligation upon termination.

Upon termination or expiration of this Agreement, you shall, at your own responsibility and expense, delete or destroy immediately all Software (including its copies, Media and Documentation).

12. Governing Law.

This Agreement shall be governed by and construed in accordance with laws of Japan.

FUJIFILM

FUJIFILM Corporation

7-3, AKASAKA 9-CHOME, MINATO-KU, TOKYO 107-0052, JAPAN

http://www.fujifilm.com/products/digital_cameras/index.html