

FUJIFILM

BL03201-101 **EN**

DIGITAL CAMERA
FINEPIX S4800 Series
FINEPIX S4700 Series
FINEPIX S4600 Series

Owner's Manual

Thank you for your purchase of this product. This manual describes how to use your FUJIFILM digital camera and the supplied software. Be sure that you have read and understood its contents and the warnings in "For Your Safety" (📖 ii) before using the camera.

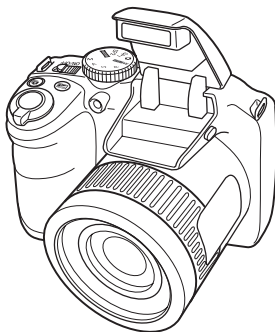

For information on related products, visit our website at
http://www.fujifilm.com/products/digital_cameras/index.html

Before You Begin

First Steps

Basic Photography and Playback

More on Photography

More on Playback

Movies

Connections

Menus

Technical Notes

Troubleshooting

Appendix

Exif Print

**S2
XC**

PictBridge

HDMI[®]
HIGH-DEFINITION MULTIMEDIA INTERFACE

For Your Safety

IMPORTANT SAFETY INSTRUCTIONS

- **Read Instructions:** All the safety and operating instructions should be read before the appliance is operated.
- **Retain Instructions:** The safety and operating instructions should be retained for future reference.
- **Heed Warnings:** All warnings on the appliance and in the operating instructions should be adhered to.
- **Follow Instructions:** All operating and use instructions should be followed.

Installation

Power Sources: This video product should be operated only from the type of power source indicated on the marking label. If you are not sure of the type of power supply to your home, consult your appliance dealer or local power company. For video products intended to operate from battery power, or other sources, refer to the operating instructions.

Grounding or Polarization: This video product is equipped with a polarized alternating-current line plug (a plug having one blade wider than the other). This plug will fit into the power outlet only one way. This is a safety feature. If you are unable to insert the plug fully into the outlet, try reversing the plug. If the plug should still fail to fit, contact your electrician to replace your obsolete outlet. Do

not defeat the safety purpose of the polarized plug.

Alternate Warnings: This video product is equipped with a 3-wire grounding-type plug, a plug having a third (grounding) pin. This plug will only fit into a grounding-type power outlet. This is a safety feature. If you are unable to insert the plug into the outlet, contact your electrician to replace your obsolete outlet. Do not defeat the safety purpose of the grounding-type plug.

Overloading: Do not overload wall outlets and extension cords as this can result in a risk of fire or electric shock.

Ventilation: Slots and openings in the cabinet are provided for ventilation and to ensure reliable operation of the video product and to protect it from overheating, and these openings must not be blocked or covered.

The openings should never be blocked by placing the video product on a bed, sofa, rug, or other similar surface.

This video product should not be placed in a built-in installation such as a bookcase or rack unless proper ventilation is provided or the manufacturer's instructions have been adhered to.

This video product should never be placed near or over a radiator or heat register.

Attachments: Do not use attachments not recommended by the video product manufacturer as they may cause hazards.

Water and Moisture: Do not use this video product near water – for example, near a bath tub, wash bowl, kitchen sink, or laundry tub, in a wet basement, or near a swimming pool, and the like.

Power-Cord Protection: Power-Supply cords should be routed so that they are not likely to be walked on or pinched by items placed upon or against them, paying particular attention to cords at plugs, convenience receptacles, and the point where they exit from the appliance.

Accessories: Do not place this video product on an unstable cart, stand, tripod, bracket, or table. The video product may fall, causing serious injury to a child or adult, and serious damage to the appliance. Use only with a cart, stand, tripod, bracket, or table recommended by the manufacturer, or sold with the video product. Any mounting of the appliance should follow the manufacturer's instructions, and should use a mounting accessory recommended by the manufacturer.

An appliance and cart combination should be moved with care. Quick stops, excessive force, and uneven surfaces may cause the appliance and cart combination to overturn.



Antennas

Outdoor Antenna Grounding: If an outside antenna or cable system is connected to the video product, be sure the antenna or cable system is grounded so as to provide some protection against voltage surges and built-up static charges. Section 810 of the National Electrical Code, ANSI/NFPA No. 70, provides information with respect to proper grounding of the mast and supporting structure, grounding of the lead-in wire to an antenna-discharge unit, size of grounding conductors, location of antenna-discharge unit, connection to grounding electrodes, and requirements for the grounding electrode.

Power Lines: An outside antenna system should not be located in the vicinity of overhead power lines or other electric light or power circuits, or where it can fall into such power lines or circuits. When installing an outside antenna system, extreme care should be taken to keep from touching such power lines or circuits as contact with them might be fatal.

EXAMPLE OF ANTENNA GROUNDING AS PER NATIONAL ELECTRICAL CODE

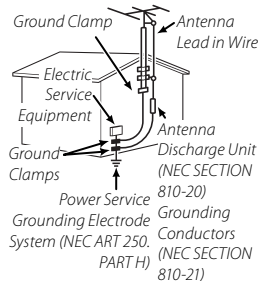

Use

Cleaning: Unplug this video product from the wall outlet before cleaning. Do not use liquid cleaners or aerosol cleaners. Use a damp cloth for cleaning.

Object and Liquid Entry: Never push objects of any kind into this video product through openings as they may touch dangerous voltage points or short out parts that could result in a fire or electric shock. Never spill liquid of any kind on the video product.

Lightning: For added protection for this video product receiver during a lightning storm, or when it is left unattended and unused for long periods of time, unplug it from the wall outlet and disconnect the antenna or cable system. This will prevent damage to the video product due to lightning and power-line surges.

Service

Service: Do not attempt to service this video product yourself as opening or removing covers may expose you to dangerous voltage or other hazards. Refer all servicing to qualified service personnel.

Damage Requiring Service: Unplug this video product from the wall outlet and refer servicing to qualified service personnel under the following conditions:

When the power-supply cord or plug is damaged.

If liquid has been spilled, or objects have fallen into the video product.

If the video product has been exposed to rain or water.

If the video product has been dropped or the cabinet has been damaged.

If the video product does not operate normally be following the operating instructions. Adjust only those controls that are covered by the operating instructions as an improper adjustment of other controls may result in damage and will often require extensive work by a qualified technician to restore the video product to its normal operation.

When the video product exhibits a distinct change in performance - this indicates a need for service.

Replacement Parts: When replacement parts are required, be sure the service technician has used replacement parts specified by the manufacturer or have the same characteristics as the original part. Unauthorized substitutions may result in fire, electric shock or other hazards.

Safety Check: Upon completion of any service or repairs to this video product, ask the service technician to perform safety checks to determine that the video product is in proper operating condition.



Be sure to read this notes before using

Safety Notes



- Make sure that you use your camera correctly. Read these Safety Notes and your *Owner's Manual* carefully before use.
- After reading these Safety Notes, store them in a safe place.

About the Icons

The icons shown below are used in this document to indicate the severity of the injury or damage that can result if the information indicated by the icon is ignored and the product is used incorrectly as a result.

| | | |
|--|----------------|---|
|  | WARNING | This icon indicates that death or serious injury can result if the information is ignored. |
|  | CAUTION | This icon indicates that personal injury or material damage can result if the information is ignored. |









The icons shown below are used to indicate the nature of the information which is to be observed.

| | |
|--|---|
|  | Triangular icons tell you that this information requires attention ("important"). |
|  | Circular icons with a diagonal bar tell you that the action indicated is prohibited ("Prohibited"). |
|  | Filled circles with an exclamation mark tell you an action that must be performed ("Required"). |

WARNING

| | |
|--|--|
|  | If a problem arises, turn the camera off, remove the battery, disconnect and unplug the AC power adapter. |
| | Continued use of the camera when it is emitting smoke, is emitting any unusual odor, or is in any other abnormal state can cause a fire or electric shock. |
| | • Contact your FUJIFILM dealer. |

WARNING

| | |
|---|---|
|  | Do not allow water or foreign objects to enter the camera. |
| | If water or foreign objects get inside the camera, turn the camera off, remove the battery and disconnect and unplug the AC power adapter. Continued use of the camera can cause a fire or electric shock. • Contact your FUJIFILM dealer. |
|  | Do not use the camera in the bathroom or shower. |
| <i>Do not use in the bathroom or shower.</i> | This can cause a fire or electric shock. |
|  | Never attempt to disassemble or modify (never open the case). |
| <i>Do not disassemble</i> | Failure to observe this precaution can cause fire or electric shock. |
|  | Should the case break open as the result of a fall or other accident, do not touch the exposed parts. |
| <i>Do not touch internal parts</i> | Failure to observe this precaution could result in electric shock or injury from touching the damaged parts. Remove the battery immediately, taking care to avoid injury or electric shock, and take the product to the point of purchase for consultation. |
|  | Do not change, heat or unduly twist or pull the connection cord and do not place heavy objects on the connection cord. |
| | These actions could damage the cord and cause a fire or electric shock. • If the cord is damaged, contact your FUJIFILM dealer. |
|  | Do not place the camera on an unstable surface. |
| | This can cause the camera to fall or tip over and cause injury. |
|  | Never attempt to take pictures while in motion. |
| | Do not use the camera while you are walking or driving a vehicle. This can result in you falling down or being involved in a traffic accident. |
|  | Do not touch any metal parts of the camera during a thunderstorm. |
| | This can cause an electric shock due to induced current from the lightning discharge. |
|  | Do not use the battery except as specified. |
| | Load the battery as aligned with the indicator. |

! WARNING

Do not heat, charge or take apart the battery. Do not drop or subject the battery to impacts. Do not store the battery with metallic products. Do not use chargers other than the specified model to charge the battery.

Any of these actions can cause the battery to burst or leak and cause fire or injury as a result.



Use only the battery or AC power adapters specified for use with this camera. Do not use voltages other than the power supply voltage shown.

The use of other power sources can cause a fire.



If the battery leaks and fluid gets in contact with your eyes, skin or clothing. Flush the affected area with clean water and seek medical attention or call an emergency number right away.



Do not use the charger to charge batteries other than those specified here.

The Ni-MH battery charger is designed for FUJIFILM HR-AA Ni-MH batteries. Using the charger to charge conventional batteries or other types of rechargeable batteries can cause the battery to leak fluid, overheat or burst.



Danger of explosion if battery is incorrectly replaced. Replace only with the same or equivalent type.



Do not use in the presence of flammable objects, explosive gases, or dust.



When carrying the battery, install it in a digital camera or keep it in the hard case. When storing the battery, keep it in the hard case. When discarding, cover the battery terminals with insulation tape.

Contact with other metallic objects or battery could cause the battery to ignite or burst.



Keep Memory Cards out of the reach of small children.

Because Memory Cards are small, they can be swallowed by children. Be sure to store Memory Cards out of the reach of small children. If a child swallows a Memory Card, seek medical attention or call an emergency number.

! CAUTION

Do not use this camera in locations affected by oil fumes, steam, humidity or dust.

This can cause a fire or electric shock.

! CAUTION

Do not leave this camera in places subject to extremely high temperatures.

Do not leave the camera in locations such as a sealed vehicle or in direct sunlight. This can cause a fire.



Keep out of the reach of small children.

This product could cause injury in the hands of a child.



Do not place heavy objects on the camera.

This can cause the heavy object to tip over or fall and cause injury.



Do not move the camera while the AC power adapter is still connected. Do not pull on the connection cord to disconnect the AC power adapter.

This can damage the power cord or cables and cause a fire or electric shock.



Do not use the AC power adapter when the plug is damaged or the plug socket connection is loose.

This could cause a fire or electric shock.



Do not cover or wrap the camera or the AC power adapter in a cloth or blanket.

This can cause heat to build up and distort the casing or cause a fire.



When you are cleaning the camera or you do not plan to use the camera for an extended period, remove the battery and disconnect and unplug the AC power adapter.

Failure to do so can cause a fire or electric shock.



When charging ends, unplug the charger from the power socket.

Leaving the charger plugged into the power socket can cause a fire.



Using a flash too close to a person's eyes may temporarily affect the eyesight.

Take particular care when photographing infants and young children.



When a memory card is removed, the card could come out of the slot too quickly. Use your finger to hold it and gently release the card.



Request regular internal testing and cleaning for your camera.

Build-up of dust in your camera can cause a fire or electric shock.

- Contact your FUJIFILM dealer to request internal cleaning every 2 years.
- Please note this is not a free of charge service.



Remove your fingers from the flash window before the flash fires.

Failure to observe this precaution could result in burns.



Keep the flash window clean and do not use the flash if the window is obstructed.

Failure to observe these precautions could cause smoke or discoloration.

Power Supply and Battery

* Confirm your battery type before reading the following descriptions.

The following explains proper use of batteries and how to prolong their life. Incorrect use of batteries can cause shorter battery life, as well as leakage, excessive heat, fire or explosion.

1 Camera uses the Rechargeable Lithium-ion Battery

- * When shipped, the battery is not fully charged. Always charge the battery before using it.
- * When carrying the battery, install it in a digital camera or keep it in the soft case.

■ Battery Features

- The battery gradually loses its charge even when not used. Use a battery that has been charged recently (in the last day or two) to take pictures.
- To maximize the life of the battery, turn the camera off as quickly as possible when it is not being used.
- The number of available frames will be lower in cold locations or at low temperatures. Take along a spare fully charged battery. You can also increase the amount of power produced by putting the battery in your pocket or another warm place to heat it and then loading it into the camera just before you take a picture.

If you are using a heating pad, take care not to place the battery directly against the pad. The camera may not operate if you use a depleted battery in cold conditions.

■ Charging the Battery

- You can charge the battery using the battery charger (included).
 - The battery can be charged at ambient temperatures between 0°C and +40°C (+32°F and +104°F). Refer to the *Owner's Manual* for the time of charging battery.
 - You should charge the battery at an ambient temperature between +10°C and +35°C (+50°F and +95°F). If you charge the battery at a temperature outside this range, charging takes longer because the performance of the battery is impaired.
 - You cannot charge the battery at temperatures of 0°C (+32°F) or below.
- The Rechargeable Lithium-ion Battery does not need to be fully discharged or exhausted flat before being charged.
- The battery may feel warm after it has been charged or immediately after being used. This is perfectly normal.
- Do not recharge a fully charged battery.

■ Battery Life

At normal temperatures, the battery can be used at least 300 times. If the time for which the battery provides power shortens markedly, this indicates that the battery has reached the end of its effective life and should be replaced.

■ Notes on storage

- If a battery is stored for long periods while charged, the performance of the battery can be impaired. If the battery will not be used for some time, run the battery out before storing it.
- If you do not intend to use the camera for a long period of time, remove the battery from the camera.
- Store the battery in a cool place.
 - The battery should be stored in a dry location with an ambient temperature between +15°C and +25°C (+59°F and +77°F).
 - Do not leave the battery in hot or extremely cold places.

■ Handling the Battery Cautions for Your Safety:

- Do not carry or store battery with metal objects such as necklaces or hairpins.
- Do not heat the battery or throw it into a fire.
- Do not attempt to take apart or change the battery.
- Do not recharge the battery with chargers other than those specified.

- Dispose of used battery promptly.
- Do not drop the battery or otherwise subject it to strong impacts.
- Do not expose the battery to water.
- Always keep the battery terminals clean.
- Do not store batteries in hot places. Also, if you use the battery for a long period, the camera body and the battery itself will become warm. This is normal. Use the AC power adapter if you are taking pictures or viewing images for a long period of time.

2 Camera uses AA Alkaline, Rechargeable Ni-MH (nickel-metal hydride) or AA lithium batteries

* For details on the batteries that you can use, refer to the *Owner's Manual* of your camera.

■ Cautions for Using Battery

- Do not heat the batteries or throw them into a fire.
- Do not carry or store batteries with metal objects such as necklaces or hairpins.
- Do not expose the batteries to water, and keep batteries from getting wet or stored in moist locations.
- Do not attempt to take apart or change the batteries, including battery casings.
- Do not subject the batteries to strong impacts.
- Do not use batteries that are leaking, deformed, discolored.

- Do not store batteries in warm or humid places.
- Keep the batteries out of reach of babies and small children.
- Make sure that the battery polarity (⊕ and ⊖) is correct.
- Do not use new with used batteries. Do not use charged and discharged batteries together.
- Do not use different types or brands of batteries at the same time.
- If you do not intend to use the camera for a long period of time, remove the batteries from the camera. Note if the camera is left with the batteries removed, the time and date settings are cleared.
- The batteries feel warm right after being used. Before removing the batteries, turn the camera off and wait for the batteries to cool down.
- Since batteries do not work well in cold weather or locations, warm the batteries by placing them inside your garments before use. Batteries do not work well when cold. They will work again when the temperature returns to normal.
- Soil (such as fingerprints) on the battery terminals makes the batteries charge less reducing the number of images. Carefully wipe the battery terminals with a soft dry cloth before loading.



If any liquid at all leaks from the batteries, wipe the battery compartment thoroughly and then load new batteries.



If any battery fluid comes into contact with your hands or clothing, flush the area thoroughly with water. Note that battery fluid can cause loss of eyesight if it gets into your eyes. If this occurs, do not rub your eyes. Flush the fluid out with clean water and contact your physician for treatment.

■ Using the AA-size Ni-MH batteries correctly

- Ni-MH batteries left unused in storage for long periods can become “deactivated”. Also, repeatedly charging Ni-MH batteries that are only partially discharged can cause them to suffer from the “memory effect”. Ni-MH batteries that are “deactivated” or affected by “memory” suffer from the problem of only providing power for a short time after being charged. To prevent this problem, discharge and recharge them several times using the camera’s “Discharging rechargeable batteries” function. Deactivation and memory are specific to Ni-MH batteries and are not in fact battery faults.

See *Owner’s Manual* for the procedure for “Discharging rechargeable batteries”.

⚠ CAUTION

Do not use the “Discharging rechargeable batteries” function when alkaline batteries being used.

- To charge Ni-MH batteries, use the quick battery charger (sold separately). Refer to the instructions supplied with the charger to make sure that the charger is used correctly.
- Do not use the battery charger to charge other batteries.
- Note that the batteries feel warm after being charged.
- Due to the way the camera is constructed, a small amount of current is used even when the camera is turned off. Note in particular that leaving Ni-MH batteries in the camera for a long period will over-discharge the batteries and may render them unusable even after recharging.
- Ni-MH batteries will self-discharge even when not used, and the time for which they can be used may be shortened as a result.
- Ni-MH batteries will deteriorate rapidly if over-discharged (e.g. by discharging the batteries in a flashlight). Use the “Discharging rechargeable batteries” function provided in the camera to discharge the batteries.

- Ni-MH batteries have a limited service life. If a battery can only be used for a short time even after repeated discharge-charge cycles, it may have reached the end of its service life.

■ Disposing of Batteries

- When disposing of batteries, do so in accordance with your local waste disposal regulations.

3 Notes on both models (1 2)

■ AC Power Adapter

Always use the AC Power Adapter with the camera. The use of an AC Power adapter other than FUJIFILM AC Power Adapter can be damaged to your digital camera.

For details on the AC power adapter, refer to the *Owner’s Manual* of your camera.

- Use the AC power adapter for indoor use only.
- Plug the connection cord plug securely into the DC input terminal.
- Turn off the FUJIFILM Digital camera before disconnecting the cord from the DC input terminal. To disconnect, pull out the plug gently. Do not pull on the cord.
- Do not use the AC power adapter with any device other than your camera.
- During use, the AC power adapter will become hot to the touch. This is normal.

- Do not take apart the AC power adapter. Doing so could be dangerous.
- Do not use the AC power adapter in a hot and humid place.
- Do not subject the AC power adapter to strong shocks.
- The AC power adapter may emit a humming. This is normal.
- If used near a radio, the AC power adapter may cause static. If this happens, move the camera away from the radio.

Before Using the Camera

Do not aim the camera at extremely bright light sources, such as the sun in a cloudless sky. Failure to observe this precaution could damage the camera image sensor.

■ Test Shots Prior to Photography

For important photographs (such as weddings and overseas trips), always take a test shot and view the image to make sure that the camera is working normally.

- FUJIFILM Corporation cannot accept liability for any incidental losses (such as the costs of photography or the loss of income from photography) incurred as a result of faults with this product.

■ Notes on Copyright

Images recorded using your digital camera system cannot be used in ways that infringe copyright laws without the consent of the owner,

unless intended only for personal use. Note that some restrictions apply to the photographing of stage performances, entertainments and exhibits, even when intended purely for personal use. Users are also asked to note that the transfer of Memory Card containing images or data protected under copyright laws is only permissible within the restrictions imposed by those copyright laws.

■ Handling Your Digital Camera

To ensure that images are recorded correctly, do not subject the camera to impact or shock while an image is being recorded.

■ Liquid Crystal

If the LCD monitor is damaged, take particular care with the liquid crystal in the monitor. If any of the following situations arise, take the urgent action indicated.

- If liquid crystal comes in contact with your skin:
Wipe the area with a cloth and then wash thoroughly with soap and running water.
- If liquid crystal gets into your eye:
Flush the affected eye with clean water for at least 15 minutes and then seek medical assistance.
- If liquid crystal is swallowed:
Flush your mouth thoroughly with water. Drink large quantities of water and induce vomiting. Then seek medical assistance.

Although the LCD panel is produced with highly sophisticated technologies, there may be black spots or permanently lit spots. This is not a malfunction, and does not affect recorded images.

■ Trademark Information

xD-Picture Card and  are trademarks of FUJIFILM Corporation. The typefaces included herein are solely developed by DynaComware Taiwan Inc. Macintosh, QuickTime, and Mac OS are trademarks of Apple Inc. in the U.S.A. and other countries. Windows 8, Windows 7, Windows Vista, and the Windows logo are trademarks of the Microsoft group of companies. Adobe and Adobe Reader are either trademarks or registered trademarks of Adobe Systems Incorporated in the U.S.A. and/ or other countries. The SDHC and SDXC logos are trademarks of SD-3C, LLC. The HDMI logo is a trademark. YouTube is a trademark of Google Inc. Facebook is a trademark of Facebook, Inc. All other trade names mentioned in this manual are the trademarks or registered trademarks of their respective owners.

■ Notes on Electrical Interference

If the camera is to be used in hospitals or aircrafts, please note that this camera may cause interference to other equipment in the hospital or aircraft. For details, please check with the applicable regulations.

■ Explanation of Color Television System

NTSC: National Television System Committee, color television telecasting specifications adopted mainly in the U.S.A., Canada and Japan.

PAL: Phase Alternation by Line, a color television system adopted mainly by European countries and China.

■ Exif Print (Exif ver. 2.3)

Exif Print Format is a newly revised digital camera file format that contains a variety of shooting information for optimal printing.

IMPORTANT NOTICE: Read Before Using the Software

Direct or indirect export, in whole or in part, of licensed software without the permission of the applicable governing bodies is prohibited.

About This Manual

Before using the camera, read this manual and the warnings on pages ii–viii. For information on specific topics, consult the sources below.

✓ *Camera Q & A* *x*

Know what you want to do but don't know the name for it? Find the answer in "Camera Q & A."

✓ *Table of Contents* *xiii*

The "Table of Contents" gives an overview of the entire manual. The principal camera operations are listed here.

✓ *Troubleshooting* *104*

Having a specific problem with the camera? Find the answer here.

✓ *Warning Messages and Displays* *112*

Find out what's behind that flashing icon or error message in the display.

Memory Cards

Pictures can be stored in an optional SD, SDHC, and SDXC memory cards ( 9), referred to in this manual as "memory cards".

Camera Q & A

Find items by task.

Camera Setup

| Question | Key phrase | See page |
|--|------------------------------|----------|
| How do I set the camera clock? | Date and time | 13 |
| Can I set the clock to local time when I travel? | Time difference | 95 |
| How do I keep the display from turning off automatically? | Auto power off | 98 |
| How do I make the display brighter or darker? | LCD brightness | 98 |
| How do I stop the camera beeping and clicking? | Operation and shutter volume | 92 |
| | Silent mode | 17 |
| Can I change the sound the shutter makes? | Shutter sound | 92 |
| What do the icons in the display mean? | Displays | 4 |
| How much charge is left in the battery? | Battery level | 15 |
| Can I increase the capacity of rechargeable Ni-MH batteries? | Discharge | 99 |
| Can I add shooting date and time to the pictures? | Date stamp | 100 |

Sharing Pictures

| Question | Key phrase | See page |
|--|-------------------|----------|
| Can I print pictures on my home printer? | Printing pictures | 60 |

Taking Pictures

| Question | Key phrase | See page |
|--|------------------------------------|----------|
| How can I avoid blurred pictures? | Dual IS mode | 16 |
| How can I make good portraits? | Intelligent Face Detection | 32 |
| Can the camera automatically adjust settings for different scenes? | SR/AUTO mode | 14 |
| Can I choose my own settings for different scenes? | Scene position | 20 |
| How can I be sure my subject is smiling when I take a photograph? | Smile detection | 21 |
| How can I be sure that nobody blinked when the photo was taken? | Blink detection | 33 |
| How do I shoot close-ups? | Macro mode (close-ups) | 36 |
| How do I keep the flash from firing? | Flash mode | 37 |
| How do I stop my subjects' eyes glowing red when I use the flash? | | |
| How do I "fill-in" shadows on back-lit subjects? | | |
| How do I take a series of pictures in a single burst? | Continuous Shooting mode | 41 |
| How do I take a group portrait that includes the photographer? | Self-timer mode | 39 |
| How do I shoot a panorama? | Motion panorama | 25 |
| Can I choose shutter speed and aperture? | P, S, A, and M modes | 27 |
| Can I save and recall camera settings? | C mode | 31 |
| How do I adjust exposure? | Exposure compensation | 45 |
| How do I keep a moving subject in focus? | Tracking | 78 |
| How do I shoot movies? | Recording movies | 56 |

Viewing Pictures

| Question | Key phrase | See page |
|---|--|----------|
| How do I view my pictures? | Single-frame playback | 47 |
| How can I delete pictures easily? | The  button | 19 |
| How can I select and delete individual pictures or delete all pictures at once? | Deleting pictures | 55 |
| Can I zoom in on pictures during playback? | Playback zoom | 48 |
| Can I mark images with favorite (★) rating? | ★ Favorites | 48 |
| How do I view a lot of pictures at once? | Multi-frame playback | 50 |
| Can I create photobooks from my favorite pictures? | Photobook assist | 52 |
| How do I find pictures? | Image search | 54 |
| Can I protect my pictures from accidental deletion? | Protect | 85 |
| Can I hide the icons in the display when viewing my pictures? | Choosing a display format | 47 |
| Can I select pictures for upload to YouTube™? | Uploading pictures | 81 |
| Can I select pictures for upload to Facebook? | | |

Table of Contents

| | |
|-------------------------------------|----|
| For Your Safety | ii |
| IMPORTANT SAFETY INSTRUCTIONS | ii |
| Safety Notes | iv |
| About This Manual | ix |
| Camera Q & A | x |

Before You Begin

| | |
|-------------------------------|---|
| Introduction | 1 |
| Symbols and Conventions | 1 |
| Supplied Accessories | 1 |
| Parts of the Camera | 2 |
| Camera Displays | 4 |
| The Mode Dial | 5 |

First Steps

| | |
|-------------------------------------|----|
| The Strap and Lens Cap | 6 |
| Inserting the Batteries | 7 |
| Inserting a Memory Card | 9 |
| Turning the Camera On and Off | 12 |
| Shooting Mode | 12 |
| Playback Mode | 12 |
| Basic Setup | 13 |



Basic Photography and Playback

| | |
|--|----|
| Taking Pictures in SR/AUTO (Scene Recognition) Mode | 14 |
| Viewing Pictures | 19 |

More on Photography

| | |
|---|----|
| Shooting Mode | 20 |
| SR/AUTO SCENE RECOGNITION | 20 |
| 📷 AUTO | 20 |
| SP1/SP2 SCENE POSITION | 20 |
| PANORAMA MOTION PANORAMA | 25 |
| P : PROGRAM AE | 27 |
| S : SHUTTER PRIORITY AE | 28 |
| A : APERTURE PRIORITY AE | 29 |
| M : MANUAL | 30 |
| C : CUSTOM MODE | 31 |
| Intelligent Face Detection | 32 |
| Blink Detection | 33 |
| Focus Lock | 34 |
| 📷 Macro and Super Macro Modes (Close-ups) | 36 |
| ⚡ Using the Flash (Intelligent Flash) | 37 |
| 🕒 Using the Self-Timer | 39 |
| 📷 Continuous Shooting (Burst Mode) | 41 |
| 📷 Instant Zoom | 43 |
| 📷 Exposure Compensation | 45 |

More on Playback

| | |
|---|----|
| Playback Options | 47 |
| Playback Zoom..... | 48 |
| ★ Favorites: Rating Pictures | 48 |
| Viewing Photo Information..... | 49 |
| Multi-Frame Playback..... | 50 |
| Viewing Panoramas | 51 |
|  PhotoBook Assist | 52 |
| Creating a PhotoBook | 52 |
| Viewing PhotoBooks | 53 |
| Editing and Deleting PhotoBooks | 53 |
|  Image Search | 54 |
|  Deleting Pictures | 55 |



















Movies











| | |
|--|----|
|  Recording Movies | 56 |
| Movie Frame Size | 57 |
|  Viewing Movies | 58 |

Connections

| | |
|--|----|
| Viewing Pictures on TV | 59 |
| Connecting the Camera to High Definition (HD) TVs | 59 |
| Printing Pictures via USB | 60 |
| Connecting the Camera | 60 |
| Printing Selected Pictures | 60 |
| Printing the DPOF Print Order..... | 61 |
| Creating a DPOF Print Order..... | 63 |
| Viewing Pictures on a Computer | 66 |
| Windows: Installing MyFinePix Studio..... | 66 |
| Importing pictures or movies to Mac (Macintosh)..... | 68 |
| Connecting the Camera | 68 |

Menus

| | |
|---|----|
| Using the Menus: Shooting Mode | 70 |
| Using the Shooting Menu..... | 70 |
| Shooting Menu Options..... | 71 |
| ISO ISO | 73 |
|  IMAGE SIZE..... | 73 |
|  IMAGE QUALITY | 74 |
|  FINEPIX COLOR..... | 75 |
|  WHITE BALANCE | 75 |
|  SHARPNESS | 76 |
|  PHOTOMETRY | 77 |
|  AF MODE..... | 77 |
|  MOVIE AF MODE | 78 |
|  AE BKT EV STEPS | 79 |
|  FLASH..... | 79 |
| Using the Menus: Playback Mode | 80 |
| Using the Playback Menu..... | 80 |
| Playback Menu Options..... | 80 |
|  MARK FOR UPLOAD..... | 81 |
|  SLIDE SHOW | 83 |
|  RED EYE REMOVAL | 84 |
|  PROTECT | 85 |
|  CROP..... | 86 |
|  RESIZE | 87 |
|  IMAGE ROTATE..... | 88 |
|  VOICE MEMO | 89 |
|  DISP. ASPECT | 90 |

| | | | |
|--|-----|--|-----|
| The Setup Menu | 91 | Technical Notes | |
| Using the Setup Menu..... | 91 | Optional Accessories | 101 |
| Setup Menu Options..... | 92 | Accessories from FUJIFILM | 102 |
|  TIME DIFFERENCE..... | 95 | Caring for the Camera | 103 |
|  FORMAT..... | 96 | | |
|  IMAGE DISP. | 96 | Troubleshooting | |
|  FRAME NO. | 97 | Troubleshooting | 104 |
|  PLAYBACK VOLUME..... | 98 | Warning Messages and Displays | 112 |
|  LCD BRIGHTNESS..... | 98 | | |
|  LCD MODE 2 | 98 | Appendix | |
|  AUTO POWER OFF | 98 | Memory Card Capacity | 116 |
|  DIGITAL ZOOM | 99 | Specifications | 117 |
|  DISCHARGE (Ni-MH Batteries Only) | 99 | | |
|  DATE STAMP..... | 100 | | |

Introduction

Symbols and Conventions

The following symbols are used in this manual:

 **Caution:** This information should be read before use to ensure correct operation.

 **Note:** Points to note when using the camera.

 **Tip:** Additional information that may be helpful when using the camera.

 Other pages in this manual on which related information may be found.

Menus and other text in the camera monitor are shown in bold. In the illustrations in this manual, the monitor display may be simplified for explanatory purposes.

Supplied Accessories

The following items are included with the camera:

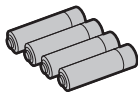

AA alkaline (LR6) batteries (x4)

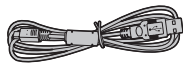

USB cable

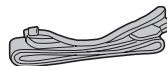

Strap



Lens cap

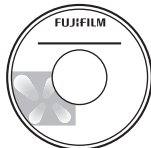



CD-ROM

• Basic Manual

Parts of the Camera

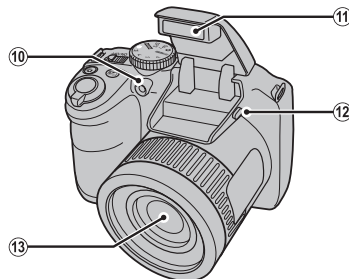
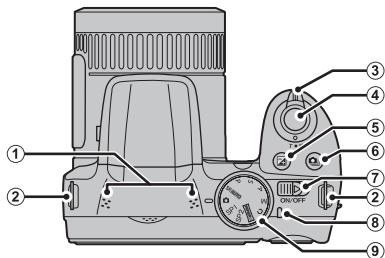
For more information, refer to the page listed to the right of each item.



| | | |
|---|---|--------------------------------------|
| 1 Microphone.....56, 89 | 6  (burst mode) button.....41 | 11 Flash.....37 |
| 2 Strap eyelet.....6 | 7 ON/OFF switch.....14 | 12 Flash pop-up button.....37 |
| 3 Zoom control.....15, 48, 50 | 8 Indicator lamp.....18 | 13 Lens.....14, 117 |
| 4 Shutter button.....18 | 9 Mode dial.....5 | |
| 5  (exposure compensation/photo info) button.....45, 49 | 10 AF-assist illuminator.....35 | |
| | Self-timer lamp.....39 | |

* Illustrations in this manual may be simplified for explanatory purposes.

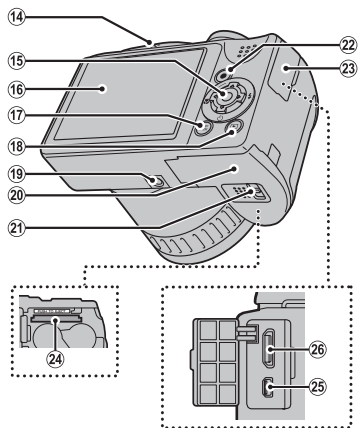

| | | | | | |
|----|---|------------|----|----------------------------------|------------|
| 14 | Speaker | 58, 90 | 20 | Battery-chamber cover | 7 |
| 15 | Selector button (see below) | | 21 | Battery-chamber latch | 7 |
| 16 | Monitor | 4 | 22 | ⊙ (movie recording) button | 56 |
| 17 | DISP (display)/ BACK button | 16, 17, 47 | 23 | Terminal cover | 59, 60, 68 |
| 18 | ▶ (playback) button | 19, 47 | 24 | Memory card slot | 10 |
| 19 | Tripod mount | | 25 | USB multi-connector | 59, 60, 68 |
| | | | 26 | HDMI Mini Connector | 59 |

● The Selector Button

Move cursor up

⏏ (instant zoom) button (📖 43)

🗑 (delete) button (📖 19)

MENU/OK button

(📖 13, 70, 80, 91)

Move cursor left

⏪ (macro) button (📖 36)

Move cursor right

⚡ (flash) button (📖 37)

Move cursor down

⌚ (self-timer) button (📖 39)

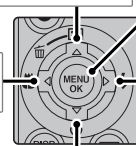

Camera Displays

The following indicators may appear during shooting and playback. The indicators displayed vary with camera settings.

Shooting

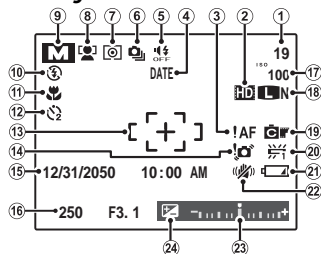

| | | | | | |
|----|---|-----|----|--------------------------------------|--------------|
| 1 | Number of available frames..... | 116 | 13 | Focus frame..... | 77 |
| 2 | Movie mode..... | 57 | 14 | Blur warning..... | 37, 108, 112 |
| 3 | Focus warning..... | 17 | 15 | Date and time..... | 13 |
| 4 | Date stamp..... | 100 | 16 | Shutter speed and aperture..... | 27 |
| 5 | Silent mode..... | 17 | 17 | Sensitivity..... | 73 |
| 6 | Burst mode..... | 41 | 18 | Image size/Image quality..... | 73, 74 |
| 7 | Metering..... | 77 | 19 | FinePix color..... | 75 |
| 8 | Intelligent Face Detection indicator..... | 32 | 20 | White balance..... | 75 |
| 9 | Shooting mode..... | 20 | 21 | Battery level..... | 15 |
| 10 | Flash mode..... | 37 | 22 | Dual IS mode..... | 16 |
| 11 | Macro (close-ups) mode..... | 36 | 23 | Exposure indicator..... | 45 |
| 12 | Self-timer indicator..... | 39 | 24 | Exposure compensation indicator..... | 45 |

Playback

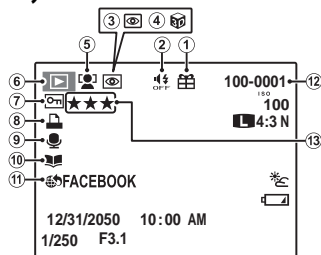

| | | | | | |
|---|---|--------|----|---------------------------------|----|
| 1 | Gift image..... | 47 | 7 | Protected image..... | 85 |
| 2 | Silent mode..... | 17 | 8 | DPOF print indicator..... | 63 |
| 3 | Red-eye removal indicator..... | 84 | 9 | Voice memo indicator..... | 89 |
| 4 | 3D image..... | 23 | 10 | Photobook assist indicator..... | 52 |
| 5 | Intelligent Face Detection indicator..... | 32 | 11 | Mark for upload to..... | 81 |
| 6 | Playback mode indicator..... | 19, 47 | 12 | Frame number..... | 97 |
| | | | 13 | Rating..... | 48 |

The Mode Dial

To select a shooting mode, align the mode icon with the mark next to the mode dial.

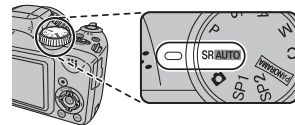

SRAUTO (SCENE RECOGNITION): A “point-and-shoot” mode in which the camera automatically adjusts settings to suit the scene (📖 14).

📷 (AUTO): A simple “point-and-shoot” mode recommended for first-time users of digital cameras (📖 20).

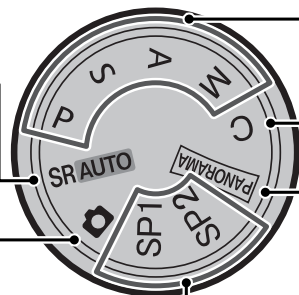

P, S, A, M: Select for full control over camera settings, including aperture (**M** and **A**) and/or shutter speed (**M** and **S**) (📖 27).

C (CUSTOM): Recall stored settings for modes **P**, **S**, **A**, and **M** (📖 31).

PANORAMA (MOTION PANORAMA): Take a series of photographs and combine them to form a panorama (📖 25).

SP1/SP2 (SCENE POSITION): Choose a scene suited to the subject or shooting conditions and let the camera do the rest (📖 20).

The Strap and Lens Cap

Attaching the Strap

Attach the strap to the two strap eyelets as shown below.

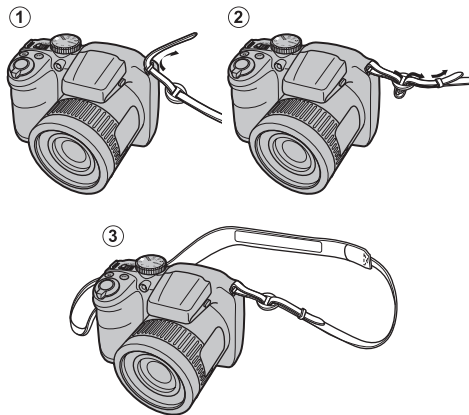

Caution

To avoid dropping the camera, be sure the strap is correctly secured.

The Lens Cap

Attach the lens cap as shown.

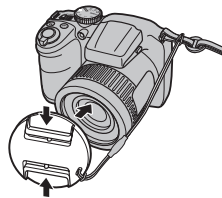

To avoid losing the lens cap, pass the supplied string through the eyelet (①) and secure the lens cap to the strap (②).

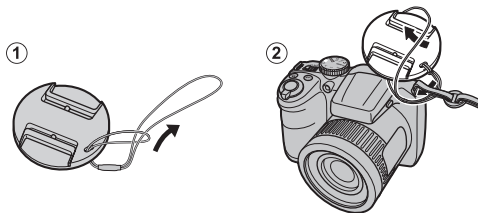

Inserting the Batteries

The camera takes four AA alkaline, lithium, or rechargeable Ni-MH batteries. A set of four alkaline batteries is supplied with the camera. Insert the batteries in the camera as described below.

1 Open the battery-chamber cover.

Slide the battery-chamber latch in the direction shown and open the battery-chamber cover.

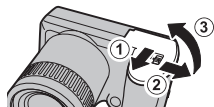

Note

Be sure the camera is off before opening the battery-chamber cover.

Cautions

- Do not open the battery-chamber cover when the camera is on. Failure to observe this precaution could result in damage to image files or memory cards.
- Do not use excessive force when handling the battery-chamber cover.

2 Insert the batteries.

Insert the batteries in the orientation shown by the “+” and “-” marks inside the battery chamber.

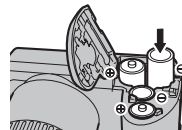

Cautions

- Insert the batteries in the correct orientation.
- **Never use batteries with peeling or damaged casing or mix old and new batteries, batteries with different charge levels, or batteries of different types.**
Failure to observe these precautions could result in the batteries leaking or overheating.
- **Never use manganese or Ni-Cd batteries.**
- The capacity of alkaline batteries varies with the manufacturer and drops at temperatures below 10°C/50°F; Ni-MH batteries are recommended.
- Fingerprints and other soil on the battery terminals can shorten battery life.

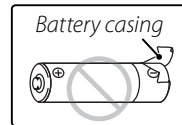

3 Close the battery-chamber cover.

Close the battery-chamber cover and slide it in until the latch clicks into place.

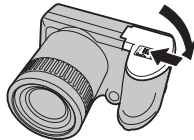

Caution

Do not use force. If the battery-chamber cover does not close, check that the batteries are in the correct orientation and try again.

Tip: Using an AC Power Adapter

The camera can be powered by an optional AC power adapter and DC coupler (sold separately).

Choosing the Battery Type

After replacing the batteries with batteries of a different type, select the battery type using the  **BATTERY TYPE** option in the setup menu (94) to ensure that the battery level is displayed correctly and the camera does not turn off unexpectedly.

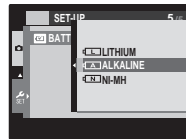

Inserting a Memory Card

The camera can store pictures on SD, SDHC, and SDXC memory cards (sold separately).

■ **Compatible Memory Cards**

FUJIFILM and SanDisk SD, SDHC, and SDXC memory cards have been approved for use in the camera. A complete list of approved memory cards is available at http://www.fujifilm.com/products/digital_cameras/index.html. Operation is not guaranteed with other cards. The camera can not be used with *xD-Picture Cards* or MultiMediaCard (MMC) devices.

⚠ **Caution**

Memory cards can be locked, making it impossible to format the card or to record or delete images. Before inserting a memory card, slide the write-protect switch to the unlocked position.

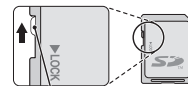

Write-protect
switch

■ Inserting a Memory Card

1 Open the battery-chamber cover.

← Note

Be sure the camera is off before opening the battery-chamber cover.

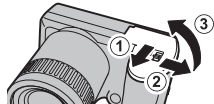

2 Insert the memory card.

Holding the memory card in the orientation shown below, slide it in until it clicks into place at the back of the slot.

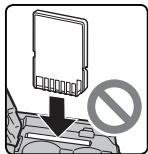
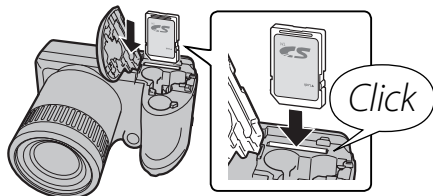

Be sure card is in correct orientation; do not insert at an angle or use force.

3 Close the battery-chamber cover.

Close the battery-chamber cover and slide it in until the latch clicks into place.

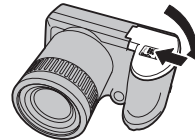

● Removing Memory Cards

After confirming that the camera is off, press the card in and then release it slowly. The card can now be removed by hand.

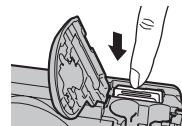

⚠ Cautions

- The memory card may spring out if you remove your finger immediately after pushing the card in.
- Memory cards may be warm to the touch after being removed from the camera. This is normal and does not indicate a malfunction.

Cautions

- **Do not turn the camera off or remove the memory card while the memory card is being formatted or data are being recorded to or deleted from the card.** Failure to observe this precaution could damage the card.
- Format SD/SDHC/SDXC memory cards before first use, and be sure to reformat all memory cards after using them in a computer or other device. For more information on formatting memory cards, see page 96.
- Memory cards are small and can be swallowed; keep out of reach of children. If a child swallows a memory card, seek medical assistance immediately.
- miniSD or microSD adapters that are larger or smaller than the standard dimensions of an SD/SDHC/SDXC card may not eject normally; if the card does not eject, take the camera to an authorized service representative. Do not forcibly remove the card.
- Do not affix labels to memory cards. Peeling labels can cause camera malfunction.
- Movie recording may be interrupted with some types of SD/SDHC/SDXC memory card. Use a CLASS 4 card or better when shooting HD movies.
- Formatting a memory card in the camera creates a folder in which pictures are stored. Do not rename or delete this folder or use a computer or other device to edit, delete, or rename image files. Always use the camera to delete pictures from memory cards; before editing or renaming files, copy them to a computer and edit or rename the copies, not the originals.

Turning the Camera On and Off

Shooting Mode

Slide the **ON/OFF** switch in the direction shown below. The lens will extend automatically.

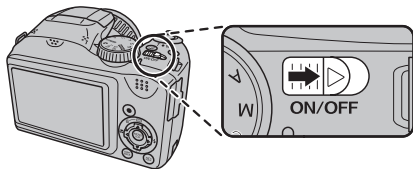

Slide the **ON/OFF** switch to turn the camera off.



Tip: Switching to Playback Mode

Press the  button to start playback. Press the shutter button halfway to return to shooting mode.

Cautions

- Be sure that the lens cap is removed before turning the camera on.
- Forcibly preventing the lens from extending could cause damage or product malfunction.
- Pictures can be affected by fingerprints and other marks on the lens. Keep the lens clean.
- The **ON/OFF** button does not completely disconnect the camera from its power supply.

Tip: Auto Power Off

The camera will turn off automatically if no operations are performed for the length of time selected in the  **AUTO POWER OFF** menu (see page 98). To turn the camera on, use the **ON/OFF** switch or press the  button for about a second.

Playback Mode

To turn the camera on and begin playback, press the  button for about a second.

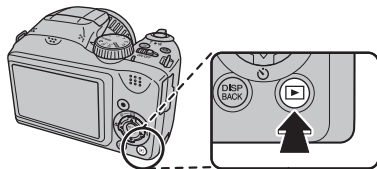

Press the  button again or slide the **ON/OFF** switch to turn the camera off.

Tip: Switching to Shooting Mode

To exit to shooting mode, press the shutter button halfway. Press the  button to return to playback.

Basic Setup

A language-selection dialog is displayed the first time the camera is turned on. Set up the camera as described below (for information on resetting the clock or changing languages, see page 92).

1 Choose a language.



1.1 Press the selector up or down to highlight a language.

1.2 Press **MENU/OK**.



2 Set the date and time.

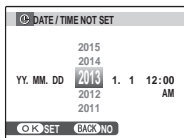

2.1 Press the selector left or right to highlight the year, month, day, hour, or minute and press up or down to change. To change the order in which the year, month, and day are displayed, highlight the date format and press the selector up or down.

2.2 Press **MENU/OK**. A battery type message will be displayed; if the type differs from the type inserted in the camera, use the setup menu **BATTERY TYPE** option (94) to specify the correct type.



Tip: The Camera Clock

If the batteries are removed for an extended period, the camera clock and battery type will be reset and the language-selection dialog will be displayed when the camera is turned on. If the batteries are left in the camera for about 10 hours, the battery can be removed for about 24 hours without resetting the clock, language, or battery type.

Taking Pictures in SR/AUTO (Scene Recognition) Mode

This section describes how to take pictures in SR/AUTO mode.

- 1 Turn the camera on.
Slide the **ON/OFF** switch to turn the camera on.

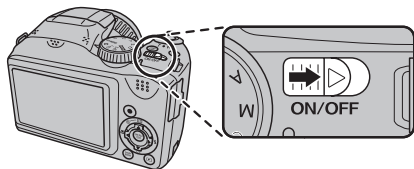

- 2 Select SR/AUTO mode.
Rotate the mode dial to SR/AUTO.

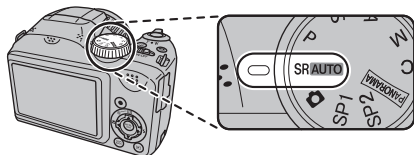

SR/AUTO

In this mode, the camera automatically analyzes the composition and selects a scene according to shooting conditions and the type of subject:





- (PORTRAIT): Human portrait *Selected scene* subject.
- (LANDSCAPE): Man-made or natural landscape.
- (NIGHT): Poorly-lit landscape.
- (MACRO): Subject close to camera.
- (NIGHT PORTRAIT): Poorly-lit portrait subject.
- (BACKLIT PORTRAIT): Back-lit portrait subject.
- (AUTO) is selected if none of the above are detected.

3 Check the battery level.

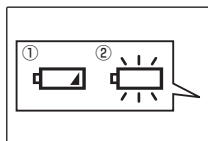
Check the battery level in the display.



| Indicator | Description |
|--|---|
| NO ICON | Batteries are partially discharged. |
| ①  (red) | Batteries are low. Replace as soon as possible. |
| ②  (blinks red) | Batteries are exhausted. Turn camera off and replace batteries. |

⚡ Note

A battery warning may not be displayed before the camera turns off, particularly if batteries are reused after having once been exhausted. Power consumption varies greatly from mode to mode; the low battery warning () may not be displayed or may be displayed only briefly before the camera turns off in some modes or when switching from shooting to playback mode.

4 Frame the picture.

Use the zoom control to frame the picture in the display.

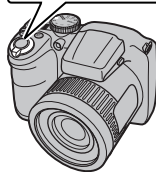
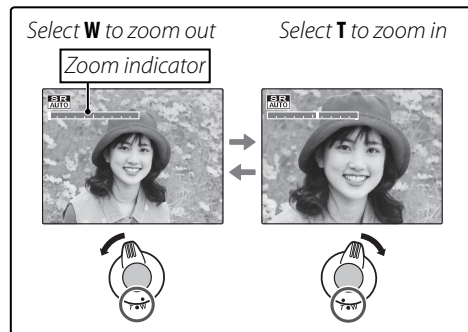

📖 Tip: Focus Lock

Use focus lock () to focus on subjects that are not in the focus frame.

Holding the Camera

Hold the camera steady with both hands and brace your elbows against your sides. Shaking or unsteady hands can blur your shots.

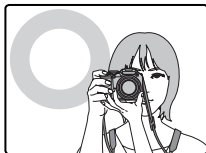



To prevent pictures that are out of focus or too dark (underexposed), keep your fingers and other objects away from the lens and flash.



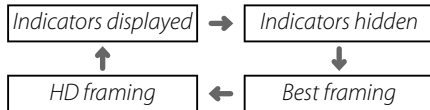

Shooting Information

To choose the shooting information and guides displayed, press the **DISP/BACK** button.



To use best framing, position the main subject at the intersection of two lines or align one of the horizontal lines with the horizon. When HD framing is used, 16:9 aspect ratio guide lines are displayed to make it easy to frame HD shots. Use focus lock ( 34) to focus on subjects that will not be in the center of the frame in the final photograph.

Avoiding Blurred Pictures

If the subject is poorly lit, blurring caused by camera shake can be reduced using the  **DUAL IS MODE** option in the setup menu ( 93). In  mode, blur caused by subject movement is also reduced (dual IS mode).





Sensitivity is raised when dual IS is in effect. Note that blurring may still occur depending on the scene. We recommend that you turn dual IS off when using a tripod.

Silent Mode

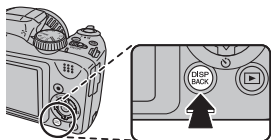
In situations in which camera sounds or lights may be unwelcome, hold the **DISP/BACK** button down until  is displayed (note that silent mode is not available during movie or voice memo playback).



The camera speaker and AF-assist illuminator/self-timer lamp turn off and volume ( 92) can not be adjusted (note that the AF-assist illuminator may still light when  is selected in **SP1/SP2**). To restore normal operation, press the **DISP/BACK** button until the  icon is no longer displayed.

5 Focus.

Press the shutter button halfway to focus.



Note

The lens may make a noise when the camera focuses; this is normal. In **SRAUTO** mode, the camera continuously adjusts focus, increasing the drain on the batteries.

If the camera is able to focus, it will beep twice and the indicator lamp will glow green.

If the camera is unable to focus, the focus frame will turn red, **!AF** will be displayed, and the indicator lamp will blink green. Change the composition or use focus lock ( 34).

6 Shoot.

Smoothly press the shutter button the rest of the way down to take the picture.



Tip: The Shutter Button

The shutter button has two positions. Pressing the shutter button halfway (①) sets focus and exposure; to shoot, press the shutter button the rest of the way down (②).

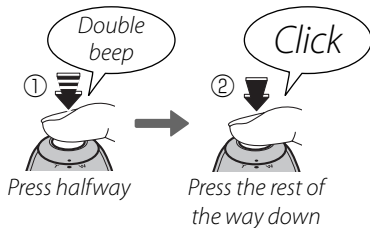

Note

If the subject is poorly lit, the AF-assist illuminator may light to assist focus (see page 35). For information on using the flash when lighting is poor, see page 37.

The Indicator Lamp

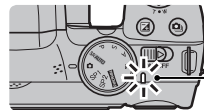

Indicator lamp

The indicator lamp shows camera status as follows:

| Indicator lamp | Camera status |
|-------------------------|--|
| Glows green | Focus locked. |
| Blinks green | Blur, focus, or exposure warning. Picture can be taken. |
| Blinks green and orange | Recording pictures. Additional pictures can be taken. |
| Glows orange | Recording pictures. No additional pictures can be taken at this time. |
| Blinks orange | Flash charging; flash will not fire when picture is taken. |
| Blinks red | Lens or memory error (memory card full or not formatted, format error, or other memory error). |

Tip: Warnings

Detailed warnings appear in the display. See pages 112–115 for more information.

Viewing Pictures

Pictures can be viewed in the monitor. When taking important photographs, take a test shot and check the results.

- 1 Press the  button.

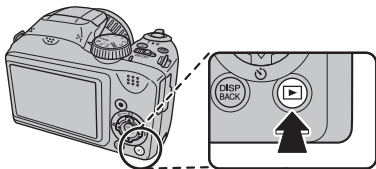

The most recent picture will be displayed in the monitor.



- 2 View additional pictures.

Press the selector right to view pictures in the order recorded, left to view pictures in reverse order.



Press the shutter button to exit to shooting mode.

Deleting Pictures

To delete the picture currently displayed in the monitor, press the selector up (). The following dialog will be displayed.



- Select **FRAME** and press **MENU/OK**.

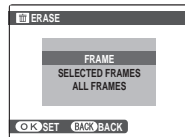



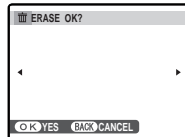

















- To delete the picture, press **MENU/OK**.



To exit without deleting the picture, press **DISP/BACK**.

Tip: The Playback Menu

Pictures can also be deleted from the playback menu ( 80).

| Scene | Description |
|---|--|
|  ZOOM BRACKETING | The camera takes three shots: one at the current zoom ratio, a second zoomed in 1.4x, and a third zoomed in 2x. |
|  NATURAL & ƒ | Get good results with backlit subjects and other difficult lighting. The camera takes two shots: one without the flash and one with. |
|  NATURAL LIGHT | Capture natural light indoors, under low light, or where the flash can not be used. |
|  PORTRAIT | Choose this mode for soft-toned portraits with natural skin tones. |
|  BABY MODE | Choose for natural skin tones when taking portraits of infants. The flash turns off automatically. |
|  SMILE&SHOOT | The shutter is released automatically when Intelligent Face Detection detects a smiling face. |
|  LANDSCAPE | Choose this mode for crisp, clear daylight shots of buildings and landscapes. |
|  SPORT | Choose this mode when photographing moving subjects. Priority is given to faster shutter speeds. |
|  NIGHT | Choose this mode for poorly lit twilight or night scenes. Sensitivity is automatically raised to reduce blur caused by camera shake. |
|  NIGHT (TRIPOD) | Choose this mode for slow shutter speeds when shooting at night. Use a tripod to prevent blur. |
|  FIREWORKS | Slow shutter speeds are used to capture the expanding burst of light from a firework. Press the  button to display a shutter-speed selection dialog and press the selector up and down to choose a shutter speed. |
|  SUNSET | Choose this mode to record the vivid colors in sunrises and sunsets. |
|  SNOW | Choose for crisp, clear shots that capture the brightness of scenes dominated by shining white snow. |
|  BEACH | Choose for crisp, clear shots that capture the brightness of sunlit beaches. |
|  PARTY | Capture indoor background lighting under low-light conditions. |
|  FLOWER | Choose for vivid close-ups of flowers. The camera focuses in the macro range. |
|  TEXT | Take clear pictures of text or drawings in print. The camera focuses in the macro range. |
|  INDIVID. SHUTTER 3D | Take two shots from different angles to create a 3D image. |

Zoom Bracketing

Each time the shutter button is pressed, the camera takes three pictures: one at the current zoom ratio with an image size of **L**, a second zoomed in 1.4× and cropped to **M**, and a third zoomed in 2× and cropped to **S** (pictures will only be taken if there is enough memory for three images). Two frames are displayed to show the areas that will be included in the second and third pictures; the outer frame shows the area that will be recorded at 1.4× zoom, the inner frame the area that will be recorded at 2× zoom. Press the  button to choose from wide and tall crops.

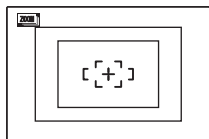

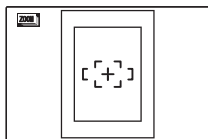

Wide



Tall

Notes

- Digital zoom can not be used. If digital zoom is active when  mode is selected, zoom will be set to the maximum optical zoom position.
- Burst shooting options are limited to  and **OFF**.

Natural &

This mode helps ensure good results with backlit subjects and in other situations with difficult lighting. Before shooting, raise the flash; pictures can only be taken when the flash is raised. Each time the shutter button is pressed, the camera takes two shots: one shot without the flash to preserve natural lighting, followed immediately by a second shot with the flash. Do not move the camera until shooting is complete.

Notes

- Do not use where flash photography is prohibited.
- Only available if memory remains for two pictures.
- Burst mode is not available.

Natural Light

Capture natural light indoors, under low light, or where the flash can not be used. The flash turns off and sensitivity is raised to reduce blur.

INDIVID. SHUTTER 3D

Take two shots from different angles to create a 3D image.

- To choose the order in which the pictures are taken, press the selector right to display the current order and then press the selector left or right to choose from the options below.

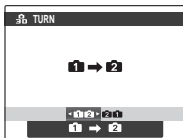

1 → **2**: Take the left shot first.

2 ← **1**: Take the right shot first.

- Press the shutter button to take the first shot.

Note

To exit without recording a picture, press **DISP/BACK**.

- The first shot will be shown superimposed on the view through the lens. Using it as a guide, frame the second shot and press the shutter release button.

Notes

- The 3D effect may not be visible with some subjects or under some shooting conditions. For best results, the distance the camera is moved between shots should be about 1/30th to 1/50th of the distance to the subject.
- The camera will turn off automatically if no operations performed for the time selected for **AUTO POWER OFF** (98). The first shot will not be saved if the second shot is not taken before the camera turns off.



Viewing and Printing 3D Images

- **The camera** displays images in 2D. Press the selector down to toggle between the first and second shots.
- **Devices equipped for 3D display**, such as the FINEPIX REAL 3D V3 digital photo frame or FINEPIX REAL 3D W3 digital camera, will display the images in 3D.
- **3D prints** can be ordered from <http://www.fujifilm.com/3d/print/>
- **The supplied software** displays 3D anaglyph images. 3D photos can also be viewed using other applications that support the MP format.
- **3D TVs** that support the MP format can display images in 3D. See the manual for your TV for details.

Cautions

- Images are not output in 3D when printed directly from the camera.
- 3D images are displayed in 2D in slide shows and when output on a conventional TV.
- 3D images can not be edited or retouched.

Note: The MP (Multi-Picture) format is a CIPA standard for files containing multiple still images. Files in MP format are referred to as “MP files” and have the extension “*.MPO”. The camera uses this format for 3D images.

PANORAMA **MOTION PANORAMA**

In this mode, you can take up to three pictures and join them together to form a panorama. Use of a tripod is recommended to assist in composing overlapping shots.

Note

Operations are described in the factory settings (**AUTO** **AUTO**).

- 1** Rotate the mode dial to **PANORAMA**.

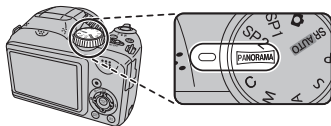

- 2** Press the selector up to select a frame. Press the selector left or right to highlight a pan direction and press **MENU/OK**.



- 3** Take a photograph. Exposure and white balance for the panorama are set with the first shot.

**Note**

The camera zooms all the way out and zoom remains fixed at the widest angle until shooting is complete.

- 4** Frame the next shot to overlap with the previous picture by superimposing **+** on **+** so that they form a solid circle (●). The camera will release the shutter automatically.

Pan direction

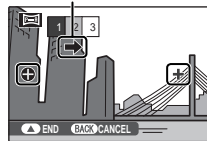

Display after 1st shot

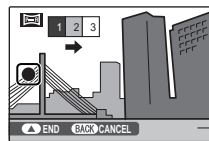

Shutter released

- 5** Take the last shot as described in Step 4.

Note



To end shooting and create a panorama after the first or second shot, press the multi selector up after completing Step 3 or Step 4 and proceed to Step 6.

6 Press **MENU/OK** to save the picture.

Cautions

- Panoramas are created from multiple frames. The camera may in some cases be unable to stitch the frames together perfectly.
- The desired results may not be achieved with moving subjects, subjects close to the camera, unvarying subjects such as the sky or a field of grass, subjects that are in constant motion, such as waves and waterfalls, or subjects that undergo marked changes in brightness. Panoramas may be blurred if the subject is poorly lit.



For Best Results



For best results, be careful not to tilt the camera backward or forward or to either side and try not to move the camera while  and  are aligned to form a solid circle.

Printing Panoramas

Depending on the page size and the size of the panorama, panoramas may print with their edges cropped out or with wide margins at the top and bottom or at both sides.

Framing Panoramas Manually

Follow the steps below if the desired results are not achieved with  **AUTO** selected for  **MODE**:

- 1** Select  **MANUAL** for  **MODE** in the shooting menu.
- 2** Select a frame and take the first shot.
- 3** Press **MENU/OK** to display a guide showing an edge of the picture you have just taken. Take the next shot, framing it to overlap with the previous picture.

Guide

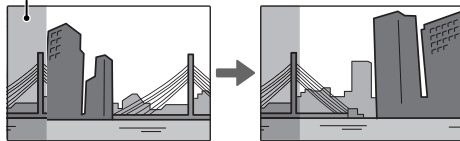

Display after 1st shot

Frame next shot

- 4** Repeat Step 3 to take the third shot and then press **MENU/OK** to display the completed panorama.
- 5** Press **MENU/OK** to save the picture.

P: PROGRAM AE

In this mode, the camera sets exposure automatically. If desired, you can choose different combinations of shutter speed and aperture that will produce the same exposure (program shift).

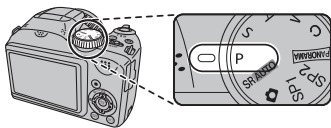

⚠ Caution

If the subject is outside the metering range of the camera, the shutter speed and aperture displays will show "---". Press the shutter button halfway to measure exposure again.

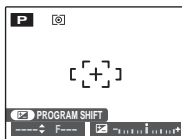

● Program Shift

Press the  button to choose the desired combination of shutter speed and aperture. Values that differ from those automatically selected by the camera are shown in yellow. The default values can be restored by raising the flash or turning the camera off. Program shift is not available when the flash is raised.

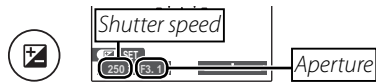

S: SHUTTER PRIORITY AE

In this mode, you choose the shutter speed while the camera adjusts aperture for optimal exposure.

- 1** Rotate the mode dial to **S**.

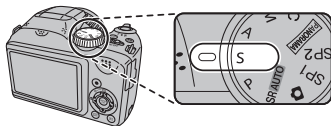

- 2** Press the  button. Shutter speed and aperture will be displayed.

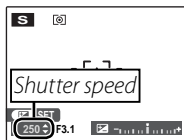

- 3** Press the selector up or down to choose the shutter speed.



- 4** Press the  button to exit to shooting mode.



- 5** Take pictures. If the correct exposure can not be achieved at the selected shutter speed, aperture will be displayed in red when the shutter button is pressed halfway. Adjust shutter speed until the correct exposure can be achieved.

Caution

If the subject is outside the metering range of the camera, the aperture display will show "---". Press the shutter button halfway to measure exposure again.

A: APERTURE PRIORITY AE

In this mode, you choose the aperture while the camera adjusts shutter speed for optimal exposure.

- 1** Rotate the mode dial to **A**.

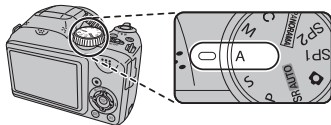

- 2** Press the  button. Shutter speed and aperture will be displayed.

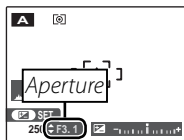

- 3** Press the selector up or down to choose the aperture.



- 4** Press the  button to exit to shooting mode.



- 5** Take pictures. If the correct exposure can not be achieved at the selected aperture, shutter speed will be displayed in red when the shutter button is pressed halfway. Adjust aperture until the correct exposure can be achieved.

Caution

If the subject is outside the metering range of the camera, the shutter speed display will show "----". Press the shutter button halfway to measure exposure again.

M: MANUAL

In this mode, you choose both shutter speed and aperture. If desired, exposure can be altered from the value suggested by the camera.

- 1** Rotate the mode dial to **M**.

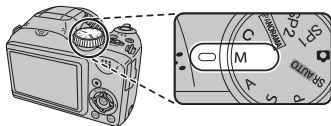

- 2** Press the  button. Shutter speed and aperture will be displayed.

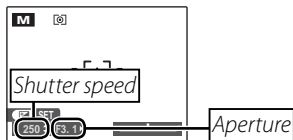

- 3** Press the selector up or down to choose the shutter speed.



- 4** Press the selector left or right to choose the aperture.



- 5** Press the  button to exit to shooting mode.



- 6** Take pictures.

The Exposure Indicator



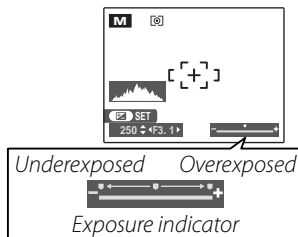





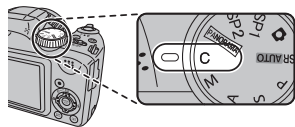







The amount the picture will be under- or over-exposed at current settings is shown by the exposure indicator. Pictures taken with the indicator to the left of center ("–") will be underexposed, pictures taken with the indicator to the right of center ("+"), overexposed.



C: CUSTOM MODE

In **P**, **S**, **A**, and **M** modes, the  **CUSTOM SET** option in the shooting menu (📖 72) can be used to save current camera and menu settings. These settings are recalled whenever the mode dial is rotated to **C** (custom mode).



| Menu/setting | Settings saved |
|---------------|---|
| Shooting menu |  ISO,  IMAGE SIZE,  FINEPIX COLOR,  IMAGE QUALITY,  PHOTOMETRY,  WB WHITE BALANCE,  AF MODE,  SHARPNESS,  FLASH,  AE BKT EV STEPS,  FACE DETECTION |
| Setup menu |  IMAGE DISP,  DUAL IS MODE,  AF ILLUMINATOR,  DIGITAL ZOOM,  LCD MODE,  BLINK DETECTION |
| Other | Shooting mode (P , S , A , or M), continuous shooting mode, instant zoom, macro mode, exposure compensation, flash mode, shutter speed, aperture, indicators/best framing |

Intelligent Face Detection

Intelligent Face Detection allows the camera to automatically detect human faces and set focus and exposure for a face anywhere in the frame for shots that emphasize portrait subjects. Choose for group portraits (in horizontal or vertical orientations) to prevent the camera from focusing on the background.

1 Turn Intelligent Face Detection on.

To use Intelligent Face Detection, press **MENU/OK** to display the shooting menu and select **ON** for **FACE DETECTION** (71).



Green border

- If a face is detected, it will be indicated by a green border.
- If there is more than one face in the frame, the camera will select the face closest to the center; other faces are indicated by white borders.

⚠ Cautions

- If no face is detected when the shutter button is pressed halfway (106), the camera will focus on the subject at the center of the display and red-eye will not be removed.
- If the subject moves as the shutter button is pressed, their face may not be in the area indicated by the green border when the picture is taken. If the number of faces is large, additional time may be required for processing.

Intelligent Face Detection

Intelligent Face Detection is recommended when using the self-timer for group- or self-portraits (83).

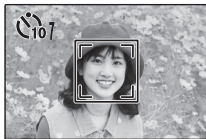

When a picture taken with Intelligent Face Detection is displayed, the camera can automatically select faces for red-eye removal (84), playback zoom (48), slide shows (83), image search (54), image disp. (96), printing (60), and cropping (86).

Blink Detection

If an option other than **OFF** is selected for **IMAGE DISP.** (92), a warning will be displayed if the camera detects subjects who may have blinked when the picture was taken. If **ZOOM (CONTINUOUS)** is selected, you can press the **▼** button to zoom in on these subjects.

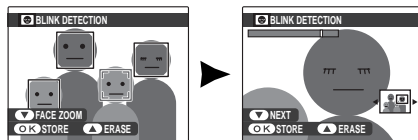

Caution

Blink detection is not performed if the camera fails to detect a face or when **OFF** is selected for **IMAGE DISP.**

Tip: Blink Detection

Blink detection can be turned on or off in the setup menu (93).

Focus Lock

To compose photographs with off-center subjects:

1 Position the subject in the focus frame.



2 Focus.

Press the shutter button halfway to set focus and exposure. Focus and exposure will remain locked while the shutter button is pressed halfway (AF/AE lock).



*Press
halfway*



Repeat steps 1 and 2 as desired to refocus before taking the picture.

3 Recompose the picture.

Keeping the shutter button pressed halfway, recompose the picture.



4 Shoot.

Press the shutter-release button the rest of the way down to take the picture.



*Press the rest of
the way down*

Autofocus

Although the camera boasts a high-precision autofocus system, it may be unable to focus on the subjects listed below. If the camera is unable to focus using autofocus, use focus lock (📖 34) to focus on another subject at the same distance and then recompose the photograph.

- Very shiny subjects such as mirrors or car bodies.
- Fast-moving subjects.

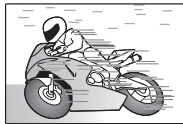

- Subjects photographed through a window or other reflective object.
- Dark subjects and subjects that absorb rather than reflect light, such as hair or fur.
- Insubstantial subjects, such as smoke or flame.
- Subjects that show little contrast with the background (for example, subjects in clothing that is the same color as the background).
- Subjects positioned in front of or behind a high-contrast object that is also in the focus frame (for example, a subject photographed against a backdrop of highly contrasting elements).

The AF-Assist Illuminator

If the subject is poorly lit, the AF-assist illuminator will light to assist the focus operation when the shutter button is pressed halfway.



Notes

- Avoid shining the AF-assist illuminator directly into your subject's eyes.
- The camera may be unable to focus using the AF-assist illuminator in some cases. If the camera is unable to focus in macro mode (📖 36), try increasing the distance to the subject.

Macro and Super Macro Modes (Close-ups)

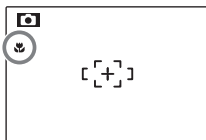
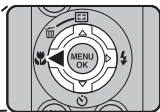
For close-ups, press the selector left () to choose from the macro options shown below.



Choose from  (macro mode),
 (super macro mode), or
OFF (macro mode off)

When macro mode is in effect, the camera focuses on subjects near the center of the frame. Use the zoom control to compose pictures. In super macro mode, optical zoom can not be adjusted and the flash can not be used.

Notes

- Use of a tripod is recommended to prevent blur caused by camera shake.
- Flash compensation may be required when using the flash ( 79).
- Using the flash at close range may cast a lens shadow. Zoom a little or have more distance from the subject.

⚡ Using the Flash (Intelligent Flash)

When the flash is used, the camera's *Intelligent Flash* system instantly analyzes the scene based on such factors as the brightness of the subject, its position in the frame, and its distance from the camera. Flash output and sensitivity are adjusted to ensure that the main subject is correctly exposed while preserving the effects of ambient background lighting, even in dimly-lit indoor scenes. Use the flash when lighting is poor, for example when shooting at night or indoors under low light.

1 Raise the flash.

Press the flash pop-up button to raise the flash.

●● Turning the Flash Off

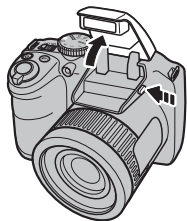

Lower the flash where flash photography is prohibited or to capture natural lighting under dim light. At slow shutter speeds,  will be displayed to warn that pictures may be blurred; use of a tripod is recommended.



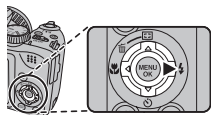

2 Choose a flash mode.

Press the selector right () . The flash mode changes each time the selector is pressed.



| Mode | Description |
|---|--|
|  (AUTO FLASH) | The flash fires when required. Recommended in most situations. |
|  (FORCED FLASH) | The flash fires whenever a picture is taken. Use for backlit subjects or for natural coloration when shooting in bright light. |
|  (SLOW SYNCHRO) | Capture both the main subject and the background under low light (note that brightly lit scenes may be overexposed). |

3 Focus.

Press the shutter button halfway to focus. If the flash will fire,  will be displayed when the shutter button is pressed halfway. At slow shutter speeds,  will appear in the display to warn that pictures may be blurred; use of a tripod is recommended.



4 Shoot.

Press the shutter button the rest of the way down to shoot.

Caution





The flash may fire several times with each shot. Do not move the camera until shooting is complete.



Note

The peripheral part of an image may be dark when using the flash.

Red-Eye Removal

When Intelligent Face Detection is active ([page 32](#)), and **ON** is selected for  **RED EYE REMOVAL** in the setup menu ([page 84](#)), red-eye removal is available in , , and .

Red-eye removal minimizes “*red-eye*” caused when light from the flash is reflected from the subject’s retinas as shown in the illustration at right.



🕒 Using the Self-Timer

The camera offers a ten-second timer that allows photographers to appear in their own photographs, and a two-second timer that can be used to avoid blur caused by the camera moving when the shutter button is pressed.

1 Set the timer.

Press the selector down (🕒), and then press the selector left or right to highlight an option and press **MENU/OK**.

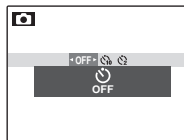
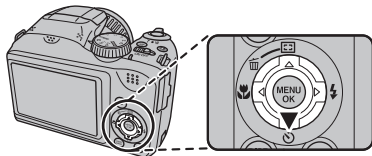

Choose from
OFF (self-timer off),
🕒 (10 s delay), or
🕒 (2 s delay)

2 Focus.

Press the shutter button halfway to focus.

⚠ Caution

Stand behind the camera when using the shutter button. Standing in front of the lens can interfere with focus and exposure.



3 Start the timer.

Press the shutter button the rest of the way down to start the timer. The display shows the number of seconds remaining until the shutter is released. To stop the timer before the picture is taken, press **DISP/BACK**.

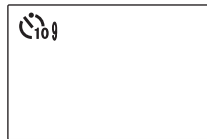

The self-timer lamp on the front of the camera will blink immediately before the picture is taken. If the two-second timer is selected, the self-timer lamp will blink as the timer counts down.

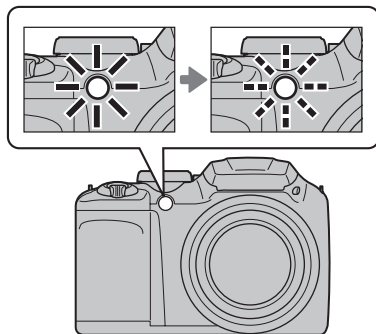

Intelligent Face Detection

Because it ensures that the faces of portrait subjects will be in focus, Intelligent Face Detection (32) is recommended when using the self-timer for group portraits or self-portraits. To use the self-timer with Intelligent Face Detection, select **10 SEC** or **2 SEC** in the self-timer menu and then press the shutter button all the way down to start the timer. The camera will detect faces while the timer is counting down and adjust focus and exposure immediately before the shutter is released. Be careful not to move until the picture has been recorded.



Note

The self-timer turns off automatically when the picture is taken, a different shooting mode is selected, playback mode is selected, or the camera is turned off.





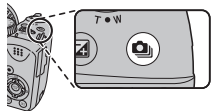

Continuous Shooting (Burst Mode)

Capture motion in a series of pictures.

1 Choose a continuous shooting mode.

Press the  button to display continuous shooting options. Press the selector  or  to highlight the desired option and press **MENU/OK**.



| Mode | Description |
|--|--|
| OFF | Continuous shooting mode off. One picture is taken each time the shutter button is pressed. |
|  (TOP 5) | The camera takes up to 5 pictures while the shutter button is pressed. |
|  (FINAL 5) | The camera takes up to 40 pictures while the shutter button is pressed, but only the last 5 frames are recorded. |
|  (LONG PERIOD) | The camera takes pictures while the shutter button is pressed. Shooting ends when the shutter button is released or memory is full. |
|  (TOP 20) | The camera takes up to 20 pictures while the shutter button is pressed. |
|  (TOP 40) | The camera takes up to 40 pictures while the shutter button is pressed. |
|  (AE BKT) | Each time the shutter-release button is pressed, the camera takes three shots: one using the metered value for exposure, the second overexposed by the amount selected for AE BKT EV STEPS in the shooting menu (page 79), and the third underexposed by the same amount (the camera may not be able to use the selected bracketing increment if the amount of over- or under-exposure exceeds the limits of the exposure metering system). |

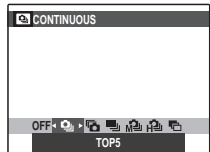

2 Focus.

Press the shutter button halfway to focus.







3 Shoot.

Pictures will be taken while the shutter button is pressed. Shooting ends when the shutter button is released, memory is full, or the selected number of shots has been taken.



Notes

- Focus and exposure are determined by the first frame in each series. The flash turns off automatically; the previously-selected flash mode is restored when continuous shooting is turned off.
- Frame rate varies with shutter speed.
- If the self-timer is used when  and  are selected, only one picture will be taken when the shutter button is pressed.
- At a setting of , white lines may appear in bright areas of the image; these can be avoided by choosing  mode.
- The number of pictures that can be recorded depends on the memory available. AE bracketing is only available if there is sufficient memory for three pictures. Additional time may be required to record pictures when shooting ends.

Instant Zoom

In instant zoom, the area surrounding the frame is visible in the display. Use to frame erratically moving subjects such as children, pets, and athletes at sporting events.

1 Position the subject in the focus frame.

Use the zoom control to frame the subject in the center of the display.



2 Choose a frame.

Press the selector up () to cycle through framing options as shown below.

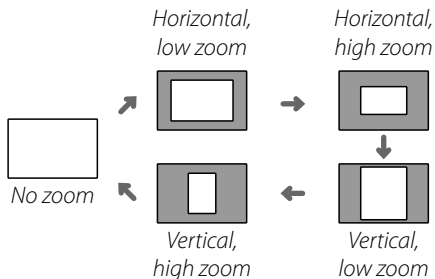
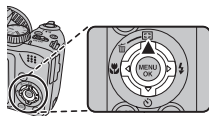

The frame is displayed as shown at right. The composition can be adjusted using the zoom control.



3 Focus and shoot.

The framed area will be enlarged to create a full-sized picture.

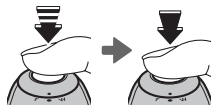

Tip: Intelligent Face Detection

Intelligent Face Detection will not detect faces outside the selected frame.

■ Digital Zoom

- 1 Enable digital zoom.**
Select **ON** for the  **DIGITAL ZOOM** option in the setup menu (📖 99).
- 2 Choose a subject.**
Frame the subject in the center of the display using digital zoom.



- 3 Press the selector up (⏏).**
The camera will zoom to the maximum optical zoom position with the area that will be recorded using digital zoom indicated by a frame at the center of the display.

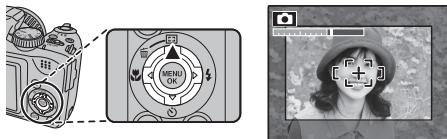



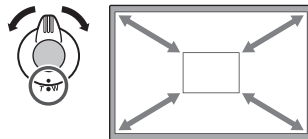

- 4 Frame the picture.**
Use the zoom control to choose the area that will be included in the final photograph.

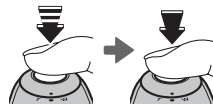

- 5 Focus and shoot.**
The framed area will be enlarged to create a full-sized picture.



Cautions

- Pictures taken using the instant zoom are lower quality than pictures taken using normal zoom.
- Only horizontal (landscape-orientation) framing is available when , , , or  is selected for continuous shooting mode.

Exposure Compensation

Use exposure compensation when photographing very bright, very dark, or high-contrast subjects.

- 1 Press the  button.**
The exposure indicator will be displayed.

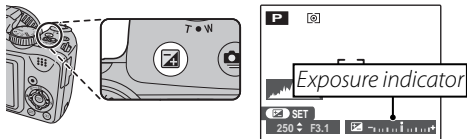

- 2 Choose a value.**
Press the selector left or right. The effect is visible in the display.

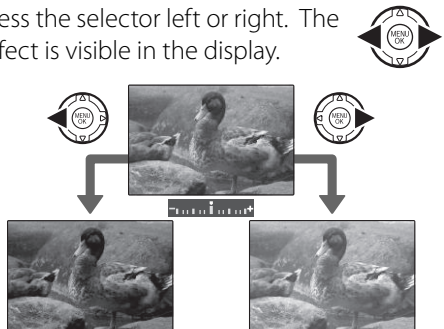

Choose negative values
to reduce exposure
("-" sign turns yellow)

Choose positive values to
increase exposure
("+ sign turns yellow)

- 3 Return to shooting mode.**
Press the  button to return to shooting mode.
- 4 Take pictures.**

Note

A  icon and exposure indicator are displayed at settings other than ± 0 . Exposure compensation is not reset when the camera is turned off; to restore normal exposure control, choose a value of ± 0 .

Choosing an Exposure Compensation Value

- **Backlit subjects:** choose values from $+2/3$ EV to $+1 2/3$ EV
- **Highly reflective subjects or very bright scenes** (e.g., snowfields): +1 EV
- **Scenes that are mostly sky:** +1 EV
- **Spotlit subjects** (particularly if photographed against dark backgrounds): $-2/3$ EV
- **Subjects with low reflectivity** (pine trees or dark-colored foliage): $-2/3$ EV



Playback Options

To view the most recent picture in the monitor, press the  button.

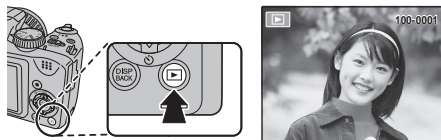

Press the selector right to view pictures in the order recorded, left to view pictures in reverse order. Keep the selector pressed to scroll rapidly to the desired frame.



Choosing a Display Format

Press the **DISP/BACK** button to cycle through playback display formats as shown below.

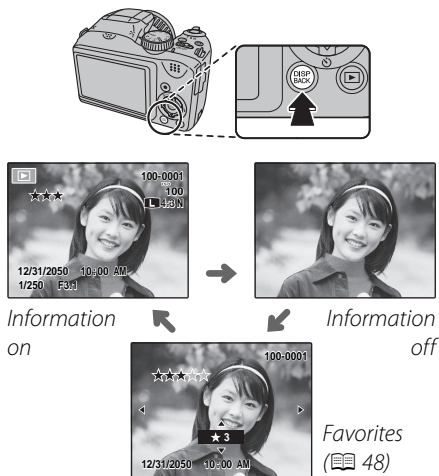

Note

Pictures taken using other cameras are indicated by a  ("gift image") icon during playback.

Playback Zoom

Select **T** to zoom in on pictures displayed in single-frame playback; select **W** to zoom out. When the picture is zoomed in, the selector can be used to view areas of the image not currently visible in the display.

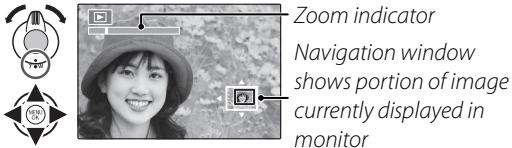

Press **DISP/BACK** to exit zoom.

← Note

The maximum zoom ratio varies with image size. Playback zoom is not available with copies resized or cropped to a size of **640** or smaller.

●● Intelligent Face Detection

Pictures taken with Intelligent Face Detection (📖 33) are indicated by a 🧑 icon. Press the ▼ button to zoom in on the subject selected with Intelligent Face Detection. You can then use the zoom control to zoom in and out.



★ Favorites: Rating Pictures

To rate the picture currently displayed in full-frame playback, press **DISP/BACK** and press the selector up and down to select from zero to five stars.

📖 Tip: Favorites

Ratings can be used for image search (📖 54).

Viewing Photo Information

To view or hide the photo information listed below in single-frame playback, press .

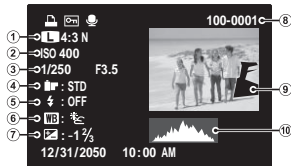
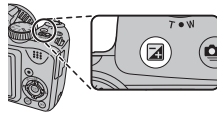

① Image quality and size, ② Sensitivity, ③ Shutter speed/aperture, ④ FinePix color, ⑤ Flash mode, ⑥ White balance, ⑦ Exposure compensation, ⑧ Frame number, ⑨ Picture (overexposed areas blink on and off), ⑩ Histogram

Histograms

Histograms show the distribution of tones in the image. Brightness is shown by the horizontal axis, the number of pixels by the vertical axis.

Optimal exposure: Pixels are distributed in an even curve throughout the tone range.



Overexposed: Pixels are clustered at the right side of the graph.



Underexposed: Pixels are clustered at the left side of the graph.



Multi-Frame Playback

To change the number of images displayed during playback, select **W**.

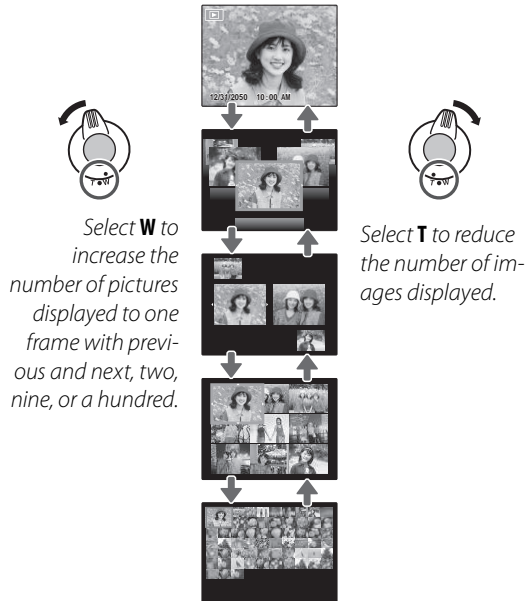

Select **W** to increase the number of pictures displayed to one frame with previous and next, two, or a hundred.

Select **T** to reduce the number of images displayed.

Use the selector to highlight images and press **MENU/OK** to view the highlighted image full frame. In the nine- and hundred-frame displays, press the selector up or down to view more pictures.

Tip: Two-Frame Display

Two-frame display can be used to compare pictures taken in  mode.



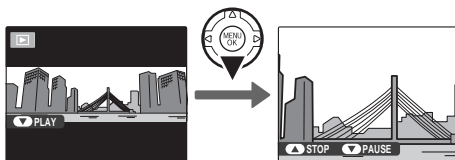

Viewing Panoramas

To view a panorama, display in single-frame view and press the selector down.



The following operations can be performed during playback:

| Operation | Button | Description |
|----------------------|---|---|
| Start/pause playback |  | Press the selector down to start playback. Press again to pause. |
| End playback |  | Press the selector up to end playback. |

PhotoBook Assist

Create books from your favorite photos.

Creating a PhotoBook

1 Select  **PHOTOBOOK ASSIST** in the playback menu.

2 Highlight **NEW BOOK**.



3 Press **MENU/OK** to display the new book dialog.



4 Choose pictures for the new book.

- **SELECT FROM ALL**: Choose from all the pictures available.
- **SELECT BY IMAGE SEARCH**: Choose from pictures matching selected search conditions ( 54).



Note

Neither photographs  or smaller nor movies can be selected for photobooks.

5 Scroll through the images and press the selector up to select or deselect the current image for inclusion in the book. To display the current image on the cover, press the selector down.

Note

The first picture selected automatically becomes the cover image. Press the selector down to select a different picture for the cover.

6 Press **MENU/OK** to exit when the book is complete.



7 Highlight **COMPLETE PHOTOBOOK**.

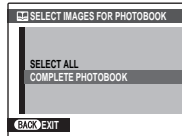

Note

Choose **SELECT ALL** to select all photos, or all photos matching the specified search conditions, for the book.

8 Press **MENU/OK**. The new book will be added to the list in the photobook assist menu.



Cautions

- Photobooks can contain up to 300 pictures.
- Books that contain no photos are automatically deleted.

PhotoBooks

Photobooks can be copied to a computer using the supplied MyFinePix Studio software.

Viewing PhotoBooks

Highlight a book in the photobook assist menu and press **MENU/OK** to display the book, then press the selector left and right to scroll through the pictures. Press **DISP/BACK** to return to the photobook assist menu.

Editing and Deleting PhotoBooks





- 1** Display the photobook and press **MENU/OK** to view book edit options. 
- 2** Choose from the following options:
 - **EDIT**: Edit the book as described in “Creating a PhotoBook” on page 52.
 - **ERASE**: Delete the current photobook.
- 3** Follow the on-screen instructions.



Image Search

Search for pictures by date, subject, scene, file type, and rating.

- 1 Select  **IMAGE SEARCH** in the playback menu.
- 2 Highlight one of the following options and press **MENU/OK**:

| Option | Description |
|------------------------|---|
| BY DATE | Find all pictures taken on a selected date. |
| BY FACE | Find all pictures based on specified face information. |
| BY ★ FAVORITES | Find all pictures with a specified rating ( 48). |
| BY SCENE | Find all pictures that match a selected scene. |
| BY TYPE OF DATA | Find all still pictures or all movies. |
| BY UPLOAD MARK | Find all pictures selected for upload to a specified destination ( 81). |

- 3 Select a search condition. Only pictures that match the search condition will be displayed. To delete or protect selected pictures or to view the selected pictures in a slide show, press **MENU/OK** and choose from the following options:

| Option | See page |
|---|----------|
|  ERASE | 55 |
|  PROTECT | 85 |
|  SLIDE SHOW | 83 |

- 4 To end the search, select **EXIT SEARCH**.

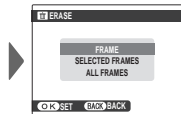

Deleting Pictures

To delete individual pictures, multiple selected pictures, or all pictures, press the selector up () and choose from the options below. *Note that deleted pictures can not be recovered. Copy important pictures to a computer or other storage device before proceeding.*



| Option | Description |
|------------------------|--|
| FRAME | Press the selector left or right to scroll through pictures and press MENU/OK to delete the current picture (a confirmation dialog is not displayed). |
| SELECTED FRAMES | Highlight pictures and press MENU/OK to select or deselect (pictures that are protected or in a print order are shown by ). When the operation is complete, press DISP/BACK to display a confirmation dialog, then highlight OK and press MENU/OK to delete the selected pictures. |
| ALL FRAMES | A confirmation dialog will be displayed; highlight OK and press MENU/OK to delete all unprotected pictures. Pressing DISP/BACK cancels deletion; note that any pictures deleted before the button was pressed can not be recovered. |

Notes

- Protected pictures can not be deleted. Remove protection from any pictures you wish to delete ( 85).
- Pictures can also be deleted by  **ERASE** from playback menu.
- If a message appears stating that the selected images are part of a DPOF print order, press **MENU/OK** to delete the pictures.

Recording Movies

Shoot short movies at 30 frames per second. Sound is recorded via the built-in microphone; do not cover the microphone during recording.

- 1 Press the  button to shoot a movie.

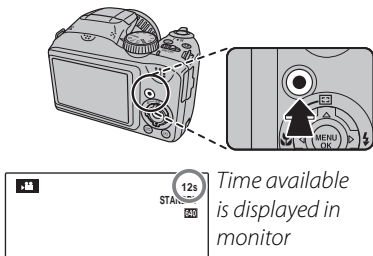

- 2 To end recording, press the  button again. Recording ends automatically when the movie reaches maximum length or memory is full.

Caution

The indicator lamp lights while movies are being recorded. Do not open the battery chamber during shooting or while the indicator lamp is lit. Failure to observe this precaution could prevent the movie from being played back.

Note

Exposure and white balance are adjusted automatically throughout recording. The color and brightness of the image may vary from that displayed before recording begins.

⚠ Cautions

- Vertical or horizontal streaks may appear in movies containing very bright subjects. This is normal and does not indicate a malfunction.
- Recording movies for a long time or using the camera at high ambient temperatures may increase the camera temperature. This is normal and does not indicate a malfunction.
- Sounds made by the camera may be recorded.
- The **fps LCD MODE** option in the setup menu is fixed at **30 fps** in movie mode.

● Avoiding Blurred Pictures

If the subject is poorly lit, blurring caused by camera shake can be reduced using the **DUAL IS MODE** option in the setup menu (📖 93).

Sensitivity is raised when dual IS is in effect. Note that blurring may still occur depending on the scene. We recommend that you turn dual IS off when using a tripod.

● Zooming While Recording a Movie

The zoom can be used while recording a movie.

In the setup menu, select **Dt DIGITAL** or **Opt OPTICAL** (📖 93).

Dt DIGITAL: Image quality may deteriorate when the zoom is used.

Opt OPTICAL: The sound of the camera zooming may be heard when playing movie.

Movie Frame Size

Before recording, select a frame size using the

MOVIE MODE option in the shooting menu.

| Option | Description |
|---------------------------|----------------------|
| HD 1280 (1280×720) | High Definition. |
| 640 (640×480) | Standard definition. |
| 320 (320×240) | Longer movie. |

▶ Viewing Movies

During playback (📖 47), movies are displayed in the monitor as shown at right. The following operations can be performed while a movie is displayed:

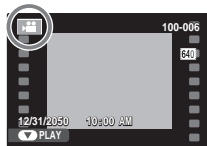

| Operation | Description |
|----------------------|---|
| Start/pause playback | Press the selector down to start playback. Press again to pause. |
| End playback/delete | Press the selector up to end playback. If playback is not in progress, pressing the selector up will delete the current movie. |
| Advance/rewind | Press the selector right to advance, left to rewind. If playback is paused, the movie will advance or rewind one frame each time the selector is pressed. |
| Adjust volume | Press MENU/OK to pause playback and display volume controls. Press the selector up or down to adjust the volume; press MENU/OK again to set the volume. |

Progress is shown in the monitor during playback.

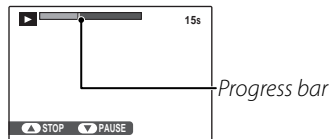

📖 **Tip: Viewing Movies on a Computer**

Copy movies to the computer before viewing.

⚠ **Caution**

Do not cover the speaker during playback.

Viewing Pictures on TV

Connecting the Camera to High Definition (HD) TVs

When an HDMI cable (available from third-party suppliers) is connected, pictures and sound are played back on the TV.

- 1 Turn the camera off and connect an HDMI cable available from third party suppliers.



← Note

The USB cable can not be used while an HDMI cable is connected.

- 2 Tune the television to the video or HDMI input channel. See the documentation supplied with the television for details.
- 3 Press the  button for about a second to turn the camera on. The camera monitor turns off and pictures and movies are played back on the TV. Note that the camera volume controls have no effect on sounds played on the TV; use the television volume controls to adjust the volume.

← Note

Image quality drops during movie playback.

Caution

When connecting the cable, be sure the connectors are fully inserted.

Printing Pictures via USB

If the printer supports PictBridge, the camera can be connected directly to the printer and pictures can be printed without first being copied to a computer. Note that depending on the printer, not all the functions described below may be supported.



Connecting the Camera

- 1 Connect the supplied USB cable as shown and turn the printer on.

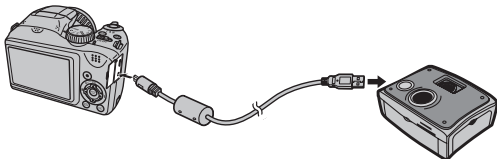

- 2 Press the button for about a second to turn the camera on. **USB** will be displayed in the monitor, followed by the PictBridge display shown below at right.

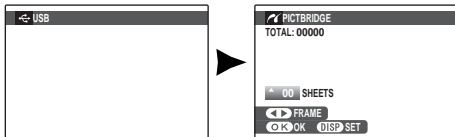

Printing Selected Pictures

- 1 Press the selector left or right to display a picture you wish to print.
- 2 Press the selector up or down to choose the number of copies (up to 99).
- 3 Repeat steps 1–2 to select additional pictures. Press **MENU/OK** to display a confirmation dialog when settings are complete.

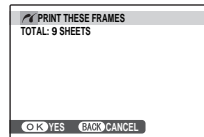

- 4 Press **MENU/OK** to start printing.



Tip: Printing the Date of Recording

To print the date of recording on pictures, press **DISP/BACK** in steps 1–2 to display the PictBridge menu (see “Printing the DPOF Print Order,” below). Press the selector up or down to highlight **PRINT WITH DATE** and press **MENU/OK** to return to the PictBridge display (to print pictures without the date of recording, select **PRINT WITHOUT DATE**).

Note

If no pictures are selected when the **MENU/OK** button is pressed, the camera will print one copy of the current picture.

Printing the DPOF Print Order

To print the print order created with **PRINT ORDER (DPOF)** in the playback menu (63).

- 1 In the PictBridge display, press **DISP/BACK** to open the PictBridge menu.

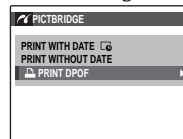

- 2 Press the selector up or down to highlight **PRINT DPOF**.



- 3 Press **MENU/OK** to display a confirmation dialog.

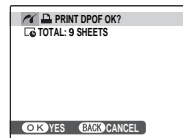



4 Press **MENU/OK** to start printing.

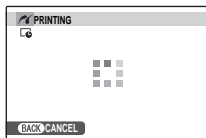

During Printing

The message shown at right is displayed during printing. Press **DISP/BACK** to cancel before all pictures are printed (depending on the printer, printing may end before the current picture has printed).



If printing is interrupted, press  to turn the camera off and then on again.

Disconnecting the Camera

Confirm that "PRINTING" is not displayed in the monitor and turn the camera off. Disconnect the USB cable.

Notes

- Print pictures from a memory card that has been formatted in the camera.
- If the printer does not support date printing, the **PRINT WITH DATE**  option will not be available in the PictBridge menu and the date will not be printed on the pictures in the DPOF print order.
- When pictures are printed via direct USB connection, page size, print quality, and border selections are made using the printer.

Creating a DPOF Print Order

The  **PRINT ORDER (DPOF)** option in the playback menu can be used to create a digital “print order” for PictBridge-compatible printers (📖 101) or devices that support DPOF.

DPOF

DPOF (Digital Print Order Format) is standard that allows pictures to be printed from “print orders” stored on a memory card. The information in the order includes the pictures to be printed, date imprint, and the number of copies of each picture.



■ **WITH DATE** /**WITHOUT DATE**

- 1 Select playback mode and press **MENU/OK** to display the playback menu.
- 2 Highlight  **PRINT ORDER (DPOF)** and press **MENU/OK**.
- 3 Highlight one of the following options and press **MENU/OK**:

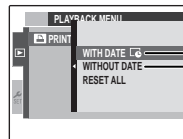

WITH DATE : Print the date of recording on pictures.

WITHOUT DATE: Do not print the date of recording on pictures.

- 4 Press the selector left or right to display a picture you wish to include in or remove from the print order.



- 5** Press the selector up or down to choose the number of copies (up to 99). To remove a picture from the order, press the selector down until the number of copies is 0.

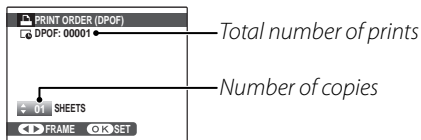

Tip: Intelligent Face Detection

If the current picture was created with Intelligent Face Detection, pressing ▼ sets the number of copies to the number of faces detected.

Note

When pictures are printed via direct USB connection, page size, print quality, and border selections are made using the printer.

- 6** Repeat steps 4–5 to complete the print order. Press **MENU/OK** to save the print order when settings are complete, or **DISP/BACK** to exit without changing the print order.



- 7** The total number of prints is displayed in the monitor. Press **MENU/OK** to exit.



The pictures in the current print order are indicated by a  icon during playback.



← Notes

- Print orders can contain a maximum of 999 pictures.
- If a memory card is inserted containing a print order created by another camera, the message shown at right will be displayed. Pressing **MENU/OK** cancels the print order; a new print order must be created as described above.

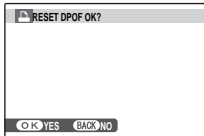
**■ RESET ALL**

To cancel the current print order, select **RESET ALL** in the **PRINT ORDER (DPOF)** menu. The confirmation shown at right will be displayed; press **MENU/OK** to remove all pictures from the order.

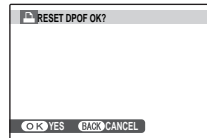

Viewing Pictures on a Computer

The supplied software can be used to copy pictures to a computer, where they can be stored, viewed, organized, and printed. Before proceeding, install the software as described below. **Do not connect the camera to the computer until installation is complete.**

Windows: Installing MyFinePix Studio

1 Confirm that the computer meets the following system requirements:

| | Windows 8/Windows 7 (SP 1)/Windows Vista (SP 2)¹ | Windows XP (SP 3)¹ |
|------------------------|---|---|
| CPU | 3 GHz Pentium 4 or better (2.4 GHz Core 2 Duo or better) ² | 2 GHz Pentium 4 or better (2.4 GHz Core 2 Duo or better) ² |
| RAM | 1 GB or more | 512 MB or more (1 GB or more) ² |
| Free disk space | 2 GB or more | |
| GPU | Supports DirectX 9 or later (recommended) | Supports DirectX 7 or later (required; performance not guaranteed with other GPUs) |
| Video | 1,024 × 768 pixels or more with 24-bit color or better | |
| Other | <ul style="list-style-type: none">• Built-in USB port recommended. Operation is not guaranteed with other USB ports.• Internet connection (broadband recommended) required to install .NET Framework (if necessary), to use auto update feature, and when performing such tasks as sharing pictures on-line or via e-mail. | |

1 Other versions of Windows are not supported. Only pre-installed operating systems are supported; operation is not guaranteed on home-built computers or computers that have been upgraded from earlier versions of Windows.

2 Recommended when displaying HD movies.

- 2 Start the computer. Log in to an account with administrator privileges before proceeding.
- 3 Exit any applications that may be running and insert the installer CD in a CD-ROM drive.

Windows 8/Windows 7/Windows Vista

If an AutoPlay dialog is displayed, click **SETUP.EXE**. A “User Account Control” dialog will then be displayed; click **Yes** (Windows 8/Windows 7) or **Allow** (Windows Vista).

The installer will start automatically; click **Install MyFinePix Studio** and follow the on-screen instructions to install MyFinePix Studio.

If the Installer Does Not Start Automatically (Windows 7/Windows Vista/Windows XP)

If the installer does not start automatically, select **Computer** or **My Computer** from the Start menu, then double-click the **FINEPIX** CD icon to open the FINEPIX CD window and double-click **setup** or **SETUP.EXE**.

If the Installer Does Not Start Automatically (Windows 8)

- 1 Select **Desktop** on the Start screen.
- 2 Select **File Explorer** on the taskbar.
- 3 Select **Computer** in the navigation pane.
- 4 Double-click the drive icon inserting the **FINEPIX** CD and follow the on-screen instructions to install.

- 4 If prompted to install Windows Media Player, DirectX, or .NET Framework, follow the on-screen instructions to complete installation.
- 5 Remove the installer CD from the CD-ROM drive when installation is complete. Store the installer CD in a dry location out of direct sunlight in case you need to re-install the software. The version number is printed at the top of the CD label for reference when updating the software or contacting customer support.

Installation is now complete. Proceed to “Connecting the Camera” on page 68.

Importing pictures or movies to Mac (Macintosh)

Use a standard application in Mac OS such as **Image Capture** to import pictures or movies to Mac.

Connecting the Camera

- 1 If the pictures you wish to copy are stored on a memory card, insert the card into the camera (see 10).

Note

Windows users may require the Windows CD when starting the software for the first time.

Caution

Loss of power during transfer could result in loss of data or damage to the memory card. Insert fresh or fully-charged batteries before connecting the camera.

- 2 Turn the camera off and connect the supplied USB cable as shown, making sure the connectors are fully inserted. Connect the camera directly to the computer; do not use a USB hub or keyboard.

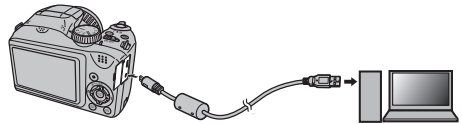

- 3 Press the  button for about a second to turn the camera on. MyFinePix Studio or FinePixViewer will start automatically; follow the on-screen instructions to copy pictures to the computer. To exit without copying pictures, click **Cancel**.

Caution

If the software does not start automatically, it may not be correctly installed. Disconnect the camera and reinstall the software.

For more information on using the supplied software, start the application and select the appropriate option from the **Help** menu.

⚠ Cautions

- If a memory card containing a large number of images is inserted, there may be a delay before the software starts and you may be unable to import or save images. Use a memory card reader to transfer pictures.
- Make sure that the computer does not display a message stating that copying is in progress and that the indicator lamp is out before turning the camera off or disconnecting the USB cable (if the number of images copied is very large, the indicator lamp may remain lit after the message has cleared from the computer display). Failure to observe this precaution could result in loss of data or damage to the memory card.
- Disconnect the camera before inserting or removing memory cards.
- In some cases, it may not be possible to access pictures saved to a network server using the supplied software in the same way as on a standalone computer.
- The user bears all applicable fees charged by the phone company or Internet service provider when using services that require an Internet connection.

●● Disconnecting the Camera

After confirming that the indicator lamp is out, follow the on-screen instructions to turn the camera off and disconnect the USB cable.

●● Uninstalling the Supplied Software

Only uninstall the supplied software when it is no longer required or before beginning reinstallation. After quitting the software and disconnecting the camera, open the control panel and use “Programs and Features” (Windows 8/Windows 7/Windows Vista) or “Add or Remove Programs” (Windows XP) to uninstall MyFinePix Studio. Under Windows, one or more confirmation dialogs may be displayed; read the contents carefully before clicking **OK**.

Using the Menus: Shooting Mode

Using the Shooting Menu

1 Press **MENU/OK** to display the shooting menu.



2 Press the selector up or down to highlight the desired menu item.



3 Press the selector right to display options for the highlighted item.



4 Press the selector up or down to highlight the desired option.







































5 Press **MENU/OK** to select the highlighted option.























6 Press **DISP/BACK** to exit from the menu.



Shooting Menu Options

| Menu item | Description | Options | Default |
|---|---|---|--|
|  SCENE POSITION | Choose a scene for SP1/SP2 mode (📖 20). |  | SP1:  SP2:  |
|  ISO | Adjust ISO sensitivity. Choose higher values when the subject is poorly lit. | AUTO (1600) / AUTO (800) / AUTO (400) / 6400  / 3200  / 1600 / 800 / 400 / 200 / 100 / 64 | AUTO (1600) |
|  IMAGE SIZE | Choose image size and aspect ratio (📖 73). |  4:3 /  3:2 /  16:9 /  4:3 /  16:9 /  4:3 /  16:9 |  4:3 |
|  IMAGE QUALITY | Choose image quality (📖 74). | FINE / NORMAL | NORMAL |
|  FINEPIX COLOR | Shoot pictures in standard or saturated color or in black-and-white (📖 75). |  /  /  |  |
|  WHITE BALANCE | Adjust color for different light sources (📖 75). | AUTO /  /  /  /  /  /  | AUTO |
|  SHARPNESS | Choose whether to sharpen or soften outlines (📖 76). | HARD / STD / SOFT | STD |
|  FACE DETECTION | Choose whether the camera automatically detects and sets focus and exposure for human portrait subjects (📖 32). | ON / OFF | OFF |
|  PHOTOMETRY | Choose how the camera meters exposure (📖 77). |  /  /  |  |

| Menu item | Description | Options | Default |
|---|--|--|---|
|  AF MODE | Choose how the camera selects a focus area (📖 77). |  /  /  /  /  |  |
|  MODE | Choose how panoramas are framed (📖 26). |  /  |  |
|  MOVIE AF MODE | This option controls how the camera selects the focus area for movies (📖 78). |  /  |  |
|  MOVIE MODE | Choose a frame size for movies (📖 57). | HD 1280 / 640 / 320 | HD 1280 |
|  AE BKT EV STEPS | Choose the size of the bracketing increment when  is selected in continuous shooting mode (📖 79). | ±1/3 EV / ±2/3 EV / ±1 EV | ±1/3 EV |
|  FLASH | Adjust flash brightness (📖 79). | -2/3 EV – +2/3 EV in steps of 1/3 EV | 0 |
|  CUSTOM SET | Save settings for P , S , A , and M modes (📖 31). | — | — |

ISO ISO

Control the camera's sensitivity to light. Higher values can be used to reduce blur when lighting is poor; note, however, that mottling may appear in pictures taken at high sensitivities. If **AUTO**, **AUTO (800)**, or **AUTO (400)** is selected, the camera will adjust sensitivity automatically in response to shooting conditions. The maximum values that will be selected by the camera at settings of **AUTO (800)** and **AUTO (400)** are 800 and 400 respectively. Settings other than **AUTO** are shown by an icon in the display.

Note

Sensitivity is not reset when the camera is turned off or another shooting mode is selected.

IMAGE SIZE

Choose the size and aspect ratio at which still pictures are recorded. Large pictures can be printed at large sizes with no drop in quality; small pictures require less memory, allowing more pictures to be recorded.

| Option | Prints at sizes up to |
|---------------|-----------------------------|
| L 4:3 | 34 × 25 cm (13.5 × 10 in.) |
| L 3:2 | 34 × 23 cm (13.5 × 9 in.) |
| L 16:9 | 34 × 19 cm (13.5 × 7.5 in.) |
| M 4:3 | 24 × 18 cm (9.5 × 7 in.) |
| M 16:9 | 24 × 13 cm (9.5 × 5.5 in.) |
| S 4:3 | 17 × 13 cm (7 × 5 in.) |
| S 16:9 | 16 × 9 cm (6.5 × 3.5 in.) |

The number of pictures that can be taken at the selected setting is shown in the display (📖 116).

Aspect Ratio

Pictures with an aspect ratio of 4:3 have the same proportions as the camera display. Pictures with an aspect ratio of 3:2 have the same proportions as a frame of 35-mm film, while an aspect ratio of 16:9 is suited to display on High Definition (HD) devices.



4:3



3:2



16:9

Note

Image size is not reset when the camera is turned off or another shooting mode is selected.

IMAGE QUALITY

Choose how much image files are compressed. Select **FINE** (low compression) for higher image quality, **NORMAL** (high compression) to increase the number of pictures that can be stored.

FINEPIX COLOR

Enhance contrast and color saturation or take pictures in black and white.

| Option | Description |
|-----------------|---|
| STANDARD | Standard contrast and saturation. Recommended in most situations. |
| CHROME | Vivid contrast and color. Choose for vivid shots of flowers or enhanced greens and blues in landscapes. |
| B&W | Take pictures in black and white. |







Settings other than **STANDARD** are shown by an icon in the display.

Notes

- **FINEPIX COLOR** is not reset when the camera is turned off or another shooting mode is selected.
- The effects of **CHROME** vary from scene to scene and may be difficult to discern with some subjects. Depending on the subject, the effects of **CHROME** may not be visible in the display.

WHITE BALANCE

For natural colors, choose a setting that matches the light source.

| Option | Description |
|---|--|
| AUTO | White balance adjusted automatically. |
|  | Measure a value for white balance. |
|  | For subjects in direct sunlight. |
|  | For subjects in the shade. |
|  | Use under "daylight" fluorescent lights. |
|  | Use under "warm white" fluorescent lights. |
|  | Use under "cool white" fluorescent lights. |
|  | Use under incandescent lighting. |

If **AUTO** does not produce the desired results (for example, when taking close-ups), select  and measure a value for white balance or choose the option that matches the light source.

Notes

- At settings other than , auto white balance is used with the flash. Lower the flash (📖 37) to take pictures at other settings.
- Results vary with shooting conditions. Play pictures back after shooting to check colors in the monitor.

■ Custom White Balance

Choose  to adjust white balance for unusual lighting conditions. White balance measurement options will be displayed; frame a white object so that it fills the monitor and press the shutter button all the way down to measure white balance.

If “COMPLETED!” is displayed, press **MENU/OK** to set white balance to the measured value. This value can be reselected by pressing **MENU/OK** when custom white balance options are displayed.

If “UNDER” is displayed, raise exposure compensation ( 45) and try again.

If “OVER” is displayed, lower exposure compensation and try again.

Tip

To give a deliberate color cast to your photographs, measure a value for custom white balance using a colored instead of a white object.

Ⓢ SHARPNESS

Choose whether to sharpen or soften outlines.

- **HARD**: Use for sharp outlines when photographing such subjects as buildings and text.
- **STANDARD**: Standard sharpness. Best choice in most situations.
- **SOFT**: Use for soft outlines in portraits and similar subjects.

PHOTOMETRY

Choose how the camera meters exposure when Intelligent Face Detection is off.



- **MULTI:** Automatic scene recognition is used to adjust exposure for a wide range of shooting conditions.
- **SPOT:** The camera meters lighting conditions at the center of the frame. Recommended when the background is much brighter or darker than the main subject. Can be used with focus lock (34) to meter off-center subjects.
- **AVERAGE:** Exposure is set to the average for the entire frame. Provides consistent exposure across multiple shots with the same lighting, and is particularly effective for landscapes and portraits of subjects dressed in black or white.

AF MODE

This option controls how the camera selects the focus area when Intelligent Face Detection is off (32). Regardless of the option selected, the camera will focus on the subject in the center of the monitor when macro mode is on (36).

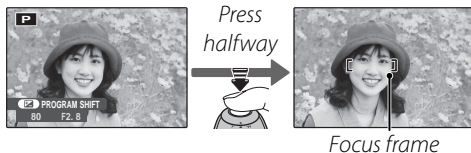

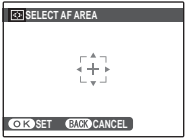
- **CENTER:** The camera focuses on the subject in the center of the frame. This option can be used with focus lock (34).
- **MULTI:** When the shutter button is pressed halfway, the camera detects high-contrast subjects near the center of the frame and selects the focus area automatically (if the focus frame is not displayed, select **CENTER** and use focus lock; 34).

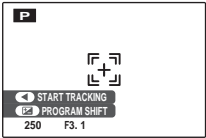

-  **AREA:** The focus position can be chosen manually by pressing the selector up, down, left, or right and pressing **MENU/OK** when the focus brackets are in the desired position. Choose for precise focus when the camera is mounted on a tripod. Note that exposure is set for the subject in the center of the frame; to meter an off-center subject, use AF/AE lock (🗨️ 34).
 
-  **CONTINUOUS:** The camera continually adjusts focus to reflect changes in the distance to the subject even when the shutter button is not pressed (note that this increases the drain on the battery).
-  **TRACKING:** Position the subject in the center focus area and press the selector left to select tracking. Focus will track the subject as it moves through the frame.
 

MOVIE AF MODE



This option controls how the camera selects the focus area for movies.

| Option | Description |
|---|--|
|  CENTER | The camera focuses on the subject in the center of the frame. |
|  CONTINUOUS | The camera continuously adjusts focus to reflect changes in the distance to subjects near the center of the frame. |

Note

Note that in  mode, the camera focuses continuously, increasing the drain on the battery, and that the sound of the camera focusing may be audible.

 AE BKT EV STEPS

Choose the size of the exposure bracketing increment used when  (AE bracketing) is selected in continuous shooting mode ( 41).

Choose from increments of $\pm\frac{1}{3}$ EV, $\pm\frac{2}{3}$ EV, and ± 1 EV.

 FLASH

Adjust flash brightness. Choose from values between $+\frac{2}{3}$ EV and $-\frac{2}{3}$ EV. The default setting is ± 0 . Note that the desired results may not be achieved depending on shooting conditions and the distance to the subject.

Using the Menus: Playback Mode













Using the Playback Menu

- 1 Press the  button to enter playback mode.
- 2 Press **MENU/OK** to display the playback menu.
- 3 Press the selector up or down to highlight the desired menu item.
- 4 Press the selector right to display options for the highlighted item.
- 5 Press the selector up or down to highlight the desired option.
- 6 Press **MENU/OK** to select the highlighted option.



Playback Menu Options

The following options are available:

| Option | Description |
|---|---|
|  PHOTOBOOK ASSIST | Create books from your favorite photos (📖 52). |
|  IMAGE SEARCH | Search for pictures by date, subject, scene, file type, or rating (📖 54). |
|  ERASE | Delete all or selected pictures (📖 55). |
|  MARK FOR UPLOAD | Select pictures for upload to YouTube or FACEBOOK (📖 81). |
|  SLIDE SHOW | View pictures in a slide show (📖 83). |
|  RED EYE REMOVAL | Create copies with reduced red eye (📖 84). |
|  PROTECT | Protect pictures from accidental deletion (📖 85). |
|  CROP | Create cropped copies of pictures (📖 86). |
|  RESIZE | Create small copies of pictures (📖 87). |
|  IMAGE ROTATE | Rotate pictures (📖 88). |
|  VOICE MEMO | Add voice memos to pictures (📖 89). |
|  PRINT ORDER (DPOF) | Select pictures for printing on DPOF- and PictBridge-compatible devices (📖 61). |
|  DISP. ASPECT | Choose how High Definition (HD) devices display pictures (📖 90). |

MARK FOR UPLOAD

You can select images and movies to be queued for upload to YouTube, Facebook and MyFinePix.com. Select  **MARK FOR UPLOAD** in the playback menu.

■ Add/Remove Items in the Upload Queue

1 Select an upload destination.



2 Press **MENU/OK**.



3 Select items to be added to, or removed from, the upload queue.



4 Press **MENU/OK** to confirm.

- Items not in the upload queue will be added to the queue when you select them and press **MENU/OK**.
- Items in the upload queue will be removed from the queue when you select them and press **MENU/OK**.



5 Repeat steps 3 and 4 as necessary and add or remove items.

When finished, press **DISP/BACK** to save the settings.



Tips

- **YouTube**, **FACEBOOK** or **MyFinePix.com** is displayed to indicate items queued for upload.
- Only movies can be selected for upload to YouTube.
- Only photos can be selected for upload to MyFinePix.com.
- During playback, selected pictures are indicated by  **YouTube**,  **FACEBOOK** or  **MyFinePix.com** icons.

■ Removing All Items From the Upload Queue

You can remove all items from the upload queue.

1 Select **RESET ALL**.

The screen for removing all items from the upload queue is displayed.



2 Select **OK**.



3 Press **MENU/OK**.

All items are removed from the upload queue.



← Note

If there are many items in the upload queue when you select to remove all items from the queue, it may take some time to remove them. To cancel, press **DISP/BACK**.

■ Upload Items

Items added to the upload queue using the camera can be easily uploaded from a computer by using the MyFinePix Studio. Install MyFinePix Studio (📖 66).

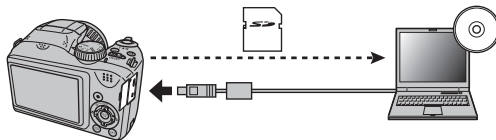



← Note

This feature is available only when using a computer running Windows.

SLIDE SHOW

View pictures in an automated slide show. Choose the type of show and press **MENU/OK** to start. Press **DISP/BACK** at any time during the show to view on-screen help. When a movie is displayed, movie playback will begin automatically, and the slide show will continue when the movie ends. The show can be ended at any time by pressing **MENU/OK**.

| Option | Displayed in |
|--|---|
| NORMAL | Press selector left or right to go back or skip ahead one frame. Select FADE-IN for fade transitions between frames. |
| FADE-IN | |
| NORMAL  | As above, except that camera automatically zooms in on faces selected with Intelligent Face detection. |
| FADE-IN  | |
| MULTIPLE | Display several pictures at once. |

Note



The camera will not turn off automatically while a slide show is in progress.

RED EYE REMOVAL

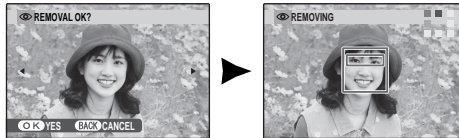
If the current picture is marked with a  icon to indicate that it was taken with Intelligent Face Detection, this option can be used to remove red-eye. The camera will analyze the image; if red-eye is detected, the image will be processed to create a copy with reduced red-eye.



Notes

- Red eye may not be removed if the camera is unable to detect a face or the face is in profile. Results may differ depending on the scene. Red eye can not be removed from pictures that have already been processed using red-eye removal or pictures created with other devices.
- The amount of time needed to process the image varies with the number of faces detected.
- Copies created with  **RED EYE REMOVAL** are indicated by a  icon during playback.

PROTECT

Protect pictures from accidental deletion. The following options are available.

■ FRAME

Protect selected pictures.

- 1 Press the selector left or right to display the desired picture.

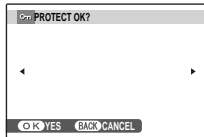

Picture not protected

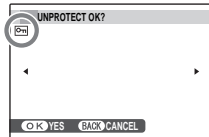

Protected picture

- 2 Press **MENU/OK** to protect the picture. If the picture is already protected, pressing **MENU/OK** will remove protection from the image.



- 3 Repeat steps 1–2 to protect additional images. Press **DISP/BACK** to exit when the operation is complete.



■ SET ALL

Press **MENU/OK** to protect all pictures, or press **DISP/BACK** to exit without changing picture status.

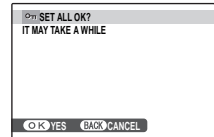

■ RESET ALL

Press **MENU/OK** to remove protection from all pictures, or press **DISP/BACK** to exit without changing picture status.

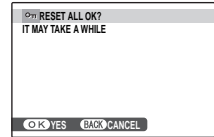

If the number of pictures affected is very large, a message will be displayed while the operation is in progress. Press **DISP/BACK** to exit before the operation is complete.

Caution

Protected pictures will be deleted when the memory card is formatted (🗨 96).

CROP

To create a cropped copy of a picture, play the picture back and select **CROP** in the playback menu (80).

- 1 Use the zoom control to zoom in and out and use the selector to scroll the picture until the desired portion is displayed (to exit to single-frame playback without creating a cropped copy, press **DISP/BACK**).

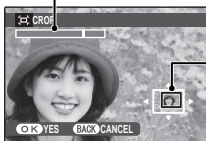

Zoom indicator



Navigation window shows portion of image currently displayed in monitor

If the size of the final copy will be **640**, **YES** will be displayed in yellow.

Tip: Intelligent Face Detection

If the picture was shot with Intelligent Face Detection (32),  will be displayed in the monitor. Press the  button to zoom in on the selected face.



- 2 Press **MENU/OK** to view the copy size. Larger crops produce larger copies.



- 3 Press **MENU/OK** to save the cropped copy to a separate file.

**Note**

Pictures taken with other cameras can not be cropped.

RESIZE

To create a small copy of a picture, play the picture back and select **RESIZE** in the playback menu (page 80).

- 1** Highlight a size and press **MENU/OK** to display a confirmation dialog.



- 2** Press **MENU/OK** to copy the picture at the selected size.



IMAGE ROTATE

By default, pictures taken in tall orientation are displayed in wide orientation. Use this option to display pictures in the correct orientation in the monitor. It has no effect on pictures displayed on a computer or other device.

Notes

- Protected pictures can not be rotated. Remove protection before rotating pictures ( 85).
- The camera may not be able to rotate pictures created with other devices.

To rotate a picture, play the picture back and select  **IMAGE ROTATE** in the playback menu ( 88).

- 1 Press the selector down to rotate the picture 90° clockwise, up to rotate the picture 90° counterclockwise.



- 2 Press **MENU/OK** to confirm the operation (to exit without rotating the picture, press **DISP/BACK**).



The next time the picture is played back, it will automatically be rotated.

VOICE MEMO

To add a voice memo to a still picture, select **VOICE MEMO** after displaying the picture in playback mode.

Note

Voice memos can not be added to movies or protected pictures. Remove protection from pictures before recording voice memos (85).

- 1 Hold the camera at a distance of about 20 cm (8 in.) and face the microphone.

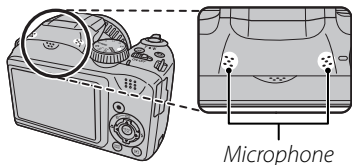

- 2 Press **MENU/OK** to start recording.

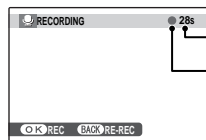



- 3 Press **MENU/OK** again to end recording. Recording ends automatically after 30 seconds.

**Notes**

- If a voice memo already exists for the current picture, a message will be displayed. Select **RE-REC** to replace the existing memo.
- Voice memos are recorded as PCM-format WAV files.

Playing Voice Memos

Pictures with voice memos are indicated by a  icon during playback. To play the voice memo back, select **PLAY** for  **VOICE MEMO** in the playback menu.

Notes

- The camera may not play voice memos recorded with other devices.
- Do not cover the speaker during playback.

DISP. ASPECT

Choose how High Definition (HD) devices display pictures with an aspect ratio of 4 : 3 (this option is available only when an HDMI cable is connected). Select **16:9** to display the image so that it fills the screen with its top and bottom cropped out, **4:3** to display the entire image with black bands at either side.

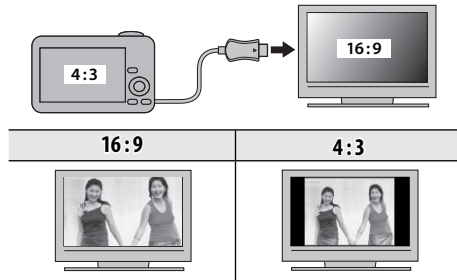

Note

Photographs with an aspect ratio of 16 : 9 are displayed full screen, those with an aspect ratio of 3 : 2 in a black frame.

The Setup Menu

Using the Setup Menu

1 Display the setup menu.

1.1 Press **MENU/OK** to display the menu for the current mode.



1.2 Press the selector left to highlight a left tab.



1.3 Press the selector up or down to select  **SET**.
The setup menu appears.

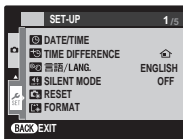

2 Adjust settings.

2.1 Press the selector right to activate the setup menu.



2.2 Press the selector up or down to highlight a menu item.



2.3 Press the selector right to display options for the highlighted item.



2.4 Press the selector up or down to highlight an option.



2.5 Press **MENU/OK** to select the highlighted option.































2.6 Press **DISP/BACK** to exit from the menu.



Setup Menu Options

| Menu item | Description | Options | Default |
|------------------------|---|-------------------------------------|----------------|
| DATE/TIME | Set the camera clock (📖 13). | — | — |
| TIME DIFFERENCE | Set the clock to local time (📖 95). | / | |
| 言語/LANG. | Choose a language (📖 13). | — | ENGLISH |
| SILENT MODE | Disables the AF-assist illuminator (except for the shooting mode), operation sounds, shutter sound, and movie playback sound. | ON/OFF | OFF |
| RESET | Reset all settings except DATE/TIME , TIME DIFFERENCE , BACKGROUND COLOR , and BATTERY TYPE to default values. A confirmation dialog will be displayed, press the selector up or down to highlight OK and press MENU/OK . | — | — |
| FORMAT | Format memory cards (📖 96). | — | — |
| IMAGE DISP. | Choose how long pictures are displayed after shooting (📖 96). | 3 SEC / 1.5 SEC / ZOOM / OFF | 1.5 SEC |
| FRAME NO. | Choose how files are named (📖 97). | CONT. / RENEW | CONT. |
| OPERATION VOL. | Adjust the volume of camera controls. | (high) / (mid) / (low) / (mute) | |
| SHUTTER VOLUME | Adjust the volume of the shutter sound. | | |
| SHUTTER SOUND | Choose the sound made by the shutter. | 1 / 2 | 1 |

| Menu item | Description | Options | Default |
|---|--|---|---|
|  PLAYBACK VOLUME | Adjust the volume for movie and voice memo playback (📖 98). | — | 7 |
|  LCD BRIGHTNESS | Control the brightness of the display (📖 98). | -5 - +5 | 0 |
|  LCD MODE | Choose 30 fps to increase battery life, 60 fps for improved display quality. | 30 fps / 60 fps | 30 fps |
|  LCD MODE 2 | Choose whether to save power to increase battery life (📖 98). |  POWER SAVE ON /  POWER SAVE OFF |  POWER SAVE OFF |
|  AUTO POWER OFF | Choose the auto power off delay (📖 98). | 2 MIN / 5 MIN / OFF | 2 MIN |
|  DUAL IS MODE | Enable image stabilization during shooting (📷 ₁ , CONTINUOUS) or only when the shutter button is pressed halfway (📷 ₂ , SHOOTING ONLY). OFF turns image stabilization off (📖 16). | (📷 ₁) ₁ / (📷 ₂) ₂ / OFF | (📷 ₁) ₁ |
|  RED EYE REMOVAL | Remove “red-eye” effects caused by the flash. | ON / OFF | ON |
|  BLINK DETECTION | Turn blink detection on or off (📖 33). | ON / OFF | ON |
|  DIGITAL ZOOM | Enable or disable digital zoom (📖 99). | ON / OFF | OFF |
|  MOVIE ZOOM TYPE | Choose the zoom type when recording movies (📖 57). | D₁ / Op₁ | Op₁ |
|  AF ILLUMINATOR | Turn the AF-assist illuminator on or off (📖 35). | ON / OFF | ON |
|  SAVE ORG IMAGE | Choose whether to save unprocessed copies of pictures taken using red-eye removal. | ON / OFF | OFF |
|  AUTOROTATE PB | Choose ON to automatically rotate “tall” (portrait-orientation) pictures during playback. | ON / OFF | ON |

| Menu item | Description | Options | Default |
|--|---|--|--|
|  BACKGROUND COLOR | Choose a color scheme. | — | — |
|  GUIDANCE DISPLAY | Choose whether to display tool tips. | ON/OFF | ON |
|  CUSTOM RESET | Reset all settings for mode C . A confirmation dialog will be displayed, press the selector up or down to highlight OK and press MENU/OK . | — | — |
|  BATTERY TYPE | Specify the type of battery used in the camera (📖 8). |  A /  N /  L |  A |
|  DISCHARGE | Discharge rechargeable Ni-MH batteries (📖 99). | — | — |
|  DATE STAMP | Choose whether to add shooting date and time to the pictures. |  31 +  ⌚ /  31 / OFF | OFF |

TIME DIFFERENCE

When travelling, use this option to switch the camera clock instantly from your home time zone to the local time at your destination.

1 Specify the difference between local time and your home time zone.

1.1 Press the selector up or down to highlight  **LOCAL**.



1.2 Press the selector right to display the time difference.



1.3 Press the selector left or right to highlight **+**, **-**, hours, or minutes; press up or down to edit.







1.4 Press **MENU/OK** when settings are complete.



2 Switch between local time and your home time zone.

To switch between local time and your home time zone, highlight  **LOCAL** or  **HOME** and press **MENU/OK**.

-  **HOME**: Switch to the time currently selected for  **DATE/TIME** (📖 13).
-  **LOCAL**: Switch to local time. If this option is selected,  and the time and date will be displayed in yellow for three seconds each time the camera is turned on.

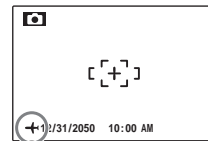

After changing time zones, check that the date and time are correct.

FORMAT

Format a memory card. Highlight **OK** and press **MENU/OK** to begin formatting.

Cautions

- All data—including protected pictures—will be deleted. Be sure important files have been copied to a computer or other storage device.
- Do not open the battery cover during formatting.

IMAGE DISP.

Choose an option other than **OFF** to display pictures in the monitor after shooting. Pictures can be displayed for 1.5 s (**1.5 SEC**), 3 s (**3 SEC**), or until the **MENU/OK** button is pressed (**ZOOM (CONTINUOUS)**). If **ZOOM (CONTINUOUS)** is selected, photos can be zoomed in to check focus and other fine details (see page 48). Note that **ZOOM (CONTINUOUS)** is disabled in continuous shooting mode (41), and that the colors displayed at settings of **1.5 SEC** and **3 SEC** may differ from those in the final picture.

When the picture is zoomed in, the selector can be used to view areas of the image not currently visible in the display.

When the picture was taken with **FACE DETECTION** turned on, detected face is zoomed. When more than one face was detected, you can move to the next face by pressing **▼**.

ZOOM (CONTINUOUS) is disabled in the following case:

- **ZOOM (CONTINUOUS)** is selected in the shooting mode.
- An option other than **OFF** is selected for **CONTINUOUS**.

Blink Detection (📖 33)

At settings other than **OFF**, a warning will be displayed if the camera detects subjects who may have blinked when the picture was taken. If **ZOOM (CONTINUOUS)** is selected, you can view these subjects using zoom.

FRAME NO.

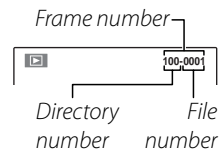

New pictures are stored in image files named using a four-digit file number assigned by adding one to the last file number used. The file number is displayed during playback as shown at right.



 **FRAME NO.** controls whether file numbering is reset to 0001 when a new memory card is inserted or the current memory card is formatted.

- **CONTINUOUS:** Numbering continues from the last file number used or the first available file number, whichever is higher. Choose this option to reduce the number of pictures with duplicate file names.
- **RENEW:** Numbering is reset to 0001 after formatting or when a new memory card is inserted.

Notes

- If the frame number reaches 999-9999, the shutter release will be disabled (📖 113).
- Selecting  **RESET** (📖 92) resets  **FRAME NO.** to **CONTINUOUS** but does not reset frame numbering.
- Frame numbers for pictures taken with other cameras may differ.

 PLAYBACK VOLUME



Press the selector up or down to choose volume for movie and voice memo playback and press **MENU/OK** to select.

 LCD BRIGHTNESS



Press the selector up or down to choose display brightness and press **MENU/OK** to select.

 LCD MODE 2



Choose whether to save power to increase battery life. This option does not take effect during playback or recording movies.

| Option | Description |
|--|--|
|  POWER SAVE ON | The display dims to save power if no operations are performed for a few seconds. Normal brightness can be restored by pressing the shutter button halfway. |
|  POWER SAVE OFF | Automatic dimming off. |

 AUTO POWER OFF

Choose the length of time before the camera turns off automatically when no operations are performed. Shorter times increase battery life; if **OFF** is selected, the camera must be turned off manually. Note that regardless of the option selected, the camera will not turn off automatically when connected to a printer ( 60) or computer ( 68) or when a slide show is in progress ( 83).

 Tip: Reactivating the Camera

To reactivate the camera after it has turned off automatically, use the **ON/OFF** switch or press the  button for about a second ( 12).

DIGITAL ZOOM

If **ON** is selected, selecting **T** at the maximum optical zoom position will trigger digital zoom, further magnifying the image. To cancel digital zoom, zoom out to the minimum digital zoom position and select **W**.

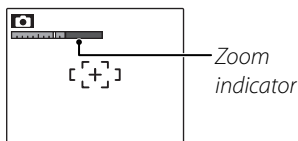

Zoom indicator,
DIGITAL ZOOM off

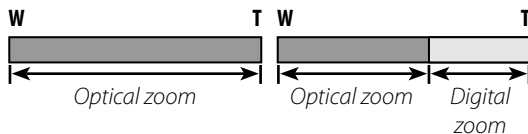

Zoom indicator,
DIGITAL ZOOM on
(except for super macro mode)



Caution

Digital zoom produces lower quality images than optical zoom.

DISCHARGE (Ni-MH Batteries Only)

The capacity of rechargeable Ni-MH batteries may be temporarily reduced when new, after long periods of disuse, or if they are repeatedly recharged before being fully discharged. Capacity can be increased by repeatedly discharging the batteries using the  **DISCHARGE** option and recharging them in a battery charger (sold separately). Do not use  **DISCHARGE** with non-rechargeable batteries, and note that the batteries will not discharge if the camera is powered by an optional AC power adapter and DC coupler.

1 Selecting  **DISCHARGE** displays a confirmation dialog. Press **MENU/OK**.



2 Select **OK**.



- 3 Press **MENU/OK** to begin discharging the batteries. When the batteries are fully discharged, the battery level indicator will blink red and the camera will turn off. To cancel the process before the batteries are fully discharged, press **DISP/BACK**.



DATE DATE STAMP

To add shooting date and time, choose **[31]** + **[⊕]**. To add only shooting date, choose **[31]**. When **OFF** is selected, no information will be added to the pictures.

Notes

- Added shooting date and time can not be deleted from the pictures. To take pictures without date and time, select **OFF** for **DATE** DATE STAMP.
- When the camera clock is not set, setting dialog will be displayed. Set the date and time (📖 13).
- When using **DATE** DATE STAMP, selecting **WITHOUT DATE** for **[PRINT]** PRINT ORDER (DPOF) is recommended (📖 63).
- Date and time can not be added to the movies and the panoramas.

Optional Accessories

The camera supports a wide range of accessories from FUJIFILM and other manufacturers.

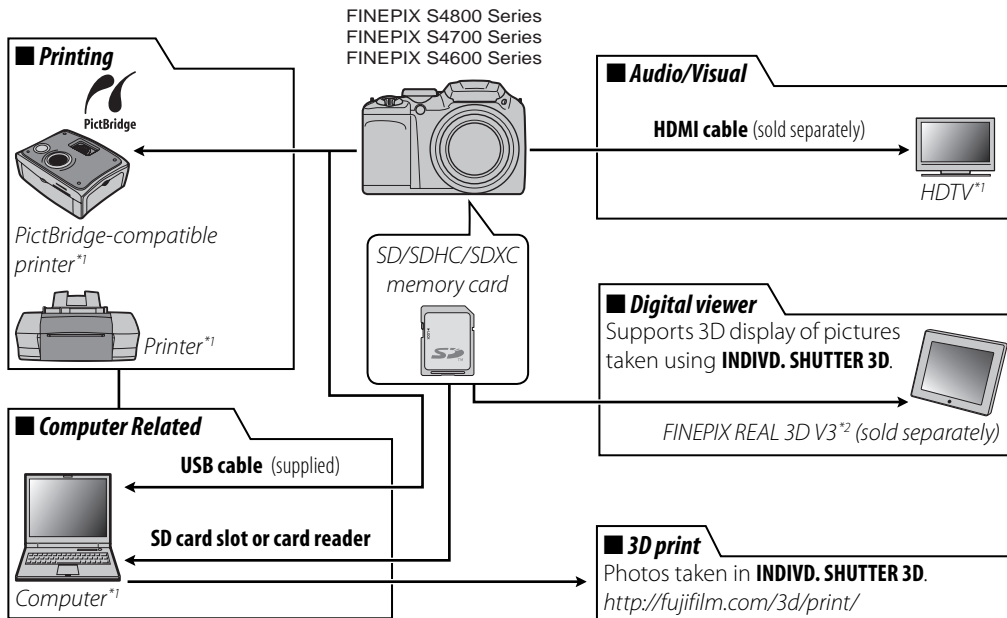



*1 Available separately.

*2 SDXC memory card is not supported.

Accessories from FUJIFILM

The following optional accessories are available from FUJIFILM. For the latest information on the accessories available in your region, check with your local FUJIFILM representative or visit http://www.fujifilm.com/products/digital_cameras/index.html.

| | | | |
|-------------------------|---|--|---|
| AC power adapter | AC-5VX (requires CP-04 DC coupler) | Use for extended playback or when copying pictures to a computer (shape of adapter and plug vary with region of sale). |  |
| DC coupler | CP-04 | Connect the AC-5VX AC power adapter to the camera. |  |
| Digital viewer | FINEPIX REAL 3D V3 | View 3D images without 3D glasses. |  |

Caring for the Camera

To ensure continued enjoyment of the product, observe the following precautions.

Storage and Use

If the camera will not be used for an extended period, remove the battery and memory card. Do not store or use the camera in locations that are:

- exposed to rain, steam, or smoke
- very humid or extremely dusty
- exposed to direct sunlight or very high temperatures, such as in a closed vehicle on a sunny day
- extremely cold
- subject to strong vibration
- exposed to strong magnetic fields, such as near a broadcasting antenna, power line, radar emitter, motor, transformer, or magnet
- in contact with volatile chemicals such as pesticides
- next to rubber or vinyl products

Water and Sand

Exposure to water and sand can also damage the camera and its internal circuitry and mechanisms. When using the camera at the beach or seaside, avoid exposing the camera to water or sand. Do not place the camera on a wet surface.

Condensation

Sudden increases in temperature, such as occur when entering a heated building on a cold day, can cause condensation inside the camera. If this occurs, turn the camera off and wait an hour before turning it on again. If condensation forms on the memory card, remove the card and wait for the condensation to dissipate.

Cleaning

Use a blower to remove dust from the lens and monitor, then gently wipe with a soft, dry cloth. Any remaining stains can be removed by wiping gently with a piece of FUJIFILM lens-cleaning paper to which a small amount of lens-cleaning fluid has been applied. Care should be taken to avoid scratching the lens or monitor. The camera body can be cleaned with a soft, dry cloth. Do not use alcohol, thinner, or other volatile chemicals.

Traveling

Keep the camera in your carry-on baggage. Checked baggage may suffer violent shocks that could damage the camera.

Troubleshooting

Power and Battery

| Problem | Possible cause | Solution | Page |
|---|---|--|------|
| The camera does not turn on. | The batteries are exhausted. | Insert fresh or fully-charged spare batteries. | 7 |
| | The batteries are not in the correct orientation. | Re-insert the batteries in the correct orientation. | 7 |
| | The battery-chamber cover is not latched. | Latch the battery-chamber cover. | 8 |
| | The AC power adapter and DC coupler are not connected properly. | Make sure that the AC power adapter and DC coupler are properly connected. | — |
| | The camera has been left for an extended period with no batteries inserted and the AC power adapter/DC coupler unplugged. | After inserting the batteries or connecting the AC power adapter/DC coupler, wait a few moments before turning the camera on. | — |
| Power supply The batteries run down quickly. | The batteries are cold. | Warm the batteries by placing them in a pocket or other warm place and re-insert them in the camera immediately before taking a picture. | vi |
| | There is dirt on the battery terminals. | Clean the terminals with a soft, dry cloth. | — |
| | The camera is in SRAUTO mode. | Select another shooting mode. | 20 |
| | The batteries are new, have been left unused for an extended period, or have been recharged without first being fully discharged (rechargeable Ni-MH batteries only). | Discharge Ni-MH batteries using the DISCHARGE option and recharge them in a battery charger (sold separately). If the batteries do not hold a charge after repeated discharging and recharging, they have reached the end of their service life and must be replaced. | 99 |
| | <input type="checkbox"/> CONTINUOUS is selected for <input checked="" type="checkbox"/> AF MODE . | Select a different focusing option. | 77 |
| The camera turns off suddenly. | The batteries are exhausted. | Insert fresh or fully-charged spare batteries. | 7 |
| | The AC power adapter or DC coupler has been disconnected. | Make sure that the AC power adapter and DC coupler are properly connected. | — |

Menus and Displays





| Problem | Possible cause | Solution | Page |
|--|--|-------------------------|--------|
| Menus and displays are not in English. | English is not selected for the  言語/LANG. | Select ENGLISH . | 13, 92 |

Shooting

| Problem | Possible cause | Solution | Page |
|---------------------------------------|--|---|-------|
| Taking pictures | Memory is full. | Insert a new memory card or delete pictures. | 9, 55 |
| | Memory is not formatted. | Format the memory card. | 96 |
| | There is dirt on the memory card contacts. | Clean the contacts with a soft, dry cloth. | — |
| | The memory card is damaged. | Insert a new memory card. | 9 |
| | The batteries are exhausted. | Insert fresh or fully-charged spare batteries. | 7 |
| | The camera has turned off automatically. | Turn the camera on. | 12 |
| The monitor goes dark after shooting. | The flash has fired. | The monitor may darken while the flash charges. Wait for the flash to charge. | 37 |
| Focus | The camera does not focus. | The subject is close to the camera. | 36 |
| | | The subject is far away from the camera. | |
| | | The subject is not suited to autofocus. | 34 |

| | Problem | Possible cause | Solution | Page |
|-----------------------------------|--|--|---|-------------|
| 3D image | 3D images do not turn out as expected. | — | Use a tripod or change the distance the camera is moved between the first and second shots. | 23 |
| Intelligent Face Detection | Face detection not available. | Intelligent Face Detection is not available in the current shooting mode. | Choose a different shooting mode. | 20 |
| | No face is detected. | The subject's face is obscured by sunglasses, a hat, long hair, or other objects. | Remove the obstructions. | 32 |
| | | The subject's face occupies only a small area of the frame. | Change the composition so that the subject's face occupies a larger area of the frame. | |
| | | The subject's head is tilted or horizontal. | Ask the subject to hold their head straight. | 16 |
| | | The camera is tilted. | Hold the camera straight. | |
| The subject's face is poorly lit. | Shoot in bright light. | — | | |
| Wrong subject selected. | The selected subject is closer to the center of the frame than the main subject. | Recompose the picture or turn face detection off and frame the picture using focus lock. | 32, 34 | |

| | Problem | Possible cause | Solution | Page |
|---------------------------------|---|---|---|-------------|
| Close-ups | Macro mode is not available. | Macro mode is not available in the current shooting mode. | Choose a different shooting mode. | 20, 36 |
| Flash | The flash does not fire. | The flash is lowered. | Raise the flash. | 37 |
| | | The flash is charging. | Wait for the flash to charge. | 37 |
| | | The flash is not available in the current shooting mode. | Choose a different shooting mode. | 20 |
| | | The batteries are exhausted. | Insert fresh or fully-charged spare batteries. | 7 |
| | | The camera is in super macro or continuous shooting mode. | Turn super macro and continuous shooting modes off. | 36, 41 |
| | Flash mode not available. | The desired flash mode is not available in the current shooting mode. | Choose a different shooting mode. | 20 |
| | The flash does not fully light the subject. | The subject is not in range of the flash. | Position the subject in range of the flash. | 119 |
| The flash window is obstructed. | | Hold the camera correctly. | 16 | |
| Fast shutter speed selected. | | Choose a slower shutter speed. | 28, 30 | |

| Problem | | Possible cause | Solution | Page |
|--------------------------|------------------------------------|--|---|--------|
| Problem images | Pictures are blurred. | The lens is dirty. | Clean the lens. | 103 |
| | | The lens is blocked. | Keep objects away from the lens. | 16 |
| | |  !AF is displayed during shooting and the focus frame is displayed in red. | Check focus before shooting. | 112 |
| | |  is displayed during shooting. | Use the flash or a tripod. | 37, 38 |
| | Pictures are mottled. | The ambient temperature is high and the subject is poorly lit. | This is normal and does not indicate a malfunction. | — |
| | Vertical lines appear in pictures. | The camera has been used continuously at high temperatures. | Turn the camera off and wait for it to cool down. | — |
| | Smear appears in pictures. | The sun or another bright object was in the frame. | White or purple vertical lines may appear when a very bright object is framed in the display. This is normal and does not indicate a malfunction. Smear is not recorded in photographs but may appear in movies. If possible, avoid shooting movies with bright objects in or close to the frame. | — |
| Recording | Pictures are not recorded. | Power was interrupted during shooting. | Turn the camera off before connecting the AC power adapter/DC coupler. Leaving the camera on can result in corrupted files or damage to the memory card. | — |
| Continuous shooting mode | Only one picture is taken. | The self timer is on and an option  and  are selected in continuous shooting mode. | Turn the self-timer off. | 39 |

Playback

| | Problem | Possible cause | Solution | Page |
|-----------|--|--|--|-------------|
| Pictures | Pictures are grainy. | The pictures were taken with a different make or model of camera. | — | — |
| | Playback zoom unavailable. | The picture has been resized or cropped to 640 / 820 or is from another make or model of camera. | — | 48 |
| Audio | No sound in voice memo and movie playback. | The camera is in silent mode. | Turn silent mode off. | 17 |
| | | Playback volume is too low. | Adjust playback volume. | 98 |
| | | The microphone was obstructed. | Hold the camera correctly during recording. | 56, 89 |
| | | The speaker is obstructed. | Hold the camera correctly during playback. | 58, 90 |
| Deletion | Selected pictures not deleted. | Some of the pictures selected for deletion are protected. | Remove protection using the device with which it was originally applied. | 85 |
| Frame no. | File numbering is unexpectedly reset. | The battery-chamber cover was opened while the camera was on. | Turn the camera off before opening the battery-chamber cover. | 12 |

Connections









| | Problem | Possible cause | Solution | Page |
|------------|---|---|-------------------------------|-------------|
| TV | Monitor is off. | The camera is connected to a TV. | View pictures on the TV. | 59 |
| | No picture or sound. | The camera is not properly connected. | Connect the camera correctly. | 59 |
| | | Input on the television is set to "TV". | Set the TV input correctly. | — |
| | | The volume on the television is too low. | Adjust the volume. | — |
| Computer | The computer does not recognize the camera. | The camera is not properly connected. | Connect the camera correctly. | 68 |
| | | | | |
| PictBridge | Pictures can not be printed. | The camera is not properly connected. | Connect the camera correctly. | 60 |
| | | The printer is off. | Turn the printer on. | — |
| | Only one copy is printed. | The printer is not PictBridge-compatible. | — | — |
| | The date is not printed. | | | |

Miscellaneous











| Problem | Possible cause | Solution | Page |
|--|---|--|-------------|
| Nothing happens when the shutter button is pressed. | Temporary camera malfunction. | Remove and reinsert the batteries or disconnect and reconnect the AC power adapter/DC coupler. | 7 |
| | The batteries are exhausted. | Insert fresh or fully-charged spare batteries. | 7 |
| The camera does not function as expected. | Temporary camera malfunction. | Remove and reinsert the batteries or disconnect and reconnect the AC power adapter/DC coupler. If the problem persists, contact your FUJIFILM dealer. | 7 |
| I want to use an AC power adapter and DC coupler overseas. | Check the label on the AC power adapter. | The AC power adapter can be used with voltages of 100–240V and power frequency of 50/60Hz. However, power outlets differ depending on the regions. Consult your travel agent for information on plug adapters. | — |
| Date and time added by DATE DATE STAMP are not correct. | The camera clock is not correctly set. | Reset the date and time. | 13 |
| Date and time are added to the pictures. | [31] +  or [31] is selected for DATE DATE STAMP option. | Added shooting date and time can not be deleted from the pictures. To take pictures without date and time, select OFF for DATE DATE STAMP . | 100 |

Warning Messages and Displays

The following warnings are displayed in the monitor:

| Warning | Description | Solution |
|--|--|---|
|  (red) | Batteries are low. | Insert fresh or fully-charged spare batteries. |
|  (blinks red) | Batteries are exhausted. | |
|  | Slow shutter speed. Picture may be blurred. | Use the flash or mount the camera on a tripod. |
| !AF (displayed in red with red focus frame) | The camera can not focus. | <ul style="list-style-type: none"> • Use focus lock to focus on another subject at the same distance, then recompose the picture ( 34). • Use macro mode to focus when taking close-ups. |
| Aperture or shutter speed shown in red | The subject is too bright or too dark. The picture will be over- or under-exposed. | If the subject is dark, use the flash. |
| BLINK DETECTED | A subject or subjects may have blinked. | Retake the photograph if desired. |
| FOCUS ERROR | Camera malfunction. | Turn the camera off and then on again, taking care not to touch the lens. If the message persists, contact a FUJIFILM dealer. |
| LENS CONTROL ERROR | | |
| CARD NOT INITIALIZED | TURN THE CAMERA OFF, REMOVE LENS CAP OR OBSTRUCTION AND TURN THE CAMERA ON | Format the memory card using the  FORMAT option in the camera setup menu ( 96). Clean the contacts with a soft, dry cloth. If the message is repeated, format the memory card ( 96). If the message persists, replace the memory card. Contact a FUJIFILM dealer. |
| | The memory card is not formatted or the memory card was formatted in a computer or other device. | |
| | The memory card contacts require cleaning. | |
| | Camera malfunction. | Contact a FUJIFILM dealer. |
| PROTECTED CARD | The memory card is locked. | Unlock the memory card ( 9). |

| Warning | Description | Solution |
|----------------|---|---|
| BUSY | The memory card is incorrectly formatted. | Use the camera to format the memory card (📖 96). |
| CARD ERROR | The memory card is not formatted for use in the camera. | Format the memory card (📖 96). |
| | The memory card contacts require cleaning or the memory card is damaged. | Clean the contacts with a soft, dry cloth. If the message is repeated, format the memory card (📖 96). If the message persists, replace the memory card. |
| | Incompatible memory card. | Use a compatible memory card. |
| | Camera malfunction. | Contact a FUJIFILM dealer. |
| SD MEMORY FULL | The memory card is full; pictures can not be recorded. | Delete pictures or insert a memory card with more free space. |
| WRITE ERROR | Memory card error or connection error. | Re-insert the memory card or turn the camera off and then on again. If the message persists, contact a FUJIFILM dealer. |
| | Not enough memory remaining to record additional pictures. | Delete pictures or insert a memory card with more free space. |
| | The memory card is not formatted. | Format the memory card (📖 96). |
| READ ERROR | The file is corrupt or was not created with the camera. | The file can not be played back. |
| | The memory card contacts require cleaning. | Clean the contacts with a soft, dry cloth. If the message is repeated, format the memory card (📖 96). If the message persists, replace the memory card. |
| | Camera malfunction. | Contact a FUJIFILM dealer. |
| FRAME NO. FULL | The camera has run out of frame numbers (current frame number is 999-9999). | Format the memory card and select RENEW for the 📄 FRAME NO. option in the ⚙️ SET-UP menu. Take a picture to reset frame numbering to 100-0001, then return to the 📄 FRAME NO. menu and select CONTINUOUS . |

| Warning | Description | Solution |
|--|--|--|
| TOO MANY FRAMES | An attempt was made to search more than 5,000 images. | The maximum number of images on which searches can be performed is 5,000. |
| PROTECTED FRAME | An attempt was made to add a voice memo to or delete a protected picture. | Remove protection before adding voice memos to or deleting pictures. |
|  ERROR | Voice memo file is corrupt. | The voice memo can not be played back. |
| | Camera malfunction. | Contact a FUJIFILM dealer. |
|  CAN NOT CROP | An attempt was made to crop a  picture. | These pictures can not be cropped. |
| CAN NOT CROP | The picture selected for cropping is damaged or was not created with the camera. | |
|  CANNOT EXECUTE | An attempt was made to resize a  picture. |  and  images can not be resized. |
|  CANNOT EXECUTE | An attempt was made to resize a  picture. | |
| DPOF FILE ERROR | The DPOF print order on the current memory card contains more than 999 images. | The maximum number of images to which DPOF print order can be tagged is 999 per memory card. |
| CAN NOT SET DPOF | The picture can not be printed using DPOF. | — |
|  CAN NOT SET DPOF | Movies can not be printed using DPOF. | — |
| CAN NOT ROTATE | The picture is protected. | Remove protection before rotating pictures. |
|  CAN NOT ROTATE | Movies can not be rotated. | — |
| PRESS AND HOLD THE DISP BUTTON TO DEACTIVATE SILENT MODE | An attempt was made to adjust the volume with the camera in silent mode. | Exit silent mode before adjusting the volume. |
| COMMUNICATION ERROR | A connection error occurred while pictures were being printed or copied to a computer or other device. | Confirm that the device is turned on and that the USB cable is connected. |
| PRINTER ERROR | Printer out of paper or ink, or other printer error. | Check printer (see printer manual for details). To resume printing, turn the printer off and then turn it back on. |
| PRINTER ERROR RESUME? | | Check printer (see printer manual for details). If printing does not resume automatically, press MENU/OK to resume. |

| Warning | Description | Solution |
|--------------------|---|---|
| CAN NOT BE PRINTED | An attempt was made to print a movie, a picture not created with the camera, or a picture in a format not supported by the printer. | Movies and some pictures created with other devices can not be printed. If the picture was created with the camera, check the printer manual to confirm that the printer supports the JFIF-JPEG or Exif-JPEG format. If it does not, the pictures can not be printed. |

Memory Card Capacity

The following table shows the recording time or number of pictures available at different image sizes. All figures are approximate; file size varies with the scene recorded, producing wide variations in the number of files that can be stored. The number of exposures or length remaining may not diminish at an even rate.

| Medium | | 4 GB | | 8 GB | |
|---------------------|----------------------------|----------|--------|----------|--------|
| | | FINE | NORMAL | FINE | NORMAL |
| Photographs | L 4:3 | 480 | 960 | 980 | 1,930 |
| | L 3:2 | 540 | 1,070 | 1,100 | 2,160 |
| | L 16:9 | 640 | 1,270 | 1,300 | 2,550 |
| | M 4:3 | 950 | 1,860 | 1,920 | 3,740 |
| | M 16:9 | 1,260 | 2,430 | 2,530 | 4,880 |
| | S 4:3 | 1,870 | 3,530 | 3,750 | 7,090 |
| | S 16:9 | 3,400 | 6,160 | 6,840 | 12,370 |
| Movies ¹ | HD 1280² | 17 min. | | 35 min. | |
| | 640 | 53 min. | | 107 min. | |
| | 320 | 112 min. | | 226 min. | |















1 Individual movies cannot exceed 2 GB in size or 29 minutes in length, regardless of capacity of memory card.

Recording times shown here are the approximate total time of all recorded movies.

2 Use a CLASS 4 card or better when shooting HD movies.

Specifications

| System | |
|---------------------------------------|--|
| Model | Digital Camera FinePix S4800/S4700/S4600 Series |
| Effective pixels | 16 million |
| CCD | 1/2.3-in., square-pixel CCD with primary color filter |
| Storage media | SD/SDHC/SDXC memory cards |
| File system | Compliant with Design Rule for Camera File System (DCF), Exif 2.3, and Digital Print Order Format (DPOF) |
| File format | <ul style="list-style-type: none">• Still pictures: Exif 2.3 JPEG (compressed) • Audio: WAV/monaural sound• Movies: AVI • Audio: monaural sound• Still pictures (3D): MPO |
| Image size (pixels, file size) | <ul style="list-style-type: none">• L 4:3: 4,608×3,456 (16M)• L 3:2: 4,608×3,072 (14M)• L 16:9: 4,608×2,592 (12M)• M 4:3: 3,264×2,448 (8M)• M 16:9: 3,264×1,840 (5M)• S 4:3: 2,304×1,728 (4M)• S 16:9: 1,920×1,080 (2M) |
| Lens | S4800 series Fujinon 30× optical zoom lens, F/3.1 (wide angle)–5.9 (telephoto) f=4.3 mm–129.0 mm (35-mm format equivalent: 24 mm–720 mm) |
| Focal length | S4700 series Fujinon 28× optical zoom lens, F/3.1 (wide angle)–5.9 (telephoto) f=4.3 mm–120.4 mm (35-mm format equivalent: 24 mm–672 mm) |
| | S4600 series Fujinon 26× optical zoom lens, F/3.1 (wide angle)–5.9 (telephoto) f=4.3 mm–111.8 mm (35-mm format equivalent: 24 mm–624 mm) |

| System | |
|---|---|
| Digital zoom | <ul style="list-style-type: none"> • Still pictures: approx. 7.2× (S4800 series: up to 216.0× / S4700 series: up to 201.6× / S4600 series: up to 187.2×, with optical zoom) • Movies: approx. 3× (HD 1280)/approx. 2× (640, 320) |
| Aperture | F3.1/F8* (wide angle), F5.9/F8/F20* (telephoto), *uses Neutral Density (ND) filter |
| Focus range (distance from front of lens) | <p>Approx. 15 cm (0.4 ft.)–infinity (wide angle); approx. 3.0 m (9.8 ft.)–infinity (telephoto)</p> <ul style="list-style-type: none"> • Macro: approx. 5 cm–3.0 m/1.9 in.–9.8 ft. (wide angle); approx. 1.8 m–3.0 m/5.9 ft.–9.8 ft. (telephoto) • Super macro: approx. 2 cm–100 cm/0.7 in.–3.2 ft. (wide angle) |
| Sensitivity | Standard output sensitivity equivalent to ISO 64, 100, 200, 400, 800, 1600, 3200, 6400 (3200 and 6400 available only at image sizes S); AUTO (400) , AUTO (800) , AUTO (1600) |
| Metering | 256-segment through-the-lens (TTL) metering; MULTI, SPOT, AVERAGE |
| Exposure control | Programmed AE, shutter-priority AE, aperture-priority AE, and manual exposure |
| Exposure compensation | –2 EV – +2 EV in increments of 1/3 EV (P , S , and A modes) |
| Scene recognition | Available (camera automatically selects  ,  ,  ,  ,  , or ) |
| Picture stabilization | Optical stabilization, CCD shift |
| Blink detection | Available |
| Shutter speed (combined mechanical and electronic shutter) | <ul style="list-style-type: none"> • P, S, A, M: 8 s – 1/2,000 s • : 8 s – 1/2 s • : 1/8 s – 1/2,000 s • Other modes: 1/4 s – 1/2,000 s • : 3 s – 1/1,500 s |
| Continuous | <ul style="list-style-type: none"> • : up to 1.2 fps; max. 5 frames • : up to 1.2 fps; maximum number of frames varies with image size and available memory • : up to 1.2 fps; max. 5 frames; last 5 frames recorded • : up to 3.3 fps; max. 20 frames; size M • : up to 1.2 fps; max. 3 frames • : up to 8 fps; max. 40 frames; size S |
| Bracketing | ±1/3 EV, ±2/3 EV, ±1 EV |

| System | |
|-----------------------------|--|
| Focus | <ul style="list-style-type: none"> • Mode: CENTER/MULTI/AREA/CONTINUOUS/TRACKING • Autofocus system: Contrast-detect TTL AF |
| White balance | Automatic scene detection; six manual preset modes for direct sunlight, shade, daylight fluorescent, warm white fluorescent, cool white fluorescent, and incandescent lighting; custom white balance |
| Self-timer | Off, 2 sec, 10 sec |
| Flash | Manual pop-up flash with CCD-metered auto flash control (using monitor pre-flashes); effective range when sensitivity is set to ISO800 is approx. 40 cm–7.0 m/1.3 ft.–22.9 ft. (wide angle) or 2.5 m–3.6 m/8.2 ft.–11.8 ft. (telephoto); effective range in macro mode is approx. 30 cm–3.0 m/0.9 ft.–9.8 ft. (wide angle) or 2.0 m–3.0 m/6.5 ft.–9.8 ft. (telephoto) |
| Flash modes | Auto, forced flash, off, slow synchro (red-eye removal off); auto with red-eye removal, forced flash with red-eye removal, off, slow sync with red-eye removal (red-eye removal on) |
| Monitor | 3.0-in. (7.6 cm), 230k-dot color LCD monitor |
| Frame coverage | Approx. 97% (shooting), 100% (playback) |
| Movie frame rate | HD 1280 (1,280 × 720/720p) / 640 (640 × 480/VGA) / 320 (320 × 240/QVGA); frame rate 30 fps |
| Input/output terminals | |
| HDMI output | HDMI Mini Connector |
| Digital input/output | USB 2.0 High Speed |

Power supply/other**Power sources**

- AA alkaline batteries (x4)
- AA lithium batteries (x4; available from third-party suppliers)
- AA rechargeable nickel-metal hydride (Ni-MH) batteries (x4; available from third-party suppliers)
- AC-5VX AC power adapter and CP-04 DC coupler (sold separately)

Battery life (approximate number of frames that can be taken with fresh or fully charged batteries)

| Battery type | Approximate number of frames |
|--------------------------------------|------------------------------|
| Alkaline (type supplied with camera) | 320 |
| Lithium | 700 |
| Ni-MH | 500 |

CIPA standard, measured in  (auto) mode using batteries supplied with camera (alkaline batteries only) and SD memory card.

Note: Number of shots that can be taken with battery varies with battery charge level and will decline at low temperatures.

Camera dimensions

114.3 mm x 79.7 mm x 97.0 mm/4.5 in. x 3.1 in. x 3.8 in. (W x H x D), excluding projections

Shooting weight**S4800 series**

Approx. 518 g/18.2 oz., including batteries and memory card

S4700 series

Approx. 518 g/18.2 oz., including batteries and memory card

S4600 series

Approx. 518 g/18.2 oz., including batteries and memory card

| | |
|-----------------------------|---|
| Power supply/other | |
| Camera weight | S4800 series Approx. 426 g/15.0 oz., excluding batteries, accessories, and memory cards |
| | S4700 series Approx. 426 g/15.0 oz., excluding batteries, accessories, and memory cards |
| | S4600 series Approx. 426 g/15.0 oz., excluding batteries, accessories, and memory cards |
| Operating conditions | • Temperature: 0 °C – +40 °C / +32 °F – +104 °F • Humidity: 10% – 80% (no condensation) |

Color Television Systems

NTSC (National Television System Committee) is a color television telecasting specification adopted mainly in the U.S.A., Canada, and Japan. PAL (Phase Alternation by Line) is a color television system adopted mainly in European countries and China.

Notices

- Specifications subject to change without notice. FUJIFILM shall not be held liable for damages resulting from errors in this manual.
- Although the monitor is manufactured using advanced high-precision technology, small bright points and anomalous colors (particularly in the vicinity of text) may appear. This is normal for this type of monitor and does not indicate a malfunction; images recorded with the camera are unaffected.
- Digital cameras may malfunction when exposed to strong radio interference (e.g., electric fields, static electricity, or line noise).
- Due to the type of lens used, some distortion may occur at the periphery of images. This is normal.

FUJIFILM

FUJIFILM Corporation

7-3, AKASAKA 9-CHOME, MINATO-KU, TOKYO 107-0052, JAPAN

http://www.fujifilm.com/products/digital_cameras/index.html

Please contact your local distributor for repairs and technical support. (see Worldwide Network list)

| Option | | Shooting mode | | | | | | | | | | | | | | | | | | | | | | | | | |
|----------------|-------------------|---------------|---|---|---|---|---|---|---|---|---|---|---|---|---|---|---|---|---|----------|---|---|---|---|---|---|---|
| | | SP1/SP2 | | | | | | | | | | | | | | | | | | PANORAMA | P | S | A | M | 👤 | | |
| | | SRAUTO | 📷 | 📷 | 📷 | 📷 | 📷 | 📷 | 📷 | 📷 | 📷 | 📷 | 📷 | 📷 | 📷 | 📷 | 📷 | 📷 | 📷 | | | | | | | 📷 | 📷 |
| ISO | AUTO (1600) | | | | | | | | | | | | | | | | | | | | | ✓ | ✓ | | | | |
| | AUTO (800) | | | | | | | | | | | | | | | | | | | | | | ✓ | ✓ | | | |
| | AUTO (400) | | | | | | | | | | | | | | | | | | | | | | ✓ | ✓ | | | |
| | 6400 ⁵ | | | | | | | | | | | | | | | | | | | | | | ✓ | | ✓ | ✓ | |
| | 3200 ⁵ | | | | | | | | | | | | | | | | | | | | | | ✓ | | ✓ | ✓ | |
| | 1600 | | | | | | | | | | | | | | | | | | | | | | ✓ | | ✓ | ✓ | |
| | 800 | | | | | | | | | | | | | | | | | | | | | | ✓ | | ✓ | ✓ | |
| | 400 | | | | | | | | | | | | | | | | | | | | | | ✓ | | ✓ | ✓ | |
| | 200 | | | | | | | | | | | | | | | | | | | | | | ✓ | | ✓ | ✓ | |
| 100 | | | | | | | | | | | | | | | | | | | | | | ✓ | | ✓ | ✓ | | |
| 64 | | | | | | | | | | | | | | | | | | | | | | ✓ | | ✓ | ✓ | | |
| 🔍 | L | ✓ | ✓ | ✓ | ✓ | ✓ | ✓ | ✓ | ✓ | ✓ | ✓ | ✓ | ✓ | ✓ | ✓ | ✓ | ✓ | ✓ | ✓ | ✓ | | ✓ | ✓ | ✓ | ✓ | | |
| | M | ✓ | ✓ | | ✓ | ✓ | ✓ | ✓ | ✓ | ✓ | ✓ | ✓ | ✓ | ✓ | ✓ | ✓ | ✓ | ✓ | ✓ | ✓ | | ✓ | ✓ | ✓ | ✓ | | |
| | S | ✓ | ✓ | | ✓ | ✓ | ✓ | ✓ | ✓ | ✓ | ✓ | ✓ | ✓ | ✓ | ✓ | ✓ | ✓ | ✓ | ✓ | ✓ | 9 | ✓ | ✓ | ✓ | ✓ | | |
| 📺 | HD 1280 | | | | | | | | | | | | | | | | | | | | | | | | | ✓ | |
| | 640 | | | | | | | | | | | | | | | | | | | | | | | | | ✓ | |
| | 320 | | | | | | | | | | | | | | | | | | | | | | | | | ✓ | |
| 📺 | FINE | ✓ | ✓ | ✓ | ✓ | ✓ | ✓ | ✓ | ✓ | ✓ | ✓ | ✓ | ✓ | ✓ | ✓ | ✓ | ✓ | ✓ | ✓ | ✓ | ✓ | ✓ | ✓ | ✓ | ✓ | | |
| | NORMAL | ✓ | ✓ | ✓ | ✓ | ✓ | ✓ | ✓ | ✓ | ✓ | ✓ | ✓ | ✓ | ✓ | ✓ | ✓ | ✓ | ✓ | ✓ | ✓ | ✓ | ✓ | ✓ | ✓ | ✓ | | |
| 📺 | 📺 | ✓ | ✓ | ✓ | ✓ | ✓ | ✓ | ✓ | ✓ | ✓ | ✓ | ✓ | ✓ | ✓ | ✓ | ✓ | ✓ | ✓ | ✓ | ✓ | ✓ | ✓ | ✓ | ✓ | ✓ | | |
| | 📺 | | ✓ | ✓ | ✓ | ✓ | | | | | | | | | | | | | | | | ✓ | ✓ | ✓ | ✓ | | |
| | 📺 | ✓ | ✓ | ✓ | ✓ | ✓ | ✓ | ✓ | ✓ | ✓ | ✓ | ✓ | ✓ | ✓ | ✓ | ✓ | ✓ | ✓ | ✓ | ✓ | ✓ | ✓ | ✓ | ✓ | ✓ | | |
| 📺 ⁸ | | | | | | | | | | | | | | | | | | | | | | ✓ | ✓ | ✓ | ✓ | | |
| WB | | | | | | | | | | | | | | | | | | | | | | ✓ | ✓ | ✓ | ✓ | | |
| 📺 | | | | | | | | | | | | | | | | | | | | | | ✓ | ✓ | ✓ | ✓ | | |
| 📺 (👤 mode) | | | | | | | | | | | | | | | | | | | | | | | | | ✓ | | |
| 📺 | | | | | | | | | | | | | | | | | | | | | | | ✓ | ✓ | ✓ | ✓ | |
| 📺 | | | | | | | | | | | | | | | | | | | | | | | ✓ | ✓ | ✓ | ✓ | |

| Option | Shooting mode | | | | | | | | | | | | | | | | | | | | | | | | | | |
|--------|----------------|----------------|---------|----------------|---|---|---|---|----------------|----------------|----------------|---|---|----------------|----------------|---|----------------|----------------|---|----------------|----------------|----------------|----------------|---|---|---|---|
| | SR/AUTO | 📷 | SP1/SP2 | | | | | | | | | | | | | | | | | P | S | A | M | 👤 | | | |
| | | | 📷 | 📷 | 📷 | 📷 | 📷 | 📷 | 📷 | 📷 | 📷 | 📷 | 📷 | 📷 | 📷 | 📷 | 📷 | 📷 | 📷 | | | | | | 📷 | 📷 | 📷 |
| 📷 | | | | | | | | | | | | | | | | | | | | | | ✓ | ✓ | ✓ | ✓ | | |
| 📷 | | | | | | | | | | | | | | | | | | | | | | | ✓ | ✓ | ✓ | ✓ | |
| 📷 | 📷 ₁ | ✓ | ✓ | ✓ | ✓ | ✓ | ✓ | ✓ | ✓ | ✓ | ✓ | ✓ | ✓ | ✓ | ✓ | ✓ | ✓ | ✓ | ✓ | ✓ | ✓ | ✓ | ✓ | ✓ | ✓ | ✓ | |
| | 📷 ₂ | ✓ | ✓ | ✓ | ✓ | ✓ | ✓ | ✓ | ✓ | ✓ | ✓ | ✓ | ✓ | ✓ | ✓ | ✓ | ✓ | ✓ | ✓ | ✓ | ✓ | ✓ | ✓ | ✓ | ✓ | | |
| AFS | ON | ✓ | ✓ | ✓ | ✓ | ✓ | ✓ | ✓ | | | | ✓ | | | ✓ | ✓ | ✓ | ✓ | ✓ | ✓ | ✓ | ✓ | ✓ | ✓ | ✓ | ✓ | |
| | OFF | ✓ | ✓ | ✓ | ✓ | ✓ | ✓ | ✓ | ✓ ¹ | ✓ ¹ | ✓ ¹ | ✓ | ✓ | ✓ ¹ | ✓ ¹ | ✓ | ✓ ¹ | ✓ ¹ | ✓ | ✓ ¹ | ✓ ¹ | ✓ | ✓ ¹ | ✓ | ✓ | ✓ | |
| 📷 | ON | | ✓ | | ✓ | ✓ | ✓ | ✓ | ✓ | ✓ | ✓ | ✓ | ✓ | ✓ | ✓ | ✓ | ✓ | ✓ | ✓ | ✓ | ✓ | | ✓ | ✓ | ✓ | ✓ | |
| | OFF | ✓ ¹ | ✓ | ✓ ¹ | ✓ | ✓ | ✓ | ✓ | ✓ | ✓ | ✓ | ✓ | ✓ | ✓ | ✓ | ✓ | ✓ | ✓ | ✓ | ✓ | ✓ | ✓ | ✓ ¹ | ✓ | ✓ | ✓ | |
| 📷 | 30fps | ✓ | ✓ | ✓ | ✓ | ✓ | ✓ | ✓ | ✓ | | ✓ | ✓ | ✓ | ✓ | ✓ | ✓ | ✓ | ✓ | ✓ | ✓ | ✓ | ✓ ¹ | ✓ | ✓ | ✓ | ✓ | |
| | 60fps | ✓ | ✓ | ✓ | ✓ | ✓ | ✓ | ✓ | ✓ | ✓ ¹ | ✓ | ✓ | ✓ | ✓ | ✓ | ✓ | ✓ | ✓ | ✓ | ✓ | ✓ | ✓ | ✓ | ✓ | ✓ | ✓ | |
| 📷 | | ✓ | ✓ | ✓ | ✓ | ✓ | ✓ | ✓ | | | ✓ | ✓ | | ✓ | ✓ | ✓ | ✓ | ✓ | ✓ | ✓ | ✓ | | ✓ | ✓ | ✓ | ✓ | |

1 Automatically optimized for selected shooting mode.

2 Flash turns off automatically in super macro mode (📷).

3 Lower flash to select 📷 in modes other than 📷.

4 Disabled if flash fires when set to **AUTO** or 📷 or if flash is set to 📷 or 📷 and subject is poorly lit.

5 Image sizes over **S** are set to **S**.

6 Image sizes over **M** are set to **M**.

7 Tall (portrait-orientation) framing not available at continuous shooting settings of 📷, 📷, 📷, or 📷.

8 Fixed at 📷 when Intelligent Face Detection is on.

9 Aspect ratio fixed at 4:3.