

 **FUJIFILM**

digital
Tools for the imagination.

xD
xD-Picture Card™

Exif Print

PictBridge



DIGITAL CAMERA
FinePix S5100
DIGITAL CAMERA
FinePix S5500

OWNER'S MANUAL

This manual will show you how to use your
FUJIFILM DIGITAL CAMERA FinePix S5100/FinePix S5500 correctly.
Please follow the instructions carefully.

1 Getting Ready

2 Using
the Camera

3 Advanced
Features

4 Settings

5 Software
Installation

6 Viewing Images

Warning (For customers of FinePix S5100)

To prevent fire or shock hazard, do not expose the unit to rain or moisture.

For customers in the U.S.A.

**Tested To Comply
With FCC Standards
FOR HOME OR OFFICE USE**

FCC Statement

This device complies with part 15 of the FCC Rules. Operation is subject to the following two conditions: (1) This device may not cause harmful interference, and (2) this device must accept any interference received, including interference that may cause undesired operation.

CAUTION

This equipment has been tested and found to comply with the limits for a Class B digital device, pursuant to Part 15 of the FCC Rules. These limits are designed to provide reasonable protection against harmful interference in a residential installation. This equipment generates, uses, and can radiate radio frequency energy and, if not installed and used in accordance with the instructions, may cause harmful interference to radio communications. However, there is no guarantee that interference will not occur in a particular installation. If this equipment does cause harmful interference to radio or television reception, which can be determined by turning the equipment off and on, the user is encouraged to try

to correct the interference by one or more of the following measures:

- Reorient or relocate the receiving antenna.
- Increase the separation between the equipment and receiver.
- Connect the equipment into an outlet on a circuit different from that to which the receiver is connected.
- Consult the dealer or an experienced radio/TV technician for help.

You are cautioned that any changes or modifications not expressly approved in this manual could void the user's authority to operate the equipment.

Notes on the Grant:

To comply with Part 15 of the FCC rules, this product must be used with a Fujifilm-specified ferrite-core A/V cable, USB cable and DC supply cord.

For customers in Canada

CAUTION

This Class B digital apparatus complies with Canadian ICES-003.

Please read the Safety Notes (→P.118) and make sure you understand them before using the camera.

IMPORTANT

NOTICE

BEFORE OPENING THE CD-ROM PROVIDED BY FUJI PHOTO FILM CO., LTD., PLEASE READ THIS END USER LICENSE AGREEMENT CAREFULLY. ONLY IF YOU AGREE WITH THIS AGREEMENT, SHOULD YOU USE THE SOFTWARE RECORDED ON THE CD-ROM. BY OPENING THE PACKAGE, YOU ACCEPT AND AGREE TO BE BOUND BY THIS AGREEMENT.

End User License Agreement

This End User License Agreement ("Agreement") is an agreement between Fuji Photo Film Co., Ltd. ("FUJIFILM") and you, which sets forth the terms and conditions of the license granted for you to use the software provided by FUJIFILM.

The CD-ROM contains third party software. In case a separate agreement is provided by a third party supplier for its software, the provisions of such separate agreement shall apply to the use of such third party software, prevailing over those of this Agreement.

1. Definitions.

- "Media" means the CD-ROM titled "Software for FinePix AX" which is provided to you together with this Agreement.
- "Software" means the software which is recorded on Media.
- "Documentation" means the operation manuals of Software and other related written materials which are provided to you together with Media.
- "Product" means Media (including Software) and Documentation collectively.

2. Use of Software.

FUJIFILM grants to you a nontransferable, nonexclusive license:

- to install one copy of Software onto one computer in binary machine executable form;
- to use Software on the computer onto which Software is installed; and
- to make one backup copy of Software.

3. Restrictions.

- You shall not distribute, rent, lease or otherwise transfer all or any part of Software, Media or Documentation to any third party without FUJIFILM's prior written consent. You also shall not sublicense, assign or otherwise transfer all or any part of the rights granted to you by FUJIFILM under this Agreement without FUJIFILM's prior written consent.
- Except as expressly granted by FUJIFILM hereunder, you shall not copy or reproduce all or any part of Software or Documentation.
- You shall not modify, adapt or translate Software or Documentation. You also shall not alter or remove copyright and other proprietary notices that appear on or in Software or Documentation.
- You shall not, or shall not have any third party, reverse-engineer, decompile, or disassemble Software.

Be sure to read this page before using the Software.

4. Ownership.

All copyrights and other proprietary rights to Software and Documentation are owned and retained by FUJIFILM or the third party suppliers as indicated on or in Software or Documentation. Nothing contained herein shall be construed, expressly or implicitly, as transferring or granting any right, license, or title to you other than those explicitly granted under this Agreement.

5. Limited Warranty.

FUJIFILM warrants to you that Media is free from any defect in material and workmanship under normal use for ninety (90) days from the date of your receipt of Media. Should Media not meet the foregoing warranty, FUJIFILM shall replace such defective Media with other Media bearing no defect. FUJIFILM's entire liability and your sole and exclusive remedy with regard to any defect in Media shall be expressly limited to such FUJIFILM's replacement of Media as provided herein.

6. DISCLAIMER OF WARRANTY.

EXCEPT AS PROVIDED IN SECTION 5 HEREIN, FUJIFILM PROVIDES PRODUCT "AS IS" AND WITHOUT WARRANTIES OF ANY KIND, EXPRESS OR IMPLIED. FUJIFILM SHALL MAKE NO WARRANTY, EXPRESS, IMPLIED OR STATUTORY, AS TO ANY OTHER MATTERS, INCLUDING, BUT NOT LIMITED TO NON-INFRINGEMENT OF ANY COPYRIGHT, PATENT, TRADE SECRET, OR ANY OTHER PROPRIETARY RIGHTS OF ANY THIRD PARTY, MERCHANTABILITY, OR FITNESS FOR ANY PARTICULAR PURPOSE.

7. LIMITATION OF LIABILITY.

IN NO EVENT SHALL FUJIFILM HAVE ANY LIABILITY FOR ANY GENERAL, SPECIAL, DIRECT, INDIRECT, CONSEQUENTIAL, INCIDENTAL, OR OTHER DAMAGES (INCLUDING DAMAGES FOR LOSS OF PROFITS OR LOST SAVINGS) INCURRED FROM THE USE OF OR INABILITY TO USE PRODUCT EVEN IF FUJIFILM HAS BEEN ADVISED OF THE POSSIBILITY OF SUCH DAMAGES.

8. No export.

You acknowledge that neither Software nor any part thereof, will be transferred, or exported to any country or used in any manner in violation of any export control laws and regulations to which Software is subject.

9. Termination.

In case you breach any of the terms and conditions hereof, FUJIFILM may immediately terminate this Agreement without any notice.

10. Term.

This Agreement is effective until the date when you cease to use Software, unless earlier terminated in accordance with Section 9 hereof.

11. Obligation upon termination.

Upon termination or expiration of this Agreement, you shall, at your own responsibility and expense, delete or destroy immediately all Software (including its copies), Media and Documentation.

12. Governing Law.

This Agreement shall be governed by and construed in accordance with laws of Japan.

EC Declaration of Conformity

We

Name: Fuji Photo Film (Europe) G.m.b.H.
Address: Heesenstrasse 31
40549 Dusseldorf, Germany

declare that the product

Product Name: FUJIFILM DIGITAL CAMERA FinePix S5100/FinePix S5500
Manufacturer's Name: Fuji Photo Film Co., Ltd.
Manufacturer's Address: 26-30, Nishiazabu 2-chome, Minato-ku,
Tokyo 106-8620, Japan

is in conformity with the following Standards

Safety: EN60065
EMC: EN55022: 1998 Classe B
EN55024: 1998
EN61000-3-2: 1995 + A1:1998 + A2:1998

following the provision of the EMC Directive (89/336/EEC, 92/31/EEC and 93/68/EEC) and Low Voltage Directive (73/23/EEC).

CE

Dusseldorf, Germany September 1, 2004

Place

Date

Signature/Managing Director



Bij dit produkt zijn batterijen geleverd. Wanneer deze leeg zijn, moet u ze niet weggooien maar inleveren als KCA

Contents

Warning (For customers of FinePix S5100)	2	Camera parts and features	8
IMPORTANT	2	Example of screen text display	9
EC Declaration of Conformity	3	■ Photography mode	9
Preface	6	■ Playback mode	9
Accessories included	7		

1 Getting Ready

ATTACHING THE LENS CAP / STRAP / ADAPTER RING	10
Attaching the lens cap	10
LOADING THE BATTERIES	11
Compatible batteries	11
INSERTING THE MEDIA	12
Checking the battery charge	13
TURNING ON AND OFF / SETTING THE DATE AND TIME	14
CORRECTING THE DATE AND TIME	15
CHANGING THE DATE ORDER	15
SELECTING THE LANGUAGE	16

2 Using the Camera

BASIC OPERATION GUIDE	17
PHOTOGRAPHY MODE	
TAKING PICTURES (AUTO AUTO MODE)	20
USING LCD MONITOR	23
AF-ASSIST ILLUMINATOR	24
NUMBER OF AVAILABLE FRAMES	24
■ Standard number of frames per xD-Picture Card	24
USING AF/AE LOCK	25
USING THE ZOOM (OPTICAL ZOOM/DIGITAL ZOOM)	26
BEST FRAMING	26
PLAYBACK MODE	
VIEWING THE IMAGES (PLAYBACK)	27
Single-frame playback / Selecting images / Multi-frame playback	27
Playback zoom	28
ERASING IMAGES (ERASE FRAME)	29

3 Advanced Features

STILL PHOTOGRAPHY	
PHOTOGRAPHY FUNCTIONS	
FOCUSING (DISTANCE)	30
EXPOSURE (SHUTTER SPEED AND APERTURE)	31
TAKING PICTURES — SELECTING THE CAMERA SETTINGS	32
AUTO AUTO / P PORTRAIT / L LANDSCAPE / S SPORTS / N NIGHT SCENE	34
PROGRAMMED AUTO	35
SHUTTER-PRIORITY AUTO	36
APERTURE-PRIORITY AUTO	37
MANUAL	38
MACRO (CLOSE-UP)	39
FLASH	40
Auto flash	41
Red-eye reduction	41
Forced flash	42
Slow synchro	42
Red-eye reduction + Slow synchro	42
CONTINUOUS SHOOTING	43
Top 3-frame continuous shooting	44
Auto bracketing	44
Final 3-frame continuous shooting	44
Long-period continuous shooting	45
EXPOSURE COMPENSATION	46
CONTINUOUS AF	47
MANUAL FOCUS	48
INCREASING MONITOR BRIGHTNESS	49
PHOTO MODE PHOTOGRAPHY	
QUALITY MODE (NUMBER OF RECORDED PIXELS)	50
Quality settings in Photography mode	50
S SENSITIVITY	51
F FinePix COLOR	52
PHOTOGRAPHY MENU	
PHOTOGRAPHY MENU OPERATION	53
PHOTOGRAPHY MENU	54
T SELF-TIMER PHOTOGRAPHY	54
W WHITE BALANCE	55
A AF MODE	57

C CENTER	57
M MULTI	57
A AREA	58
PHOTOMETRY	58
B BRACKETING	59
S SHARPNESS	59
F FLASH BRIGHTNESS ADJUSTMENT	59
PLAYBACK	
PLAYBACK FUNCTIONS	
PLAYBACK INFORMATION	60
PLAYBACK MENU	
E ERASING SINGLE / ALL FRAMES	61
P PROTECTING IMAGES: FRAME / SET ALL / RESET ALL	63
A AUTOMATIC PLAYBACK	65
R RECORDING VOICE MEMOS	66
P PLAYING BACK VOICE MEMOS	68
■ Playing back voice memos	68
T TRIMMING	69
PHOTO MODE PLAYBACK	
H HOW TO SPECIFY PRINT OPTIONS (DPOF)	71
D DPOF SET FRAME	72
Z DPOF ALL RESET	74
MOVIE	
MOVIE MODE	
R RECORDING MOVIES	75
■ Recording times for xD-Picture Card	75
PHOTO MODE MOVIE	
Q QUALITY SETTINGS IN MOVIE MODE	77
PLAYBACK MODE	
PLAYING BACK MOVIES	78
■ Playing back movies	78

4 Settings

* ADJUSTING THE MONITOR BRIGHTNESS / VOLUME	79
SET-UP	80
U USING THE SET-UP SCREEN	80
■ SET-UP menu options	81
POWER SAVE SETTING	82
FORMAT	82
WORLD TIME (TIME DIFFERENCE)	83
FRAME NO.	85
CCD-RAW	85

5 Software Installation

5.1 INSTALLATION ON A Windows PC	86
5.2 INSTALLATION ON A Mac OS 9.2	88
5.3 INSTALLATION ON A Mac OS X	91

6 Viewing Images

6.1 CAMERA CONNECTION	94
6.1.1 Using the AC power adapter (sold separately)	94
6.1.2 Connecting to a TV	94
6.2 CONNECTING TO A PC	95
6.2.1 Connecting to a PC	95
6.2.2 Disconnecting the Camera	98
6.3 USING FinePixViewer	99
6.3.1 Mastering FinePixViewer	99
6.3.2 Uninstalling the software	99
6.4 CONNECTING THE CAMERA DIRECTLY TO THE PRINTER — PictBridge FUNCTION	101
6.4.1 Specifying images for printing on the camera	101
6.4.2 Specifying images for printing without using DPOF (single-frame printing)	102

System Expansion Options	104	Using the AA-size Ni-MH batteries correctly	108
Accessories Guide	105	AC Power Adapter	108
Conversion Lens Guide (sold separately)	106	Procedure for discharging rechargeable Ni-MH batteries	109
Wide conversion lens WL-FX9/WL-FX9B	106	Notes on the xD-Picture Card™	110
Teleconversion lens TL-FX9/TL-FX9B	106	Warning Displays	111
Using Your Camera Correctly	107	Troubleshooting	113
Power Supply and Batteries	107	Specifications	115
Applicable Batteries	107	Explanation of Terms	117
Notes on the Batteries	107	Safety Notes	118

Preface

■ Test Shots Prior to Photography

For important photographs (such as weddings and overseas trips), always take a test shot and view the image to make sure that the camera is working normally.

● Fuji Photo Film Co., Ltd. cannot accept liability for any incidental losses (such as the costs of photography or the loss of income from photography) incurred as a result of faults with this product.

■ Notes on Copyright

Images recorded using your digital camera system cannot be used in ways that infringe copyright laws without the consent of the owner, unless intended only for personal use. Note that some restrictions apply to the photographing of stage performances, entertainments and exhibits, even when intended purely for personal use. Users are also asked to note that the transfer of **xD-Picture Card** containing images or data protected under copyright laws is only permissible within the restrictions imposed by those copyright laws.

■ Liquid Crystal

If the LCD monitor or viewfinder (EVF) is damaged, take particular care with the liquid crystal in the monitor or viewfinder. If any of the following situations arise, take the urgent action indicated.

- If liquid crystal comes in contact with your skin
Wipe the area with a cloth and then wash thoroughly with soap and running water.
- If liquid crystal gets into your eye
Flush the affected eye with clean water for at least 15 minutes and then seek medical assistance.
- If liquid crystal is swallowed
Flush your mouth thoroughly with water. Drink large quantities of water and induce vomiting. Then seek medical assistance.

■ Notes on Electrical Interference

If the camera is to be used in hospitals or aircrafts, please note that this camera may cause interference to other equipment in the hospital or aircraft. For details, please check with the applicable regulations.

■ Handling Your Digital Camera

This camera contains precision electronic components. To ensure that images are recorded correctly, do not subject the camera to impact or shock while an image is being recorded.

■ Trademark Information

- **xD-Picture Card** and **xD-Picture Card™** are trademarks of Fuji Photo Film Co., Ltd.
- IBM PC/AT is a registered trademark of International Business Machines Corp. of the U.S.A.
- Macintosh, Power Macintosh, iMac, PowerBook, iBook and Mac OS are trademarks of Apple Computer, Inc., registered in the U.S. and other countries.
- Adobe Acrobat® Reader® is a trademark of Adobe Systems Incorporated of the U.S.
- Microsoft, Windows, and the Windows logo are trademarks, or registered trademarks of Microsoft Corporation in the United States and/or other countries. Windows is an abbreviated term referring to the Microsoft® Windows® Operating System.
- * The "Designed for Microsoft® Windows® XP" logo refers to the camera and the driver only.
- Other company or product names are trademarks or registered trademarks of the respective companies.

■ Explanation of Color Television System

NTSC: National Television System Committee, color television telecasting specifications adopted mainly in the U.S.A., Canada and Japan.

PAL: Phase Alternation by Line, a color television system adopted mainly by European countries and China.

■ Exif Print (Exif ver. 2.2)

Exif Print Format is a newly revised digital camera file format that contains a variety of shooting information for optimal printing.

Accessories included

- AA-size alkaline batteries (LR6) (4)

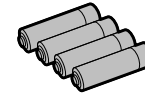

- 16 MB, xD-Picture Card™ (1)

Included with: Anti-static case (1)



- Shoulder strap (1)



- Adapter ring AR-FX5A (1)

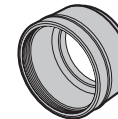

- Lens cap (1)



- A/V cable for FinePix S5100/
FinePix S5500 (1)
approx. 1.5 m (4.9 ft.), plug (2.5 mm dia.) to pin-plug x2

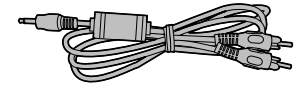

- USB cable (mini-B) (1)

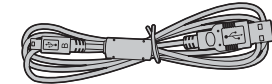

- CD-ROM (1)

Software for FinePix AX



- Owner's Manual (this manual) (1)

Camera parts and features

* Refer to the pages in parentheses for information on using the camera parts or features.

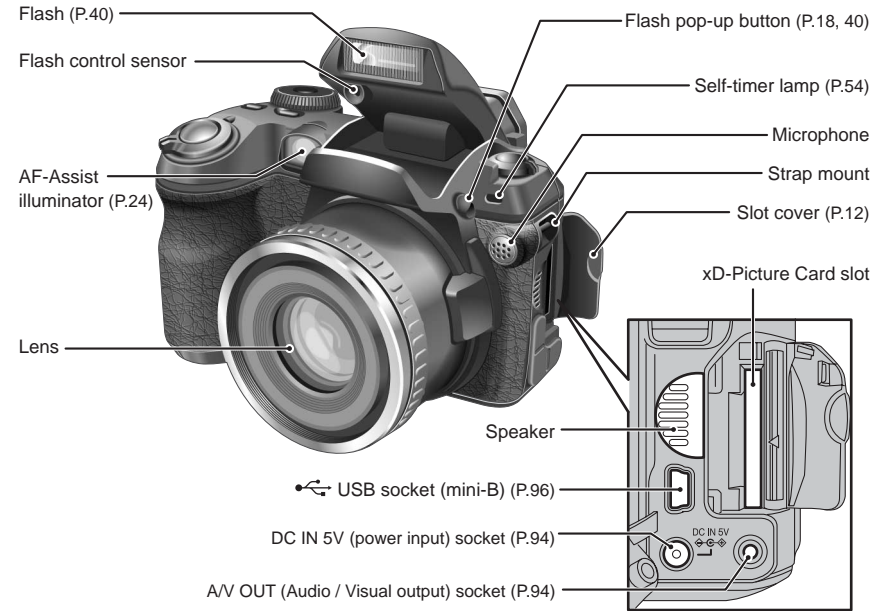
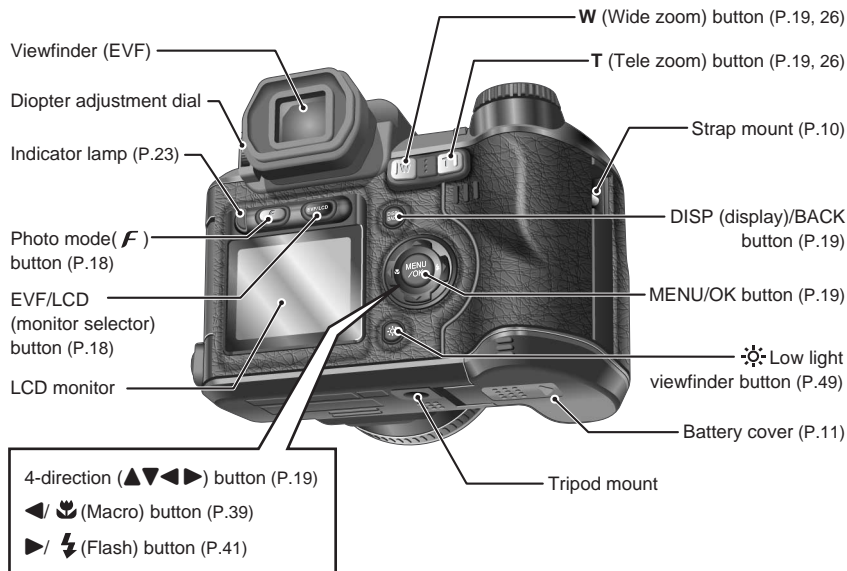
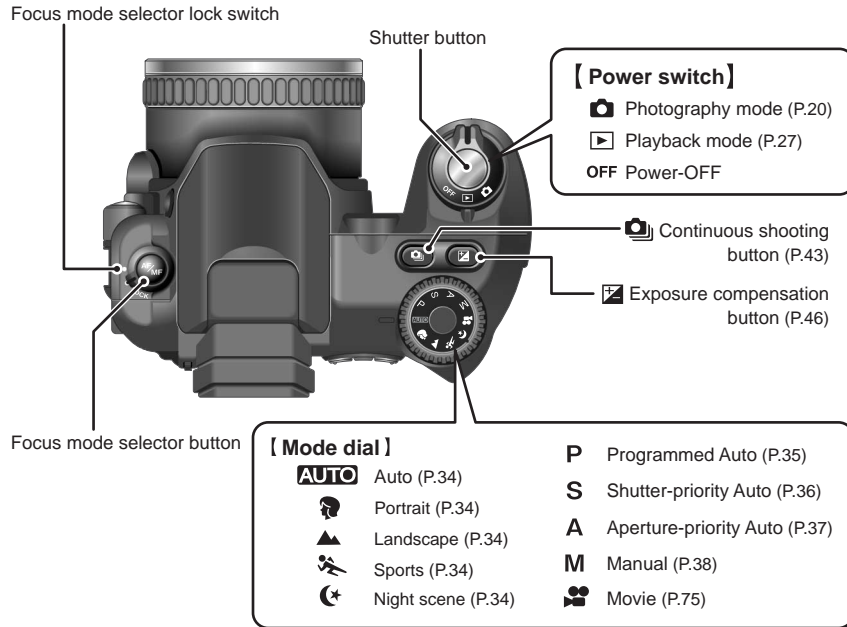

Example of screen text display

Photography mode

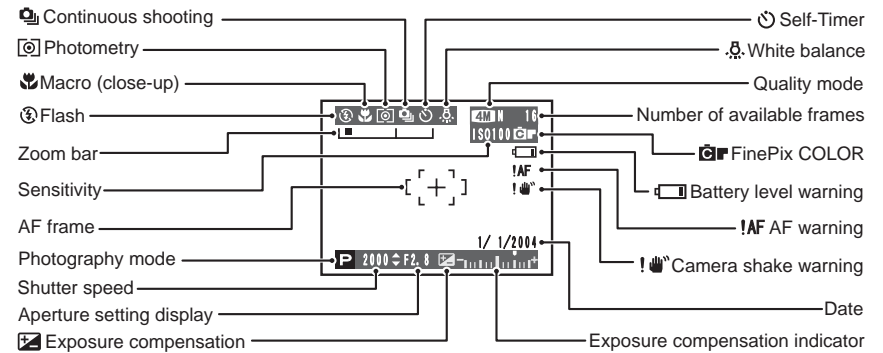

Playback mode

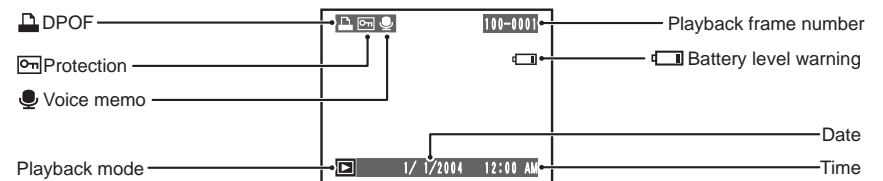

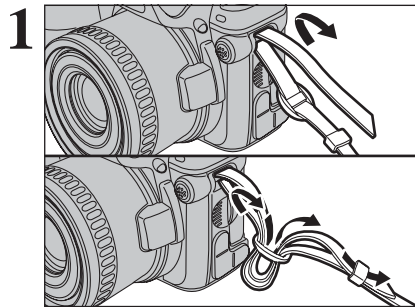

1 Attach the strap to the strap mounts on the camera. Once you have attached both ends of the strap, check carefully to make sure that the strap is firmly secured.

⚠ Attach the strap correctly to avoid dropping the camera.

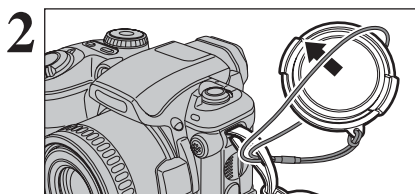

2 Pull the lens cap cord through the strap.

⚠ Attach the lens cap cord to prevent losing the lens cap.

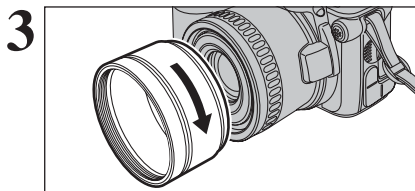

3 Screw the adapter ring in the direction of the arrow to mount it on the camera.

Mount the adapter ring on the camera at all times. This setting blocks unwanted external light, protects the lens and allows the optional conversion lens to be attached.

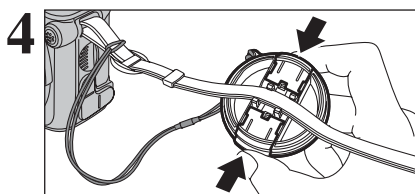

Attaching the lens cap

To prevent the lens cap from appearing in the shot when you take pictures, attach the lens cap to the strap.

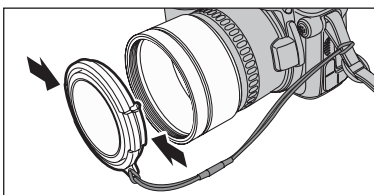

Attach the lens cap to the lens by pressing in on each side of the cap.

Compatible batteries

- AA-size alkaline batteries (LR6) (4), or AA-size Ni-MH batteries (HR-AA) (4) (sold separately).
- ⚠ Please use the same brand and grade AA-size alkaline batteries as those supplied with the camera.

◆ **How to use the batteries** ◆

- Never use the following types of batteries, as this could cause serious problems such as battery fluid leakage or overheating:
 1. Batteries with split or peeling outer casings
 2. Combinations of different types of batteries or new and used batteries together
- Do not use manganese or Ni-Cd batteries.
- Soil, such as fingerprints on the poles of the batteries can shorten time for which the batteries can be used.
- The time for which AA-size alkaline batteries (referred to hereafter simply as alkaline batteries) can be used varies depending on the brand. Some alkaline batteries may stop providing power more quickly than those supplied with the camera. Note also that due to their nature, the time for which alkaline batteries can be used decreases in cold conditions (0°C to +10°C/+32°F to +50°F). The use of AA-size Ni-MH batteries is better for this reason.
- Use Fujifilm Battery charger (sold separately) to charge AA-size Ni-MH batteries.
- See P.107-108 for other notes on using batteries.
- When first purchased or if left unused for a long period, the amount of time which AA-size Ni-MH batteries can be used may be short. See P.108 for more information.

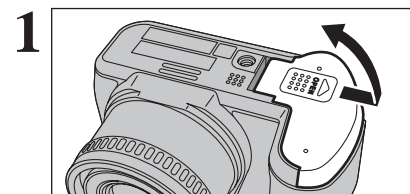
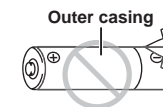

1 Check that the camera is turned off (indicator lamp is off) before opening the battery cover.

- ⚠ If opening the battery cover while the camera is still on, the camera will turn off.
- ⚠ Do not apply force to the battery cover.

Do not open the battery cover while the camera is on. This could damage the xD-Picture Card or ruin the image files on the xD-Picture Card.

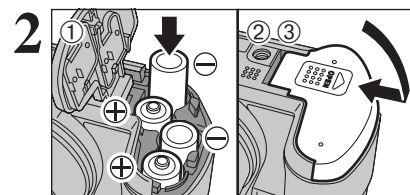

- ① Load the batteries correctly as indicated by the polarity icons.
- ② Press on the battery cover to push the batteries down.
- ③ Slide the battery cover closed.

INSERTING THE MEDIA

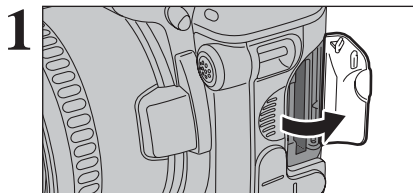

Set the Power switch to "OFF". Open the slot cover after checking that the indicator lamp is off.

⚠ If opening the slot cover while the camera is still on, the camera will turn off.

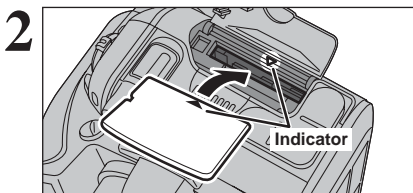

Align the indicators on the xD-Picture Card slot and **xD-Picture Card** and then push the card firmly all the way into the slot.

⚠ If the **xD-Picture Card** is oriented incorrectly, it will not go all the way into the slot. Do not apply force when inserting an **xD-Picture Card**.

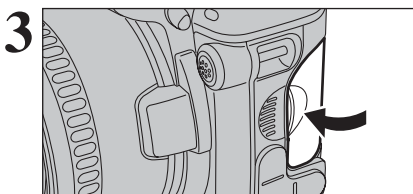

Close the slot cover.

◆ How to replace the xD-Picture Card ◆

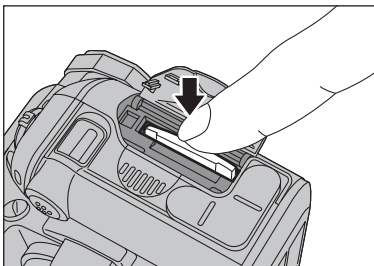

Make sure that the camera is turned off before opening the slot cover. Push the **xD-Picture Card** into the slot and then slowly remove your finger. The lock is released and the **xD-Picture Card** is pushed out.



Checking the battery charge

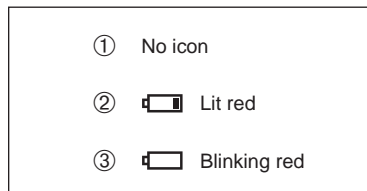

Turn the camera on and check the battery charge.

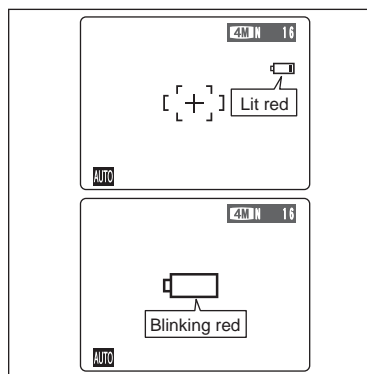

- ① There is ample battery charge.
- ② There is insufficient charge left in the batteries. The batteries will soon run out. Have a new set of batteries ready.
- ③ The batteries are depleted. The display will shortly go blank and the camera will stop working. Replace or recharge the batteries.





"" appears as a small icon on the right-hand side of the screen. "" appears as a large icon in the center of the screen.



⚠ Depending on the camera mode and the type of batteries used, the transition from "" to "" may occur more quickly.

⚠ Due to the nature of the battery, the battery low warning may appear early when the camera is used in cold locations. This is normal. Try warming the batteries in your pocket or a similar location before use.

* Battery level warning

- 1) The camera's estimation of the remaining battery charge varies greatly depending on the camera operation mode. Consequently, even if "" or "" is not displayed in Playback mode, one of them may appear when you change to Photography mode.
- 2) Depending on the battery type and the level of charge in the batteries, the camera may run out of power without first displaying a battery level warning. This is particularly likely to happen when batteries that have run out of charge once are re-used. In situation 2), immediately load new or fully charged replacement batteries.

◆ Power save function ◆

When this function is active, it turns off the screen (sleep mode) to reduce power consumption if the camera is not used for 60 seconds (⇒P.82). If the camera is then left unused for 2 or 5 minutes, the Power save function turns the camera off. To turn the camera back on, set the Power switch to "OFF" briefly and then back to "" or "".

TURNING ON AND OFF / SETTING THE DATE AND TIME

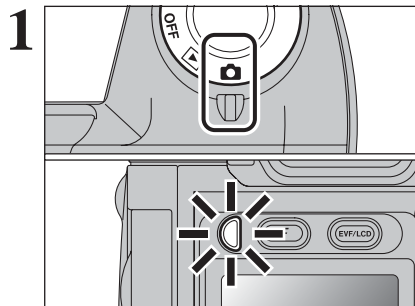

Turn the Power switch to turn the camera on and off. When turning the camera on, the indicator lamp lights green.

The lens moves when the camera is in "📷" Photography mode. Take care not to obstruct the lens. Obstructing the lens will cause damage and "ZOOM ERROR" or "FOCUS ERROR" will appear. Take care also not to get fingerprints on the camera lens as this will result in impaired image quality in your shots.

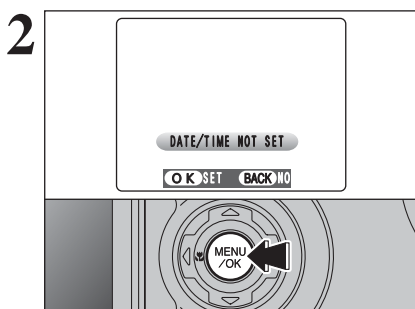

When using the camera for the first time after purchasing, the date and time are cleared. Press the "MENU/OK" button to set the date and time.

- ⚡ If the message (see figure at left) does not appear, refer to "Correcting the date and time" (P.15) and check and correct the date and time settings.
- ⚡ The message also appears when the camera batteries have been removed and the camera has been left for a long period.
- ⚡ To set the date and time later, press the "DISP/BACK" button.
- ⚡ If you do not set the date and time, this message will appear each time you turn the camera on.

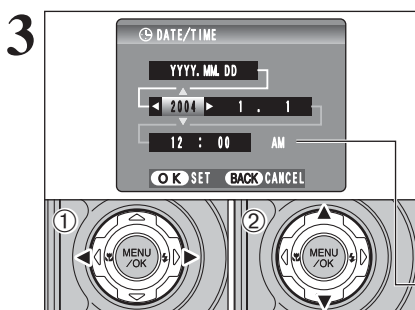

- 1 Press "◀" or "▶" to select Year, Month, Day, Hour or Minute.
- 2 Press "▲" or "▼" to correct the setting.

- ⚡ Holding down "▲" or "▼" changes the numbers continuously.
- ⚡ When the time displayed passes "12:00", the AM/PM setting changes.

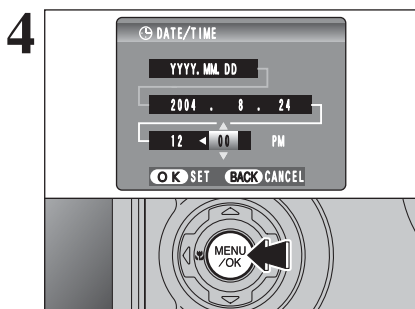

Once you have set the date and time, press the "MENU/OK" button. Pressing the "MENU/OK" button changes the camera to Photography or Playback mode.

- ⚡ At the time of purchase and after leaving the camera for a long period with the batteries removed, settings such as the date and time are cleared. Once the AC power adapter has been connected or the batteries have been installed for 2 hours or more, the camera settings will be retained for roughly 6 hours even if both sources of power are removed.

CORRECTING THE DATE AND TIME / CHANGING THE DATE ORDER

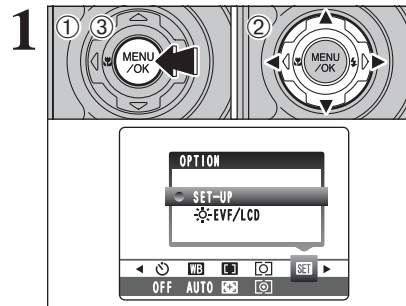

- 1 Press the "MENU/OK" button to display the menu on the screen.
- 2 Press "◀" or "▶" to select "SET" OPTION and then press "▲" or "▼" to select "SET-UP".
- 3 Press the "MENU/OK" button.

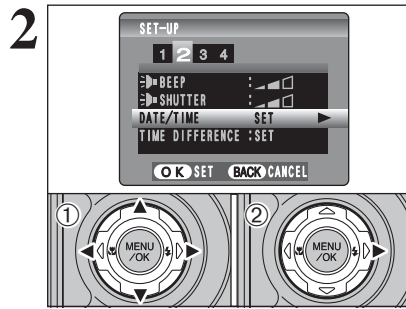

- 1 Press "◀" or "▶" to move to option 2 and then press "▲" or "▼" to select "DATE/TIME".
- 2 Press "▶".

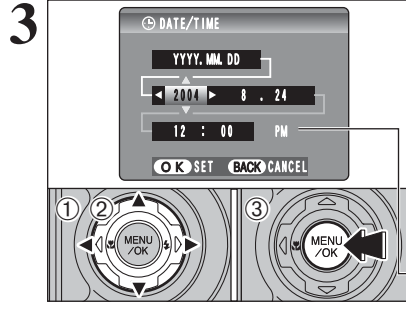

- ### Correcting the date and time
- 1 Press "◀" or "▶" to select Year, Month, Day, Hour or Minute.
 - 2 Press "▲" or "▼" to correct the setting.
 - 3 Always press the "MENU/OK" button after the settings are completed.

- ⚡ Holding down "▲" or "▼" changes the numbers continuously.
- ⚡ When the time displayed passes "12:00", the AM/PM setting changes.

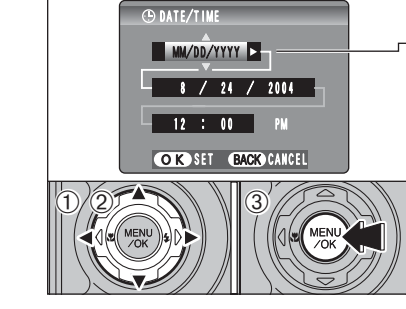

- ### Changing the date order
- 1 Press "◀" or "▶" to select the date order.
 - 2 Press "▲" or "▼" to set the order. Refer to the table below for details of the settings.
 - 3 Always press the "MENU/OK" button after the settings are completed.

Date order	Explanation
YYYY.MM.DD	Displays the date in the "year. month. day" format.
MM/DD/YYYY	Displays the date in the "month / day / year" format.
DD.MM.YYYY	Displays the date in the "day. month. year" format.

SELECTING THE LANGUAGE

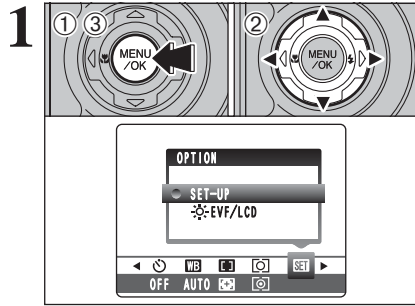

- ① Press the "MENU/OK" button to display the menu on the screen.
- ② Press "◀" or "▶" to select "OPTION" and then press "▲" or "▼" to select "SET-UP".
- ③ Press the "MENU/OK" button.

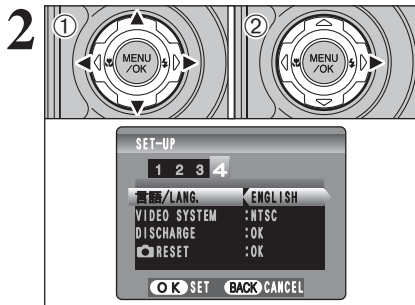

- ① The "SET-UP" screen appears. Press "◀" or "▶" to move to option 4 and then press "▲" or "▼" to select "言語/LANG.".
- ② Press "▶" to select "ENGLISH", "FRANCAIS", "DEUTSCH", "ESPAÑOL", "ITALIANO", "中文" or "日本語". Press "▶" to cycle through the language settings.

☛ The screens in this manual are shown in English.
 ☛ See P.81 for more information on the "OPTION" menu.

2 Using the Camera

BASIC OPERATION GUIDE

This section describes the camera's functions.

● Focus mode selector button

Unlock using the Focus mode selector lock switch. Press the Focus mode selector button to change the focus mode.

Focus mode

- ↓ S-AF : Single AF
- ↓ M F : Manual focus
- ↓ C-AF : Continuous AF

● Power switch

ON/OFF and "📷" Photography mode/ "▶" Playback mode selector switch

Use the Power switch to select the mode.

● Continuous shooting button

With the "📷" button held down, press "◀" or "▶" to select the Continuous shooting mode.

● Exposure compensation button

With the "☒" button held down, press the "◀" or "▶" button to select the exposure compensation.

● Photography mode selector

Turn the Mode dial to select the Photography mode.

AUTO Auto	P Programmed Auto
Portrait	S Shutter-priority Auto
Landscape	A Aperture-priority Auto
Sports	M Manual
Night scene	Movie

● Diopter adjustment dial

Makes the image in the viewfinder easier to see. Set the dial to the position where the AF frame appears sharpest.

● Flash pop-up button

To use the flash, press the Flash pop-up button to release the flash.

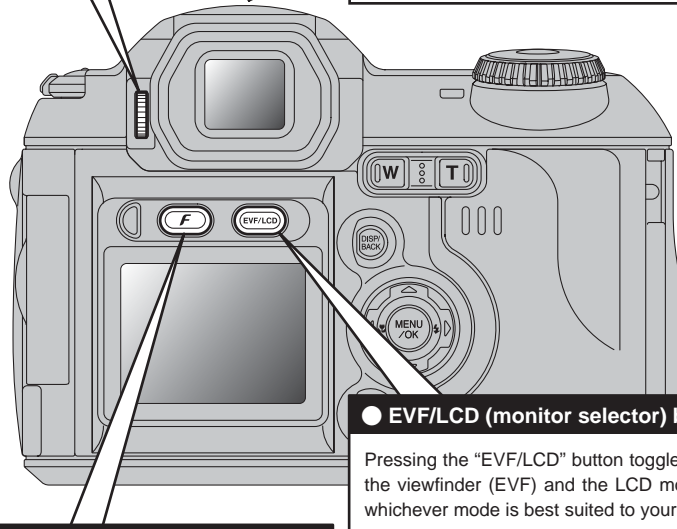
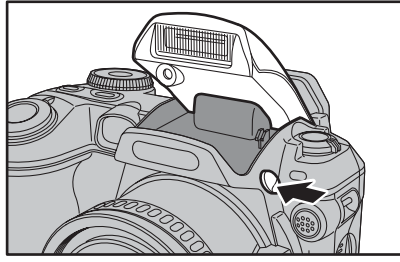

● EVF/LCD (monitor selector) button

Pressing the "EVF/LCD" button toggles between the viewfinder (EVF) and the LCD monitor. Use whichever mode is best suited to your shot.

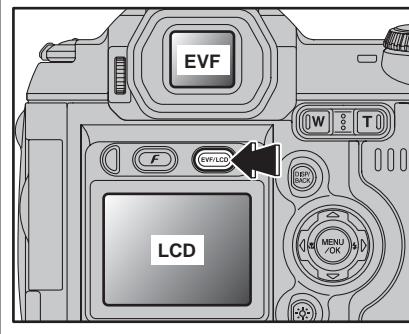

● Photo mode (F) button

Photography: Select the quality (number of recorded pixels), sensitivity and FinePix COLOR settings.
Playback: Specify the print order (DPOF) settings.

● Zoom button

Photography: Press "T" to zoom in (telephoto). Press "W" to zoom out (wide-angle).
Playback: Press "T" to enlarge the image. Press "W" to revert to normal display.

● DISP / BACK button

DISP: Press this button to select the screen display.
BACK: Press this button to stop a procedure midway through.

● Low light viewfinder button

The screen brightness is increased briefly.

● ◀▶ button

Photography: ◀ button Turns Macro (M) on and off. ▶ button Sets the flash (F).
Playback: Change frame or movie frame advance.

● Using the menus

① Display the menu. Press the "MENU/OK" button.



② Select a menu option. Press the left or right arrow on the 4-direction button.

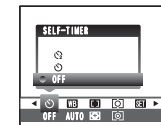

③ Select a setting. Press the up or down arrow on the 4-direction button.

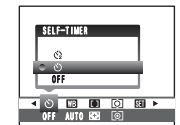

④ Confirm the setting. Press the "MENU/OK" button.



◆ Displaying the on-screen help ◆

Instructions for the next step in the procedure appear at the bottom of the screen. Press the button indicated. For example, to trim the image as shown in the figure at right, press the "MENU/OK" button.

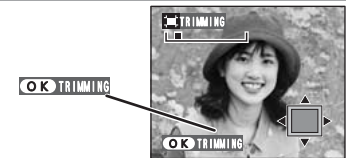

Up, down, left and right are indicated by black triangles in the Owner's Manual. Up or down is shown as "▲" or "▼", and left or right is shown as "◀" or "▶".

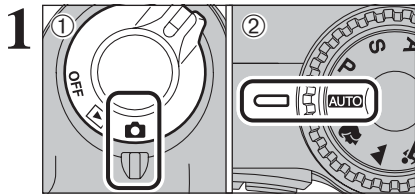

- ① Set the Power switch to "📷".
 - ② Set the Mode dial to "AUTO".
- **Focal range**
Wide-angle: approx. 90 cm (3.0 ft.) to infinity
Telephoto: approx. 2.0 m (6.6 ft.) to infinity
 - 🔧 Use Macro mode for subjects closer than 90 cm (3.0 ft.) (→P.39)
 - 🔧 When "CARD ERROR", "CARD NOT INITIALIZED", "CARD FULL" or "NO CARD" appears, see P.111.

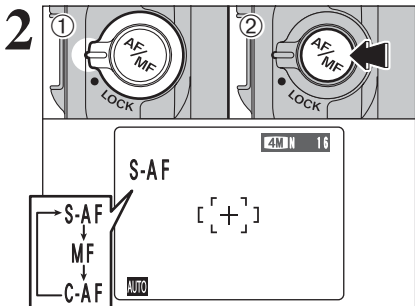

- ① Unlock the Focus mode selector lock switch.
- ② Press the Focus mode selector button to set the Focus mode to "S-AF".

🔧 See P.47-48 for information on the manual focus "MF" and the continuous AF "C-AF".

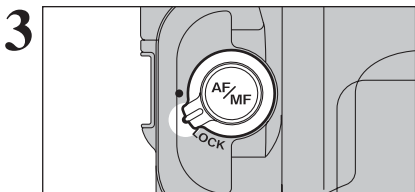

Lock the Focus mode selector lock switch to prevent the switch moves.

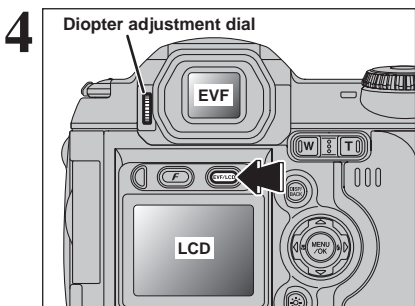

Press the "EVF/LCD" button to alternate the display between the viewfinder (EVF) and the LCD monitor. Press the "EVF/LCD" button to select the viewfinder (EVF). When the AF frame in the viewfinder is difficult to see, adjust the viewfinder using the Dioper adjustment dial.

The EVF/LCD selection is retained even when the camera is off or the Mode dial setting is changed.

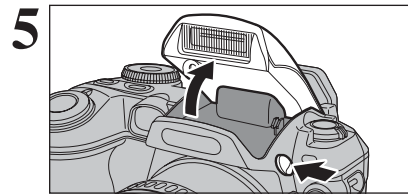

Press the Flash pop-up button to pop up the flash.

- 🔧 When the flash pops up, the image may disappear and go dark briefly due to flash charging. The indicator lamp blinks orange during charging.
- 🔧 If the flash is used in dusty conditions or when it is snowing, white dots may appear in the image. This is due to the flash reflecting off the dust particles or snowflakes. Use Suppressed flash mode to fix the problem.

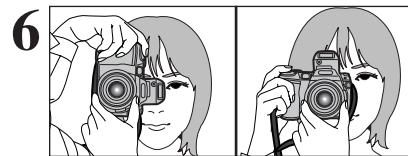

Brace your elbows against your sides and hold the camera with both hands. Position your right thumb so that it is handy for using the zoom.

- 🔧 Moving the camera while shooting gives a blurred picture (camera shake). Use a tripod to prevent camera shake, particularly for shots in the dark when the selected flash mode is Suppressed flash.
- 🔧 There may be some uneven brightness at the lower edge of the screen. This is normal and does not affect the image.

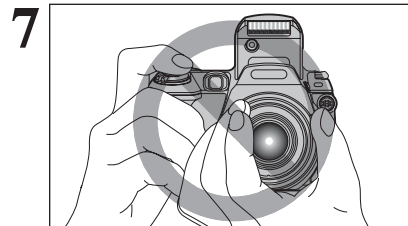

Hold the camera so that your fingers or the strap do not cover the lens, flash, AF-assist illuminator or flash control sensor. If the lens, flash, AF-assist illuminator or flash control sensor is obscured, the brightness (exposure) of your shot may be incorrect.

- 🔧 Check that the lens is clean. If it is dirty, clean the lens as informed on P.107.

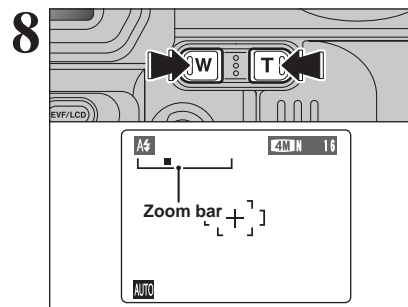

Press "T" (telephoto) button to zoom in. Press "W" (wide-angle) button to zoom out. A zoom bar appears on the screen.

- **Optical zoom focal length**
(35 mm camera equivalent)
Approx. 37 mm to 370 mm
Max. zoom scale: 10x

- 🔧 The zoom setting is retained even when the camera is turned off.

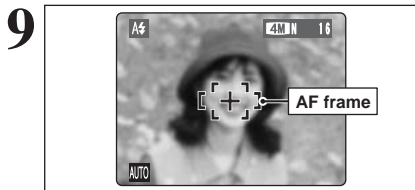

9 Frame the shot so that the subject fills the entire AF (Autofocus) frame.

When the subject is not in the AF frame, use AF/AE lock to take the picture (⇒P.25).

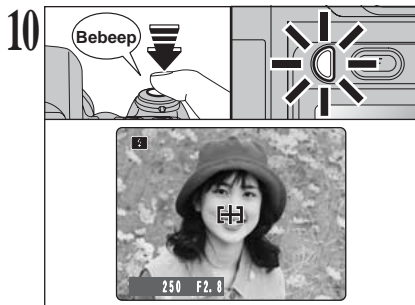

10 Press the shutter button down halfway. When a short double-beep is heard, the camera focuses on your subject. The AF frame on the screen becomes smaller and the camera sets the shutter speed and aperture. The indicator lamp (green) changes from blinking to lit.

- The image shown on the screen before the picture is taken may differ in brightness, color, etc. from the image actually recorded. Play back the recorded image to check it (⇒P.27).
- When a short double-beep is not heard and "1AF" appears on the screen, the camera cannot focus.
- Pressing the shutter button down halfway freezes the image on the screen briefly. This image is not the recorded image.
- If "1AF" appears on the screen (e.g. the shot is too dark for the camera to focus), try standing about 2 m (6.6 ft.) from the subject to take the picture.

Before the flash fires, "E" appears on the screen.

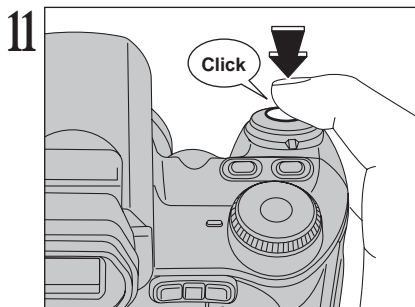

11 Press the shutter button down fully. When a clicking noise is heard, the camera records the image.

- There is a slight delay between the shutter button being pressed and the picture being taken. Playback the shot to check the image.
- When pressing the shutter button down fully in one motion, the picture is taken without the AF frame changing.
- When the camera takes the picture, the indicator lamp lights orange (shooting disabled). The indicator lamp then turns green and the next picture can be taken.
- The indicator lamp blinks orange while the flash is charging. The screen may go dark briefly. This is normal.
- See P.111-112 for information on the warning displays.

◆ **Subjects not suitable for autofocus** ◆

The FinePix S5100/FinePix S5500 uses a high-precision autofocus mechanism. However, it may have difficulty focusing on the following:

- Very shiny subjects such as a mirror or car body
- Subjects photographed through glass
- Subjects that do not reflect well, such as hair or fur
- Subjects with no substance, such as smoke or flames
- Dark subjects
- Fast moving subjects
- Subjects with little or no contrast between the subject and the background (such as white walls or subjects dressed in the same color as the background)
- Shots where another high-contrast object (not the subject) is close to the AF frame and is either closer or further away than your subject (such as a shot of someone against a background with strongly contrasting elements)

For such subjects use AF/AE lock (⇒P.25).

USING LCD MONITOR

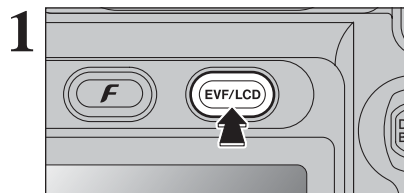

1 When using the LCD monitor to take pictures, press the "EVF/LCD" button to select the LCD monitor.

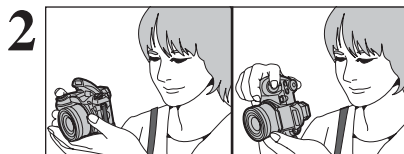

2 Brace your elbows against your sides and hold the camera with both hands. Position your right thumb so that it is handy for using the zoom.

- Moving the camera while shooting gives a blurred picture (camera shake). Use a tripod to prevent camera shake, particularly for shots in the dark when the selected flash mode is Suppressed flash.
- There may be some uneven brightness at the lower edge of the screen. This is normal and does not affect the image.



3 Frame the shot so that the subject fills the entire AF (Autofocus) frame.

- The image shown on the LCD monitor before the picture is taken may differ in brightness, color, etc. from the image actually recorded. Playback the recorded image to check it (⇒P.27).

■ **Indicator lamp display**

Display	Status
Lit green	Ready to shoot
Blinking green	AF/AE in progress, camera shake warning or AF warning (ready to shoot)
Blinking green and orange alternately	Recording to xD-Picture Card (ready to shoot)
Lit orange	Recording to xD-Picture Card (not ready)
Blinking orange	Charging the flash (flash will not fire)
Blinking green (1-second intervals)	Camera in Power save mode (⇒P.82)
Blinking red	<ul style="list-style-type: none"> xD-Picture Card Warnings No card loaded, card not formatted, incorrect format, card full or xD-Picture Card error Lens operation error

* Detailed warning messages appear on the screen (⇒P.111-112).

AF-ASSIST ILLUMINATOR

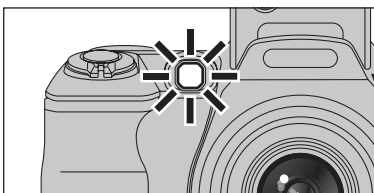

Press the shutter button down halfway in dimly lit conditions. The camera fires the AF-assist Illuminator (green) to allow easier focusing at shooting distances up to roughly 2 m depending on subject.

However, the AF-assist Illuminator is not effective when the zoom is set to telephoto (high magnification: 6x or more). Wherever possible, use a wide-angle zoom setting (low magnification) to take pictures.

When "AF" appears on the screen even with the AF-assist Illuminator used, the camera cannot focus. Try standing about 2 m (6.6 ft.) from the subject to take the picture.

NUMBER OF AVAILABLE FRAMES

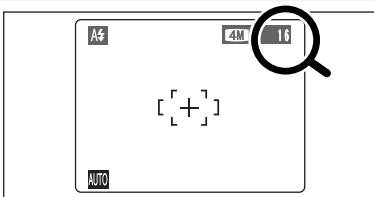

The number of available frames appears on the screen.

See P.50 for information on changing the quality setting.
The default quality "4M" set at shipment is "4M N".

Standard number of frames per xD-Picture Card

The table below shows the standard number of frames for a new xD-Picture Card formatted on the camera. The larger the xD-Picture Card capacity, the bigger the difference between the actual number of frames and the number shown here. Also, the size of an image file varies depending on the subject. So the number of remaining shots may decrease by 2 or may remain the same. For this reason, the number displayed may not show the actual number of frames.

Quality setting	4M F	4M N	2M	1M	0.3M	RAW
Number of recorded pixels	2272 × 1704	2272 × 1704	1600 × 1200	1280 × 960	640 × 480	2272 × 1704
DPC-16 (16 MB)	8	16	25	33	122	1
DPC-32 (32 MB)	16	32	50	68	247	3
DPC-64 (64 MB)	33	66	101	137	497	7
DPC-128 (128 MB)	66	132	204	275	997	15
DPC-256 (256 MB)	134	266	409	550	1997	30
DPC-512 (512 MB)	268	532	818	1101	3993	61

USING AF/AE LOCK

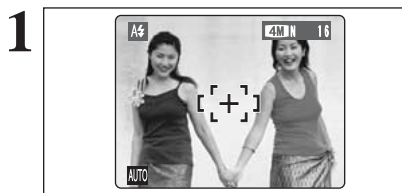

In this shot, the subjects (two people in this case) are not in the AF frame. Taking the picture at this point will result in the subjects being out of focus.

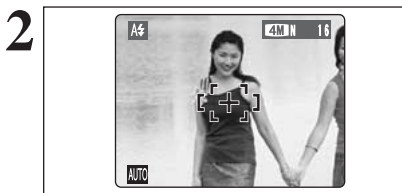

Move the camera slightly so that one of the subjects is in the AF frame.

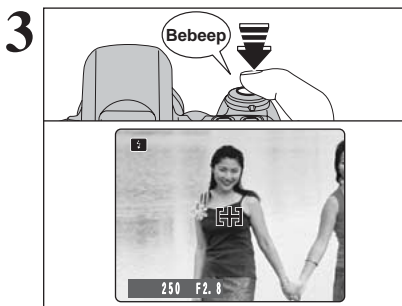

Press the shutter button down halfway (AF/AE lock). When a short double-beep is heard, the camera focuses on your subject. The AF frame on the screen becomes smaller and the camera sets the shutter speed and aperture. The indicator lamp (green) changes from blinking to lit.

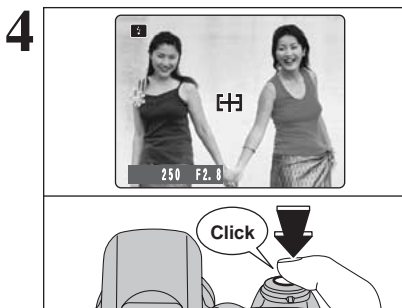

Continue to hold the shutter button down halfway. Move the camera back to the original image and press the shutter button fully.

AF/AE lock can be applied repeatedly before the shutter is released.
Use AF/AE lock in all Photography modes to guarantee excellent results.

◆ AF (Autofocus)/AE (Auto-exposure) lock ◆

On the FinePix S5100/FinePix S5500, pressing the shutter button down halfway locks the focus and exposure settings (AF/AE lock). To focus on a subject that is off to one side or to set the exposure before composing the final shot, lock the AF and AE settings. Then compose and take the picture to get the best results.

USING THE ZOOM (OPTICAL ZOOM / DIGITAL ZOOM)

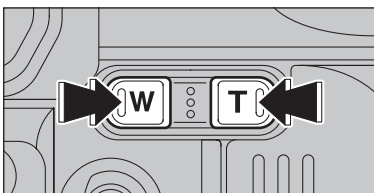

Press the Zoom buttons to zoom in and out. The digital zoom can be used with the "2M", "1M" and "0.3M" quality settings.

When zooming changes between optical and digital, the position of the "■" indicator stops. Press the same Zoom button again to start the "■" indicator moving again.

- The digital zoom cannot be used with the "4M" quality setting.
- See P.50 for information on changing the quality setting.
- If the shot goes out of focus during zooming, hold the shutter button down halfway to refocus the shot.

Zoom bar display

The position of the "■" indicator on the zoom bar shows the zooming status. The area to the right of the separator indicates digital zooming, while the area to the left indicates optical zooming.

- **Optical zoom focal length***
Approx. 37 mm-370 mm, max. zoom scale: 10×
 - **Digital zoom focal lengths***
 - 2M: approx. 370 mm-525 mm, max. zoom scale: approx. 1.4×
 - 1M: approx. 370 mm-659 mm, max. zoom scale: approx. 1.8×
 - 0.3M: approx. 370 mm-1314 mm, max. zoom scale: approx. 3.6×
- * 35 mm camera equivalents

BEST FRAMING

Select the framing guideline in the Photography mode. Pressing the "DISP/BACK" button changes the screen display. Press the "DISP/BACK" button until "Framing Guideline" appears.

Important

Always use AF/AE lock when composing a shot. The image may be out of focus if AF/AE lock is not used.

Scene

Position the main subject at the intersection of two lines in this frame or align one of the horizontal lines with the horizon. Use this frame as a guide to the subject's size and the balance of the shot while composing a shot.

- The framing guideline is not recorded on the image.
- The lines in the scene frame divide the image into 3 roughly equal parts horizontally and vertically. The resulting printed image may be shifted slightly from the scene frame.

Single-frame playback

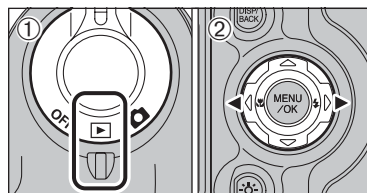

- ① Set the Power switch to "▶".
- ② Press "▶" to scan forward through the images. Press "◀" to scan backwards.

- Set the Power switch to "□" to playback the last shot.
- When the lens is extended during playback, the lens retracts as a protective measure if the camera is not used for 6 seconds.

Selecting images

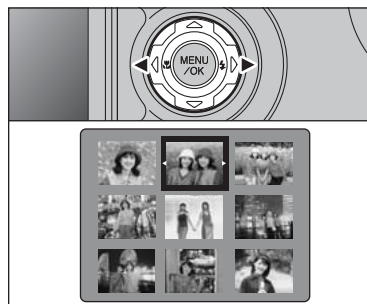

To select images on the thumbnail lists screen, hold down "◀" or "▶" for 1 second during playback.

Multi-frame playback

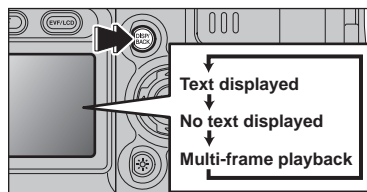

In Playback mode, press the "DISP/BACK" button to change the display shown on the screen. Press the "DISP/BACK" button until the multi-frame playback screen (9 frames) appears.

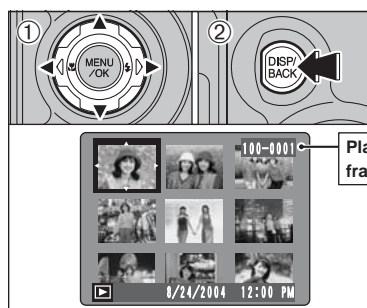

- ① Press "▲", "▼", "◀" or "▶" to move the cursor (orange frame) to the frame you want to select. Press "▲" or "▼" repeatedly to jump to the next page.
- ② Press the "DISP/BACK" button again to enlarge the image.

● The screen text display disappears after 3 seconds.

Still images viewable on the FinePix S5100/FinePix S5500

This camera will display still images recorded on the FinePix S5100/FinePix S5500 or still images (excluding some uncompressed images) recorded on any FUJIFILM digital camera that supports xD-Picture Cards. Clear playback or playback zooming may not be possible for still images shot on cameras other than the FinePix S5100/FinePix S5500.

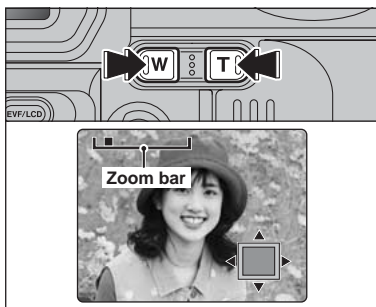

Playback zoom

Press the Zoom button during single-frame playback to zoom (enlarge) the still image. A zoom bar appears.

- ☛ Press the "DISP/BACK" button to cancel playback zoom.
- ☛ Playback zoom cannot be used with multi-frame playback.

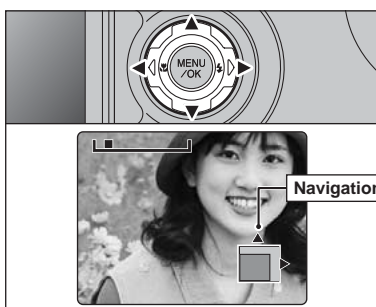

Press "▲", "▼", "◀" or "▶" to display another part of the image. The current displayed image appears on the navigation screen.

- ☛ Press the "DISP/BACK" button to cancel playback zoom.

■ **Zoom scales**

Quality mode	Max. zoom scale
4M (2272 × 1704 pixels)	Approx. 14.2x
2M (1600 × 1200 pixels)	Approx. 10.0x
1M (1280 × 960 pixels)	Approx. 8.0x
0.8M (640 × 480 pixels)	Approx. 4.0x

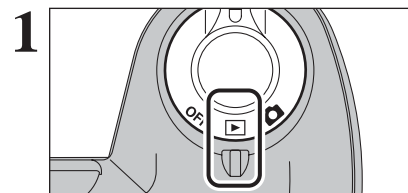

1 Set the Power switch to "OFF".

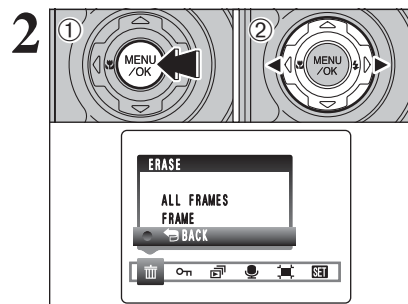

- ① Press the "MENU/OK" button during playback to display the menu on the screen.
- ② Press "◀" or "▶" to select "ERASE".

Erased frames (files) cannot be recovered. Back up important frames (files) onto your PC or another media.

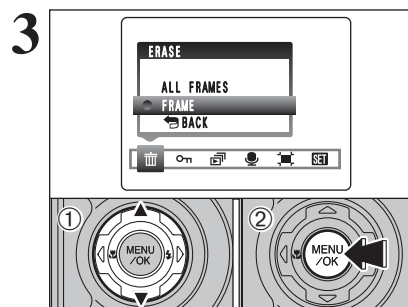

- ① Press "▲" or "▼" to select "FRAME".
- ② Press the "MENU/OK" button to confirm the selection. See P.61 for information on "ALL FRAMES".

- ☛ To return to single-frame playback, press "▲" or "▼" to select "BACK" and then press the "MENU/OK" button.

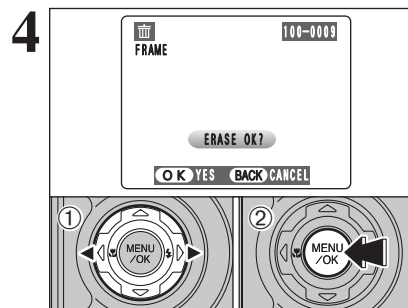

- ① Press "◀" or "▶" to select the frame (file) to be erased.
- ② Press the "MENU/OK" button to erase the displayed frame (file). To erase another image, repeat steps ① and ②. Press the "DISP/BACK" button to cancel single frame erasing.

- ☛ Press the "MENU/OK" button repeatedly to erase consecutive image. Take care not to erase important images.

The distance from the subject to the camera is referred to as the shooting distance. When the shooting distance is set correctly and the image appears sharp, the image is focused.

■ **Three focusing methods**

There are mechanisms for focusing: (1) Single AF (S-AF); (2) Continuous AF (C-AF); and (3) Manual focus (MF).

S-AF : In this mode, the camera focuses each time the shutter button is pressed down halfway.

Select the AF mode when the Mode dial is set to "P", "S", "A" or "M" mode.

C-AF : When this mode is set, the camera focuses continuously on the subject in the center of the screen. Use this mode to photograph moving subjects. See P.47 for details.

MF : With the "☒" button held down, press the "T" or "W" button to focus the shot. See P.48 for details.

■ **Causes of focusing errors and the solutions**

Cause	Solution
The subject is not suited to AF.	Use AF lock (AF mode: AF (CENTER))*1 or MF.
The subject is outside the shooting range.	Turn Macro mode on or off.*2
The subject is moving too quickly.	Use MF (pre-setting the shooting distance for a shot).

*1 Taking pictures using AF lock

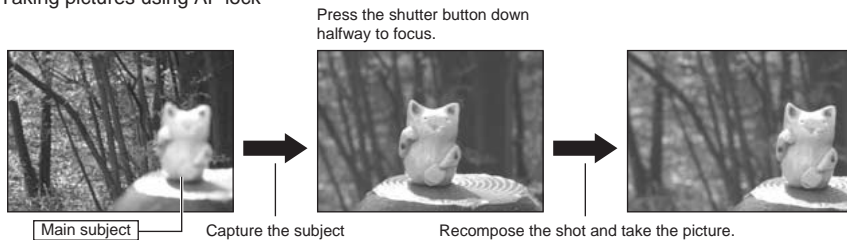

*2 Turning Macro mode ON/OFF

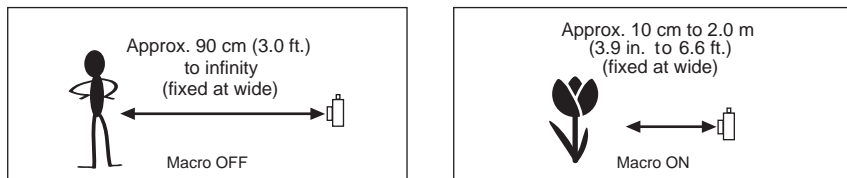

◆ **Subjects not suitable for autofocus** ◆

- Very shiny subjects such as a mirror or car body
- Subjects photographed through glass
- Subjects that do not reflect well, such as hair or fur
- Subjects with no substance, such as smoke or flames
- Dark subjects
- Fast moving subjects
- Subjects with little or no contrast between the subject and the background (such as white walls or subjects dressed in the same color as the background)
- Shots where another high-contrast object (not the subject) is close to the AF frame and is either closer or further away than your subject (such as a shot of someone against a background with strongly contrasting elements)

Exposure refers to the light that hits the CCD or the total amount of captured light and determines the brightness of the image.

The exposure is determined by the combination of aperture and shutter speed. In AE (Auto-exposure), the camera determines the correct exposure, allowing for factors such as the brightness of the subject and the sensitivity setting.

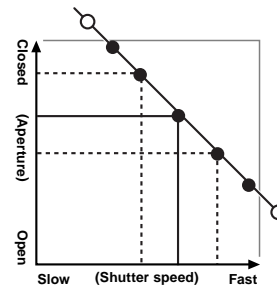

The graph at left shows the way the aperture and shutter speed settings can be changed while maintaining the same exposure level.

- When the aperture is decreased by one step, the shutter speed also decreases by one step (the dot moves upper left).
- When the aperture is increased by one step, the shutter speed also increases by one step (the dot moves lower right).
- Combinations that result in the shutter speed or aperture being outside the available range of settings cannot be selected (white dots).
- In the "P", "S" and "A" Photography modes, it is easy to select different settings along this line.
- Selecting settings that run parallel to this line by adjusting the brightness of the photographed image is referred to as exposure compensation.

◆ **When you cannot get the correct exposure** ◆

Exposure compensation:

This function uses the exposure level set by the AE function as a reference (0) and then brightens (+) or darkens (-) the image. By selecting Auto bracketing, you can shoot 3 frames, one underexposed (-), one at the reference exposure (0) and one overexposed (+).

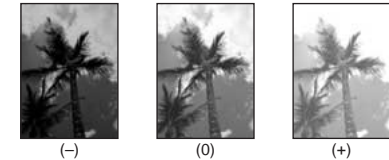

Shutter speed

When shooting a moving subject, you can either "freeze the motion" or "capture the sense of movement" by adjusting the shutter speed.

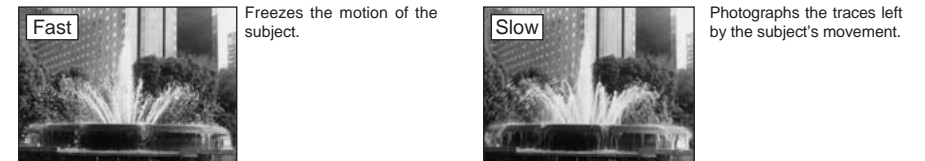

Aperture

By adjusting the aperture, you can change the depth of focus (depth of field).

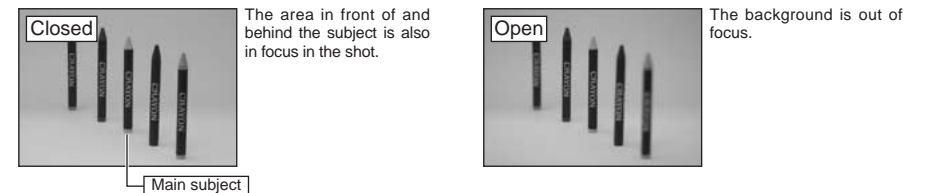

TAKING PICTURES — SELECTING THE CAMERA SETTINGS

Consider the scene you are photographing and the sort of image you want to achieve when you specify the camera settings. A general guide is given below.

1 Select the Photography mode (⇒P.34-38, 75-76).

- AUTO** Specifies all settings other than the Quality, Sensitivity and FinePix COLOR on the camera.
- Selects the best Scene position setting for the scene being shot. Changes the aperture or shutter speed setting so that the action is frozen, the flow of the motion is conveyed, or the background is out of focus.
- M** Adjust all the camera settings yourself. Record a movie.

2 Specify the photography settings (⇒P.39-49).

- Macro Uses for close-up shots.
- Flash Uses for shots in dark locations or for backlit subjects, etc.
- Continuous shooting Uses to take a series of continuous shots or to use auto bracketing (with exposure compensation).
- Exposure compensation Use the AE (Auto-exposure) as a reference value of 0. This function brightens (+) or darkens (-) the shot.

3 Take the pictures (check the exposure and focus ⇒ adjust the shot composition ⇒ press the shutter button down fully).

★ You can use the menus for more detailed settings (⇒P.50-59, 77).

The table below provides a number of sample settings. Use the settings effectively.

To achieve this result	Sample settings
To express the motion of the subject	Set the Mode dial to "S" and select a slow shutter speed. (Use a tripod to prevent camera shake.)
To freeze the subject's movement	Set the Mode dial to "S" and select a fast shutter speed.
To make the subject stand out by having the background out of focus	Set the Mode dial to "A" and select a wide aperture setting.
To get a very large depth of focus	Set the Mode dial to "A" and select a narrow aperture setting.
To prevent the image from having a red or blue cast due to the light source	Change the "White balance" setting in the photography menu.
To prevent missing snapshot opportunities	Take pictures in AUTO mode (see "Using the Camera").
To prevent the subject from being overexposed or underexposed and to show the substance and textures of the subject clearly.	Use exposure compensation. Select (+) if the background is pale and (-) if the background is dark.

List of functions available in each mode

Function	Photography mode	Mode										
		AUTO	PORTRAIT	LANDSCAPE	SPORTS	NIGHT SCENE	P	S	A	M	Video	
Macro	P.39	YES	NO	NO	NO	NO	YES	YES	YES	YES	NO	
Flash	Auto flash	P.41	YES	YES	NO	YES	NO	NO	NO	NO	NO	
	Red-eye reduction	P.41	YES	YES	NO	NO	NO	YES	YES	YES	NO	
	Forced flash	P.42	YES	YES	NO	YES	NO	YES	YES	YES	NO	
	Slow synchro	P.42	NO	YES	NO	NO	YES	YES	NO	YES	NO	
	Red-eye reduction + Slow synchro	P.42	NO	YES	NO	NO	YES	YES	NO	YES	NO	
Continuous shooting	Top 3-frame	P.44	YES	YES			YES	YES	YES	YES	NO	
	Auto bracketing	P.44	NO	NO			YES	YES	YES	YES	NO	
	Final 3-frame	P.44	YES	YES			YES	YES	YES	YES	NO	
	Long-period (up to 40 frames)	P.45	YES	NO			NO	NO	NO	NO	NO	
Focus mode (S-AF/MF/C-AF)		P.30	YES	YES			YES	YES	YES	YES	NO	
<input checked="" type="checkbox"/> Exposure compensation		P.46	NO	NO			YES	YES	YES	NO	NO	
Increasing monitor brightness		P.49	YES								NO	

* The flash cannot be used for continuous shooting.

List of menu options available in each mode

Menu options	Function	P	Factory Defaults	Mode										
				AUTO	Scene mode icons	P	S	A	M	Video				
FinePix photo mode	Quality	P.50, P.77	N	YES	YES			YES	YES	YES	YES	YES		
	ISO	P.51	AUTO*1	YES	YES			YES	YES	YES	NO			
	FinePix COLOR	P.52	F-STANDARD	YES	YES			YES	YES	YES	NO			
	Self-timer	P.54	OFF	YES	YES			YES	YES	YES	NO			
Menu options	White balance	P.55	AUTO	NO	NO			YES	YES	YES	NO			
	AF mode	CENTER	P.57	CENTER	NO	NO			YES	YES	YES	NO		
		MULTI	P.57		NO	NO			YES	YES	YES	NO		
		AREA	P.58		NO	NO			YES	YES	YES	NO		
	[O] Photo metry	[O] MULTI	P.58	MULTI	NO	NO			YES	YES	YES	NO		
		[•] SPOT	P.58		NO	NO			YES	YES	YES	NO		
		[] AVERAGE	P.58		NO	NO			YES	YES	YES	NO		
	Bracketing	P.59	±1/3EV	NO	NO			YES	YES	YES	NO			
Sharpness	P.59	NORMAL	NO	NO			YES	YES	YES	NO				
Flash (brightness adjustment)	P.59	±0	NO	NO			YES	YES	YES	NO				

*1 AUTO can only be set in "AUTO" mode.
* AREA and continuous AF(C-AF) cannot be used together.

When shutter speed and aperture adjustments alone do not give the correct exposure:

When the image is too bright
Lower the "ISO" sensitivity setting.

When the image is too dark
Raise the "ISO" sensitivity setting.
Use flash or the brightness adjustment function.

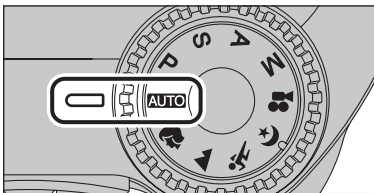
AUTO AUTO

Set the Mode dial to “**AUTO**”.
This is the easiest mode to use and can be used for most types of shots.

See P.33 for information on available flashes.

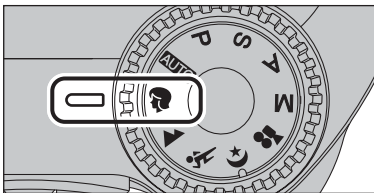
 **PORTRAIT**

Set the Mode dial to “”.
This is the most suitable for shooting portraits. Skin tones are shown beautifully and the overall tone is soft.

The camera selects the “100” sensitivity setting. Choose the sensitivity setting that best suits the conditions.
See P.33 for information on available flashes.

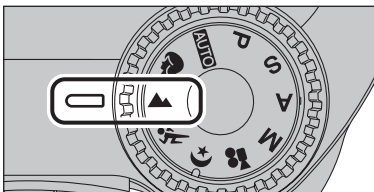
 **LANDSCAPE**

Set the Mode dial to “”.
This mode is the best for shooting scenery in daylight and provides crisp, clear shots of scenery such as buildings and mountains.

The camera selects the “100” sensitivity setting. Choose the sensitivity setting that best suits the conditions.
Flash not available. When the flash is popped up, “” appears.

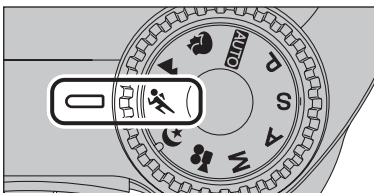
 **SPORTS**

Set the Mode dial to “”.
This is the most suitable for shooting sporting events. The priority to faster shutter speeds is given.

The camera selects the “100” sensitivity setting. Choose the sensitivity setting that best suits the conditions.
See P.33 for information on available flashes.

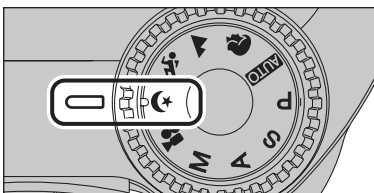
 **NIGHT SCENE**

Set the Mode dial to “”.
This mode is the best for shooting evening and night scenes. The priority to slow shutter speeds (up to 3 seconds) is given. To prevent camera shake, always use a tripod.

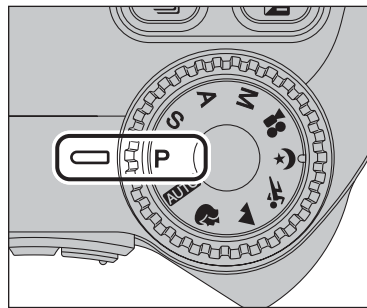

The camera selects the “100” sensitivity setting. Choose the sensitivity setting that best suits the conditions.
See P.33 for information on available flashes.

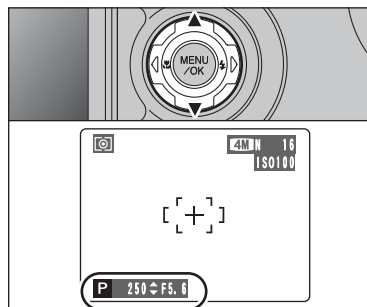

Set the Mode dial to “**P**”.

This is an automatic mode to specify the settings except for the shutter speed and aperture setting. This is a simple way to take pictures the same as the Shutter-priority Auto and Aperture-priority Auto modes (Program shift).

**Program shift**

Press “” or “” to select different shutter speed and aperture setting combinations without changing the exposure setting. The shutter speed and aperture setting appear in yellow when the camera is in Program shift mode.

Any of the following cancels Program shift:

- Changing the Mode dial setting
- Popping the flash up
- Setting the camera to Playback mode
- Turning the camera off

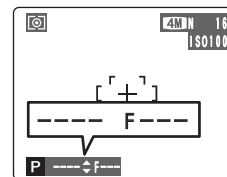
◆ **The shutter speed and aperture setting display** ◆

When the brightness of the subject is outside the camera's brightness metering range, “---” appears as the shutter speed and aperture setting on the screen.

S SHUTTER-PRIORITY AUTO

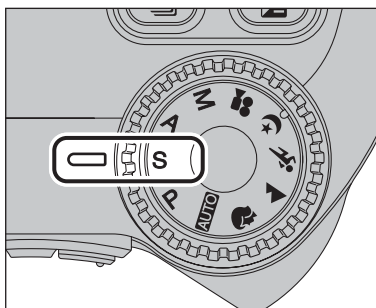

Set the Mode dial to "S".
This is an automatic mode to set the shutter speed. Use this mode to freeze a moving subject (fast shutter speed) or convey the impression of movement (slow shutter speed).

Setting the shutter speed

Press "▲" or "▼" to select the shutter speed.

● Shutter speed setting

3 sec. to 1/1000 sec. in 1/3 EV increments

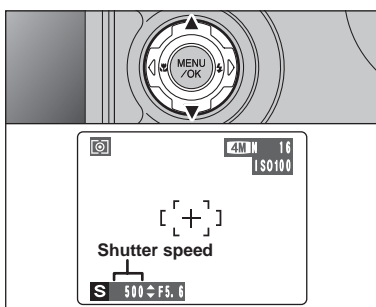

● The displayed aperture settings on the screen may differ from the value described in specification.

A APERTURE-PRIORITY AUTO

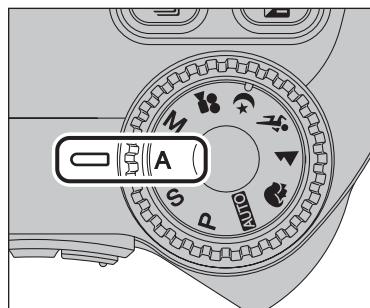

Set the Mode dial to "A".
This is an automatic mode to set the aperture. Use this mode to have the background out of focus (large aperture) or have both near and far objects in focus (small aperture).

Setting the aperture

Press "▲" or "▼" to select the aperture.

● Aperture settings

Wide-angle: F2.8 to F8 in 1/3 EV increments
Telephoto: F3.1 to F9 in 1/3 EV increments

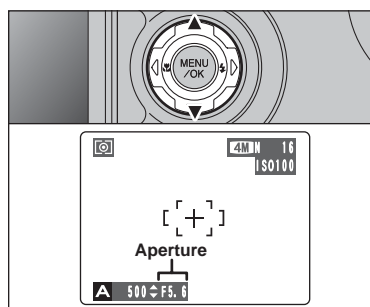

● The displayed aperture settings on the screen may differ from the value described in specification.

◆ The shutter speed and aperture setting display ◆

Overexposed

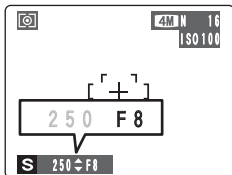

In scenes that are extremely overexposed, the aperture setting (F8) appears in red. When this occurs, select a faster shutter speed (up to 1/1000 sec.).

Underexposed

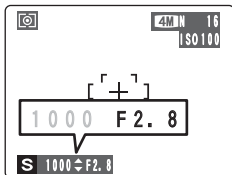

In scenes that are extremely underexposed, the aperture setting (F2.8) appears in red. When this occurs, select a slower shutter speed (down to 3 sec.).

Metering failed

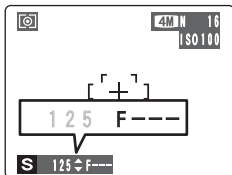

When the brightness of the subject is outside the camera's brightness metering range, "F---" appears as the aperture setting. When this occurs, press the shutter button down halfway to measure the light level again and display a value.

◆ The shutter speed and aperture setting display ◆

Overexposed

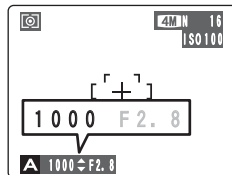

In scenes that are extremely overexposed, the shutter speed setting appears in red. When this occurs, select a larger number of aperture.

Underexposed

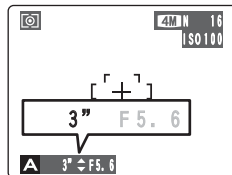

In scenes that are extremely underexposed, the shutter speed setting appears in red. When this occurs, select a smaller number of aperture.

Metering failed

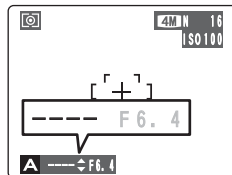

● When Forced flash mode is selected, the slowest available shutter speed is 1/60 sec.

When the brightness of the subject is outside the camera's brightness metering range, "----" appears as the shutter speed setting. When this occurs, press the shutter button down halfway to measure the light level again and display a value.

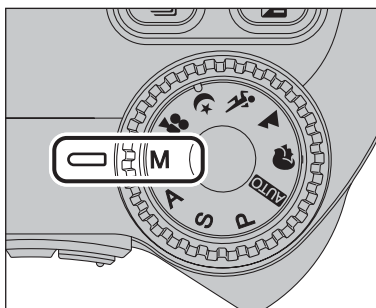

Set the Mode dial to "M".
Use Manual mode to set any shutter speed and aperture setting.

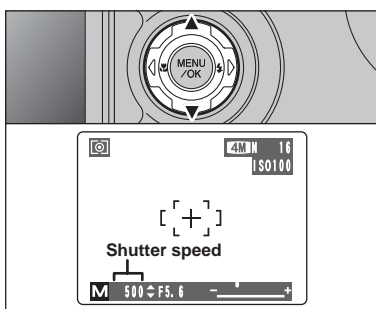

Setting the shutter speed

Press "▲" or "▼" to select the shutter speed.

- **Shutter speed setting**
15 sec. to 1/2000 sec. in 1/3 EV increments

- 🔧 See P.117 for information on EVs.
- 🔧 Use a tripod to prevent camera shake.
- 🔧 In shots with long exposures, noise (dots) may appear on the image.
- 🔧 When taking pictures with a fast shutter speed (1/2000 sec.), smearing (white stripes) may appear in the image (➡P.117).
- 🔧 If the shutter speed is set to a speed faster than 1/1000 sec., the image may appear dark even if the flash is used.

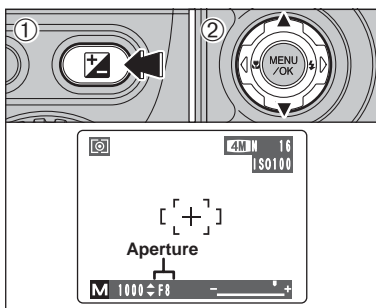

Setting the aperture

- 1 Hold down the "Fn" button.
- 2 Press "▲" or "▼" to select the aperture.

- **Aperture settings**
Wide-angle: F2.8 to F8 in 1/3 EV increments
Telephoto: F3.1 to F9 in 1/3 EV increments

- 🔧 The displayed aperture settings on the screen may differ from the value described in specification.

◆ The exposure indicator ◆

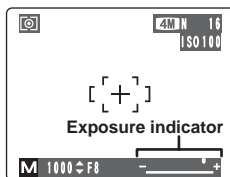

Use the exposure indicator on the screen as a guide when setting the exposure.
When the brightness of the subject is outside the camera's brightness metering range, the indicator moves to the (+) end to show that the image will be overexposed (the (+) turns yellow) or to the (-) end to show that the image will be underexposed (the (-) turns yellow).

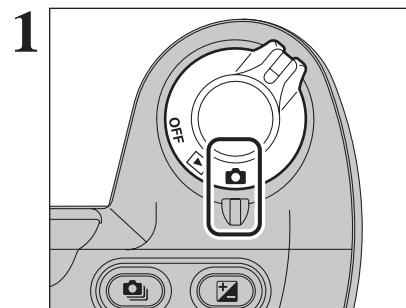
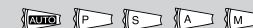

1 Select Macro mode to take close-up shots.
Set the Power switch to "📷".

- **Focal range**
Wide-angle: approx. 10 cm to 2.0 m
(3.9 in. to 6.6 ft.)
Telephoto: approx. 90 cm to 2.0 m
(3.0 ft. to 6.6 ft.)

- **Effective flash range**
Approx. 30 cm to 2.0 m (1.0 ft. to 6.6 ft.)

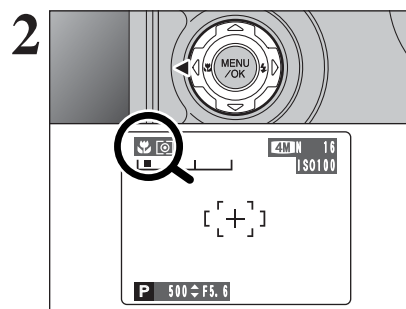

2 Press the "📷 (◀)" Macro button. The "📷" appears on the screen indicating that you can take close-up shots.
To cancel Macro mode, press the "📷 (◀)" Macro button again.

- 🔧 Any of the following cancels Macro mode:
 - Changing the Mode dial to "📷", "📷", "▲", "📷" or "📷" mode
 - Turning the camera off
 - 🔧 If the flash is too bright, use flash brightness adjustment (➡P.59).
 - 🔧 Use a tripod to prevent camera shake when shooting in the dark (when "📷" appears).

◆ When using the flash ◆

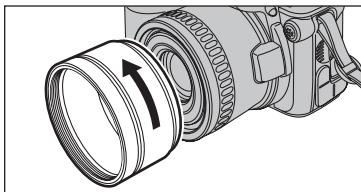

When using the flash in Macro mode, remove the lens adapter ring.
If the adapter ring is not removed, a shadow may appear in the bottom center of your shot.



Choose from 5 flash modes according to the type of shot.

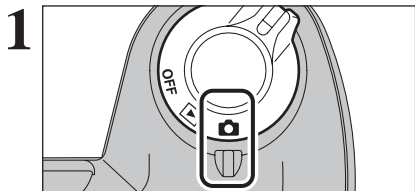

1 Set the Power switch to "CAMERA".

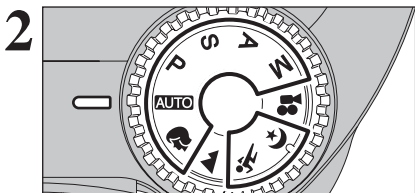

2 Set the Mode dial to "AUTO", "P", "S", "A" or "M" mode.

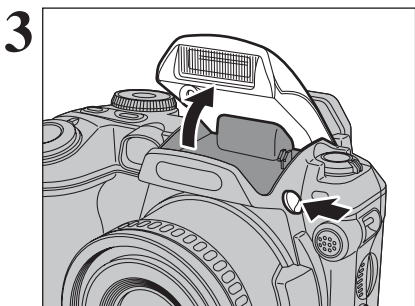

3 Press the Flash pop-up button to pop-up the flash.

● **Effective flash range (AUTO)**

Wide-angle: approx. 30 cm to 5.0 m
(1.0 ft. to 13.8 ft.)

Telephoto: approx. 80 cm to 4.5 m
(2.6 ft. to 12.5 ft.)

- If the shutter speed is set to a speed faster than 1/1000 sec., the image may appear dark even if the flash is used.
- When the flash pops up, the image may disappear and go dark briefly due to flash charging. The indicator lamp blinks orange during charging.

◆ **Suppressed flash** ◆

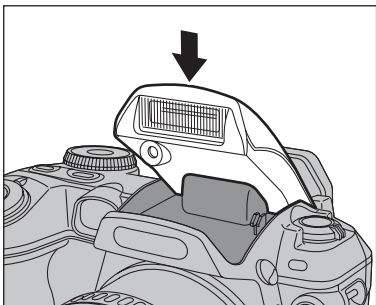

Pressing the flash down changes the camera to Suppressed flash mode.

Use this mode for taking pictures using indoor lighting, for shots taken through glass, and for photography in places such as theaters or at indoor sporting events where the distance is too great for the flash to be effective. When you use Suppressed flash, the selected white balance function (→P.55) operates so that natural colors are captured along with the ambience of the available light.

- Use a tripod to prevent camera shake, particularly for shots in the dark when the selected flash mode is Suppressed flash.
- See P.23, 111 for information on the camera shake warning.

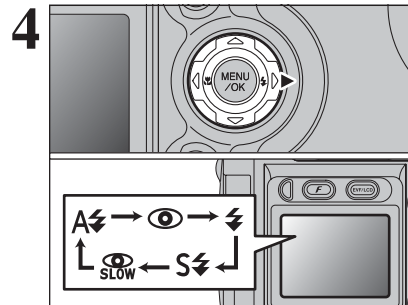

4 The flash setting changes each time you press the "MENU/OK" Flash button.

- If the flash is used in dusty conditions or when it is snowing, white dots may appear in the image due to flash reflecting off the dust particles or snowflakes. Use Suppressed flash mode.
- When taking a picture using the flash, the image may disappear and go dark briefly due to flash charging. The indicator lamp blinks orange during charging.
- The available flash modes are limited depending on the Photography menu selected (→P.33).

Press the shutter button down halfway. "FLASH" appears on the screen when the flash is used.



◆ **Auto flash** ◆

Use this mode for ordinary photography. The flash fires as required by the shooting conditions.

- If pressing the shutter button while the flash is charging, the picture will be taken without the flash.



◆ **Red-eye reduction** ◆

Use this mode to make sure that the subject's eyes appear normal when taking pictures of people in low-light conditions. The flash fires a pre-flash just before the picture is taken and then fires again to take the actual picture. The flash fires as required by the shooting conditions.

- If pressing the shutter button while the flash is charging, the picture will be taken without the flash.

◆ **Red-eye effect** ◆

When using the flash to take a picture of people in low-light conditions, their eyes sometimes appear red in the picture. This is caused by the light of the flash reflecting off the inside of the eye. Use Red-eye reduction flash to minimize the likelihood of this effect.

Take the following measures to make Red-eye reduction more effective:

- Get the subjects to look at the camera.
- Get as close as possible to the subjects.



⚡ Forced flash

Use this mode in backlit scenes, such as a subject against a window or in the shade of a tree, or to get the correct colors when taking a picture under bright lighting. In this mode, the flash fires in bright as well as dark conditions.



⚡ S Slow synchro

This is a flash mode that uses a slow shutter speed. This allows you to take pictures of people at night that clearly show both your subjects and the night time backdrop. To prevent camera shake, always use a tripod.

- **Slowest shutter speed**
 “⚡” Night scene: up to 3 sec.

👁️ SLOW Red-eye reduction + Slow synchro

Use this mode for Slow synchro shots with Red-eye reduction.

- ⚠️ The image may be overexposed when shooting bright scenes.

To take a picture of a main subject at night with the background brightly lit, use the “⚡” (Night scene) setting (→P.34).

1

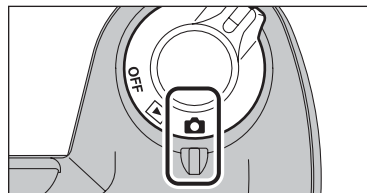

Set the Power switch to “**ON**”.

2

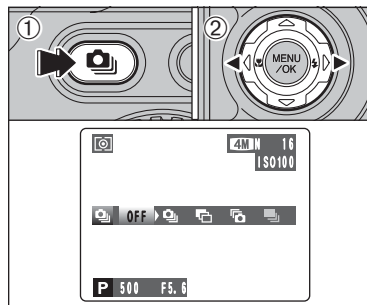

- ① Hold down the “**ON**” button.
- ② Press “**◀**” or “**▶**” to select the Continuous shooting mode.
 Release the “**ON**” button to confirm your selection.

3

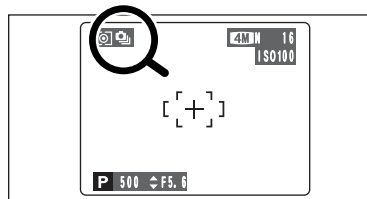

Setting the Continuous shooting mode (except for “OFF”), the selected mode appears on the screen.

- 📷: Top 3-frame continuous shooting
- 📷: Auto bracketing
- 📷: Final 3-frame continuous shooting
- 📷: Long-period continuous shooting

◆ **Notes on using the Continuous shooting modes** ◆

- Shooting continues as long as you hold down the shutter button. In auto bracketing mode however, just press the shutter button once to shoot 3 frames.
- If there is insufficient space on the **xD-Picture Card**, as many frames as can be recorded on the available space are shot. When auto bracketing, if there is insufficient space on the **xD-Picture Card** to record 3 frames, no pictures are taken.
- The focus is determined in the first frame and cannot be changed in mid-sequence.
- The exposure is determined in the first frame, but in Long-period continuous shooting the exposure is adjusted for the scene being shot.
- The speed of continuous shooting varies depending on the shutter speed.
- The speed of continuous shooting does not change with the quality setting.
- The flash cannot be used as the flash mode is set to Suppressed flash.
- For continuous shooting, final 3-frame continuous shooting and pictures taken using auto bracketing, the results are always displayed after you shoot. Note that pictures taken using Long-period continuous shooting are recorded without displaying the results.

Top 3-frame continuous shooting

Available Photography mode:



This mode shoots up to 3 frames (Max. 3 frames/sec.). When taking the pictures, the images appear (in sequence from the left) and are recorded.

The maximum file recording time using the continuous shooting is 3.3 seconds when recording in **xD-Picture Card**.

Auto bracketing

Available Photography mode:

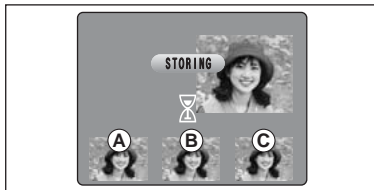

This mode shoots the same image with different exposure settings. Bracketing shoots 3 continuous frames each with a different exposure setting.

A is correctly exposed, B is overexposed and C is underexposed.

The settings (exposure range) can be changed in the photography menu.

Auto bracketing settings (3)

±1/3 EV, ±2/3 EV, ±1 EV

If the underexposed or overexposed frame is outside the camera's control range, the picture is not taken with the specified setting increments.

Auto bracketing cannot be used in "AUTO", "A", "P", "S", "A", "M" and "M" modes.

Changing the setting (exposure range)

Press the "MENU/OK" button to display the menu and change the setting in the "BRACKETING" menu option (P.59).

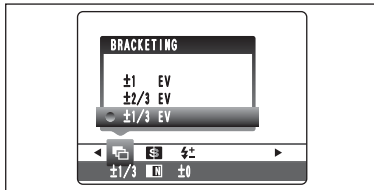

Final 3-frame continuous shooting

Available Photography mode:

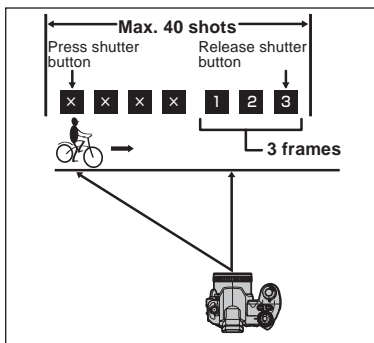

This mode allows you to release the shutter up to 40 times (Max. 3 frames/sec.) and record the last 3 frames. If you take your finger off the shutter button before 40 shots have been taken, the camera records the final 3 frames shot before you released the shutter button.

If there is insufficient space on the **xD-Picture Card**, the camera records as many of the shots taken just before the shutter button was released as will fit on the **xD-Picture Card**.

Long-period continuous shooting

Available Photography mode:

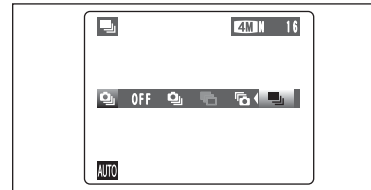

This mode allows you to take up to 40 continuous shots (Max. 1.6 frames/sec.).

Long-period continuous shooting cannot be used in the "A", "P", "S", "A", "M" and "M" modes.

Focusing on a moving subject

If you press the shutter button halfway to focus on the subject at the starting point (A), the subject may no longer be in focus when it reaches point (B) where you want to take the shot. In such situations, focus on point (B) beforehand and then lock the focus so that it does not shift. This feature is also useful for photographing fast-moving subjects that are difficult to focus on.

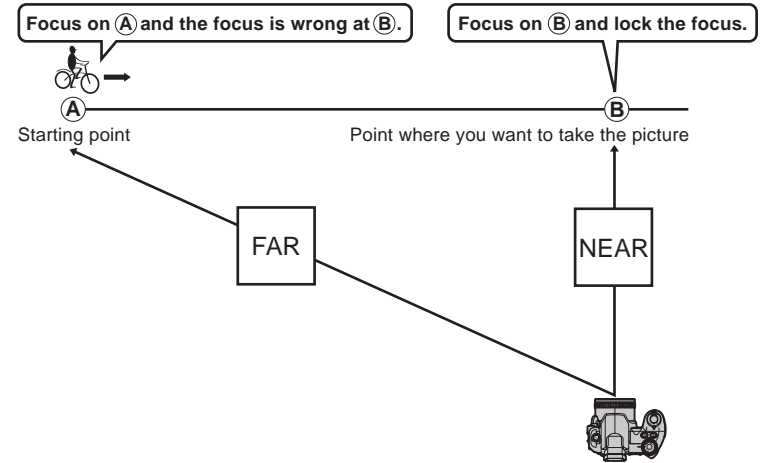

Flash

When a Continuous shooting mode is selected, the flash mode is forcibly set to "Suppressed flash". However, when the mode is changed back to normal photography, the flash setting specified before continuous shooting was selected is restored.

EXPOSURE COMPENSATION

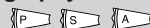

Use this function for shots to get the correct brightness (exposure), such as shots with extremely high contrast between the subject and the background.

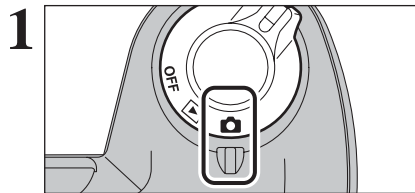

1 Set the Power switch to "CAMERA".

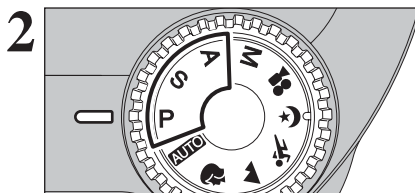

2 Set the Mode dial to "P", "S" or "A" mode.

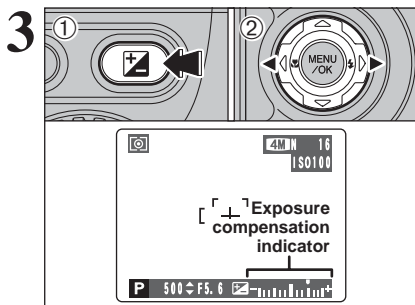

① Hold down "MENU" button.
② Press "◀" or "▶" to set the compensation value.
The symbol indicating the compensation direction (- or +) turns yellow. The "MENU" icon also turns yellow while exposure compensation is being set and then turns blue after setting is completed.

● **Compensation range**
-2 EV to +2 EV (13 steps in 1/3 EV increments)

- Exposure compensation cannot be used in the "AUTO", "SCN", "A", "M", "C", "M" and "M" modes.
- Exposure compensation is disabled in the following situations:
When "FL" (Forced flash) or "RE" (Red-eye reduction) mode is used and the scene is dark.

This setting is retained when the mode is changed or the camera is turned off ("MENU" icon appears). Set the exposure compensation to "0" unless compensation is required.

◆ To obtain the optimum brightness ◆

Adjust the exposure compensation according to the level of brightness or darkness in the image.

- When the subject appears too bright
Try a negative (-) compensation setting.
This will make the overall image darker.
- When the subject appears too dark
Try a positive (+) compensation setting.
This will make the overall image brighter.

■ Guide to compensation

- Backlit portraits: +2 steps to +4 steps (+ $\frac{2}{3}$ EV to +1 $\frac{1}{3}$ EV)
- Very bright scenes (such as snowfields) and highly reflective subjects: +3 steps (+1 EV)
- Shots made up predominantly of sky: +3 steps (+1 EV)
- Spotlight subjects, particularly against dark backgrounds: -2 steps (- $\frac{2}{3}$ EV)
- Scenes with low reflectivity, such as shots of pine trees or dark foliage: -2 steps (- $\frac{2}{3}$ EV)

CONTINUOUS AF

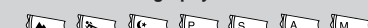

Use this button to take pictures of a moving subject. Using Continuous AF mode reduces the time required for focusing.

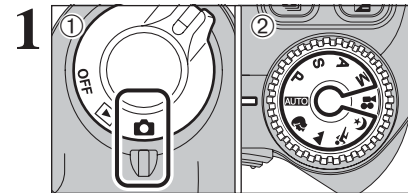

① Set the Power switch to "CAMERA".
② Set the Mode dial to "AUTO", "SCN", "A", "M", "C", "P", "S", "A" or "M" mode.

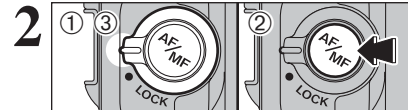

① Unlock the Focus mode selector lock switch.
② Press the Focus mode selector button to set the Focus mode to "C-AF".
③ Lock the Focus mode selector lock switch to prevent the switch moves.

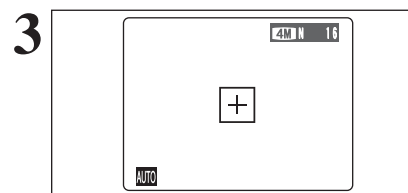
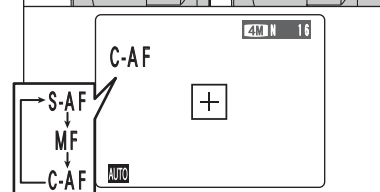

Frame the shot so that the subject fills the entire AF frame. The camera continues to focus on the main subject in the AF frame.

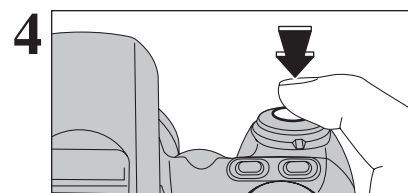

Press the shutter button down halfway (AF/AE lock) without releasing the button, press the button down fully to take the picture.
This allows you to shorten the focusing time.

- Continuous AF is disabled in the AF AREA or MF (Manual Focus) modes.
See P.57 for information on changing AF mode.

◆ Notes on continuous AF ◆

Because the camera focuses continuously without pressing the shutter button, note the following:

- Watch the battery level carefully since the camera consumes more power in this mode than in other Focus modes (S-AF and MF).
- If the Power save function is set to "OFF", particular attention must be given to the battery level.

To set the focus manually, use this function after adjusting the focus automatically with “S-AF” auto focus mode.

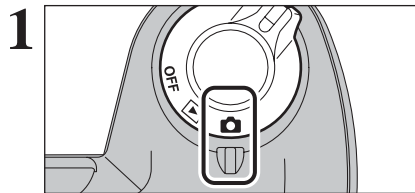

1 Set the Power switch to “”.

Manual focus cannot be used in the “” Movie mode.

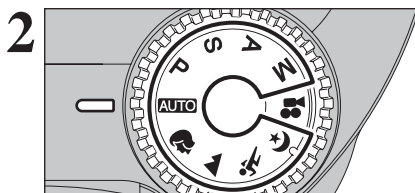

2 Set the Mode dial to “**AUTO**”, “”, “”, “”, “”, “P”, “S”, “A” or “M” mode.

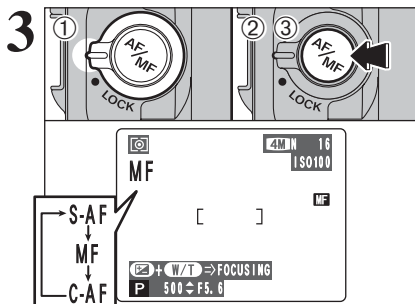

① Unlock the Focus mode selector lock switch.
② Press the Focus mode selector button to set the Focus mode to “S-AF”, focus on the subject and press the shutter button halfway. The camera is then focused on the subject.
③ Press the Focus mode selector button to set the Focus mode to “MF”. The focusing position is locked on the subject.

If the subject moves or the zoom setting is changed, repeat the procedure from step ②.

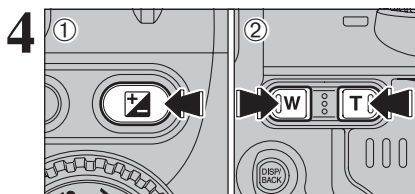

① Hold down the “” button.
② Press the “T” or “W” button to adjust the focus. Use the screen to check the focus.

+T	Moves the focus further.
+W	Moves the focus closer.

◆ Mastering manual focusing ◆

The image is unfocused when the camera moves. Use a tripod to avoid camera shake.

This is useful when checking the shot composition for dimly lit scenes (Slow synchro shots, etc.).

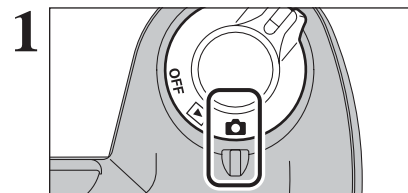

1 Set the Power switch to “”.

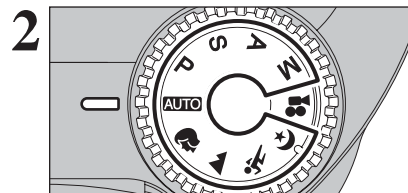

2 Set the Mode dial to “**AUTO**”, “”, “”, “”, “”, “P”, “S”, “A” or “M” mode.

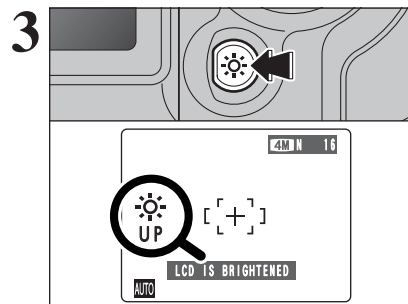

3 Press the “” Low light viewfinder button. “” appears on the screen and the subject is displayed brightly.
To cancel increased brightness: Press the “” Low light viewfinder button again. This function is automatically cancelled after each shot.

This function is purely for checking the composition of your shot. It does not increase the brightness of the photographed image.
 Even if you increase the brightness in dark locations, you may not see the subject.
 To maintain the monitor brightness, specify the desired setting in the “ EVF/LCD” (LCD monitor brightness) adjustment in the settings menu. The adjustment is retained even after taking pictures or turning camera off. See P.79 for details.

QUALITY MODE (NUMBER OF RECORDED PIXELS)

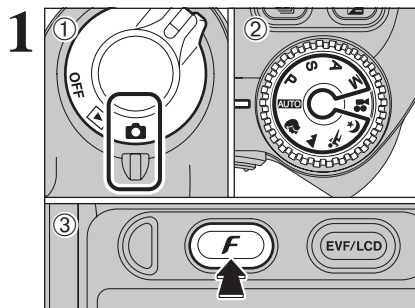

- 1 Set the Power switch to "ON".
- 2 Set the Mode dial to "AUTO", "P", "S", "A" or "M" mode.
- 3 Press the "F" button.

The quality setting is retained even when the camera is off or the Mode setting is changed.

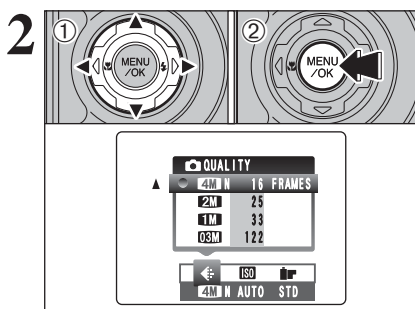

- 1 Press "←" or "→" to select the "QUALITY" setting and then press "▲" or "▼" to change the setting.
- 2 Press the "MENU/OK" button to confirm the setting.

- The numbers to the right of each setting show the number of available frames.
- When changing the quality setting, the number of available frames also changes (⇒P.24).

Quality settings in Photography mode

Quality mode	Sample Uses
4M F (2272 × 1704)	Printing at up to 6R (15.2 × 20.3 cm/6 × 8 in.) / A5 size For better quality, select "4M F"
4M N (2272 × 1704)	
2M (1600 × 1200)	Printing at up to 4R (10.2 × 15.2 cm/4 × 6 in.) / A6 size
1M (1280 × 960)	Printing at up to 3R (8.9 × 12.7 cm/3.5 × 5 in.) size
0.8M (640 × 480)	To use for e-mail or web site

ISO SENSITIVITY

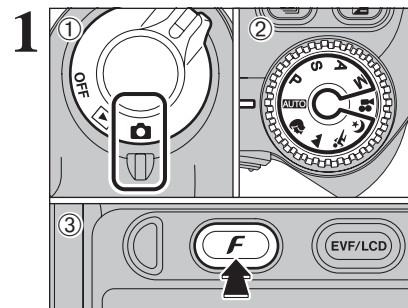

- 1 Set the Power switch to "ON".
- 2 Set the Mode dial to "AUTO", "P", "S", "A" or "M" mode.
- 3 Press the "F" button.

In "MOVIE" mode, do not set the "ISO" (sensitivity) setting.

Sensitivity is retained even when the camera is off or the Mode setting is changed.

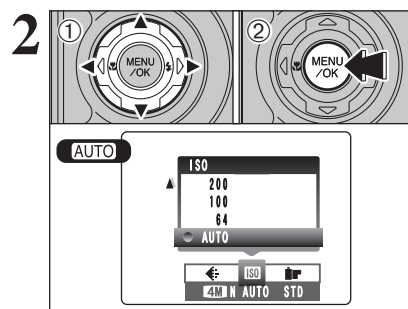

- 1 Press "←" or "→" to select the "ISO" setting and then press "▲" or "▼" to change the setting.
- 2 Press the "MENU/OK" button to confirm the setting.

Settings

AUTO: AUTO/64/100/200/400
 P, S, A, M: 64/100/200/400

- When setting CCD-RAW (⇒P.85), only the "64", "100" and "200" sensitivity settings can be selected.
- While selecting a higher sensitivity setting will allow you to take pictures in darker locations, it will also increase the amount of speckling in your images. Streaking may also be visible in shots of scenes such as the night sky. Choose the sensitivity setting that best suits the conditions.

Selecting AUTO as the sensitivity setting, the camera selects the best sensitivity setting for the subject's brightness. Refer to "Specifications" (⇒P.115) for information on the AUTO sensitivity setting. The AUTO sensitivity setting can be selected in the "AUTO" Photography modes.

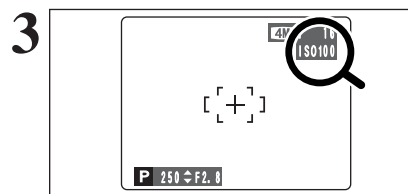

When the sensitivity is set to "64", "100", "200" or "400" the selected sensitivity setting appears on the screen.

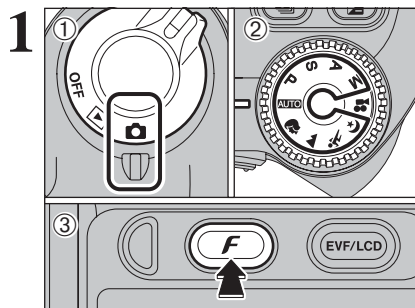

- 1 Set the Power switch to "ON".
- 2 Set the Mode dial to "AUTO", "P", "S", "A", "M", "P", "S", "A" or "M" mode.
- 3 Press the "F" button.

In "Movie" mode, do not set the "FinePix COLOR" setting.

The FinePix COLOR setting is retained even when the camera is off or the Mode setting is changed.

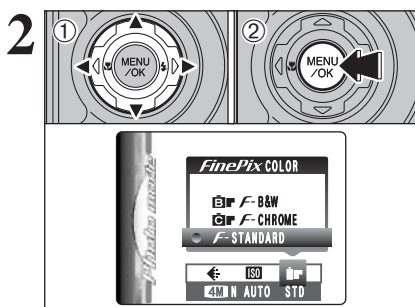

- 1 Press "◀" or "▶" to select the "FinePix COLOR" setting and then press "▲" or "▼" to change the setting.
- 2 Press the "MENU/OK" button to confirm the setting.

- F-CHROME may have little visible effect with some subjects, such as close-up shots of people (portraits).
- Because the effects on the image differ depending on the scene being shot in F-CHROME mode, take pictures in standard mode as well as this mode. Note that you may not be able to see any difference on the screen.
- For shots taken in F-CHROME mode or F-B&W mode, automatic quality adjustment will be suppressed on Exif Print compliant printers.

F-STANDARD	The contrast and color saturation are set to standard. Use this mode for normal photography.
F-CHROME	The contrast and color saturation are set to high. This feature is effective for taking more vivid shots of subjects such as scenery (blue sky and greenery) and flowers.
F-B&W	This setting converts the colors in the photographed image to black and white.

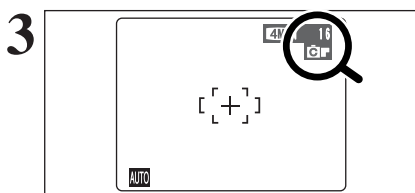

When setting F-CHROME or F-B&W, the icon appears on the screen.

- F-CHROME:
- F-B&W:

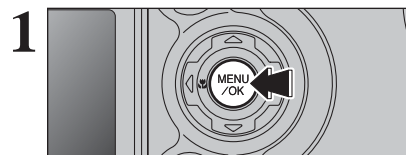

Press the "MENU/OK" button to display the menu on the screen.

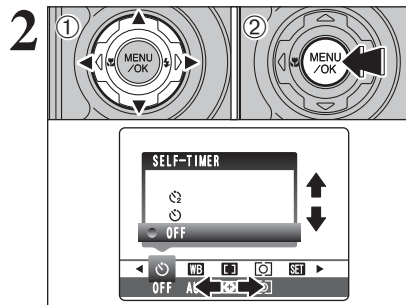

- 1 Press "◀" or "▶" to select the menu item and "▲" or "▼" to change the setting.
- 2 Press the "MENU/OK" button to confirm the setting.

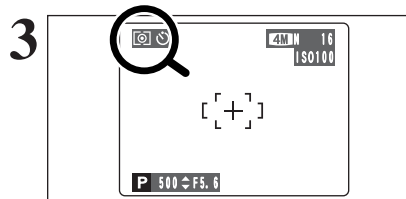

When you enable the setting, an icon appears in the top-left corner of the screen.

The settings available in the menu screen vary depending on the Photography mode.

Self-timer →P.54

Use this setting for taking pictures such as group shots where the photographer is included in the shot.

Bracketing →P.59

Use this setting to photograph the same image with different exposure settings.

WB White balance →P.55

Change the white balance setting to take a picture with the white balance fixed for the surroundings and lighting.

Sharpness →P.59

Use this setting to soften or emphasize outlines or to adjust the quality of the image.

AF Mode →P.57

Set the focusing method.

Flash brightness adjustment →P.59

Change this setting to adjust the amount of light emitted by the flash to suit the photography conditions or to achieve a desired effect.

[O] Photometry →P.58

Use this setting for scenes where the brightness of the subject and background differ markedly so that the MULTI setting is unlikely to achieve the desired results.

SELF-TIMER PHOTOGRAPHY

Available Photography mode:

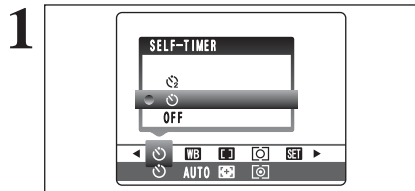

The self-timer is used in situations where the photographer is included in the shot. When selecting the self-timer setting, the self-timer icon appears on the screen.

- : The picture is taken after 2 seconds.
- : The picture is taken after 10 seconds.

- Any of the following cancels the self-timer setting:
 - Completing the shooting
 - Changing the Mode dial setting
 - Setting the camera to Playback mode
 - Turning the camera off

Using the 2-second self-timer

This is useful when you have the camera on a tripod and you want to prevent camera shake.



- ① Position the AF frame over the subject.
- ② Press the shutter button down halfway to focus on the subject.
- ③ Without releasing the shutter button, press the button all the way down (fully pressed) to start the self-timer.

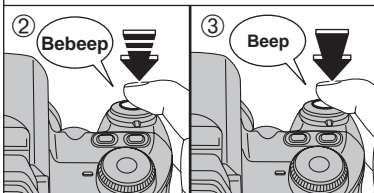

- The AF/AE lock can be also used (⇒P.25).
- Take care not to stand in front of the lens when pressing the shutter button as this can prevent the correct focus or brightness (exposure) from being achieved.

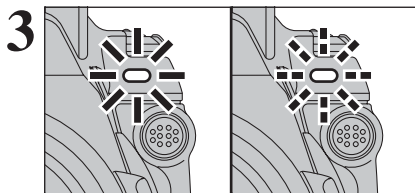

The self-timer lamp lights and then starts blinking until the picture is taken.

- To stop the self-timer, once it has started running, press the "DISP/BACK" button.

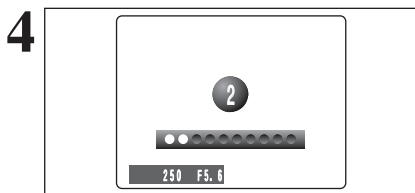

A countdown appears on the screen indicating the time remaining until the picture is taken. Self-timer mode is cancelled after each shot.

WB WHITE BALANCE

Available Photography mode:

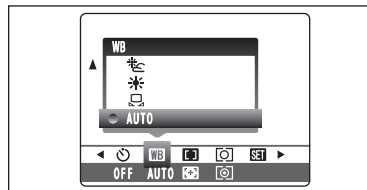

Change the white balance setting to take a picture with the white balance fixed for the surroundings and lighting.

In AUTO mode, the correct white balance may not be achieved for subjects such as close-ups of people's faces and pictures taken under a special light source. Select the correct white balance for the light source. See P.117 for more information on the white balance.

- AUTO**: Automatic adjustment (shooting to show the ambience of the light source)
- : Custom white balance
- : Shooting outdoors in good weather
- : Shooting in shade

- : Shooting under "Daylight" fluorescent lamps
- : Shooting under "Warm White" fluorescent lamps
- : Shooting under "Cool White" fluorescent lamps
- : Shooting in incandescent light

* When the flash fires, the white balance setting (excluding custom white balance) for the flash is used. Consequently, to achieve a particular effect, the flash mode should be set to Suppressed flash (⇒P.40).

- The color tones may vary depending on the shooting conditions (light source, etc.).

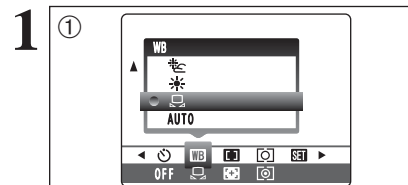

Custom white balance

Use this setting to set the white balance for the ambient natural or artificial lighting in images. Use this setting to achieve special effects also.

- ① Select "CUSTOM" Custom white balance.
- ② Press the "MENU/OK" button.

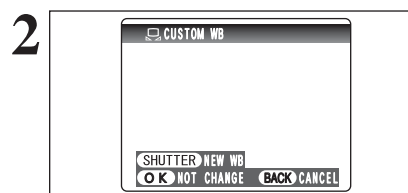

Hold a piece of white paper under the light source you are setting the white balance for, so that it fills the entire screen. Then press the shutter button to set the white balance.

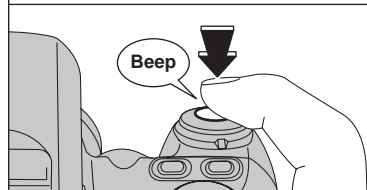

- The white balance setting does not affect the image shown on the screen.

To use the white balance set previously, press the "MENU/OK" button without pressing the shutter button.

3

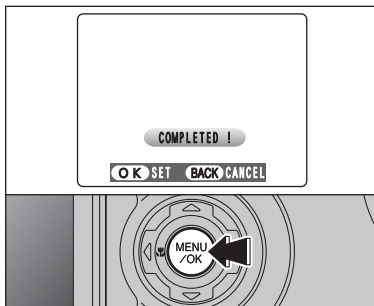

When the correct exposure is measured, "COMPLETED!" appears. Press the "MENU/OK" button to confirm the setting.

- The specified custom white balance is retained until it is reset. This setting is retained even if the batteries are removed.
- After taking the picture, check the "Color (White balance)" setting for the image.
 - Set the Power switch to "II" (⇒P.27).

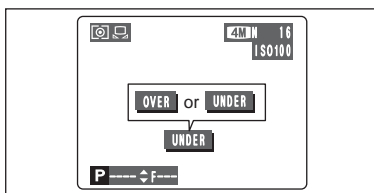

When "OVER" or "UNDER" appears, the white balance was not measured at the correct exposure. Set the exposure compensation again, using a negative value (-) when "OVER" appears and a positive value (+) when "UNDER" appears.

◆ Example ◆

You can change the white balance for a photographed image by using colored paper instead of white paper.

AF MODE

Available Photography mode: P S A M

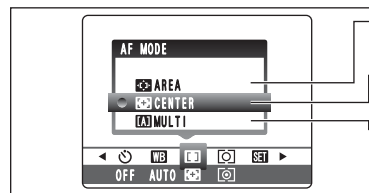

- AREA
- CENTER
- MULTI

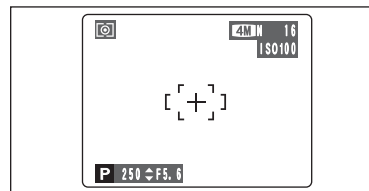

CENTER
The camera focuses on the center of the screen. Use this setting when taking pictures using AF/AE lock (⇒P.25).

The AF mode can only be selected when the focus mode is S-AF (⇒P.20).

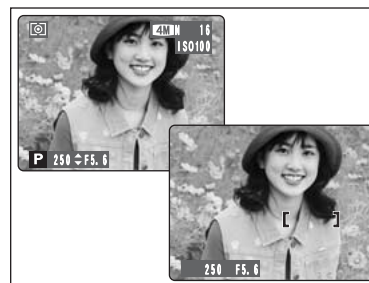

MULTI
Press the shutter button down halfway. The camera recognizes any strongly contrasting subject near the center of the screen and displays the AF frame over the subject in focus.

- When taking pictures in Macro mode, the camera focuses on the center of the screen.

You cannot check the focus when taking pictures using the viewfinder. After taking the picture, play it back to check the focus.

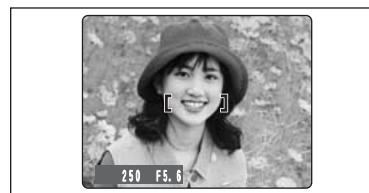

For a high-contrast subject in the center of the screen

Press the shutter button down halfway. The AF frame appears positioned on the high-contrast subject near the center of the image.

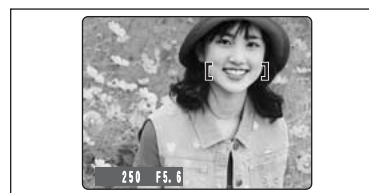

When there is no high-contrast subject in the center of the screen

When the camera has difficulty focusing on the subject in MULTI mode, set the AF mode to CENTER and use AF/AE Lock (⇒P.25).

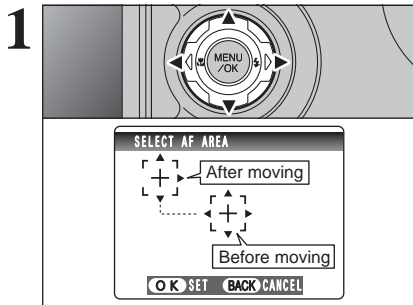

AREA

The camera changes the focusing position on the screen. Use this setting when composing the shot using a tripod and changing the focusing position. Press “▲”, “▼”, “◀” or “▶” to move the “+” (target point) to the focusing position.

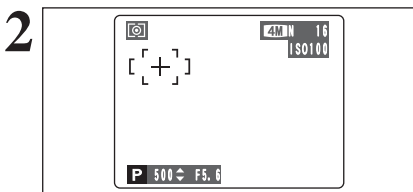

The AF frame appears in the location to which the target point was moved. Take the picture in the normal way. To reposition the AF frame, select “AREA” from the “AF MODE” menu.

Regardless of the AF frame location, the exposure is always set using the area in the center of the screen. To expose the shot for your main subject, use AE lock.

PHOTOMETRY

Available Photography mode: P S A M

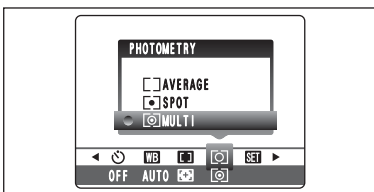

Use this setting for scenes where the brightness of the subject and background differ markedly so that the MULTI setting is unlikely to achieve the desired result.

[O] MULTI

Light metering where the camera assesses the scene and selects the optimum exposure.

[•] SPOT

Light metering where the exposure is optimized for the center of the image.

[] AVERAGE

Light metering where an average value for the entire image is used.

In the “AUTO”, “P”, “S”, “A”, “M” and “C” modes, light metering is fixed at the MULTI setting and cannot be changed.

◆ The photometry modes are effective for the following subjects ◆

- **MULTI**
In this mode, the camera uses automatic scene recognition to analyze the subject and provide optimum exposure in a wide range of shooting conditions. This mode should be used for everyday photography.
- **SPOT**
This mode is useful for subjects with strongly contrasting light and dark areas where you want to achieve the correct exposure for a particular feature.
- **AVERAGE**
The advantage of this mode is that the exposure tends not to change for different compositions or subjects. This mode is particularly effective for shots of people wearing black or white clothing and shots of scenery.

BRACKETING

Available Photography mode: P S A M

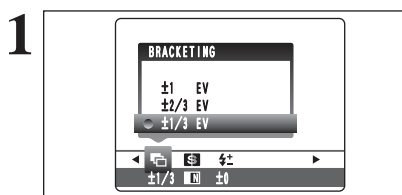

Use this setting to photograph the same image with different exposure settings. Bracketing shoots 3 continuous frames, one of which is correctly exposed while the remaining two are underexposed and overexposed respectively by a set amount.

• Bracketing settings (3)

±1/3 EV, ±2/3 EV, ±1 EV

See P.117 for more information on EVs.

If the underexposed or overexposed frame is outside the camera's control range, the shot is not taken with the specified setting increments.

Flash photography cannot be used.

This feature always takes 3 shots. However, if there is insufficient space on the xD-Picture Card for 3 shots, no picture will be taken.

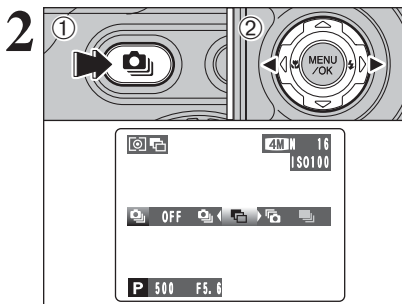

Auto bracketing

After setting the exposure for bracketing:

- ① Hold down the “OK” button.
- ② Press “◀” or “▶” to select “Auto bracketing”.

SHARPNESS

Available Photography mode: P S A M

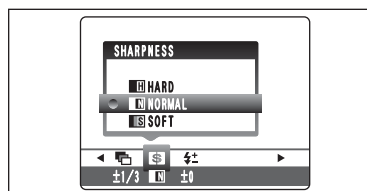

Use this setting to soften or emphasize outlines or to adjust the quality of the image.

HARD: Emphasizes the outlines. Best for shots of subjects such as buildings or text where sharp images are desirable.

SOFT: Softens the outlines. Best for shots of subjects such as people, where a softer image is desirable.

NORMAL: Best for ordinary photography. Provides edge sharpness that is ideal for most picture taking situations.

FLASH BRIGHTNESS ADJUSTMENT

Available Photography mode: P S A M

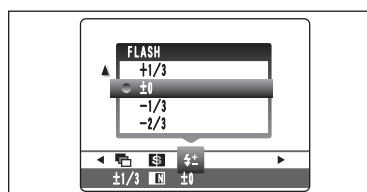

Use this setting to change the amount of light emitted by the flash to suit the photography conditions or to achieve a desired effect.

• Compensation range: ±2 levels

–2/3 EV to +2/3 EV in approx. 1/3 EV increments (total: 5 levels selectable)

See P.117 for information on EVs.

Depending on the type of subject and the shooting distance, brightness adjustment may have no effect.

The image may appear dark when the shutter speed is set to speeds higher than 1/1000 sec.

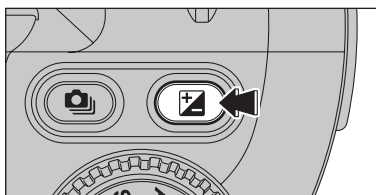

Use this function to check the photography information. Hold down the “” button to check the information.

This function cannot be used during multi-frame playback (→P.27).

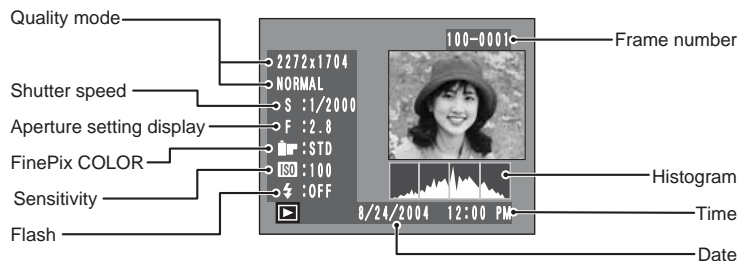

◆ Histograms ◆

A histogram is a chart showing the distribution of brightness in an image (horizontal axis: brightness; vertical axis: pixels).

- ① **Optimal exposure:** There is an ample distribution of pixels overall with a peak in the middle range.
- ② **Overexposed:** The number of highlight pixels is high with the distribution sloping upwards to the right.
- ③ **Underexposed:** The number of shadow pixels is high with the distribution sloping upwards to the left.

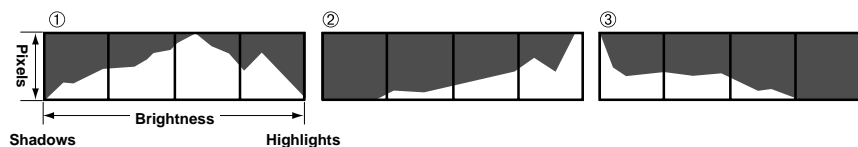

The shape of the graph will vary depending on the subject.

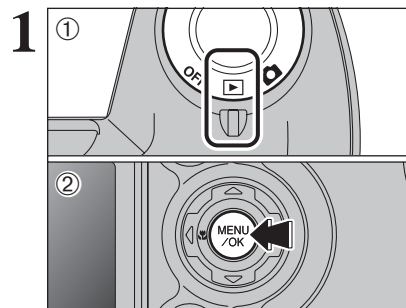

- ① Set the Power switch to “ON”.
- ② Press the “MENU/OK” button to display the menu on the screen.

Erased frames (files) cannot be recovered. Back up important frames (files) onto your PC or another media.

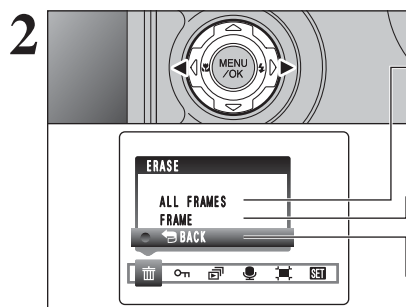

Press “◀” or “▶” to select “” ERASE.

ALL FRAMES

Erases all unprotected frames (files). Back up important frames (files) onto your PC or another media.

FRAME

Erases only the selected frame (file).

BACK

Returns to playback without erasing any frames (files).

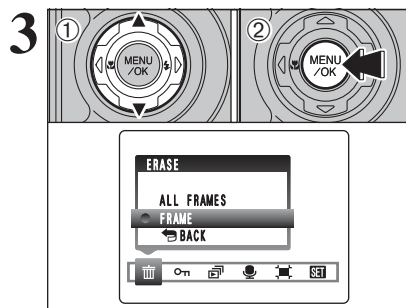

- ① Press “▲” or “▼” to select “ALL FRAMES” or “FRAME”.
- ② Press the “MENU/OK” button.

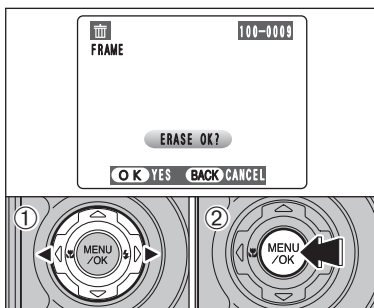

FRAME

- 1 Press “◀” or “▶” to select the frame (file) to be erased.
- 2 Press the “MENU/OK” button to erase the currently displayed frame (file).
To erase another frame (file), repeat steps ① and ②. When you have finished erasing frames (files), press the “DISP/BACK” button.

- ⚠ Pressing the “MENU/OK” button repeatedly erases consecutive frames (files). Take care not to erase a frame (file) by mistake.
- ⚠ Protected frames (files) cannot be erased. Unprotect the frames (files) before erasing them (⇒P.63).

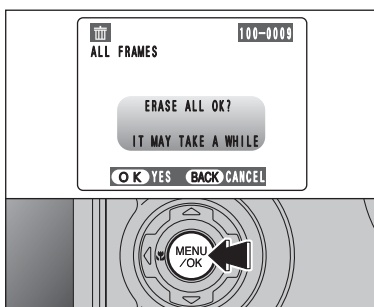

ALL FRAMES

Pressing the “MENU/OK” button erases all the frames (files).

- ⚠ Protected frames (files) cannot be erased. Unprotect the frames (files) before erasing them (⇒P.63).

If “DPOF SPECIFIED. ERASE OK?” or “DPOF SPECIFIED. ERASE ALL OK?” appears, press the “MENU/OK” button again to erase the frames (files).

◆ To stop the procedure midway ◆

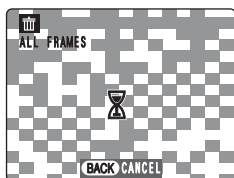

Press the “DISP/BACK” button to cancel erasing of all the frames (files). Some unprotected frames (files) will be left unerased.

- ⚠ Even if you stop the procedure immediately, some frames (files) will be erased.

PROTECTING IMAGES: FRAME / SET ALL / RESET ALL

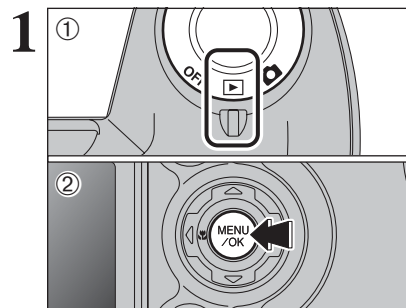

- ① Set the Power switch to “”.
- ② Press the “MENU/OK” button to display the menu on the screen.

Protection is a setting that prevents frames (files) from being accidentally erased. However, the “FORMAT” function erases all the frames (files), including protected frames (files) (⇒P.82).

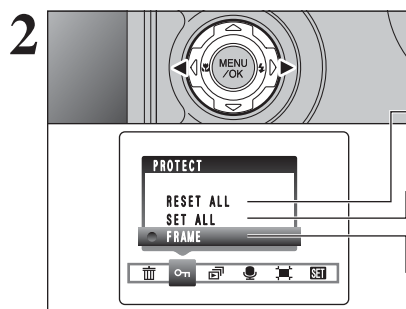

Press “◀” or “▶” to select “” PROTECT.

RESET ALL

Removes the protection from all the frames (files).

SET ALL

Protects all the frames (files).

FRAME

Protects or unprotects only the selected frame (file).

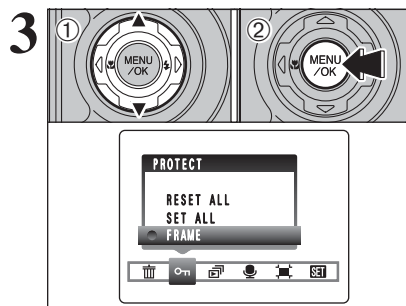

- ① Press “▲” or “▼” to select “FRAME”, “SET ALL” or “RESET ALL”.
- ② Press “MENU/OK” button to confirm your selection.

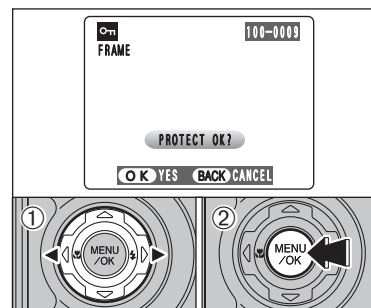

FRAME SET

- ① Press “◀” or “▶” to select the frame (file) to be protected.
- ② Press the “MENU/OK” button to protect the frame (file) currently displayed.

To protect another frame (file), repeat steps ① and ②. When you have finished protecting frames (files), press the “DISP/BACK” button.

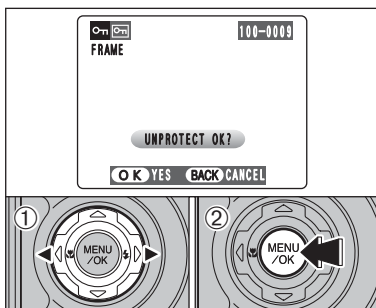

FRAME RESET

- ① Press “◀” or “▶” to select the protected frame (file).
- ② Press the “MENU/OK” button to unprotect the displayed frame (file).

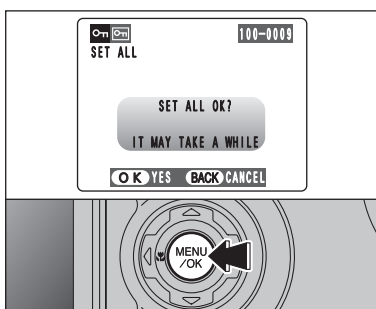

SET ALL

Press the “MENU/OK” button to protect all the frames (files).

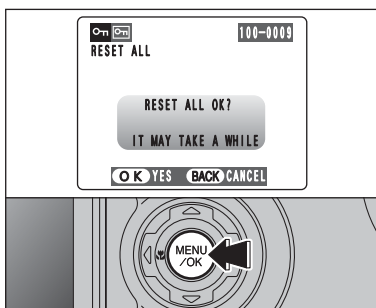

RESET ALL

Press the “MENU/OK” button to unprotect all the frames (files).

◆ **To stop the procedure midway** ◆

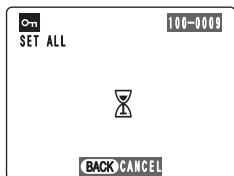

If the images are very large, protecting or unprotecting all the frames (files) may take some time. If you want to take a picture or record a movie during the procedure, press the “DISP/BACK” button. To return to protecting or unprotecting all the frames (files), see the procedure on P.63 and begin at step 1.

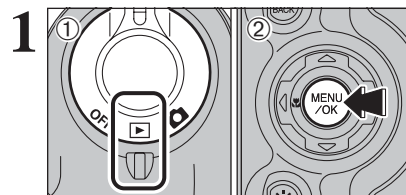

- ① Set the Power switch to “▶”.
- ② Press the “MENU/OK” button to display the menu on the screen.

The Power save function does not operate during playback.
 Movies start automatically. When the movie ends, the playback function moves it on.

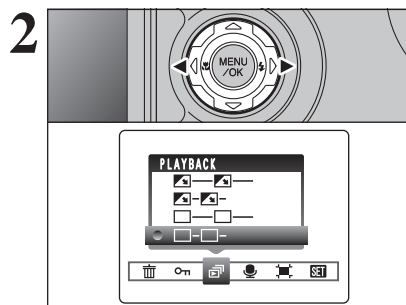

Press “◀” or “▶” to select “▶” PLAYBACK.

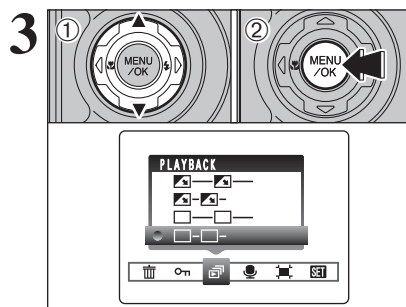

- ① Press “▲” or “▼” to select the playback interval and the type of image transition.
- ② Press the “MENU/OK” button. The image frames are advanced and played back. To interrupt PLAYBACK, press “▲” (or “MENU/OK” button).

Press the “DISP/BACK” button once during playback to display the playback frame number and on-screen help.

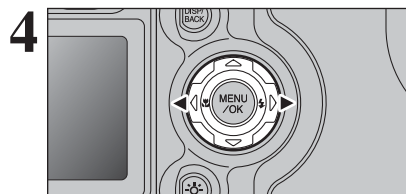

Press “◀” or “▶” to advance or go back through the images.

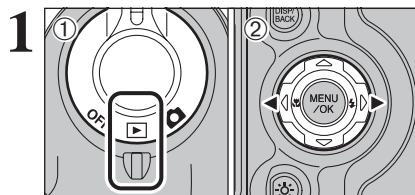

Voice memos can be added to still images.

- **Audio recording format:** WAVE (→P.117)
PCM recording format
- **Audio file size:** approx. 480 KB
(for a 30-second voice memo)

- ① Set the Power switch to "▶".
- ② Press "◀" or "▶" to select the image (still image) to add a voice memo.

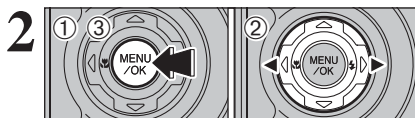

- ① Press the "MENU/OK" button to display the menu on the screen.
- ② Press "◀" or "▶" to select "🎤" VOICE MEMO.
- ③ Press the "MENU/OK" button.

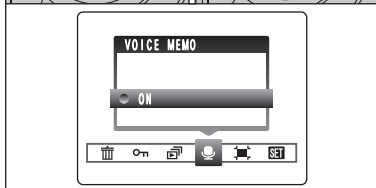

- 🔊 Voice memos cannot be added to movies.
- 🔊 When "PROTECTED FRAME" appears, unprotect the frame.

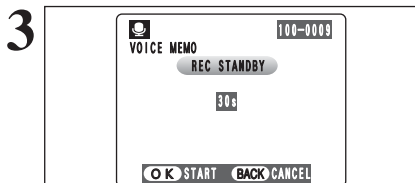

"REC STANDBY" appears on the screen.
Press the "MENU/OK" button to begin recording.

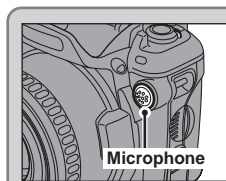

Face the microphone on the front of the camera to record your comment. Hold the camera about 20 cm (7.9 in.) away for the best results.

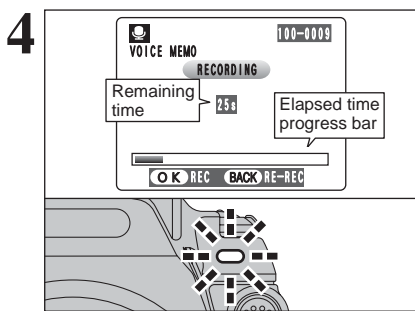

The remaining recording time appears during recording and the self-timer lamp blinks. When the time remaining reaches 5 seconds, the self-timer lamp starts blinking quickly.

- 🔊 To end your comment during recording, press the "MENU/OK" button.

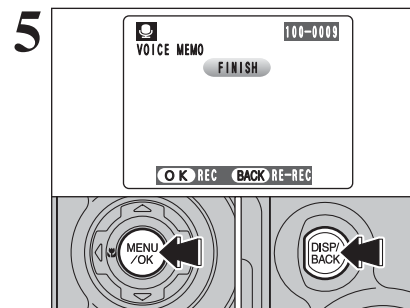

After 30 seconds of recording, "FINISH" appears on the screen.

To finish: Press the "MENU/OK" button.

To re-record your comment:

Press the "DISP/BACK" button.

◆ **When the image already has a voice memo** ◆

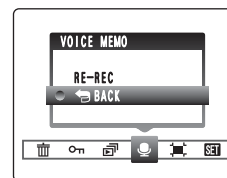

If you select an image that already has a voice memo, a screen appears in which you can select whether to re-record the memo.

- 🔊 When "PROTECTED FRAME" appears, unprotect the frame.

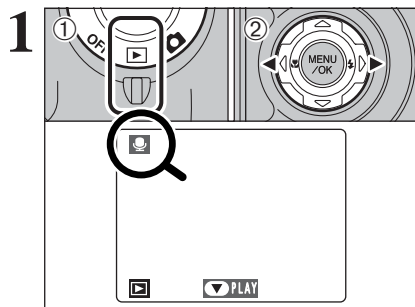

- 1 Set the Power switch to "▶".
- 2 Press "◀" or "▶" to select an image file that has a voice memo.

🔊 Voice memos can not be played back using multi-frame playback. Press the "DISP/BACK" button twice to select single-frame playback.

Indicated by the "🔊" icon.

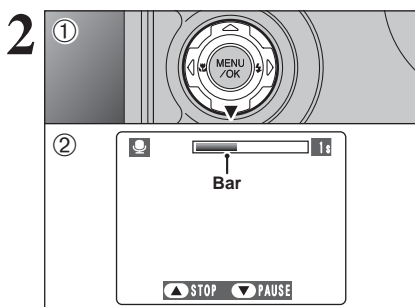

- 1 Press "▼" to play the voice memo.
- 2 The playback time appears on the screen along with a progress bar.

🔊 When the sound is difficult to hear, adjust the volume (➡P.79).

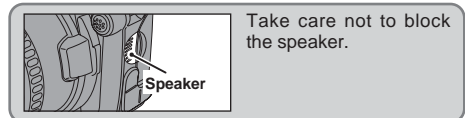

■ **Playing back voice memos**

	Control	Description
Playback		The voice memo stops when playback ends.
Pause/Resume		Pauses the voice memo during playback. Press "▼" again to resume playback.
Stop		Stops playback. * Press "◀" or "▶" while voice memo playback is stopped to go back to the previous file or advance to the next file respectively.
Fast forward/ Fast reverse	 Fast reverse Fast forward	Press "◀" or "▶" during playback to skip forwards or backwards through the voice memo. * These buttons do not function while playback is paused.

◆ **Compatible voice memo files** ◆

You can use your FinePix S5100/FinePix S5500 to playback voice memos recorded on this camera or voice memos up to 30 seconds long recorded onto a **xD-Picture Card** using a FUJIFILM digital camera.

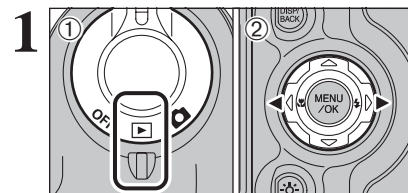

- 1 Set the Power switch to "▶".
- 2 Press "◀" or "▶" to select the trimming frame (file).

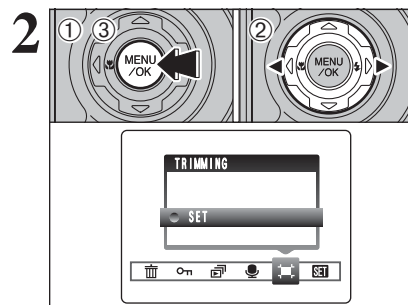

- 1 Press the "MENU/OK" button to display the menu on the screen.
- 2 Press "◀" or "▶" to select "TRIMMING".
- 3 Press the "MENU/OK" button.

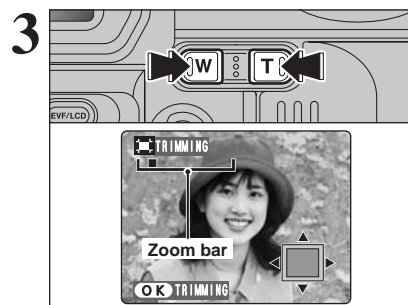

Press the "T" button or "W" button to zoom in (enlarge) or out on a still image. A zoom bar appears.

🔊 Press the "DISP/BACK" button to return to single-frame playback.

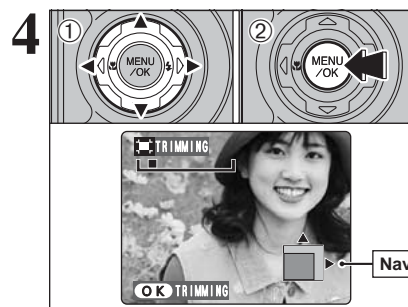

- 1 Press "▲", "▼", "◀" or "▶" to display another area.
- 2 Press the "MENU/OK" button to trim the image. The current displayed image appears on the navigation screen.

🔊 Press the "DISP/BACK" button to return to single-frame playback.

5

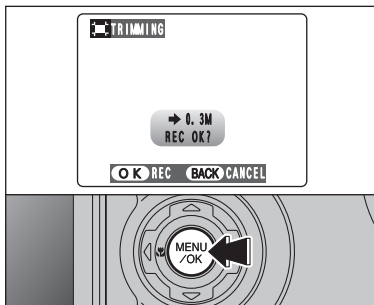

Check the saved image size and press the "MENU/OK" button. The trimmed image is added as a separate file in the final frame.

■ Image sizes

2M	Printing at up to 4R (10.2 × 15.2 cm/4 × 6 in.) / A6 size
1M	Printing at up to 3R (8.9 × 12.7 cm/3.5 × 5 in.) size
03M	To use for e-mail or web site



DPOF stands for Digital Print Order Format and refers to a format that is used for recording printing specifications for images shot using a digital camera on media such as an **xD-Picture Card**. The recorded specifications include information on which frames are to be printed.

This section gives a detailed description of how to order your prints with the FinePix S5100/FinePix S5500.

- * Note that some printers do not support date and time imprinting or specification of the number of prints.
- * Note that the warnings shown below may be displayed while you are specifying the prints.

DPOF SPECIFIED. ERASE OK ?

DPOF SPECIFIED. ERASE ALL OK ? (⇒P.62)

When erasing the image, the DPOF setting for that image is deleted at the same time.

RESET DPOF OK ? (⇒P.72)

When inserting an **xD-Picture Card** that contains images specified for printing by another camera, those print specifications are all reset and replaced by the new print specifications.

DPOF FILE ERROR (⇒P.112)

Up to 999 images can be specified on the same **xD-Picture Card**.

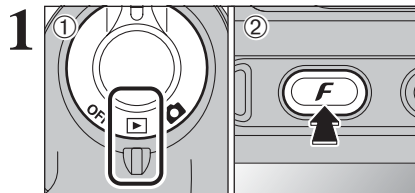

- ① Set the Power switch to "▶".
- ② Press the "F" button.

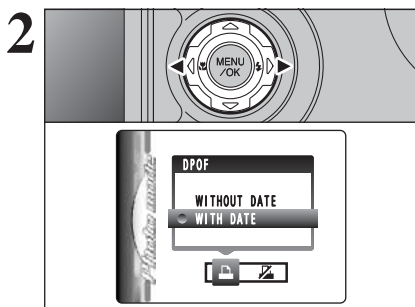

Press "◀" or "▶" to select " DPOF.



"" appears on the screen during playback when the image has specified DPOF settings.

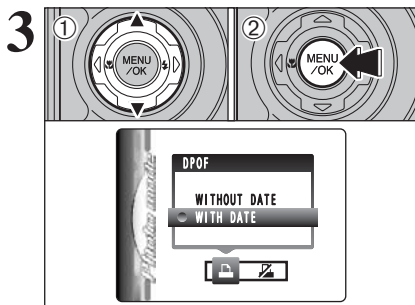

- ① Press "▲" or "▼" to select "WITH DATE" or "WITHOUT DATE". Selecting "WITH DATE" will cause the date to be imprinted on your prints.
- ② Press the "MENU/OK" button.

⚠ When selecting the "WITH DATE" setting, the date is imprinted on your shots using the Print Service or a DPOF-compatible printer (depending on the printer specifications, the date may not be printed in some cases).

◆ **When DPOF settings were specified on another camera** ◆



When the data includes a frame (file) with DPOF settings that were specified on another camera, "RESET DPOF OK?" appears. Pressing the "MENU/OK" button erases all of the DPOF settings already specified for each frame (file). Specify the DPOF setting for each frame (file) again.

⚠ Press the "DISP/BACK" button to leave the previous settings unchanged.

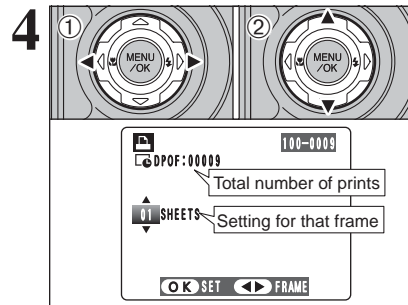

- ① Press "◀" or "▶" to display the frame (file) for specifying DPOF settings.

- ② Press "▲" or "▼" to set a value up to 99 as the number of copies of the frame (file) to be printed. For frames (files) that you do not want printed, set the number of prints to 0 (zero).

To specify more DPOF settings, repeat steps ① and ②.

⚠ Prints of up to 999 image frames (files) can be ordered on the same xD-Picture Card.

⚠ DPOF settings cannot be specified for movie and CCD-RAW.

Pressing the "DISP/BACK" button while choosing the settings will cancel all the current settings. If there were previous DPOF settings, only the modifications are cancelled.

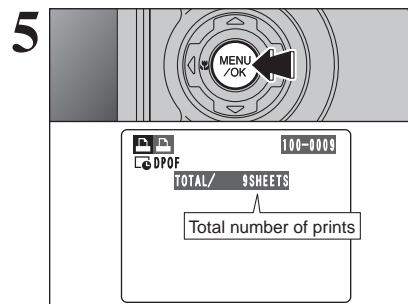

Always press the "MENU/OK" button after the settings are completed.

Pressing the "DISP/BACK" button cancels those settings.

◆ **Canceling a frame** ◆

To cancel the DPOF setting for a frame (file) you have specified (cancel frame), perform steps 1 to 3 and then:

- ① Press "◀" or "▶" to select the frame (file) with the DPOF setting you want to cancel.
- ② Set the number of prints to 0(zero).

To cancel the DPOF setting for another frame (file), repeat steps ① and ②.

Press the "MENU/OK" button to complete the settings.

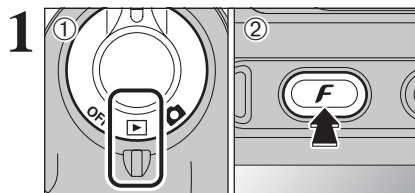

- ① Set the Power switch to "Movie".
- ② Press the "F" button.

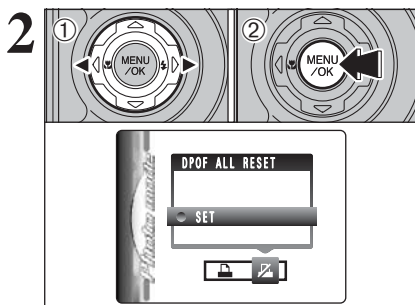

- ① Press "←" or "→" to select "DPOF ALL RESET".
- ② Press the "MENU/OK" button.

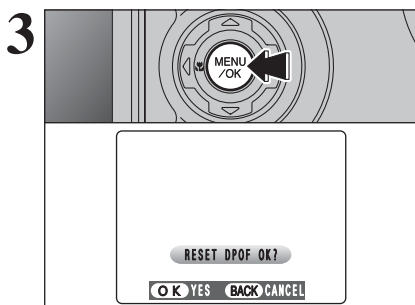

A message appears.
To reset all the DPOF settings, press the "MENU/OK" button.

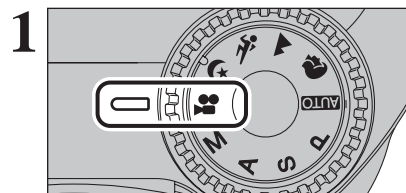

Set the Mode dial to "Movie".
Use "Movie" mode to record movies with sound.

- **Specifications**
Motion JPEG with monaural sound
 - **Quality selection method**
 - 640 (640 × 480 pixels)
 - 320 (320 × 240 pixels)
 - **Frame rate**
30 frames per second
- See P.117 for information on the frame rate.

- ⚠ See P.77 for information on changing the quality setting.
- ⚠ The available recording time for a movie may decrease depending on the amount of free space on the xD-Picture Card.
- ⚠ Because a movie is recorded onto the xD-Picture Card as it is saved, it cannot be recorded correctly if the camera suddenly loses power (if you open the battery cover or disconnect the AC power adapter).

It may not be possible to playback your movies on other cameras.

Recording times for xD-Picture Card

* These figures are the available recording times using a new xD-Picture Card formatted on the camera. The actual recording times will vary depending on the free space available on the xD-Picture Card.

	640 (30 frames per second)	320 (30 frames per second)
DPC-16 (16 MB)	13 sec.	26 sec.
DPC-32 (32 MB)	27 sec.	54 sec.
DPC-64 (64 MB)	55 sec.	109 sec.
DPC-128 (128 MB)	111 sec.	219 sec.
DPC-256 (256 MB)	223 sec.	7.3 min.
DPC-512 (512 MB)	7.4 min.	14.6 min.

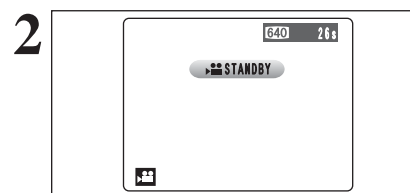

The available recording time and "STANDBY" appear on the screen.

- ⚠ Because sound is recorded concurrently with the images, make sure that you do not cover the microphone with a finger, etc. (→P.9).

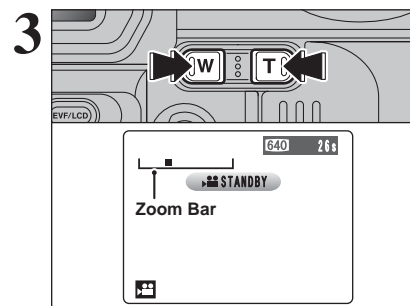

Press the "T" or "W" button to zoom in or out before recording. You must zoom beforehand as you cannot zoom during recording.

- **Optical zoom focal length (35 mm camera equivalent)**
Approx. 37 mm-370 mm
Max. zoom scale: 10x
- **Focal range**
Wide-angle: approx. 90 cm (3.0 ft.) to infinity
Telephoto: approx. 2.0 m (6.6 ft.) to infinity

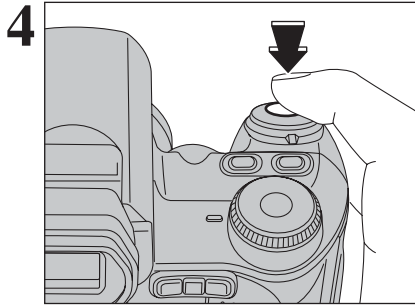

Press the shutter button down fully to start recording.

- ⚠ The brightness and color of the screen shown during movie recording may differ from those shown before recording begins.
- ⚠ There is no need to hold down the shutter button.

Pressing the shutter button down fully fixes the focus, however the exposure and white balance are adjusted for the scene being shot.

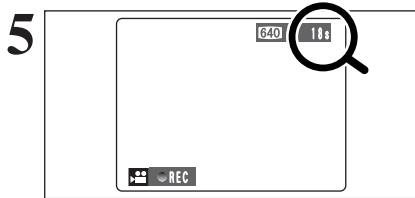

A counter appears in the top-right corner of the screen during recording. It shows the remaining time.

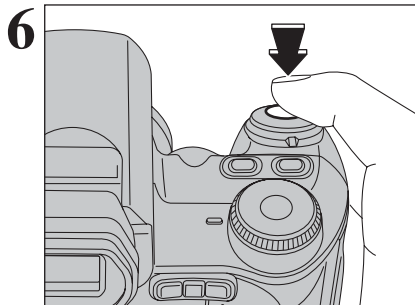

- ⚠ If the brightness of the subject changes during movie recording, the sound of lens operation may be recorded.
- ⚠ Some wind noise may be recorded in shots taken outdoors.
- ⚠ When the remaining time runs out, recording ends and the movie is saved onto the xD-Picture Card.



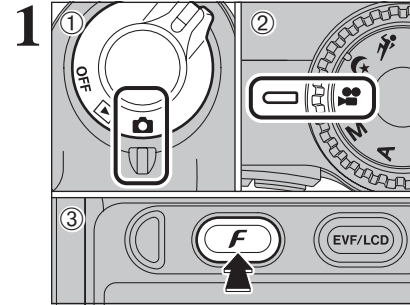

Press the shutter button during recording. Recording ends and the movie is stored on the xD-Picture Card.

- ⚠ If recording is stopped immediately after it begins, 1 second of movie is recorded onto the xD-Picture Card.



- ① Set the Power switch to .
- ② Set the Mode dial to .
- ③ Press the "F" button.

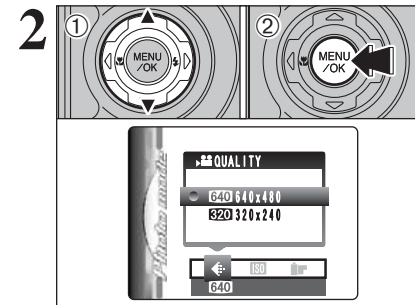

- ⚠ In  Movie mode, do not set the "ISO" (sensitivity) setting.
- ⚠ In  Movie mode, do not set the "FINEPIX COLOR" setting.

The quality setting is retained even when the camera is off or the Mode dial setting is changed.



- ① Press "▲" or "▼" to change the setting.
- ② Press the "MENU/OK" button to confirm the setting.

■ Quality settings

Quality mode	Sample uses
 (640 × 480)	for better quality
 (320 × 240)	to record longer movies

PLAYBACK MODE PLAYING BACK MOVIES

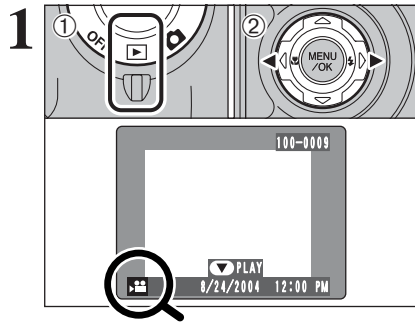

- 1 Set the Power switch to "▶".
- 2 Press "◀" or "▶" to select the movie file.

⚠ Movies cannot be played back using multi-frame playback. Press the "DISP/BACK" button twice to select single-frame playback.

Indicated by the "▶" icon.

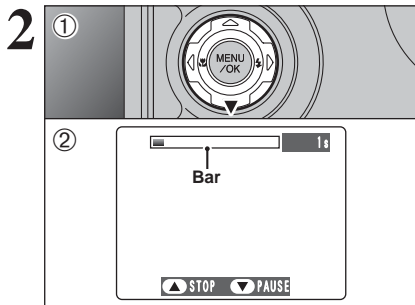

- 1 Press "▼" to play the movie.
- 2 The playback time appears on the screen along with a progress bar.

⚠ Take care not to block the speaker.
 ⚠ When the sound is difficult to hear, adjust the volume (→P.79).
 ⚠ If the subject of the shot is very bright, white vertical streaks or black horizontal streaks may appear in the image during playback. This is normal.

Movies are displayed one size smaller than still images.

■ Playing back movies

	Control	Description
Playback		Playback begins. Playback stops when the end of the movie is reached.
Pause/Resume		Pauses the movie during playback. Press "▼" again to resume playback.
Stop		Stops playback. * Press "◀" or "▶" while playback is stopped to go back to the previous file or advance to the next file respectively.
Fast forward/ Fast reverse	 Fast reverse Fast forward	Press "◀" or "▶" during playback to skip forwards or backwards through the movie.
Skip playback	 When paused	Press "◀" or "▶" when the movie is paused, the movie advances or goes back one frame. Hold down "◀" or "▶" to move through the frames quickly.

◆ Playing movie files ◆

- You may not be able to play some movie files recorded on other cameras.
- To play back movie files on a PC, save the movie file on the **xD-Picture Card** to the PC's hard disk and then play back the saved file.

4 Settings

ADJUSTING THE MONITOR BRIGHTNESS / VOLUME

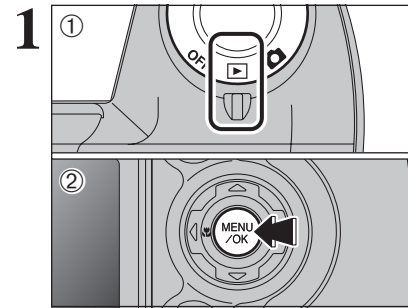

- 1 Set the Power switch to "▶" or "▶".
- 2 Press the "MENU/OK" button to display the menu on the screen.

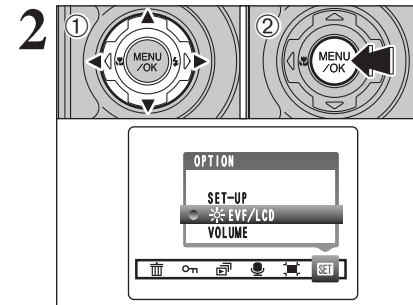

- 1 Press "◀" or "▶" to select "SET" OPTION and then press "▲" or "▼" to select "⚙ EVF/LCD" or "VOLUME".
- 2 Press the "MENU/OK" button.

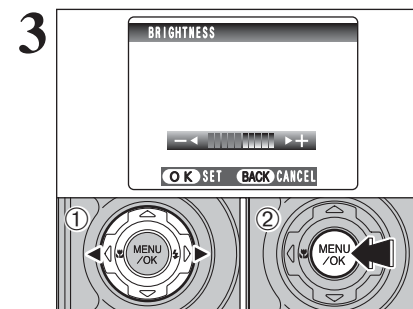

- 1 Press "◀" or "▶" to adjust the monitor brightness or the volume.
- 2 Press the "MENU/OK" button to confirm the new setting.

◆ SET-UP menu options ◆

The options available in the "SET" menu vary depending on whether the "▶" or "▶" mode is selected.

- "AUTO", "P", "S", "A", "M"
Photography mode

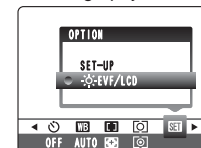

* In P, S, A, M

- "▶" Movie mode

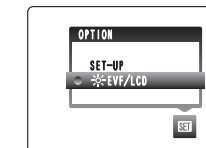

- "▶" Playback mode

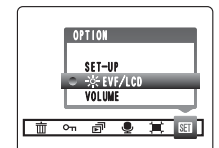

SET-UP

SET USING THE SET-UP SCREEN

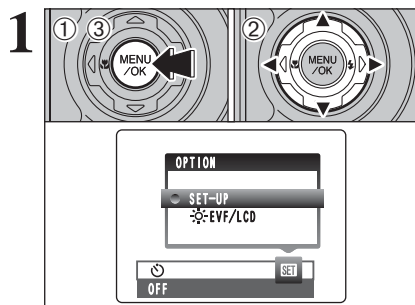

- Press the "MENU/OK" button to display the menu on the screen.
- Press "◀" or "▶" to select "SET" OPTION and then press "▲" or "▼" to select "SET-UP".
- Press the "MENU/OK" button to display the SET-UP screen.

Always turn the camera off when replacing the batteries. Opening the battery cover or disconnecting the AC power adapter without turning the camera off may cause the camera settings to revert to the factory default values set at shipment.

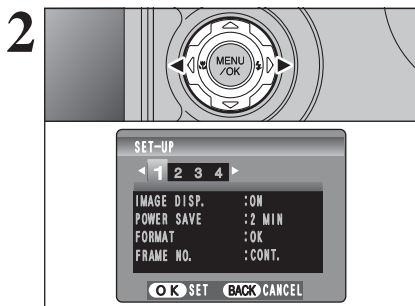

Press "◀" or "▶" to move to options 1 to 4.

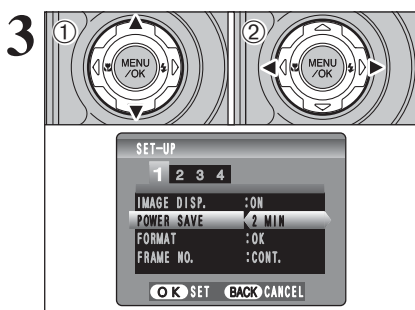

- Press "▲" or "▼" to select a menu option.
- Press "◀" or "▶" to change the setting. Press "▶" for "FORMAT", "DATE/TIME", "TIME DIFFERENCE", "DISCHARGE" or "RESET".

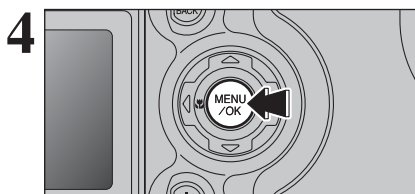

After you have changed the settings, press the "MENU/OK" button to confirm the changes.

SET-UP menu options

	Settings	Display	Factory default	Explanation	page
1	IMAGE DISP.	ON/OFF	ON	Specifies whether the preview images (the photographed images) are displayed after taking a picture.	–
	POWER SAVE	2 MIN/5MIN/OFF	2 MIN	Reduces the camera's power consumption and subsequently turns the camera off when not being used.	82
	FORMAT	OK	–	Erases all files.	82
	FRAME NO.	CONT./RENEW	CONT.	Specifies whether frame numbers are assigned consecutively from previous numbers or begin again.	85
2	BEEP	OFF/1/2/3	2	Sets the volume of the tone emitted when the camera controls are used.	–
	SHUTTER	OFF/1/2/3	2	Sets the volume of the sound emitted when the shutter operates.	–
	DATE/TIME	SET	–	Corrects the date or time.	15
	TIME DIFFERENCE	SET	–	Specifies the time difference settings.	83
3	AF ILLUMINATOR	ON/OFF	ON	Specifies whether the AF-assist illuminator is ON or OFF.	–
	ZOOM POSITION	RESET/RESUME	RESET	Specifies whether the position of the lens is recorded when the camera is turned off. The lens moves to the recorded position when turning the camera on again.	–
	USB MODE			: DSC (Mass storage device) mode This mode provides a simple way to read images from an xD-Picture Card and store images onto an xD-Picture Card . : WEB: WEB CAM (WEB Camera) mode This function allows you to conduct videoconferencing sessions between PCs connected to the Internet. * Windows XP SP1 only : PictBridge If a printer that supports PictBridge is available, images can be printed by connecting the camera directly to the PictBridge-compatible printer without using a PC.	96 95
	RAW CCD-RAW	OFF/ON	OFF	Sets the image quality to CCD-RAW. Because no image processing is performed on the camera for CCD-RAW images, images must be processed on a PC.	85
4	言語/LANG.	日本語/ENGLISH/ FRANCAIS/DEUTSCH/ ESPAÑOL/ITALIANO/ 中文	ENGLISH	Specifies the language used for screen display.	16
	VIDEO SYSTEM	NTSC/PAL	–	Specifies whether video output is set to NTSC or PAL.	–
	DISCHARGE	OK	–	Discharges rechargeable batteries.	109
	RESET	OK	–	Resets all the camera settings (other than the DATE/TIME, TIME DIFFERENCE, LANG. and VIDEO SYSTEM) to the factory default values set at shipment. A confirmation message appears when you press "▶". To reset the camera settings, press the "MENU/OK" button again.	–

POWER SAVE SETTING

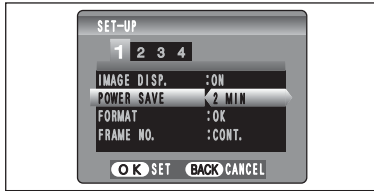

When this function is enabled and the camera is not used for 60 seconds, the screen temporarily turns off (sleep mode) and the indicator lamp blinks at 1-second intervals to save power. If the camera remains unused for 2 or 5 minutes, it is turned off. Use this function when you want to get the maximum possible running time from your batteries.

⚠ The Power save setting is disabled during automatic playback, discharging and when a USB connection is being used.

The Sleep function does not operate in SET-UP or Playback mode, but the camera will turn off if it is left unused for a set time (2 or 5 minutes).

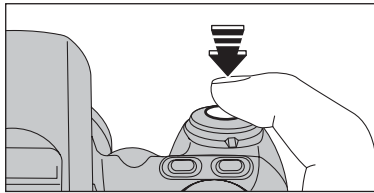

When the camera is in sleep mode, pressing the shutter button down halfway wakes the camera up.

⚠ Pressing any other button as well as the shutter button wakes the camera up.

◆ To restore power to the camera ◆

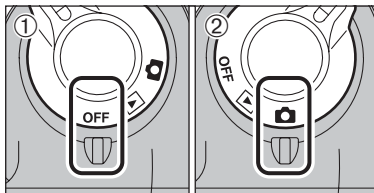

When the Power save function (2 or 5 minutes setting) has shut the camera down:

- ① Set the Power switch to "OFF".
- ② Set the Power switch back to "CAM" or "CAM".

FORMAT

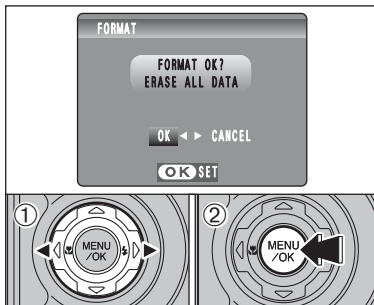

Initialize (format) the **xD-Picture Card** for use with the camera.

Because initializing the **xD-Picture Card** erases all the frames (files), including protected frames (files). Back up important frames (files) onto your PC or another media.

- ① Press "◀" or "▶" to select "OK".
- ② Pressing the "MENU/OK" button erases all the frames (files) and initializes the **xD-Picture Card**.

⚠ If "[CARD ERROR]", "[WRITE ERROR]", "[READ ERROR]" or "[CARD NOT INITIALIZED]" appears, see P.111-112 for information before formatting the **xD-Picture Card**.

WORLD TIME (TIME DIFFERENCE)

This function sets a time difference relative to the date and time currently set. When this setting is enabled, the specified time difference is applied when pictures are taken. Use this function when traveling to destinations in different time zones.

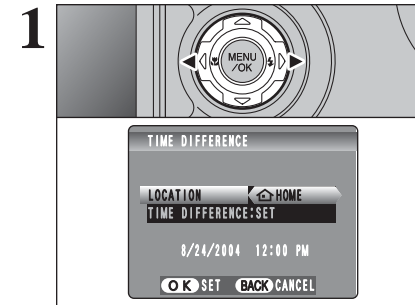

1 Press "◀" or "▶" to change between "HOME" and "LOCAL".
To set the time difference, select "LOCAL".
HOME: Your home time zone
LOCAL: Your destination time zone

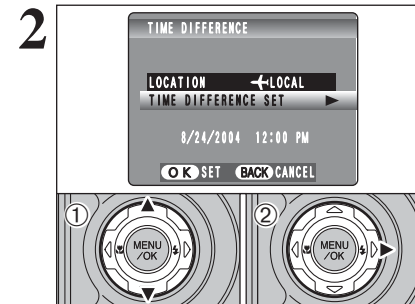

- ① Press "▲" or "▼" to select "TIME DIFFERENCE".
- ② Press "▶".

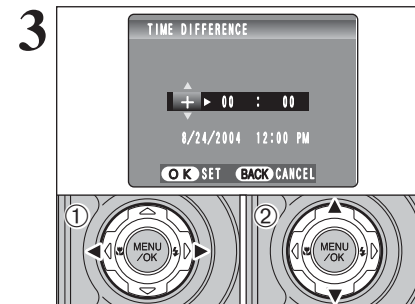

- ① Press "◀" or "▶" to select +, -, hour and minute.
 - ② Press "▲" or "▼" to correct the setting.
- Available time setting
-23:45 to +23:45 (in 15-minute increments)

SET-UP

* How to display the SET-UP menu (⇒P.80)

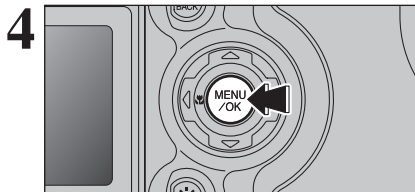

4 Always press the "MENU/OK" button after the settings are completed.

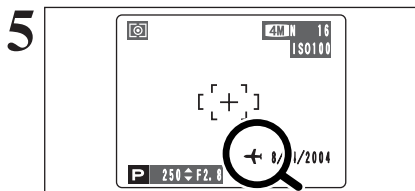

5 When the Photography mode is selected with world time set, "←" appears on the screen for 3 seconds.

Upon returning from a trip, always change the World time setting back to "HOME".

FRAME NO.

	< CONT. >	< RENEW >
A	0001	0001
	⋮	⋮
	0005	0005
↓		
B	0006	0001
	⋮	⋮
	0010	0005

* Formatted xD-Picture Card used for both A and B.

Specifies whether frame numbers are assigned consecutively from previous numbers or begin again.

CONT.: Pictures are stored beginning from the highest file number stored on the last xD-Picture Card used.

RENEW: Pictures are stored on each xD-Picture Card beginning with a file number "0001".

Setting this function to "CONT." makes file management easier as it makes sure that file names are not duplicated when images are downloaded to a PC.

When the camera settings are "RESET", the frame number setting ("CONT." or "RENEW") is changed to "CONT." and the frame number itself does not return to "0001".

When the xD-Picture Card already contains image files with file numbers higher than the highest file number on the last xD-Picture Card, images are stored beginning from the highest file number on the current xD-Picture Card.

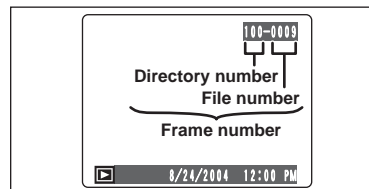

Check the file number by viewing the image. The last 4 digits of the 7-digit number in the top right corner of the screen are the file numbers, while the first 3 digits show the directory number.

When changing the xD-Picture Card, always turn the camera off before opening the battery cover. Opening the battery cover without turning the camera off may cause the frame number memory to not function.

File number runs from 0001 to 9999. Once 9999 is exceeded, the directory number changes from 100 to 101. The maximum number is 999-9999.

The displayed frame number may differ for images photographed on other cameras.

When "[FRAME NO. FULL]" appears, see P.111.

CCD-RAW

Setting CCD-RAW to ON disables the signal processing functions (reconstituting the data received from the CCD as an image) performed on the camera. Consequently, this task must be performed on the PC.

Use the bundled RAW FILE CONVERTER LE software to perform the processing on a PC. Conversion using RAW FILE CONVERTER LE also provides a simple way to create TIFF-format images.

* To rebuild images, FinePixViewer (on the bundled CD-ROM) must be installed on your PC.

■ The functions listed below cannot be used in CCD-RAW mode.

During shooting	Digital zoom, Continuous shooting and FinePix Photo mode (image quality, sensitivity (ISO 400) and FinePix COLOR) are unavailable.
During playback	Playback image quality is fixed at 1M (1280 × 960). Playback can be zoomed up to 800%, but trimmed images cannot be saved.

Pre-installation checklist

To run this software, you must have the hardware and software described below. Check your system before you begin the installation.

Operating System*1	Windows 98 (including the Second Edition) Windows Millennium Edition (Windows Me) Windows 2000 Professional*2 Windows XP Home Edition*2 Windows XP Professional*2
CPU	200 MHz Pentium or better recommended (800 MHz Pentium III or better recommended for Windows XP)
RAM	64MB minimum (128 MB minimum for Windows XP) Minimum 256 MB when RAW FILE CONVERTER LE is used
Hard disk space	Amount required for installation: 450 MB minimum Amount required for operation: 600 MB minimum (When using ImageMixer VCD2 for FinePix: 2 GB or better) Minimum 1 GB when RAW FILE CONVERTER LE is used
Display	800 × 600 pixels or better, 16-bit color or better (When using ImageMixer VCD2 for FinePix: 1024 × 768 or better)
Internet connection*3	<ul style="list-style-type: none"> To use the FinePix Internet Service or mail attachment function: An Internet connection or e-mail transmission software is needed Connection speed: 56 k or better recommended

*1 Models with one of the above operating systems pre-installed.

*2 When you install the software, log in using a system administrator account (e.g. "Administrator").

*3 Required to use the FinePix Internet Service. The software can still be installed even if you do not have an Internet connection.

Notes

- Connect the camera directly to the PC using the USB cable (mini-B). The software may not operate correctly when you use an extension cable or connect the camera via a USB hub.
- When your PC has more than one USB port, the camera can be connected to either port.
- Push the USB connector fully into the socket to ensure that it is securely connected. The software may not operate correctly if the connection is faulty.
- Additional USB interface board is not guaranteed.
- Windows 95 and Windows NT cannot be used.
- Operation is not guaranteed on home-built PCs or on PCs running updated operating system software.
- When you reinstall or remove FinePixViewer, the Internet menu and your user ID and password for the FinePix Internet Service are deleted from your PC. Click the [Register now] button, enter your registered user ID and password and download the menu again.
- To use Video Chat, a PC running Windows XP Professional (Service Pack 1) or Windows XP Home Edition (Service Pack 1) is required with a sound card, a connected microphone and speakers, and Windows Messenger 5.0 or later installed. When using a router, check that the router is compatible with Windows Messenger.

Do not connect the camera to your PC until the software installation is completed.

1 Install FinePixViewer as instructed in the Quick start guide.

Launching the installer manually

- 1 Double-click the "My Computer" icon.
* Windows XP users should click "My Computer" in the "Start" menu.
- 2 Right-click "FINEPIX" (CD-ROM drive) in the "My Computer" window and select "Open".
- 3 Double-click "SETUP" or "SETUP.exe" in the CD-ROM window.

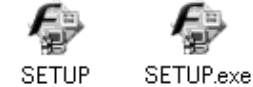

- * The way file names are displayed differs as described below depending on your PC settings.
 - File extensions (3-letter suffixes indicating the file type) may be shown or hidden. (e.g. Setup.exe or Setup)
 - Text may be shown normally or all in uppercase (e.g. Setup or SETUP).

Installing other applications

You may see messages for installing, ImageMixer VCD2 for FinePix and WINASPI. Install these applications as directed by the on-screen instructions. The installation screens for these applications are displayed as required.

2 After restarting the PC, install DirectX as directed by the on-screen instructions and then restart your PC again. If the latest version of DirectX is already installed on your PC, this installation is not performed.

- If the latest version is already installed, this window does not appear.
- Do not remove the CD-ROM during this procedure.

3 After restarting, the USB Video Class driver would be installed.

- If the latest version is already installed, this window does not appear.
- The driver is only installed on Windows XP SP 1.



4 After restarting the PC, a message appears stating "Installation of the FinePixViewer has been completed".

5.2 INSTALLATION ON A Mac OS 9.2

Pre-installation checklist

To run this software, you must have the hardware and software described below. Check your system before you begin the installation.

Compatible Mac	Power Macintosh G3*1, PowerBook G3*1, Power Macintosh G4, iMac, iBook, Power Macintosh G4 Cube or PowerBook G4
Operating System	Mac OS 9.2.2*2
RAM	64 MB minimum*3 Minimum 256 MB when RAW FILE CONVERTER LE is used (When using ImageMixer VCD2 for FinePix: 128 MB or better)
Hard disk space	Amount required for installation: 400 MB minimum Amount required for operation: 600 MB minimum (When using ImageMixer VCD2 for FinePix: 2 GB or better) Minimum 1 GB when RAW FILE CONVERTER LE is used
Display	800 × 600 pixels or better, at least 32,000 colors (When using ImageMixer VCD2 for FinePix: 1024 × 768 or better)
Internet connection*4	<ul style="list-style-type: none">To use the FinePix Internet Service or mail attachment functionAn Internet connection or e-mail transmission software is neededConnection speed: 56 k or better recommended

*1 Models with a USB port as a standard feature.

*2 This software does not run correctly in the Mac OS X Classic environment.

*3 Turn virtual memory on if necessary.

*4 Required to use the FinePix Internet Service. The software can still be installed even if you do not have an Internet connection.

Notes

- Connect the camera directly to the Macintosh using the USB cable (mini-B). The software may not operate correctly if you use an extension cable or connect the camera via a USB hub.
- Push the USB connector fully into the socket to ensure that it is securely connected. The software may not operate correctly if the connection is faulty.
- Additional USB interface board is not guaranteed.
- On Macintosh PCs, allocate at least 400 MB of virtual memory when RAW FILE CONVERTER LE is used. If other applications will be used at the same time, allocate the additional amount required for those applications also.

- Turn on your Macintosh and start up Mac OS 9.2.2.
 - Do not connect the camera to your Macintosh until the software installation is completed.
- When the bundled CD-ROM is loaded into the CD-ROM drive, the [FinePix] volume appears. Double-click the volume icon to open the volume window.
- Double-click "Installer for MacOS9" to launch the Installer.

- The Installer setup screen appears. Click the [Installing FinePixViewer] button.

- For more information on what is installed, click the [Read Me First] button and [Using FinePixViewer] button.



- A confirmation message appears asking whether you want to continue with the installation. Click the [OK] button.

- The User License Agreement for this software appears. Read the agreement carefully and then, if you agree to the terms of the Agreement, click the [Agree] button. If you click the [Disagree] button, the software is not installed.

- Select the installation destination for FinePixViewer.
 - Click the [Open] button to open the installation destination folder.

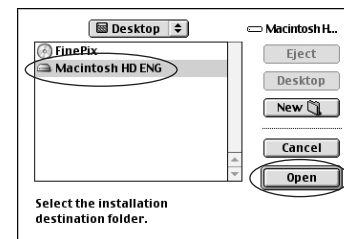

- Click the [Save] button.

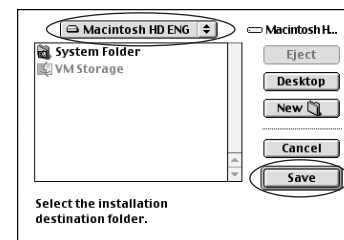

- Install ImageMixer VCD2 for FinePix as directed by the on-screen instructions.

5.2 INSTALLATION ON A Mac OS 9.2

- 9 After restarting the Macintosh, the “FinePixViewer installation completed” message appears. Click “Using FinePixViewer” to view the basic FinePixViewer functions.



- 10 To install Acrobat Reader, click “Install Acrobat Reader”.
 11 Install Adobe Systems’ Acrobat Reader software to read the FinePixViewer User’s Guide (PDF). If the latest version already has been installed, this step is not required.

- 11 Proceed with the installation as directed by the on-screen instructions.

◆ To install Acrobat Reader later... ◆

- ① Double-click the “FinePix” CD-ROM to open the CD-ROM window.
- ② Double-click “FinePixViewer for MacOS9” ⇒ “Acrobat Reader” ⇒ “English” folder.
- ③ Double-click “English Reader Installer”.
- ④ Proceed with the installation as directed by the on-screen instructions.

5.3 INSTALLATION ON A Mac OS X

Pre-installation checklist

■ Hardware and software requirements

To run this software, you must have the hardware and software described below. Check your system before you begin the installation.

Compatible Mac	Power Macintosh G3*1, PowerBook G3*1, Power Macintosh G4, iMac, iBook, Power Macintosh G4 Cube, or PowerBook G4, Power Macintosh G5
Operating System	Mac OS X (compatible with version 10.2.6 to 10.3.3)
RAM	192 MB minimum Minimum 256 MB when RAW FILE CONVERTER LE is used
Hard disk space	Amount required for installation: 200 MB minimum Amount required for operation: 400 MB minimum (When using ImageMixer VCD2 for FinePix: 2 GB or better) Minimum 1 GB when RAW FILE CONVERTER LE is used
Display	800 × 600 pixels or better, at least 32,000 colors (When using ImageMixer VCD2 for FinePix: 1024 × 768 or better)
Internet connection*2	<ul style="list-style-type: none"> • To use the FinePix Internet Service or mail attachment function • An Internet connection or e-mail transmission software is needed • Connection speed: 56 k or better recommended

*1 Models with a USB port as a standard feature

*2 Required to use the FinePix Internet Service. The software can still be installed even if you do not have an Internet connection.

◆ Notes ◆

- Connect the camera directly to the Macintosh using the USB cable (mini-B). The software may not operate correctly if you use an extension cable or connect the camera via a USB hub.
- Push the USB connector fully into the socket to ensure that it is securely connected. The software may not operate correctly if the connection is faulty.
- Additional USB interface board is not guaranteed.
- On Macintosh PCs, allocate at least 400 MB of virtual memory when RAW FILE CONVERTER LE is used. If other applications will be used at the same time, allocate the additional amount required for those applications also.

5.3 INSTALLATION ON A Mac OS X

1 Turn your Macintosh on and start up Mac OS X. Do not launch any other applications.

2 When the bundled CD-ROM is loaded into the CD-ROM drive, the “FinePix” icon appears. Double-click the “FinePix” icon to open the “FinePix” volume window.



3 Double-click on “Installer for MacOS X”.

4 The Installer setup dialog appears. Click the [Installing FinePixViewer] button.

For more information on what is installed, click the [Read Me First] button and [Using FinePixViewer] button.



5 The “Authenticate” dialog appears. Enter the name and password for the administrator account and then click the [OK] button.*

* The administrator account is the user account used for Mac OS X installation and you can confirm the user account in the Accounts dialog in the System Preferences.

6 The “License” dialog appears. Read the agreement carefully and then, if you agree to the terms of the Agreement, click the [Accept] button.

7 The “Read me” dialog appears. Click the [Continue] button.

8 The “FinePixInstallOSX” window appears. Click the [Install] button to install FinePixViewer and RAW FILE CONVERTER LE.



9 The ImageMixer VCD2 installer automatically starts up and a window showing the installation progress appears. (Installation may take several minutes.)

10 The “FinePixViewer installation completed” message dialog appears. Then click exit button and close it.

11 Launch “Image Capture” from the “Applications” folder.

12 Change the Image Capture settings. Select “Preferenes...” from the “Image Capture” menu.

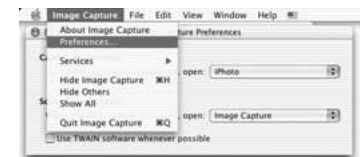

13 Select “Other...” from “When a camera is connected, open”.

14 Select “FPVBridge” from “FinePixViewer” folder in the “Applications” folder and click the [Open] button.



15 Select “Quit Image Capture” menu in the “Image Capture” menu.

6.1.1 Using the AC power adapter (sold separately)

Always use a FUJIFILM AC Power Adapter AC-5VH/AC-5VHS (⇒P.105). Use the AC power adapter to prevent losing power at inconvenient times, such as when downloading photographed images to your PC. You can take pictures and play back images without worrying about depleting the batteries.

⚠ Only connect or disconnect the AC power adapter when the camera is off. Connecting or disconnecting the AC power adapter while the camera is on temporarily interrupts the power supply to the camera, so that images or movies being shot are not recorded. Failing to turn the camera off first can also result in damage to the xD-Picture Card or malfunctions during PC connection.

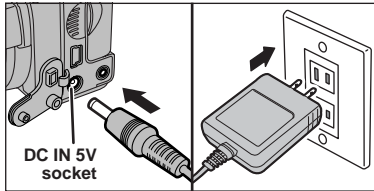

Check that the camera is off. Plug the AC power adapter connector into the "DC IN 5V" socket and then plug the AC power adapter into the power outlet.

- ⚠ The socket-outlet shall be installed near the equipment and shall be easily accessible.
- ⚠ The shape of the plug and socket-outlet depends on the country of use.
- ⚠ See P.108 for notes on using the AC power adapter.

Do not connect the AC power adapter to charge the Ni-MH batteries. Use the optional charger (⇒P.105) to charge the Ni-MH batteries.

6.1.2 Connecting to a TV

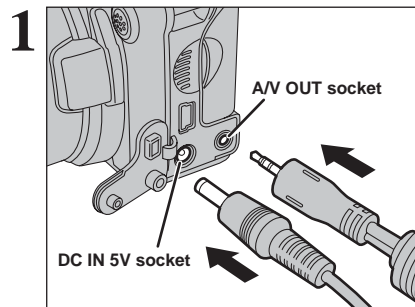

Turn off the camera and TV. Plug the A/V cable (included) into the "A/V OUT" (Audio/Visual output) socket.

- ⚠ When there is a power outlet available, connect the AC Power Adapter AC-5VH.

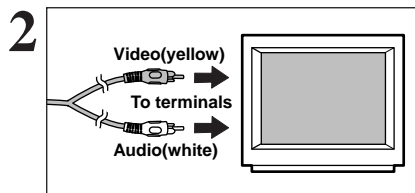

Plug the other end of the cable into the video/audio input socket on the TV. Then turn the camera and TV on and take pictures or play back images normally.

- ⚠ When connecting the A/V cable to TV, the LCD monitor is turned off.
- ⚠ Refer to the instructions provided with your TV for more information on video/audio input for your TV.

6.2.1 Connecting to a PC

The "Connecting to a PC" section explains how to connect the camera to your PC using the USB cable (mini-B) and describes the functions you can use once the camera and PC are connected.

If the power cuts out during data transmission, the data will not be transmitted correctly. Always use the AC power adapter when connecting the camera to a PC.

Refer to Section 5 the first time you connect the camera to your PC. Install the software first. Do not connect the camera to the PC before installing all the software.



CD-ROM
(Software for FinePix AX)

DSC (Mass storage device) mode

This mode provides a simple way to read images from an xD-Picture Card and store images onto an xD-Picture Card (⇒P.96).

WEB WEB CAM (Web Camera) mode

This function allows you to conduct videoconferencing sessions between PCs connected to the Internet.

- ⚠ The WEB Camera function can only be used on Windows XP SP1.
- ⚠ Microsoft Windows Messenger 5.0 or later is required to use the WEB Camera function. For downloading and using this software, please refer to the below explanation for "Using Video Chat with Windows Messenger" No.⑧. Please download it from the Messenger web site.
- ⚠ Images are not output to a TV.
- ⚠ When using Video Chat with the WEB Camera function, Windows XP SP1 is required also for your partner's OS.

Change between "DSC" and "WEB" in the camera's SET-UP screen.

Using Video Chat with Windows Messenger

Connecting camera to a PC

- 1 Plug the AC power adapter connector into the "DC IN 5V" socket on the camera and then plug the adapter into the power outlet.
- 2 Turn the Power switch to turn the camera on (⇒P.14).
- 3 Select "WEB" in "USB MODE" in the SET-UP menu (⇒P.80).
- 4 Turn the camera off (⇒P.14).
- 5 Turn your PC on.
- 6 Use the USB cable to connect the camera to your PC.
- 7 Turn the Power switch to turn the camera on (⇒P.14).
- 8 Using Video Chat with Windows Messenger, refer to "How to use FinePixViewer" in the HELP menu which was installed from the CD-ROM.

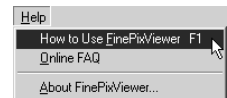

- ⚠ Make sure that the USB cable (mini-B) is connected correctly and pushed in.
- "WEB CAMERA" appears on the screen.
- ⚠ The screen darkens when the WEB Camera is used.
- Power save and Auto power off are disabled during USB connection.

Disconnecting the Camera

- 1 Quit all applications (FinePixViewer etc.) that are using the camera.
- 2 Turn the camera off (⇒P.14).
- 3 Unplug the USB cable from the camera.

6.2 CONNECTING TO A PC

USE AT DSC MODE

1 Set a camera

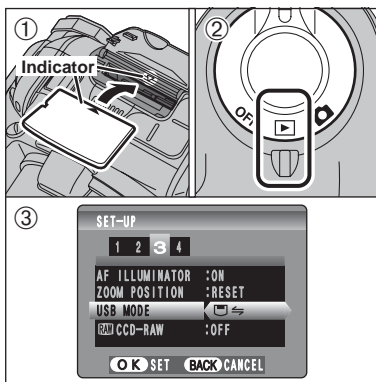

- 1 Insert an **xD-Picture Card** into the camera. Plug the AC power adapter connector into the "DC IN 5V" socket on the camera and then plug the adapter into the power outlet.
- 2 Turn the Power switch to turn the camera on.
- 3 Set the "USB MODE" setting in the "SET-UP" menu to "P.80". Turn the Power switch to turn the camera off.

⚠ If shutting off power supply during communication, the files on the **xD-Picture Card** may cause damage.

2 Connect a camera to a PC

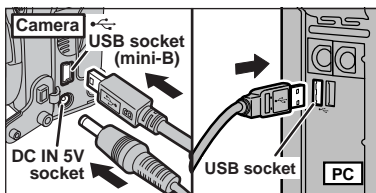

- 1 Turn your PC on.
- 2 Connect the camera to your PC using the USB cable (mini-B).
- 3 Turn the camera on.

⚠ Make sure that the USB cable (mini-B) is connected correctly and pushed in.

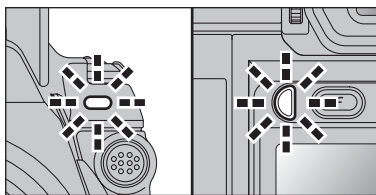

- When the camera and PC are exchanging data, the self-timer lamp blinks and the indicator lamp blinks alternately green and orange.
 - "DSC" appears on the screen.
 - Power save and Auto power off are disabled during USB connection.
- ⚠ Before replacing the **xD-Picture Card**, always disconnect the camera from the PC. See P.98 for information on the disconnection procedure.
- ⚠ Do not disconnect the USB cable (mini-B) when the camera is communicating with a PC. See P.98 for information on the disconnection procedure.

3 Set a PC

Windows 98 / 98 SE / Me / 2000 Professional / Macintosh

⚠ The Windows CD-ROM may also be required during installation. In this event, change CD-ROMs as directed by the on-screen instructions.

- FinePixViewer automatically starts up and the Save Image Wizard window (Save Image dialog box) appears. Follow the instructions provided on screen to save the images at this point. To proceed without saving the images, click the [Cancel] button.



* Screen for Windows 98 SE

- A removable disk icon appears and you can use your PC to transfer files to and from the camera.

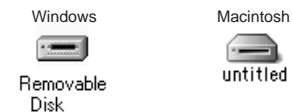

If the above operations do not occur, you do not have the required software programs or drivers installed on your PC. Complete the required PC setup procedures. Then reconnect the camera to your PC.

Windows XP

- 1 The "Found New Hardware" help message appears in the bottom-right corner of your screen. This message will close when the settings are completed. No action is required.



⚠ This step is not required for subsequent connections.

- 2 Specify the settings in the "AutoPlay" dialog box.
 - **When FinePixViewer is included in the list of actions to perform**
Select "Viewing images using FinePixViewer" and then select the "Always do the selected action" checkbox. This checkbox may not be shown in some cases. Click the [OK] button to launch FinePixViewer.
 - **When FinePixViewer is not included in the list of actions to perform**
Select "Take no action" and then select the "Always do the selected action" checkbox. This checkbox may not be shown in some cases. Click the [OK] button and launch FinePixViewer manually.
- 3 A new removable disk icon appears in the "My Computer" window. FinePixViewer automatically starts up and the Save Image Wizard window (Save Image dialog box) appears. Follow the instructions provided on screen to save the images at this point. To proceed without saving the images, click the [Cancel] button.

◆ Regarding the icons ◆

The next time you connect the camera, the removable disk drive icon's name changes to the "FinePix" icon and name.

Proceed to "USING FinePixViewer" on P.99.

6.2 CONNECTING TO A PC

6.2.2 Disconnecting the camera

1 Windows

Once the image has been saved, the "Remove Camera/Media" window appears (Save Image Wizard Windows). To disconnect the camera, click the [Remove] button.

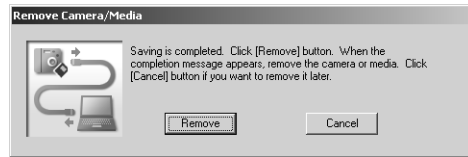

Macintosh

Once the image has been saved, the "Remove camera/media" window appears (Save Image dialog box). To disconnect the camera, click the [OK] button.

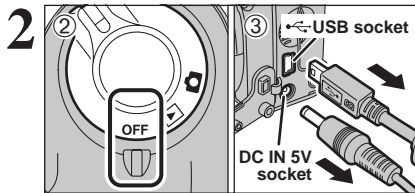

- ① When the "It is now safe to disconnect the camera" message appears, click the [OK] button and disconnect the camera.
- ② Turn the camera off.
- ③ Unplug the USB cable (mini-B) from the camera.

6.3 USING FinePixViewer

6.3.1 Mastering FinePixViewer

For all information on FinePixViewer functions, refer to "How to Use FinePixViewer" in the Help menu for details.

◆ Macintosh ◆

- **To read "How to Use FinePixViewer"...**
You must install Adobe Systems' Acrobat Reader. See P.90 for information on installing Acrobat Reader.
 - 🔧 For more information on using Acrobat Reader, refer to the Acrobat Reader "Help" menu.
- **What is explained in "How to Use FinePixViewer"...**
"How to Use FinePixViewer" covers a range of topics, including batch processing and ordering prints.

■ Example: Looking up slide shows

- ① Click "How to Use FinePixViewer" in the FinePixViewer Help menu.
- ② Click "Basic Operation" and then click "Basic Slide Show Operations" in the menu that appears.
- ③ The "Basic Slid Show Operations" information appears. Press the "<<<" key to view the previous page or the ">>>" key to view the next page.

6.3.2 Uninstalling the software

Only perform this operation when you no longer require the installed software or when the software was not installed correctly.

Windows

- ① Check that the camera is not connected to the PC.
- ② Quit all currently running applications.
- ③ Open the "My Computer" window. Then open the "Control Panel" and double-click on "Add/Remove Programs".
- ④ The "Add/Remove Programs Properties" window appears. Select the software to be uninstalled (FinePixViewer or the driver) and then click the [Add/Remove] button.

<To remove FinePixViewer>
FinePixViewer Ver.4.2
<To remove the driver software>
FUJIFILM USB Driver



6.3 USING FinePixViewer

- ⑤ When the message appears, click the [OK] button. Check your selection carefully since the process cannot be cancelled once you click the [OK] button.



- ⑥ Automatic uninstallation begins. When uninstallation ends, click the [OK] button.

Macintosh

Mac OS 9.2

■ Uninstalling Exif Launcher, FinePixViewer

- ① After you have quit Exif Launcher in "Exif Launcher Settings" in the FinePixViewer "Settings" menu, move the Exif Launcher file from the "Startup Items" folder in the System folder to the Trash. Then select "Empty Trash" in the "Special" menu.
- ② After you have exited FinePixViewer, drag the installed FinePixViewer folder to the Trash. Then click "Empty Trash" in the "Special" menu.

Mac OS X

■ Uninstalling FinePixViewer

Quit FinePixViewer. Then drag the installed FinePixViewer folder to the Trash and select "Empty Trash" in the "Special" menu.

6.4 CONNECTING THE CAMERA DIRECTLY TO THE PRINTER — PictBridge FUNCTION

When a printer that supports PictBridge is available, images can be printed by connecting the camera directly to the PictBridge-compatible printer without using a PC.

- ⚠ In PictBridge function, images photographed on other than a camera may not be printed.

6.4.1 Specifying images for printing on the camera

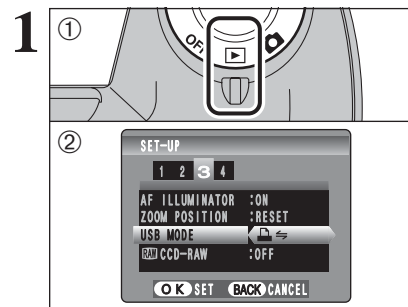

- ① Set the Power switch to "I" to turn the camera on.
- ② Select "PictBridge" in "USB MODE" in the "SET-UP" menu (P.80). Set the Power switch to "OFF" to turn the camera off.

- ⚠ Do not connect to a PC when the USB mode setting is set to "PictBridge". See P.114 if you connect to PC by mistake.

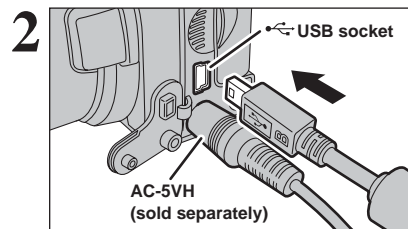

- ① Connect the camera to the printer using the USB cable (mini-B).
- ② Turn the printer on.

- ⚠ The camera cannot be used to specify printer settings such as the paper size and print quality.
- ⚠ Please connect the AC power adapter AC-5VH (sold separately) to your camera.
- ⚠ Use an xD-Picture Card that was formatted in the camera.

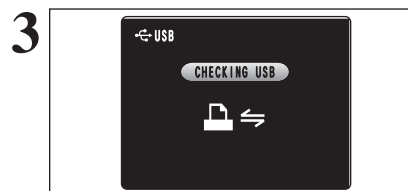

Set the Power switch to "I". "CHECKING USB" appears and then the menu is displayed on the screen.

- ⚠ If the menu does not appear, check whether the USB mode setting is "PictBridge".
- ⚠ Depending on the printer, some functions are disabled.

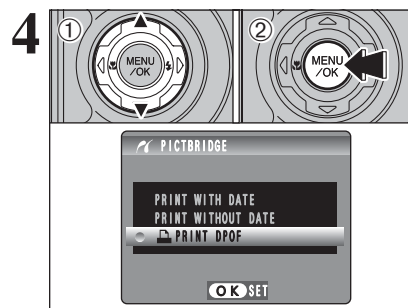

- ① Press "▲" or "▼" to select "PRINT DPOF".
- ② Press the "MENU/OK" button.

- ⚠ When "NOT SET DPOF" appears, the DPOF settings are not specified.
- ⚠ To use DPOF printing, the DPOF settings must be specified on FinePix S5100/FinePix S5500 beforehand (P.72).
- ⚠ Even when "WITH DATE" is specified in the DPOF settings, the date is not inserted from printers that do not support date printing.

6.4 CONNECTING THE CAMERA DIRECTLY TO THE PRINTER — PictBridge FUNCTION

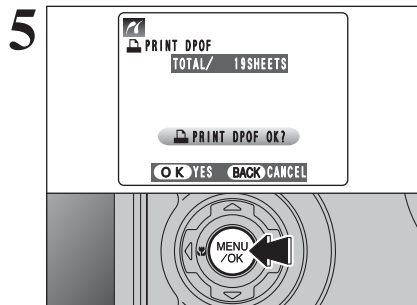

Press the "MENU/OK" button to download the data to the printer and print the frames specified in the DPOF settings.

⚠ Press the "DISP/BACK" button to cancel the printing. Depending on the printer, the printing may not be canceled immediately. Printing may stop midway through. When printing stops midway, briefly turn the camera off and then on again.

6.4.2 Specifying images for printing without using DPOF (single-frame printing)

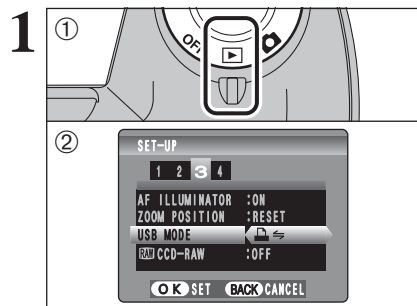

① Set the Power switch to "ON" to turn the camera on.
② Select "PictBridge" in "USB MODE" in the "SET-UP" menu (→P.80). Set the Power switch to "OFF" to turn the camera off.

⚠ Do not connect to a PC when the USB mode setting is set to "PictBridge". See P.114 if you connect to a PC by mistake.

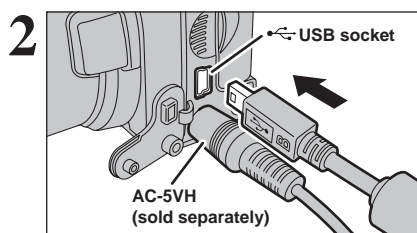

① Connect the camera to the printer using the USB cable (mini-B).
② Turn the printer on.

⚠ The camera cannot be used to specify printer settings such as the paper size and print quality.
⚠ Please connect the AC power adapter AC-5VH (sold separately) to your camera.
⚠ Use an xD-Picture Card that was formatted in the camera.

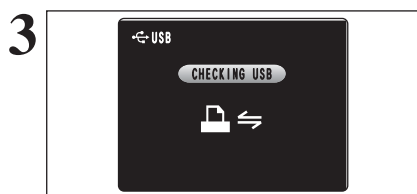

Set the Power switch to "ON".
"CHECKING USB" appears and then the menu is displayed on the screen.

⚠ If the menu does not appear, check whether the USB mode setting is "PictBridge".
⚠ Depending on the printer, some functions are disabled.

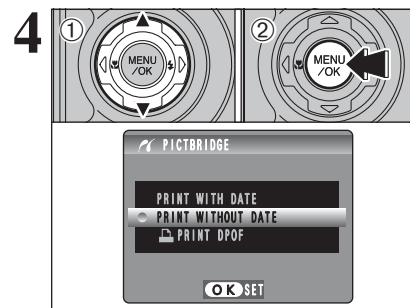

① Press "▲" or "▼" to select "PRINT WITH DATE" or "PRINT WITHOUT DATE". If "PRINT WITH DATE" is selected, the date is imprinted on your prints.
② Press the "MENU/OK" button.

⚠ "PRINT WITH DATE" is not available when the camera is connected to a printer that does not support date printing.

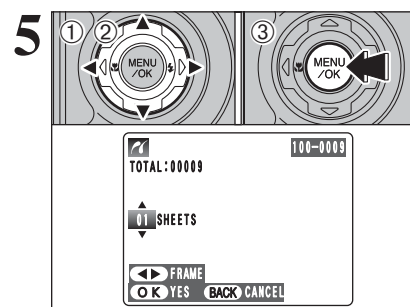

① Press "◀" or "▶" to display the frame (file) for specifying PRINT settings.
② Press "▲" or "▼" to set a value up to 99 as the number of copies of the frame (file) to be printed. For frames (files) that you do not want printed, set the number of prints to 0 (zero). To specify more PRINT settings, repeat steps ① and ②.
③ Always press the "MENU/OK" button after the settings are completed.

⚠ Movie images cannot be printed.

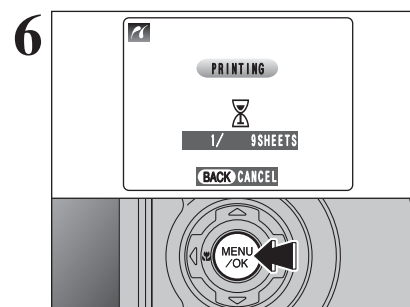

Press the "MENU/OK" button to download the data to the printer and start printing the specified number of prints.
To end printing, press the "DISP/BACK" button.

⚠ Press the "DISP/BACK" button to cancel the printing. Depending on the printer, the printing may not be canceled immediately. Printing may stop midway through. When printing stops midway, briefly turn the camera off and then on again.

◆ Disconnecting the printer ◆

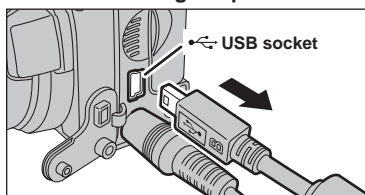

① Check that "PRINTING" is not displayed on the camera's screen.
② Turn the camera off. Unplug the USB cable.

System Expansion Options

- By using the FinePix S5100/FinePix S5500 together with other optional FUJIFILM products, your system can be expanded to fill a wide range of uses.

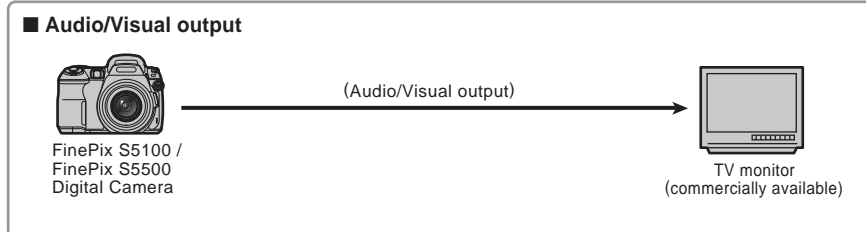
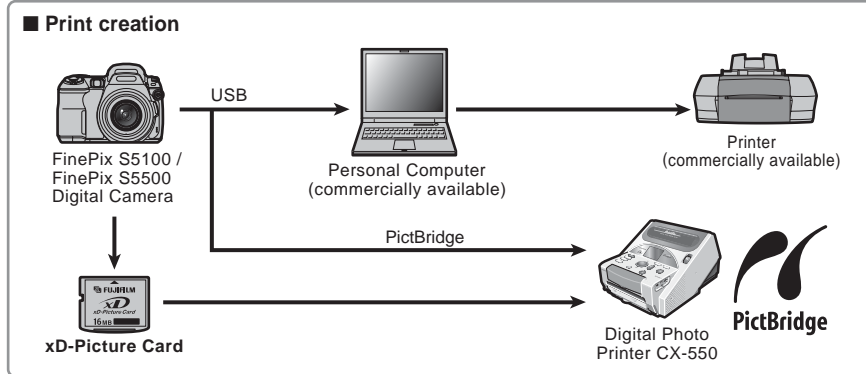
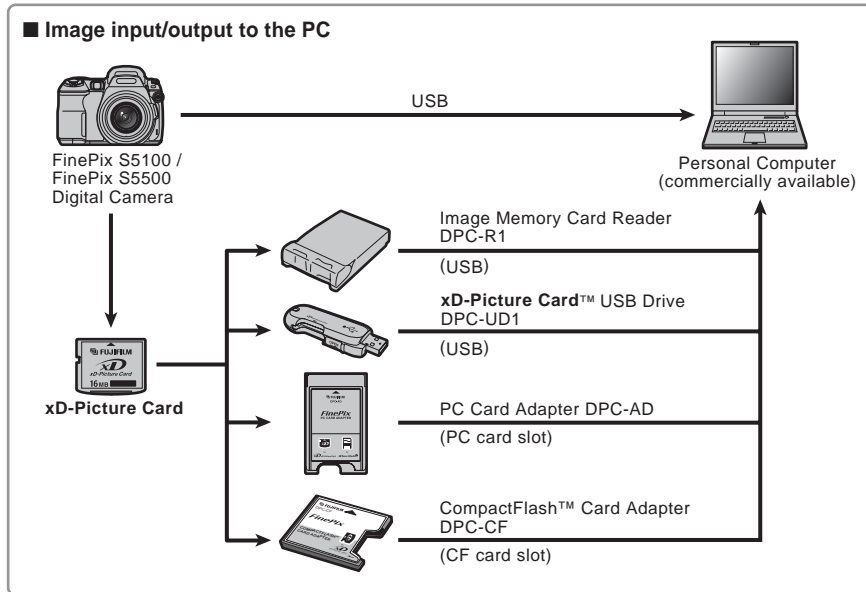

Accessories Guide

- The accessories (sold separately) can make taking pictures with the FinePix S5100/FinePix S5500 even easier. For information on how to attach and use the accessories, refer to the instructions provided with the accessory used. Visit the FUJIFILM web site for the latest information on camera accessories. <http://home.fujifilm.com/products/digital/index.html>

● xD-Picture Card

These are separately available xD-Picture Cards.

Use the following xD-Picture Card:

DPC-16 (16 MB)/DPC-32 (32 MB)/DPC-64 (64 MB)/DPC-128 (128 MB)/
DPC-256 (256 MB)/DPC-512 (512 MB)



● Rechargeable Battery 2HR-3UF (2x)

The 2HR-3UF includes 2 pieces of high-capacity AA-size Nickel-Metal Hydride (Ni-MH) batteries.

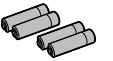

● Battery Charger with Battery BK-NH/BK-NH2 (With Euro type or UK type plug)

The BK-NH/BK-NH2 includes the quick battery charger BCH-NH/BCH-NH2 and 2 Ni-MH batteries. The BCH-NH/BCH-NH2 can charge 2 Ni-MH batteries in approximately 120 minutes. Up to 4 Ni-MH batteries can be charged simultaneously.

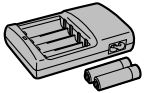

● AC Power Adapter AC-5VH/AC-5VHS

Use the AC-5VH/AC-5VHS when taking pictures or playing back images for long periods or when the FinePix S5100/FinePix S5500 is connected to a PC.

* The shape of the AC power adapter, the plug and socket outlet depend on the country.

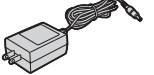

● Soft Case SC-FXS5

This is a special case made of Leather/Polyester that protects the camera against soil, dust and minor impacts when it is being carried.

● Image Memory Card Reader DPC-R1

The DPC-R1 provides a quick and easy way to transfer images back and forth between your PC and an image memory card (xD-Picture Card and SmartMedia). The DPC-R1 uses the USB interface for high-speed file transfer.

● Compatible with Windows 98/98 SE, Windows Me, Windows 2000 Professional, Windows XP or iMac, Mac OS 8.6 to 9.2, Mac OS X (10.1.2 to 10.2.2) and models that support USB as standard.

● Compatible with xD-Picture Cards of 16 MB to 512 MB, and SmartMedia of 3.3 V, 4 MB to 128 MB.

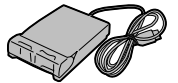

● PC Card Adapter DPC-AD

The PC Card Adapter allows the xD-Picture Card and SmartMedia to be used as a PC Card Standard ATA-compliant (PCMCIA 2.1) PC card (Type II).

● Compatible with xD-Picture Card of 16 MB to 512 MB, and SmartMedia of 3.3 V, 2 MB to 128 MB.



● CompactFlash™ Card Adapter DPC-CF

Loading an xD-Picture Card into this adapter allows you to use the card as a CompactFlash card (Type I).

● Windows 95/98/98 SE/Me/2000 Professional/XP

● Mac OS 8.6 to 9.2/X (10.1.2 to 10.1.5)



● xD-Picture Card™ USB Drive DPC-UD1

This is a compact card reader for xD-Picture Cards. Simply plug the drive into the USB port to read and write data to an xD-Picture Card (No driver installation is required except on Windows 98/98 SE).

● Compatible with xD-Picture Card of 16 MB to 512 MB

● Windows 98/98 SE/Me/2000 Professional/XP

● Mac OS 9.0 to 9.2/X (10.0.4 to 10.2.6)



Conversion Lens Guide (sold separately)

Wide conversion lens WL-FX9/WL-FX9B

Changes the focal length by a factor of 0.79× (wide-angle: equivalent to 29 mm) without altering the F-stop value of the lens.

● Wide conversion lens specifications

Magnification: 0.79×

Lens configuration: 3 lenses in 3 groups

Shooting range: approx. 90 cm (3.0 ft.) to infinity

Dimensions: 70 mm (2.76 in.) dia. × 32 mm (1.26 in.)

Mass (Weight): approx. 185 g (6.5 oz.)

Accessories: Adapter ring AR-FX9 (see below remarks),

Lens caps (front and rear), Lens pouch

* Except for body color, the specifications of the WL-FX9 and WL-FX9B are the same.

WL-FX9: Silver

WL-FX9B: Black

⚠ The adapter ring enclosed with the FinePix S5100/FinePix S5500 (AR-FX5A) should be used with this conversion lens. The adapter rings provided with these conversion lenses (AR-FX9 for FinePix 4900 zoom/6900 zoom/S602 zoom/S7000/S20 Pro) cannot be used with the FinePix S5100/FinePix S5500.

⚠ Only use the wide conversion lens at the wide-angle zoom setting.

⚠ The built-in flash cannot be used when the wide conversion lens is mounted.

⚠ Commercially available filters can be mounted on the lens when the adapter ring is attached, but no more than one filter should be mounted at a time.

Teleconversion lens TL-FX9/TL-FX9B

Changes the focal length by a factor of 1.5× (telephoto: equivalent to 555 mm) without altering the F-stop value of the lens.

● Teleconversion lens specifications

Magnification: 1.5×

Lens configuration: 3 lenses in 3 groups

Shooting range: approx. 5.0 m (16.4 ft.) to infinity

Dimensions: 65 mm (2.56 in.) dia. × 55 mm (2.17 in.)

Mass (Weight): approx. 100 g (3.5 oz.)

Accessories: Adapter ring AR-FX9 (see below remarks),

Lens caps (front and rear), Lens pouch

* Except for body color, the specifications of the TL-FX9 and TL-FX9B are the same.

TL-FX9: Silver

TL-FX9B: Black

⚠ The adapter ring enclosed with the FinePix S5100/FinePix S5500 (AR-FX5A) should be used with this conversion lens. The adapter rings provided with these conversion lenses (AR-FX9 for FinePix 4900 zoom/6900 zoom/S602 zoom/S7000/S20 Pro) cannot be used with the FinePix S5100/FinePix S5500.

⚠ Only use the tele conversion lens at the telephoto zoom setting.

⚠ The built-in flash cannot be used when the teleconversion lens is mounted.

⚠ Commercially available filters can be mounted on the lens when the adapter ring is attached, but no more than one filter should be mounted at a time.

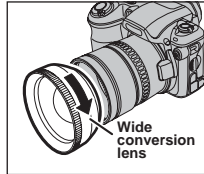

Mount the Wide conversion lens by screwing in the direction of arrow.

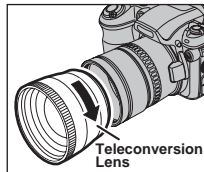

Mount the Teleconversion lens by screwing in the direction of arrow.

Using Your Camera Correctly

▶ Read this information and the “Safety Notes” (→P.118), to make sure you use your camera correctly.

■ Places to Avoid

Do not store or use the camera in the following types of locations:

- In the rain or in very humid, dirty or dusty places
- In direct sunlight or in places subject to extreme temperature, such as in a closed car in summer
- Extremely cold places
- Places with strong vibration
- Places with smoke or steam
- Places subject to strong magnetic fields (such as near motors, transformers or magnets)
- In contact with chemicals such as pesticides
- Next to rubber or vinyl products

■ Damaged by Water or sand

The FinePix S5100/FinePix S5500 can be damaged on the inside and outside by water and sand. When you are at the beach or close to water, make sure that the camera is not damaged by water or sand. Take care not to place the camera on a wet surface.

■ Damaged by Condensation

If the camera is carried from a cold location into a warm place, water droplets (condensation) may form on the inside of the camera or on the lens. When this occurs, turn the camera off and wait an hour before using the camera. Condensation may also form on the xD-Picture card. In this event, remove the xD-Picture

card and wait a short time.

■ When the Camera is Not Used or is stored Periods of Time

If you do not intend to use the camera for a long period of time, remove the batteries and the xD-Picture card.

■ Cleaning Your Camera

- Use a blower brush to brush away any dust on the lens, LCD monitor, viewfinder and then gently wipe the camera with a soft, dry cloth. If any soil remains, apply a small amount of lens cleaning liquid to a piece of FUJIFILM lens cleaning paper and wipe gently.
- Do not scratch hard objects against the lens, LCD monitor or viewfinder.
- Clean the body of the camera with a soft, dry cloth. Do not use volatile substances or cleaning products these items can cause damage.

■ Using the Camera When Traveling

When traveling overseas, do not place your camera in the check-in baggage. Baggage can be subjected violent shocks, and the camera may be damaged inside or outside.

Power Supply and Batteries

Applicable Batteries

- In the camera, use AA-size alkaline or nickel-metal hydride (Ni-MH) batteries.
- Do not use AA-size manganese or nickel-cadmium (Ni-Cd) batteries in your FinePix S5100/FinePix S5500 because the heat created by the batteries could damage the camera or cause it not to work.
- The life of alkaline batteries varies between brands. The life of batteries you purchase may be shorter than those provided with the camera.

Notes on the Batteries

Incorrect use of the batteries could cause them to leak, become hot, ignite or burst. Always observe the precautions given below.

- Do not heat the batteries or throw them into a fire.
- Do not carry or store batteries with metal objects such as necklaces or hairpins.
- Do not expose the batteries to water, and keep batteries from getting wet or stored in moist locations.
- Do not attempt to take apart or change the batteries, including battery casings.
- Do not subject the batteries to strong impacts.
- Do not use batteries that are leaking, deformed, discolored.
- Do not store batteries in warm or humid places.
- Keep the batteries out of reach of babies and small children.
- Make sure that the battery polarity (⊕ and ⊖) is correct.

- Do not use new with used batteries. Do not use charged and discharged batteries together.
- Do not use different types or brands of batteries at the same time.
- If you do not intend to use the camera for a long period of time, remove the batteries from the camera. Note if the camera is left with the batteries removed, the time and date settings are cleared.
- The batteries feel warm right after being used. Before removing the batteries, turn the camera off and wait for the batteries to cool down.
- Since batteries do not work well in cold weather or locations, warm the batteries by placing them inside your garments before use. Batteries do not work well when cold. They will work again when the temperature returns to normal.
- Soil (such as fingerprints) on the battery terminals makes the batteries charge less reducing the number of images. Carefully wipe the battery terminals with a soft dry cloth before loading.

⚠ If any liquid at all leaks from the batteries, wipe the battery compartment thoroughly and then load new batteries.

⚠ If any battery fluid comes into contact with your hands or clothing, flush the area thoroughly with water. Note that battery fluid can cause loss of eyesight if it gets into your eyes. If this occurs, do not rub your eyes. Flush the fluid out with clean water and contact your physician for treatment.

Power Supply and Batteries

Using the AA-size Ni-MH batteries correctly

- As a power source in digital cameras, AA-size Ni-MH batteries (referred to hereafter as Ni-NH batteries) are superior to alkaline batteries in several ways, such as allowing more shots to be taken with the camera. However, care must be taken with the way Ni-MH batteries are used if their original performance is to be maintained.
- Ni-MH batteries left unused in storage for long periods can become "deactivated". Also, repeatedly charging Ni-MH batteries that are only partially discharged can cause them to suffer from the "memory effect".
- Ni-MH batteries that are "deactivated" or affected by "memory" suffer from the problem of only providing power for a short time after being charged. To prevent this problem, discharge and recharge them several times using the camera's "Discharging rechargeable batteries" function. By repeating this cycle several times, the temporary reduction in performance caused by "memory" or "deactivation" can be remedied and the batteries can be restored to their original performance levels.
- Deactivation and memory are specific to Ni-MH batteries and are not in fact battery faults. See P.109 for the procedure for "Discharging rechargeable batteries".

Do not use the "Discharging rechargeable batteries" function when alkaline batteries are being used.

- To charge Ni-MH batteries, use the quick battery charger (sold separately). Refer to the instructions supplied with the charger to make sure that the charger is used correctly.
- Do not use the battery charger to charge other batteries.
- Note that the batteries feel warm after being charged.
- Due to the way the camera is constructed, a small amount of current is used even when the camera is turned off. Note in particular that leaving Ni-MH batteries in the camera for a long period will overdischarge the batteries and may render them unusable even after recharging.
- Ni-MH batteries will self-discharge even when not used, and the time for which they can be used may be shortened as a result.
- Ni-MH batteries will deteriorate rapidly if overdischarged (eg. by discharging the batteries in a flashlight). Use the "Discharging rechargeable batteries" function provided in the camera to discharge the batteries.
- Ni-MH batteries have a limited service life. If a battery can only be used for a short time even after repeated discharge-charge cycles, it may have reached the end of its service life.

Disposing of Batteries

When disposing of batteries, do so in accordance with your local waste disposal regulations.

AC Power Adapter

Always use the AC Power Adapter AC-5VH/AC-5VHS with the camera.

The use of an AC Power adapter other than AC-5VH/AC-5VHS can cause damage to your digital camera.

- Use the AC power adapter for indoor use only.
- Plug the connection cord plug securely into the DC input terminal of the FUJIFILM Digital camera.
- Turn off the FUJIFILM Digital camera before disconnecting the cord from the FUJIFILM Digital camera's DC input terminal. To disconnect, pull out the plug gently. Do not pull on the cord.
- Do not use the AC power adapter with any device other than your camera.
- During use, the AC power adapter will become hot to the touch. This is normal.
- Do not take apart the AC power adapter. Doing so could be dangerous.
- Do not use the AC power adapter in a hot humid place.
- Do not subject the AC power adapter to strong shocks.
- The AC power adapter may emit a humming. But this is normal.
- If used near a radio, the AC power adapter may cause static. If this happens, move the camera away from the radio.

Procedure for discharging rechargeable Ni-MH batteries

The "Discharging rechargeable batteries" function can only be used with Ni-MH batteries.

The "Discharging rechargeable batteries" function should not be used with alkaline batteries as it will completely drain the battery charge.

Use the "Discharging rechargeable batteries" function in the following situations:

- When the batteries can only be used for a short time after being charged normally
- When the batteries have not been used for a long period
- When you purchase new Ni-MH batteries

Do not use the "Discharging rechargeable batteries" function while using the AC power adapter. In these situations, the Ni-MH batteries will not be discharged due to the external power supply.

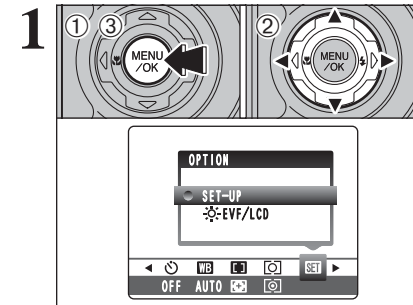

- Press the "MENU/OK" button.
- Press "◀" or "▶" to select "SET-UP" OPTION and then press "▲" or "▼" to select "SET-UP".
- Press the "MENU/OK" button.

Do not use the procedure for discharging rechargeable batteries with alkaline batteries.

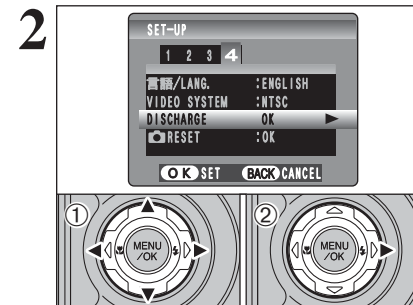

- Press "◀" or "▶" to move to option 4 and then press "▲" or "▼" to select "DISCHARGE".
- Press "▶".

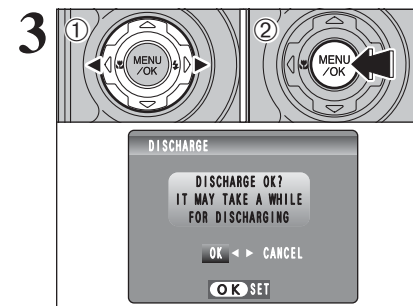

- Press "◀" or "▶" to select "OK".
 - Press the "MENU/OK" button.
- The screen changes and discharging begins. When the battery level indicator blinks red and discharging ends, the camera turns off.

Discharging takes a maximum of 15 hours.
To cancel discharging, press the "DISP/BACK" button.

Notes on the xD-Picture Card™

■ Image Memory Card

- This Image Memory Card is a new image recording media (**xD-Picture Card**) developed for digital cameras. The Image Memory Card consists of a semiconductor memory (NAND-type flash memory) to record digital image data. The recording process is electrically performed and enables erasure of existing image data as well as re-recording of new image data.
- When using a new Memory Card, or a Memory Card that has been formatted by a PC, be sure to format the card with your digital camera before using it.

■ Protecting Your Data

- Images and movies may be lost or destroyed in the following situations. Please note that FUJIFILM assumes no responsibility for data that is lost or destroyed.
 1. Removal of the memory card or turning the power off while the memory card is being accessed (i.e., during record, erase, initialization, and playback operations).
 2. Improper handling and use of the memory card by the user or third party.
- Save your important data to another media (i.e., MO disk, CD-R, hard disk, etc.).

■ Handling xD-Picture Card

- When storing **xD-Picture Cards**, make sure that they are kept out of the reach of children. An **xD-Picture Card** could be swallowed cause suffocation. If a child swallows an **xD-Picture Card**, seek medical attention or call emergency number right away.
- When inserting the **xD-Picture Card** into the camera, hold the **xD-Picture Card** straight as you push it in.
- Do not expose an **xD-Picture Card** to shock. Do not apply pressure, and avoid bending.
- Do not use or store **xD-Picture Card** in hot humid places.
- Clean the **xD-Picture Card** with a soft dry piece of cloth when dirty.
- When carrying or storing an **xD-Picture Card**, keep it in the special protective case.
- The **xD-Picture Card** will work well for long time, but will sooner or later lose its ability to store and play back images or movies. If this happens replace it with a new **xD-Picture Card**.
- Never remove the **xD-Picture Card** or turn the camera off during data recording or erasing (**xD-Picture Card** formatting) as this could be damaged to the **xD-Picture Card**.
- The use of **xD-Picture Cards** is recommended with the FinePix S5100/FinePix S5500. The recording quality cannot be guaranteed when **xD-Picture Cards** other than those manufactured by FUJIFILM are used.
- The **xD-Picture Card** may feel warm when it is removed from the camera after taking pictures. This is normal.
- Do not put labels on the **xD-Picture Card**. Peeling labels can cause the camera not to work properly.

■ Using xD-Picture Card with a PC















- When taking pictures using an **xD-Picture Card** that has been used on a PC, reformat the **xD-Picture Card** using your camera for best quality.
- When formatting an **xD-Picture Card**, a directory (folder) is created. Image data is then recorded in this directory.
- Do not change or delete the directory (folder) or file names on the **xD-Picture Card** because this will make it impossible to use the **xD-Picture Card** in your camera.
- Always use the camera to erase image data on an **xD-Picture Card**.
- To edit image data, copy the image data to the PC and edit the copy.

■ Specifications





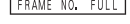







Type	Image memory card for digital cameras (xD-Picture Card)
Memory type	NAND-type flash memory
Conditions for use	Temperature: 0°C to +40°C (+32°F to +104°F) Humidity: 80% max. (no condensation) 25 mm × 20 mm × 2.2 mm (0.98 in. × 0.79 in. × 0.09 in.) (W × H × D)
Dimensions	

Warning Displays

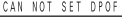
▶ The table below lists the warnings that are displayed on the LCD monitor.

Warning Displayed	Explanation	Remedy
 (Lit red)  (Blinking red)	The camera batteries are low or completely out of charge.	Load new or fully charged batteries.
	There is a strong likelihood of camera shake because the shutter speed is slow.	Use flash photography. However, use a tripod for some scenes and modes.
Aperture/Shutter speed display (Lit red)	Outside the AE continuous range.	The picture can be taken, but the correct brightness (exposure) will not be obtained.
	The AF (autofocus) cannot work effectively.	<ul style="list-style-type: none"> ● If the image is too dark, take the picture at a distance of around 2 m (6.6 ft.) from the subject. ● Use AF lock to take the picture.
 	Camera malfunction or fault.	<ul style="list-style-type: none"> ● Turn the camera on again, taking care not to touch the lens. ● Turn the camera off and on again. If the message still appears, contact your FUJIFILM dealer.
	No xD-Picture Card is inserted.	Insert an xD-Picture Card .
	<ul style="list-style-type: none"> ● The xD-Picture Card is not formatted. ● The xD-Picture Card contact area is soiled. 	<ul style="list-style-type: none"> ● Format the xD-Picture Card on the camera. ● Wipe the contact area on the xD-Picture Card with a soft dry cloth. It may be necessary to format the xD-Picture Card. If the message still appears, replace the xD-Picture Card. ● Contact your FUJIFILM dealer.
	<ul style="list-style-type: none"> ● The xD-Picture Card contact area is soiled. ● The xD-Picture Card is damaged. ● The xD-Picture Card format is incorrect. ● Camera fault. 	<ul style="list-style-type: none"> ● Wipe the contact area on the xD-Picture Card with a soft dry cloth. It may be necessary to format the xD-Picture Card. If the message still appears, replace the xD-Picture Card. ● Contact your FUJIFILM dealer.
	The xD-Picture Card is full.	Erase some images or use an xD-Picture Card that has ample free space.
	<ul style="list-style-type: none"> ● The data could not be recorded due to an xD-Picture Card error or a connection error between the xD-Picture Card and camera. ● The image cannot be recorded as it is too large to fit in the available space on the xD-Picture Card. 	<ul style="list-style-type: none"> ● Re-insert the xD-Picture Card or turn the camera off and then on again. If the message still appears, contact your FUJIFILM dealer. ● Use a new xD-Picture Card.
	The timing for recording was incorrect because the xD-Picture Card was formatted on a PC.	Use an xD-Picture Card that was formatted on the camera.
	The frame number has reached 999-9999.	<ol style="list-style-type: none"> ① Insert a formatted xD-Picture Card into the camera. ② Set "RENEW" as the FRAME NO. setting in the "SET-UP" menu. ③ Start taking pictures (The frame numbers start from "100-0001") ④ Set "CONT." as the FRAME NO. setting in the "SET-UP" menu.
 	CCD-RAW is set to "ON" in the "SET-UP" menu.	Set CCD-RAW to "OFF" in the "SET-UP" menu (⇒P.81).

Warning Displays

Warning Displayed	Explanation	Remedy
	<ul style="list-style-type: none"> The played back file was not recorded correctly. The xD-Picture Card contact area is soiled. Camera fault. An attempt was made to play a movie that was not recorded on this camera. 	<ul style="list-style-type: none"> Images cannot be played back. Wipe the contact area on the xD-Picture Card with a soft dry cloth. It may be necessary to format the xD-Picture Card. If the message still appears, replace the xD-Picture Card. Contact your FUJIFILM dealer. Movies cannot be played back.
	<ul style="list-style-type: none"> A protected file was encountered. An attempt was made to add a voice memo to protected file. 	<ul style="list-style-type: none"> Protected files cannot be erased. Remove the protection. Protected files cannot be added to voice memos. Remove the protection.
	<ul style="list-style-type: none"> The voice memo file is faulty. Camera fault. 	<ul style="list-style-type: none"> The voice memo cannot be played back. Contact your FUJIFILM dealer.
 	An attempt was made to trim a 0.3M image or an image shot using the RAW setting.	The image cannot be trimmed.
	<ul style="list-style-type: none"> An attempt was made to trim an image shot using a camera other than FinePix S5100/FinePix S5500. The image is damaged. 	The image cannot be trimmed.
	Prints were specified for 1000 or more frames in the DPOF frame settings.	The maximum number of frames for which prints can be specified on the same xD-Picture Card is 999. Copy the images for which you want to order prints onto another xD-Picture Card and then specify the DPOF settings.
 	An attempt was made to specify DPOF settings for an image that is not supported by DPOF.	DPOF printing cannot be used with this image format.
	The camera is not connected to PC or printer.	<ul style="list-style-type: none"> Check that the USB cable (mini-B) is connected correctly. Check that your printer is turned on.
	Displayed for PictBridge.	<ul style="list-style-type: none"> Check that the printer is not out of paper or out of ink. Turn the printer off briefly and then turn it back on. Refer to the user manual supplied with your printer.
	Displayed for PictBridge.	Check that the printer is not out of paper or out of ink. Printing automatically restarts when the error is cleared. If the message still appears after checking, press the "MENU/OK" button to restart printing.
	Displayed for PictBridge.	<ul style="list-style-type: none"> Refer to the user manual for the printer being used and check whether the printer supports the JFIF-JPEG or Exif-JPEG image format. If not, the printer cannot print the images. Movie images cannot be printed. Was the image data photographed using FinePix S5100/FinePix S5500? You may not be able to print some images photographed on other cameras.
	Displayed for PictBridge.	This message appears when printing is performed from a FUJIFILM printer that supports PictBridge. Refer to the Owner's Manual for the printer for details.

Troubleshooting

► If you think the camera is faulty, check the following once more.

Troubleshooting	Possible causes	Solutions
No power.	<ul style="list-style-type: none"> The batteries have run out. The batteries are loaded backward. The battery cover is not closed correctly. The AC power adapter plug has come out of the power outlet. 	<ul style="list-style-type: none"> Load new or fully charged batteries. Load the batteries in the correct direction. Close the battery cover correctly. Plug the adapter back in.
Power cuts out during operation.	The batteries have run out.	Load new or fully charged batteries.
Batteries run out quickly.	<ul style="list-style-type: none"> Camera is being used in extremely cold conditions. The terminals are soiled. The batteries can no longer be recharged. The rechargeable batteries (if used) have become deactivated, or the battery capacity has diminished due to the memory effect. 	<ul style="list-style-type: none"> Put the batteries in your pocket or another warm place to heat them and then load them into the camera just before you take a picture. Wipe the battery terminals with a clean, dry cloth. Load new or fully charged batteries. Use the rechargeable battery discharging function to restore the rechargeable batteries to full capacity.
No photograph is taken when the shutter button is pressed.	<ul style="list-style-type: none"> No xD-Picture Card is inserted. The xD-Picture Card is full. The xD-Picture Card is not formatted. The xD-Picture Card contact area is soiled. The xD-Picture Card is damaged. The Auto power off function has turned the camera off. The batteries have run out. 	<ul style="list-style-type: none"> Insert an xD-Picture Card. Insert a new xD-Picture Card or erase some unwanted frames. Format the xD-Picture Card on the camera. Wipe the xD-Picture Card contact area with a clean dry cloth. Insert a new xD-Picture Card. Turn the camera on. Load new or fully charged batteries.
Can't use the flash.	<ul style="list-style-type: none"> The shutter button was pressed while the flash was charging. The flash is not popped up. The Mode dial is set to "▲" Landscape. 	<ul style="list-style-type: none"> Wait until the charging is completed before pressing the shutter button. Pop up the flash. Change the Photography mode.
The flash settings are restricted and cannot be selected.	The Mode dial is set to "▲", "❄" or "☾".	The flash settings are restricted because the camera settings are tailored to the scene being shot. Change the Photography mode for a wider range of flash settings.
The playback image is dark even though the flash was used.	<ul style="list-style-type: none"> The subject is too far away. Your finger was covering the flash/flash control sensor. 	<ul style="list-style-type: none"> Move to within the effective flash range before taking the picture. Hold the camera correctly.
Can't set exposure compensation.	The Mode dial is set to "AUTO", "☾", "▲", "❄", "☾" or "M".	Change the Photography mode.
Can only select Suppressed flash mode.	Continuous shooting is selected.	Set continuous shooting to "OFF".
The image is blurred.	<ul style="list-style-type: none"> The lens is dirty. The photographed subject was too dark. You photographed scenery with Macro mode selected. You took a close-up shot without selecting Macro mode. You are shooting a subject that is not suited to autofocus. 	<ul style="list-style-type: none"> Clean the lens. Try standing about 2 m (6.6 ft.) from your subject to take the picture. Cancel Macro mode. Select Macro mode. Use AF/AE lock to take the picture.
There is speckling on the image.	The picture was taken with a slow shutter speed (long exposure) in a high-temperature environment.	This is a characteristic of CCDs and does not indicate a camera fault.
The camera does not emit any sound.	<ul style="list-style-type: none"> The camera volume is set too low. The microphone was blocked during shooting/recording. There is something covering the speaker during playback. 	<ul style="list-style-type: none"> Adjust the volume. Take care not to block the microphone during shooting/recording. Make sure that the speaker is uncovered.

Troubleshooting

▶ If you think the camera is faulty, check the following once more.

Troubleshooting	Possible causes	Solutions
Frame erase does not erase the frame. The ERASE ALL function does not erase all the frames.	Some frames may be protected.	Unprotect frames using the camera on which the protection was first applied.
Screens are not displayed in English.	A language other than English is selected in the “言語/LANG.” setting in the “SET-UP” menu (▶P.81).	<ol style="list-style-type: none"> Press the “MENU/OK” button to display the menu. Press “▲” or “▶” to select “” and press “▲” or “▼” to select “SET-UP”. Press the “MENU/OK” button to display the SET-UP screen on the screen. Press “◀” or “▶” to move to option 4 and then press “▲” or “▼” to select “言語/LANG.”. Press “◀” or “▶” several times to select “ENGLISH”. Press the “MENU/OK” button.
There is no image or sound on the TV.	<ul style="list-style-type: none"> The camera is not connected to the TV correctly. “TV” is selected as the TV input. The video output setting is incorrect. 	<ul style="list-style-type: none"> Connect the camera and TV correctly. Set the TV input to “VIDEO”. Change the setting to “NTSC” or “PAL” (▶P.81).
The TV image is black and white.	The video output setting is incorrect.	Change the setting to “NTSC” or “PAL” (▶P.81)
When the camera is connected to a PC, the photographed image or playback image appears on the camera’s screen.	<ul style="list-style-type: none"> The USB cable (mini-B) is not correctly connected to the PC or camera. The PC is not turned on. 	<ul style="list-style-type: none"> Set up the camera and the USB cable (mini-B) correctly. Turn the PC on.
Nothing happens when I use the Mode dial.	<ul style="list-style-type: none"> Camera malfunction. The batteries have run out. 	<ul style="list-style-type: none"> Briefly remove the batteries or disconnect the AC power adapter. Then reload the battery or reconnect the AC power adapter and try again. Load new or fully charged batteries.
The camera no longer works correctly.	The camera has suffered an unforeseen problem.	Briefly remove the batteries or disconnect the AC power adapter. Then reload the batteries or reconnect the AC power adapter and try again. If the message still appears, contact your FUJIFILM dealer.
Can’t print with PictBridge.	“” is not selected in USB mode in the “SET-UP” menu.	Select “” in USB mode in the “SET-UP” menu.
The camera was connected to a PC when the USB mode was set to “”.		<p>Perform steps ① to ③ to remove the camera from the PC.</p> <ul style="list-style-type: none"> ● Windows <ol style="list-style-type: none"> The “New Hardware Found” wizard (or “Scanner and Camera” wizard) appears. If the wizard does not appear, proceed to step ③. Click the [Cancel] button. Disconnect the camera from the PC. ● Macintosh <ol style="list-style-type: none"> The window for locating the driver appears. If the window does not appear, proceed to step ③. Click the [Cancel] button. Disconnect the camera from the Macintosh.

Specifications

System	
Model	Digital camera FinePix S5100/FinePix S5500
Effective pixels	4.0 million pixels
CCD	1/2.7 inch square pixel CCD Number of total pixels: 4.23 million pixels
Number of recorded pixels	Still image: 2272 × 1704 pixels/1600 × 1200 pixels/1280 × 960 pixels/ 640 × 480 pixels (/// Movie: 640 × 480 pixels (30 frames per second with monaural sound) 320 × 240 pixels (30 frames per second with monaural sound)
Storage media	xD-Picture Card (16/32/64/128/256/512 MB)
File format	Still image: Compressed: JPEG (Exif ver. 2.2) Uncompressed: CCD-RAW (RAF) * Design rule for Camera File System compliant DPOF compatible Movie: AVI format, Motion JPEG Audio: WAVE format, Monaural sound
Lens	Fujinon 10× optical zoom lens, F2.8-F3.1
Aperture	F2.8-F8 10 steps at wide-angle/F3.1-F9 10 steps at telephoto in 1/3 EV increments Manual/Auto selectable
Focal length	f=5.7 mm to 57 mm (Equivalent to 37 mm to 370 mm on a 35 mm camera)
Digital zoom	: approx. 1.4× /: approx. 1.8× /: approx. 3.6× (10× optical zoom lens is used together: Max. zoom scale: 35.5×)
Focal range	Normal: Wide-angle: Approx. 90 cm (3.0 ft.) to infinity Telephoto: Approx. 2.0 m (6.6 ft.) to infinity Macro: Wide-angle: Approx. 10 cm to 2.0 m (3.9 in. to 6.6 ft.) Telephoto: Approx. 90 cm to 2.0 m (3.0 ft. to 6.6 ft.)
Shutter speed	: AUTO / : 1/4 sec. to 1/2000 sec. / : 3 sec. to 1/1000 sec. A: 1/4 sec. to 1/1000 sec. M: 15 sec. to 1/2000 sec.
Focus	TTL contrast-type, Auto focus, Manual focus
Sensitivity	: AUTO (Equivalent to ISO 64 to 320, depending on conditions) 64/100/200/400 ///: Equivalent to ISO 64/100/200/400 (During setting CCD-RAW: ISO 64/100/200)
Photometry	TTL 64-zones metering Multi, Spot, Average
Exposure control	Program AE (), P, , , ,), Shutter-priority AE, Aperture-priority AE, Manual exposure
Exposure compensation	-2.0 EV to +2.0 EV in 1/3 EV step increments (in Programmed auto, shutter-priority auto, Aperture-priority auto)
White balance	Auto (, , , ,) Manual modes, 8 positions can be selected (P, S, A, M)
Viewfinder	0.33 inches, 115,000 pixels electronic viewfinder, Approx. 100% coverage
LCD monitor	1.5 inches, low-temperature polysilicon TFT 115,000 pixels, Approx. 100% coverage
Flash type	Auto flash using flash control sensor Effective range: Wide-angle: Approx. 30 cm to 5.0 m (1.0 ft. to 16.4 ft.) (Approx. 30 cm to 2.0 m (1.0 ft. to 6.6 ft.): Macro) Telephoto: Approx. 80 cm to 4.5 m (2.6 ft. to 14.8 ft.) Flash modes: Auto, Red-eye reduction, Forced flash, Suppressed flash, Slow synchro, Red-eye reduction + Slow synchro
Self-timer	Approx. 2 sec./10 sec.
Continuous shooting	Top 3-frame: Number of recorded frames: up to 3 frames (at intervals as short as approx. 0.3 sec.) Final 3-frame: Number of recorded frames: last 3 frames before releasing the shutter button (at intervals as short as approx. 0.3 sec.) Long-period continuous shooting Number of recorded frames: up to 40 frames (at intervals as short as approx. 0.6 sec.)
Shooting functions	Best framing, Frame No. memory
Playback functions	Trimming, Automatic playback, Multi-frame playback, Voice memo
Other functions	PictBridge, Language (日本語, English, Francais, Deutsch, Español, Italiano, 中文), FinePix photo mode (F-mode), WEB camera, Discharge batteries
A/V output	NTSC/PAL selectable

Specifications

Input/Output Terminals

A/V output socket	2.5 mm dia. jack
USB socket	For file transfer to a PC
DC input	Socket for specified AC power adapter AC-5VH/AC-5VHS (sold separately)

Power Supply and Others

Power supply	Use one of the following: <ul style="list-style-type: none"> • 4× AA-size alkaline batteries • 4× AA-size Ni-MH (Nickel-Metal Hydride) batteries (sold separately) • AC Power Adapter AC-5VH/AC-5VHS (sold separately)
--------------	---

Guide to the number of available frames for battery operation	Battery Type	With LCD monitor ON
	Alkaline batteries	Approx. 200 frames
	Ni-MH batteries 2300 mAh	Approx. 400 frames

According to the CIPA (Camera & Imaging Products Association) standard procedure for measuring digital still camera battery consumption (extract):
When using alkaline batteries, use the batteries supplied with the camera. You can use Ni-MH batteries also. The storage media should be **xD-Picture Card**.
Pictures should be taken at a temperature of 23°C (+73°F), with the LCD monitor/viewfinder (EVF) turned on, the optical zoom moved from full wide-angle to full telephoto (or vice-versa) and back again to its original position every 30 seconds, the flash used at full power every second shot and the camera turned off and then on again once every 10 shots.
● Note: Because the number of available shots varies depending on the capacity of alkaline batteries or the level of charge in Ni-MH batteries, the figures shown here for the number of available shots using batteries are not guaranteed. The number of available shots will also decline at low temperatures.

Conditions for use	Temperature : 0°C to +40°C (+32°F to +104°F) ; 80% humidity or less (no condensation)
Camera dimensions (W×H×D)	112.7 mm × 81.1 mm × 79.3 mm/4.4 in. × 3.2 in. × 3.1 in. (not including accessories and attachments)
Camera mass (weight)	Approx. 340 g/12.0 oz. (not including accessories, batteries and xD-Picture Card)
Weight for photography	Approx. 480 g/16.9 oz. (including batteries and xD-Picture Card)
Accessories	See P.7
Optional accessories	See P.105

■ Standard number of available frames/recording time per xD-Picture Card

The number of available shots, recording time or file size varies slightly depending on the subjects photographed. Note also that the difference between standard number of frames and the actual number of frames is greater for **xD-Picture Cards** with higher capacities.

Quality Setting	4M F	4M N	2M	1M	8M	RAW	Movie 640	Movie 320
Number of recorded pixels	2272 × 1704	1600 × 1200	1280 × 960	640 × 480	2272 × 1704	640 × 480	320 × 240	
Image Data Size	1.9 MB	960 KB	620 KB	460 KB	130 KB	8.3 MB	–	–
DPC-16 (16 MB)	8	16	25	33	122	1	13 sec.	26 sec.
DPC-32 (32 MB)	16	32	50	68	247	3	27 sec.	54 sec.
DPC-64 (64 MB)	33	66	101	137	497	7	55 sec.	109 sec.
DPC-128 (128 MB)	66	132	204	275	997	15	111 sec.	219 sec.
DPC-256 (256 MB)	134	266	409	550	1997	30	223 sec.	7.3 min.
DPC-512 (512 MB)	268	532	818	1101	3993	61	7.4 min.	14.6 min.

* These specifications are subject to change without notice. FUJIFILM shall not be held liable for damages resulting from errors in this Owner's Manual.

* The LCD monitor/viewfinder (EVF) on your digital camera is manufactured using advanced high-precision technology. Even so, small bright points and anomalous colors (particularly around text) may appear on the monitor/finder. These are normal display characteristics and do not indicate a fault with the monitor/finder. This phenomenon will not appear on the recorded image.

* The operation error may be caused in a digital camera by the strong radio interference (i. e. electric fields, static electricity, line noise, etc.).

* Due to the nature of the lens, the edges of photographed images may appear distorted. This is normal.

Explanation of Terms

AF/AE Lock

On the FinePix S5100/FinePix S5500, pressing the shutter button down half way locks the focus and exposure settings (AF and AE lock). If you want to focus on a subject that is not centered in the frame or change the picture composition after the exposure is set, you can obtain good results by changing the composition after the AF and AE settings are locked.

Auto power save function

If the camera is not used in any way for 60 seconds, this function turns features such as the LCD monitor/viewfinder (EVF) off (sleep mode) to prevent battery depletion and the waste of power when the AC power adapter is connected. If the camera is then left unused for a further period, the Auto power save function turns the camera off. This period can be set to 2 or 5 minutes on this camera.

● The Auto power off function does not operate in PC mode, during automatic playback, or if it is disabled during setup.

Deactivated batteries

Leaving an Ni-MH battery unused in storage for a long period may cause a rise in the level of substances that inhibit current flow inside the battery and result in a dormant battery. A battery in this state is referred to as deactivated. Because current flow is inhibited in a deactivated Ni-MH battery, the battery's original level of performance cannot be achieved.

DPOF

Digital Print Order Format

DPOF is a format used for recording information on a storage media (image memory card, etc.) that allows you to specify which of the frames shot using a digital camera are to be printed and how many prints are made of each image.

EV

A number denotes Exposure Value. The EV is determined by the brightness of the subject and sensitivity (speed) of the film or CCD. The number is larger for bright subjects and smaller for dark subjects. As the brightness of the subject changes, a digital camera maintains the amount of light hitting the CCD at a constant level by adjusting the aperture and shutter speed.

When the amount of light striking the CCD doubles, the EV increases by 1. Likewise, when the light is halved, the EV decreases by 1.

Frame rate (fps)

The frame rate refers to the number of images (frames) that are photographed or played back per second. For example, when 10 frames are continuously photographed in a 1-second interval, the frame rate is expressed as 10 fps. For reference, TV images are displayed at 30 fps (NTSC).

JPEG

Joint Photographics Experts Group

A file format used for compressing and saving color images. The higher the compression rate, the greater the loss of quality in the decompressed (restored) image.

Memory effect

If an Ni-MH battery is repeatedly charged without first being fully discharged, its performance may drop below its original level. This is referred to as the "memory effect".

Motion JPEG

A type of AVI (Audio Video Interleave) file format that handles images and sound as a single file. Images in the file are recorded in JPEG format. Motion JPEG can be played back by QuickTime 3.0 or later.

PC Card

A generic term for cards that meet the PC Card Standard.

PC Card Standard

A standard for PC cards determined by the PCMCIA.

PCMCIA

Personal Computer Memory Card International Association (US).

Smear

A phenomenon specific to CCDs whereby white streaks appear on the image when there is a very strong light source, such as the sun or reflected sunlight, in the photography screen.

WAVE

A standard format used on Windows systems for saving audio data. WAVE files have the ".WAV" file extension and the data can be saved in either compressed or uncompressed format. Uncompressed recording is used on this camera.

WAVE files can be played back on a PC using the following software:

Windows: MediaPlayer

Macintosh: QuickTime Player

* QuickTime 3.0 or later

White Balance

Whatever the kind of the light, the human eye adapts to it so that a white object still looks white. On the other hand, devices such as digital cameras see a white subject as white by first adjusting the color balance to suit the color of the ambient light around the subject. This adjustment is called matching the white balance.



Exif Print Format is a newly revised digital camera file format that contains a variety of shooting information for optimal printing.

Safety Notes

- Make sure that you use your FinePix S5100/FinePix S5500 camera correctly. Read these Safety Notes and your Owner's Manual carefully before use.
- After reading these Safety Notes, store them in a safe place.

About the Icons

The icons shown below are used in this document to indicate the severity of the injury or damage that can result if the information indicated by the icon is ignored and the product is used incorrectly as a result.

	WARNING This icon indicates that death or serious injury can result if the information is ignored.
	CAUTION This icon indicates that personal injury or material damage can result if the information is ignored.

The icons shown below are used to indicate the nature of the information which is to be observed.

- Triangular icons tell you that this information requires attention ("important").
- Circular icons with a diagonal bar tell you that the action indicated is prohibited ("Prohibited").
- Filled circles with an exclamation mark tell you an action that must be performed ("Required").

	WARNING If a problem arises, turn the camera off, remove the batteries, disconnect and unplug the AC power adapter. Continued use of the camera when it is emitting smoke, is emitting any unusual odor, or is in any other abnormal state can cause a fire or electric shock. ● Contact your FUJIFILM dealer.	 Unplug from power socket.
	Do not allow water or foreign objects to enter the camera. If water or foreign objects get inside the camera, turn the camera off, remove the batteries and disconnect and unplug the AC power adapter. Continued use of the camera can cause a fire or electric shock. ● Contact your FUJIFILM dealer.	
	Do not use the camera in the bathroom or shower. This can cause a fire or electric shock.	 Do not use in the bathroom or shower.
	Never attempt to change or take apart the camera. (Never open the casing.) Do not use the camera when it has been dropped or the casing is damaged. This can cause a fire or electric shock. ● Contact your FUJIFILM dealer.	 Do not disassemble.
	Do not change, heat or unduly twist or pull the connection cord and do not place heavy objects on the connection cord. These actions could damage the cord and cause a fire or electric shock. ● If the cord is damaged, contact your FUJIFILM dealer.	
	Do not place the camera on an unstable surface. This can cause the camera to fall or tip over and cause injury.	
	Never attempt to take pictures while in motion. Do not use the camera while you are walking or driving a vehicle. This can result in you falling down or being involved in a traffic accident.	
	Do not touch any metal parts of the camera during a thunderstorm. This can cause an electric shock due to induced current from the lightning discharge.	
	Do not use the batteries except as specified. Load the batteries with the ⊕ and ⊖ marks.	

	WARNING Do not heat, change or take apart the batteries. Do not drop or subject the batteries to impacts. Do not attempt to recharge lithium or alkaline batteries. Do not store the batteries with metallic products. Do not use chargers other than the specified model to charge the batteries. Any of these actions can cause the batteries to burst or leak and cause fire or injury as a result.	
	Use only the batteries or AC power adapters specified for use with this camera. Do not use voltages other than the power supply voltage shown. The use of other power sources can cause a fire.	
	If the battery leaks and fluid gets in contact with your eyes, skin or clothing. Flush the affected area with clean water and seek medical attention or call an emergency number right away.	
	Do not use the charger to charge batteries other than those specified here. The charger is designed for Fujifilm HR-AA Ni-MH batteries. Using the charger to charge conventional batteries or other types of rechargeable batteries can cause the battery to leak fluid, overheat or burst.	
	When discarding or storing batteries, cover the battery terminals with insulation tape. ● Contact with other metallic objects or batteries could cause the batteries to ignite or burst.	
	Keep xD-Picture Cards out of the reach of small children. Because xD-Picture Cards are small, they can be swallowed by children. Be sure to store xD-Picture Cards out of the reach of small children. If a child swallows an xD-Picture Card, seek medical attention or call an emergency number.	

	CAUTION Do not use this camera in locations affected by oil fumes, steam, humidity or dust. This can cause a fire or electric shock.	
	Do not leave this camera in places subject to extremely high temperatures. Do not leave the camera in locations such as a sealed vehicle or in direct sunlight. This can cause a fire.	
	Keep out of the reach of small children. This product could cause injury in the hands of a child.	
	Do not place heavy objects on the camera. This can cause the heavy object to tip over or fall and cause injury.	
	Do not move the camera while the AC power adapter is still connected. Do not pull on the connection cord to disconnect the AC power adapter. This can damage the power cord or cables and cause a fire or electric shock.	
	Do not use the AC power adapter when the plug is damaged or the plug socket connection is loose. This could cause a fire or electric shock.	
	Do not cover or wrap the camera or the AC power adapter in a cloth or blanket. This can cause heat to build up and distort the casing or cause a fire.	
	When you are cleaning the camera or you do not plan to use the camera for an extended period, remove the batteries and disconnect and unplug the AC power adapter. Failure to do so can cause a fire or electric shock.	
	When charging ends, unplug the charger from the power socket. Leaving the charger plugged into the power socket can cause a fire.	
	Using a flash too close to a person's eyes may temporarily affect their eyesight. Take particular care when taking pictures of children.	
	When an xD-Picture Card is removed, the card could come out of the slot too quickly. Use your finger to hold it and gently release the card.	
	Request regular internal testing and cleaning for your camera. Build-up of dust in your camera can cause a fire or electric shock. ● Contact your FUJIFILM dealer to request internal cleaning every 2 years. Please note this is not a free of charge service.	



FUJI PHOTO FILM CO., LTD.

26-30, Nishiazabu 2-chome, Minato-ku, Tokyo 106-8620, Japan

<http://home.fujifilm.com/products/digital/>

Printed in Japan

Printed on recycled paper.

FGS-406107-FG