

 **FUJIFILM**

digital
Tools for the imagination.

xD
xD-Picture Card™

Exif Print

PictBridge



DIGITAL CAMERA
FinePix S9000
DIGITAL CAMERA
FinePix S9500

OWNER'S MANUAL

This manual will show you how to use your
FUJIFILM DIGITAL CAMERA FinePix S9000/FinePix S9500 correctly.
Please follow the instructions carefully.

1 Getting Ready

2 Using
the Camera

3 Advanced
Features

4 Settings

5 Software
Installation

6 Viewing Images

Warning

To prevent fire or shock hazard, do not expose the unit to rain or moisture.

For customers in the U.S.A.

**Tested To Comply
With FCC Standards
FOR HOME OR OFFICE USE**

FCC Statement

This device complies with part 15 of the FCC Rules. Operation is subject to the following two conditions: (1) This device may not cause harmful interference, and (2) this device must accept any interference received, including interference that may cause undesired operation.

CAUTION

This equipment has been tested and found to comply with the limits for a Class B digital device, pursuant to Part 15 of the FCC Rules. These limits are designed to provide reasonable protection against harmful interference in a residential installation. This equipment generates, uses, and can radiate radio frequency energy and, if not installed and used in accordance with the instructions, may cause harmful interference to radio communications. However, there is no guarantee that interference will not occur in a particular installation. If this equipment does cause harmful interference to radio or television reception, which can be determined by turning the equipment off and on, the user is encouraged to try

to correct the interference by one or more of the following measures:

- Reorient or relocate the receiving antenna.
- Increase the separation between the equipment and receiver.
- Connect the equipment into an outlet on a circuit different from that to which the receiver is connected.
- Consult the dealer or an experienced radio/TV technician for help.

You are cautioned that any changes or modifications not expressly approved in this manual could void the user's authority to operate the equipment.

Notes on the Grant:

To comply with Part 15 of the FCC rules, this product must be used with a Fujifilm-specified ferrite-core A/V cable, USB cable and DC supply cord.

For customers in Canada

CAUTION

This Class B digital apparatus complies with Canadian ICES-003.

Please read the Safety Notes (→P.142) and make sure you understand them before using the camera.

Be sure to read this page before using the Software.

IMPORTANT

NOTICE

BEFORE OPENING THE CD-ROM PROVIDED BY FUJI PHOTO FILM CO., LTD., PLEASE READ THIS END USER LICENSE AGREEMENT CAREFULLY. ONLY IF YOU AGREE WITH THIS AGREEMENT, SHOULD YOU USE THE SOFTWARE RECORDED ON THE CD-ROM. BY OPENING THE PACKAGE, YOU ACCEPT AND AGREE TO BE BOUND BY THIS AGREEMENT.

End User License Agreement

This End User License Agreement ("Agreement") is an agreement between Fuji Photo Film Co., Ltd. ("FUJIFILM") and you, which sets forth the terms and conditions of the license granted for you to use the software provided by FUJIFILM.

The CD-ROM contains third party software. In case a separate agreement is provided by a third party supplier for its software, the provisions of such separate agreement shall apply to the use of such third party software, prevailing over those of this Agreement.

1. Definitions.

- "Media" means the CD-ROM titled "Software for FinePix CX" which is provided to you together with this Agreement.
- "Software" means the software which is recorded on Media.
- "Documentation" means the operation manuals of Software and other related written materials which are provided to you together with Media.
- "Product" means Media (including Software) and Documentation collectively.

2. Use of Software.

- FUJIFILM grants to you a nontransferable, nonexclusive license:
- to install one copy of Software onto one computer in binary machine executable form;
 - to use Software on the computer onto which Software is installed; and
 - to make one backup copy of Software.

3. Restrictions.

- You shall not distribute, rent, lease or otherwise transfer all or any part of Software, Media or Documentation to any third party without FUJIFILM's prior written consent. You also shall not sublicense, assign or otherwise transfer all or any part of the rights granted to you by FUJIFILM under this Agreement without FUJIFILM's prior written consent.
- Except as expressly granted by FUJIFILM hereunder, you shall not copy or reproduce all or any part of Software or Documentation.
- You shall not modify, adapt or translate Software or Documentation. You also shall not alter or remove copyright and other proprietary notices that appear on or in Software or Documentation.
- You shall not, or shall not have any third party, reverse-engineer, decompile, or disassemble Software.

4. Ownership.

All copyrights and other proprietary rights to Software and Documentation are owned and retained by FUJIFILM or the third party suppliers as indicated on or in Software or Documentation. Nothing contained herein shall be construed, expressly or implicitly, as transferring or granting any right, license, or title to you other than those explicitly granted under this Agreement.

5. Limited Warranty.

FUJIFILM warrants to you that Media is free from any defect in material and workmanship under normal use for ninety (90) days from the date of your receipt of Media. Should Media not meet the foregoing warranty, FUJIFILM shall replace such defective Media with other Media bearing no defect. FUJIFILM's entire liability and your sole and exclusive remedy with regard to any defect in Media shall be expressly limited to such FUJIFILM's replacement of Media as provided herein.

6. DISCLAIMER OF WARRANTY.

EXCEPT AS PROVIDED IN SECTION 5 HEREIN, FUJIFILM PROVIDES PRODUCT "AS IS" AND WITHOUT WARRANTIES OF ANY KIND, EXPRESS OR IMPLIED. FUJIFILM SHALL MAKE NO WARRANTY, EXPRESS, IMPLIED OR STATUTORY, AS TO ANY OTHER MATTERS, INCLUDING, BUT NOT LIMITED TO NON-INFRINGEMENT OF ANY COPYRIGHT, PATENT, TRADE SECRET, OR ANY OTHER PROPRIETARY RIGHTS OF ANY THIRD PARTY, MERCHANTABILITY, OR FITNESS FOR ANY PARTICULAR PURPOSE.

7. LIMITATION OF LIABILITY.

IN NO EVENT SHALL FUJIFILM HAVE ANY LIABILITY FOR ANY GENERAL, SPECIAL, DIRECT, INDIRECT, CONSEQUENTIAL, INCIDENTAL, OR OTHER DAMAGES (INCLUDING DAMAGES FOR LOSS OF PROFITS OR LOST SAVINGS) INCURRED FROM THE USE OF OR INABILITY TO USE PRODUCT EVEN IF FUJIFILM HAS BEEN ADVISED OF THE POSSIBILITY OF SUCH DAMAGES.

8. No export.

You acknowledge that neither Software nor any part thereof, will be transferred, or exported to any country or used in any manner in violation of any export control laws and regulations to which Software is subject.

9. Termination.

In case you breach any of the terms and conditions hereof, FUJIFILM may immediately terminate this Agreement without any notice.

10. Term.

This Agreement is effective until the date when you cease to use Software, unless earlier terminated in accordance with Section 9 hereof.

11. Obligation upon termination.

Upon termination or expiration of this Agreement, you shall, at your own responsibility and expense, delete or destroy immediately all Software (including its copies), Media and Documentation.

12. Governing Law.

This Agreement shall be governed by and construed in accordance with laws of Japan.

EC Declaration of Conformity

We

Name: Fuji Photo Film (Europe) G.m.b.H.
Address: Heesenstrasse 31
40549 Dusseldorf, Germany

declare that the product

Product Name: FUJIFILM DIGITAL CAMERA FinePix S9000 / FinePix S9500
Manufacturer's Name: Fuji Photo Film Co., Ltd.
Manufacturer's Address: 26-30, Nishiazabu 2-chome, Minato-ku,
Tokyo 106-8620, Japan

is in conformity with the following Standards

Safety: EN60065
EMC: EN55022: 1998 Classe B
EN55024: 1998
EN61000-3-2: 1995 + A1: 1998 + A2: 1998

following the provision of the EMC Directive (89/336/EEC, 92/31/EEC and 93/68/EEC) and Low Voltage Directive (73/23/EEC).



Dusseldorf, Germany

August 1, 2005

Place

Date

Signature/Managing Director



Bij dit product zijn batterijen geleverd. Wanneer deze leeg zijn, moet u ze niet weggooien maar inleveren als KCA

Disposal of Electric and Electronic Equipment in Private Households

Disposal of used Electrical & Electronic Equipment (Applicable in the European Union and other European countries with separate collection systems)



This symbol on the product, or in the manual and in the warranty, and/or on its packaging indicates that this product shall not be treated as household waste.

Instead it should be taken to an applicable collection point for the recycling of electrical and electronic equipment.

By ensuring this product is disposed of correctly, you will help prevent potential negative consequences to the environment and human health, which could otherwise be caused by inappropriate waste handling of this product.

If your equipment contains easy removable batteries or accumulators please dispose these separately according to your local requirements.

The recycling of materials will help to conserve natural resources. For more detailed information about recycling of this product, please contact your local city office, your household waste disposal service or the shop where you have purchased the product.

In Countries outside the EU:

If you wish to discard this product, please contact your local authorities and ask for the correct way of disposal.

Contents

Warning	2	Accessories included	8
IMPORTANT	2	Camera parts and features	9
EC Declaration of Conformity	3	Example of screen text display	10
Disposal of Electric and Electronic Equipment in Private Households	3	■ Photography mode	10
Preface	7	■ Playback mode	10

1 Getting Ready

ATTACHING THE STRAP, LENS CAP AND LENS HOOD	11
Attaching the lens cap	11
Attaching the lens hood	12
LOADING THE BATTERIES	13
Compatible batteries	13
INSERTING THE MEDIA	14
Checking the battery charge	15
TURNING ON AND OFF / SETTING THE DATE AND TIME	16
CORRECTING THE DATE AND TIME / CHANGING THE DATE FORMAT	17
SELECTING THE LANGUAGE	19

2 Using the Camera

BASIC OPERATION GUIDE	20
PHOTOGRAPHY MODE	
TAKING PICTURES (AUTO MODE)	23
INDICATOR LAMP DISPLAY	26
AF-ASSIST ILLUMINATOR	26
NUMBER OF AVAILABLE FRAMES	27
■ Standard number of frames per media	27
USING AF/AE LOCK	28
USING ZOOM FUNCTION	29
SHOOTING ASSISTANT FUNCTION	30
PLAYBACK MODE	
VIEWING THE IMAGES (▶ PLAYBACK)	31
Single-frame playback / Selecting images / Multi-frame playback	31
Sorting by date	32
Playback zoom	34
■ Zoom scales	34
ERASING IMAGE (ERASE FRAME)	35

3 Advanced Features

STILL PHOTOGRAPHY	
PHOTOGRAPHY FUNCTIONS	
FOCUSING (DISTANCE)	36
EXPOSURE (SHUTTER SPEED AND APERTURE)	37
TAKING PICTURES — SELECTING THE CAMERA SETTINGS	38
SELECTING PHOTOGRAPHY MODE	40
AUTO AUTO	40
SCENE POSITION	40
P PROGRAMMED AUTO	41
S SHUTTER-PRIORITY AUTO	42
A APERTURE-PRIORITY AUTO	43
M MANUAL	44
AE-L EXPOSURE COMPENSATION	45
AE-L USING AE LOCK	46
ADJUSTING LIGHT METERING (PHOTOMETRY)	47
CONTINUOUS AF	48
MANUAL FOCUS	49

M MACRO (CLOSE-UP)	50
L FLASH PHOTOGRAPHY	51
A Auto flash	52
RE Red-eye reduction	52
F Forced flash	52
S Slow synchro	52
RE Red-eye reduction + Slow synchro	52
C CONTINUOUS SHOOTING	54
4 Top 4-frame continuous shooting	55
AB Auto bracketing	55
4 Final 4-frame continuous shooting	55
LP Long-period continuous shooting	56
INCREASING MONITOR BRIGHTNESS	57
PHOTOGRAPHY INFORMATION	58
F PHOTO MODE PHOTOGRAPHY	
Q QUALITY MODE (NUMBER OF RECORDED PIXELS)	59
Quality settings in Photography mode	60
S SENSITIVITY	61
C FinePix COLOR	62
PHOTOGRAPHY MENU	
SETTING PHOTOGRAPHY MENU	63
PHOTOGRAPHY MENU	65
T SELF-TIMER PHOTOGRAPHY	65
WB WHITE BALANCE (SELECTING THE LIGHT SOURCE)	66
HS HIGH-SPEED SHOOTING	67
AF AF MODE	68
FB FLASH BRIGHTNESS ADJUSTMENT	69
S SHARPNESS	69
S SATURATION	70
C CONTRAST	70
B BRACKETING	70
M MULTIPLE EXPOSURE	71
EF USING AN EXTERNAL FLASH	72
PLAYBACK	
PHOTOGRAPHY FUNCTIONS	
PLAYBACK INFORMATION	74
PLAYBACK MENU	
E ERASING SINGLE / ALL FRAMES	75
R IMAGE ROTATE	77
F PHOTO MODE PLAYBACK	
P HOW TO SPECIFY PRINT OPTIONS (DPOF)	78
P SPECIFYING DPOF SETTINGS EASILY	79
PLAYBACK MENU	
P DPOF SET FRAME	81
P DPOF ALL RESET	83
PA PROTECTING IMAGES: FRAME / SET ALL / RESET ALL	84
AP AUTOMATIC PLAYBACK	86
R RECORDING VOICE MEMOS	87
R PLAYING BACK VOICE MEMOS	89
■ Playing back voice memos	89
Adjusting volume of voice memos	90
T TRIMMING	91
MOVIE	
MOVIE MODE	
M RECORDING MOVIES	93
■ Recording times per media	94
F PHOTO MODE MOVIE	
Q QUALITY SETTINGS IN MOVIE MODE	95

Contents

PLAYBACK MODE	
PLAYING BACK MOVIES	96
■ Playing back movies	96
Adjusting volume of movies	97
4 Settings	
SET-UP	98
USING THE SET-UP SCREEN	98
■ SET-UP menu options	100
IMAGE DISPLAY	101
PLAYBACK VOLUME	102
FRAME NO.	102
ADJUSTING SCREEN BRIGHTNESS	103
CCD-RAW	103
AUTO POWER OFF	104
FORMAT	104
TIME DIFFERENCE	105
5 Software Installation	
5.1 INSTALLATION ON A Windows PC	107
5.2 INSTALLATION ON A Mac OS X	109
6 Viewing Images	
6.1 CAMERA CONNECTION	112
6.1.1 Using the AC Power adapter	112
6.1.2 Connecting to a TV	112
6.2 CONNECTING THE CAMERA DIRECTLY TO THE PRINTER — PictBridge FUNCTION	113
6.2.1 Specifying images for printing on the camera	113
6.2.2 Specifying images for printing without using DPOF (single-frame printing)	115
6.3 CONNECTING TO A PC	117
6.3.1 Connecting to a PC	117
6.3.2 Disconnecting the camera	120
6.4 USING FinePixViewer	121
6.4.1 Mastering FinePixViewer	121
6.4.2 Uninstalling the software	121

System Expansion Options	123	Notes on the Media	129
Accessories Guide	124	Warning Displays	130
Using Your Camera Correctly	125	Troubleshooting	132
Power Supply and Batteries	125	Specifications	134
Applicable Batteries	125	Explanation of Terms	137
Notes on the Batteries	125	FUJIFILM Digital Camera	
Using the AA-size		Worldwide Network	138
Ni-MH batteries correctly	126	Safety Notes	142
AC Power Adapter	126		
Discharging			
rechargeable batteries	127		

Preface

■ Test Shots Prior to Photography

For important photographs (such as weddings and overseas trips), always take a test shot and view the image to make sure that the camera is working normally.

● Fuji Photo Film Co., Ltd. cannot accept liability for any incidental losses (such as the costs of photography or the loss of income from photography) incurred as a result of faults with this product.

■ Notes on Copyright

Images recorded using your digital camera system cannot be used in ways that infringe copyright laws without the consent of the owner, unless intended only for personal use. Note that some restrictions apply to the photographing of stage performances, entertainments and exhibits, even when intended purely for personal use. Users are also asked to note that the transfer of memory cards (xD-Picture Card or CF/Microdrive) containing images or data protected under copyright laws is only permissible within the restrictions imposed by those copyright laws.

■ Liquid Crystal

If the LCD monitor is damaged, take particular care with the liquid crystal in the monitor. If any of the following situations arise, take the urgent action indicated.

- If liquid crystal comes in contact with your skin
Wipe the area with a cloth and then wash thoroughly with soap and running water.
- If liquid crystal gets into your eye
Flush the affected eye with clean water for at least 15 minutes and then seek medical assistance.
- If liquid crystal is swallowed
Flush your mouth thoroughly with water. Drink large quantities of water and induce vomiting. Then seek medical assistance.

■ Notes on Electrical Interference

If the camera is to be used in hospitals or aircrafts, please note that this camera may cause interference to other equipment in the hospital or aircraft. For details, please check with the applicable regulations.

■ Handling Your Digital Camera

This camera contains precision electronic components. To ensure that images are recorded correctly, do not subject the camera to impact or shock while an image is being recorded.

■ Trademark Information

- and xD-Picture Card™ are trademarks of Fuji Photo Film Co., Ltd.
- IBM PC/AT is a registered trademark of International Business Machines Corp. of the U.S.A.
- Macintosh, Power Macintosh, iMac, PowerBook, iBook and Mac OS are trademarks of Apple Computer, Inc., registered in the U.S. and other countries.
- Microsoft, Windows, and the Windows logo are trademarks, or registered trademarks of Microsoft Corporation in the United States and/or other countries. Windows is an abbreviated term referring to the Microsoft® Windows® Operating System.
- * The "Designed for Microsoft® Windows® XP" logo refers to the camera and the driver only.
- Other company or product names are trademarks or registered trademarks of the respective companies.

■ Explanation of Color Television System

NTSC: National Television System Committee, color television telecasting specifications adopted mainly in the U.S.A., Canada and Japan.

PAL: Phase Alternation by Line, a color television system adopted mainly by European countries and China.

■ Exif Print (Exif ver. 2.2)

Exif Print Format is a newly revised digital camera file format that contains a variety of shooting information for optimal printing.

Do not store or use the camera in direct sunlight or in places subject to extreme temperature rises, such as in a closed car in summer.

Accessories included

- AA-size Alkaline Batteries (LR6) (4)

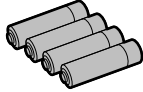

- A/V cable (1)

Approx. 1.2 m (3.9 ft.), plug (2.5 mm dia.) to pin-plug x2

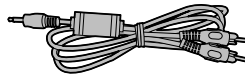

- 16 MB, xD-Picture Card™ (1)

Anti-static case (1) included



- USB cable (mini-B) (1)

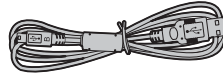

- Strap (1)

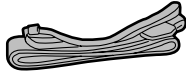

- CD-ROM (1)

Software for FinePix CX



- Lens cap (1)

- Lens cap holder (1)



- Lens hood (1)



- Owner's Manual (this manual) (1)

Camera parts and features

* Refer to the pages in parentheses for information on using the camera parts or features.

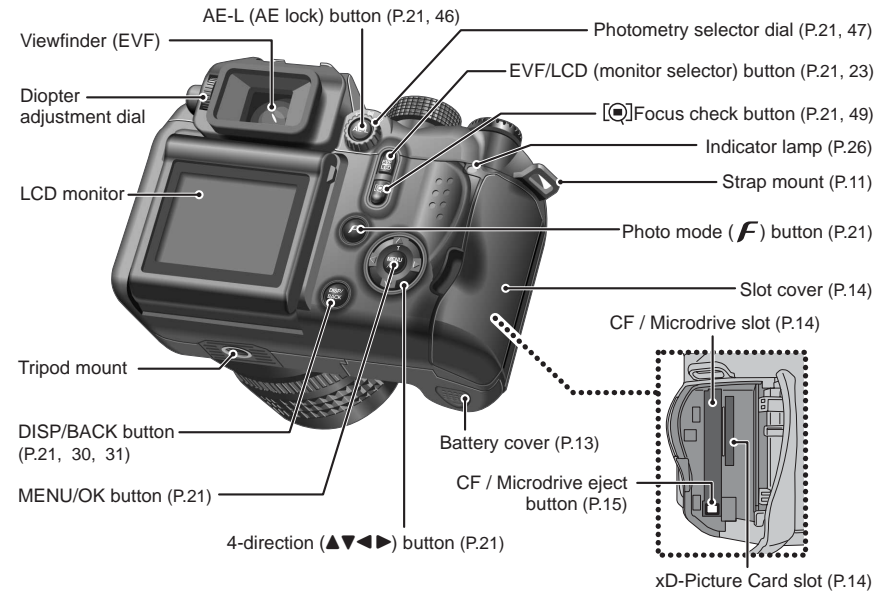
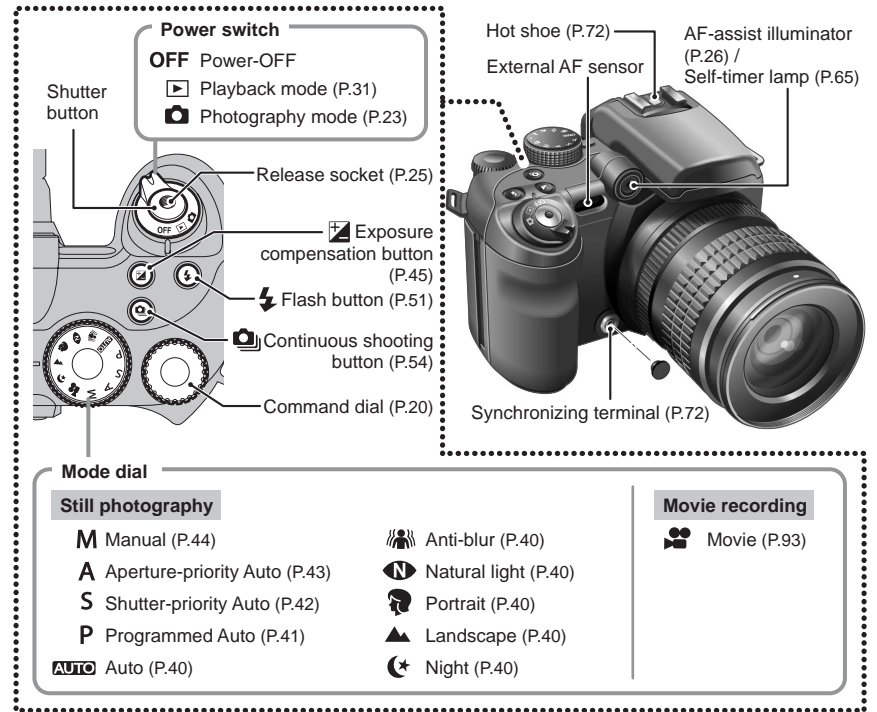

Camera parts and features

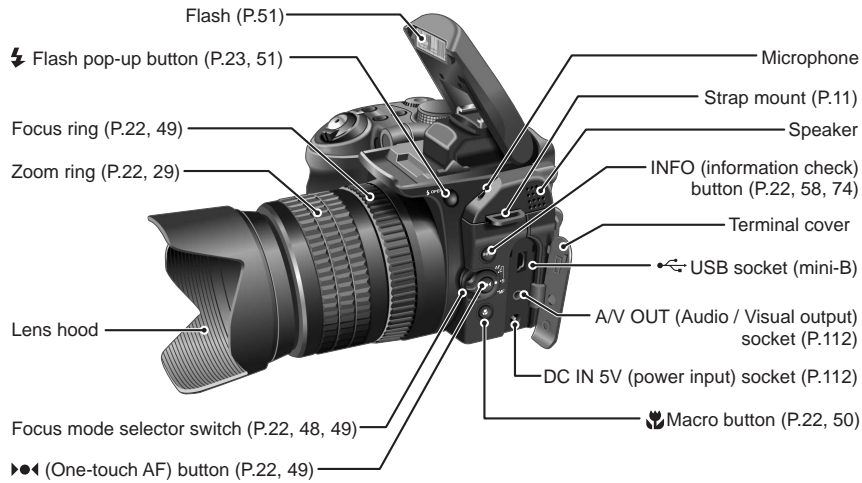

Example of screen text display

■ Photography mode

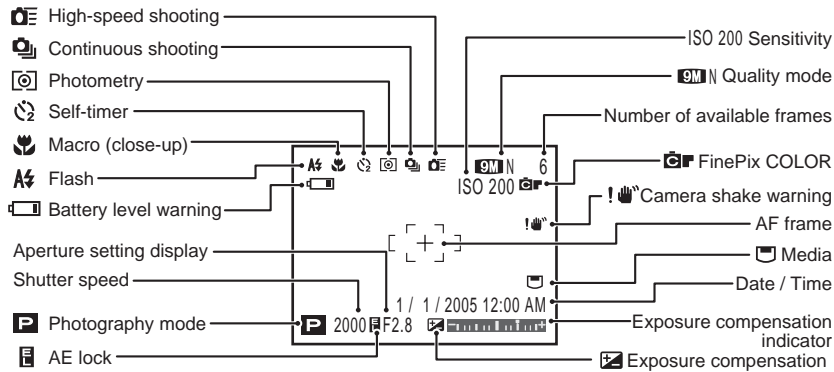

■ Playback mode

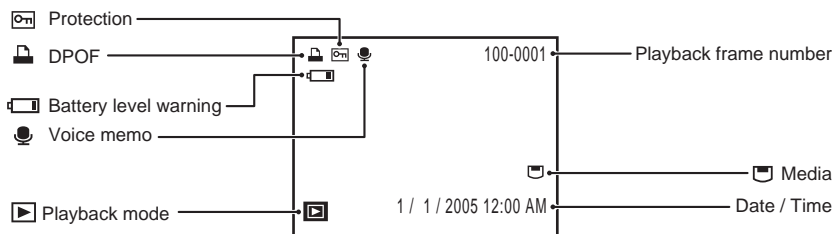

1 Getting Ready

ATTACHING THE STRAP, LENS CAP AND LENS HOOD

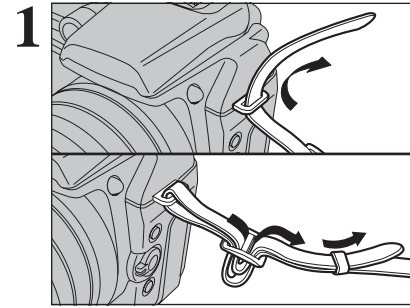

1 Attach the strap to the strap mounts on the camera. Once you have attached both ends of the strap, check carefully to make sure that the strap is firmly secured.

● Attach the strap correctly to prevent dropping the camera.

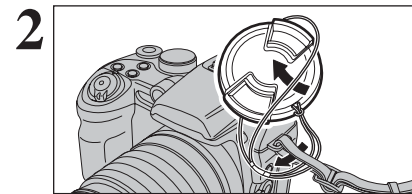

2 Pull the lens cap cord through the strap.

● Attach the lens cap cord to prevent losing the lens cap.

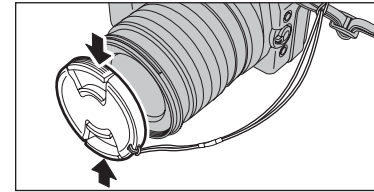

Attaching the lens cap

Attach the lens cap to the lens by pressing in on both sides of the cap.

◆ Using the lens cap holder ◆

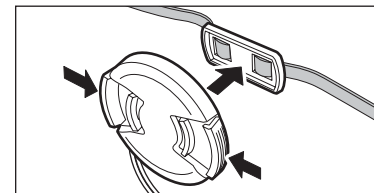

Make sure that the lens cap does not appear in your shot when taking a picture, attach it to the lens cap holder.

ATTACHING THE STRAP, LENS CAP AND LENS HOOD

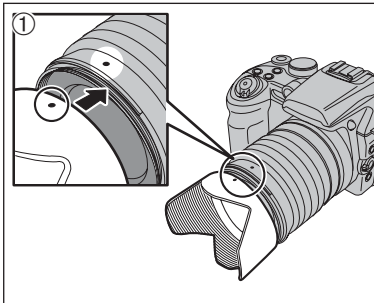

Attaching the lens hood

When attaching the lens hood, it is effective for reducing ghost images and flare in backlit scenes. Camera provides crisp, clear shots.

- ① Align the indicators on the camera and lens hood, and fit the lens hood to the lens.

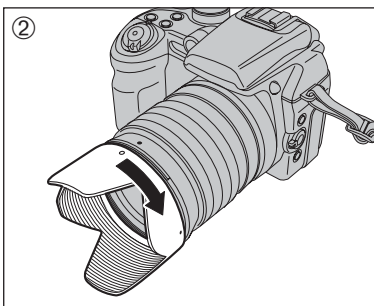

- ② Turn the lens hood clockwise until it clicks.

Storing lens hood

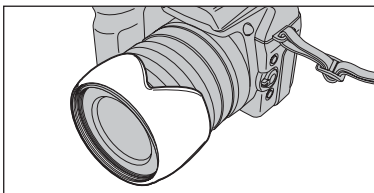

As in storing lens hood into the soft case, the lens hood can be attached upside down.

LOADING THE BATTERIES

Compatible batteries

- AA-size alkaline batteries (4) or AA-size Ni-MH rechargeable batteries (4) (sold separately)
- ⚡ Use the same brand and grade AA-size alkaline batteries as those supplied with the camera.

How to use the batteries

- Never use the following types of batteries, as they could cause serious problems such as battery fluid leakage or overheating:
 1. Batteries with split or peeling outer casings
 2. Combinations of different types of batteries or new and used batteries together
- Do not use manganese or Ni-Cd batteries.
- Soil, such as fingermarks on the poles of the batteries can shorten time for which the batteries can be used.
- The time for which AA-size alkaline batteries (referred to hereafter simply as alkaline batteries) can be used varies depending on the brand. Some brands of alkaline batteries may stop providing power more quickly than those supplied with the camera. Note also that due to their nature, the time for which alkaline batteries can be used decreases in cold conditions (0°C to +10°C/+32°F to +50°F). The use of AA-size Ni-MH batteries is better for this reason.
- Use Fujifilm Battery charger (sold separately) to charge AA-size Ni-MH batteries.
- See P.125-126 for other notes on using batteries.
- When first purchased or if left unused for a long period, the amount of time which AA-size Ni-MH batteries can be used may be short. See P.126 for more information.

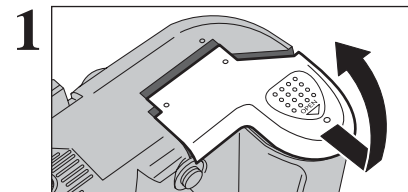
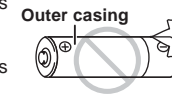

1 Check that the camera is turned off (set the Power switch to "OFF") before opening the battery cover.

- ⚡ If opening the battery cover while the camera is still on, the camera will turn off.
- ⚡ Do not apply force to the battery cover.

Do not open the battery cover while the camera is on. This could damage the media or ruin the image files on the media.

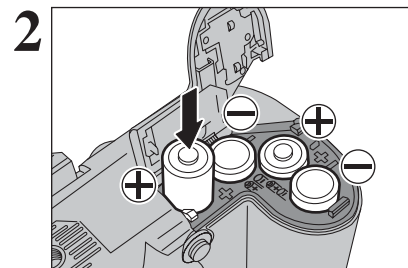

2 Load the batteries correctly as indicated by the polarity icons.

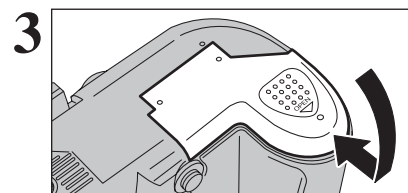

3 Press on the battery cover to push the batteries down. Slide the cover closed.

INSERTING THE MEDIA

Use either **xD-Picture Card** or CF/Microdrive as recording media in the FinePix S9000 / FinePix S9500.

- If an **xD-Picture Card** and a CF/Microdrive are inserted at the same time, images will be recorded onto the media selected as the "MEDIA" (➔P.100).
- Data cannot be copied between the two media types on the FinePix S9000 / FinePix S9500.

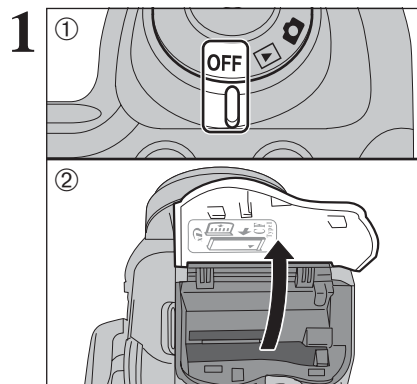

- ① Set the Power switch to "OFF".
- ② Open the slot cover.

⚠ If opening the slot cover while the camera is still on, the camera will turn off.

Do not open the slot cover while the camera is on. This could damage the media or ruin the image files on the media.

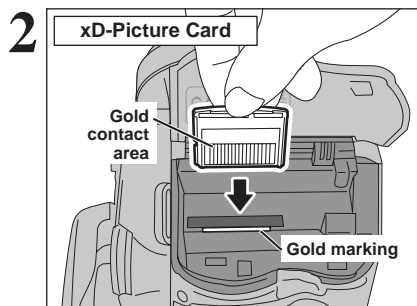

Align the gold marking on the xD-Picture Card slot with the gold contact area on the **xD-Picture Card** and push the card firmly all the way into the slot.

- ⚠ Insert only the appropriate media types into the **xD-Picture Card** and CF/Microdrive slots. Inserting the incorrect media will damage the camera or media.
- ⚠ If the media is oriented incorrectly, it will not go all the way into the slot. Do not apply force when inserting an **xD-Picture Card** or a CF/Microdrive.
- ⚠ If the media is not fully inserted into the slot, [CARD ERROR] appears.

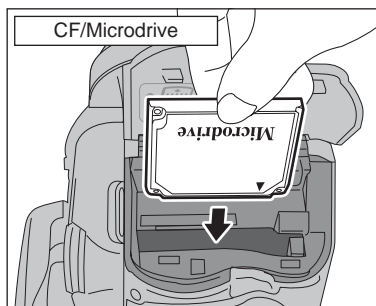

Push the CF/Microdrive firmly all the way into the CF/Microdrive slot. Compatibility is listed on Fujifilm website: <http://home.fujifilm.com/products/digital/>

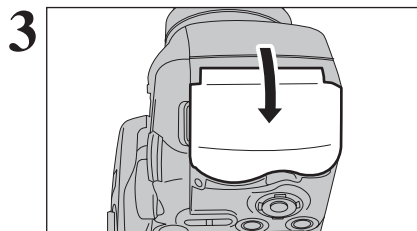

Close the slot cover.

◆ How to replace the xD-Picture Card ◆

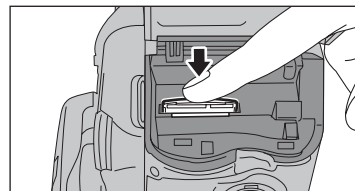

Push the **xD-Picture Card** into the slot and then slowly remove your finger. The lock is released and the **xD-Picture Card** is pushed out.

◆ How to replace the CF/Microdrive ◆

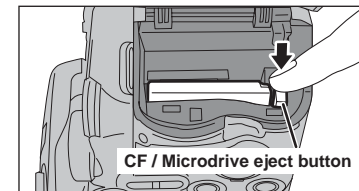

Open the slot cover, press the CF/Microdrive eject button and remove the CF/Microdrive.

⚠ When storing CF/Microdrives, always use the special protective case.

Checking the battery charge

Turn the camera on and check the battery charge.

- ① **No icon**
- ② **Lit red**
- ③ **Blinking red**

- ① There is ample battery charge.
- ② There is insufficient charge left in the batteries. The batteries will soon run out. Have a new set of batteries ready.
- ③ The batteries are depleted. The display will shortly go blank and the camera will stop working. Replace or recharge the batteries.

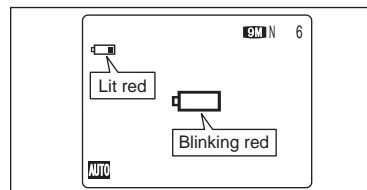

"" appears as a small icon on the left-hand side of the screen. "" appears as a large icon in the center of the screen.

- ⚠ Depending on the camera mode and the type of batteries used, the transition from "" to "" may occur more quickly.
- ⚠ Due to the nature of the battery, the battery level warning may appear early when the camera is used in cold locations. This is normal. Try warming the batteries in your pocket or a similar location before use.

* Battery level warning

- 1) The camera's estimation of the remaining battery charge varies greatly depending on the camera operation mode. Consequently, even if "" or "" is not displayed in Playback mode, one of them may appear when you change to Photography mode.
- 2) Depending on the battery type and the level of charge in the batteries, the camera may run out of power without first displaying a battery level warning. This is particularly likely to happen when batteries that have run out of charge are re-used. In situation 2), immediately load new or fully charged replacement batteries.

◆ Auto power off function ◆

If the camera is left unused for 2 or 5 minutes, the Auto power off function turns the camera off (➔P.104). To turn the camera back on, set the Power switch to "OFF" briefly and then back to "CAM" or "REC".

TURNING ON AND OFF / SETTING THE DATE AND TIME

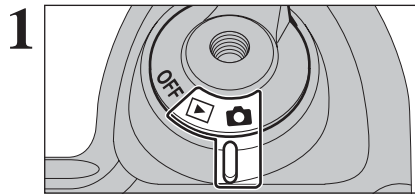

To turn the camera on, set the Power switch to “” or “”.
To turn the camera off, set the Power switch to “OFF”.

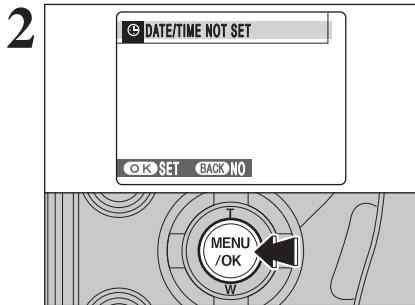

When using the camera for the first time after purchasing, the date and time are cleared.
Press the “MENU/OK” button to set the date and time.

- The message also appears when the batteries have been removed and the camera has been left for a long period.
- To set the date and time later, press the “DISP/BACK” button.
- If you do not set the date and time, this message will appear each time you turn the camera on.

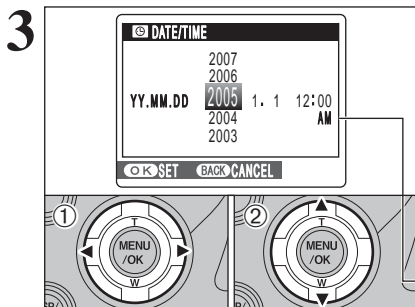

① Press “” or “” to select Year, Month, Day, Hour or Minute.
② Press “” or “” to correct the setting.

- Holding down “” or “” changes the numbers continuously.
- When the time displayed passes “12”, the AM/PM setting changes.

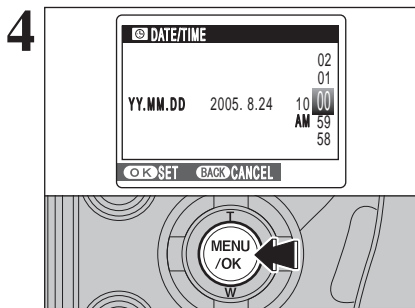

Once you have set the date and time, press the “MENU/OK” button. Pressing the “MENU/OK” button changes the camera to Photography or Playback mode.

- At the time of purchase and after leaving the camera for a long period with the batteries removed, settings such as the date and time are cleared. Once the AC power adapter has been connected or the batteries have been installed for 2 hours or more, the camera settings will be retained for roughly 6 hours even if both sources of power are removed.

CORRECTING THE DATE AND TIME / CHANGING THE DATE FORMAT

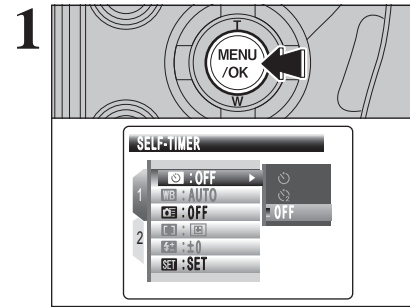

Press the “MENU/OK” button to display the menu on the screen.

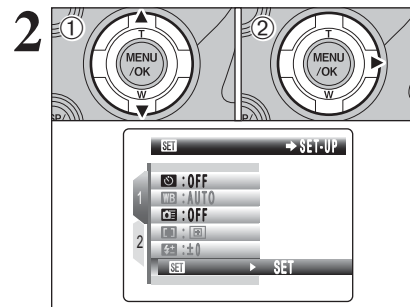

① Press “” or “” to select “” SET-UP.
② Press “”.

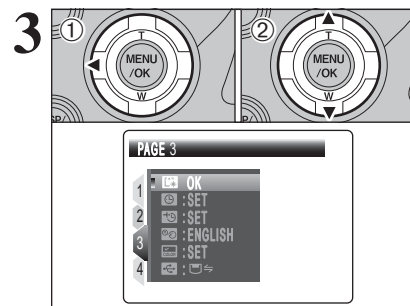

① Press “” to move to page number.
② Press “” or “” to select “PAGE 3”.

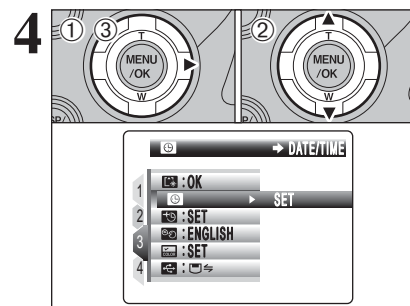

① Press “” to move to menu item.
② Press “” or “” to select “” DATE/TIME.
③ Press “”.

CORRECTING THE DATE AND TIME / CHANGING THE DATE FORMAT

5

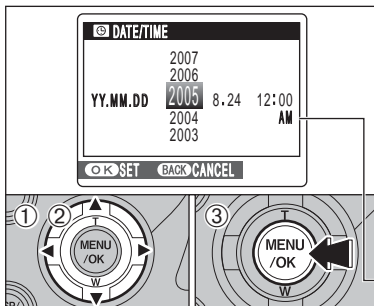

Correcting the date and time

- ① Press “◀” or “▶” to select Year, Month, Day, Hour or Minute.
- ② Press “▲” or “▼” to correct the setting.
- ③ Always press the “MENU/OK” button after the settings are completed.

- ⚡ Holding down “▲” or “▼” changes the numbers continuously.
- ⚡ When the time displayed passes “12”, the AM/PM setting changes.

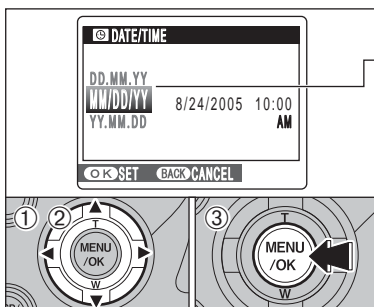

Changing the date format

- ① Press “◀” or “▶” to select the date format.
- ② Press “▲” or “▼” to set the format. Refer to the table below for details of the settings.
- ③ Always press the “MENU/OK” button after the settings are completed.

Date format	Sample settings
YY.MM.DD	2005.8.24
MM/DD/YY	8/24/2005
DD.MM.YY	24.8.2005

SELECTING THE LANGUAGE

1

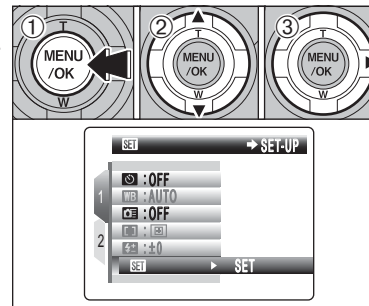

- ① Press the “MENU/OK” button to display the menu on the screen.
- ② Press “▲” or “▼” to select “SET-UP”.
- ③ Press “▶”.

2

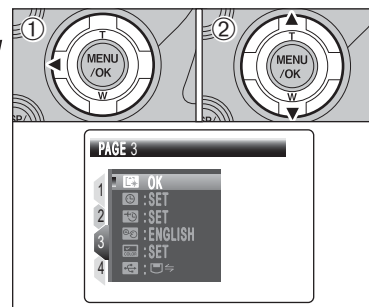

- ① Press “◀” to move to page number.
- ② Press “▲” or “▼” to select “PAGE 3”.

3

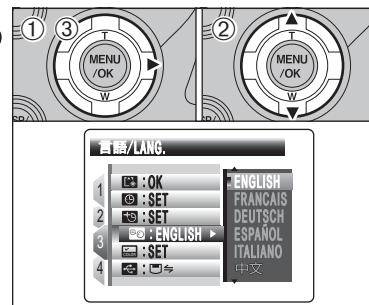

- ① Press “▶” to move to menu item.
- ② Press “▲” or “▼” to select “言語/LANG.”.
- ③ Press “▶”.

- ⚡ The screens in this manual are shown in English.
- ⚡ See P.100 for more information on the “SET” SET-UP menu.

4

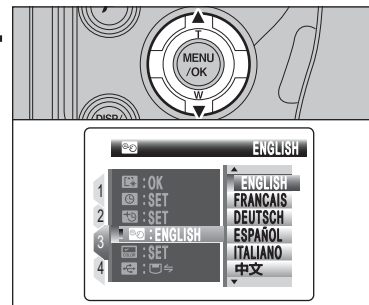

- Press “▲” or “▼” to select the language.

This section describes the camera's functions.

Command dial

In Photography mode, turn the Command dial to select program shift and specify settings such as the shutter speed and aperture.

: **Exposure compensation**
Hold down the "" button and turn the Command dial to select the setting.

: **Flash**
Release the pop-up flash, hold down the "" button and turn the Command dial to select the setting.

: **Continuous shooting**
Hold down the "" button and turn the Command dial to select the setting.

Power switch

ON/OFF and "📷" Photography mode / "▶" Playback mode selector switch

Use the Power switch to select the mode.

Photography mode selector

Turn the Mode dial to select the Photography mode.

Auto	Programmed Auto
Anti-blur	Shutter-priority Auto
Natural light	Aperture-priority Auto
Portrait	Manual
Landscape	
Night	Movie

Still photography: P, S, A, M, L, N, B, OFF

Movie recording: M, MOVIE

Diopter adjustment dial

Makes the image in the viewfinder easier to see. Set the dial to the position where the AF frame appears sharpest.

AE-L button

The exposure remains locked while this button is pressed.

Photometry selector dial

Selecting light metering method.

EVF/LCD (monitor selector) button

Pressing the "EVF/LCD" button toggles between the viewfinder (EVF) and the LCD monitor. Use whichever mode is best suited to your shot.

Photo mode F button

Photography: Select the quality mode, sensitivity and FinePix COLOR settings.
Playback: Specify the print order (DPOF) settings.

Focus check button

Pressing this button enlarges the central portion of the screen. Use this to focus the image precisely.

DISP/BACK button

DISP: Press this button to select the screen display.
BACK: Press this button to stop a procedure midway through.

▲▼ button

"T (▲)" button: Selecting Digital zoom mode (2x).
"W (▼)" button: Canceling the Digital zoom mode.

Using the Menus

- ① Displaying the menu.
Press the "MENU/OK" button.
- ② Selecting a menu option.
Press the up or down arrow on the 4-direction button.
- ③ Selecting an option.
Press the right arrow on the 4-direction button.
- ④ Selecting a setting.
Press the up or down arrow on the 4-direction button.
- ⑤ Confirming the setting.
Press the "MENU/OK" button.

Up, down, left and right are indicated by black triangles in the Owner's Manual. Up or down is shown as "▲" or "▼", and left or right is shown as "◀" or "▶".

Focus ring
The camera focuses on the subject using Manual focus mode.

Zoom ring
Turn the zoom ring to take pictures with zoom function.

Flash pop-up button
To use the flash, press the flash pop-up button to release the flash.

INFO (information check) button
Press this button to view image information.
Photography mode: Displays the current settings (white balance, sharpness, etc.) and histogram.
Playback mode: Displays the information for the image currently displayed.

One-touch AF button
Focus the image once. This can only be used for manual focusing.

Focus mode selector switch
Changes among C-AF (Continuous AF), S-AF (Single AF) and MF (Manual focus).

Macro button
Use this for close-up shots. Pressing this button changes the modes as follows:
Macro → Super macro → Macro off (Normal)

Focal range: Normal	Wide-angle: approx. 50 cm (1.6 ft.) to infinity Telephoto: approx. 2 m (6.6 ft.) to infinity
Macro	Wide-angle: approx. 10 cm to 3 m (3.9 in. to 9.8 ft.) Telephoto: approx. 90 cm to 3 m (3.0 ft. to 9.8 ft.)
Super macro	Approx. 1 cm to 1 m (0.4 in. to 3.3 ft.) (Wide-angle only)

◆ **Displaying the on-screen Help** ◆

Instructions for the next step in the procedure appear at the bottom of the screen. Press the button indicated.

In the right side screen, press the "MENU/OK" button to erase the displayed frame. To cancel erasing, press the "DISP/BACK" button.



- Set the Power switch to "ON".
 - Set the Mode dial to "AUTO".
 - Set the Focus mode selector switch to "S-AF".
 - Focal range**
Wide-angle: approx. 50 cm (1.6 ft.) to infinity
Telephoto: approx. 2 m (6.6 ft.) to infinity
 - Use Macro mode for subjects closer than 50 cm (1.6 ft.) (→P.50).
 - When [CARD ERROR], [CARD NOT INITIALIZED], [CARD FULL] or [NO CARD] appears, see P.130.
- Press the Flash pop-up button to pop up the flash.

 - When the flash pops up, the image may disappear and go dark briefly due to flash charging. The indicator lamp blinks orange during charging.
 - If the flash is used in dusty conditions or when it is snowing, white dots may appear in the image due to flash reflecting off the dust particles or snowflakes. Use Suppressed flash mode to fix the problem.
- Press the "EVF/LCD" button to alternate the display between the viewfinder (EVF) and the LCD monitor.
When the AF frame in the viewfinder (EVF) is difficult to see, adjust the viewfinder using the Diopter adjustment dial.

The EVF/LCD selection is retained even when the camera is off or the mode setting is changed.

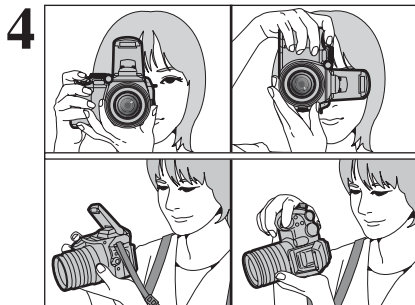

Brace your elbows against your sides and hold the camera with both hands.

- ⚠ Moving the camera while shooting gives a blurred picture (camera shake). Use a tripod to prevent camera shake, particularly for shots in the dark when the selected flash mode is Suppressed flash.
- ⚠ There may be some uneven brightness at the lower edge of the screen. This is normal and does not affect the photographed image.

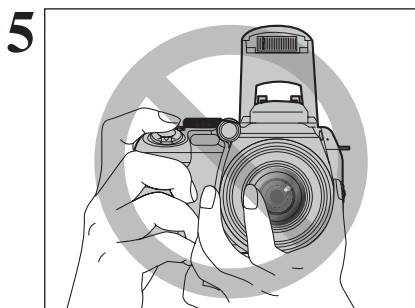

Hold the camera so that your fingers or the strap do not cover the lens, flash and AF-assist illuminator. If the lens, flash or AF-assist illuminator is obscured by your fingers or the strap, subjects may be out of focus or the brightness (exposure) of your shot may be incorrect.

- ⚠ Check that the lens is clean. If it is dirty, clean the lens as informed on P.125.

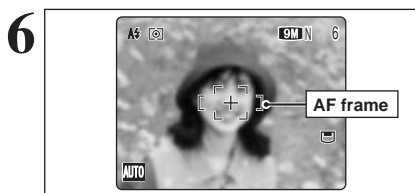

Frame the shot so that the subject fills the entire AF (Autofocus) frame.

- ⚠ The image shown on the screen before the picture is taken may differ in brightness, color, etc. from the image actually recorded. Play back the recorded image to check it (⇒P.31).
- ⚠ When the subject is not in the AF frame, use AF/AE lock to take the picture (⇒P.28).

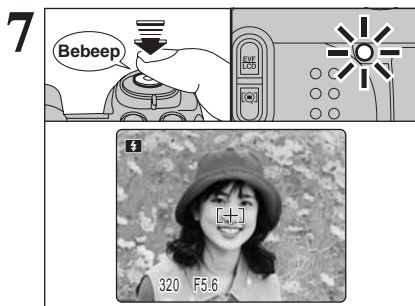

Press the shutter button down halfway. When a short double-beep is heard, the camera focuses on your subject. The AF frame on the screen becomes smaller and the camera sets the shutter speed and aperture. The indicator lamp (green) changes from blinking to lit.

- ⚠ When a short double-beep is not heard and "AF" appears on the screen, the camera cannot focus.
- ⚠ Pressing the shutter button down halfway freezes the image on the screen briefly. This image is not the recorded image.
- ⚠ When "AF" appears on the screen, press again the shutter button down halfway or try standing about 2 m (6.6 ft.) from your subject to take the picture.
- ⚠ The flash fires several times (pre-flashes and the main flash).

Before the flash fires, "AF" appears on the screen. When selecting a slow shutter speed that will cause camera shake, "!" appears on the screen. Use the flash to take pictures. According to the scene or mode being shot, use a tripod.

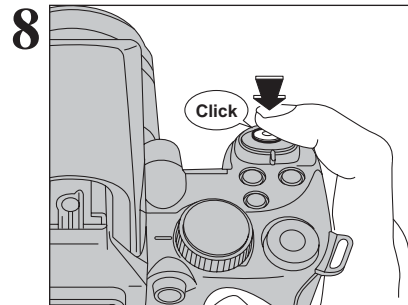

Press the shutter button down fully. When a clicking sound is heard, the camera records the image.

- ⚠ There is a slight delay between the shutter button being pressed and the picture being taken. Play back the shot to check the image.
- ⚠ When pressing the shutter button down fully in one motion, the camera takes the picture without the AF frame changing.
- ⚠ When pressing the shutter button fully, the indicator lamp lights orange (shooting disabled) and next picture can be taken after turning off the indicator lamp.
- ⚠ When taking a picture using flash, the image may disappear and go dark briefly due to flash charging. The indicator lamp blinks orange during charging.
- ⚠ See P.130-131 for information on the warning displays.

◆ Support for a cable release ◆

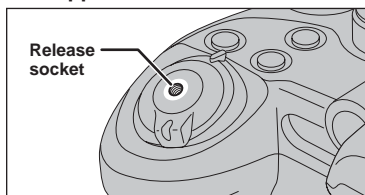

Use a mechanical cable release with this camera. To prevent camera shake, use a tripod (sold separately) and cable release (sold separately).

Compatible cable releases
ISO 6053: 1979-compliant cable releases

- ⚠ Do not apply force to a cable release attached to the camera. This could damage the camera.

◆ Compatible filters ◆

58 mm-diameter commercial available filters can be attached.

- ⚠ Do not use more than one filter at a time.
- ⚠ The lens cap (included) may not be used when attaching the filter.

◆ Subjects not suitable for autofocus ◆

The FinePix S9000 / FinePix S9500 uses a high-precision autofocus mechanism. However, it may have difficulty focusing on the following:

- Very shiny subjects such as a mirror or car body
 - Subjects photographed through glass
 - Subjects that do not reflect well, such as hair or fur
 - Subjects with no substance, such as smoke or flames
 - Dark subjects
 - Fast moving subjects
 - Subjects with little or no contrast between the subject and the background (such as white walls or subjects dressed in the same color as the background)
 - Shots where another high-contrast object (not the subject) is close to the AF frame and is either closer or further away than your subject (such as a shot of someone against a background with strongly contrasting elements)
- For such subjects use AF/AE lock (⇒P.28) or "MF" Manual focus mode (⇒P.49).

◆ Using LCD monitor ◆

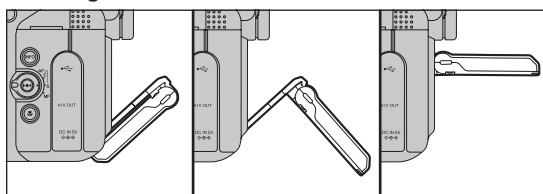

You can adjust any angle of the LCD monitor. It is useful to shoot the subject that is in a high or low location.

INDICATOR LAMP DISPLAY

Display	Status
Lit green	AF/AE lock in progress, Setting video output
Blinking green	Camera shake warning or AF warning (ready to shoot)
Blinking green and orange alternately	Recording to media (ready to shoot)
Lit orange	Recording to media (not ready)
Blinking orange	Charging the flash (flash will not fire)
Blinking red	<ul style="list-style-type: none"> Media Warnings No card inserted, card not formatted, incorrect format, card full and media error Lens operation error

* Detailed warning messages appear on the screen (P.130-131).

AF-ASSIST ILLUMINATOR

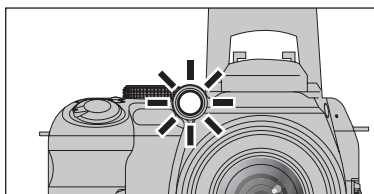

Press the shutter button down halfway in dimly lit conditions. The camera fires the AF-assist illuminator (green) to allow easier focusing. Note that the effective range decreases for telephoto shots.

- Even when the AF-assist illuminator fires, the camera may have difficulty focusing in some conditions.
- Even though there is no danger to safety, do not expose it directly in someone's eyes from a short distance.
- The camera focuses most easily when a picture is taken at a distance of around 3.5 m (11.5 ft.) with wide-angle and 2 m (6.6 ft.) with telephoto.
- When using the AF-assist illuminator in Macro mode, the camera may have difficulty focusing to take close-up shots.
- See P.100 for information on turning the AF-assist illuminator off.

NUMBER OF AVAILABLE FRAMES

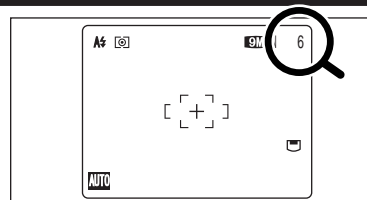

The number of available frames appears on the screen.

- See P.59 for information on changing the quality setting.
- The default quality "K" set at shipment is "9M N".

Standard number of frames per media

The table below shows the standard number of frames for a new media formatted on the camera. The larger the media capacity, the bigger the difference between the actual number of frames and the number shown here. Also, the size of an image file varies depending on the subject. So the number of remaining shots may decrease by 2 or may remain the same. For this reason, the number displayed may not show the actual number of frames.

Quality setting	9M F	9M N	3:2	5M	3M	2M	03M	RAW
Number of recorded pixels	3488 × 2616	3696 × 2464	2592 × 1944	2048 × 1536	1600 × 1200	640 × 480	—	—
DPC-16 (16 MB)	3	6	6	12	19	25	122	0
DPC-32 (32 MB)	6	13	13	25	40	50	247	1
DPC-64 (64 MB)	13	28	28	50	81	101	497	3
DPC-128 (128 MB)	28	56	56	102	162	204	997	6
DPC-256 (256 MB)	56	113	113	204	325	409	1997	13
DPC-512/M512 (512 MB)	113	227	227	409	651	818	3993	27
DPC-M1GB (1 GB)	228	456	456	819	1305	1639	7995	54
Microdrive 340 MB	77	155	155	279	445	559	2729	18
Microdrive 1 GB	234	469	469	842	1313	1642	8212	55

USING AF/AE LOCK

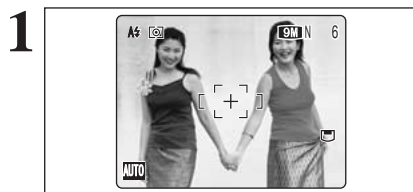

In this shot, the subjects (two people in this case) are not in the AF frame. Taking the picture at this point will result in the subjects being out of focus.

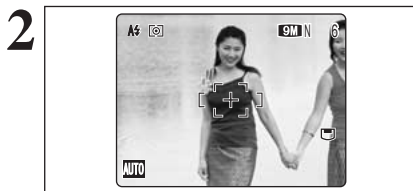

Move the camera slightly so that one of the subjects is in the AF frame.

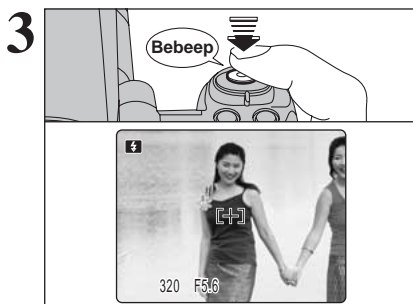

Press the shutter button down halfway (AF/AE lock). When a short double-beep is heard, the camera focuses on your subject. The AF frame on the screen becomes smaller and the camera sets the shutter speed and aperture. The indicator lamp (green) changes from blinking to lit.



Continue to hold the shutter button down halfway. Move the camera back to the original image and press the shutter button fully.

- AF/AE lock can be applied repeatedly before the shutter is released.
- Use AF/AE lock in all Photography modes to guarantee excellent results.

◆ AF (Autofocus)/AE (Auto-exposure) lock ◆

On the FinePix S9000 / FinePix S9500, pressing the shutter button down halfway locks the focus and exposure settings (AF/AE lock). To focus on a subject that is off to one side or to set the exposure before composing the final shot, locks the AF and AE settings. Then take the picture to get the best result.

● When the camera cannot focus and AF/AE lock does not give the correct exposure

Position the AF frame over the main subject and apply the AE lock (→P.46). Then position the AF frame over another subject at roughly the same distance. Press the shutter button down halfway. Recompose the shot and then take the picture.

USING ZOOM FUNCTION

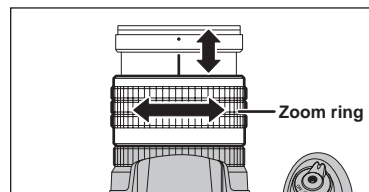

Turn the zoom ring to take pictures with zoom function. The zoom bar appears on the screen during zooming.

- **Optical zoom focal length (35 mm camera equivalent)**
Approx. 28 mm to 300 mm
Max. zoom scale: 10.7×

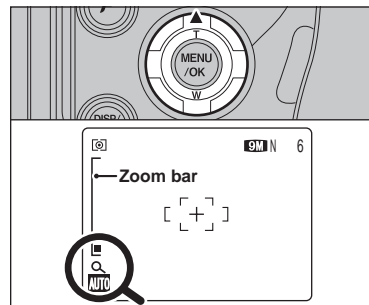

Press "▲" to change to Digital zoom mode (2×). When using digital zoom, "Q" appears in the bottom left corner of the screen and the zoom bar turns blue. Use the zoom ring to adjust digital zoom operation as well as optical zoom. Press the "▼" button to cancel the digital zoom.

SHOOTING ASSISTANT FUNCTION

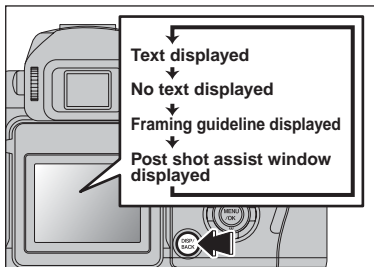

Select the framing guideline and post shot assist window in Photography mode. Pressing the “DISP/BACK” button changes the screen display.

Best framing

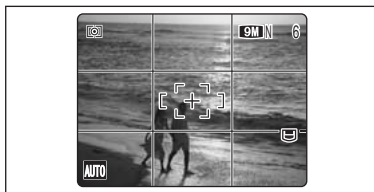

The framing guideline display consists of horizontal and vertical lines that divide the image on the screen into 9 frames.

◆ **Important** ◆

Always use AF/AE lock when composing a shot. The image may be out of focus if AF/AE lock is not used.

Scene

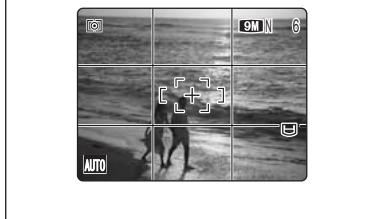

Position the main subject at the intersection of two lines in this frame or align one of the horizontal lines with the horizon. Use this frame as a guide to the subject's size and the balance of the shot while composing a shot.

- ☛ The framing guideline is not recorded on the image.
- ☛ The lines in the scene frame divide the image into 3 roughly equal parts horizontally and vertically. The resulting printed image may be shifted slightly from the scene frame.

Post shot assist window



When using the post shot assist window, the last photographed image appears as a thumbnail in the bottom left corner of the screen (post shot assist window).

Up to the last 3 photographed images appear on the post shot assist window. This serves as a guide for taking other shots with similar compositions.

- ☛ Any of the following clears the image in the post shot assist window:
 - Setting the camera to Playback mode
 - Turning the camera off
 - Using the PictBridge function
 - Using the DSC mode etc.

Single-frame playback

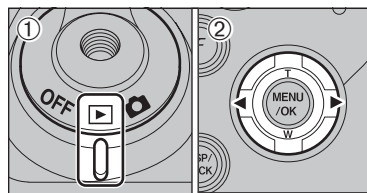

- ① Set the Power switch to “▶”.
- ② Press “▶” to scan forward through the images. Press “◀” to scan backwards.

☛ Set the Power switch to “▶” to play back the last shot.

Selecting images

To select images on the thumbnail lists screen, hold down “◀” or “▶” for 1 second during playback.



Multi-frame playback

In Playback mode, press the “DISP/BACK” button to change the display shown on the screen. Press the “DISP/BACK” button until the multi-frame playback screen (9 frames) appears.

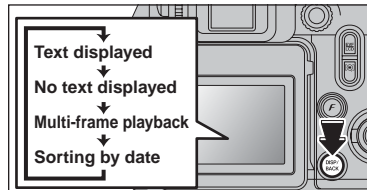

- ① Press “▲”, “▼”, “◀” or “▶” to move the cursor (colored frame) to the selecting frame. Press “▲” or “▼” repeatedly to jump to the next page.
- ② Press the “MENU/OK” button again to enlarge the image.

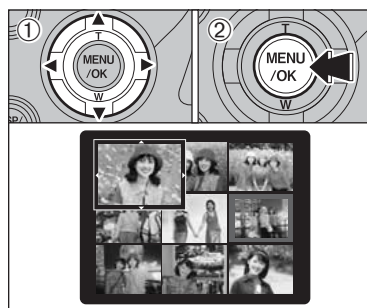

◆ **Still images viewable on the FinePix S9000 / FinePix S9500** ◆

This camera will display still images recorded on the FinePix S9000 / FinePix S9500 or still images (excluding some uncompressed images) recorded on any FUJIFILM digital camera that supports **xD-Picture Cards** or CF/Microdrives. Clear playback or playback zooming may not be possible for still images shot on cameras other than the FinePix S9000 / FinePix S9500.

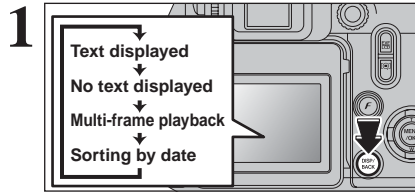

Sorting by date

In Playback mode, press the “DISP/BACK” button to change the display shown on the screen. Press the “DISP/BACK” button until the sorting by date screen appears.

Large number of images may take longer to appear.

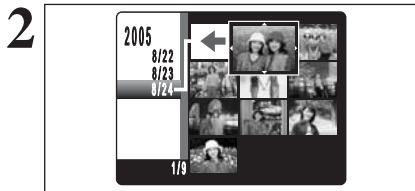

Changing to Sorting by date mode displays the images taken on the same day as the image selected in Multi-frame playback mode.

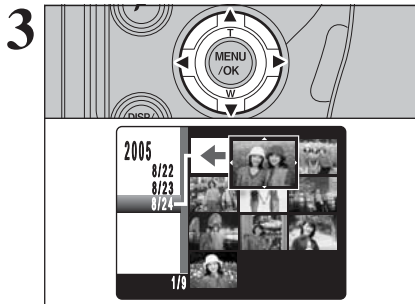

Press “▲”, “▼”, “◀” or “▶” to move the cursor (colored frame) to the selecting frame.

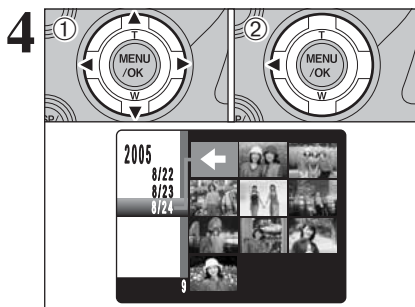

To select the date:
 ① Press “▲”, “▼”, “◀” or “▶” to move the cursor (colored frame) to “◀” on the upper left frame.
 ② Press “◀” to display the selecting date.

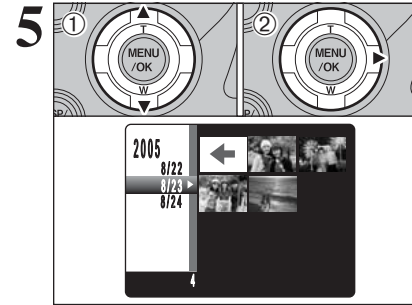

① Press “▲” or “▼” to move the cursor (colored frame) to select the date. Pressing “▲” or “▼” repeatedly changes to the next page.
 ② Press “▶” to return to “◀”.

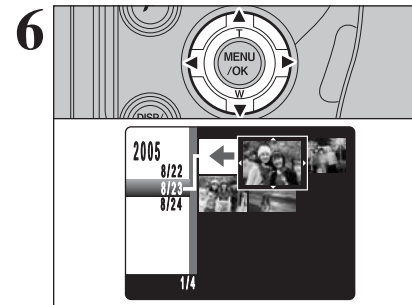

Press “▲”, “▼”, “◀” or “▶” to move the cursor (colored frame) to the selecting frame.

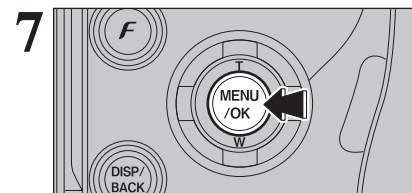

Press the “MENU/OK” button to enlarge the selected image.

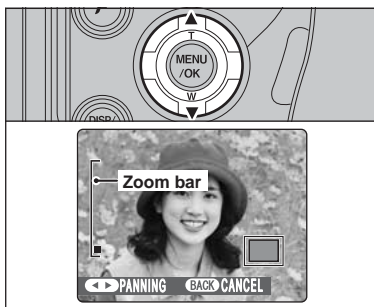

Playback zoom

Press “▲” or “▼” during single-frame playback to zoom the image. A zoom bar appears on the screen.

- 🔊 Press the “DISP/BACK” button to cancel playback zoom.
- 🔊 Playback zoom cannot be used with multi-frame playback.

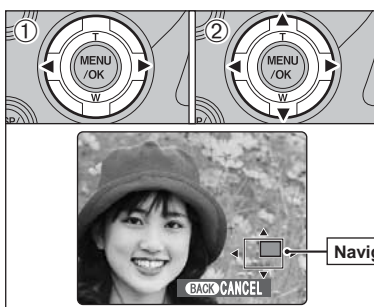

- ① Press “◀” or “▶” to select to “PANNING”.
 - ② Press “▲”, “▼”, “◀”, or “▶” to display another part of the image.
- The current displayed image appears on the navigation screen.

- 🔊 Press the “DISP/BACK” button to return to the zoom setting.

■ **Zoom scales**

Quality mode	Max. zoom scale
9M (3488 × 2616 pixels)	Approx. 5.5×
8.2 (3696 × 2464 pixels)	Approx. 5.8×
6M (2592 × 1944 pixels)	Approx. 4.1×
3M (2048 × 1536 pixels)	Approx. 3.2×
2M (1600 × 1200 pixels)	Approx. 2.5×

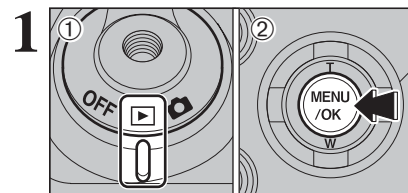

- ① Set the Power switch to “▶”.
- ② Press the “MENU/OK” button to display the menu on the screen.

Erased frames (files) cannot be recovered. Back up important frames (files) onto your PC or another media.

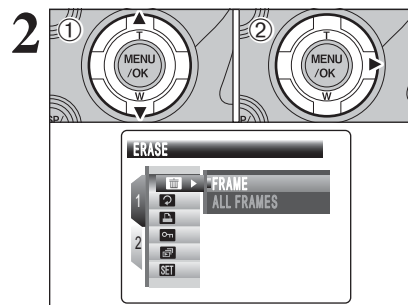

- ① Press “▲” or “▼” to select “” ERASE.
- ② Press “▶”.

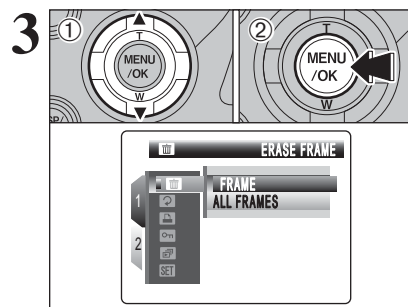

- ① Press “▲” or “▼” to select “FRAME”.
 - ② Press the “MENU/OK” button.
- See P.75 for information on “ALL FRAMES”.



- ① Press “◀” or “▶” to select the erasing frame (file).
- ② Press the “MENU/OK” button to erase the displayed frame (file).

To erase another frame (file), repeat steps ① and ②.
When erasing frames (files) is completed, press the “DISP/BACK” button.

- 🔊 Pressing the “MENU/OK” button repeatedly erases consecutive frames (files). Take care not to erase a frame (file) by mistake.

The distance from the subject to the camera is referred to as the shooting distance. When the shooting distance is set correctly and the image appears sharp, the image is focused.

■ Three focusing methods

The mechanisms for focusing are S-AF (Single AF), C-AF (Continuous AF) and MF (Manual focus).

S-AF: Use S-AF for normal photography. In this mode, the camera focuses each time the shutter button is pressed down halfway. Select the AF mode (→P.68) when the Mode dial is set to "P", "S", "A" or "M" mode.

◆ The AF sensor ◆

The FinePix S9000 / FinePix S9500 uses an external AF sensor (external-light passive phase difference AF) that features faster AF operation than previous models. The external AF sensor does not function when Macro mode, Super macro mode, the digital zoom, AREA or C-AF focusing is used. It may take longer to focus if the external AF sensor is soiled (→P.132).

C-AF: Use C-AF to photograph moving subjects. When this mode is set, the camera focuses continuously on the subject in the center of the screen. See P.48 for details.

MF: The focus is adjusted by turning the focusing ring manually. See P.49 for details.

■ Causes of focusing errors and the solutions

Cause	Solution
The subject is not in the AF frame.	Use AF lock (AF mode: AF (CENTER)) *1 or MF.
The subject is not suited to AF.	Use AF lock (AF mode: AF (CENTER)) *1 or MF.
The subject is outside the shooting range.	Turn Macro mode on or off *2.
The subject is moving too quickly.	Use MF (pre-setting the shooting distance for a shot)

*1 Taking pictures using AF lock

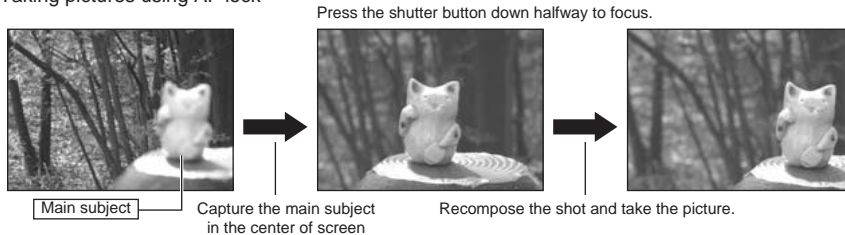

*2 Turning Macro mode ON/OFF

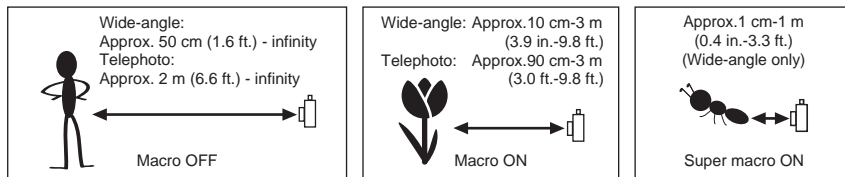

◆ Subjects not suitable for autofocus ◆

- Very shiny subjects such as a mirror or car body
- Subjects photographed through glass
- Subjects that do not reflect well, such as hair or fur
- Subjects with no substance, such as smoke or flames
- Dark subjects
- Fast moving subjects
- Subjects with little or no contrast between the subject and the background (such as white walls or subjects dressed in the same color as the background)
- Shots where another high-contrast object (not the subject) is close to the AF frame and is either closer or further away than your subject (such as a shot of someone against a background with strongly contrasting elements)

Exposure refers to the light that hits the CCD or the total amount of captured light and determines the brightness of the image.

The exposure is determined by the combination of aperture and shutter speed. In AE (Auto-exposure), the camera determines the correct exposure, allowing for factors such as the brightness of the subject and the sensitivity setting.

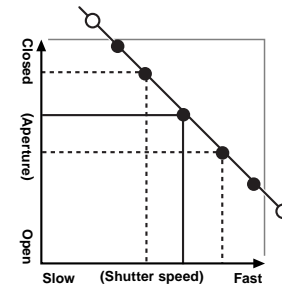

The graph at left shows the way the aperture and shutter speed settings can be changed while maintaining the same exposure level.

- When the aperture is decreased by one step, the shutter speed also decreases by one step (the dot moves upper left).
- When the aperture is increased by one step, the shutter speed also increases by one step (the dot moves lower right).
- Combinations that result in the shutter speed or aperture being outside the available range of settings cannot be selected (white dots).
- In the "P", "S" and "A" Photography modes, it is easy to select different settings along this line.
- Selecting settings that run parallel to this line by adjusting the brightness of the photographed image is referred to as exposure compensation.

◆ When you cannot get the correct exposure ◆

AE lock: Determines and fixes the exposure at a target level. Use the following procedure to take a picture using AE lock:

Press the "AE-L" button (sets and locks the exposure). → Press the shutter button down halfway (sets and fixes the focus). → Press the shutter button down fully (takes the picture).



Exposure compensation:

This function uses the exposure level set by the AE function as a reference (0) and then brightens (+) or darkens (-) the image. By selecting auto bracketing, you can shoot 3 frames, one underexposed (-), one at the reference exposure (0) and one overexposed (+).

Shutter speed

When shooting a moving subject, you can either "freeze the motion" or "capture the sense of movement" by adjusting the shutter speed.

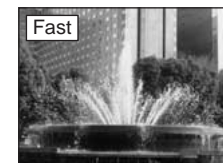

Freezes the motion of the subject.



Photographs the traces left by the subject's movement.

Aperture

By adjusting the aperture, you can change the depth of focus (depth of field).

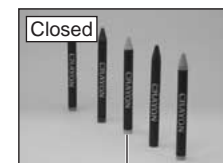

The area in front of and behind the subject is also in focus in the shot.



The area in front of and behind the subject is out of focus.

TAKING PICTURES — SELECTING THE CAMERA SETTINGS

Specify the camera settings for taking pictures to get the best result. A general guide is given below.

1 Select the Photography mode (⇒P.40-44).

AUTO Specifies all settings other than “Quality”, “Sensitivity” and “FinePix COLOR” on the camera.

Selects the best Scene position setting for the scene being shot.
P/S/A Changes the aperture or shutter speed setting so that the action is frozen, the flow of the motion is conveyed, or the background is out of focus.

M Adjusts all the camera settings yourself.

2 Specify the photography settings (⇒P.45-47, 50-56).

Exposure compensation Uses the AE exposure as a reference value of 0. This function brightens (+) or darkens (-) the shot.

AE-L AE lock Fixes the exposure settings.

Photometry Used for shots where the brightness of the subject and background differ markedly and the light is not metered as desired.

Macro/Super macro Used for close-up shots.

Flash Used for shots in dark locations or for backlit subjects, etc.

Continuous shooting Used to take a series of continuous shots or to use auto bracketing (with exposure compensation).

3 Take the pictures (check the exposure and focus ⇒ adjust the shot composition ⇒ press the shutter button down fully).

★ You can use the menus for more detailed settings (⇒P.59-73).

The table below provides a number of sample settings. Use the settings effectively.

To achieve this result	Sample settings
To express the motion of the subject	Set the Mode dial to “S” and select a slow shutter speed. Use a tripod to prevent camera shake.
To freeze the subject’s movement	Set the Mode dial to “S” and select a fast shutter speed.
To make the subject stand out by having the area in front of and behind the subject out of focus	Set the Mode dial to “A” and select a wide aperture setting.
To get a very large depth of focus	Set the Mode dial to “A” and select a narrow aperture setting. Use a tripod to prevent camera shake because shutter speed decreases.
To prevent the image from having a red or blue cast due to the light source	Change the “White balance” setting in the photography menu.
To avoid missing snapshot opportunities	Take pictures in AUTO mode (see “Using the Camera”). Shoot with HIGH-SPEED SHOOTING.
To prevent the subject from being overexposed or underexposed and to show the substance and textures of the subject clearly	Use exposure compensation. Select (+) if the background is pale and (-) if the background is dark.

List of functions available in each mode

✓: YES, —: NO

Photography mode	Function	AUTO	Anti-blur	Natural light	Portrait	Landscape	Night	P	S	A	M
		P.40							P.41-44		
	Exposure compensation	P.45	—	—	—	—	—	✓	✓	✓	—
	AE-L AE lock	P.46	✓	—	—	—	—	✓	✓	✓	—
	Photometry	P.47	✓	—	—	—	—	✓	✓	✓	—
	Focus mode (S-AF/C-AF/MF)	P.22	✓	—	—	—	—	✓	✓	✓	—
	Macro/ Super macro	P.50	✓	✓	—	—	—	✓	✓	✓	—
Flash	Auto flash	P.52	✓	✓	—	—	—	✓	—	—	—
	Red-eye reduction	P.52	✓	✓	—	—	—	✓	✓	✓	—
	Forced flash	P.52	✓	✓	—	—	—	✓	✓	✓	—
	Slow synchro	P.52	—	—	—	—	—	✓	—	✓	—
	Red-eye reduction+ Slow synchro	P.52	—	—	—	—	—	✓	—	✓	—
Continuous shooting	Top 4-frame	P.55	✓	—	—	—	—	✓	✓	✓	—
	Auto bracketing	P.55	—	—	—	—	—	✓	✓	✓	—
	Final 4-frame	P.55	✓	—	—	—	—	✓	✓	✓	—
	Long-period (up to 40 frames)	P.56	✓	—	—	—	—	—	—	—	—

* The flash cannot be used for Continuous shooting and Super macro.

List of menu options available in each mode

✓: YES, —: NO

Photography mode	Menu	Page	Factory default	AUTO		P	S	A	M	
FinePix Photo mode	QUALITY	P.59	GMN	✓	—	✓	✓	✓	✓	
	ISO	P.61	—	✓	✓*1	✓	✓	✓	✓	
	FinePix COLOR	P.62	STD	✓	—	✓	✓	✓	✓	
Photography menu	Self-timer	P.65	OFF	✓	—	✓	✓	✓	✓	
	White balance	P.66	AUTO	—	—	✓	✓	✓	✓	
	High-speed shooting	P.67	OFF	✓	—	✓	✓	✓	✓	
	AF mode	CENTER	P.68	—	✓	—	✓	✓	✓	✓
		MULTI	P.68	—	—	—	✓	✓	✓	✓
		AREA	P.69	—	—	—	✓	✓	✓	✓
	Flash brightness adjustment	P.69	0	—	—	✓	✓	✓	✓	
	Sharpness	P.69	STD	—	—	✓	✓	✓	✓	
	Saturation	P.70	STD	—	—	✓	✓	✓	✓	
	Contrast	P.70	STD	—	—	✓	✓	✓	✓	
Bracketing	P.70	±1/3EV	—	—	✓	✓	✓	✓		
Multiple exposure	P.71	OFF	—	—	✓	✓	✓	✓		
External flash	P.72	OFF	—	—	✓	✓	✓	✓		

*1 “” Anti-blur and “” Natural light can be selected in only the “AUTO” mode.

* MULTI, AREA and Continuous AF (C-AF) cannot be used together.

When shutter speed and aperture adjustments alone do not give the correct exposure.

When the image is too bright
 Lower the sensitivity setting.
 Use an ND filter (sold separately).

When the image is too dark
 Raise the sensitivity setting.
 Use flash or the brightness adjustment function.

AUTO AUTO

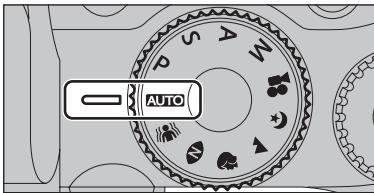

Set the Mode dial to "AUTO". This is the easiest mode to use and can be used for most types of shots.

See P.39 for information on available flashes.

SCENE POSITION

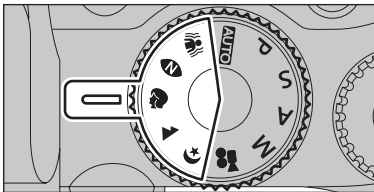

Set the Mode dial to "Anti-blur", "Natural light", "Portrait", "Landscape" or "Night". This mode provides the best Scene position setting for the scene being shot.

"Portrait", "Landscape" and "Night" cannot be selected Macro mode.

Scene position settings	Explanation	Available flash modes
Anti-blur	Using this mode selects a fast shutter speed that reduces camera shake and moving-subject blurring.	A $\frac{1}{2}$ / / $\frac{1}{2}$
Natural light	This mode produces beautiful images that retain the natural ambience when shots are taken in low-light conditions. This mode is also ideal for situations where the flash cannot be used. Sample uses: • Portraits of sleeping children, pets and birthday cakes • Candlelit services (weddings, etc.) and school concerts • Restaurants, aquariums, museums and churches	Flash not available. When the flash is popped up, "Ⓢ" appears.
Portrait	Used for photography getting beautiful skin tones and soft overall tone.	A $\frac{1}{2}$ / / $\frac{1}{2}$ / S $\frac{1}{2}$ /
Landscape	Used for shooting scenery in daylight and provides crisp, clear shots of scenery such as buildings and mountains.	Flash not available. When the flash is popped up, "Ⓢ" appears.
Night	Used for shooting evening and night scenes. This mode allows you to take shots where priority is given to slow shutter speeds of up to 4 seconds. To prevent camera shake, always use a tripod.	S $\frac{1}{2}$ /

In Anti-blur or Natural light mode, when you have been used for long periods in places subject to extreme temperature rises, it will lower your image quality and streaking may also be visible in your images. If this occurs, turn the camera off several times to prevent heating the camera. Setting High-speed shooting mode to "OFF" is effective.

Changing the Photography mode

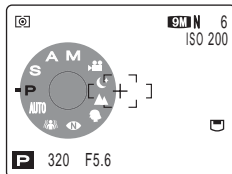

When turning the Mode dial, the Mode dial appears on the screen to check the selected mode. You can operate watching the screen. It is useful such as when taking pictures using viewfinder (EVF).

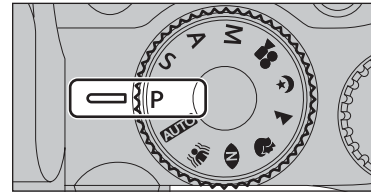

Set the Mode dial to "P". This is an automatic mode to specify the settings except for the shutter speed and aperture setting. This is a simple way to take pictures the same as the Shutter-priority Auto and Aperture-priority Auto modes (Program shift).

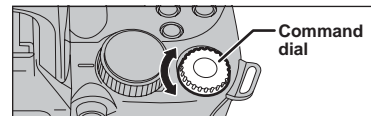

Command dial

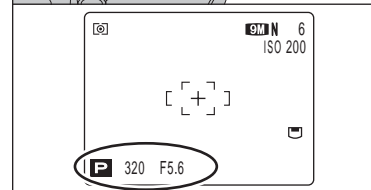

Program shift

Turn the Command dial to select different shutter speed and aperture setting combinations without changing the exposure setting. The shutter speed and aperture setting appear in yellow when the camera is in Program shift mode.

- Any of following cancels Program shift:
 - Changing the Mode dial setting
 - Popping the flash up
 - Setting "EXTERNAL FLASH" to "ON" in the Photography menu
 - Setting the camera to Playback mode
 - Turning the camera off

The shutter speed and aperture setting display

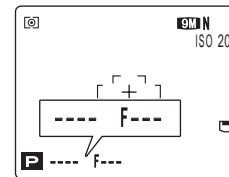

When the brightness of the subject is outside the camera's brightness metering range, "----" appears as the shutter speed and aperture setting on the screen.

S SHUTTER-PRIORITY AUTO

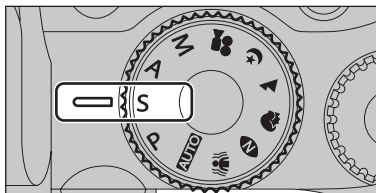

Set the Mode dial to "S".
This is an automatic mode to set the shutter speed. Use this mode to freeze a moving subject (fast shutter speed) or convey the impression of movement (slow shutter speed).

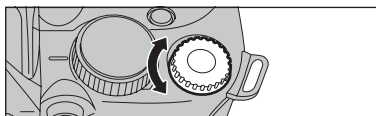

Setting the shutter speed

Turn the Command dial to select the shutter speed.

● Shutter speed setting

- Wide-angle:
4 sec. to 1/4000 sec. in 1/3 EV increments
- Telephoto:
4 sec. to 1/2000 sec. in 1/3 EV increments

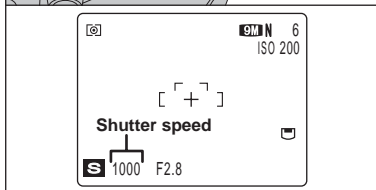

◆ The shutter speed and aperture setting display ◆

Overexposed

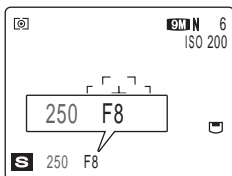

In scenes that are extremely overexposed, the aperture setting (F8) appears in red. When this occurs, select a faster shutter speed (up to 1/4000 sec.).

Underexposed

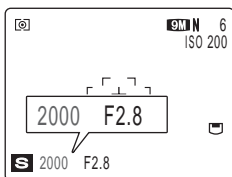

In scenes that are extremely underexposed, the aperture setting (F2.8) appears in red. When this occurs, select a slower shutter speed (down to 4 sec.).

Metering failed

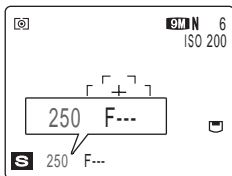

When the brightness of the subject is outside the camera's brightness metering range, "F---" appears as the aperture setting. When this occurs, press the shutter button down halfway to measure the light level again and display a value.

A APERTURE-PRIORITY AUTO

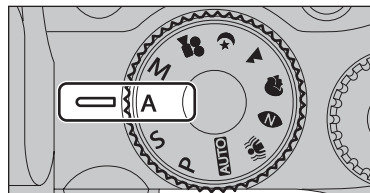

Set the Mode dial to "A".
This is an automatic mode to set the aperture. Use this mode to have the area in front of and behind the subject out of focus (large aperture) or have both near and far subjects in focus (small aperture).

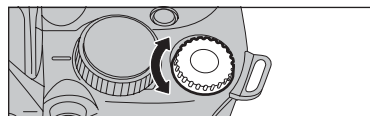

Setting the aperture

Turn the Command dial to select the aperture.

● Aperture settings

- Wide-angle: F2.8 to F8 in 1/3 EV increments
- Telephoto: F4.9 to F8 in 1/3 EV increments

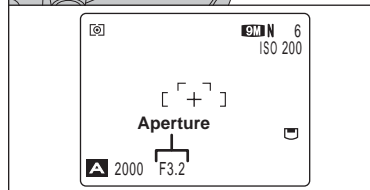

◆ The shutter speed and aperture setting display ◆

Overexposed

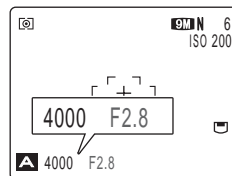

In scenes that are extremely overexposed, the shutter speed setting (1/2000 sec. or 1/4000 sec.) appears in red. When this occurs, select a larger number of aperture (up to F8).

Underexposed

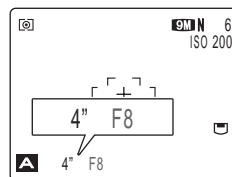

In scenes that are extremely underexposed, the shutter speed setting (4 sec.) appears in red. When this occurs, select a smaller number of aperture.

Metering failed

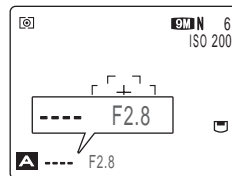

When Forced flash mode is selected, the slowest available shutter speed is 1/45 sec.

When the brightness of the subject is outside the camera's brightness metering range, "----" appears as the shutter speed setting. When this occurs, press the shutter button down halfway to measure the light level again and display a value.

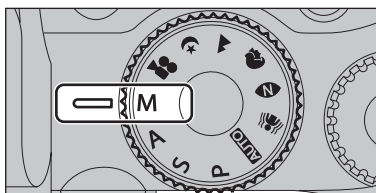

Set the Mode dial to "M".
Use Manual mode to set any shutter speed and aperture setting.

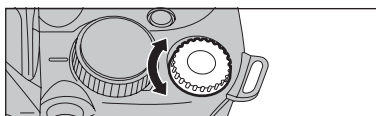

Setting the shutter speed

Turn the Command dial to select the shutter speed.

● Shutter speed setting

30 sec. to 1/4000 sec. in 1/3 EV increments
Bulb (B)

- ⚡ See P.137 for information on EVs.
- ⚡ Use a tripod or cable release to prevent camera shake.
- ⚡ In shots with long exposures, noise (dots) may appear on the image.
- ⚡ If the shutter speed is set to a speed faster than 1/2000 sec., smearing (white stripes) may appear in the image (→P.137).
- ⚡ If the shutter speed is set to a speed faster than 1/1000 sec., the image may appear dark even if the flash is used.

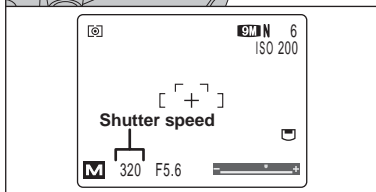

◆ Bulb photography ◆

Setting shutter speed to "B" (Bulb) allows bulb shots to be taken. In bulb photography, the shutter stays open for as long as the shutter button is held down (up to 30 seconds). Use a tripod or a cable release to keep the camera steady.

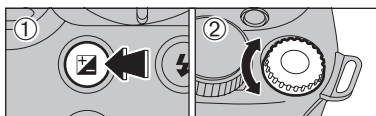

Setting the aperture

- ① Hold down the "Fn" button.
- ② Turn the Command dial to select aperture.

● Aperture settings

Wide-angle: F2.8 to F11 in 1/3 EV increments
Telephoto: F4.9 to F11 in 1/3 EV increments

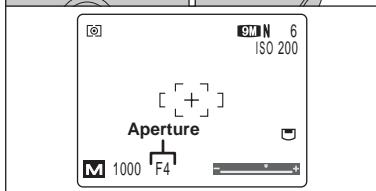

◆ The exposure indicator ◆

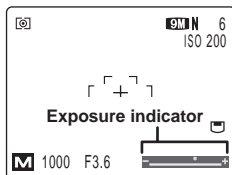

Use the exposure indicator on the screen as a guide when setting the exposure.
When the brightness of the subject is outside the camera's brightness metering range, the exposure indicator disappears on the screen.

Use this function for shots to get the correct brightness (exposure), such as shots with extremely high contrast between the subject and the background.

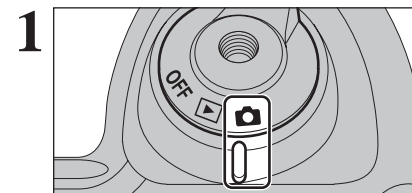

1 Set the Power switch to "CAM".

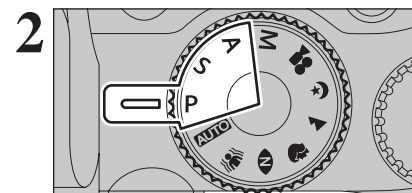

2 Set the Mode dial to "P", "S" or "A" mode.

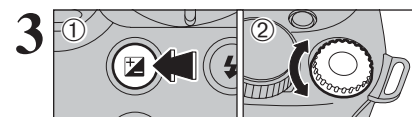

- ① Hold down "Fn" button.
- ② Turn the Command dial to set the compensation value.

The symbol indicating the compensation direction (– or +) turns yellow. The "Fn" icon also turns yellow while exposure compensation is being set and then turns blue after setting is completed.

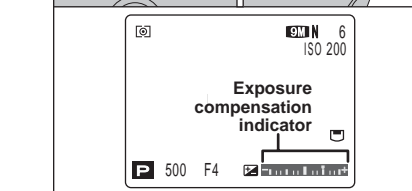

● Compensation range

–2 EV to +2 EV (13 steps in 1/3 EV increments)

- ⚡ Exposure compensation cannot be used in the "AUTO", "M", "A", "S", "P", "L", "M", "M" and "M" modes.
- ⚡ The screen brightness will increase or decrease depending on the exposure compensation setting.
- ⚡ The following disables exposure compensation:
Shooting dark scenes in "4" Forced flash or "Red-eye reduction mode.

This setting is retained when the mode is changed or the camera is turned off ("Fn" icon appears). Set the exposure compensation to "0" unless compensation is required.

◆ To obtain the optimum brightness ◆

Adjust the exposure compensation according to the level of brightness or darkness in the image.

- When the subject appears too bright
Try a negative (–) compensation setting.
This will make the overall image darker.
- When the subject appears too dark
Try a positive (+) compensation setting.
This will make the overall image brighter.
- Guide to compensation
 - Backlit portraits: +2 steps to +4 steps (+ $\frac{2}{3}$ EV to +1 $\frac{1}{3}$ EV)
 - Very bright scenes (such as snowfields) and highly reflective subjects: +3 steps (+1 EV)
 - Shots made up predominantly of sky: +3 steps (+1 EV)
 - Spotlight subjects, particularly against dark backgrounds: –2 steps (– $\frac{2}{3}$ EV)
 - Scenes with low reflectivity, such as shots of pine trees or dark foliage: –2 steps (– $\frac{2}{3}$ EV)

AE-L USING AE LOCK

Available Photography modes: **AUTO**, , , , , , 

Use this function to take pictures with the exposure locked for a particular subject.

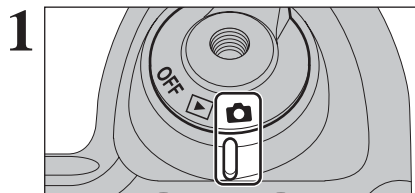

1 Set the Power switch to "CAM".

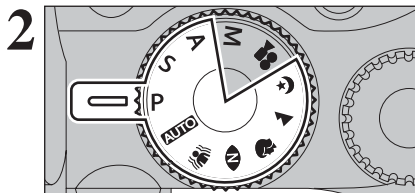

2 Set the Mode dial to "AUTO", , , , "P", "S" or "A" mode.

 AE lock cannot be used when Long-period continuous shooting is selected.

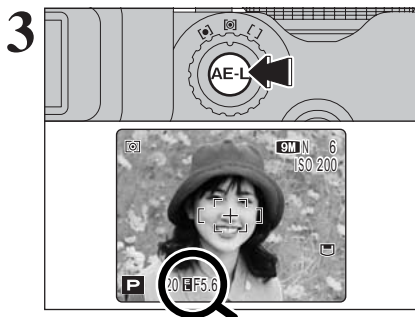

3 Position the subject in the center of the screen and press the "AE-L" button. "AE-L" appears on the screen and the exposure is locked while you hold down the "AE-L" button.

AE-L1	The exposure is locked while holding down the "AE-L" button.
AE-L2	Pressing the "AE-L" button locks the exposure. Press the "AE-L" button again to cancel the setting.

 See P.100 for information on changing the setting to AE-L1/AE-L2.

 AE lock can be canceled when zooming the subject during AE lock.

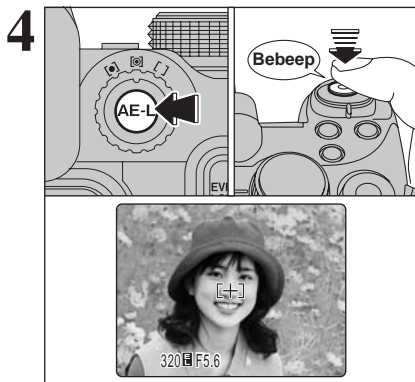

4 With the "AE-L" button held down, press the shutter button down halfway to focus the shot and then compose the shot again.

 Once you press the shutter button down halfway, the exposure remains locked even if you release the "AE-L" button.

 When the AE lock is applied, pressing the shutter button down halfway only sets the focus.

Available Photography modes: **AUTO**, , , , **ADJUSTING LIGHT METERING (PHOTOMETRY)** , , , P, S, A, M

Use this setting for scenes where the brightness of the subject and background differ markedly so that the MULTI setting is unlikely to achieve the desired result.

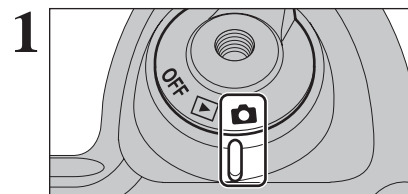

1 Set the Power switch to "CAM".

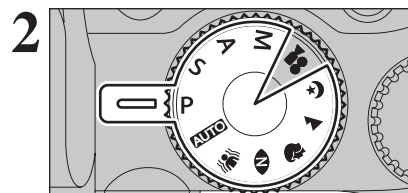

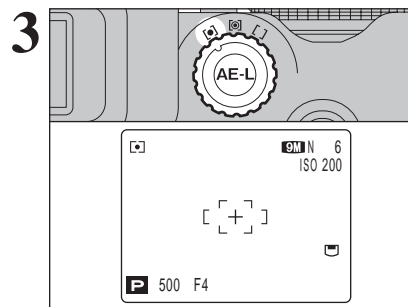

2 Set the Mode dial to Photography mode.



3 Turn the Photometry selector dial to select the light metering method.

 **Multi (Pattern):** Light metering where the camera assesses the scene and selects the correct exposure.

 **Spot:** Light metering where the exposure is optimized for the center of the image.

 **Average:** Light metering where an average value for the entire image is used.

◆ The photometry modes are effective for the following subjects ◆

• **Multi**

In this mode, the camera uses automatic scene recognition to analyze the subject and provide optimum exposure in a wide range of shooting conditions. This mode should be used for everyday photography.

• **Spot**

This mode is useful for subjects with strongly contrasting light and dark areas where you want to achieve the correct exposure for a particular feature.

• **Average**

The advantage of this mode is that the exposure tends not to change for different compositions or subjects. This mode is particularly effective for shots of people wearing black or white clothing and shots of scenery.

CONTINUOUS AF

Available Photography modes:
AUTO, , **N**, , , , **S**, **A**, **M**

Use this button to take pictures of a moving subject. Using Continuous AF mode reduces the time required for focusing.

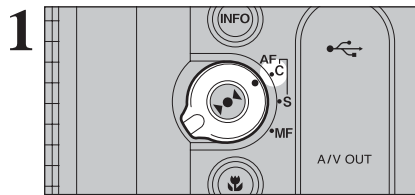

1 Set the Focus mode selector switch to "C-AF".

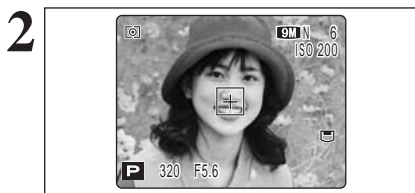

2 Frame the shot so that the subject fills the entire AF frame. The camera continues to focus on the main subject in the AF frame.

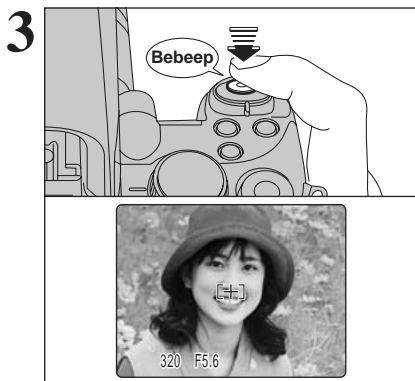

3 Press the shutter button down halfway. When a short double-beep is heard, the camera focuses on your subject. The AF frame on the screen becomes smaller and the camera sets the shutter speed and aperture. The indicator lamp (green) changes from blinking to lit.

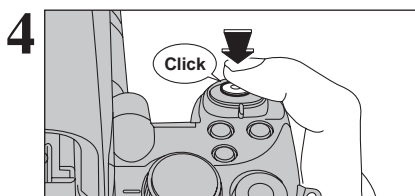

4 Press the shutter button down fully. When a clicking sound is heard, the camera records the image.

◆ Notes on continuous AF ◆

Because the camera focuses continuously without pressing the shutter button, note the following:

- Watch the battery level carefully since the camera consumes more power in this mode than in other Focus modes (S-AF and MF).
- If the Auto power off function is set to "OFF", particular attention must be given to the battery level.

MANUAL FOCUS

Available Photography modes:
AUTO, , **N**, , , , **S**, **A**, **M**

Use manual focus to lock the focus for a shot.

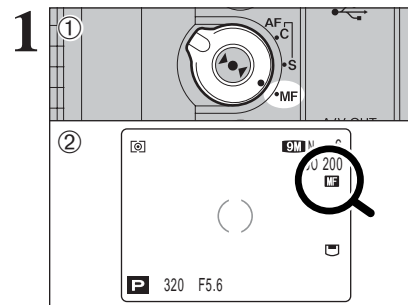

- 1 Set the Focus mode selector switch to "MF".
- 2 The "⊙" appears on the screen.

- ⚠ If the focus is set to infinity using manual focusing, position the "∞" mark on a subject close to infinity. Continuing to turn the focus ring will move the focus position beyond infinity and defocus the image.
- ⚠ Manual focus cannot be used in the "🎥" Movie mode.

◆ Using manual focus effectively ◆

The image is unfocused when the camera moves. Use a tripod to prevent camera shake.

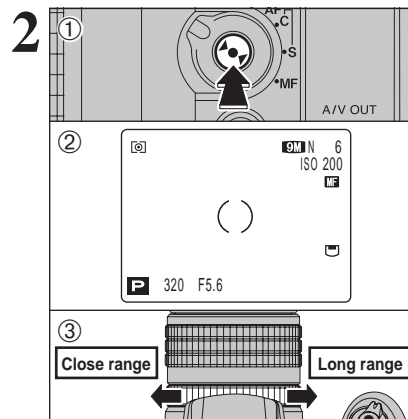

- 1 Press "▶●◀" button to focus on the subject in the focus frame.
- 2 A focusing indicator mark appears on the screen. Check whether "⊙" mark appears in yellow.
- 3 When the "⊙" mark is not yellow, turn the focus ring until the "⊙" mark appears in yellow.

■ Focusing indicator marks

The focusing mark appears when the focus is close to the focused position. Use the mark to focus the shot.

⊙ (Yellow)	The shot is focused.
⊙	The focus is set too close. Turn the focus ring clockwise.
⊙	The focus is set too far. Turn the focus ring counterclockwise.

◆ One-touch AF function ◆

Use this function to focus the shot quickly.

Pressing the "▶●◀" button, the camera uses the autofocus function to focus on the subject.

- ⚠ The focus indicator does not appear in One-touch AF mode.

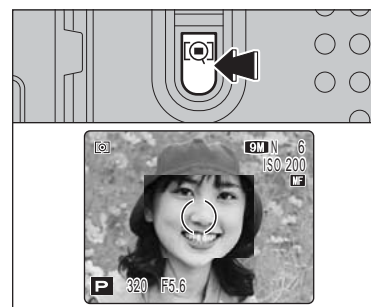

🔍 Focus check function

Use this function when it is difficult to see whether the image is focused.

Pressing the "🔍" button, the center of the image is shown enlarged and can be focused using the enlarged image. Take the picture or press the "🔍" button again to return to normal display.

- ⚠ Focus check function can be used in the "📷" CENTER and "MF" mode.
- ⚠ Focus check function is disabled when setting the High-speed shooting mode or setting "📷" EVF/LCD MODE to "60 fps" in the "📷" SET-UP menu.

MACRO (CLOSE-UP)

Available Photography modes:

AUTO, , , P, S, A, M

Select Macro mode to take close-up shots.

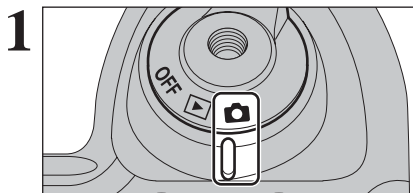

1 Set the Power switch to "📷".

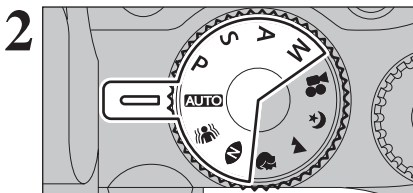

2 Set the Mode dial to "AUTO", , "N", "P", "S", "A" or "M" mode.

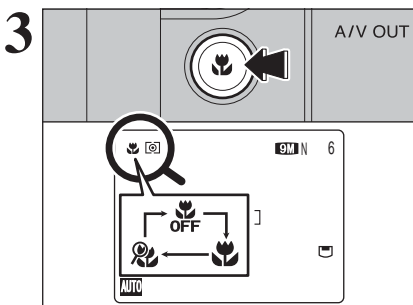

3 The Macro mode setting changes each time you press the button.

- ⚠ Any of the following cancels Macro mode:
 - Changing the Mode dial to "📷", "▲", "📷" or "📷" mode
 - Turning the camera off
- ⚠ If the flash is too bright, use flash brightness adjustment (➡P.69).
- ⚠ Use a tripod to prevent camera shake when shooting in the dark (when "f" appears).
- ⚠ Selecting MULTI in the AF mode, the focusing position remains near the center of the screen.

	Focal range	Effective flash range
Macro	Wide-angle: Approx. 10 cm-3 m (3.9 in. to 9.8 ft.) Telephoto: Approx. 90 cm-3 m (3.0 ft. to 9.8 ft.)	Wide-angle: Approx. 30 cm-3 m (1.0 ft.-9.8 ft.) Telephoto: Approx. 90 cm-3 m (3.0 ft.-9.8 ft.)
Super macro	Approx. 1 cm-1 m (0.4 in.-3.3 ft.) (Wide-angle only)	Flash not available

◆ Super macro ◆

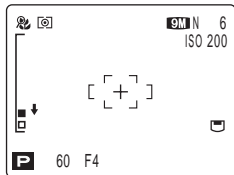

Use the lens at the wide-angle zoom setting in Super macro mode. If your camera select any other settings, "↓" appears on the screen. Turn the zoom ring to adjust zoom setting as indicated "↓".

FLASH PHOTOGRAPHY

Available Photography modes:

AUTO, , , , S, A, M

Choose from 5 flash modes according to the type of shot.

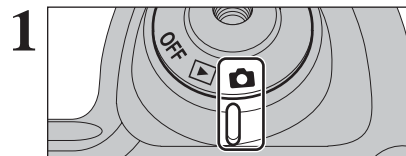

1 Set the Power switch to "📷".

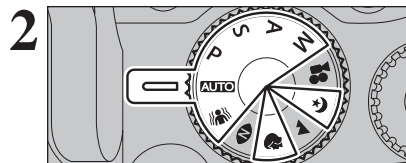

2 Set the Mode dial to "AUTO", , "N", "P", "S", "A", or "M" mode.

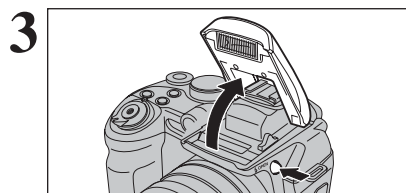

3 Press the Flash pop-up button to pop-up the flash.

- **Effective flash range** ("📷": AUTO)
 - Wide-angle: approx. 30 cm to 5.6 m (1.0 ft. to 18.4 ft.)
 - Telephoto: approx. 60 cm to 3 m (2.0 ft. to 9.8 ft.)

- ⚠ If the shutter speed is set to a speed faster than 1/1000 sec., the image may appear dark even if the flash is used.
- ⚠ When the flash pops up, the image may disappear and go dark briefly due to flash charging. The indicator lamp blinks orange during charging.

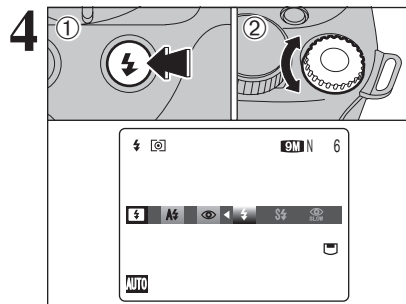

- ① Hold down the "⚡" button.
- ② Turn the Command dial to select the flash mode setting.

⚠ See P.72 for information on using an external flash.

The available flash modes are limited depending on the Photography mode selected (➡P.39).

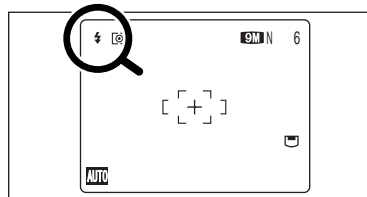

"A4", "👁", "⚡", "S4" or "📷" appears on the screen when using flash.

- ⚠ If the flash is used in dusty conditions or when it is snowing, white dots may appear in the image due to flash reflecting off the dust particles or snowflakes. Use Suppressed flash mode to fix the problem.
- ⚠ The flash charging time may increase when the batteries are low on charge.
- ⚠ When taking a picture using flash, the image may disappear and go dark briefly due to flash charging. The indicator lamp blinks orange during charging.
- ⚠ The flash fires several times (pre-flashes and the main flash).

When pressing the shutter button down halfway, "📷" appears on the screen before the flash fires.

Continued

⚡ FLASH PHOTOGRAPHY

Available Photography modes:

AUTO, , , , , P, S, A, M

⚡ Auto flash

Use this mode for ordinary photography. The flash fires as required by the shooting conditions.

- ⚠ If pressing the shutter button while the flash is charging, the picture will be taken without the flash.



👁 Red-eye reduction

Use this mode to guarantee that the subject's eyes appear normal when taking pictures of people in low-light conditions. The flash fires a pre-flash just before the picture is taken and then fires again to take the actual picture. The flash fires as required by the shooting conditions.

- ⚠ If pressing the shutter button while the flash is charging, the picture will be taken without the flash.

◆ Red-eye effect ◆

When using the flash to take a picture of people in low-light conditions, their eyes sometimes appear red in the picture. This is caused by the light of the flash reflecting off the inside of the eye. Use Red-eye reduction flash to minimize the likelihood of this effect.

Take the following measures to make Red-eye reduction more effective:

- Get the subjects to look at the camera.
- Get as close as possible to the subjects.



⚡ Forced flash

Use this mode in backlit scenes, such as a subject against a window or in the shade of a tree, or to get the correct colors when taking a picture under bright lighting. In this mode, the flash fires in bright as well as dark conditions.



⚡ Slow synchro

This is a flash mode that uses a slow shutter speed. This allows you to take pictures of people at night that clearly show both your subjects and the night time backdrop. To prevent camera shake, always use a tripod.

- **Slowest shutter speed**
 **Night:** up to 4 sec.

👁 SLOW Red-eye reduction + Slow synchro

Use this mode for Slow synchro shots with Red-eye reduction.

- ⚠ The image may be overexposed when shooting bright scenes.

To take a picture of a main subject at night with the background brightly lit, use the  Night setting in Photography mode (⇒P.40).

◆ Suppressed flash ◆

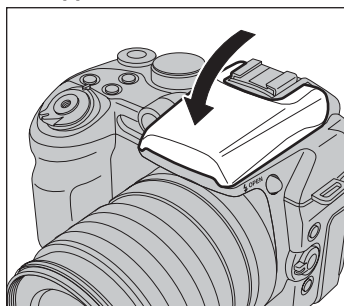

Pressing the flash down changes the camera to Suppressed flash mode.

Use this mode for taking pictures using indoor lighting, for shots taken through glass, and for photography in places such as theaters or at indoor sporting events where the distance is too great for the flash to be effective. When you use Suppressed flash, the selected white balance function (⇒P.66) operates so that natural colors are captured along with the ambience of the available light.

- ⚠ Use a tripod to prevent camera shake when shooting in Suppressed flash mode in the dark condition.
- ⚠ See P.130 for information on the camera shake warning.

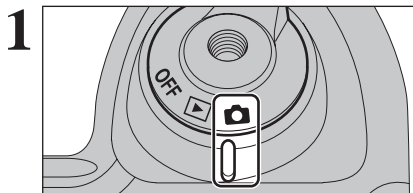

Set the Power switch to "ON".

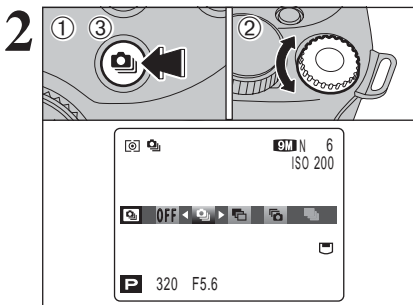

- ① Hold down the "shutter" button.
- ② Turn the Command dial to select the Continuous shooting mode.
- ③ Release the "shutter" button to confirm your selection.

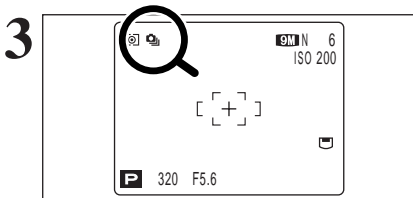

When setting the Continuous shooting mode (except for "OFF"), the selected mode appears on the screen.

- : Top 4-frame continuous shooting
- : Auto bracketing
- : Final 4-frame continuous shooting
- : Long-period continuous shooting

◆ **Notes on using the Continuous shooting modes** ◆

- Shooting continues as long as holding the shutter button down. In auto bracketing mode however, just press the shutter button once to shoot 3 frames.
- If there is limited space on the media, as many frames as can be recorded on the available space are shot. When auto bracketing, if there is insufficient space on the media to record 3 frames, no pictures are taken.
- The focus is determined in the first frame and cannot be changed in mid-sequence (excluding Long-period continuous shooting).
- The exposure is determined in the first frame, however, in Long-period continuous shooting the exposure is adjusted for the scene being shot.
- The speed of continuous shooting varies depending on the shutter speed.
- The speed of continuous shooting does not change with the quality setting.
- The flash cannot be used as the flash mode is set to Suppressed flash.
- For top 4-frame continuous shooting, final 4-frame continuous shooting and pictures taken using auto bracketing, the results are always displayed after you shoot.

Top 4-frame continuous shooting

Available Photography modes: **AUTO**, , **N**, , , , **M**

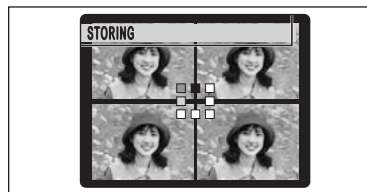

This mode shoots up to 4 frames (max. 1.5 frames/sec.). When taking the pictures, the images appear and are recorded.

- ⚠ Top 4-frame continuous shooting cannot be used in the "Movie mode".
- ⚠ The maximum file recording time using the continuous shooting is 15 seconds when recording in **xD-Picture Card**.

Auto bracketing

Available Photography modes: **P**, **S**, **A**, **M**

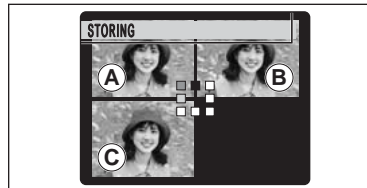

This mode shoots the same image with different exposure settings. Bracketing shoots 3 continuous frames, each with a different exposure setting.

A is correctly exposed, **B** is overexposed and **C** is underexposed.

The settings (exposure range) can be changed in the photography menu.

- **Auto bracketing settings (3)**
±1/3 EV, ±2/3 EV, ±1 EV

- ⚠ If the underexposed or overexposed frame is outside the camera's control range, the picture is not taken with the specified setting increments.
- ⚠ Auto bracketing cannot be used in "AUTO", "Movie mode", "N", "P", "S", "A", "M", "C" or "Self-timer" mode.

Changing the setting (exposure range)

Press the "MENU/OK" button to display the menu and change the setting in the "BRACKETING" menu option (P.70).

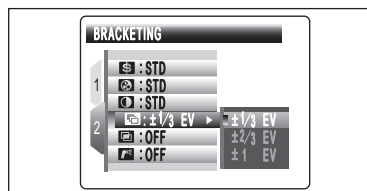

Final 4-frame continuous shooting

Available Photography modes: **AUTO**, , **N**, , , , **M**

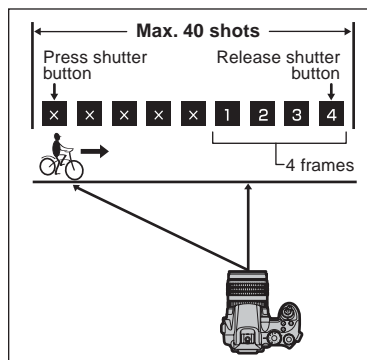

This mode allows you to release the shutter up to 40 times (max. 1.5 frames/sec.) and record the last 4 frames. If you take your finger off the shutter button before 40 shots have been taken, the camera records the final 4 frames shot before you released the shutter button.

If there is insufficient space on the media, the camera records as many of the shots taken just before the shutter button was released as will fit on the media.

- ⚠ Final 4-frame continuous shooting cannot be used in the "Movie mode".
- ⚠ Only 1 frame can be shot when using the Final 4-frame continuous shooting mode and Self-timer mode together.

Long-period continuous shooting

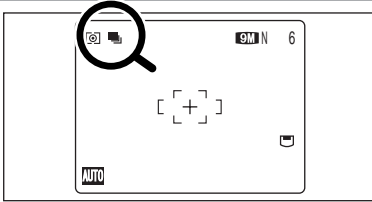
Available Photography modes: **AUTO**, , , , , , 

This mode allows you to take up to 40 continuous shots (max. 1.1 frames/sec.).

- ⚠ Long-period continuous shooting cannot be used in the "P", "S", "A", "M" and "⏸" modes.
- ⚠ Only 1 frame can be shot when using the Long-period continuous shooting mode and Self-timer mode together.

◆ Focusing on a moving subject ◆

If you press the shutter button down halfway to focus on the subject at the starting point **A**, the subject may no longer be in focus when it reaches point **B** where you want to take the shot. In such situations, focus on point **B** beforehand and then lock the focus so that it does not shift. This feature is also useful for photographing fast-moving subjects that are difficult to focus on.

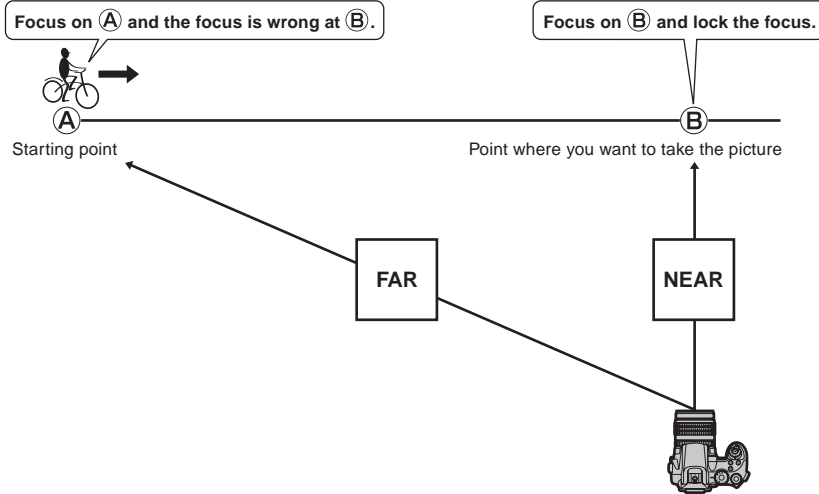

◆ Continuous shooting and flash ◆

When a Continuous shooting mode is selected, the flash mode is forcibly set to "Ⓢ" Suppressed flash. However, when the mode is changed back to normal photography, the flash setting specified before continuous shooting was selected is restored.

This is useful when checking the shot composition for dimly lit scenes (Slow synchro shots, etc.).

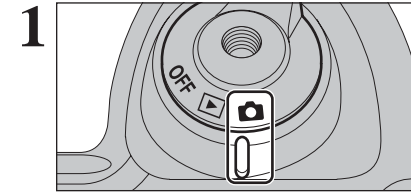

Set the Power switch to "Ⓢ".

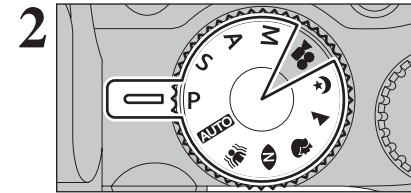

Set the Mode dial to Photography mode.

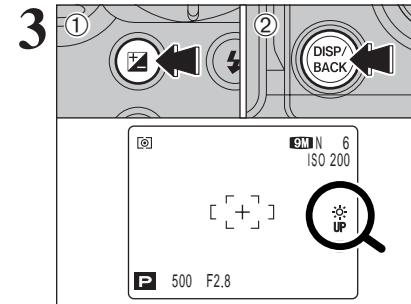

- ① Hold down the "Fn" button.
 - ② Press the "DISP/BACK" button.
- "UP" appears on the screen and the subject is displayed brightly.

To cancel increased brightness:

- ① Hold down the "Fn" button.
 - ② Press the "DISP/BACK" button again.
- This function is automatically canceled after each shot.

- ⚠ When this function is active, it will increase the amount of speckling in images on the screen. This is normal and does not affect the photographed image.
- ⚠ This function is purely for checking the composition of your shot. It does not increase the brightness of the image.
- ⚠ Even if you increase the brightness in low-light conditions, you cannot check the subject.
- ⚠ The color tones may vary depending on the subjects.

This function displays the histogram for an image and allows the brightness distribution during shooting to be checked. This function can also be used to check the current photography settings.

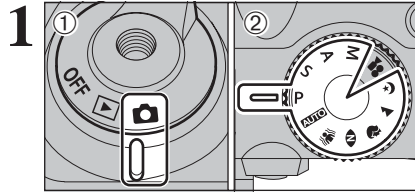

- 1 Set the Power switch to "ON".
- 2 Set the Mode dial to Photography mode.

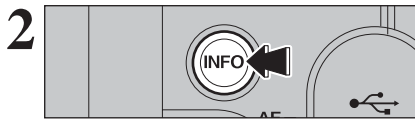

Press the "INFO" button to display the histogram. Press the "INFO" button again to display the current settings.



Histogram (Quick display)

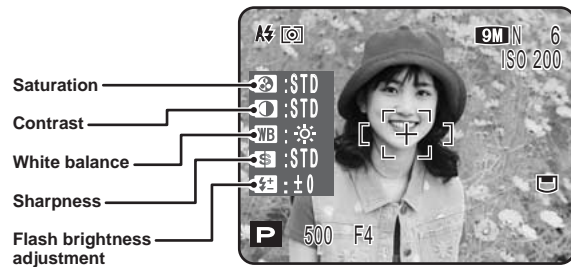

- The histogram that appears on the screen during shooting is a quick display. The shape of the graph may differ from that shown during playback. Play back the image to check the histogram after shooting (⇒P.74).
- A quick display of the brightness distribution is shown when taking a picture. The exposure cannot be checked.
- Information for the photography settings does not appear in "AUTO", "P", "S", "A", "M", "L" and "C" mode.

QUALITY MODE (NUMBER OF RECORDED PIXELS)

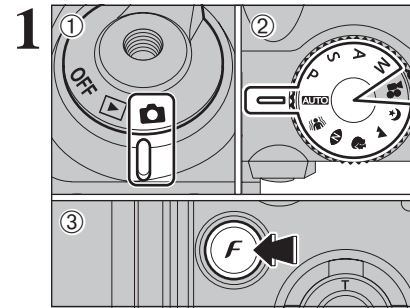

- 1 Set the Power switch to "ON".
- 2 Set the Mode dial to Photography mode.
- 3 Press the "F" button to display the menu on the screen.

"F" Quality cannot be selected when setting CCD-RAW (⇒P.103).

The quality setting is retained even when the camera is off or the mode setting is changed.

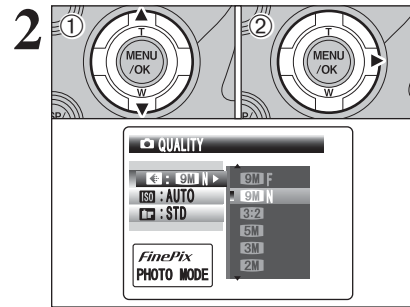

- 1 Press "▲" or "▼" to select "QUALITY".
- 2 Press "▶".

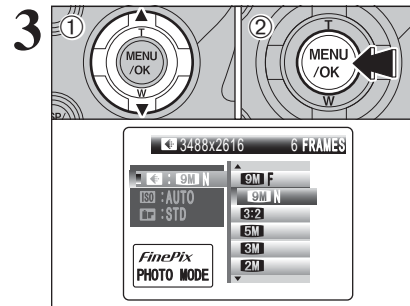

- 1 Press "▲" or "▼" to change the setting.
- 2 Press the "MENU/OK" button to confirm the setting.

- The numbers to the right of setting show the number of available frames.
- When changing the quality setting, the number of available frames also changes (⇒P.27).

QUALITY MODE (NUMBER OF RECORDED PIXELS)

Quality settings in Photography mode

Choose from 7 settings. Using the table below as a guide, select the setting that best suits your aims.

Quality mode	Sample uses
9M F (3488 × 2616)	Printing at up to 10R (25.4 × 30.5 cm) / A3 size For better quality, select "9M F"
9M N (3488 × 2616)	
3:2 (3696 × 2464)	Printing at up to 10R (25.4 × 30.5 cm) / A4 size
5M (2592 × 1944)	Printing at up to 6R (15.2 × 20.3 cm) / A5 size
3M (2048 × 1536)	Printing at up to 4R (10.2 × 15.2 cm) / A6 size
2M (1600 × 1200)	To use for e-mail or web site
63M (640 × 480)	

◆ Area shot and quality setting ◆

Area shot excluding "3:2"



Area shot with "3:2"



Normal shooting provides an aspect ratio of 4:3 and "3:2" shooting provides an aspect ratio of 3:2 (same aspect ratio as 35 mm film and post card).

ISO SENSITIVITY

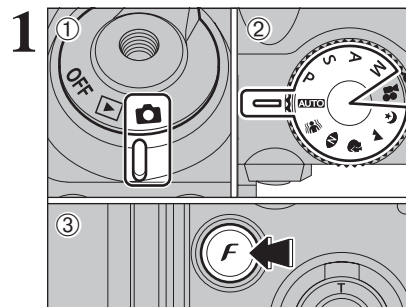

- 1 Set the Power switch to "ON".
- 2 Set the Mode dial to Photography mode.
- 3 Press the "F" button to display the menu on the screen.

In "Movie" mode, do not set the "ISO" (sensitivity) setting.

Sensitivity is retained even when the camera is off or the mode setting is changed.

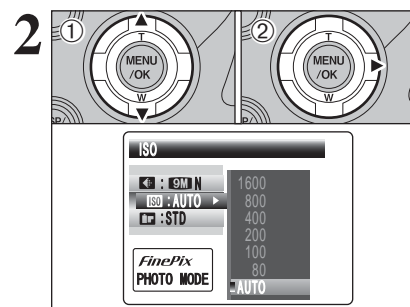

- 1 Press "▲" or "▼" to select "ISO" (sensitivity).
- 2 Press "▶".

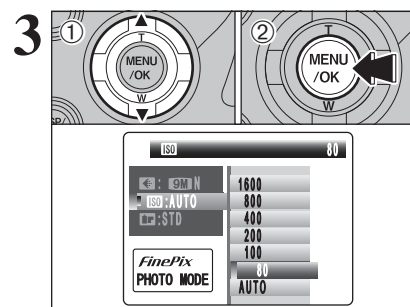

- 1 Press "▲" or "▼" to change the setting.
- 2 Press the "MENU/OK" button to confirm the setting.

● Settings

AUTO /80/100/200/400/800/1600

- Although higher sensitivity settings will allow you to take pictures in darker locations, they will also increase the amount of speckling in your images. Streaking may also be visible in shots of scenes such as the night sky. Choose the sensitivity setting that best suits the conditions.
- When selecting "Anti-blur" or "Natural light", only "AUTO" can be selected in the "ISO" (sensitivity) setting.
- When selecting "P", "S", "A" or "M", AUTO cannot be selected in the "ISO" (sensitivity) setting.

When selecting "AUTO" as the sensitivity setting, the camera selects the best sensitivity setting for the subject's brightness.

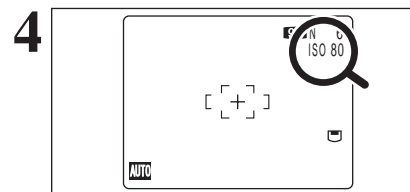

When the sensitivity is set to "80", "100", "200", "400", "800" or "1600", the selected sensitivity setting appears on the screen.

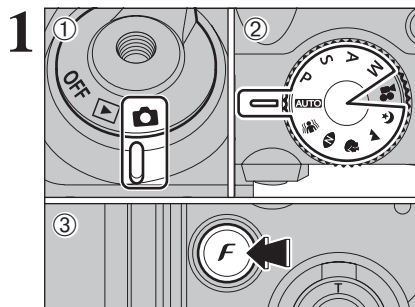

- 1 Set the Power switch to "ON".
- 2 Set the Mode dial to Photography mode.
- 3 Press the "F" button to display the menu on the screen.

⚠ In "MOVIE" Movie mode, do not set the "F" FinePix COLOR setting.

The FinePix COLOR setting is retained even when the camera is off or the mode setting is changed.

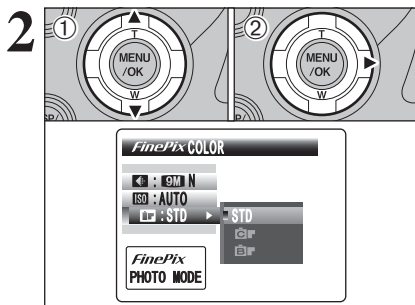

- 1 Press "▲" or "▼" to select "F" FinePix COLOR.
- 2 Press "▶".

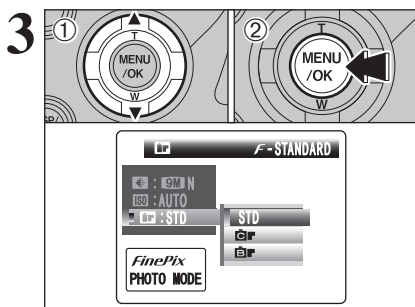

- 1 Press "▲" or "▼" to change the setting.
- 2 Press the "MENU/OK" button to confirm the setting.

- ⚠ **F-CHROME** may have little visible effect with some subjects, such as close-up shots of people (portraits).
- ⚠ Because the effects on the image differ depending on the scene being shot in **F-CHROME** mode, take pictures in **F-STANDARD** mode as well as this mode. Note that you may not be able to see any difference on the screen.
- ⚠ For shots taken in **F-CHROME** mode or **F-B&W** mode, automatic quality adjustment will be suppressed on Exif Print compliant printers.

F-STANDARD	The contrast and color saturation are set to standard. Use this mode for normal photography.
F-CHROME	The contrast and color saturation are set to high. This feature is effective for taking more vivid shots of subjects such as scenery (blue sky and greenery) and flowers.
F-B&W	This setting converts the colors in the photographed image to black and white.

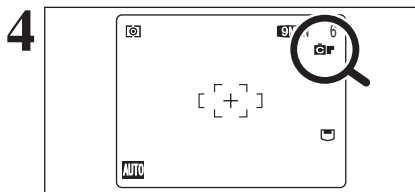

When setting **F-CHROME** or **F-B&W**, the icon appears on the screen.

- F-CHROME:**
- F-B&W:**

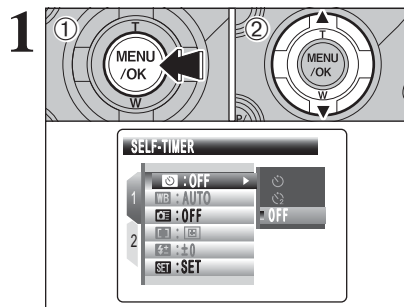

- 1 Press the "MENU/OK" button to display the menu on the screen.
- 2 Press "▲" or "▼" to select the menu item.

⚠ When the top or bottom of the menu item is selected, press "▲" or "▼" to change the page.

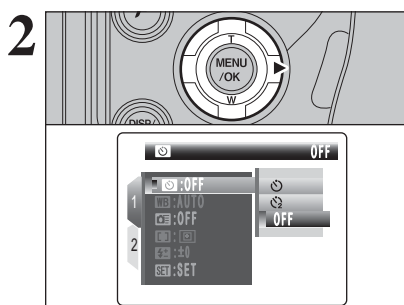

Press "▶".

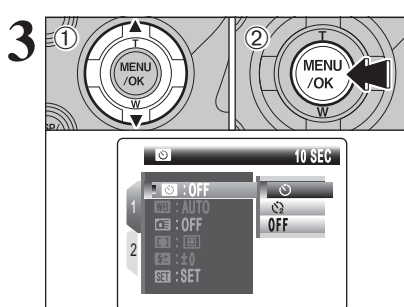

- 1 Press "▲" or "▼" to change the setting.
- 2 Press the "MENU/OK" button to confirm the setting.

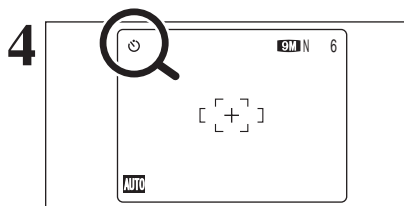

When the setting is enabled, an icon appears in the top-left corner of the screen.

⚠ The settings available in the menu screen vary depending on the Photography mode.

Changing the page number

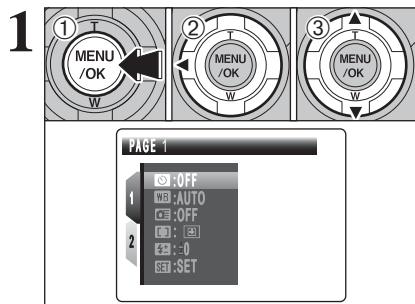

- 1 Press the “MENU/OK” button to display the menu on the monitor.
- 2 Press “◀” to move to page number.
- 3 Press “▲” or “▼” to select the page.

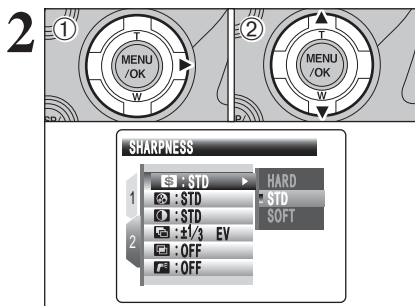

- 1 Press “▶” to move to menu item.
- 2 Press “▲” or “▼” to select the menu item.

Self-timer →P.65

Use this setting for taking pictures such as group shots where the photographer is included in the shot.

WB White balance →P.66

Change this setting to suit for the surroundings and lighting.

High-speed shooting →P.67

Use this setting to reduce the time required for focusing.

AF mode →P.68

Set the focusing method.

Flash brightness adjustment →P.69

Change this setting to adjust the amount of light emitted by the flash to suit the photography conditions or to achieve a desired effect.

S Sharpness →P.69

Use this setting to soften or emphasize outlines or to adjust the quality of the image.

Saturation →P.70

Use this setting to adjust the lightness of color.

Contrast →P.70

Use this setting to adjust the contrast.

Bracketing →P.70

Use this setting to photograph the same image with different exposure settings.

Multiple exposure →P.71

Multiple exposure provides a way of overlaying images on top of each other to give a final image.

External flash →P.72

Select the external flash setting to use an external flash.

SELF-TIMER PHOTOGRAPHY

Available Photography modes: **AUTO**, **[Person]**, **N**, **[Eye]**, **[Star]**, **P**, **S**, **A**, **M**

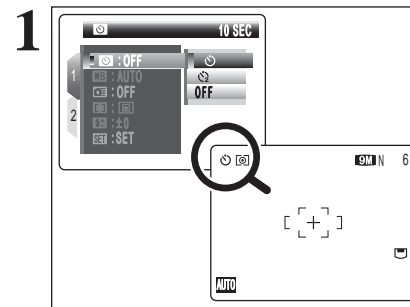

The self-timer is used in situations where the photographer is included in the shot. When selecting the self-timer setting, the self-timer icon appears on the screen.

- ⌚: The picture is taken after 10 seconds.
- ⌚: The picture is taken after 2 seconds.

- Any of the following cancels the self-timer setting:
 - Completing the shooting
 - Changing the Mode dial setting
 - Setting the camera to Playback mode
 - Turning the camera off

Using the 2-second self-timer

This is useful when you have the camera on a tripod and you want to prevent camera shake.

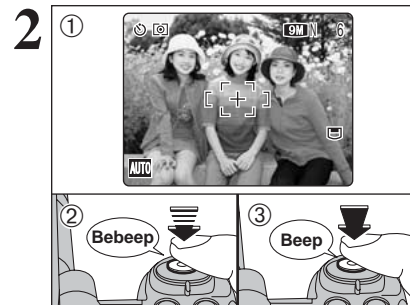

- 1 Position the AF frame over the subject.
- 2 Press the shutter button down halfway to focus on the subject.
- 3 Without releasing the shutter button, press the button all the way down (fully pressed) to start the self-timer.

- The AF/AE lock can be used (→P.28).
- Take care not to stand in front of the lens when pressing the shutter button as this can prevent the correct focus or brightness (exposure) from being achieved.

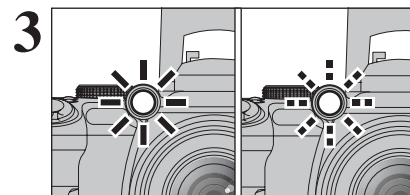

The self-timer lamp lights and then starts blinking until the picture is taken.

Self-timer lamp display

⌚	Lit for 5 seconds = Blinking for 5 seconds
⌚	Blinking for 2 seconds

- To stop the self-timer, once it has started running, press the “DISP/BACK” button.

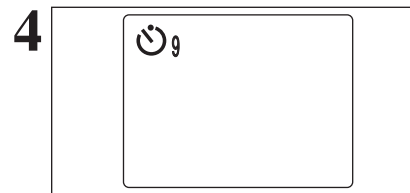

A countdown appears on the screen indicating the time remaining until the picture is taken. Self-timer mode is canceled after each shot.

WB WHITE BALANCE (SELECTING THE LIGHT SOURCE)

Available Photography modes: P, S, A, M

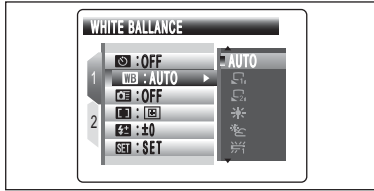

Change the white balance setting to suit for the surroundings and lighting. In "AUTO" mode, the correct white balance may not be achieved for subjects such as close-ups of people's faces and pictures taken under a special light source. Select the correct white balance for the light source. See P.137 for more information on the white balance.

- AUTO: Automatic adjustment (shooting to show the ambience of the light source)
- 1: Custom white balance type 1
- 2: Custom white balance type 2
- ☀: Shooting outdoors in good weather
- ☁: Shooting in shade

- ☀: Shooting under "Daylight" fluorescent lamps
- ☁: Shooting under "Warm White" fluorescent lamps
- ☀: Shooting under "Cool White" fluorescent lamps
- ☁: Shooting in incandescent light

* When the flash fires, the white balance setting (excluding custom white balance) for the flash is used. Consequently, to achieve a particular effect, the flash mode should be set to Suppressed flash (⇒P.53).

☝ The color tones may vary depending on the shooting conditions (light source, etc.).

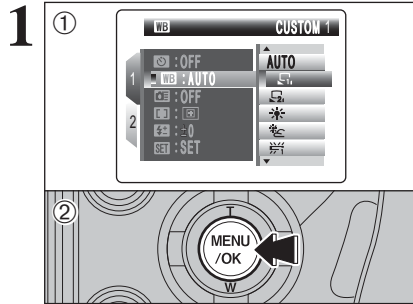

Custom white balance

Use this setting to set the white balance for the ambient natural or artificial lighting in images. Use this setting to achieve special effects also.

- ① Select custom white balance "1" or "2".
- ② Press the "MENU/OK" button.

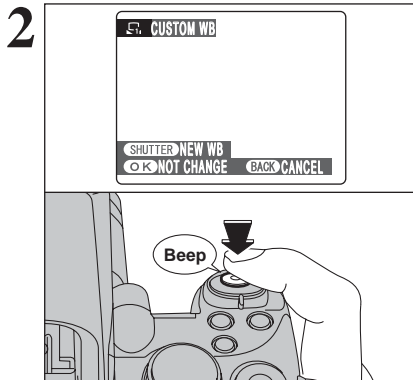

Hold a piece of white paper under the light source for setting the white balance, so that it fills the entire screen. Then press the shutter button to set the white balance.

☝ The white balance setting does not affect the image shown on the screen.

To use the white balance set previously, press the "MENU/OK" button without pressing the shutter button.

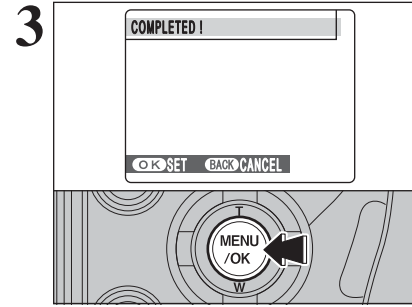

When the correct exposure is measured, "COMPLETED!" appears. Press the "MENU/OK" button to confirm the setting.

- ☝ The specified custom white balance is retained until it is reset. This setting is retained even if the batteries are removed.
- ☝ Adjust the custom white balance again when changing the sensitivity setting.
- ☝ After taking the picture, check the color (white balance) setting for the image.
 - Set "IMAGE DISP." to "1.5 SEC", "3 SEC" or "CONT" in the "SET-UP" menu (⇒P.101).
 - Set the Power switch to "E" (⇒P.31).

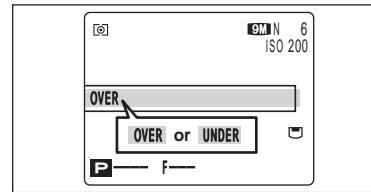

When [OVER] or [UNDER] appears, the white balance was not measured at the correct exposure. Set the exposure compensation again, using a negative value (-) when [OVER] appears and a positive value (+) when [UNDER] appears.

◆ Example ◆

You can change the white balance for a photographed image by using colored paper instead of white paper.

HS HIGH-SPEED SHOOTING

Available Photography modes: **AUTO**, [P], [S], [A], [M]

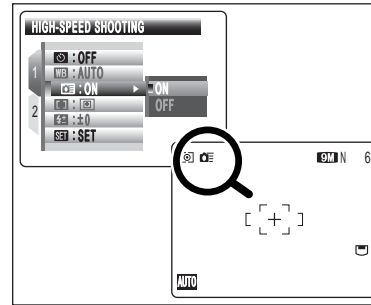

High-speed shooting mode reduces the time required for focusing when pressing the shutter button down halfway.

- **Focal range**
 - Wide-angle: approx. 2 m (6.6 ft.) to infinity
 - Telephoto: approx. 4 m (13.1 ft.) to infinity

- ☝ When this function is active, higher sensitivity settings will increase the amount of speckling in your images. This is normal and does not affect the photographed image.
- ☝ When taking pictures while the HIGH-SPEED SHOOTING mode is set to "ON", the batteries will run down more quickly.

AF MODE

Available Photography modes: P, S, A, M

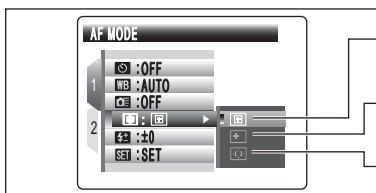

- CENTER
- MULTI
- AREA

The AF mode can only be selected when the focus mode is S-AF (⇒P.23).

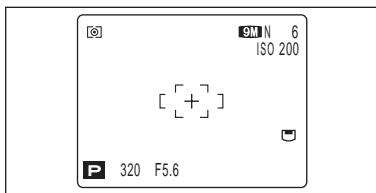

CENTER
The camera focuses on the center of the screen. Use this setting when taking pictures using AF/AE lock (⇒P.28).

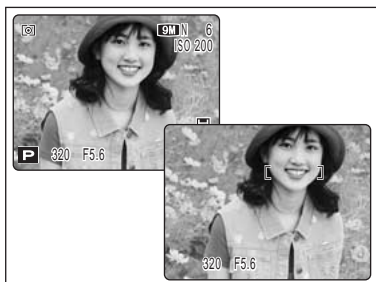

MULTI
Press the shutter button down halfway. The camera recognizes any strongly contrasting subject near the center of the screen and displays the AF frame over the subject in focus.

When taking pictures in Macro mode, the camera focuses on the center of the screen.



For a high-contrast subject in the center of the screen

Press the shutter button down halfway. The AF frame appears positioned on the high-contrast subject near the center of the image.



When there is no high-contrast subject in the center of the screen

When the camera has difficulty focusing on the subject in "MULTI" mode, set the AF mode to "CENTER" and use AF/AE Lock (⇒P.28).

1

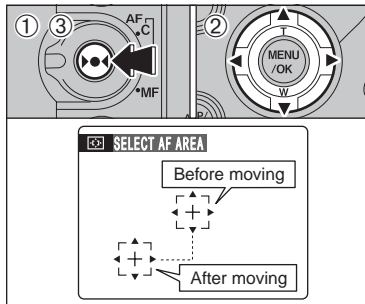

AREA

The camera changes the focusing position on the screen. Use this setting when composing the shot using a tripod and changing the focusing position.

- ① Hold down the "AF-ON" button.
- ② Press "▲", "▼", "◀" or "▶" to move the "target point" to the focusing position.
- ③ Release the "AF-ON" button.

2

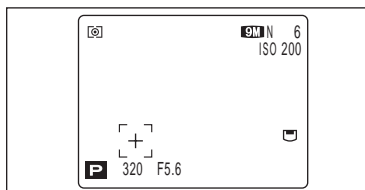

The AF frame appears in the location to which the target point was moved. Take the picture in the normal way. To reposition the AF frame, repeat step 1.

Regardless of the AF frame location, the exposure is always set using the area in the center of the screen. To expose the shot for your main subject, use AE lock.

FLASH BRIGHTNESS ADJUSTMENT

Available Photography modes: P, S, A, M

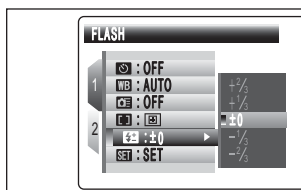

Use this setting to change the amount of light emitted by the flash to suit the photography conditions or to achieve a desired effect.

Compensation range:
-2/3 EV to +2/3 EV in approx. 1/3 EV increments (total: 5 levels selectable)
See P.137 for information on EVs.

- Depending on the type of subject and the shooting distance, brightness adjustment may have no effect.
- The image may appear dark when setting the shutter speed to higher than 1/1000 sec.

SHARPNESS

Available Photography modes: P, S, A, M

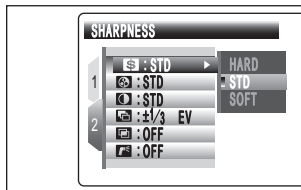

Use this setting to soften or emphasize outlines or to adjust the quality of the image.

- HARD:** Emphasizes the outlines. Best for shots of subjects such as buildings or text where sharp images are desirable.
- STANDARD:** Best for ordinary photography. Provides edge sharpness that is ideal for most picture taking situations.
- SOFT:** Softens the outlines. Best for shots of subjects such as people, where a softer image is desirable.

SATURATION

Available Photography modes: P, S, A, M

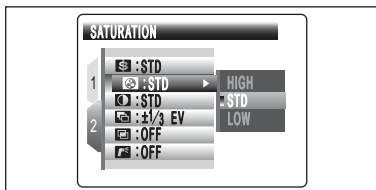

Use this setting to adjust the quality of the image, including making the colors more vivid or toning the colors down.

HIGH: Obtains deep and vivid color. This setting is effective for taking more vivid shots of subjects such as scenery (blue sky and greenery etc.).

STANDARD: The camera determines the correct saturation.

LOW: Obtains soft color. This setting produces beautiful images that retain the natural ambience in low-light conditions.

This setting is disabled when selecting "F-CHROME" or "F-B&W" in the "FinePix COLOR" setting.

CONTRAST

Available Photography modes: P, S, A, M

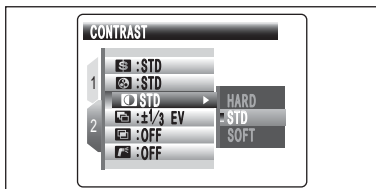

Use this setting to raise or lower the contrast.

HARD: Emphasizes the contrast. This setting provides crisp, clear images.

STANDARD: The camera determines the correct contrast.

SOFT: Lowers the contrast. Bright areas are less likely to be washed out and dark areas are less likely to turn completely black.

This setting is disabled when selecting "F-CHROME" or "F-B&W" in the "FinePix COLOR" setting.

BRACKETING

Available Photography modes: P, S, A, M

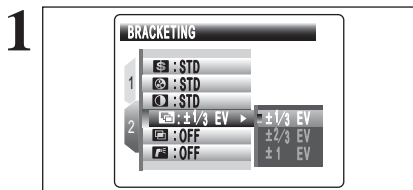

Use this setting to photograph the same image with different exposure settings. Bracketing shoots 3 continuous frames, one of which is correctly exposed while the remaining two are underexposed and overexposed respectively by a set amount.

Bracketing settings (3)

±1/3 EV, ±2/3 EV, ±1 EV

See P.137 for more information on EVs.

If the underexposed or overexposed frame is outside the camera's control range, the picture is not taken with the specified setting increments.

Flash photography cannot be used.

This feature always takes 3 shots. However, if there is insufficient space on the media for 3 shots, no picture will be taken.

2

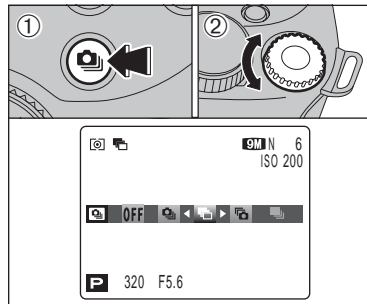

Auto bracketing

After setting the exposure for bracketing:

- Hold down the "Camera" button.
- Turn the Command dial to select "Auto Bracketing".

MULTIPLE EXPOSURE

Available Photography modes: P, S, A, M

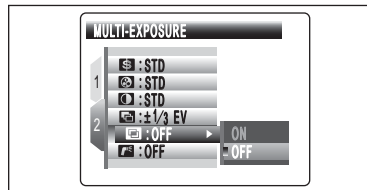

Multiple exposure provides a way of overlaying images on top of each other to give a final image that cannot be got through normal photography.

When the image is overexposed, use negative compensation in the brightness (exposure compensation) setting to correct the exposure (→P.45).

Only the optical zoom can be used for multiple exposure shots. The digital zoom (→P.29) does not function.

This mode is canceled when changing the Mode dial to "AUTO", "F", "S", "A", "M", "P", "C", "E", or "M", and turning the camera off.

- Continuous shooting and auto bracketing are disabled when MULTI-EXPOSURE is selected.
- You cannot change the photography menu settings and the quality setting during shooting.
- There is no limit on the number of multiple exposures.

1

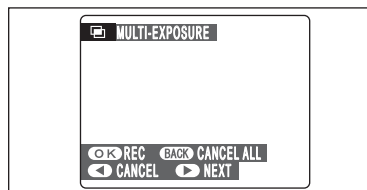

A preview screen appears when taking a picture.

- To overlay more images Press "Next".
- To record the image Press the "MENU/OK" button.
- To return to the previous image Press "Back".
- To stop without recording any images Press the "DISP/BACK" button.

A preview image is always shown, regardless of the IMAGE DISPLAY setting (→P.101).

Changing the Photography mode exits multiple exposure mode without recording the images.

2

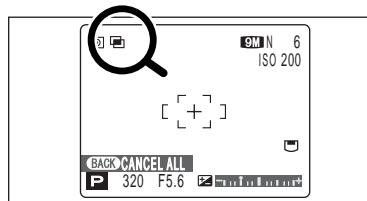

From the 2nd shot onwards, the yellow "Camera" icon appears on the screen.

1 USING AN EXTERNAL FLASH Available Photography modes: P, S, A, M

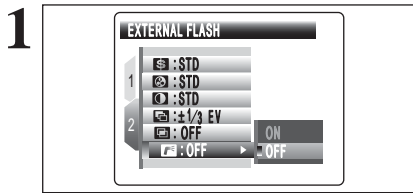

Select "ON" in this setting when using an external flash unit. Synchronized shutter speeds up to 1/1000 sec. can be used.

- The image may appear dark when the shutter speed is set to speeds higher than 1/1000 sec.
- Set the white balance (⇒P.66) to "AUTO" or custom white balance (⇒P.73).

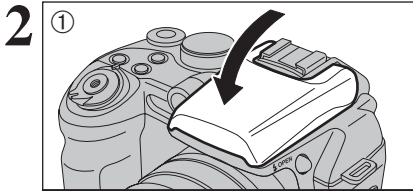

- 1 Close the built-in flash.
- 2 Mount the external flash on the camera's hot shoe and tighten the locking screw.

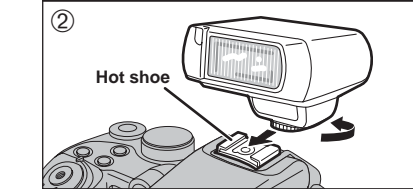

- If you pop up the built-in flash when the external flash is set to "ON", the built-in flash fires once as a signal for the external flash to fire. The hot shoe and the Synchronizing terminal do not make a signal for flash.

Ordinary external flash units can be used. However, some camera-specific flash units cannot be used.

◆ Using a Synchronizing terminal ◆

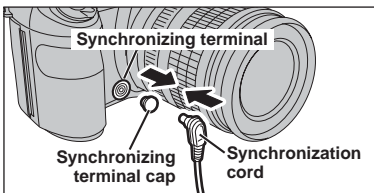

Attach the synchronization cord from the external flash to the Synchronizing terminal on the camera by pushing the cord into the terminal securely.

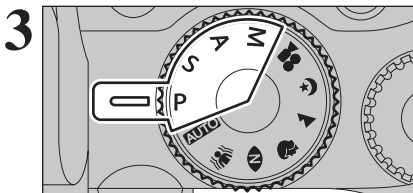

The mode can be set to "P", "S", "A" (⇒P.41, 42, 43) or "M" (⇒P.44), but the use of "A" or "M" is better.

- Flash photography cannot be used when Top 4-frame continuous shooting (⇒P.54) or auto bracketing (⇒P.54) is selected.

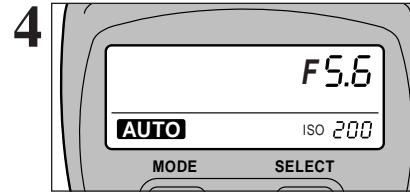

* Illustration is display of the external flash (commercial available).

External flash settings (for flashes with automatic flash control)

For external flash, refer to the user's manual for the flash and specify the settings as described below.

- Select external flash mode (TTL mode cannot be used).
- Match the settings to the camera aperture setting. Set the flash for the aperture setting measured by the camera.
- Match the sensitivity setting (⇒P.61) to the setting on the camera.

When the white balance is incorrect

Adjust the white balance to match the external flash. In "WB" WHITE BALANCE in the photography menu (⇒P.66), select "CUSTOM 1". Press the "MENU/OK" button.

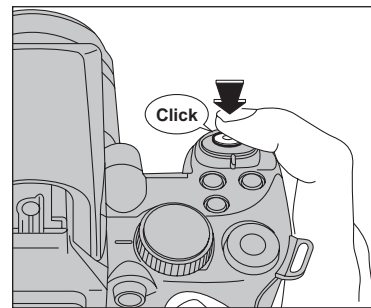
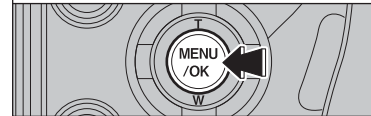
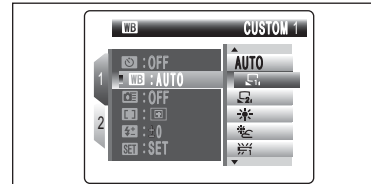

Hold a sheet of white paper so that it fills the entire screen. When pressing the shutter button, the flash fires and the white balance is set.

- After taking the picture, check the color (white balance) setting for the image.
- Set "IMAGE DISP." to "1.5 SEC", "3 SEC" or "CONT" in the SET-UP menu (⇒P.101).
- Set the Power switch to "E" (⇒P.31).

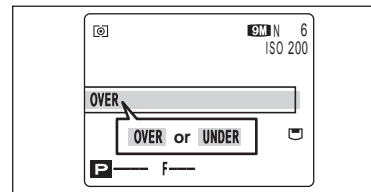

When [OVER] or [UNDER] appears, the white balance was not measured at the correct exposure. Set the exposure compensation again, using a negative value (-) when [OVER] appears and a positive value (+) when [UNDER] appears.

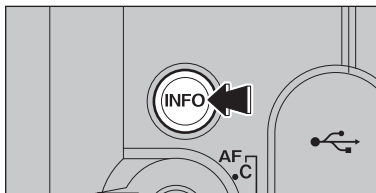

Use this function to check the photography information. Hold down the "INFO" button to check the information.

This function cannot be used during multi-frame playback (→P.31).

Quality mode — 9M F
Sensitivity — ISO 400
Shutter speed / Aperture — 1/500 4
FinePix COLOR — :STD
Saturation — :STD
Contrast — :STD
Flash — :OFF
White balance — WB : AUTO
Exposure compensation setting — ±0

100-0001 — Frame number

Histogram

8/24/2005 10:00 AM

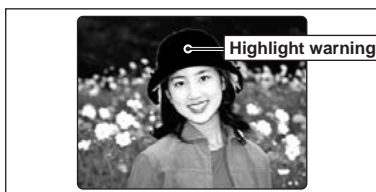

Highlight warning: When the image is overexposed, areas where white blooming has occurred flash black.

The Highlight warnings displayed during playback and during photographed image checking may differ.

◆ Histograms ◆

A histogram is a chart showing the distribution of brightness in an image (horizontal axis: brightness; vertical axis: pixels).

- ① **Optimal exposure:** There is an ample distribution of pixels overall with a peak in the middle range.
- ② **Overexposed:** The number of highlight pixels is high with the distribution sloping upwards to the right.
- ③ **Underexposed:** The number of shadow pixels is high with the distribution sloping upwards to the left.



The shape of the graph will vary depending on the subject.

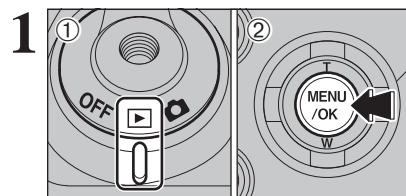

- ① Set the Power switch to "ON".
- ② Press the "MENU/OK" button to display the menu on the screen.

Erased frames (files) cannot be recovered. Back up important frames (files) onto your PC or another media.

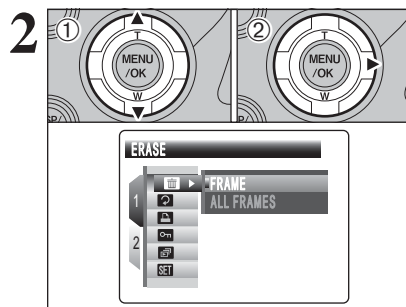

- ① Press "▲" or "▼" to select "ERASE".
- ② Press "▶".

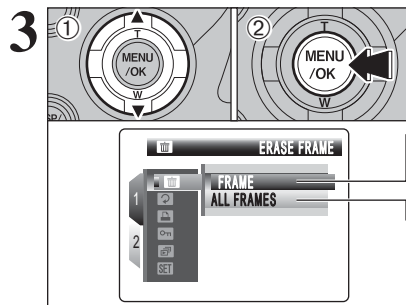

- ① Press "▲" or "▼" to select "FRAME" or "ALL FRAMES".
- ② Press the "MENU/OK" button.

FRAME
Erases only the selected frame (file).

ALL FRAMES
Erases all unprotected frames (files).
Back up important frames (files) onto your PC or another media.

"DPOF SPECIFIED. ERASE OK ?" appears when erasing a frame (file) with DPOF setting.

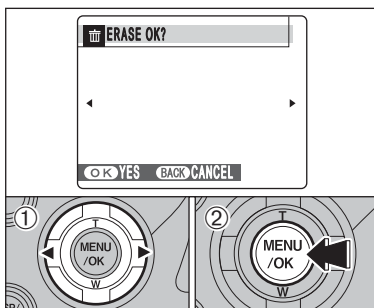

FRAME

- ① Press “◀” or “▶” to select the erasing frame (file).
- ② Press the “MENU/OK” button to erase the currently displayed frame (file).
To erase another frame (file), repeat steps ① and ②.

When erasing frames (files) is completed, press the “DISP/BACK” button.

- ⚠ Pressing the “MENU/OK” button repeatedly erases consecutive frames (files). Take care not to erase a frame (file) by mistake.
- ⚠ Protected frames (files) cannot be erased. Unprotect the frames (files) before erasing them (⇒P.84).

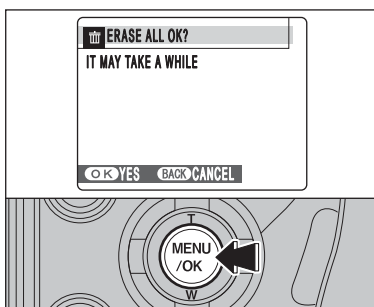

ALL FRAMES

Pressing the “MENU/OK” button erases all the frames (files).

- ⚠ Protected frames (files) cannot be erased. Unprotect the frames (files) before erasing them (⇒P.84).

◆ To stop the procedure midway ◆

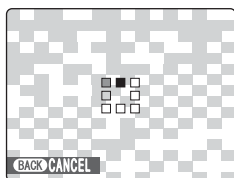

Press the “DISP/BACK” button to cancel erasing of all the frames (files). Some unprotected frames (files) will be left unerased.

- ⚠ Even if you stop the procedure immediately, some frames (files) will be erased.

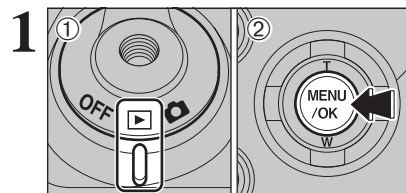

Use this mode to rotate an image photographed with FinePix S9000 / FinePix S9500.

- ① Set the Power switch to “[ON]”.
- ② Press the “MENU/OK” button to display the menu on the screen.

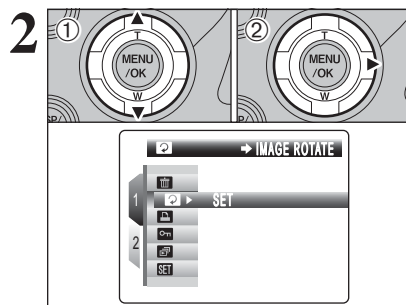

- ① Press “▲” or “▼” to select “[2]” IMAGE ROTATE.
- ② Press “▶”.

- ⚠ When [PROTECTED FRAME] appears, unprotect the frame (⇒P.84).

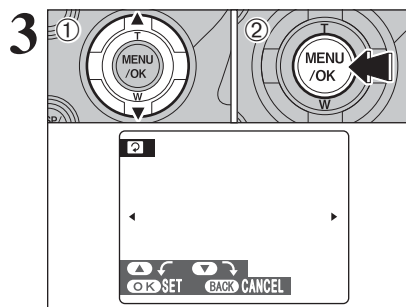

- ① Press “▲” or “▼” to rotate and display the image.
- ② Press “MENU/OK” button to confirm your selection. Press the “DISP/BACK” button to cancel rotating the image.

- ⚠ An image can be rotated when playing back using FinePix S9000 / FinePix S9500 and FinePixViewer (included).

◆ Images that can be rotated ◆

You may not be able to rotate images that were shot with a camera other than the FinePix S9000 / FinePix S9500.



DPOF stands for Digital Print Order Format and refers to a format that is used for recording printing specifications for images shot using a digital camera on media such as an **xD-Picture Card** and CF/Microdrive. The recorded specifications include information on which frames are to be printed.

This section gives a detailed description of how to order your prints with the FinePix S9000 / FinePix S9500.

- * Some printers do not support date and time imprinting or specification of the number of prints.
- * The warnings shown below may appear while specifying the prints.

"DPOF SPECIFIED. ERASE OK ?"
 "DPOF SPECIFIED. ERASE ALL OK ?" (→P.75)
 When erasing the image, the DPOF setting for that image is deleted at the same time.

"RESET DPOF OK ?" (→P.79)
 When inserting a media that contains images specified for printing on by another camera, those print specifications are all reset and replaced by the new print specifications.

[DPOF FILE ERROR] (→P.131)
 Up to 999 images can be specified on the same media.

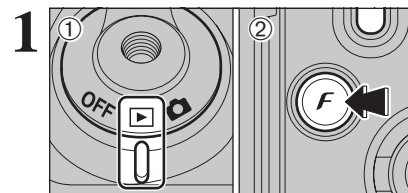

- ① Set the Power switch to "▶".
- ② Press the "F" button.
 "WITH DATE" is selected at factory default setting. See P.81 for information on selecting "WITH DATE" or "WITHOUT DATE".

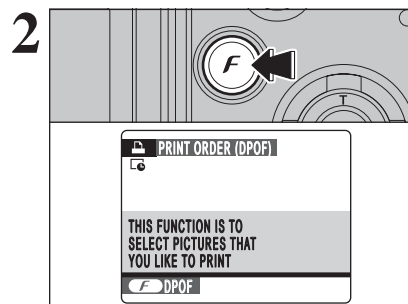

- ② Press the "F" button.
 If there were previous DPOF settings, perform step 3.

☛ "☒" appears on the screen when selecting "WITH DATE".

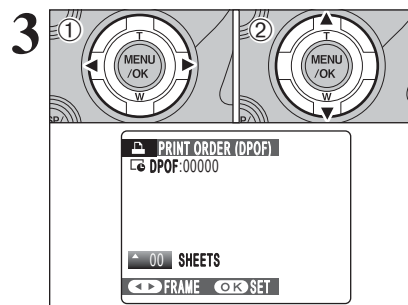

- ① Press "◀" or "▶" to display the frame (file) for specifying DPOF settings.
- ② Press "▲" or "▼" to set a value up to 99 as the number of copies of the frame (file) to be printed. For frames (files) that you do not want printed, set the number of prints to 0 (zero).
 To specify more DPOF settings, repeat steps ① and ②.

- ☛ Prints of up to 999 image frames (files) can be ordered on the same media.
- ☛ DPOF settings cannot be specified for movie and CCD-RAW.
- ☛ Images photographed with a camera other than FinePix S9000 / FinePix S9500 may not be specified DPOF settings.

Pressing the "DISP/BACK" button while choosing settings will cancel all current settings. If there were previous DPOF settings, only the modifications are canceled.

◆ When DPOF settings were specified on another camera ◆

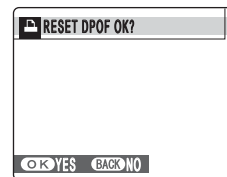

When the data includes a frame (file) with DPOF settings that were specified on another camera, "RESET DPOF OK?" appears. Pressing the "MENU/OK" button erases all of the DPOF settings already specified for each frame (file). Specify the DPOF setting for each frame (file) again.

- ☛ Press the "DISP/BACK" button to leave the previous settings unchanged.

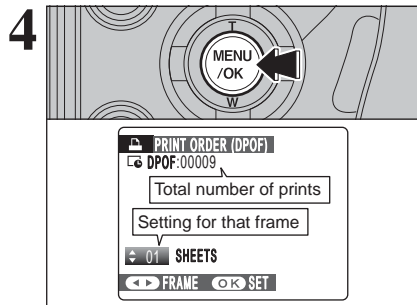

4 Always press the “MENU/OK” button after the settings are completed. Pressing the “DISP/BACK” button cancels those settings.

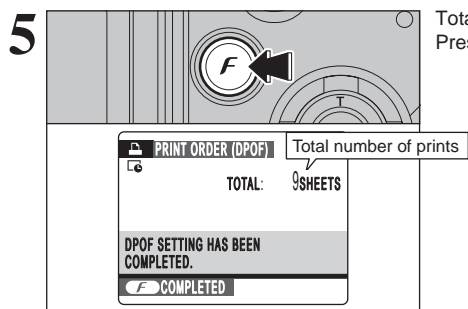

5 Total number of prints appears on the screen. Press the “F” button.

◆ **Canceling DPOF setting** ◆

To cancel the DPOF setting for a specified frame (file):

① Press “◀” or “▶” to select the frame (file) with the DPOF setting you want to cancel.

② Set the number of prints to 0 (zero).

To cancel the DPOF setting for another frame (file), repeat steps ① and ②.

Press the “MENU/OK” button to complete the settings.

- DPOF ALL RESET (➡P.83).

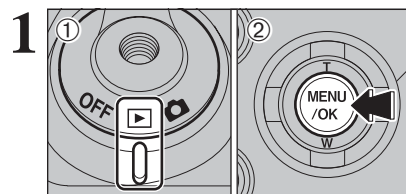

① Set the Power switch to “▶”.
② Press the “MENU/OK” button to display the menu on the screen.

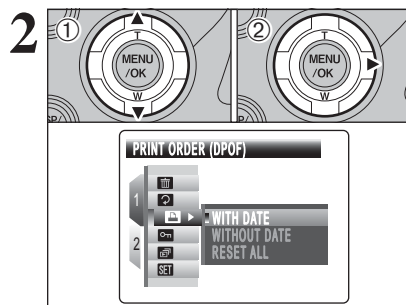

① Press “▲” or “▼” to select “PRINT ORDER (DPOF)”.
② Press “▶”.

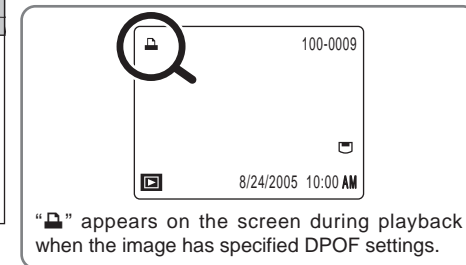

“” appears on the screen during playback when the image has specified DPOF settings.

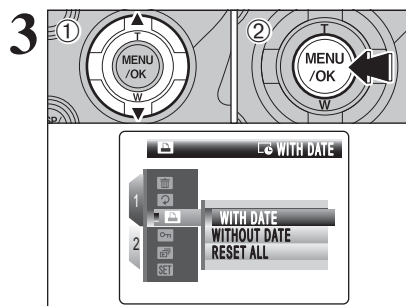

① Press “▲” or “▼” to select “WITH DATE” or “WITHOUT DATE”. Selecting “WITH DATE” will cause the date to be imprinted on your prints.
② Press the “MENU/OK” button.

When selecting the “WITH DATE” setting, the date is imprinted on your shots using the Print Service or a DPOF-compatible printer (depending on the printer specifications, the date may not be printed in some cases).

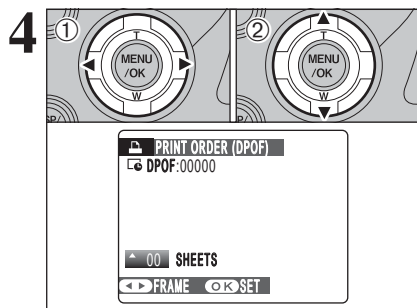

- ① Press “◀” or “▶” to display the frame (file) for specifying DPOF settings.
- ② Press “▲” or “▼” to set a value up to 99 as the number of copies of the frame (file) to be printed. For frames (files) that you do not want printed, set the number of prints to 0 (zero).

To specify more DPOF settings, repeat steps ① and ②.

- Prints of up to 999 image frames (files) can be ordered on the same media.
- “” appears on the screen when selecting “WITH DATE”.
- DPOF settings cannot be specified for movie and CCD-RAW.
- Images photographed with a camera other than FinePix S9000 / FinePix S9500 may not be specified DPOF settings.

Pressing the “DISP/BACK” button while choosing settings will cancel all current settings. If there were previous DPOF settings, only the modifications are canceled.

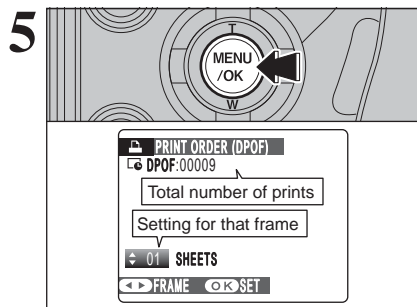

Always press the “MENU/OK” button after the settings are completed.

Pressing the “DISP/BACK” button cancels those settings.

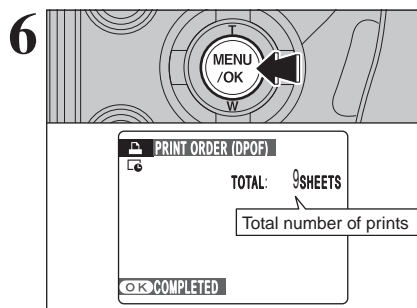

Total number of prints appears on the screen. Press the “MENU/OK” button.

◆ **Canceling DPOF setting** ◆

To cancel the DPOF setting for a specified frame (file):

- ① Press “◀” or “▶” to select the frame (file) with the DPOF setting you want to cancel.
 - ② Set the number of prints to 0 (zero).
- To cancel the DPOF setting for another frame (file), repeat steps ① and ②. Press the “MENU/OK” button to complete the settings.

- DPOF ALL RESET (➡P.83).

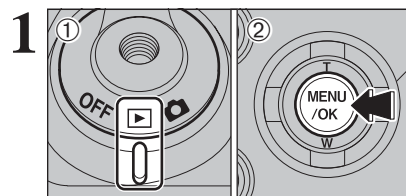

- ① Set the Power switch to “”.
- ② Press the “MENU/OK” button to display the menu on the screen.

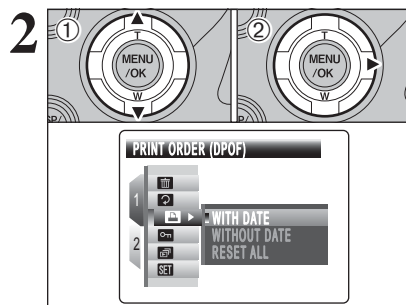

- ① Press “▲” or “▼” to select “” PRINT ORDER (DPOF).
- ② Press “▶”.

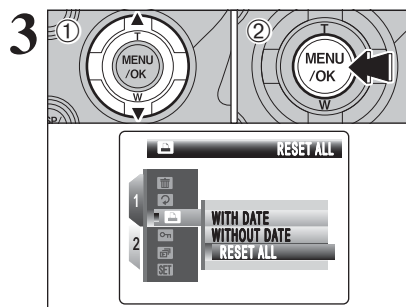
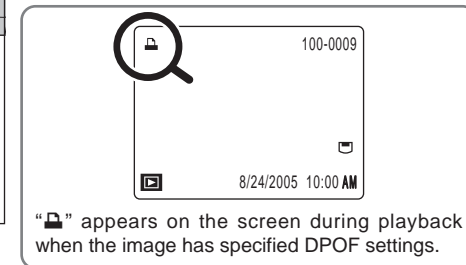

- ① Press “▲” or “▼” to select “RESET ALL”.
- ② Press the “MENU/OK” button.

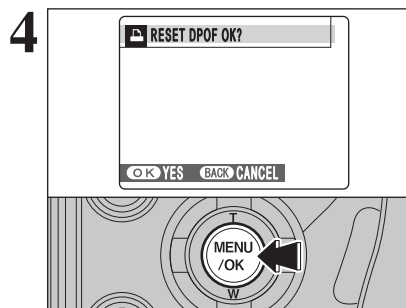

A message appears on the screen. To reset all the DPOF settings, press the “MENU/OK” button.

PROTECTING IMAGES: FRAME / SET ALL / RESET ALL

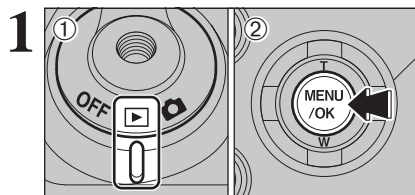

- 1 Set the Power switch to "▶".
- 2 Press the "MENU/OK" button to display the menu on the screen.

Protection is a setting that prevents frames (files) from being accidentally erased. However, the "FORMAT" function erases all the frames (files), including protected frames (files) (→P.104).

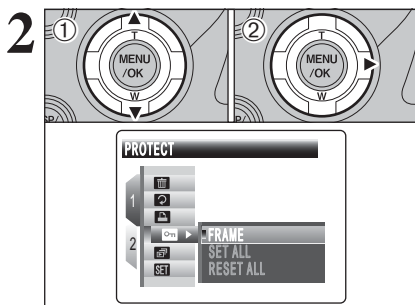

- 1 Press "▲" or "▼" to select "PROTECT".
- 2 Press "▶".

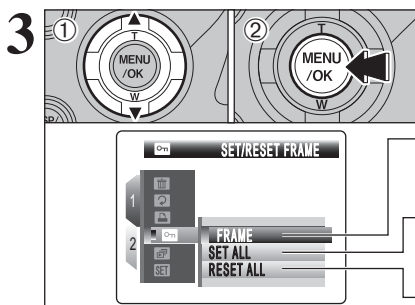

- 1 Press "▲" or "▼" to select "FRAME", "SET ALL" or "RESET ALL".
- 2 Press the "MENU/OK" button to confirm your selection.

FRAME

Protects or unprotects only the selected frame (file).

SET ALL

Protects all the frames (files).

RESET ALL

Removes the protection from all the frames (files).

FRAME SET

- 1 Press "◀" or "▶" to select the protecting frame (file).
 - 2 Press the "MENU/OK" button to protect the currently displayed frame (file).
- To protect another frame (file), repeat steps ① and ②. When protecting frames (files) is completed, press the "DISP/BACK" button.

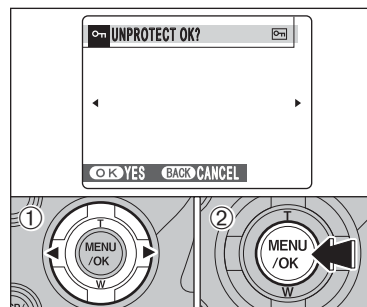
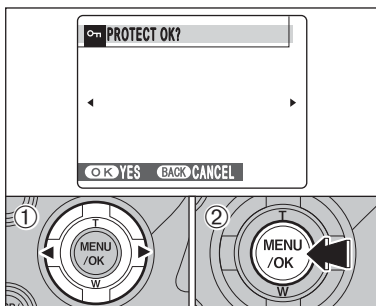

FRAME RESET

- 1 Press "◀" or "▶" to select the protected frame (file).
- 2 Press the "MENU/OK" button to unprotect the displayed frame (file).



SET ALL

Press the "MENU/OK" button to protect all the frames (files).



RESET ALL

Press the "MENU/OK" button to unprotect all the frames (files).

◆ To stop the procedure midway ◆

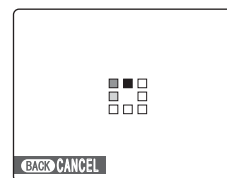

If the images are very large, protecting or unprotecting all the frames (files) may take some time.

If you want to take a picture or record a movie during the procedure, press the "DISP/BACK" button. To return to protecting or unprotecting all the frames (files), see the procedure on P.84 and begin at step 1.

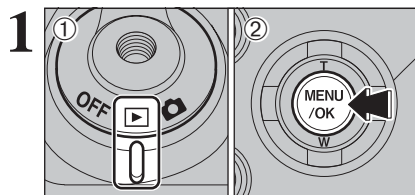

- 1 Set the Power switch to "ON".
- 2 Press the "MENU/OK" button to display the menu on the screen.

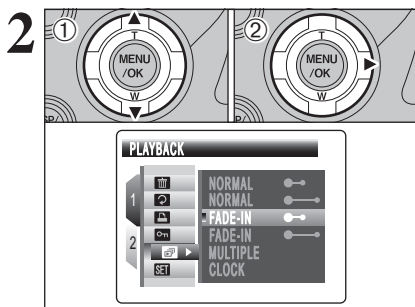

- 1 Press "▲" or "▼" to select "PLAYBACK".
- 2 Press "▶".

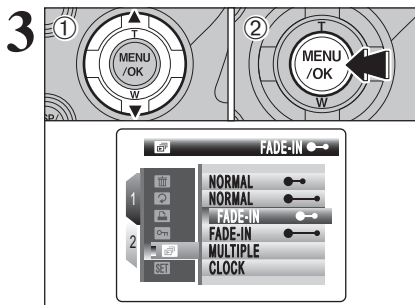

- 1 Press "▲" or "▼" to select the playback interval and the type of image transition.
- 2 Press the "MENU/OK" button. The image frames are advanced and played back.

Press "◀" or "▶" to advance or go back through the images when selecting "NORMAL" and "FADE-IN".

To interrupt automatic playback, press "MENU/OK" button.

- Press the "DISP/BACK" button once during playback to display on-screen help.
- The Auto power off function does not operate during playback.
- Movie starts automatically. When the movie ends, the playback function moves it on.

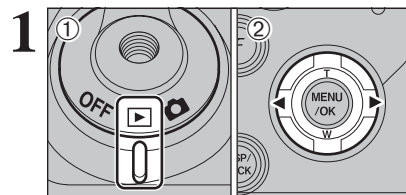

Voice memos of up to 30 seconds can be added to still images.

- **Audio recording format**
WAVE (→P.137)
PCM recording format

- **Audio file size**
Approx. 480 KB (for a 30-second voice memo)

- 1 Set the Power switch to "ON".
- 2 Press "◀" or "▶" to select the image to add a voice memo.

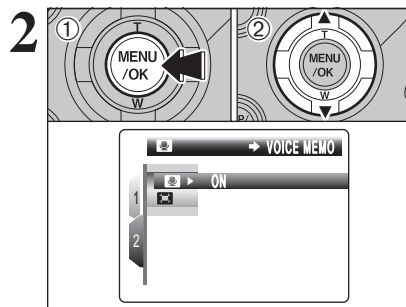

- 1 Press the "MENU/OK" button to display the menu on the screen.
- 2 Press "▲" or "▼" to select "VOICE MEMO".

- Voice memos cannot be added to movies.
- When [PROTECTED FRAME] appears, unprotect the frame (→P.84).

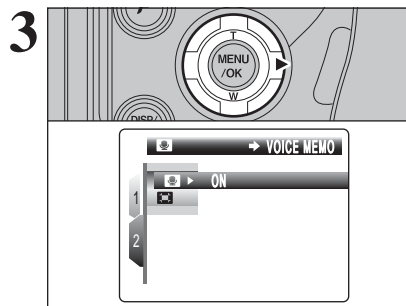

Press "▶".

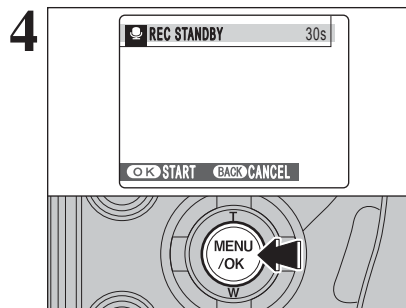

"REC STANDBY" appears on the screen. Press the "MENU/OK" button to begin recording.

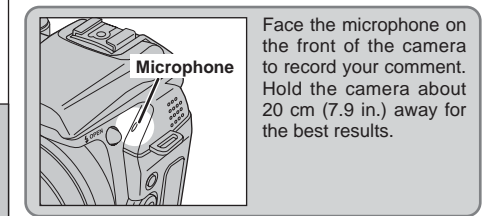

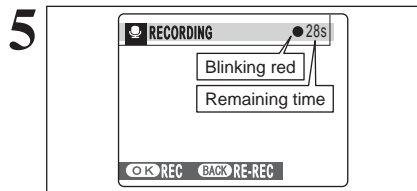

The remaining recording time appears during recording.

To end your comment during recording, press the "MENU/OK" button.

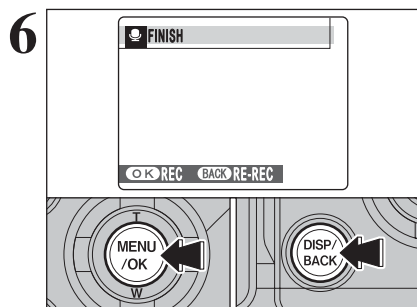

After 30 seconds of recording, "FINISH" appears on the screen.

To finish
Press the "MENU/OK" button.
To re-record your comment
Press the "DISP/BACK" button.

◆ **When the image already has a voice memo** ◆

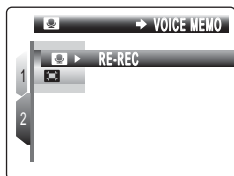

When you select an image that already has a voice memo, a screen appears in which you can select whether to re-record the voice memo.

When [PROTECTED FRAME] appears, unprotect the frame (P.84).

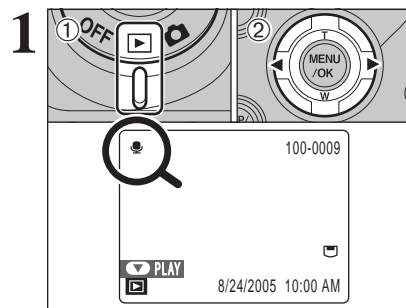

- 1 Set the Power switch to "▶".
- 2 Press "◀" or "▶" to select an image file that has a voice memo.

Voice memos cannot be played back using multi-frame playback. Press the "DISP/BACK" button to select single-frame playback.

"🔍" appears on the screen when an image file with a voice memo is selected.

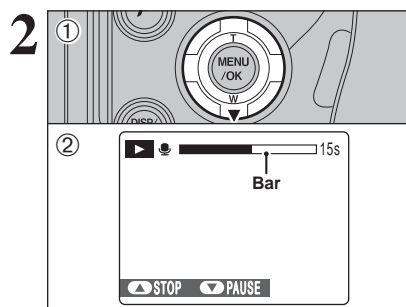

- 1 Press "▼" to play the voice memo.
- 2 The playback time appears on the screen along with a progress bar.

When the sound is difficult to hear, adjust the volume (P.90, 102).

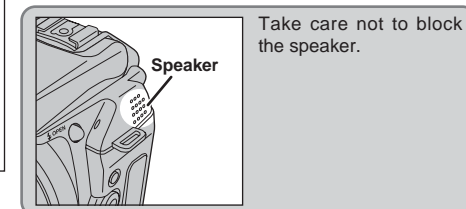

■ **Playing back voice memos**

	Control	Description
Playback		The voice memo stops when playback ends.
Pause/Resume		Pauses the voice memo during playback. Press "▼" again to resume playback.
Stop		Stops playback. * Press "◀" or "▶" while voice memo playback is stopped to go back to the previous file or advance to the next file respectively.
Fast forward/Rewind		Press "◀" or "▶" during playback to skip forwards or backwards through the voice memo. * These buttons do not function while playback is paused.

◆ **Playing voice memo files** ◆

You may not be able to play back some voice memo files recorded on other cameras.

Adjusting volume of voice memos

Volume can be adjusted while playing back voice memos. Adjust the volume to suit your condition.

1 Press the "MENU/OK" button while playing back voice memo. The voice memo is paused during playback.

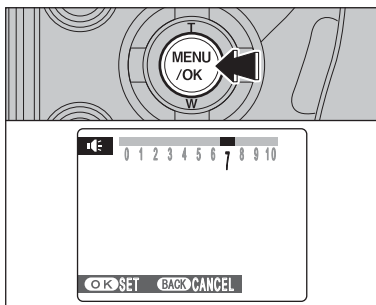

2 Press "◀" or "▶" to adjust the volume.

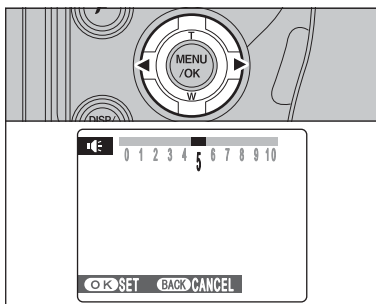

3 Press the "MENU/OK" button to confirm the new setting. Camera starts to play back the voice memo.

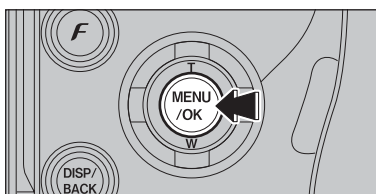

1
 ① Set the Power switch to "▶".
 ② Press "◀" or "▶" to select the trimming frame (file).

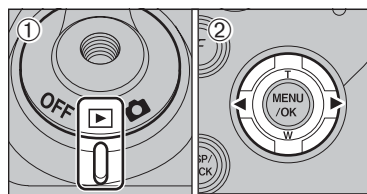

2
 ① Press the "MENU/OK" button to display the menu on the screen.
 ② Press "▲" or "▼" to select "TRIMMING".

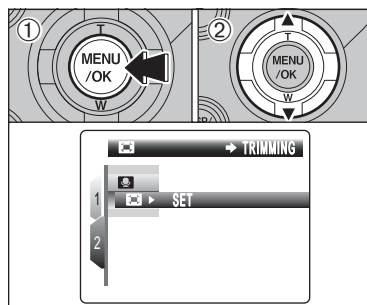

3 Press "▶".

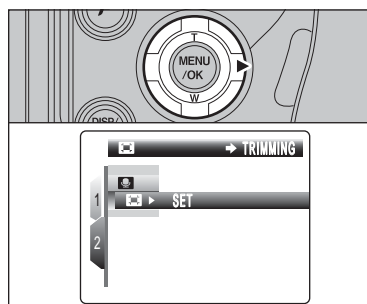

4 Press "▲" or "▼" to zoom in or out on an image. A zoom bar appears on the screen.

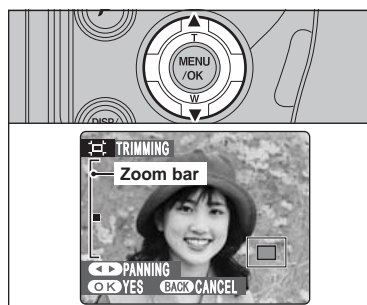

Press the "DISP/BACK" button to return to single-frame playback.

A saved image size varies depending on the zoom scale. For 0.3M, the "OK YES" option appears in yellow.

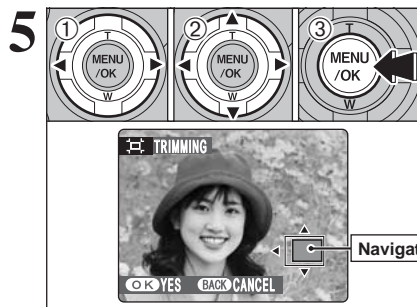

- ① Press “◀” or “▶” to select to “PANNING”.
- ② Press “▲”, “▼”, “◀” or “▶” to display another part of the image.
The current displayed image appears on the navigation screen.
- ③ Press the “MENU/OK” button to trim the image.

Press the “DISP/BACK” button to return to the zoom setting.

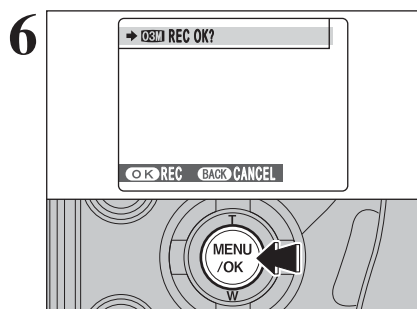

Check the saved image size and press the “MENU/OK” button. The trimmed image is added as a separate file in the final frame.

■ Image sizes

	Sample uses
5M	Printing at up to 10R (25.4 × 30.5 cm) / A4 size
3M	Printing at up to 6R (15.2 × 20.3 cm) / A5 size
2M	Printing at up to 4R (10.2 × 15.2 cm) / A6 size
03M	To use for e-mail or web site

When “03” quality setting is selected, the image is trimmed to normal size (4:3 aspect ratio).

◆ Images that can be trimmed ◆

You may not be able to trim images that were shot with a camera other than the FinePix S9000 / FinePix S9500.

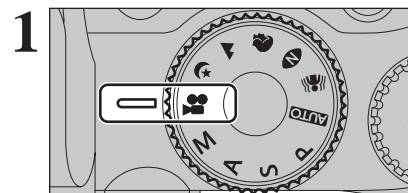

Set the Mode dial to “”. Use “” Movie mode to record movies with sound.

- **Specifications**
Motion JPEG (⇒P.137) with monaural sound
- **Quality selection method**
640 (640 × 480 pixels)
320 (320 × 240 pixels)
- **Frame rate** (⇒P.137)
30 frames per second (fixed)

- ⓘ See P.95 for information on changing the quality mode.
- ⓘ Because a movie is recorded onto the media as it is saved, it cannot be recorded correctly if the camera suddenly loses power (if you open the battery cover or slot cover, or disconnect the AC power adapter).

It may not be possible to playback your movies on other cameras.

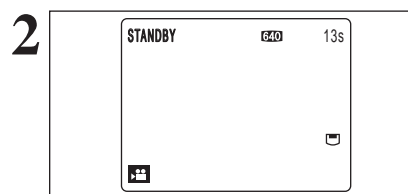

The available recording time and “STANDBY” appear on the screen.

Because sound is recorded concurrently with the images, make sure that you do not cover the microphone with a finger, etc. (⇒P.10).

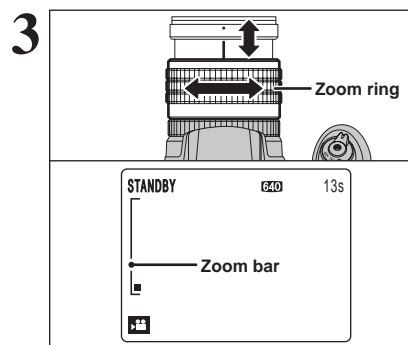

Turn the zoom ring to zoom in or out during shooting. Refocus on the subject after zooming.

- **Optical zoom focal length (35 mm camera equivalent)**
Approx. 28 mm to 300 mm
Max. zoom scale: 10.7×
- **Focal range**
Wide-angle: approx. 50 cm (1.6 ft.) to infinity
Telephoto: approx. 2 m (6.6 ft.) to infinity

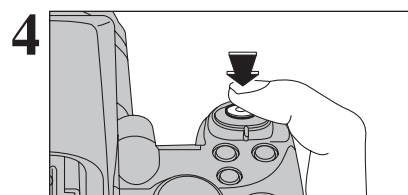

Press the shutter button down fully to start recording.

- ⓘ The brightness and color of the screen shown during movie recording may differ from those shown before recording begins.
- ⓘ There is no need to hold down the shutter button.
- ⓘ The noises made by camera operations such as focusing and aperture control may be recorded during movie shooting.

During shooting, the exposure and white balance are adjusted to the scene being shot.

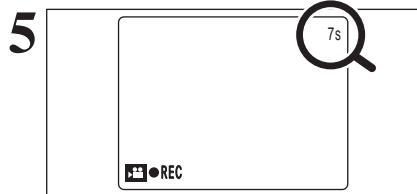

During recording, “●REC” appears in the bottom-left corner of the screen and a counter that shows the remaining time appears in the top-right corner of the screen.

- ⚠ If the brightness of the subject changes during movie recording, the sound of lens operation may be recorded.
- ⚠ Some wind noise may be recorded in shots taken outdoors.
- ⚠ When the remaining time runs out, recording ends and the movie is saved onto the media.

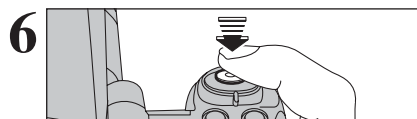

Press the shutter button down halfway during recording, the recording ends.

- ⚠ If recording is stopped immediately after it begins, 1 second of the movie is recorded onto the media.

Available recording times

■ Recording times per media

* These figures are the available recording times using a new media formatted on the camera. The actual recording times will vary depending on the free space available on the media.

Media capacity		Quality	
		640 (30 frames per second)	820 (30 frames per second)
xD-Picture Card	DPC-16 (16 MB)	13 sec.	26 sec.
	DPC-32 (32 MB)	27 sec.	54 sec.
	DPC-64 (64 MB)	55 sec.	109 sec.
	DPC-128 (128 MB)	111 sec.	219 sec.
	DPC-256 (256 MB)	223 sec.	7.3 min.
	DPC-512/M512 (512 MB)	7.4 min.	14.6 min.
Microdrive	DPC-M1GB (1 GB)	14.9 min.	29.3 min.
	Microdrive (340 MB)	5.1 min.	10.0 min.
	Microdrive (1 GB)	15.3 min.	30.1 min.

◆ Notes on using Microdrives for movie shooting ◆

If the camera's internal temperature rises too high, movie shooting stops to protect the media. Because Microdrives tend to generate heat (for mechanical reasons), long periods of continuous movie shooting may not be possible when the ambient temperature is high. As a general guide to shooting times, you can shoot movies for around 20 minutes at an ambient temperature of +30°C/+86°F and for around 30 minutes at +25°C/+77°F.

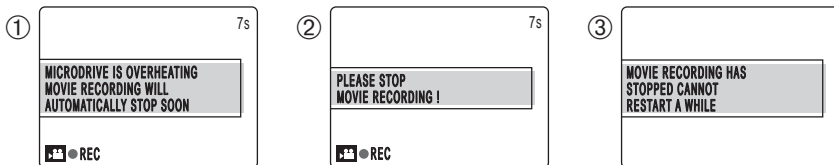

- ① If the camera's internal temperature rises during shooting, “MICRODRIVE IS OVERHEATING. MOVIE RECORDING WILL AUTOMATICALLY STOP SOON” appears.
- ② This then changes to “PLEASE STOP MOVIE RECORDING!”. If you continue shooting, the movie is saved and the camera shuts down.
- ③ If you then immediately try to start shooting again, “MOVIE RECORDING HAS STOPPED CANNOT RESTART A WHILE” appears and you cannot start shooting. Turn the camera off and do not use it for roughly 30 minutes until it has cooled down. Note that you can still shoot still images during this period.

⚠ Because the Microdrive is hot just after a movie is recorded, do not remove the Microdrive immediately.

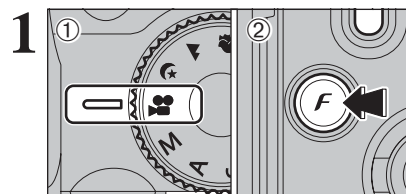

- ① Set the Mode dial to “”.
- ② Press the “F” button to display the menu on the screen.

- ⚠ In “” Movie mode, do not set the “” (sensitivity) setting.
- ⚠ In “” Movie mode, do not set the “” FinePix COLOR setting.

The quality setting is retained even when the camera is off or the mode setting is changed.

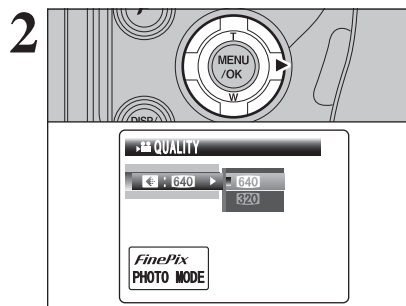

Press “▶”.

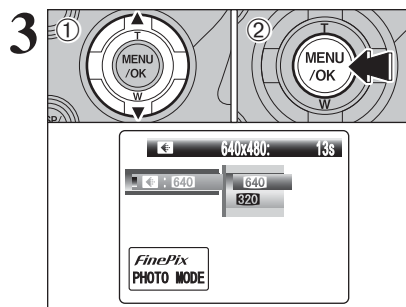

- ① Press “▲” or “▼” to change the setting.
- ② Press the “MENU/OK” button to confirm the setting.

Quality settings in Movie mode

Quality mode	Sample uses
640 (640 × 480)	For better quality
820 (320 × 240)	To record longer movies

When used media is 4GB or more, a movie up to 60 minutes long (at the “640” setting) or 120 minutes long (at the “820” setting) can be recorded.

Visit website for information on available Microdrive / CompactFlash card:
<http://home.fujifilm.com/products/digital/>

PLAYBACK MODE PLAYING BACK MOVIES

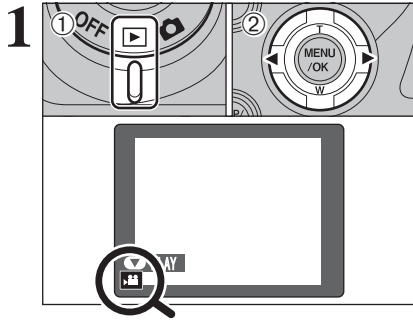

- 1 Set the Power switch to "OFF".
- 2 Press "◀" or "▶" to select the movie file.

⚠ Movies cannot be played back using multi-frame playback. Press the "DISP/BACK" button to select single-frame playback.

Indicated by the "M" icon.

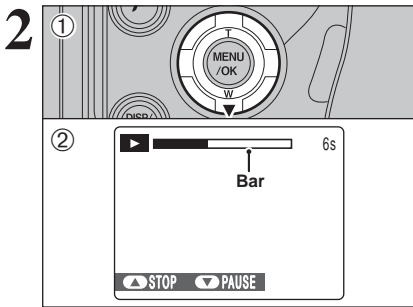

- 1 Press "▼" to play the movie.
- 2 The playback time appears on the screen along with a progress bar.

- ⚠ Take care not to block the speaker.
- ⚠ When the sound is difficult to hear, adjust the volume (→P.97, 102).
- ⚠ If the subject of the shot is very bright, white vertical streaks or black horizontal streaks may appear in the image during playback. This is normal.

■ Playing back movies

	Control	Description
Playback		Playback begins. Playback stops when the end of the movie is reached.
Pause/Resume		Pauses the movie during playback. Press "▼" again to resume playback.
Stop		Stops playback. * Press "◀" or "▶" while playback is stopped to go back to the previous file or advance to the next file respectively.
Fast forward/Rewind		Press "◀" or "▶" during playback to skip forwards or backwards through the movie.
Skip playback	 When paused	Press "◀" or "▶" when the movie is paused, the movie advances or goes back one frame. Hold down "◀" or "▶" to move through the frames quickly.

◆ Playing movie files ◆

- You may not be able to play back some movie files recorded on other cameras.
- To play back movie files on a PC, save the movie file on the media to the PC's hard disk and then play back the saved file.

Adjusting volume of movies

Volume can be adjusted while playing back movies. Adjust the volume to suit your condition.

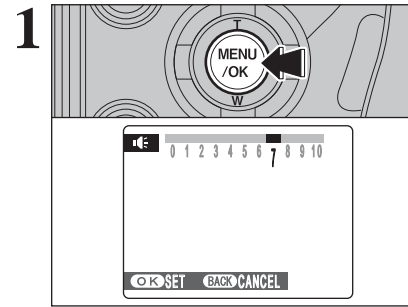

Press the "MENU/OK" button while playing back movie. The movie is paused during playback.

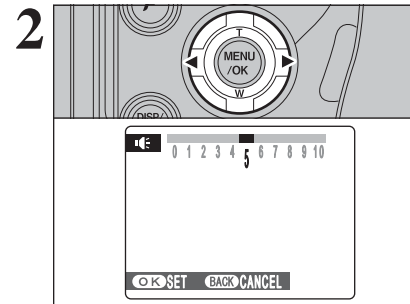

Press "◀" or "▶" to adjust the volume.

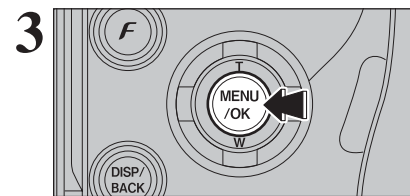

Press the "MENU/OK" button to confirm the new setting. Camera starts to play back the movie.

SET USING THE SET-UP SCREEN

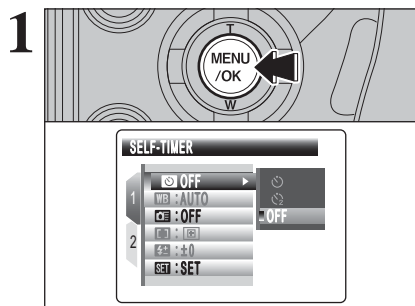

Press the "MENU/OK" button to display the menu on the screen.

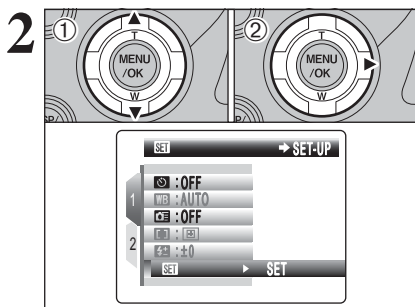

① Press "▲" or "▼" to select "SET" SET-UP.
② Press "▶".

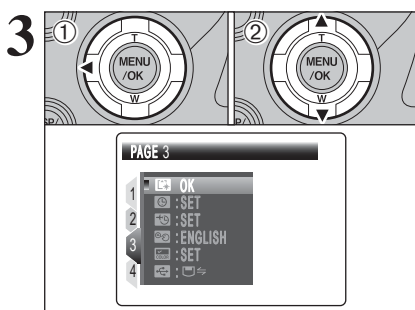

① Press "◀" to move to page number.
② Press "▲" or "▼" to select the page.

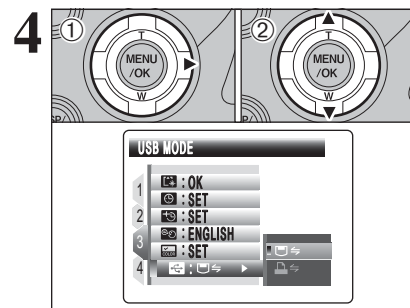

① Press "▶" to move to menu item.
② Press "▲" or "▼" to select the menu item.

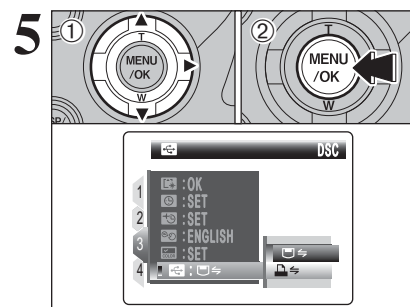

① Press "▶" to select a menu option. Press "▲" or "▼" to change the setting. Press "▶" for "▶" PLAYBACK VOLUME, "▶" LCD BRIGHTNESS, "▶" FORMAT, "▶" DATE/TIME, "▶" TIME DIFFERENCE, "▶" BACKGROUND COLOR, "▶" DISCHARGE or "▶" RESET.
② After you have changed the settings, press the "MENU/OK" button to confirm the changes.

■ SET-UP menu options

Settings	Display	Factory default	Explanation	Page	
1	IMAGE DISP.	CONT/3 SEC/ 1.5 SEC/OFF	1.5 SEC Specifies whether an image checking screen (photography result) appears after taking a picture. The image appears for a few moments and is then recorded. The color tones in images recorded may differ from actual color. Play back the recorded images to check them.	101	
	SHUTTER VOLUME	OFF/1/2/3	2	Sets the volume of the sound emitted when the shutter operates.	-
	BEEP VOLUME	OFF/1/2/3	2	Sets the volume of the tone emitted when the camera controls are used.	-
	PLAYBACK VOLUME	SET	7	Sets the volume of playing back movie and voice memo.	102
	FRAME NO.	CONT./RENEW	CONT.	Specifies whether frame numbers are assigned consecutively from previous numbers or begin again.	102
	LCD BRIGHTNESS	SET	0	Sets the screen brightness.	103
2	MEDIA	(xD-Picture Card) (CF/Microdrive)	(xD-Picture Card) (CF/Microdrive)	Sets the media to be used when an xD-Picture Card and a CF/Microdrive are loaded in the camera.	-
	CCD-RAW	OFF/ON	OFF	Sets the image quality to CCD-RAW. Because no image processing is performed on the camera for CCD-RAW images, images must be processed on a PC.	103
	EVF/LCD MODE	30fps/60fps	30fps	The screen is displayed smoothly in any situations such as immediately after moving the camera.	-
	AE-LOCK MODE	AE-L1/AE-L2	AE-L1	Selects the AE lock setting.	-
	AF ILLUMINATOR	ON/OFF	ON	Specifies whether the AF-assist illuminator is ON or OFF.	-
	AUTO POWER OFF	5 MIN/2 MIN/OFF	2 MIN	Sets the time of turning camera off when camera is not used.	104
3	FORMAT	OK	-	Erases all files.	104
	DATE/TIME	SET	-	Corrects the date and time.	17
	TIME DIFFERENCE	SET	-	Specifies the time difference settings.	105
	言語/LANG.	ENGLISH/FRANCAIS/ DEUTSCH/ESPAÑOL/ ITALIANO/中文/한글	ENGLISH	Specifies the language used for screen display.	19
	BACKGROUND COLOR	SET	-	Specifies the colors of menu and cursor.	-
	USB MODE			⇐: DSC (Mass storage device) mode Provides a simple way to read images from a media and store images onto a media.	117
⇐: PictBridge If a printer that supports PictBridge is available, images can be printed by connecting the camera directly to the PictBridge-compatible printer without using a PC.				113	
4	VIDEO SYSTEM	NTSC/PAL	-	Specifies whether video output is set to NTSC or PAL.	-
	DISCHARGE	OK	-	Discharges Ni-MH batteries.	127
	RESET	OK	-	Resets all the camera settings (other than the DATE/TIME, TIME DIFFERENCE, 言語/LANG., VIDEO SYSTEM and BACKGROUND COLOR) to the factory default values set at shipment. A confirmation message appears when you press "▶". To reset the camera settings, press the "MENU/OK" button again.	-

IMAGE DISPLAY

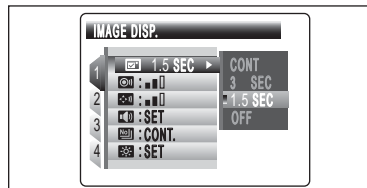

Use this setting to specify whether images are displayed after shooting.

CONT: The results are always displayed after you shoot. The display changes between the histogram and photography information each time you press the "INFO" button. Press the "MENU/OK" button to take another picture.

3 SEC/1.5 SEC: The image appears for about 3 or 1.5 seconds and is then recorded.

OFF: Images are recorded without being displayed.

- ⚙ In long-period continuous shooting, the images do not appear.
- ⚙ In top 4-frame continuous shooting, auto bracketing and final 4-frame continuous shooting, the images appear for a set time before being recorded even when "OFF" is selected.
- ⚙ When selecting "CONT", information for the photography settings does not appear in "Auto", "P", "A", "S", "M", and "C" mode.
- ⚙ The color tones in images displayed when "3 SEC" or "1.5 SEC" is selected may differ slightly from those in the images actually recorded.

PLAYBACK VOLUME

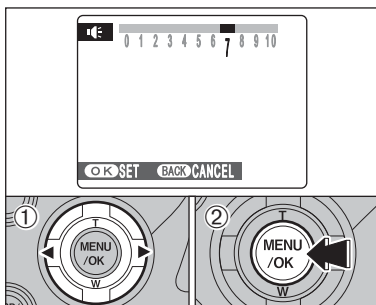

Adjust volume while playing back movie and voice memo.

- ① Press “◀” or “▶” to adjust the volume. The larger the number, the larger the volume is emitted. “0” indicates a sound deadening.
- ② Press the “MENU/OK” button to confirm the new setting.

FRAME NO.

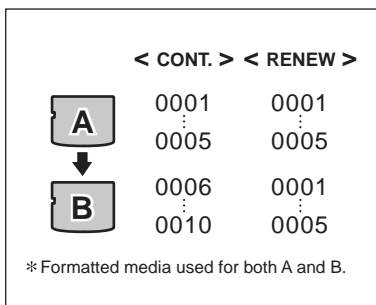

Specifies whether frame numbers are assigned consecutively from previous numbers or begin again.

CONT.: Pictures are stored beginning from the highest file number stored on the last media used.

RENEW: Pictures are stored on each media beginning with a file number “0001”.

Setting this function to “CONT.” makes file management easier as it makes sure that file names are not duplicated when images are downloaded to a PC.

- When the camera settings are “RESET”, the frame number setting (“CONT.” or “RENEW”) is changed to “CONT.” and the frame number itself does not return to “0001”.
- When the media already contains image files with file numbers higher than the highest file number on the last media, images are stored beginning from the highest file number on the current media.

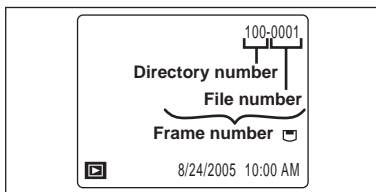

Check the file number by viewing the image. The last 4 digits of the 7-digit number in the top right corner of the screen are the file numbers, while the first 3 digits show the directory number.

- When changing the media, always turn the camera off before opening the slot cover. Opening the slot cover without turning the camera off may cause the frame number memory to not function.
- File number runs from 0001 to 9999. Once 9999 is exceeded, the directory number changes from 100 to 101. The maximum number is 999-9999.
- The displayed frame number may differ for images photographed on other cameras.
- When [FRAME NO. FULL] appears, see P.130.

ADJUSTING SCREEN BRIGHTNESS

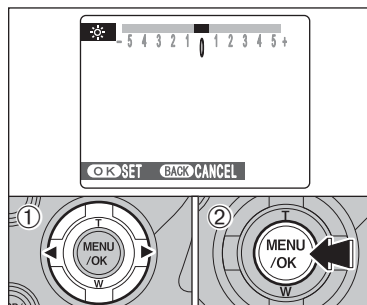

To adjust screen brightness:

- ① Press “◀” or “▶” to adjust the screen brightness.
- ② Press the “MENU/OK” button to confirm the new setting.

CCD-RAW

Setting CCD-RAW to ON disables the signal processing functions (reconstituting the data received from the CCD as an image) performed on the camera. Consequently, this task must be performed on the PC.

Use the bundled RAW FILE CONVERTER LE software to perform the processing on a PC. Conversion using RAW FILE CONVERTER LE also provides a simple way to create TIFF-format images.

* To rebuild images, FinePixViewer (on the bundled CD-ROM) must be installed on your PC.

The functions listed below cannot be used in CCD-RAW mode.

During shooting	Digital zoom, Continuous shooting and Quality are unavailable.
During playback	Playback can be zoomed up to 2.5x, but cropped images cannot be saved.

AUTO POWER OFF

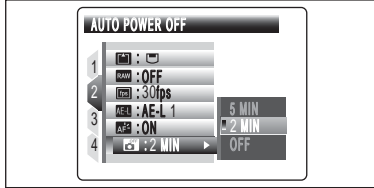

When this function is enabled and the camera remains unused for 2 or 5 minutes, it is turned off. Auto power off function prevents leaving the power on.

⚠ The Auto power off function is disabled during automatic playing back and discharging, and when a USB connection is being used.

To restore power to the camera

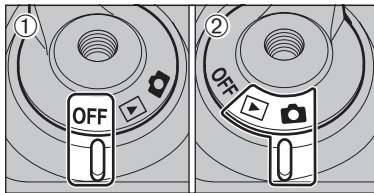

- 1 Set the Power switch to "OFF".
- 2 Set the Power switch back to "CAMERA" or "PC".

FORMAT

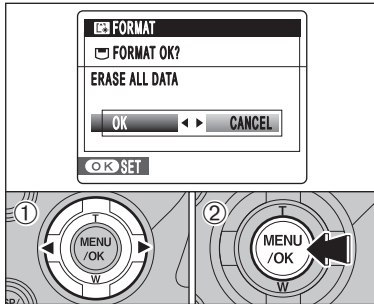

Initialize (format) the media for use with the camera. Because initializing the media erases all the frames (files), including protected frames (files). Back up important frames (files) onto your PC or another media.

- 1 Press "◀" or "▶" to select "OK".
 - 2 Pressing the "MENU/OK" button erases all the frames (files) and initializes the media.
- ⚠ Always check the media to be formatted on the screen before proceeding.
- Formatted media
 - "FORMAT OK?": xD-Picture Cards
 - "FORMAT OK?": CF/Microdrives
- ⚠ When [CARD ERROR], [WRITE ERROR], [READ ERROR] or [CARD NOT INITIALIZED] appears, see P.130 for information before formatting the media.

TIME DIFFERENCE

This function sets a time difference relative to the date and time currently set. When this setting is enabled, the specified time difference is applied when pictures are taken. Use this function when traveling to destinations in different time zones.

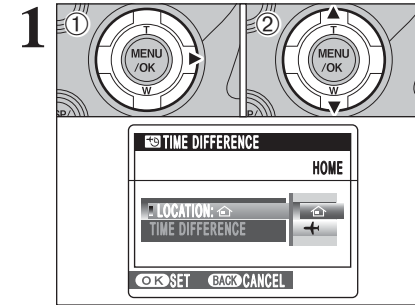

- 1 Press "▶".
 - 2 Press "▲" or "▼" to change between "HOME" and "LOCAL".
- To set the time difference, select "LOCAL".
- HOME: Your home time zone
 - LOCAL: Your destination time zone

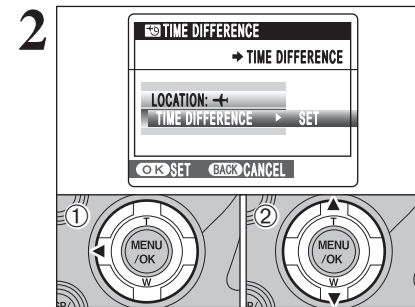

- 1 Press "◀".
- 2 Press "▲" or "▼" to select "TIME DIFFERENCE".

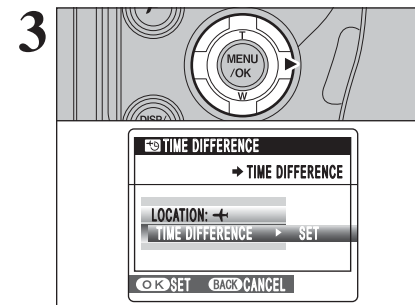

Press "▶".

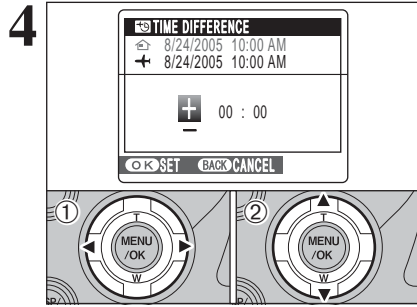

- ① Press “←” or “→” to select +, -, hour and minute.
 - ② Press “▲” or “▼” to correct the setting.
- **Available time setting**
-23:45 to +23:45 (in 15-minute increments)

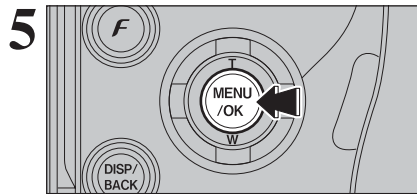

Always press the “MENU/OK” button after the settings are completed.

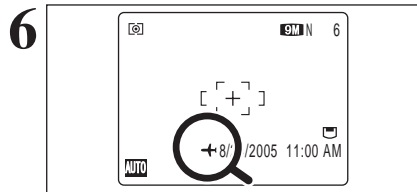

When the Photography mode is selected with world time set, “←” appears on the screen for 3 seconds and the date turns yellow.

Upon returning from a trip, always change the World time setting back to “HOME”.

Pre-installation checklist

To run this software, you must have the hardware and software described below. Check your system before you begin the installation.

Operating System *1	Windows 98 (including the Second Edition) Windows Millennium Edition (Windows Me) Windows 2000 Professional*2 Windows XP Home Edition*2 Windows XP Professional*2
CPU	200 MHz Pentium or better recommended (800 MHz Pentium III or better recommended for Windows XP)
RAM	64 MB minimum (128 MB minimum for Windows XP), Minimum 256 MB when RAW FILE CONVERTER LE is used
Hard disk space	Amount required for installation: 450 MB minimum Amount required for operation: 600 MB minimum (When using ImageMixer VCD2 LE for FinePix: 2 GB or better) Minimum 2 GB when RAW FILE CONVERTER LE is used (must specified in the OS as virtual memory or paging files)
Display	800 × 600 pixels or better, 16-bit color or better (When using ImageMixer VCD2 LE for FinePix: 1024 × 768 or better)
Internet connection *3	<ul style="list-style-type: none"> • To use the FinePix Internet Service or mail attachment function: An Internet connection or e-mail transmission software is needed • Connection speed: 56 k or better recommended

*1 Models with one of the above operating systems pre-installed.

*2 When you install the software, login using a system administrator account (e.g. “Administrator”).

*3 Required to use the FinePix Internet Service. The software can still be installed even if you do not have an Internet connection.

◆ **Notes** ◆

- Connect the camera directly to the PC using the USB cable (mini-B). The software may not operate correctly when you use an extension cable or connect the camera via a USB hub.
- When your PC has more than one USB port, the camera can be connected to either port.
- Push the USB connector fully into the socket to ensure that it is securely connected. The software may not operate correctly if the connection is faulty.
- Additional USB interface board is not guaranteed.
- Windows 95 and Windows NT cannot be used.
- Operation is not guaranteed on home-built PCs or on PCs running updated operating system software.
- When you reinstall or remove FinePixViewer, the Internet menu and your user ID and password for the FinePix Internet Service are deleted from your PC. Click the [Register now] button, enter your registered user ID and password and download the menu again.

5.1 INSTALLATION ON A Windows PC

Do not connect the camera to your PC until the software installation is completed.

- 1 Install FinePixViewer as instructed in the Quick start guide.

◆ Launching the installer manually ◆

- ① Double-click the "My Computer" icon.
 - * Windows XP users should click "My Computer" in the "Start" menu.
- ② Right-click "FINEPIX" (CD-ROM drive) in the "My Computer" window and select "Open".
- ③ Double-click "SETUP" or "SETUP.exe" in the CD-ROM window.



- * The way file names are displayed differs as described below depending on your PC settings.
 - File extensions (3-letter suffixes indicating the file type) may be shown or hidden. (e.g. Setup.exe or Setup)
 - Text may be shown normally or all in uppercase (e.g. Setup or SETUP).

◆ Installing other applications ◆

You may see messages for installing ImageMixer VCD2 LE for FinePix. Install this application as directed by the on-screen instructions.

- 2 Install DirectX as directed by the on-screen instructions and then restart your PC. If the latest version of DirectX is already installed on your PC, this installation is not performed.

- If the latest version is already installed, this window does not appear.
- Do not remove the CD-ROM during this procedure.

- 3 After restarting, the USB Video Class Driver would be installed.

- If the latest version is already installed, this window does not appear.
- The driver is only installed on Windows XP SP1.



- 4 After restarting the PC, a message appears stating "Installation of the FinePixViewer has been completed".

5.2 INSTALLATION ON A Mac OS X

Pre-installation checklist

■ Hardware and software requirements

To run this software, you must have the hardware and software described below. Check your system before you begin the installation.

Compatible Mac	Power Macintosh G3*1, PowerBook G3*1, Power Macintosh G4, iMac, iBook, Power Macintosh G4 Cube, or PowerBook G4, Power Macintosh G5
Operating System	Mac OS X (compatible with version 10.2.8 to 10.3.9)*2
RAM	192 MB minimum Minimum 256 MB when RAW FILE CONVERTER LE is used
Hard disk space	Amount required for installation: 200 MB minimum Amount required for operation: 400 MB minimum (When using ImageMixer VCD2 LE for FinePix: 2 GB or better) Minimum 2 GB when RAW FILE CONVERTER LE is used (required on the system disk)
Display	800 × 600 pixels or better, at least 32,000 colors (When using ImageMixer VCD2 LE for FinePix: 1024 × 768 or better)
Internet connection*3	<ul style="list-style-type: none">• To use the FinePix Internet Service or mail attachment function An Internet connection or e-mail transmission software is needed• Connection speed: 56 k or better recommended

*1 Models with a USB port as a standard feature

*2 This software does not support QuickTime 7.

*3 Required to use the FinePix Internet Service. The software can still be installed even if you do not have an Internet connection.

◆ Notes ◆

- Connect the camera directly to the Macintosh using the USB cable (mini-B). The software may not operate correctly if you use an extension cable or connect the camera via a USB hub.
- Push the USB connector fully into the socket to ensure that it is securely connected. The software may not operate correctly if the connection is faulty.
- Additional USB interface board is not guaranteed.
- On Macintosh PCs, allocate at least 400 MB of virtual memory when RAW FILE CONVERTER LE is used. If other applications will be used at the same time, allocate the additional amount required for those applications also.

5.2 INSTALLATION ON A Mac OS X

1 Turn your Macintosh on and start up Mac OS X. Do not launch any other applications.

2 When the bundled CD-ROM is loaded into the CD-ROM drive, the "FinePix" icon appears. Double-click the "FinePix" icon to open the "FinePix" volume window.



3 Double-click on "Installer for MacOSX".

4 The Installer setup dialog appears. Click the [Installing FinePixViewer] button.

For more information on what is installed, click the [Read Me First] button and [Using FinePixViewer] button.



5 The "Authenticate" dialog appears. Enter the name and password for the administrator account and then click the [OK] button.*

* The administrator account is the user account used for Mac OS X installation and you can confirm the user account in the Accounts dialog in the System Preferences.

6 The "License" dialog appears. Read the agreement carefully and then, if you agree to the terms of the Agreement, click the [Accept] button.

7 The "Read me" dialog appears. Click the [Continue] button.

8 The "FinePixInstallOSX" window appears. Click the [Install] button to install FinePixViewer and RAW FILE CONVERTER LE.

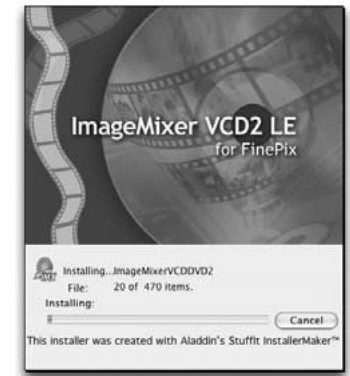

9 The ImageMixer VCD2 LE for FinePix installer automatically starts up and a window showing the installation progress appears (Installation may take several minutes).

10 The "FinePixViewer installation completed" message dialog appears. Then click exit button and close it.

When Safari is used as the Web browser, a message may be displayed and the CD-ROM may not be removed. If this happens, click the Safari icon in the Dock to make Safari the active application and then select "Quit Safari" in the "Safari" menu to shut down Safari.

11 Launch "Image Capture" from the "Applications" folder.

12 Change the Image Capture settings. Select "Preferences..." from the "Image Capture" menu.



13 Select "Other..." from "When a camera is connected, open".

14 Select "FPVBridge" from "FinePixViewer" folder in the "Applications" folder and click the [Open] button.



15 Select "Quit Image Capture" menu in the "Image Capture" menu.

6.1.1 Using the AC power adapter

Always use a FUJIFILM AC Power Adapter AC-5VX (sold separately) (⇒P.124). Use the AC power adapter to prevent losing power at inconvenient times, such as when downloading photographed images to your PC. You can take pictures and play back images without worrying about depleting the batteries.

- Only connect or disconnect the AC power adapter when the camera is off. Connecting or disconnecting the AC power adapter while the camera is turned on temporarily interrupts the power supply to the camera, so that images or movies being shot at the time are not recorded. Failing to turn the camera off first can also result in damage to the media or malfunctions during PC connection.

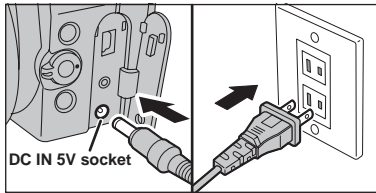

Check that the camera is off. Plug the AC power adapter connector into the "DC IN 5V" socket and then plug the AC power adapter into the power outlet.

- The socket-outlet shall be installed near the equipment and shall be easily accessible.
- The shape of the plug and socket-outlet depends on the country of use.
- See P.126 for notes on using the AC power adapter.

Do not connect the AC power adapter to charge the AA-size Ni-MH (nickel-metal hydride) batteries. Use the optional charger (⇒P.124) to charge the Ni-MH batteries.

6.1.2 Connecting to a TV

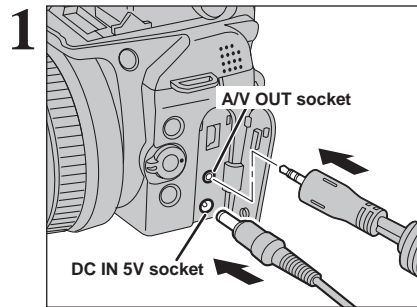

Turn off the camera and TV. Plug the A/V cable (included) into the "A/V OUT" (Audio/Visual output) socket.

- Plug the A/V cable (included) and the AC power adapter correctly and push them in the terminals.
- When there is a power outlet available, connect the AC Power Adapter AC-5VX.

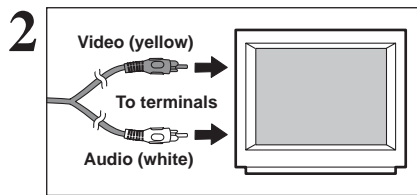

Plug the other end of the cable into the audio / video input socket on the TV. Then turn the camera and TV on and take pictures or play back images normally.

- When connecting the A/V cable to TV, the camera's screen is turned off.
- Refer to the instructions provided with your TV for more information on audio/video input for your TV.
- The image quality for movie playback is lower than for still images.

6.2 CONNECTING THE CAMERA DIRECTLY TO THE PRINTER — PictBridge FUNCTION

When a printer that supports PictBridge is available, images can be printed by connecting the camera directly to the PictBridge-compatible printer without using a PC.



- In PictBridge function, images photographed on other than a camera may not be printed.

6.2.1 Specifying images for printing on the camera

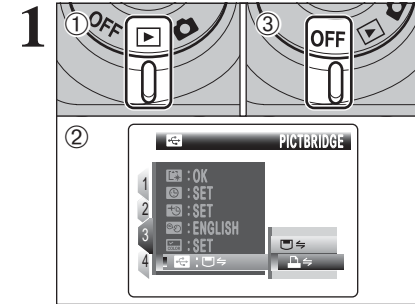

- Set the Power switch to "ON" to turn the camera on.
- Select "PICTBRIDGE" in "USB MODE" in the "SET-UP" menu (⇒P.100).
- Set the Power switch to "OFF" to turn the camera off.

- Do not connect to a PC when the "USB MODE" setting is set to "PICTBRIDGE". See P.133 if you connect to a PC by mistake.

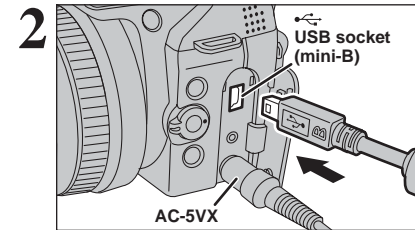

- Connect the camera to the printer using the USB cable (mini-B).
- Turn the printer on.

- The camera cannot be used to specify printer settings such as the paper size and print quality.
- Please connect the AC Power Adapter AC-5VX (sold separately) to your camera.
- Use a media that was formatted on FinePix S9000 / FinePix S9500.

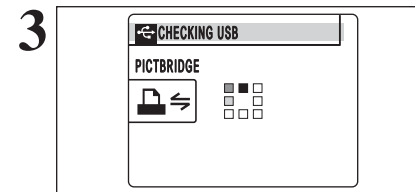

Set the Power switch to "ON". "CHECKING USB" appears and then the menu is displayed on the screen.

- If the menu does not appear, check whether the "USB MODE" setting is "PICTBRIDGE".
- Depending on the printer, some functions are disabled.

6.2 CONNECTING THE CAMERA DIRECTLY TO THE PRINTER — PictBridge FUNCTION

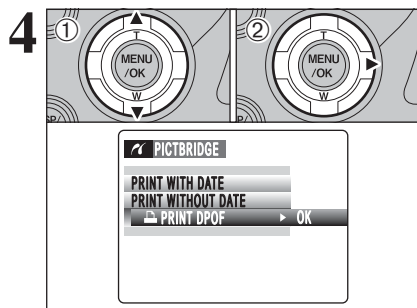

- ① Press "▲" or "▼" to select "PRINT DPOF".
- ② Press "▶".

- ⚠ When [NOT SET DPOF] appears, the DPOF settings are not specified.
- ⚠ To use DPOF printing, the DPOF settings must be specified on FinePix S9000 / FinePix S9500 beforehand (→P.79).
- ⚠ Even when "WITH DATE" is specified in the DPOF settings, the date is not inserted on printers that do not support date printing.

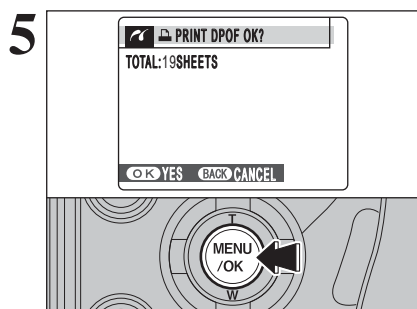

"PRINT DPOF OK?" appears on the screen. Press the "MENU/OK" button to begin printing.

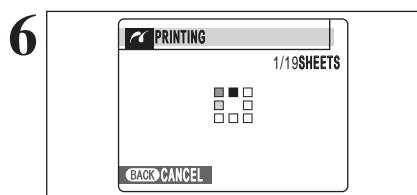

The specified frames (files) are printed continuously.

- ⚠ Press the "DISP/BACK" button to cancel the printing. Depending on the printer, the printing may not be canceled immediately or printing may stop midway through. When printing stops midway, briefly turn the camera off and then on again.

6.2.2 Specifying images for printing without using DPOF (single-frame printing)

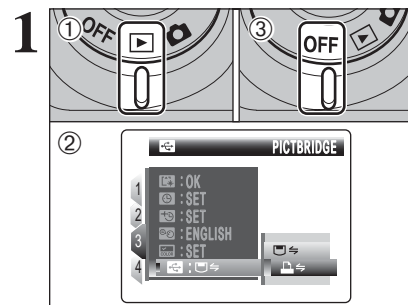

- ① Set the Power switch to "OFF" to turn the camera on.
- ② Select "PictBridge" in "USB MODE" in the "SET-UP" menu (→P.100).
- ③ Set the Power switch to "OFF" to turn the camera off.

- ⚠ Do not connect to a PC when the "USB MODE" setting is set to "PictBridge". See P.133 if you connect to a PC by mistake.

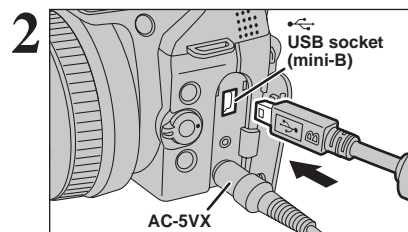

- ① Connect the camera to the printer using the USB cable (mini-B).
- ② Turn the printer on.

- ⚠ The camera cannot be used to specify printer settings such as the paper size and print quality.
- ⚠ Please connect the AC Power Adapter AC-5VX (sold separately) to your camera.
- ⚠ Use a media that was formatted on FinePix S9000 / FinePix S9500.

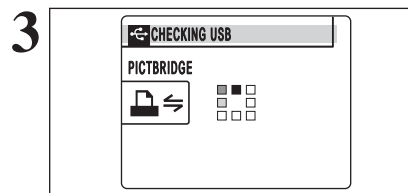

Set the Power switch to "OFF". "CHECKING USB" appears and then the menu is displayed on the screen.

- ⚠ If the menu does not appear, check whether the "USB MODE" setting is "PictBridge".
- ⚠ Depending on the printer, some functions are disabled.

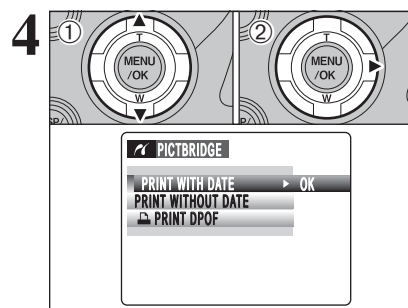

- ① Press "▲" or "▼" to select "PRINT WITH DATE" or "PRINT WITHOUT DATE". If "PRINT WITH DATE" is selected, the date is imprinted on your prints.
- ② Press "▶".

- ⚠ "PRINT WITH DATE" is not available when the camera is connected to a printer that does not support date printing.

6.2 CONNECTING THE CAMERA DIRECTLY TO THE PRINTER — PictBridge FUNCTION

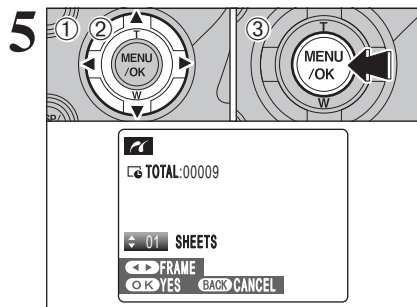

① Press “◀” or “▶” to display the frame (file) for which you want to specify PRINT settings.

② Press “▲” or “▼” to set a value up to 99 as the number of copies of the frame (file) to be printed. For frames (files) that you do not want printed, set the number of prints to 0 (zero).

To specify more PRINT settings, repeat steps ① and ②.

③ Always press the “MENU/OK” button after the settings are completed.

- ⚡ Movies and images with CCD-RAW cannot be printed.
- ⚡ Images photographed with a camera other than FinePix S9000 / FinePix S9500 may not be printed.

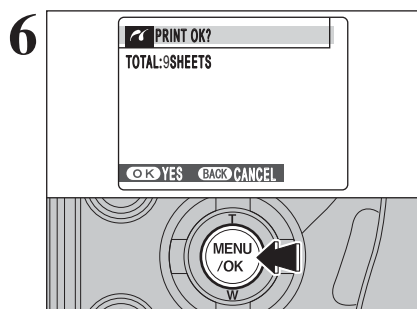

“PRINT OK?” appears on the screen. Press the “MENU/OK” button to begin printing.

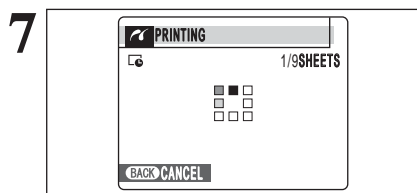

Printer starts printing the specified number of prints.

- ⚡ Press the “DISP/BACK” button to cancel the printing. Depending on the printer, the printing may not be canceled immediately or printing may stop midway through. When printing stops midway, briefly turn the camera off and then on again.

Disconnecting the printer

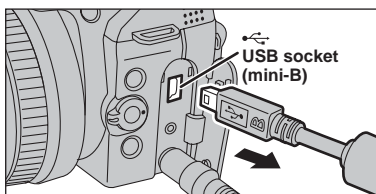

- ① Check that “PRINTING” is not displayed on the camera’s screen.
- ② Turn the camera off. Unplug the USB cable (mini-B).

6.3 CONNECTING TO A PC

6.3.1 Connecting to a PC

The “Connecting to a PC” section explains how to connect the camera to your PC using the USB cable (mini-B) and describes the functions you can use once the camera and PC are connected.

If the power cuts out during data transmission, the data will not be transmitted correctly. Always use the AC power adapter when connecting the camera to a PC.

Refer to Section 5 the first time you connect the camera to your PC.

Install the software first. Do not connect the camera to the PC before installing all the software.



CD-ROM
(Software for FinePix CX)

DSC (Mass storage device) mode

This mode provides a simple way to read images from a media and store images onto a media.

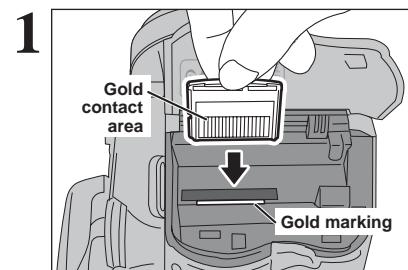

Insert the media into the camera.

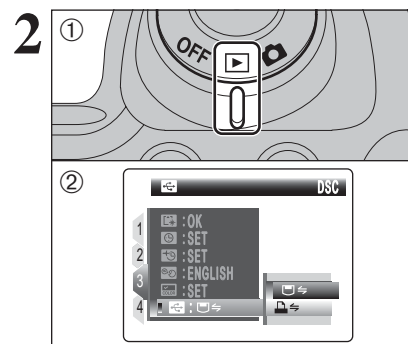

- ① Set the Power switch to “OFF” to turn the camera on.
- ② Select “DSC” in “USB MODE” in the “SET” SET-UP menu (P.100).
- ③ Turn the camera off.

- ⚡ Use the AC Power Adapter AC-5VX (sold separately) for the connection (P.112). If shutting off power supply during communication, the files on the media may be damaged.
- ⚡ If inserting an xD-Picture Card and a CF/Microdrive into the camera at the same time, images will be recorded onto the media selected as the “MEDIA” (P.100).

6.3 CONNECTING TO A PC

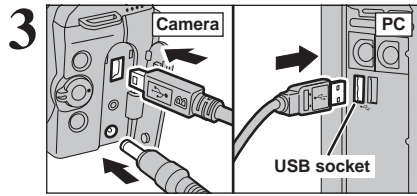

- ① Turn your PC on.
- ② Connect the camera to the PC using the USB cable (mini-B).

● Make sure that the USB cable (mini-B) is connected correctly and pushed in.

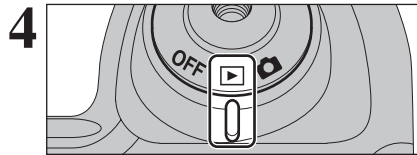

Set the Power switch to "ON".

Camera operation

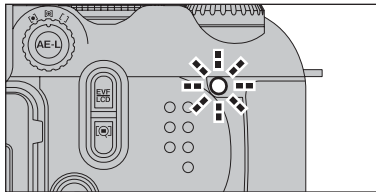

- When the camera and PC are exchanging data, the indicator lamp blinks orange.
- "DSC" appears on the screen.
- Auto power off is disabled during USB connection.

- Before replacing the media, always disconnect the camera from the PC. See P.120 for information on the disconnection procedure.
- Do not disconnect the USB cable (mini-B) when the camera is communicating with a PC. See P.120 for information on the disconnection procedure.

◆ When displaying [COMMUNICATION ERROR] ◆

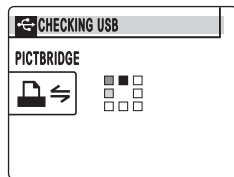

If "CHECKING USB" appears and then [COMMUNICATION ERROR] is displayed on the screen, "DSC" (DSC mode) is not selected in "USB MODE". Disconnect the USB cable (mini-B) to the camera and restart the procedure from step 1.

5 Set a PC

Windows 98 / 98 SE / Me / 2000 Professional / Macintosh

● The Windows CD-ROM may also be required during installation. In this event, change CD-ROMs as directed by the on-screen instructions.

- FinePixViewer automatically starts up and the Save Image Wizard window (Save Image dialog box) appears. Follow the instructions provided on screen to save the images. To proceed without saving the images, click the [Cancel] button.



* Screen for Windows 2000 Professional

- A removable disk icon appears and you can use your PC to transfer files to and from the camera.

Windows



Macintosh



If the above operations do not occur, you do not have the required software programs or drivers installed on your PC. Complete the required PC setup procedures. Then reconnect the camera to your PC.

Windows XP

- ① The "Found New Hardware" help message appears in the bottom-right corner of your screen. This message will close when the settings are completed. No action is required.



● This step is not required for subsequent connections.

- ② A new removable disk icon appears in the "My Computer" window. FinePixViewer automatically starts up and the Save Image Wizard window (Save Image dialog box) appears. Follow the instructions provided on screen to save the images. To proceed without saving the images, click the [Cancel] button.

◆ Regarding the icons ◆

The next time you connect the camera, the removable disk drive icon's name changes to the "FinePix" icon and name.

Proceed to "USING FinePixViewer" on P.121.

6.3 CONNECTING TO A PC

6.3.2 Disconnecting the camera

1 Windows

Once the image has been saved, the window below appears (Save Image Wizard Windows). To disconnect the camera, click the [Remove] button.



Macintosh

Once the image has been saved, the window below appears. To disconnect the camera, click the [OK] button.



2

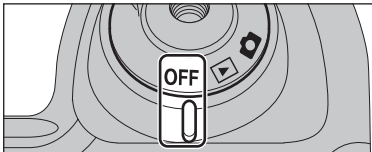

When the "It is now safe to disconnect the camera" message appears, click the [OK] button and disconnect the camera. Set the Power switch to "OFF" to turn the camera off.

6.4 USING FinePixViewer

6.4.1 Mastering FinePixViewer

For all information on FinePixViewer functions, refer to "How to Use FinePixViewer" in the Help menu for details.

• What is explained in "How to Use FinePixViewer"...

"How to Use FinePixViewer" covers a range of topics, including batch processing and ordering prints.

■ Example: Looking up slide shows

- 1 Click "How to Use FinePixViewer" in the FinePixViewer Help menu.
- 2 Click "Basic Operation" and then click "Slide Show" in the menu that appears.
- 3 The "Slide Show" information appears. Press the "<<<" key to view the previous page or the ">>>" key to view the next page.

6.4.2 Uninstalling the software

Only perform this operation when you no longer require the installed software or when the software was not installed correctly.

Windows

- 1 Check that the camera is not connected to the PC.
- 2 Quit all currently running applications.
- 3 Open the "My Computer" window. Then open the "Control Panel" and double-click on "Add/Remove Programs".



- 4 The "Add/Remove Programs Properties" window appears. Select the software to be uninstalled (FinePixViewer or the driver) and then click the [Add/Remove] button.

<To remove FinePixViewer>

FinePixViewer Ver.5.1

<To remove the driver software>

FUJIFILM USB Driver



6.4 USING FinePixViewer

- ⑤ When the message appears, click the [OK] button. Check your selection carefully since the process cannot be canceled once you click the [OK] button.



- ⑥ Automatic uninstallation begins. When uninstallation ends, click the [OK] button.

Macintosh

■ Uninstalling FinePixViewer

Quit FinePixViewer. Then drag the installed FinePixViewer folder to the Trash and select "Empty Trash" in the "Finder" menu.





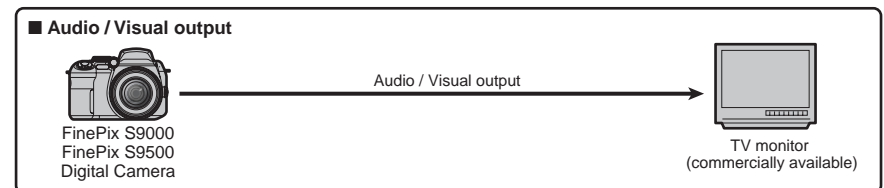
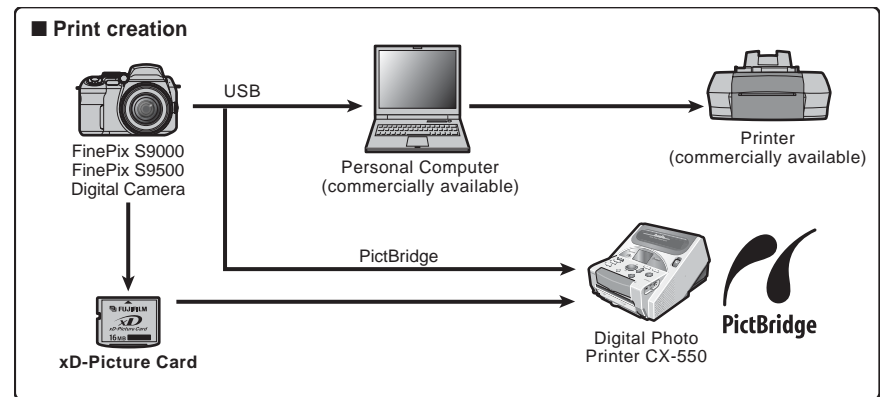
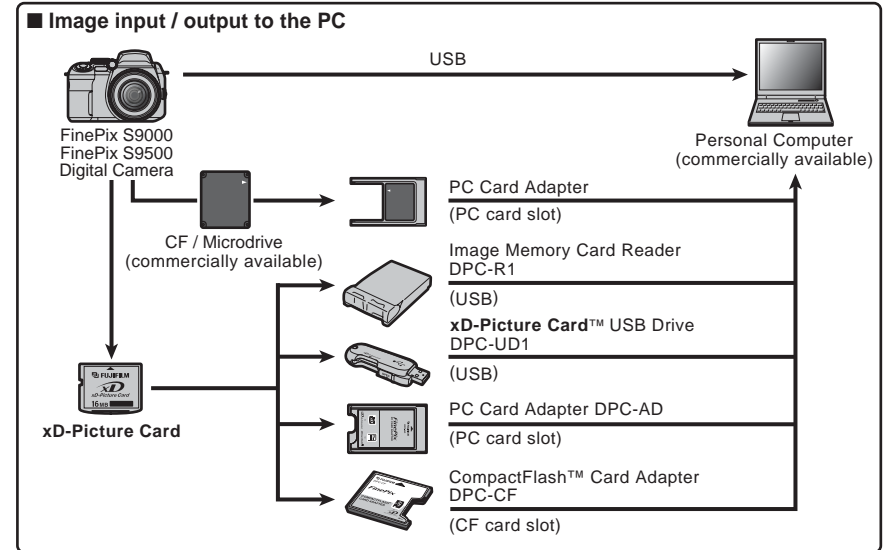

System Expansion Options

- By using the FinePix S9000 / FinePix S9500 together with other optional FUJIFILM products, your system can be expanded to fill a wide range of uses.

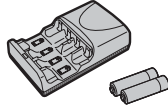
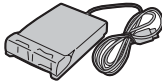

Accessories Guide

- Visit the FUJIFILM web site for the latest information on camera accessories.
<http://home.fujifilm.com/products/digital/index.html>

<p>● xD-Picture Card Use the following xD-Picture Cards: DPC-16 (16 MB)/DPC-32 (32 MB)/DPC-64 (64 MB)/DPC-128 (128 MB)/ DPC-256 (256 MB)/DPC-512 (512 MB)/DPC-M512 (512 MB)/DPC-M1GB (1 GB)</p>	
<p>● AC Power Adapter AC-5VX Use the AC-5VX when taking pictures or play back images for long periods or when the FinePix S9000 / FinePix S9500 is connected to a PC. * The shape of the AC power adapter, the plug and socket outlet depend on the country.</p>	
<p>● Fujifilm Rechargeable Battery 2HR-3UF The 2HR-3UF includes 2 pieces of high-capacity AA-size Ni-MH (nickel-metal hydride) batteries.</p>	
<p>● Fujifilm Battery Charger with Battery BK-NH2 (With Euro type or UK type plug) The BK-NH2 includes the quick battery charger BCH-NH2 and 2 Ni-MH batteries. The BCH-NH2 can charge 2 Ni-MH batteries in approx. 120 minutes. Up to 4 Ni-MH batteries can be charged simultaneously.</p>	
<p>● Soft Case SC-FXS9 This is a special case made of polyester that protects the camera against soil, dust and minor impacts when it is being carried.</p>	
<p>● Image Memory Card Reader DPC-R1 The DPC-R1 provides a quick and easy way to transfer images back and forth between your PC and an image memory card (xD-Picture Card and SmartMedia). The DPC-R1 uses the USB interface for high-speed file transfer.</p> <ul style="list-style-type: none"> ● Compatible with Windows 98/98 SE, Windows Me, Windows 2000 Professional, Windows XP or iMac, Mac OS 8.6 to 9.2.2, Mac OS X (10.1.2 to 10.2.2) and models that support USB as standard. ● Compatible with xD-Picture Card of 16 MB to 512 MB, and SmartMedia of 3.3 V, 4 MB to 128 MB. 	
<p>● PC Card Adapter DPC-AD The PC Card Adapter allows the xD-Picture Card and SmartMedia to be used as a PC Card Standard ATA-compliant (PCMCIA 2.1) PC card (Type II).</p> <ul style="list-style-type: none"> ● Compatible with xD-Picture Card of 16 MB to 512 MB, and SmartMedia of 3.3 V, 2 MB to 128 MB. 	
<p>● CompactFlash™ Card Adapter DPC-CF Loading an xD-Picture Card into this adapter allows you to use the card as a CompactFlash card (Type I).</p> <ul style="list-style-type: none"> ● Windows 95/98/98 SE/Me/2000 Professional/XP ● Mac OS 8.6 to 9.2/X (10.1.2 to 10.1.5) 	
<p>● xD-Picture Card™ USB Drive DPC-UD1 This is a compact card reader for xD-Picture Cards. Simply plug the drive into the USB port to read and write data to an xD-Picture Card (No driver installation is required except on Windows 98/98 SE).</p> <ul style="list-style-type: none"> ● Compatible with xD-Picture Card of 16 MB to 512 MB ● Windows 98/98 SE/Me/2000 Professional/XP ● Mac OS 9.0 to 9.2.2/X (10.0.4 to 10.2.6) 	

Using Your Camera Correctly

- Read this information and the “Safety Notes” (►P.142), to make sure you use your camera correctly.

■ Places to Avoid

Do not store or use the camera in the following types of locations:

- In the rain or in very humid, dirty or dusty places
- In direct sunlight or in places subject to extreme temperature rises, such as in a closed car in summer
- Extremely cold places
- Places with strong vibration
- Places with smoke or steam
- Places subject to strong magnetic fields (such as near motors, transformers or magnets)
- In contact with chemicals such as pesticides
- Next to rubber or vinyl products

■ Damage by Water or Sand

The FinePix S9000 / FinePix S9500 can be damaged on the inside and outside by water and sand. When you are at the beach or close to water, make sure that the camera is not damaged by water or sand. Take care not to place the camera on a wet surface.

■ Damage by Condensation

If the camera is carried from a cold location into a warm place, water droplets (condensation) may form on the inside of the camera or on the lens. When this occurs, turn the camera off and wait an hour before

using the camera. Condensation may also form on the media. In this event, remove the media and wait a short time.

■ When the Camera is Not Used or is stored Periods of Time

If you do not intend to use the camera for a long period of time, remove the batteries and the media.

■ Cleaning Your Camera

- Use a blower brush to remove any dust on the lens, LCD monitor, viewfinder or external AF sensor and then gently wipe the camera with a soft, dry cloth. If any soil remains, apply a small amount of lens cleaning liquid to a piece of FUJIFILM lens cleaning paper and wipe gently.
- Do not scratch hard objects against the lens, LCD monitor or viewfinder.
- Clean the body of the camera with a soft, dry cloth. Do not use volatile substances or cleaning products these items can cause damage.

■ Using the Camera When Traveling

When traveling overseas, do not place your camera in the check-in baggage. Baggage can be subjected to violent shocks, and the camera may be damaged inside or outside.

Power Supply and Batteries

Applicable Batteries

- In the camera, use AA-size alkaline or Ni-MH (nickel-metal hydride) rechargeable batteries. Do not use AA-size manganese or nickel-cadmium (Ni-Cd) batteries in your FinePix S9000 / FinePix S9500 because the heat created by the batteries could damage the camera or cause it not to work.
- The life of alkaline batteries varies between brands. The life of batteries you purchase may be shorter than those provided with the camera.

Notes on the Batteries

Incorrect use of the batteries could cause them to leak, become hot, ignite or burst. Always observe the precautions given below.

- Do not heat the batteries or throw them into a fire.
- Do not carry or store batteries with metal objects such as necklaces or hairpins.
- Do not expose the batteries to water, and keep batteries from getting wet or stored in moist locations.
- Do not attempt to take apart or change the batteries, including battery casings.
- Do not subject the batteries to strong impacts.
- Do not use batteries that are leaking, deformed, discolored.
- Do not store batteries in warm or humid places.
- Keep the batteries out of reach of babies and small children.
- Make sure that the battery polarity (⊕ and ⊖) is correct.

- Do not use new with used batteries. Do not use charged and discharged batteries together.
- Do not use different types or brands of batteries at the same time.
- If you do not intend to use the camera for a long period of time, remove the batteries from the camera. Note if the camera is left with the batteries removed, the time and date settings are cleared.
- The batteries feel warm right after being used. Before removing the batteries, turn the camera off and wait for the batteries to cool down.
- Since batteries do not work well in cold weather or locations, warm the batteries by placing them inside your garments before use. Batteries do not work well when cold. They will work again when the temperature returns to normal.
- Soil (such as fingerprints) on the battery terminals makes the batteries charge less reducing the number of images. Carefully wipe the battery terminals with a soft dry cloth before loading.

⚠ If any liquid at all leaks from the batteries, wipe the battery compartment thoroughly and then load new batteries.

⚠ If any battery fluid comes into contact with your hands or clothing, flush the area thoroughly with water. Note that battery fluid can cause loss of eyesight if it gets into your eyes. If this occurs, do not rub your eyes. Flush the fluid out with clean water and contact your physician for treatment.

Power Supply and Batteries

Using the AA-size Ni-MH batteries correctly

- As a power source in digital cameras, AA-size Ni-MH batteries (referred to hereafter as Ni-MH batteries) are superior to alkaline batteries in several ways, such as allowing more shots to be taken with the camera. However, care must be taken with the way Ni-MH batteries are used if their original performance is to be maintained.
- Ni-MH batteries left unused in storage for long periods can become “deactivated”. Also, repeatedly charging Ni-MH batteries that are only partially discharged can cause them to suffer from the “memory effect”.
- Ni-MH batteries that are “deactivated” or affected by “memory” suffer from the problem of only providing power for a short time after being charged. To prevent this problem, discharge and recharge them several times using the camera’s “Discharging rechargeable batteries” function. By repeating this cycle several times, the temporary reduction in performance caused by “memory” or “deactivation” can be remedied and the batteries can be restored to their original performance levels. Deactivation and memory are specific to Ni-MH batteries and are not in fact battery faults. See P.127 for the procedure for “Discharging rechargeable batteries”.

Do not use the “Discharging rechargeable batteries” function when alkaline batteries being used.

- To charge Ni-MH batteries, use the quick battery charger (sold separately). Refer to the instructions supplied with the charger to make sure that the charger is used correctly.
- Do not use the battery charger to charge other batteries.
- Note that the batteries feel warm after being charged.
- Due to the way the camera is constructed, a small amount of current is used even when the camera is turned off. Note in particular that leaving Ni-MH batteries in the camera for a long period will overdischarge the batteries and may render them unusable even after recharging.
- Ni-MH batteries will self-discharge even when not used, and the time for which they can be used may be shortened as a result.
- Ni-MH batteries will deteriorate rapidly if overdischarged (e.g. by discharging the batteries in a flashlight). Use the “Discharging rechargeable batteries” function provided in the camera to discharge the batteries.
- Ni-MH batteries have a limited service life. If a battery can only be used for a short time even after repeated discharge-charge cycles, it may have reached the end of its service life.

■ Disposing of Batteries

When disposing of batteries, do so in accordance with your local waste disposal regulations.

AC Power Adapter

Always use the AC Power Adapter AC-5VX with the camera.

The use of an AC Power adapter other than AC-5VX can be damaged to your digital camera.

- Use the AC power adapter for indoor use only.
- Plug the connection cord plug securely into the DC input terminal of the FUJIFILM Digital camera.
- Turn off the FUJIFILM Digital camera before disconnecting the cord from the FUJIFILM Digital camera’s DC input terminal. To disconnect, pull out the plug gently. Do not pull on the cord.
- Do not use the AC power adapter with any device other than your camera.
- During use, the AC power adapter will become hot to the touch. This is normal.
- Do not take apart the AC power adapter. Doing so could be dangerous.
- Do not use the AC power adapter in a hot and humid place.
- Do not subject the AC power adapter to strong shocks.
- The AC power adapter may emit a humming. This is normal.
- If used near a radio, the AC power adapter may cause static. If this happens, move the camera away from the radio.

Discharging rechargeable batteries

The “Discharging rechargeable batteries” function can only be used with Ni-MH batteries.

The “Discharging rechargeable batteries” function should not be used with alkaline batteries as it will completely drain the battery charge.

Use the “Discharging rechargeable batteries” function in the following situations:

- When the batteries only last for a short time after being charged normally
- When the batteries have not been used for a long period
- When you purchase new Ni-MH batteries

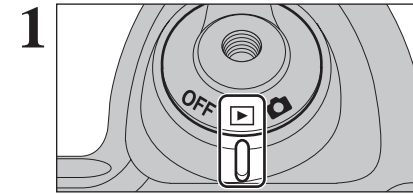

Set the Power switch to “▶”.

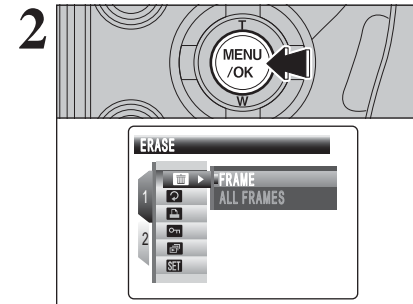

Press the “MENU/OK” button to display the menu on the screen.

Do not use the procedure for discharging rechargeable batteries with alkaline batteries.

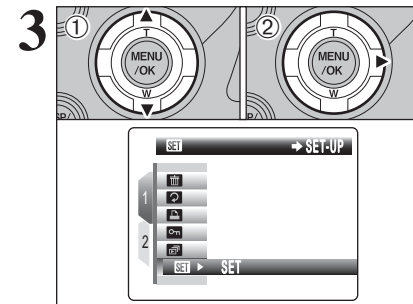

① Press “▲” or “▼” to select “SET” SET-UP.
② Press “▶”.

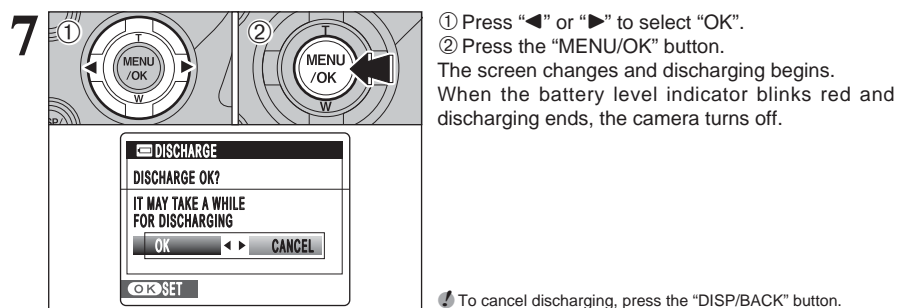
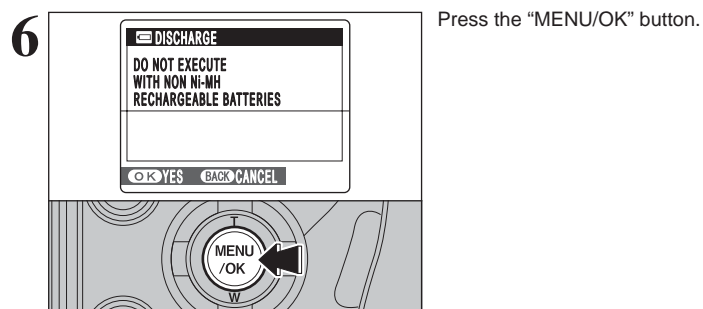
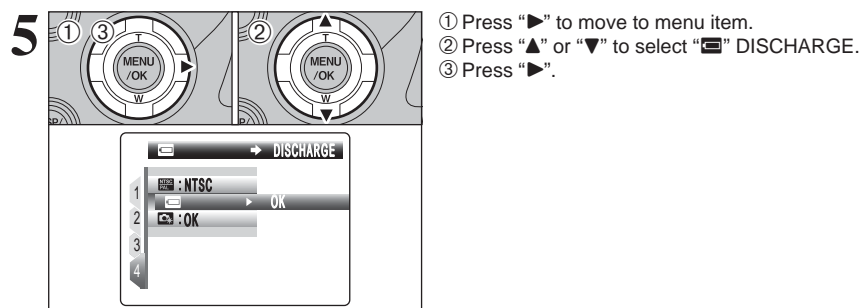
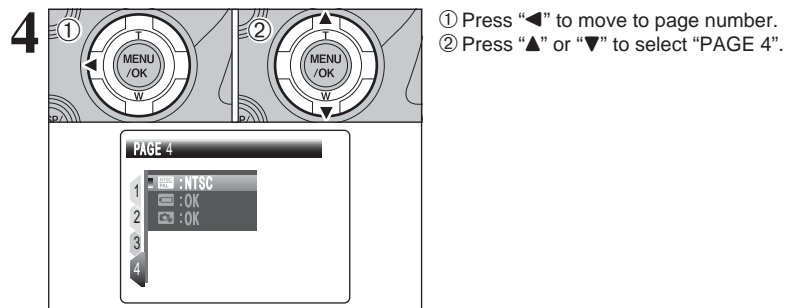

To cancel discharging, press the "DISP/BACK" button.

■ Image Memory Card

● This Image Memory Card is a new image recording media (**xD-Picture Card**) developed for digital cameras. The Image Memory Card consists of a semiconductor memory (NAND-type flash memory) to record digital image data.

The recording process is electrically performed and enables erasure of existing image data as well as re-recording of new image data.

● When using a new Memory Card, or a Memory Card that has been formatted by a PC, be sure to format the card with your digital camera before using it.

■ Microdrives

Microdrives are compact, lightweight hard disk drives that conform to the CF+ Type II standard. Due to their ample capacity for large image data files and their low per-megabyte recording cost, Microdrives provide a more economical way to save high-resolution image files.

■ Protecting Your Data

● Images and movies may be lost or destroyed in the following situations. Please note that FUJIFILM assumes no responsibility for data that is lost or destroyed.

1. Removal of the memory card or turning the power off while the memory card is being accessed (i.e., during record, erase, initialization, and playback operations).
2. Improper handling and use of the memory card by the user or third party.

● Save your important data to another media (i.e., MO disk, CD-R, hard disk, etc.).

■ Handling Media (all types)

● When inserting the media into the camera, hold the media straight as you push it in.

● Never remove the media or turn the camera off during data recording or erasing (media formatting) as this could be damaged to the media.

● Do not bend, drop or otherwise subject the media to strong force or shocks.

● Do not use or store these media in places with affected by strong static electricity or electrical noise.

● Do not use or store media in hot humid places or in places where they are exposed to corrosive substances.

■ Handling xD-Picture Card

● When storing **xD-Picture Cards**, make sure that they are kept out of the reach of children. An **xD-Picture Card** could be swallowed cause suffocation. If a child swallows an **xD-Picture Card**, seek medical attention or call emergency number right away.

● Do not expose an **xD-Picture Card** to shock. Do not apply pressure, and avoid bending.

● Do not use the **xD-Picture Card** in a hot or humid place.

● Clean the **xD-Picture Card** with a soft dry piece of cloth when dirty.

● When carrying or storing an **xD-Picture Card**, keep it in the special protective case.

● The **xD-Picture Card** will work well for long time, but will sooner or later lose its ability to store and play back images or movies. If this happens replace it with a new **xD-Picture Card**.

● The use of **xD-Picture Cards** is recommended with the FinePix S9000 / FinePix S9500.

The recording quality cannot be guaranteed when **xD-Picture Cards** other than those manufactured by

FUJIFILM are used.

● The **xD-Picture Card** may feel warm when it is removed from the camera after taking pictures. This is normal.

● Do not put labels on the **xD-Picture Card**. Peeling labels can cause the camera not to work properly.

■ Using Microdrive

● Do not use hard-pointed pens to write on the Microdrive label.

● Do not peel off the Microdrive label.

● Do not stick additional labels onto a Microdrive.

● When carrying or storing a Microdrive, keep it in the protective case provided.

● When a Microdrive is used, vibration or impacts during image data recording may prevent the image data from being recorded correctly. Put the camera down carefully when placing it on a desk or table, etc.

● Do not use Microdrive in CF+ Type II slots that do not have an eject function.

● Take care when handling Microdrive that have been used for long periods as they may become hot.

● Do not place Microdrives close to strong magnetic fields.

● Keep Microdrive dry.

● Do not apply strong pressure to the Microdrive cover.

■ Using Compact Flash

Contact the CompactFlash card manufacturer for information on the CompactFlash functions, operation details and system requirements.

Card types approved for use with the FinePix S9000 / FinePix S9500 are listed on the FUJIFILM website.

<http://home.fujifilm.com/products/digital/>

● The CompactFlash card may be hot immediately after being used in the camera and should be handled with care.

● Do not touch the card contact area with your fingers or metal objects.

● Unused CompactFlash cards should be formatted before being used.

■ Using media with a PC

● When taking pictures using a media that has been used on a PC, reformat the media using your camera for best quality.

● When formatting a media, a directory (folder) is created. Image data is then recorded in this directory.

● Do not change or delete the directory (folder) or file names on the media because this will make it impossible to use the media in your camera.

● Always use the camera to erase image data on a media.



● To edit image data, copy the image data to the PC and edit the copy.









■ Specifications

Type	Image memory card for digital cameras (xD-Picture Card)
Memory type	NAND-type flash memory
Conditions for use	Temperature: 0°C to +40°C (+32°F to +104°F) Humidity: 80% max. (no condensation)
Dimensions	25 mm × 20 mm × 2.2 mm (0.98 in. × 0.79 in. × 0.09 in.) (W × H × D)

Warning Displays

►The table below lists the warnings that are displayed on the screen.

Warning Displayed	Explanation	Remedy
 (Lit red)  (Blinking red)	The camera batteries are low or completely out of charge.	Load new or fully charged batteries.
	There is a strong likelihood of camera shake because the shutter speed is slow.	Use flash photography. However, use a tripod for some scenes and modes.
!AF	The AF (autofocus) cannot work effectively.	<ul style="list-style-type: none"> • If the image is too dark, take the picture at a distance of around 2 m (6.6 ft.) from the subject. • Use AF lock to take the picture.
Aperture/Shutter speed display (Lit red)	Outside the AE continuous range.	The picture can be taken, but the correct brightness (exposure) will not be obtained.
FOCUS ERROR ZOOM ERROR	Camera malfunction or fault.	<ul style="list-style-type: none"> • Turn the camera on again, taking care not to touch the lens. • Turn the camera off and on again. If the message still appears, contact your FUJIFILM dealer.
NO CARD	No media is inserted.	Insert a media.
CARD NOT INITIALIZED	<ul style="list-style-type: none"> • The media is not formatted. • The xD-Picture Card contact area is soiled. • Camera fault. 	<ul style="list-style-type: none"> • Format the media on the camera. • Wipe the contact area on the xD-Picture Card with a soft dry cloth. It may be necessary to format the xD-Picture Card. If the message still appears, replace the xD-Picture Card. • Contact your FUJIFILM dealer.
CARD ERROR	<ul style="list-style-type: none"> • The xD-Picture Card contact area is soiled. • The media format is incorrect. • Camera fault. • The media is damaged. 	<ul style="list-style-type: none"> • Wipe the contact area on the xD-Picture Card with a soft dry cloth. It may be necessary to format the xD-Picture Card. If the message still appears, replace the xD-Picture Card. • Contact your FUJIFILM dealer.
CARD FULL	The media is full.	Erase some images or use a media that has ample free space.
WRITE ERROR	<ul style="list-style-type: none"> • The data could not be recorded due to a media error or a connection error between the media and camera. • The image cannot be recorded as it is too large to fit in the available space on the media. 	<ul style="list-style-type: none"> • Re-insert the media or turn the camera off and then on again. If the message still appears, contact your FUJIFILM dealer. • Use a new media.
BUSY	The timing for recording was incorrect because the media was formatted on a PC.	Use a media that was formatted on the camera.
FRAME NO. FULL	The frame number has reached 999-9999.	<ol style="list-style-type: none"> ① Insert a formatted media into the camera. ② Set "RENEW" as the FRAME NO. setting in the "SET-UP" menu. ③ Start taking pictures (The frame number starts from "100-0001"). ④ Set "CONT." as the FRAME NO. setting in the "SET-UP" menu.
READ ERROR	<ul style="list-style-type: none"> • The played back file was not recorded correctly. • The xD-Picture Card contact area is soiled. • Camera fault. • An attempt was made to play a movie or display an image that was not recorded on this camera. 	<ul style="list-style-type: none"> • Images cannot be played back. • Wipe the contact area on the xD-Picture Card with a soft dry cloth. It may be necessary to format the xD-Picture Card. If the message still appears, replace the xD-Picture Card. • Contact your FUJIFILM dealer. • Movies and images cannot be played back.
TOO MANY FRAMES	An attempt was made to show 5,000 or more images by date sorting.	No more than 4,999 images can be shown by date sorting.
PROTECTED FRAME	<ul style="list-style-type: none"> • A protected file was encountered. • An attempt was made to add a voice memo to protected file. • An attempt was made to rotate a protected file. 	<ul style="list-style-type: none"> • Protected files cannot be erased. Remove the protection. • Protected files cannot be added to voice memos. Remove the protection. • Protected files cannot be rotated. Remove the protection.

Warning Displayed	Explanation	Remedy
 ERROR	<ul style="list-style-type: none"> • The voice memo file is faulty. • Camera fault. 	<ul style="list-style-type: none"> • The voice memo cannot be played back. • Contact your FUJIFILM dealer.
 CAN NOT TRIM  CAN NOT TRIM	An attempt was made to trim a 0.3M image or an image shot with the RAW setting.	The image cannot be trimmed.
CAN NOT TRIM	<ul style="list-style-type: none"> • An attempt was made to trim an image shot using a camera other than FinePix S9000 / FinePix S9500. • The image is damaged. 	The image cannot be trimmed.
DPOF FILE ERROR	Prints were specified for 1000 or more frames in the DPOF frame settings.	The maximum number of frames for which prints can be specified on the same media is 999. Copy the images for which you want to order prints onto another media and then specify the DPOF settings.
 CAN NOT SET DPOF  CAN NOT SET DPOF  CAN NOT SET DPOF	An attempt was made to specify DPOF settings for an image that is not supported by DPOF.	DPOF printing cannot be used with this image format.
 CAN NOT ROTATE	An attempt was made to rotate a movie.	These images cannot be rotated by image formats.
COMMUNICATION ERROR	The camera is not connected to a PC or printer.	<ul style="list-style-type: none"> • Check that the USB cable (mini-B) is connected correctly. • Check that your printer is turned on.
PRINTER ERROR	Displayed for PictBridge.	<ul style="list-style-type: none"> • Check that the printer is not out of paper or out of ink. • Turn the printer off briefly and then turn it back on. • Refer to the user manual supplied with your printer.
PRINTER ERROR RESUME?	Displayed for PictBridge.	Check that the printer is not out of paper or out of ink. Printing automatically restarts when the error is cleared. If the message still appears after checking, press the "MENU/OK" button to restart printing.
CANNOT BE PRINTED	Displayed for PictBridge.	<ul style="list-style-type: none"> • Refer to the user manual for the printer being used and check whether the printer supports the JFIF-JPEG or Exif-JPEG image format. If not, the printer cannot print the images. • Movies and images with CCD-RAW cannot be printed. • Was the image data photographed using FinePix S9000 / FinePix S9500? You may not be able to print some images photographed on other cameras.
 PRINTING	Displayed for PictBridge.	This message appears when printing is performed from a FUJIFILM printer that supports PictBridge. Refer to the Owner's Manual for the printer for details.
MICRODRIVE IS OVERHEATING MOVIE RECORDING WILL AUTOMATICALLY STOP SOON	An attempt was made to shoot a movie when the Microdrive was too hot.	Turn the camera off and stop using it for about 30 minutes until it has cooled down. Note that you can shoot still images during this period.
MOVIE RECORDING HAS STOPPED CANNOT RESTART A WHILE		

Troubleshooting

▶ If you think the camera is faulty, check the following once more.

Troubleshooting	Possible causes	Solutions
No power.	<ul style="list-style-type: none"> The batteries have run out. The AC power adapter plug has come out of the power outlet. The batteries are loaded backwards. The battery cover is not closed correctly. 	<ul style="list-style-type: none"> Load new or fully charged batteries. Plug the adapter back in. Load the batteries in the correct direction. Close the battery cover correctly.
Power cuts out during operation.	The batteries have run out.	Load new or fully charged batteries.
Batteries run out quickly.	<ul style="list-style-type: none"> Camera is being used in extremely cold conditions. The terminals are soiled. The batteries can no longer be recharged. The rechargeable batteries (if used) have become deactivated, or the battery capacity has diminished due to the memory effect. 	<ul style="list-style-type: none"> Put the batteries in your pocket or another warm place to heat them and then load them into the camera just before you take a picture. Wipe the battery terminals with a clean, dry cloth. Load new or fully charged batteries. Use the rechargeable battery discharging function to restore the rechargeable batteries to full capacity.
No photograph is taken when pressing the shutter button.	<ul style="list-style-type: none"> No media is inserted. The media is full. The media is not formatted. The xD-Picture Card contact area is soiled. The media is damaged. The batteries have run out. 	<ul style="list-style-type: none"> Insert a media. Insert a new media or erase some unwanted frames. Format the media on the camera. Wipe the xD-Picture Card contact area with a clean, dry cloth. Insert a new media. Load new or fully charged batteries.
Focusing is slow.	The external AF sensor is dirty.	Use a blower brush to brush away any dust and then gently wipe the sensor with a soft, dry cloth.
Cannot set the camera to Macro (close-up) mode.	Photography mode is set to "☉", "▲" or "☾".	Change the Photography mode to "AUTO", "☼", "☽", "P", "S", "A" or "M".
Cannot select continuous shooting.	Multiple exposure mode is selected.	Set multiple exposure mode to "OFF".
Cannot set exposure compensation.	The Mode dial is set to "AUTO", "☼", "☽", "☉", "▲", "☾" or "M".	Change the Photography mode.
Cannot use the flash.	<ul style="list-style-type: none"> The shutter button was pressed while the flash was charging. The flash is not popped up. The batteries have run out. The camera is set to "☽" or "▲" in Photography mode. Continuous shooting is selected. Super macro mode is selected. 	<ul style="list-style-type: none"> Wait until the charging is completed before pressing the shutter button. Pop up the flash. Load new or fully charged batteries. Change the Photography mode. Set continuous shooting to "OFF". Cancel Super macro mode.
The flash settings are restricted and cannot be selected.	The Photography mode is set to "AUTO", "☼", "☽", "▲", "☾", "S", "A" or "M".	The flash settings are restricted because the camera settings are tailored to the scene being shot. Change the Photography mode for a wider range of flash settings.
The playback image is dark even though the flash was used.	<ul style="list-style-type: none"> The subject is too far away. Your finger was covering the flash. 	<ul style="list-style-type: none"> Move to within the effective flash range before taking the picture. Hold the camera correctly.
The image is blurred.	<ul style="list-style-type: none"> The lens is dirty. You photographed scenery with Macro mode selected. You took a close-up shot without selecting Macro mode. You are shooting a subject that is not suited to autofocusing. 	<ul style="list-style-type: none"> Clean the lens. Cancel Macro mode. Select Macro mode. Use AF/AE lock or "MF" Manual focus mode to take the picture.
There is speckling on the image.	The picture was taken with a slow shutter speed (long exposure) in a high-temperature environment.	This is a characteristic of CCDs and does not indicate a camera fault.

Troubleshooting	Possible causes	Solutions
The camera does not emit any sound.	<ul style="list-style-type: none"> The camera volume is set too low. The microphone was blocked during shooting/recording. There is something covering the speaker during playback. 	<ul style="list-style-type: none"> Adjust the volume. Take care not to block the microphone during shooting/recording. Make sure that the speaker is uncovered.
Frame erase does not erase the frame.	Some frames may be protected.	Unprotect frames using the camera on which the protection was first applied.
The ERASE ALL function does not erase all the frames.		
Screens are not displayed in English.	A language other than English is selected in the "☼ 言語/LANG. setting in the "☼ SET-UP menu (▶P.100).	<ol style="list-style-type: none"> Press the "MENU/OK" button to display the menu. Press "▲" or "▼" to select "☼ SET-UP and press "▶". Press "▲" or "▼" to select "☼ 言語/LANG.. Press "▶". Press "▲" or "▼" several times to select "ENGLISH". Press the "MENU/OK" button.
There is no image or sound on the TV.	<ul style="list-style-type: none"> The included A/V cable was connected during movie playback. The camera is not connected to the TV correctly. "TV" is selected as the TV input. The "☼" video output setting is incorrect. The TV volume is turned down. 	<ul style="list-style-type: none"> After the movie playback mode is stopped, connect the camera and TV correctly. Connect the camera and TV correctly. Set the TV input to "VIDEO". Change the setting to "NTSC" or "PAL" (▶P.100). Adjust the volume.
The TV image is black and white.	The "☼" video output setting is incorrect.	Change the setting to "NTSC" or "PAL" (▶P.100).
When connecting the camera to a PC, the photographed image or playback image appears on the camera's screen.	<ul style="list-style-type: none"> The USB cable (mini-B) is not correctly connected to the PC or camera. The PC is not turned on. 	<ul style="list-style-type: none"> Set up the camera, and connect the USB cable (mini-B) correctly. Turn the PC on.
Nothing happens when using the Mode dial.	<ul style="list-style-type: none"> Camera malfunction. The batteries have run out. 	<ul style="list-style-type: none"> Briefly remove the batteries or disconnect the AC power adapter. Then reload the batteries or reconnect the AC power adapter and try again. Load new or fully charged batteries.
The camera no longer works correctly.	The camera has suffered an unforeseen problem.	Briefly remove the batteries or disconnect the AC power adapter. Then reload the batteries or reconnect the AC power adapter and try again. If you think the camera is faulty, contact your FUJIFILM dealer.
Cannot print with PictBridge.	"☼ PICTBRIDGE is not selected in "☼ USB mode in the "☼ SET-UP menu.	Select "☼ PICTBRIDGE in "☼ USB mode in the "☼ SET-UP menu.
The camera was connected to a PC when the USB mode was set to "☼".		<p>Perform steps ① to ③ to remove the camera from the PC.</p> <p>● Windows</p> <ol style="list-style-type: none"> The "New Hardware Found" wizard or "Scanner and Camera" wizard appears. If the wizard does not appear, proceed to step ③. Click the [Cancel] button. Disconnect the camera from the PC. <p>● Macintosh</p> <ol style="list-style-type: none"> The window for locating the driver appears. If the window does not appear, proceed to step ③. Click the [Cancel] button. Disconnect the camera from the Macintosh.

Specifications

System	
Model	Digital camera FinePix S9000 / FinePix S9500
Effective pixels	9.0 million pixels
CCD	1/1.6-inch Super CCD HR Number of total pixels: 9.24 million pixels
Storage media	xD-Picture Card (16/32/64/128/256/512 MB/1 GB) CF card and Microdrive™ (Compatibility is listed on Fujifilm website: http://home.fujifilm.com/products/digital/)
File format	Still image: DCF-compliant Compressed: Exif ver.2.2 JPEG, DPOF-compatible Uncompressed: CCD-RAW (RAF) * Design rule for Camera File System compliant DPOF compatible Movie: AVI format, Motion JPEG Audio: WAVE format, Monaural sound
Number of recorded pixels	Still image: 3488 × 2616 pixels/3696 × 2464 pixels/2592 × 1944 pixels/2048 × 1536 pixels/1600 × 1200 pixels/640 × 480 pixels (9M /3.2/ 5M / 3M / 2M / 0.5M)
File size	See the table on P.136.
Lens	Fujinon 10.7× optical zoom lens F2.8-F4.9
Focal length	f=6.2 mm-66.7 mm (Equivalent to approx. 28 mm-300 mm on a 35 mm camera)
Digital zoom	Approx. 2× (10.7× optical zoom lens is used together: Max. zoom scale: 21.4×)
Aperture (Wide-angle)	F2.8 to F11 Up to 13 steps in 1/3 EV increments Manual/Auto selectable
Focal range	Normal: Wide-angle: approx. 50 cm (1.6 ft.) to infinity (In High-speed shooting mode: approx. 2 m (6.6 ft.) to infinity) Telephoto: approx. 2 m (6.6 ft.) to infinity (In High-speed shooting mode: approx. 4 m (13.1 ft.) to infinity) Macro: Wide-angle: approx. 10 cm (3.9 in.) to 3 m (9.8 ft.) Telephoto: approx. 90 cm (3.0 ft.) to 3 m (9.8 ft.) Super macro: approx. 1 cm to 1 m (0.4 in. to 3.3 ft.) (Wide-angle only)
Sensitivity	AUTO/Equivalent to ISO 80/100/200/400/800/1600
Photometry	TTL 256-zones metering Multi, Spot, Average
Exposure control	Program AE (AUTO , M , N , P , A , S , A), Shutter-priority AE, Aperture-priority AE, Manual exposure
Scene position	M (Anti-blur), N (Natural light), P (Portrait), A (Landscape), S (Night)
Exposure compensation	-2 EV to +2 EV in 1/3 EV-step increments (P, S, A)
Shutter speed	AUTO , M , N , P , A : 1/4 sec. to 1/4000 sec. S : 4 sec. to 1/500 sec. P/S/A: 4 sec. to 1/4000 sec. M: 30 sec. to 1/4000 sec. Bulb (Up to 30 sec.)
Continuous shooting	Top 4-frame: Number of recorded frames: up to 4 frames (Max. 1.5 frames/sec.) Final 4-frame: Number of recorded frames: last 4 frames before releasing the shutter button (Max. 1.5 frames/sec.) Long-period continuous shooting mode: Number of recorded frames: up to 40 frames. (Max. 1.1 frames/sec.)
Auto bracketing	± 1/3 EV, ± 2/3 EV, ± 1 EV
Focus	Mode: Auto focus, Continuous AF, Manual focus AF system: TTL contrast-type AF frame selection: AF (CENTER), AF (MULTI), AF (AREA)

System	
White balance	Automatic scene recognition/Preset (Fine, Shade, Fluorescent (Daylight), Fluorescent (Warm White), Fluorescent (Cool White), Incandescent/Custom white balance (2 types))
Self-timer	Approx. 10 sec./2 sec.
Flash type	Auto flash Effective range (ISO : AUTO): Wide-angle: approx. 30 cm-5.6 m (1.0 ft.-18.4 ft.) Telephoto: approx. 60 cm-3 m (2.0 ft.-9.8 ft.)
Flash mode	Auto, Red-Eye Reduction, Forced Flash, Suppressed Flash, Slow Synchro, Red-Eye Reduction + Slow Synchro
Viewfinder	0.44 inches, 235,000 pixels, LCD viewfinder Approx. 100% coverage
LCD monitor	1.8 inches, Aspect ratio: 4:3; approx. 118,000 pixels low-temperature polysilicon TFT, Approx. 100% coverage
Movie	640 × 480 pixels/320 × 240 pixels (640i / 320i) (30 frames per second with monaural sound) A series of continuous image can be recorded up to available recording time per media.
Photography functions	High-speed shooting, Best framing, Post shot assist window, Frame No. memory
Playback functions	Trimming, Image rotate, Automatic playback, Multi-frame playback, Sorting by date, Voice memo
Other functions	PictBridge, Exif print, Language (English, Francais, Deutsch, Español, Italiano, 中文, 한글), Time difference, FinePix photo mode (F -mode)

Input/Output Terminal	
A/V OUT (Audio/Visual output)	NTSC/PAL-type (with monaural sound)
Digital input/output	USB2.0 High-Speed
DC input socket	AC Power Adapter AC-5VX (sold separately)
Accessory shoe	Hot shoe
Synchronizing terminal	Equipped with ISO 519 synchronizing terminal as standard, lock screw provided

Specifications

Power Supply and Others

Power supply

Use one of the following:

- 4× AA-size alkaline batteries
- 4× AA-size Ni-MH (Nickel-Metal Hydride) batteries (sold separately)
- AC Power Adapter AC-5VX (sold separately)

Guide to the number of available frames for battery operation

Media	Battery Type	
	Alkaline batteries	Ni-MH batteries 2500 mAh
xD-Picture Card	Approx. 140 frames	Approx. 340 frames
Microdrive	Approx. 100 frames	Approx. 320 frames

According to the CIPA (Camera & Imaging Products Association) standard procedure for measuring digital still camera battery consumption (extract):

When using alkaline batteries, use the batteries supplied with the camera. You can use Ni-MH batteries also. The storage media should be **xD-Picture Card** or Microdrive. Pictures should be taken at a temperature of +23°C (+73°F), with the LCD monitor turned on, AF-assist illuminator off, the optical zoom moved from full wide-angle to full telephoto (or vice-versa) and back again to its original position every 30 seconds, the flash used at full power every second shot and the camera turned off and then on again once every 10 shots.

- Note: Because the number of available shots varies depending on the capacity of alkaline batteries or the level of charge in Ni-MH batteries, the figures shown here for the number of available shots using batteries are not guaranteed. The number of available shots will also decline at low temperatures.

Camera dimensions (W/H/D)

128.0 mm × 93.0 mm × 129.0 mm/5.0 in. × 3.7 in. × 5.1 in.
(not including accessories and attachments)

Camera mass (weight)

Approx. 645 g/22.8 oz.
(not including accessories, batteries and **xD-Picture Card** or CF/Microdrive)

Weight for photography

Approx. 755 g/26.6 oz. (including batteries and **xD-Picture Card**)

Operating conditions

Temperature: 0°C to +40°C (+32°F to +104°F)
80% humidity or less (no condensation)

■ Standard number of available frames/recording time per media

The number of available frames, recording time or file size varies slightly depending on the subjects photographed. Note also that the divergence between standard number of frames and the actual number of frames is greater for medias with higher capacities. When used media is 4GB or more, a movie up to 60 minutes long (at the "640" setting) or 120 minutes long (at the "320" setting) can be recorded.

Visit website for information on available Microdrive / CompactFlash card: <http://home.fujifilm.com/products/digital/>

Quality setting	9M F	9M N	3:2	5M	3M	2M	03M	RAW	640 (30 fps)	320 (30 fps)
Number of recorded pixels	3488 × 2616	3696 × 2464	2592 × 1944	2048 × 1536	1600 × 1200	640 × 480	—	640 × 480	320 × 240	
Image data size	4.5 MB	2.2 MB	2.2 MB	1.2 MB	780 KB	630 KB	130 KB	18.8 MB	—	—
DPC-16 (16 MB)	3	6	6	12	19	25	122	0	13 sec.	26 sec.
DPC-32 (32 MB)	6	13	13	25	40	50	247	1	27 sec.	54 sec.
DPC-64 (64 MB)	13	28	28	50	81	101	497	3	55 sec.	109 sec.
DPC-128 (128 MB)	28	56	56	102	162	204	997	6	111 sec.	219 sec.
DPC-256 (256 MB)	56	113	113	204	325	409	1997	13	223 sec.	7.3 min.
DPC-512/M512 (512 MB)	113	227	227	409	651	818	3993	27	7.4 min.	14.6 min.
DPC-M1GB (1 GB)	228	456	456	819	1305	1639	7995	54	14.9 min.	29.3 min.
Microdrive 340 MB	77	155	155	279	445	559	2729	18	5.1 min.	10.0 min.
Microdrive 1 GB	234	469	469	842	1313	1642	8212	55	15.3 min.	30.1 min.

* These specifications are subject to change without notice. FUJIFILM shall not be held liable for damages resulting from errors in this Owner's Manual.

* The LCD monitor on your digital camera is manufactured using advanced high-precision technology. Even so, small bright points and anomalous colors (particularly around text) may appear on the monitor. These are normal display characteristics and do not indicate a fault with the monitor. This phenomenon will not appear on the recorded image.

* The operation error may be caused in a digital camera by the strong radio interference (i. e. electric fields, static electricity, line noise, etc.).

* Due to the nature of the lens, the edges of images may appear distorted. This is normal.

Explanation of Terms

Deactivated batteries

Leaving an Ni-MH battery unused in storage for a long period may cause a rise in the level of substances that inhibit current flow inside the battery and result in a dormant battery. A battery in this state is referred to as deactivated.

Because current flow is inhibited in a deactivated Ni-MH battery, the battery's original level of performance cannot be achieved.

EV

A number denotes Exposure Value. The EV is determined by the brightness of the subject and sensitivity (speed) of the film or CCD. The number is larger for bright subjects and smaller for dark subjects. As the brightness of the subject changes, a digital camera maintains the amount of light hitting the CCD at a constant level by adjusting the aperture and shutter speed.

When the amount of light striking the CCD doubles, the EV increases by 1. Likewise, when the light is halved, the EV decreases by 1.

Frame rate (fps)

The frame rate refers to the number of images (frames) that are photographed or played back per second. For example, when 10 frames are continuously photographed in a 1-second interval, the frame rate is expressed as 10 fps.

For reference, TV images are displayed at 30 fps (NTSC).

JPEG

Joint Photographic Experts Group

A file format used for compressing and saving color images. The higher the compression rate, the greater the loss of quality in the decompressed (restored) image.

Memory effect

If an Ni-MH battery is repeatedly charged without first being fully discharged, its performance may drop below its original level. This is referred to as the "memory effect".

Motion JPEG

A type of AVI (Audio Video Interleave) file format that handles images and sound as a single file. Images in the file are recorded in JPEG format. Motion JPEG can be played back by QuickTime 3.0 or later.

Smear

A phenomenon specific to CCDs whereby white streaks appear on the image when there is a very strong light source, such as the sun or reflected sunlight, in the photography screen.

WAVE

A standard format used on Windows systems for saving audio data. WAVE files have the ".WAV" file extension and the data can be saved in either compressed or uncompressed format. Uncompressed recording is used on this camera.

WAVE files can be played back on a personal computer using the following software:

Windows: MediaPlayer

Macintosh: QuickTime Player

* QuickTime 3.0 or later

White Balance

Whatever the kind of the light, the human eye adapts to it so that a white object still looks white. On the other hand, devices such as digital cameras see a white subject as white by first adjusting the color balance to suit the color of the ambient light around the subject. This adjustment is called matching the white balance.



Exif Print Format is a newly revised digital camera file format that contains a variety of shooting information for optimal printing.

FUJIFILM Digital Camera Worldwide Network

If you have technical questions or if you need repair service, ask the following local distributor. Please present a warranty card and a purchase receipt when you ask for repair. Refer to the warranty card for detail of warranty conditions. There is a case that repair and Technical support cannot be accepted for some models which your local distributor does not deal with. These lists are subject to change without notice.

NORTH AMERICA

Canada	Fuji Photo Film Canada Inc. Technical support 600 Suffolk Court Mississauga Ontario, L5R 4G4 TEL 1-866-818-FUJI (3854) http://www.fujihelp.ca Repair service 600 Suffolk Court Mississauga Ontario, L5R 4G4 TEL 1-800-263-5018 FAX 1-905-755-2993 http://www.fujihelp.ca
U.S.A.	Fuji Photo Film USA Technical support 1100 King George Post Rd., Edison, NJ 08837 TEL 800-800-3854 FAX 732-857-3487 digitalinfo@fujifilm.com Repair service 1100 King George Post Rd., Edison, NJ 08837 TEL 732-857-3000 FAX 732-857-3471 njcamerarepair@fujifilm.com
Hawaii	Fuji Photo Film Hawaii, Inc. Technical support & Repair service 94-468 Akoki Street, Waipahu, HI. 96797 TEL 1-808-677-3854, ext. 209 FAX 1-808-677-1443 kurt.kmett@fujifilmhawaii.com

CENTRAL & SOUTH AMERICA

Argentina	Imagen e informacion S.A. Technical support & Repair service Fondo de la Legua 936 San Isidro Pcia. de Buenos Aires TEL +54-11-4836-1000 FAX +54-11-4836-1144 servtec@imagineinformacion.com.ar
Bolivia	Reifschneider Bolivia Ltda. Technical support & Repair service Calle H.N.° 5 - Equipetrol Norte - Santa Cruz TEL +591 33 44 1129 FAX +591 33 45 2919 gciagral@bibosi.scz.entelnet.bo
Brazil	Fuji Photo Film do Brasil Ltda. Technical support & Repair service Av. Vereador José Diniz, 3400 - Campo Belo, São Paulo/SP TEL 0800-12-8600 FAX +55 11 5091-4150 camarasdigitais@fujifilm.com.br
Chile	Reifschneider SA Technical support & Repair service Av. El Conquistador del Monte 5024, Huechuraba, Santiago, Chile TEL 02-4431500 FAX 02-4431596 cecilialcalvo@reifschneider.cl
Colombia	Animex de Colombia Ltda. Technical support & Repair service Calle 44 N.° 13-43 Piso 2 Apartado 18001 - Bogotá TEL +57 1 338-0299 FAX +57 1 288-2208 animex@etb.net.co
Ecuador	Espacri Cia Ltda Technical support & Repair service Bolivar 5-69 y Hermano Miguel TEL 593-72-835526 FAX 593-72-833157
Ecuador	Importaciones Espacri Cia. Ltda. Technical support & Repair service Simón Bolívar 5-69 y Hno. Miguel - Cuenca TEL +593 783 5526 FAX +593 783 3157 portiz@fujifilm.com.ec
Mexico	Fujifilm de Mexico, S.A. de C.V. Technical support Av. Ejercito Nacional 351, Col. Granada 11520 Mexico, D.F. TEL (52-55) 5263-5566 / 68 FAX (52-55) 5254-1508 jlgraud1@fujifilm.com.mx Repair service Av. Presidente Juarez 2007, Col. Tepetlaco, 54090 Tlalnepantla, Edo. de Mexico TEL (52-55) 5263-5500 FAX (52-55) 5254-1508 jlgraud1@fujifilm.com.mx
Paraguay	Errece S.R.L. Technical support & Repair service Edificio Unitas 15 de Agosto 1035, Asunción TEL +595 21 444256 FAX +595 21 444651 jmarbulo@fujifilm.com.py
Peru	Procesos de Color S.A. Technical support & Repair service Pablo Bermudez 111 Apartado 3794 - Esq. Arequipa - Lima 11 TEL +51 14 33 5563 FAX +51 14 33 7177 jalvarado@fujifilm.com.pe
Uruguay	Fotocamara S.R.L. Technical support & Repair service Cuareim 1439, montevideo, Uruguay TEL +598-2-9002004 FAX +598-2-9008430 fotocam@adinet.com.uy
Uruguay	Kiel S.A. Technical support & Repair service Maldonado 1787 Montevideo- Uruguay TEL (05982) 419 4542 FAX (05982) 412 0046 kiel@fujifilm.com.uy
Venezuela	C. Hellmund & Cia Sa Technical support & Repair service Av. Ppal Diego Cisneros Caracas Venezuela Edf Oficentro TEL 0212-2022300 FAX 0212-2399796 hellmund@hellmund.com

EUROPE

Austria	Fuji Film Oesterreich Technical support & Repair service Traviatgasse/Pfarrgasse, 1230 Vienna, Austria TEL 0043 1 6162606/51 or 52 FAX 0043 1 6162606/58 kamera.service@fujifilm.at
Belgium	Belgian Fuji Agency Technical support & Repair service 20, Avenue Lavoisier, Wavre, 1300, Belgium TEL 3210242090 FAX 3210238562 info@fuji.be

Croatia	I&I d.o.o. Technical support Hondlova 2, Zagreb, Croatia TEL 38512319060 FAX 2310240 dsaravanja@fujifilm.hr Repair service Hondlova 2, Zagreb, Croatia TEL 38512316228 FAX 2310240 info@fujifilm.hr
Cyprus	PMS IMAGING LTD Technical support & Repair service 11, Dighenis Akritas Avenue, P.O.BOX 22315, 1586 Nicosia TEL 35722746746 FAX 35722438209 mariosashiotis@fujifilm.com.cy
Cyprus	Doros Neophytou CAMERA REPAIRS Technical support & Repair service 28B, Agiou Demetriou, Acropoli, Nicosia TEL 35722314719 FAX 35722515562 dorosn@logosnet.cy.net
Czech Republic	Fujifilm Cz., s.r.o. Technical support U nakladoveho nadrazi 2/1949, 130 00 Praha 3 TEL 00420 234 703 411 FAX 00420 234 703 489 fricman@fujifilm.cz
Czech Republic	AWH servis Repair service Milesovska 1, 130 00 Praha 3, Czech republic TEL 00420 222 721 525 FAX 00420 222 720 122 awh@awh.cz
Denmark	Fujifilm Denmark A/S Technical support & Repair service Stubbeled 2, 2950 Vedbæk Denmark TEL 0045 45662244 FAX 0045 45662214 fujifilm@fujifilm.dk
Finland	Fuji Finland Oy Technical support & Repair service Martinkyläntie 41, 01720 Vantaa, Finland TEL +358 9 825951 FAX +358 9 870 3818 fuji@fuji.fi
France	FUJIFILM France Technical support & Repair service 2, Avenue Franklin, 78186 Saint-Quentin en Yvelines, France FAX 33 1 01 30 58 58 65 direction.technique@fujifilm.fr
Germany	Fuji Photo Film (Europe) GmbH Technical support & Repair service Heesenstr. 70, 40549 Düsseldorf International call TEL +49 211 50890 FAX +49 211 5089668 service@fujifilm.de National call* TEL 0180 5898980 FAX 0180 5898982 * 12 Cent/Min aus dem deutschen Festnetz
Greece	FUJIFILM HELLAS S.A. Technical support & Repair service 1, Ithous & Ag. Anargiron str., 175 64 P.Phaliro, Athens, Greece TEL 0030 210 9404100 FAX 0030 210 9404397 fujifilm@fujifilm.gr
Hungary	Fujifilm Hungary Ltd. Technical support Vaci ut 19, Budapest, 1134, Hungary TEL 3612389410 FAX 3612389401 fujifilm@fujifilm.hu
Iceland	Icephto (Ljosmyndavörur) Technical support & Repair service Skipholt 31, 105 Reykjavik, Iceland TEL 354 568 0450 FAX 354 568 0455 framkollun@fujifilm.is
Italy	Fujifilm Italia S.p.A. Technical support Via Dell'Unione Europea, 4 - 20097 San Donato Milanese (MI), Italy TEL 039-02895821 FAX 039-0289582912 info@fujifilm.it Repair service Fujifilm On Line - Call center TEL 039-026695272 info@fujifilm.it
Lithuania	Fujifilm Lithuania Technical support & Repair service Gerosios Vilties str. 38, LT-03143 Vilnius, Lithuania TEL 370-5-2130121 FAX 3705-5-2134066 info@fujifilm.lt
Malta	Ciancio (1913) Co.Ltd. Technical support & Repair service Fuji Tech Centre, Ciancio House, Cannon Road, Qormi, QRM05 TEL 0356-21-480500 FAX 0356-21-488328 info@fujifilm.com.mt
Netherlands	Fujifilm Nederland BV Technical support Hoogstraat 39, 3011 PE, Rotterdam, The Netherlands TEL 010-2812345 FAX 010-2812334 fuji@fujifilm.nl Repair service Hoevenseweg 43, 4877 LA, Etten-Leur, The Netherlands TEL 010-2812345 FAX 076-7502641 reparatie@fujifilm.nl
Norway	Fujifilm Norge AS Technical support Lilleakerveien 10, 0283 Oslo, Norway TEL 0047-22736000 FAX 0047-22736020 www.fujifilm.no/mailto:post@fujifilm.no Repair service Llaveien 1, 5132 Nyborg, Norway TEL 0047-55393880 FAX 0047-55195201 www.camera.no/mailto:service@camera.no
Poland	Fujifilm Polska Distribution Sp. z o.o. Technical support Poland Al. Jerozolimskie 178; 02-486 Warszawa TEL +48-22-517-66-00 FAX +48-22-517-66-02 fujifilm@fujifilm.pl Repair service Poland, Muszkietierow 15, 02-273 Warszawa TEL +48-22-886-94-40 FAX +48-22-886-94-42 serwis@fujifilm.pl
Portugal	Fujifilm Portugal, Lda Technical support Av. Fontes Pereira de Melo, 342, 4100-259 Porto, Portugal TEL (351) 226194200 FAX (351) 226194213 finpix@fujifilm.pt Repair service Av. Fontes Pereira de Melo, 342, 4100-259 Porto, Portugal TEL (351) 226194200 FAX (351) 225194662 cameras@fujifilm.pt

FUJIFILM Digital Camera Worldwide Network

Romania	CTS-Cardinal Top Systems Ltd Technical support & Repair service 112, Calea Dorobanti street, 4 flat, 1sector, Bucharest, Romania TEL 4021-230-09-82 FAX 4021-230-09-82 cts_tirla@hotmail.com
Russia	ZAO "Fujifilm RU" Technical support Bld. 1, 10, Rozanova str., Moscow, 123007, Russia TEL +7-095-956-9858 FAX +7-095-230-6217 info@fujifilm.ru Repair service 18, Shelepikhinskaya Naberezhnaya str., Moscow, 123290, Russia TEL +7-095-797-3434 FAX +7-095-797-3434
Slovakia	Fujifilm Slovakia Technical support Pribylinska 2, 831 04 Bratislava, Slovakia TEL 00421 2 44 888 077 FAX 00421 2 44 889 300 fujifilm@fujifilm.sk Repair service FIS Tatracentrum, Hodzovo nam. 4 - Tatracentrum, 811 06 Bratislava, Slovakia TEL 00421 2 54 647 347 fis.tatracentrum@stonline.sk
Spain	Fujifilm España S.A. Technical support Aragón 180, 08011 Barcelona (España) TEL 902012535 FAX 934515900 / 933230330 info@fujifilm.es Repair service Aragón 180, 08011 Barcelona (España) TEL 934511515 FAX 934515900 / 933230330 tallersat@fujifilm.es
Sweden	Fujifilm Sverige AB Technical support Sveavägen 167 104 35 Stockholm TEL 46 8 506 141 70 FAX 46 8 506 142 09 kamera@fujifilm.se Repair service Sveavägen 167 104 35 Stockholm TEL 46 8 506 513 54 FAX 46 8 506513 54 kameraverkstaden@fujifilm.se
Switzerland / Lichtenstein	Fujifilm (Switzerland) AG Technical support & Repair service Niederhaslistrasse 12, 8157 Dietlikon, Switzerland TEL +41 44 855 5154 FAX +41 44 855 5329 RepairCenter@fujifilm.ch
Turkey	Fujifilm Turkiye Sinfo A.S. Technical support Fujifilm Plaza, Dereboyu Cad. 39 34660 Halkali, Istanbul, Turkey TEL +90 212 696 5090 FAX +90 212 696 5009 csarp@fujifilm.com.tr Repair service Fujifilm Plaza, Dereboyu Cad. 39 34660 Halkali, Istanbul, Turkey TEL +90 212 696 5090 FAX +90 212 696 5010 servis@fujifilm.com.tr
U.K.	Fuji Photo Film (UK) Ltd. Technical support St Martins Way St Martins Business Centre Bedford MK42 0LF TEL +44 (0)123 424 5383 FAX +44 (0)123 424 5285 fujitec@fuji.co.uk Repair service St Martins Way St Martins Business Centre Bedford MK42 0LF TEL +44 (0)123 421 8388 FAX +44 (0)123 424 5285 fujitec@fuji.co.uk
Ukraine	Image Ukraine CJSC Technical support & Repair service 12, Kontraktova ploshcha, Kyiv 04070, Ukraine TEL +380-44-4909075 FAX +380-44-4909076 d@fujifilm.ua
MIDDLE EAST	
Iran	Tehran Fuka Co. Technical support & Repair service 229,"Fuji" Bldg., Mirdamad Blvd., Tehran 19189, Iran TEL (+98-21)2254810-19 FAX (+98-21)2221002 fuka@neda.net
Israel	Shimone Group Ltd. Technical support Efal 33 keyriat Arie Petah Tikva 49130, Israel TEL (+) 972 3 9250666 digital@fujifilm.co.il Repair service Efal 33 keyriat Arie Petah Tikva 49130, Israel TEL (+) 972 3 9250666 FAX 972 3 9250699 khaim@shimone.com
Jordan	Grand Stores Technical support & Repair service Al- Abdali, Amman / Jordan TEL 009626-4646387 FAX 009626-4647542 gstores@go.com.jo
Qatar	Techno Blue Technical support Blue Salon Bldg, 3rd Floor, Suhaim bin Hamad st, Al- Saad, Doha TEL 00974 44 66 175 FAX 00974 44 79 053 prabu@techno-blue.com
Saudi Arabia	Emam Distribution Co. Ltd. Technical support P.O. Box 1716, Jeddah 21441, Saudi Arabia TEL 96626978756 FAX 96626917036 service@fujifilm.com.sa
Syria	Film Trading Company Technical support Al-Shahbandar P.O. Box:31180 Damascus SYRIA TEL + 963 11 2218049 FAX + 963 11 44673456 f.t.c@Net.SY Repair service Al-cheikh Taha P.O. Box: 6171 Aleppo SYRIA TEL + 963 21 4641903 FAX + 963 21 4641907 filmtradin@Net.SY
U.A.E.	Grand Stores Technical support & Repair service P. O. Box 2144, Saleh Bin Lahej Building, Al Garhoud, Deira, Dubai TEL + 971 4-2823700 FAX + 971 4-2828382 photography@grandstores.ae
Yemen	Al-Haidary Trading Technical support P.O.Box-2942 Haddah St. HTC, Sana'a, Yemen TEL 00967-1-503980 FAX 00967-1-503983 Repair service P.O.Box-2942 Haddah St. HTC, Sana'a, Yemen TEL 00967-1-503977 FAX 00967-1-503983

AFRICA

Egypt	Foto Express Egypt Technical support & Repair service 426 Pyramids St., Giza, Egypt TEL (202) 7762062 FAX (202) 7760169 fotoegypt@access.com.eg
Kenya	Fuji Kenya Ltd Repair service P.O.Box 41669-00100, Fuji Plaza, Chiromo Road, Nairobi, Kenya. TEL (254-20)4446265-8 FAX (254-20)4448515 / 7 info@fujifilm.co.ke

OCEANIA

Australia	FUJIFILM Australia Pty Ltd Technical support 114 Old Pittwater Road, Brookvale, NSW, 2100, Australia TEL 1800 226 355 FAX +61 (2) 9938 1975 digital@fujifilm.com.au Repair service 114 Joynton Avenue, Zetland, NSW, 2017, Australia TEL 1800 226 355 FAX +61 (2) 9938 1975 digital@fujifilm.com.au
Fiji	Brijlal & Co. Ltd Technical support & Repair service 70-72 Cumming Street, Suva, Fiji TEL (679)3304133 FAX (679)3302777 kapadia@connect.com.fj
New Caledonia	Phocidis SARL Technical support & Repair service 58, rue Higginson - B.P.661 - 98845 TEL (00 687) 25-46-35 FAX (00 687) 28-66-70 phocidis@phocidis.nc
New Zealand	Fujifilm NZ Ltd Technical support & Repair service Cnr William Pickering & Bush Road Albany, Auckland TEL +64-9-4140400 FAX +64-9-4140410 glenn.beaumont@fujifilm.co.nz
Papua New Guinea	Oceania PNG Limited Technical support Section 15, Allotment 1, Reke St, Boroko NCD, PNG. Mail: PO Box 2167, Boroko NCD, PNG. TEL +675 3256411 FAX +675 3250311 oceania@daltron.com.pg

ASIA

Hong Kong	Fuji Photo Products Co., Ltd. Technical support & Repair service 8/F., TSUEN WAN IND. CENTRE, 220 TEXACO RD., TSUEN WAN, HONG KONG TEL (852)2406 3287 FAX (852)2408 3130 rsd@chinahkphoto.com.hk
Indonesia	PT Modern Photo Tbk Technical support & Repair service Jl.Matraman Raya 12, Jakarta Timur 13150 TEL +62 021 2801000 FAX +62 021 8581620+62 021 2801012 kmr-srv@moderndgroup.co.id
Malaysia	Fuji Photo Film (Malaysia) Sdn. Bhd. Technical support Letter Box 1, Level 10, 11 & 12, Menara Axis, No 2, Jalan 51A/223, 46100 Petaling Jaya, Selangor Darul Ehsan, Malaysia TEL 603-79584700 FAX 603-79584110 digital@fujifilm.com.my Repair service Letter Box 1, Level 10, 11 & 12, Menara Axis, No 2, Jalan 51A/223, 46100 Petaling Jaya, Selangor Darul Ehsan, Malaysia TEL 603-79584700 FAX 603-79584110 technical@fujifilm.com.my
Philippines	YKL Development & Trdg. Corp. Technical support 24 Sto. Domingo St., Quezon City 1100, Philippines TEL 632-7436601-06 FAX 632-7324661 digital@yklcolor.com Repair service 24 Sto. Domingo St., Quezon City 1100, Philippines TEL 632-7436601-06 FAX 632-7324661 tech_services@yklcolor.com
Singapore	Fuji Photo Film Singapore Pte Ltd Technical support & Repair service 10 New Industrial Road Fujifilm Building Singapore 536201 TEL 65-6380 5557 FAX 65-6281 3594 service@fujifilm.com.sg
South Korea	Korea Fujifilm Co., Ltd. Technical support 30-1, Mukjeung-dong, Jung-gu, Seoul, Korea TEL +82-2-3282-7363 FAX +82-2-2269-7435 photo@fujifilm.co.kr
South Korea	Yonsan AS Center (Fujidigital) Repair service #301, 3F, Jeonjaland, 16-9, Hangangro3-ga, Yongsan-gu, Seoul, Korea TEL +82-2-701-1472 FAX +82-2-718-1331 1bowl@hanmail.net
South Korea	Kangnam AS Center (Digitalgallery) Repair service 2F, Hyeongin Tower, 23-2, Bangyi-dong, Songpa-gu, Seoul, Korea TEL +82-2-2203-1472 FAX +82-2-418-5572 nurijiji@hanmail.net
South Korea	Busan AS Center (Digital-Sewon) Repair service 241-4, Bujeon-dong, Busanjin-gu, Busan, Korea TEL +82-51-806-1472 FAX +82-51-817-0083 merahan@yahoo.co.kr
Taiwan	Hung Chong Corp. Technical support & Repair service No. 38, Min-Chuan E. Rd. Sec. 6, Taipei (114), Taiwan, R.O.C. TEL 886-2-6602-8988 FAX 886-2-2791-8647 dah@mail.hungchong.com.tw
Thailand	Fuji Photo Film (Thailand) Ltd. Technical support 388 SP Building, 8th Floor, Phayathai, Bangkok 10400 TEL +662-2730029 ext. 755 FAX +662-2730239 supaleark@fujifilm.co.th Repair service 388 SP Building, 8th Floor, Phayathai, Bangkok 10400 TEL +662-2730029 ext.761,762 FAX +662-2730239 warin@fujifilm.co.th

Safety Notes

- Make sure that you use your FinePix S9000 / FinePix S9500 camera correctly. Read these Safety Notes and your Owner's Manual carefully before use.
- After reading these Safety Notes, store them in a safe place.

About the Icons

The icons shown below are used in this document to indicate the severity of the injury or damage that can result if the information indicated by the icon is ignored and the product is used incorrectly as a result.

	WARNING This icon indicates that death or serious injury can result if the information is ignored.
	CAUTION This icon indicates that personal injury or material damage can result if the information is ignored.

The icons shown below are used to indicate the nature of the information which is to be observed.

- Triangular icons tell you that this information requires attention ("important").
- Circular icons with a diagonal bar tell you that the action indicated is prohibited ("Prohibited").
- Filled circles with an exclamation mark tell you an action that must be performed ("Required").

	WARNING If a problem arises, turn the camera off, remove the batteries, disconnect and unplug the AC power adapter. Continued use of the camera when it is emitting smoke, is emitting any unusual odor, or is in any other abnormal state can cause a fire or electric shock. ● Contact your FUJIFILM dealer.	
	Do not allow water or foreign objects to enter the camera. If water or foreign objects get inside the camera, turn the camera off, remove the batteries and disconnect and unplug the AC power adapter. Continued use of the camera can cause a fire or electric shock. ● Contact your FUJIFILM dealer.	
	Do not use the camera in the bathroom or shower. This can cause a fire or electric shock.	
	Never attempt to change or take apart the camera. (Never open the casing.) Do not use the camera when it has been dropped or the casing is damaged. This can cause a fire or electric shock. ● Contact your FUJIFILM dealer.	
	Do not change, heat or unduly twist or pull the connection cord and do not place heavy objects on the connection cord. These actions could damage the cord and cause a fire or electric shock. ● If the cord is damaged, contact your FUJIFILM dealer.	
	Do not place the camera on an unstable surface. This can cause the camera to fall or tip over and cause injury.	
	Never attempt to take pictures while in motion. Do not use the camera while you are walking or driving a vehicle. This can result in you falling down or being involved in a traffic accident.	
	Do not touch any metal parts of the camera during a thunderstorm. This can cause an electric shock due to induced current from the lightning discharge.	
	Do not use the batteries except as specified. Load the batteries with the ⊕ and ⊖ marks.	

	WARNING Do not heat, change or take apart the batteries. Do not drop or subject the batteries to impacts. Do not attempt to recharge lithium or alkaline batteries. Do not store the batteries with metallic products. Do not use chargers other than the specified model to charge the batteries. Any of these actions can cause the batteries to burst or leak and cause fire or injury as a result.	
	Use only the batteries or AC power adapters specified for use with this camera. Do not use voltages other than the power supply voltage shown. The use of other power sources can cause a fire.	
	If the battery leaks and fluid gets in contact with your eyes, skin or clothing. Flush the affected area with clean water and seek medical attention or call an emergency number right away.	
	Do not use the charger to charge batteries other than those specified here. The charger is designed for Fujifilm HR-AA Ni-MH batteries. Using the charger to charge conventional batteries or other types of rechargeable batteries can cause the battery to leak fluid, overheat or burst.	
	When discarding or storing batteries, cover the battery terminals with insulation tape. ● Contact with other metallic objects or batteries could cause the batteries to ignite or burst.	
	Keep xD-Picture Cards out of the reach of small children. Because xD-Picture Cards are small, they can be swallowed by children. Be sure to store xD-Picture Cards out of the reach of small children. If a child swallows an xD-Picture Card, seek medical attention or call an emergency number.	

	CAUTION Do not use this camera in locations affected by oil fumes, steam, humidity or dust. This can cause a fire or electric shock.	
	Do not leave this camera in places subject to extremely high temperatures. Do not leave the camera in locations such as a sealed vehicle or in direct sunlight. This can cause a fire.	
	Keep out of the reach of small children. This product could cause injury in the hands of a child.	
	Do not place heavy objects on the camera. This can cause the heavy object to tip over or fall and cause injury.	
	Do not move the camera while the AC power adapter is still connected. Do not pull on the connection cord to disconnect the AC power adapter. This can damage the power cord or cables and cause a fire or electric shock.	
	Do not use the AC power adapter when the plug is damaged or the plug socket connection is loose. This could cause a fire or electric shock.	
	Do not cover or wrap the camera or the AC power adapter in a cloth or blanket. This can cause heat to build up and distort the casing or cause a fire.	
	When you are cleaning the camera or you do not plan to use the camera for an extended period, remove the batteries and disconnect and unplug the AC power adapter. Failure to do so can cause a fire or electric shock.	
	When charging ends, unplug the charger from the power socket. Leaving the charger plugged into the power socket can cause a fire.	
	Using a flash too close to a person's eyes may temporarily affect the eyesight. Take particular care when photographing infants and young children.	
	When an xD-Picture Card is removed, the card could come out of the slot too quickly. Use your finger to hold it and gently release the card.	
	Request regular internal testing and cleaning for your camera. Build-up of dust in your camera can cause a fire or electric shock. ● Contact your FUJIFILM dealer to request internal cleaning every 2 years. ● Please note this is not a free of charge service.	



FUJI PHOTO FILM CO., LTD.

26-30, Nishiazabu 2-chome, Minato-ku, Tokyo 106-8620, Japan

<http://home.fujifilm.com/products/digital/>

Printed in Japan

Printed on recycled paper.

FPT-507107-FP