

FUJIFILM

BL00004662-200 **EN**

DIGITAL CAMERA

FINEPIX XP80 Series

Owner's Manual

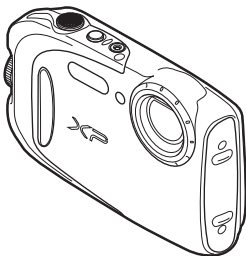

For information on related products, visit our website at
http://www.fujifilm.com/products/digital_cameras/index.html

Before You Begin

First Steps

Basic Photography and Playback

More on Photography

More on Playback

Wireless Networks

Movies

Connections

Menus

Technical Notes

Troubleshooting

Appendix

Exif Print

SDTM
XC

WiFi[®]
CERTIFIED

WIRELESS
SETUP

PictBridge

HDMI[®]
HIGH-DEFINITION MULTIMEDIA INTERFACE

For Your Safety

Be sure to read these notes before use

Safety Notes

- Make sure that you use your camera correctly. Read these safety notes and your *Owner's Manual* carefully before use.
- After reading these safety notes, store them in a safe place.

About the icons

The icons shown below are used in this document to indicate the severity of the injury or damage that can result if the information indicated by the icon is ignored and the product is used incorrectly as a result.



WARNING

This icon indicates that death or serious injury can result if the information is ignored.



CAUTION

This icon indicates that personal injury or material damage can result if the information is ignored.

The icons shown below are used to indicate the nature of the instructions which are to be observed.



Triangular icons tell you that this information requires attention ("Important").



Circular icons with a diagonal bar tell you that the action indicated is prohibited ("Prohibited").



Filled circles with an exclamation mark indicate an action that must be performed ("Required").

Notes for waterproof products

- When not in use, this camera should be stored in a dry location.
- If liquid other than fresh water or sea water is spilled onto the camera, please wipe off with a lint free cloth after rinsing it with fresh water. Please check with your local service centre if unsure.
- Waterproof/dustproof products are excluded from prohibition against water/dust exposure. Keep this in mind when reading following notes and cautions.

WARNING



Unplug from power socket

If a problem arises, turn the camera off, remove the battery, and disconnect and unplug the AC power adapter. Continued use of the camera when it is emitting smoke, is emitting any unusual odor, or is in any other abnormal state can cause a fire or electric shock. Contact your FUJIFILM dealer.



Do not allow water or foreign objects to enter the camera. If water or foreign objects get inside the camera, turn the camera off, remove the battery, and disconnect and unplug the AC power adapter. Continued use of the camera can cause a fire or electric shock. Contact your FUJIFILM dealer.



Do not use in the bathroom or shower

Do not use the camera in the bathroom or shower (excluding waterproof products). This can cause a fire or electric shock.













Do not disassemble









Never attempt to change or take apart the camera (never open the case). Failure to observe this precaution can cause fire or electric shock.

















Do not touch internal parts

Should the case break open as the result of a fall or other accident, do not touch the exposed parts. Failure to observe this precaution could result in electric shock or in injury from touching the damaged parts. Remove the battery immediately, taking care to avoid injury or electric shock, and take the product to the point of purchase for consultation.

 WARNING	
	<u>Do not change, heat or unduly twist or pull the connection cord and do not place heavy objects on the connection cord.</u> These actions could damage the cord and cause a fire or electric shock. If the cord is damaged, contact your FUJIFILM dealer.
	<u>Do not place the camera on an unstable surface.</u> This can cause the camera to fall or tip over and cause injury.
	<u>Never attempt to take pictures while in motion.</u> Do not use the camera while you are walking or driving a vehicle. This can result in you falling down or being involved in a traffic accident.
	<u>Do not touch any metal parts of the camera during a thunderstorm.</u> This can cause an electric shock due to induced current from the lightning discharge.
	<u>Do not use the battery except as specified.</u> Load the battery as shown by the indicator.
	<u>Do not heat, change or take apart the battery. Do not drop or subject the battery to impacts. Do not store the battery with metallic products.</u> Any of these actions can cause the battery to burst or leak and cause fire or injury as a result.
	<u>Use only the battery or AC power adapters specified for use with this camera. Do not use voltages other than the power supply voltage shown.</u> The use of other power sources can cause a fire.
	<u>If the battery leaks and fluid gets in contact with your eyes, skin or clothing, flush the affected area with clean water and seek medical attention or call an emergency number right away.</u>
	<u>Do not use the charger to charge batteries other than those specified here.</u> The supplied battery charger is for use only with the type of battery supplied with the camera. Using the charger to charge conventional batteries or other types of rechargeable batteries can cause the battery to leak fluid, overheat or burst.

 WARNING	
	<u>Danger of explosion if battery is incorrectly replaced. Replace only with the same.</u>
	<u>Do not use in the presence of flammable objects, explosive gases, or dust.</u>
	<u>When carrying the battery, install it in a digital camera or keep it in the hard case. When storing the battery, keep it in the hard case. When discarding, cover the battery terminals with insulation tape.</u> Contact with other metallic objects or batteries could cause the battery to ignite or burst.
	<u>Keep memory cards out of the reach of small children.</u> Because memory cards are small, they can be swallowed by children. Be sure to store memory cards out of the reach of small children. If a child swallows a memory card, seek medical attention or call an emergency number.
	<u>Turn the camera off in crowds.</u> The camera emits radio-frequency radiation that may interfere with pacemakers.
	<u>Turn the camera off in the vicinity of automatic doors, public address systems, and other automatically controlled devices.</u> The camera emits radio-frequency radiation that may cause these devices to malfunction.
	<u>Keep the camera at least 22 cm (0.7 ft.) away from people wearing pacemakers.</u> The camera emits radio-frequency radiation that may interfere with pacemakers.

 CAUTION	
	<u>Do not use this camera in locations affected by oil fumes or steams.</u> This can cause a fire or electric shock.
	<u>Do not use this camera in locations affected by humidity or dust (excluding waterproof products).</u> This can cause a fire or electric shock.
	<u>Do not leave this camera in places subject to extremely high temperatures.</u> Do not leave the camera in locations such as a sealed vehicle or in direct sunlight. This can cause a fire.
	<u>Keep out of the reach of small children.</u> This product could cause injury in the hands of a child.
	<u>Do not place heavy objects on the camera.</u> This can cause the heavy object to tip over or fall and cause injury.
	<u>Do not move the camera while the AC power adapter is still connected. Do not pull on the connection cord to disconnect the AC power adapter.</u> This can damage the power cord or cables and cause a fire or electric shock.
	<u>Do not use the AC power adapter when the plug is damaged or the plug socket connection is loose.</u> This could cause a fire or electric shock.
	<u>Do not cover or wrap the camera or the AC power adapter in a cloth or blanket.</u> This can cause heat to build up and distort the casing or cause a fire.
	<u>When you are cleaning the camera or you do not plan to use the camera for an extended period, remove the battery and disconnect and unplug the AC power adapter.</u> Failure to do so can cause a fire or electric shock.

 CAUTION	
 <small>Unplug from power socket</small>	<u>When charging ends, unplug the charger from the power socket.</u> Leaving the charger plugged into the power socket can cause a fire.
	<u>Using a flash too close to a person's eyes may temporarily affect the eyesight.</u> Take particular care when photographing infants and young children.
	<u>When a memory card is removed, the card could come out of the slot too quickly. Use your finger to hold it and gently release the card.</u> Injury could result to those struck by the ejected card.
	<u>Request regular internal testing and cleaning for your camera.</u> Build-up of dust in your camera can cause a fire or electric shock. Contact your FUJIFILM dealer to request internal cleaning every two years. Please note that this service is not free of charge.

The Battery and Power Supply

Note: Check the type of battery used in your camera and read the appropriate sections.

The following describes the proper use of batteries and how to prolong their life. Incorrect use can shorten battery life or cause leakage, overheating, fire, or explosion.

Li-ion Batteries

Read this section if your camera uses a rechargeable Li-ion battery.

The battery is not charged at shipment. Charge the battery before use. Keep the battery in its case when not in use.

Notes on the Battery

The battery gradually loses its charge when not in use. Charge the battery one or two days before use.

Battery life can be extended by turning the camera off when not in use.

Battery capacity decreases at low temperatures; a depleted battery may not function at when cold. Keep a fully charged spare battery in a warm place and exchange as necessary, or keep the battery in your pocket or other warm place and insert it in the camera only when shooting. Do not place the battery in direct contact with hand warmers or other heating devices.

Charging the Battery

Charging times will increase at ambient temperatures below +10°C (+50°F) or above +35°C (+95°F). Do not attempt to charge the battery at temperatures above 40°C (+104°F); at temperatures below 0°C (+32°F), the battery will not charge.

Do not attempt to recharge a fully charged battery. The battery does not however need to be fully discharged before charging.

The battery may be warm to the touch immediately after charging or use. This is normal.

Battery Life

At normal temperatures, the battery can be recharged about 300 times. A noticeable decrease in the length of time the battery will hold a charge indicates that it has reached the end of its service life and should be replaced.

Storage

Performance may be impaired if the battery is left unused for extended periods when fully charged. Run the battery flat before storing it.

If the camera will not be used for an extended period, remove the battery and store it in a dry place with an ambient temperature of from +15°C to +25°C (+59°F to +77°F). Do not store in locations exposed to extremes of temperature.

Cautions: Handling the Battery

- Do not transport or store with metal objects such as necklaces or hairpins.
- Do not expose to flame or heat.
- Do not disassemble or modify.
- Use with designated chargers only.
- Do not drop or subject to strong physical shocks.
- Do not expose to water.
- Keep the terminals clean.
- The battery and camera body may become warm to the touch after extended use. This is normal.

AA Alkaline/Rechargeable NiMH Batteries/

AA lithium batteries

Read this section if your camera uses AA alkaline or rechargeable AA NiMH batteries. Information on compatible battery types may be found elsewhere in the camera manual.

Cautions: Handling the Batteries

- Do not expose to water, flame, or heat, or store in warm or humid conditions.
- Do not transport or store with metal objects such as necklaces or hairpins.
- Do not disassemble or modify the batteries or battery casing.
- Do not subject to strong physical shocks.
- Do not use batteries that are leaking, deformed, or discolored.
- Keep out of reach of infants and small children.
- Insert in the correct orientation.

- Do not mix old and new batteries, batteries with different charge levels, or batteries of different types.
- If the camera will not be used for an extended period, remove the batteries. Note that the camera clock will be reset.
- The batteries may be warm to the touch immediately after use. Turn the camera off and allow the batteries to cool before handling.
- Battery capacity tends to decrease at low temperatures. Keep spare batteries in a pocket or other warm place and exchange as necessary. Cold batteries may recover some of their charge when warmed.
- Fingerprints and other stains on the battery terminals can impair battery performance. Thoroughly clean the terminals with a soft, dry cloth before inserting them in the camera.



If the batteries leak, clean the battery compartment thoroughly before inserting new batteries.



If fluid from the battery comes into contact with skin or clothing, flush the affected area with water. ***If fluid enters your eyes, immediately flush the affected area with water and seek medical attention. Do not rub your eyes. Failure to observe this precaution could result in permanent visual impairment.***

■ NiMH Batteries

The capacity of Ni-MH batteries may be temporarily reduced when new, after long periods of disuse, or if they are repeatedly recharged before being fully discharged. This is normal and does not indicate a malfunction. Capacity can be increased by repeatedly discharging the batteries using the discharge option in the camera setup menu and recharging them using a battery charger.

ⓘ **CAUTION:** Do not use the discharge option with alkaline batteries.

The camera draws a small amount of current even when off. Ni-MH batteries that have been left in the camera for an extended period may be drawn down to the point that they no longer hold a charge. Battery performance may also drop if the batteries are run down in a device such as a flashlight. Use the discharge option in the camera setup menu to discharge Ni-MH batteries. Batteries that no longer hold a charge even after repeatedly being discharged and recharged have reached the end of their service life and must be replaced.

Ni-MH batteries can be recharged in a battery charger (sold separately). Batteries may become warm to the touch after charging. Refer to the instructions provided with the charger for more information. Use the charger with compatible batteries only.

Ni-MH batteries gradually lose their charge when not in use.

■ Disposal

CAUTION: Dispose of used batteries in accord with local regulations.

AC Power Adapters (Available Separately)

This section applies to all camera models. Use only FUJIFILM AC power adapters designated for use with this camera. Other adapters could damage the camera.

- The AC power adapter is for indoor use only.
- Be sure the DC plug is securely connected to the camera.
- Turn the camera off before disconnecting the adapter. Disconnect the adapter by the plug, not the cable.
- Do not use with other devices.
- Do not disassemble.
- Do not expose to high heat and humidity.
- Do not subject to strong physical shocks.
- The adapter may hum or become hot to the touch during use. This is normal.
- If the adapter causes radio interference, reorient or relocate the receiving antenna.

Using the Camera

Do not aim the camera at extremely bright light sources, such as the sun in a cloudless sky. Failure to observe this precaution could damage the camera image sensor.

Take Test Shots

Before taking photographs on important occasions (such as at weddings or before taking the camera on a trip), take a test shot and view the result in the LCD monitor to ensure that the camera is functioning normally. FUJIFILM Corporation can not accept liability for damages or lost profits incurred as a result of product malfunction.

Notes on Copyright

Unless intended solely for personal use, images recorded using your digital camera system cannot be used in ways that infringe copyright laws without the consent of the owner. Note that some restrictions apply to the photographing of stage performances, entertainments, and exhibits, even when intended purely for personal use. Users are also asked to note that the transfer of memory cards containing images or data protected under copyright laws is only permissible within the restrictions imposed by those copyright laws.

Handling

To ensure that images are recorded correctly, do not subject the camera to impact or physical shocks while images are being recorded.

Liquid Crystal

In the event that the LCD monitor is damaged, care should be taken to avoid contact with liquid crystal. Take the urgent action indicated should any of the following situations arise:

- **If liquid crystal comes in contact with your skin**, clean the area with a cloth and then wash thoroughly with soap and running water.
- **If liquid crystal enters your eyes**, flush the affected eye with clean water for at least 15 minutes and then seek medical assistance.
- **If liquid crystal is swallowed**, rinse your mouth thoroughly with water. Drink large quantities of water and induce vomiting, then seek medical assistance.

Although the display is manufactured using extremely high-precision technology, it may contain pixels that are always lit or that do not light. This is not a malfunction, and images recorded with the product are unaffected.

Trademark Information

xD-Picture Card and  are trademarks of FUJIFILM Corporation. The typefaces included herein are solely developed by DynaComware Taiwan Inc. Macintosh, QuickTime, and Mac OS are trademarks of Apple Inc. in the U.S.A. and other countries. Windows 8, Windows 7, Windows Vista, and the Windows logo are trademarks of the Microsoft group of companies. Wi-Fi® and Wi-Fi Protected Setup® are registered trademarks of the Wi-Fi Alliance. Adobe and Adobe Reader are either trademarks or registered trademarks of Adobe Systems Incorporated in the U.S.A. and/or other countries. The SDHC and SDXC logos are trademarks of SD-3C, LLC. The HDMI logo is a trademark. YouTube is a trademark of Google Inc. All other trade names mentioned

in this manual are the trademarks or registered trademarks of their respective owners.

Electrical Interference

This camera may interfere with hospital or aviation equipment. Consult with hospital or airline staff before using the camera in a hospital or on an aircraft.

Exif Print (Exif Version 2.3)

Exif Print is a newly revised digital camera file format in which information stored with photographs is used for optimal color reproduction during printing.

IMPORTANT NOTICE: Read Before Using the Software

Direct or indirect export, in whole or in part, of licensed software without the permission of the applicable governing bodies is prohibited.

IMPORTANT: Read the following notices before using the camera's built-in wireless transmitter.

- Ⓢ This product, which contains encryption function developed in the United States, is controlled by the United States Export Administration Regulations and may not be exported or re-exported to any country to which the United States embargoes goods.
- **Use only as part of a wireless network.** FUJIFILM does not accept liability for damages resulting from unauthorized use. Do not use in applications requiring a high degree of reliability, for example in medical devices or other systems that may directly or indirectly impact human life. When using the device in computer and other systems that demand a greater degree of reliability than wireless networks, be sure to take all necessary precautions to ensure safety and prevent malfunction.
 - **Use only in the country in which the device was purchased.** This device conforms to regulations governing wireless network devices in the country in which it was purchased. Observe all location regulations when using the device. FUJIFILM does not accept liability for problems arising from use in other jurisdictions.
 - **Wireless data (images) may be intercepted by third parties.** The security of data transmitted over wireless networks is not guaranteed.
 - **Do not use the device in locations subject to magnetic fields, static electricity, or radio interference.** Do not use the transmitter in the vicinity of microwave ovens or in other locations subject to magnetic fields, static electricity, or radio interference that may prevent reception of wireless signals. Mutual interference may occur when the transmitter is used in the vicinity of other wireless devices operating in the 2.4 GHz band.
 - **The wireless transmitter operates in the 2.4 GHz band using DSSS and OFDM modulation.**

Wireless Network Devices: Cautions

- **This device operates on the same frequency as commercial, educational, and medical devices and wireless transmitters.** It also operates on the same frequency as licensed transmitters and special unlicensed low-voltage transmitters used in RFID tracking systems for assembly lines and in other similar applications.
- **To prevent interference with the above devices, observe the following precautions.** Confirm that the RFID transmitter is not in operation before using this device. If the device causes interference to premises radio stations used for RFID tracking, immediately either relocate this device or stop the emission of radio waves. If you notice that this device causes interference in low-voltage RFID tracing systems, contact a FUJIFILM representative.

2.4DS/OF4

This sticker indicates that this device operates in the 2.4 GHz band using DSSS and OFDM modulation and may cause interference at distances of up to 40 m.

About This Manual

Before using the camera, read this manual and the warnings in “For Your Safety” (📖 ii). For information on specific topics, consult the sources below.

Table of Contents 📖 xv

The “Table of Contents” gives an overview of the entire manual. The principal camera operations are listed here.

Troubleshooting 📖 97

Having a specific problem with the camera? Find the answer here.

Warning Messages and Displays ... 📖 104

Find out what’s behind that flashing icon or error message in the display.

Memory Cards

Pictures can be stored in the camera’s internal memory or on optional SD, SDHC, and SDXC memory cards (📖 12), referred to in this manual as “memory cards.”

Frequently-Used Buttons

■ Deleting Pictures

➔ To delete a picture, display it full frame and press the selector up (🗑).



■ Taking Pictures During Playback

➔ To return instantly to shooting mode, press the shutter button halfway.

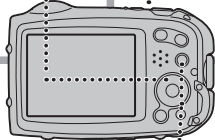
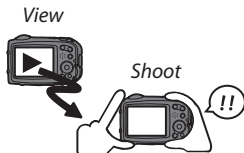

■ Turning the Camera on in Playback Mode

➔ When the camera is off, playback can be started by pressing the  button for about a second.



Product Features and Precautions for Use

■ Water, Dust, and Shock Resistance

- ① The camera complies with JIS Class 8 water resistance and JIS Class 6 (IP68) dust resistance standards, and has passed FUJIFILM drop tests (drop height: 1.75 m/5.7 ft; impact surface: plywood, thickness 5 cm/2.0 in.) compliant with MIL-STD 810F Method 516.5: Shock. These results were obtained through in-house testing and are not a blanket guarantee of water resistance or invulnerability to damage or destruction. The accessories supplied with the camera are not water resistant.

■ Before Use

- 1 Inspect the water-resistant seal and adjacent surfaces and remove any dust, sand, or other foreign matter using a soft, dry cloth.

- ① Have the water-resistant seal replaced if it is deformed or otherwise damaged (note that a fee is charged for this service; contact your retailer or a FUJIFILM-authorized repair technician for more information). Failure to replace the seal could result in leaks and damage to the camera.

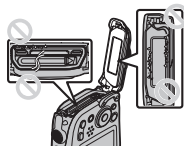

- 2 Holding the battery-chamber cover closed against the camera body (①), rotate the latch until it clicks into place (②), indicating that the cover is secure.

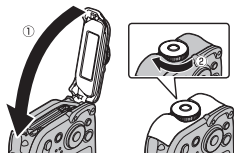

- 3 Check that the cover is secure by rotating the latch in the opposite direction and confirming that the cover does not open.

- ① The front surface of the camera lens is protected by a sheet of glass. Foreign matter on the glass will appear in photographs; keep the glass clean at all times.
- ① Be sure that the battery-chamber is fully latched. The presence of water, mud, or sand in the camera could cause malfunction.
- ① Do not open or close the battery-chamber cover with wet hands or in locations that are dusty, sandy, or near water, for example while on or by a body of water.
- ① Be sure the camera is completely dry before inserting or removing batteries or memory cards or connecting the USB or HDMI cable.
- ① The camera does not float. Be sure to attach the strap and keep it around your wrist when using the camera.

■ During Use

- ① Restrict underwater use to depths of 15 m (49 ft.) or less and periods shorter than 120 minutes. Clean and dry the camera within one hour of using it underwater.
- ① The interior of the camera is not waterproof. Do not open or close the battery-chamber cover while under water. After cleaning the camera, be sure it is completely dry before opening or closing the battery-chamber cover.
- ① Do not use in hot springs or heated pools.
- ① The camera may lose water resistance if subjected to excessive force or vibration. Do not dive into water with the camera or otherwise subject it to excessive force. In the event the camera is subjected to strong physical shocks, contact your retailer or a FUJIFILM-authorized repair technician.
- ① If the camera is left on the sand, its temperature may exceed operating limits and sand may get into the speaker or microphone.
- ① Sunscreen, suntan lotion, or other oily substances may discolor the camera body and should be removed with a damp cloth.

■ After Use

Perform the following steps after using the camera underwater or in locations where foreign matter might adhere to the camera body.

- 1** Securely close the battery-chamber cover and rinse the camera under the tap or leave it in a basin of fresh water for about ten minutes.



- 2** Remove water from the camera with a soft, dry cloth and leave it to dry in a well-ventilated location in the shade.
- 3** After confirming that the camera has dried and is free of water droplets, open the battery-chamber cover and use a soft, dry cloth to remove any water, dust, or other foreign matter from the battery chamber.

- ① Remove any foreign matter from the water-resistant seal and adjacent surfaces. Foreign matter could damage the seal, lowering water resistance.
- ① Liquid soaps, detergents, alcohol, and other cleansers may affect water resistance and should never be used.
- ① After use, remove water droplets and foreign matter with a dry cloth, firmly latch the battery-chamber cover, and soak the camera in fresh water for about ten minutes. Dry the camera thoroughly after removing it from the water.

■ Storage and Maintenance

- ① Do not store at temperatures below 0 °C (32 °F) or above 40 °C (104 °F).
- ① To ensure continued water resistance, it is recommended that you have the water-resistant seal replaced about once a year (a fee is charged for this service). Contact your retailer or a FUJIFILM-authorized repair technician for more information.

■ Condensation Inside the Lens

In some environments, condensation (fog) may form inside of lens. This does not indicate a malfunction. Condensation can be removed by leaving the battery-chamber cover open in a location with a steady temperature that is free of heat, humidity, sand, and dust.

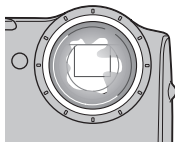

● Condensation

Condensation is particularly likely to occur if the camera is placed in cold water after being exposed to high temperatures or taken from a cold to a warm environment or if the battery chamber is opened in a humid location.

■ Cold Climates

- ① Battery performance drops at low temperatures, reducing the number of pictures that can be taken. Insulate the camera to keep it warm or place it in your clothing.
- ① Use an NP-45S battery.
- ① Display response may slow at low temperatures. This is not a malfunction.

Table of Contents

For Your Safety	ii
Safety Notes.....	ii
About This Manual	ix
Frequently-Used Buttons	x
Product Features and Precautions for Use.....	xi

Before You Begin

Symbols and Conventions.....	1
Supplied Accessories	1
Parts of the Camera	2
Camera Displays.....	4
Shooting	4
Playback.....	5











First Steps















Inserting the Battery and a Memory Card.....	7
Compatible Memory Cards	12
Charging the Battery	14
Turning the Camera on and Off	17
Shooting Mode	17
Playback Mode.....	17
Basic Setup	19













































Basic Photography and Playback

Taking Pictures in  (Scene Recognition) Mode.....	20
Viewing Pictures	24

More on Photography

Shooting Mode	25
Choosing a Shooting Mode	25
Shooting Mode Options	26
 ACTION CAMERA	27
 PRO LOW-LIGHT.....	28
 HDR	29
 ADVANCED FILTER.....	30
 MOTION PANORAMA 360.....	31
 Intelligent Face Detection.....	33
Focus Lock	34
 Exposure Compensation	36
 Macro Mode (Close-ups)	37
 Using the Flash (Intelligent Flash)	38
 Using the Self-Timer	40
Interval shooting.....	41
The Burst Mode Button.....	43

More on Playback		Connections	
Playback Options.....	44	Viewing Pictures on High-Definition TVs.....	58
Continuous Shooting.....	44	Printing Pictures via USB.....	59
★ Favorites: Rating Pictures.....	44	Printing the DPOF Print Order.....	61
Playback Zoom.....	45	Viewing Pictures on a Computer	63
Multi-Frame Playback.....	46	Copying Pictures to a Computer.....	63
 Deleting Pictures.....	47	Windows: Downloading and Installing MyFinePix Studio to a Computer.....	63
 Image Search.....	48	Windows: Installing MyFinePix Studio.....	64
 PhotoBook Assist.....	49	Windows: Uninstalling MyFinePix Studio.....	66
Creating a PhotoBook.....	49	Connecting the Camera.....	67
Viewing Photobooks.....	50		
Editing and Deleting Photobooks.....	50	Menus	
Viewing Panoramas.....	51	Using the Menus: Shooting Mode.....	69
		Using the Shooting Menu.....	69
Wireless Networks		Shooting Menu Options.....	69
Using Wireless Networks.....	52	 SHOOTING MODE.....	69
Connecting with smartphones.....	52	 ISO.....	69
Saving Pictures to a Computer.....	53	 IMAGE SIZE.....	70
		 IMAGE QUALITY.....	71
Movies		 FINEPIX COLOR.....	71
Recording Movies.....	54	 WHITE BALANCE.....	72
Viewing Movies.....	57	 CONTINUOUS.....	73
		 FACE DETECTION.....	73
		 AF MODE.....	74
		 MOVIE AF MODE.....	74
		 MOVIE MODE.....	75
		 WIRELESS COMMUNICATION.....	75

Using the Menus: Playback Mode	76	The Setup Menu	84
Using the Playback Menu	76	Using the Setup Menu	84
Playback Menu Options	76	Setup Menu Options	85
 WIRELESS COMMUNICATION	76	 DATE/TIME	85
 PC AUTO SAVE	76	 TIME DIFFERENCE	85
 IMAGE SEARCH	76	 言語/LANG.	85
 ERASE	76	 SILENT MODE	85
 MOVIE EDIT	77	 RESET	86
 MARK FOR UPLOAD TO	78	 FORMAT	86
 SLIDE SHOW	79	 IMAGE DISP.	86
 RED EYE REMOVAL	79	 FRAME NO.	87
 PROTECT	80	 OPERATION VOL.	88
 CROP	80	 SHUTTER VOLUME	88
 RESIZE	81	 SHUTTER SOUND	88
 IMAGE ROTATE	81	 PLAYBACK VOLUME	88
 COPY	82	 LCD BRIGHTNESS	88
 PHOTOBOK ASSIST	82	 LCD POWER SAVE	89
 PRINT ORDER (DPOF)	82	 AUTO POWER OFF	89
 DISP ASPECT	83	 IS MODE	89
		 DIGITAL IMAGE STABILIZER	89
		 RED EYE REMOVAL	89
		 INTELLIGENT DIGITAL ZOOM	90
		 MOVIE ZOOM TYPE	91
		 AF ILLUMINATOR	91
		 AUTOROTATE PB	91
		 BACKGROUND COLOR	91
		 WIND FILTER	91
		 WIRELESS SETTINGS	91
		 PC AUTO SAVE SETTING	92
		 GEOTAGGING SET-UP	92
		 DATE DATE STAMP	92

Technical Notes

Optional Accessories93
 Accessories from FUJIFILM.....94
Caring for the Camera.....95
 Storage and Use95
 Condensation.....95
 Cleaning.....96
 Traveling96

Troubleshooting

Problems and Solutions.....97
Warning Messages and Displays104

Appendix

Memory Card Capacity108
Specifications109

Before You Begin

Symbols and Conventions

The following symbols are used in this manual:

- ⓘ : This information should be read before use to ensure correct operation.
- 📖 : Additional information that may be helpful when using the camera.
- 📖 : Other pages in this manual on which related information may be found.

Menus and other text in the LCD monitor are shown in **bold**. In the illustrations in this manual, displays may be simplified for explanatory purposes.

Supplied Accessories

The following items are included with the camera:



*NP-45S rechargeable
battery*



AC power adapter



*Plug adapter**



USB cable

- *Strap*
- *User Guide/
Basic Manual*

Attaching the Strap

Attach the strap as shown.

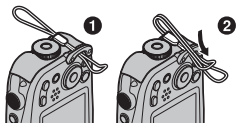

* Shape of adapter varies with region of sale.

Parts of the Camera

For more information, refer to the page listed to the right of each item.

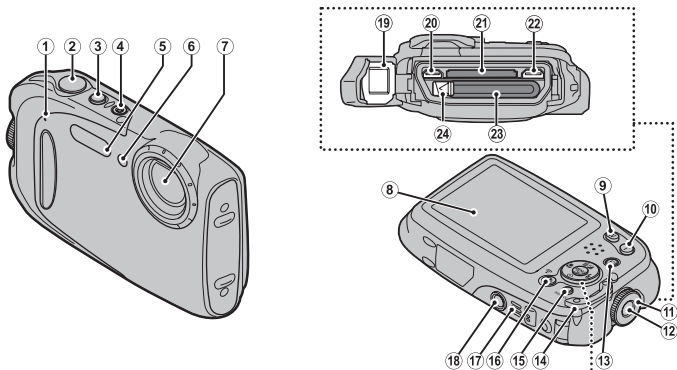

Selector button

Move cursor up

- (exposure compensation) button (36)
- (delete) button (3)

MENU/OK button

Move cursor left

- (macro) button (37)

Move cursor right



- (flash) button (38)

Move cursor down

- (self-timer) button (40)



* The illustrations in this manual have been simplified for explanatory purposes.

① Microphone.....	54	⑭ Strap eyelet.....	1
② Shutter button.....	22	⑮ DISP (display)/ BACK button.....	6, 19
③ ON/OFF button.....	17	⑯ Burst mode button.....	43
④  (movie recording) button.....	54	 (wireless transfer) button.....	52
⑤ Flash.....	38	⑰ Speaker.....	57
⑥ Self-timer lamp.....	40	⑱ Tripod mount.....	
AF-assist illuminator.....	91	⑲ Water-resistant seal.....	xi, 10
⑦ Lens/protective glass.....		⑳ USB connector.....	59, 67
⑧ LCD monitor.....	4	㉑ Memory card slot.....	9
⑨ W (zoom out) button.....	21, 45	㉒ Micro HDMI connector.....	58
⑩ T (zoom in) button.....	21, 45	㉓ Battery chamber.....	7
⑪ Latch.....	7, 10	㉔ Battery latch.....	8, 11
⑫ Safety lock.....	7, 10		
⑬  (playback) button.....	24		

Camera Displays

The following types of indicator may be displayed during shooting and playback. Indicators vary with camera settings.

Shooting

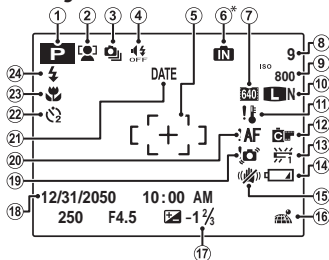

① Shooting mode	25
② Intelligent Face Detection indicator.....	33
③ Continuous shooting mode	73
④ Silent mode indicator.....	85
⑤ Focus frame.....	34
⑥ Internal memory indicator*	
⑦ Movie mode.....	75

⑧ Number of available frames	108
⑨ Sensitivity	69
⑩ Image size and quality	70, 71
⑪ Temperature warning.....	105
⑫ FINEPIX color	71
⑬ White balance.....	72
⑭ Battery level.....	5
⑮ IS mode.....	89
⑯ Location data download status	92
⑰ Exposure compensation	36
⑱ Date and time	19
⑲ Blur warning	39, 104
⑳ Focus warning.....	22, 104
㉑ Date stamp.....	92
㉒ Self-timer indicator	40
㉓ Macro (close-up) mode	37
㉔ Flash mode	38

* **IN**: indicates that no memory card is inserted and that pictures will be stored in the camera's internal memory (see 9); flashes yellow while images are recorded. If a memory card is inserted, a yellow **SD** icon will flash in the display while images are recorded.

■ Playback

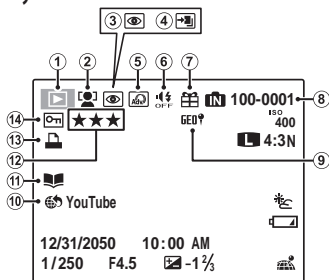

① Playback mode indicator	24, 44
② Intelligent Face Detection indicator.....	33, 79
③ Red-eye removal indicator	79
④ Pro low-light mode, HDR	28, 29
⑤ Advanced filter.....	30
⑥ Silent mode indicator	85
⑦ Gift image	44
⑧ Frame number	87
⑨ Location data	92
⑩ Mark for upload to	78
⑪ Photobook assist.....	49
⑫ Favorites.....	44
⑬ DPOF print indicator	61
⑭ Protected image.....	80

● Battery Level

Battery level is shown as follows:

Indicator	Description
(white)	Battery partially discharged.
(white)	Battery more than half discharged.
(red)	Low battery. Charge as soon as possible.
(blinks red)	Battery exhausted. Turn camera off and charge battery.

Hiding and Viewing Indicators

Press **DISP/BACK** to cycle through shooting and playback indicators as follows:

- **Shooting:** Indicators displayed/indicators hidden/best framing/HD framing
- **Playback:** Indicators displayed/indicators hidden/★ favorites

First Steps

Inserting the Battery and a Memory Card

Insert the battery and memory card as described below.

- ① Before proceeding, confirm that the water-resistant seal is free of foreign matter as described on page xi.

1 Open the battery-chamber cover.

Keeping the safety lock pressed (①), rotate the latch (②) and open the battery-chamber cover (③).

- ◆ Be sure the camera is off before opening the battery-chamber cover.
- ① Do not open the battery-chamber cover when the camera is on. Failure to observe this precaution could result in damage to image files or memory cards.
 - ① Do not use excessive force when handling the battery-chamber cover.
 - ① Remove water droplets and other foreign matter with a dry cloth before opening the battery-chamber cover.

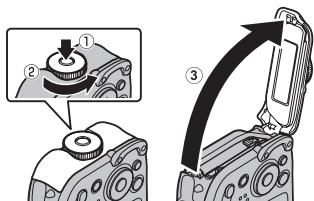

2 Insert the battery.

Align the orange stripe on the battery with the orange battery latch and slide the battery into the camera, keeping the battery latch pressed to one side. Confirm that the battery is securely latched.

- ① Insert the battery in the correct orientation. **Do NOT use force or attempt to insert the battery upside down or backwards.** The battery will slide in easily in the correct orientation.

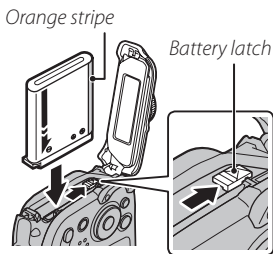

3 Insert the memory card.

Holding the memory card in the orientation shown at right, slide it in until it clicks into place at the back of the slot.

- ① Be sure card is in the correct orientation; do not insert at an angle or use force. If the memory card is not correctly inserted or no memory card is inserted, **IN** will appear in the LCD monitor and internal memory will be used for recording and playback.
- ① SD/SDHC/SDXC memory cards can be locked, making it impossible to format the card or to record or delete images. Before inserting an SD/SDHC/SDXC memory card, slide the write-protect switch to the unlocked position.

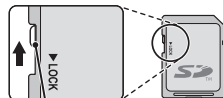
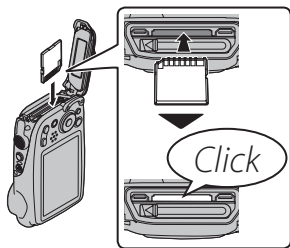

Write-protect switch

4 Close and latch the battery-chamber cover.

Holding the battery-chamber cover closed against the camera body (①), rotate the latch until it clicks into place (②), indicating that the cover is secure.

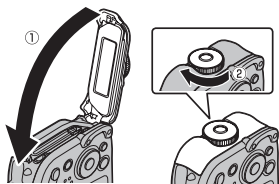

- ① Before closing the cover, confirm that there is no dust, sand, or other foreign matter on the water-resistant seal or adjacent surfaces.
- ① When closing the battery-chamber cover, do not subject it to excessive horizontal forces. Failure to observe this precaution could cause the water-resistant seal to become misaligned, allowing water into the camera.
- ① Check that the cover is secure by rotating the latch in the opposite direction and confirming that the cover does not open.

Confirming That the Cover Is Latched

Make sure that the strap is not caught in the cover and that the latch is closed.

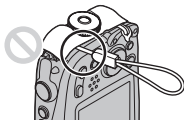

Correct

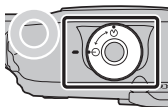

The latch is closed.

Incorrect

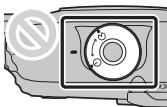

The latch is open.

Removing the Battery and Memory Card

Before removing the battery or memory card, **turn the camera off** and open the battery-chamber cover.

To remove the battery, press the battery latch to the side, and slide the battery out of the camera as shown.

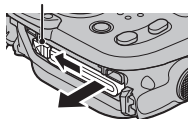

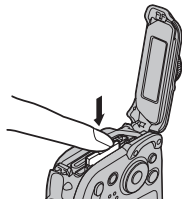

To remove the memory card, press it in and release it slowly. The card can then be removed by hand. When a memory card is removed, the card could come out of the slot too quickly. Use your finger to hold it and gently release the card.



■ Compatible Memory Cards

FUJIFILM and SanDisk SD, SDHC, and SDXC memory cards have been approved for use in the camera. A complete list of approved memory cards is available at http://www.fujifilm.com/support/digital_cameras/compatibility/. Operation is not guaranteed with other cards. The camera can not be used with **xD-Picture Cards** or **MultiMediaCard** (MMC) devices.

① Memory Cards

- *Do not turn the camera off or remove the memory card while the memory card is being formatted or data are being recorded to or deleted from the card.* Failure to observe this precaution could damage the card.
- Format SD/SDHC/SDXC memory cards before first use, and be sure to reformat all memory cards after using them in a computer or other device. For more information on formatting memory cards, see “ **FORMAT**” (📖 86).
- Memory cards are small and can be swallowed; keep out of reach of children. If a child swallows a memory card, seek medical assistance immediately.
- miniSD or microSD adapters that are larger or smaller than the standard dimensions of an SD/SDHC/SDXC card may not eject normally; if the card does not eject, take the camera to an authorized service representative. Do not forcibly remove the card.
- Do not affix labels to memory cards. Peeling labels can cause camera malfunction.
- Movie recording may be interrupted with some types of SD/SDHC/SDXC memory card. Use a **CLASSIC**  card or better when shooting HD movies, Full HD movies or high-speed movies.

- The data in internal memory may be erased or corrupted when the camera is repaired. Please note that the repairer will be able to view pictures in internal memory.
- Formatting a memory card or internal memory in the camera creates a folder in which pictures are stored. Do not rename or delete this folder or use a computer or other device to edit, delete, or rename image files. Always use the camera to delete pictures from memory cards and internal memory; before editing or renaming files, copy them to a computer and edit or rename the copies, not the originals.

① Batteries

- Remove dirt from the battery terminals with a clean, dry cloth. Failure to observe this precaution could prevent the battery from charging.
- Do not affix stickers or other objects to the battery. Failure to observe this precaution could make it impossible to remove the battery from the camera.
- Do not short the battery terminals. The battery could overheat.
- Read the cautions in “The Battery and Power Supply” (📖 v).
- Use only battery chargers designated for use with the battery. Failure to observe this precaution could result in product malfunction.
- Do not remove the labels from the battery or attempt to split or peel the outer casing.
- The battery gradually loses its charge when not in use. Charge the battery one or two days before use.

Charging the Battery

The battery is not charged at shipment. Charge the battery before use. The camera charges the battery internally.

The camera uses an NP-45S rechargeable battery.

1 Attach the plug adapter to the AC power adapter.

Attach the plug adapter as shown, making sure that it is fully inserted and clicks into place on the AC power adapter terminals.

- ① The plug adapter is exclusively for use with the supplied AC power adapter. Do not use it with other devices.

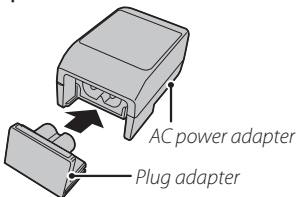

2 Open the battery-chamber cover.

Keeping the safety lock pressed (①), rotate the latch (②) and open the battery-chamber cover (③).

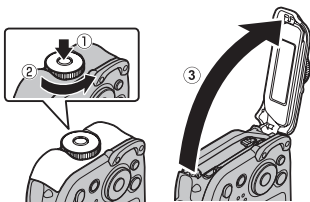

3 Charge the battery.

Connect the camera to the supplied AC power adapter using the supplied USB cable. Then plug the AC power adapter into an indoor power outlet.

- ① Be sure the connectors are in the correct orientation and then insert them fully.

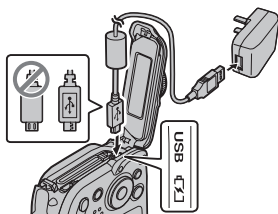

The Self-timer Lamp

The self-timer lamp shows battery charge status as follows:



Self-timer lamp	Battery status	Action
On	Battery charging.	—
Blinks	Battery fault.	See page 98.
Off	Charging complete.	—
	Can not charge.	Unplug the AC power adapter from the power outlet and reinsert the battery in the correct orientation (📖 98).

- ① The battery will not charge while the camera is on.
- 🔦 The camera operates in external power mode if the camera is turned on while plugged into AC power.

Charging via a computer

The battery can be charged by connecting the camera to a computer.

Turn the camera off and connect the supplied USB cable as shown, making sure the connectors are fully inserted. Connect the camera directly to the computer; do not use a USB hub or keyboard.

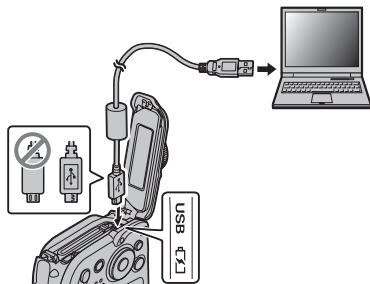

- ① If the camera is turned on, charging is not available.
- ① If the computer goes into sleep mode while charging, charging will stop. To continue charging, disable sleep mode on the computer, and disconnect and connect the USB cable.
- ① Charging may be impossible depending on computer specifications, settings or conditions.

Turning the Camera on and Off

Shooting Mode

Press the **ON/OFF** button to turn the camera on.

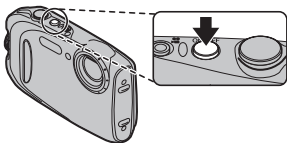

Press **ON/OFF** again to turn the camera off.

◆ **Switching to Playback Mode**

Press the  button to start playback. Press the shutter button halfway to return to shooting mode.

ⓘ You may be prompted to confirm that the battery-chamber cover is locked, but this does not indicate a malfunction.

Playback Mode

To turn the camera on and begin playback, press the  button for about a second.

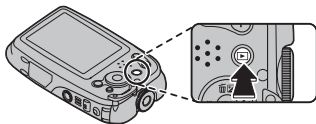



Press the  button again or press the **ON/OFF** button to turn the camera off.

◆ **Switching to Shooting Mode**



To exit to shooting mode, press the shutter button halfway. Press the  button to return to playback.

- ⓘ Fingerprints and other marks on the protective glass covering the lens can affect pictures. Keep the glass clean.
- ⓘ The **ON/OFF** button does not completely end the supply of power to the camera.

🔑 **Auto Power Off**

The camera will turn off automatically if no operations are performed for the length of time selected for  **AUTO POWER OFF** (📖 89). To turn the camera on, use the **ON/OFF** button or press the  button for about a second.

Basic Setup

A language-selection dialog is displayed the first time the camera is turned on. Set up the camera as described below (you can reset the clock or change languages at any time using the  **DATE/TIME** or  **言語/LANG.** options in the setup menu; for information on displaying the setup menu, see page 85).

1 Highlight a language and press **MENU/OK**.

- ◆ Press **DISP/BACK** to skip the current step. Any steps you skip will be displayed the next time the camera is turned on.

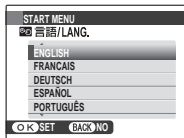

2 The date and time will be displayed. Press the selector left or right to highlight the year, month, day, hour, or minute and press up or down to change. To change the order in which the year, month, and day are displayed, highlight the date format and press the selector up or down. Press **MENU/OK** when settings are complete.

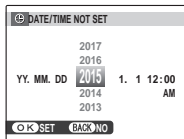

◆ The Camera Clock

If the battery is removed for an extended period, the camera clock will be reset and the language-selection dialog will be displayed when the camera is turned on.

Basic Photography and Playback

Taking Pictures in **SR** **AUTO** (Scene Recognition) Mode

This section describes how to take pictures in **SR** **AUTO** (scene recognition) mode. The camera automatically analyzes the composition and adjusts settings appropriately.

1 Turn the camera on.

Press the **ON/OFF** button to turn the camera on.

SR **AUTO** shooting indicators will be displayed.

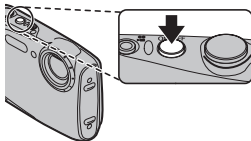















The Icon

This icon indicates that the camera continuously searches for faces to select the appropriate scene, increasing the drain on the battery.



The Scene Icon

The camera selects the scene according to shooting conditions and the type of subject (the scenes in brackets are selected if the camera detects that the subject is moving):  PORTRAIT () ,  LANDSCAPE () ,  NIGHT () ,  MACRO () ,  NIGHT PORTRAIT () ,  BACKLIT PORTRAIT () ,  AUTO AUTO () .

2 Frame the picture.

Use the zoom buttons to frame the picture in the display.

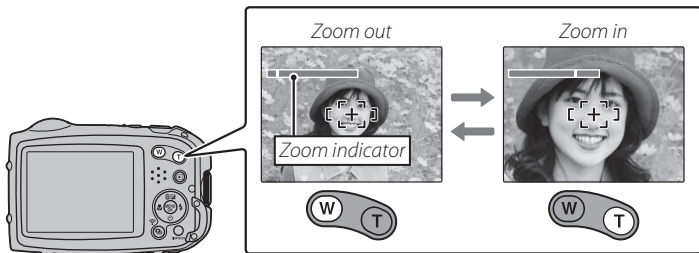

Holding the Camera

Hold the camera steady with both hands and brace your elbows against your sides. Shaking or unsteady hands can blur your shots.



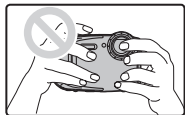

To prevent pictures that are out of focus or too dark (underexposed), keep your fingers and other objects away from the flash and from the protective glass covering the lens.



3 Focus.

Press the shutter button halfway to focus.

- ◆ The lens may make a noise when the camera focuses; this is normal. If the subject is poorly lit, the AF-assist illuminator may light; see “ **AFILLUMINATOR**” ( 91) for information on disabling the illuminator.

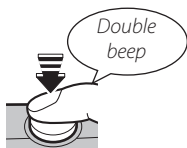

If the camera is able to focus, it will beep twice.

If the camera is unable to focus, the focus frame will turn red, **!AF** will be displayed. Change the composition or use focus lock ( 34).

4 Shoot.

Smoothly press the shutter button the rest of the way down to take the picture.

- ◆ If the subject is poorly lit, the flash may fire when the picture is taken. For information on using the flash when lighting is poor, see “ Using the Flash (Intelligent Flash)” (📖 38).



The Shutter Button

The shutter button has two positions. Pressing the shutter button halfway sets focus and exposure; to shoot, press the shutter button the rest of the way down.

Viewing Pictures

Pictures can be viewed in the LCD monitor. When taking important photographs, take a test shot and check the results.

1 Press the button.

The most recent picture will be displayed.

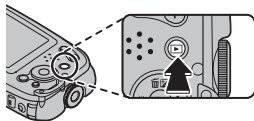

2 View additional pictures.

Press the selector right to view pictures in the order recorded, left to view pictures in reverse order.

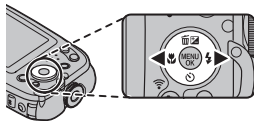

Press the shutter button halfway to exit to shooting mode.

More on Photography

Shooting Mode

Choose a shooting mode according to the scene or type of subject.

Choosing a Shooting Mode

1 Press **MENU/OK** to display the shooting menu.

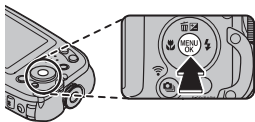

2 Highlight **SHOOTING MODE** and press the selector right to display shooting mode options.

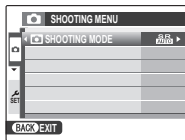



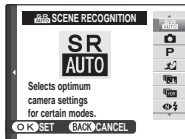

















3 Highlight the desired mode and press **MENU/OK**.



4 Press **DISP/BACK** to exit to shooting mode.





Shooting Mode Options

Mode	Description
 SCENE RECOGNITION	The camera automatically analyzes the composition and selects a scene according to shooting conditions and the type of subject.
 AUTO	Choose for crisp, clear snapshots. This mode is recommended in most situations.
P PROGRAM AE	The camera sets exposure automatically.
 ACTION CAMERA	Record impressive photos and videos of your adventures in wide angle (📖 27).
 PRO LOW-LIGHT	Choose when photographing stationary subjects under low light or with the camera zoomed in (📖 28).
 HDR	Choose when photographing high-contrast scenes. The camera varies exposure over a series of shots and blends the results to preserve details in highlights and shadows (📖 29).
 NATURAL & FLASH	The camera takes two shots: one without the flash and one with.
 PORTRAIT	Choose for portraits.
 LANDSCAPE	Choose for daylight shots of buildings and landscapes.
 ADVANCED FILTER	Take photos with filter effects (📖 30).
 MOTION PANORAMA 360	Pan the camera to record a series of shots that are joined together to form a panorama (📖 31).
 SPORT	Choose when photographing moving subjects.
 NIGHT	Choose this mode for poorly lit twilight or night scenes.
 NIGHT (TRIPOD)	Choose this mode for slow shutter speeds when shooting at night.
 SUNSET	Choose this mode to record the vivid colors in sunrises and sunsets.

Mode	Description
 SNOW	Choose for crisp, clear shots that capture the brightness of scenes dominated by shining white snow.
 BEACH	Choose for crisp, clear shots that capture the brightness of sunlit beaches.
 UNDERWATER	Choose for underwater photography.
 UNDER WATER (MACRO)	Choose for underwater close-ups of small objects.
 PARTY	Capture indoor background lighting under low-light conditions.
 FLOWER	Choose for vivid close-ups of flowers.
 TEXT	Take clear pictures of text or drawings in print.

■ ACTION CAMERA

Record impressive photos and videos of your adventures in wide angle. Choose this mode for shooting with the camera attached to the photographer's body etc. Press the  button to start or stop recording a video.

- ⓘ Do not use this mode under the condition where the camera may get hard vibration, such as putting the camera directly on the bicycle.
- 📷 While recording a video, the LCD monitor turns off and the self-timer lamp blinks. The self-timer lamp blinks may affect the video depending on the scene.
- 📷 When a video is recorded, the frame size is set to  **1920 × 1080** (60fps),  **1920 × 1080** (30fps),  **1280 × 720** (60fps) or  **640 × 480** (30 fps).

■ PRO LOW-LIGHT

Each time the shutter button is pressed, the camera makes four exposures and combines them into a single photograph. Use to reduce noise and blur when photographing poorly lit subjects or static subjects at high zoom ratios.



- ◆ A single combined photograph may not be created with some scenes or if the subject or camera moves during shooting. Do not move the camera until shooting is complete.

PRO LOW-LIGHT

- ① Keep the camera steady during shooting.
- ① The camera may make fewer than four exposures in some situations.

 **HDR**

Each time the shutter button is pressed, the camera takes a series of shots, each with different exposure. These are combined into a single image, preserving detail in highlights and shadows. Choose for high-contrast scenes.

❖ A single combined photograph may not be created with some scenes or if the subject or camera moves during shooting. Do not move the camera until shooting is complete.

















 **D-RANGE PRIORITY**

① Keep the camera steady during shooting.

■ ADVANCED FILTER

Take photos with filter effects.

- 1 Select **ADVANCED FILTER** for shooting mode (☰ 25).
- 2 Select a filter effect and press **MENU/OK**.

Filter	Description
 TOY CAMERA	Choose for a retro toy camera effect.
 MINIATURE* ¹	The tops and bottoms of pictures are blurred for a diorama effect.
 POP COLOR	Create high-contrast images with saturated colors.
 HIGH-KEY	Create bright, low-contrast images.
 LOW-KEY	Create uniformly dark tones with few areas of emphasized highlights.
 DYNAMIC TONE* ¹	Dynamic tone expression is used for a fantasy effect.
 FISH-EYE	Create a distorting effect of a fisheye lens.
 SOFT FOCUS* ¹	Create a look that is evenly soft throughout the whole image.
 CROSS SCREEN* ¹	Create a star pattern where lines radiate out from bright objects.
 SKETCH	Create line-drawing-like pictures with contours of subjects remained.
 PARTIAL COLOR (RED)	Areas of the image that are the selected color are recorded in that color. All others areas of the image are recorded in black-and-white.
 PARTIAL COLOR (ORANGE)	
 PARTIAL COLOR (YELLOW)	
 PARTIAL COLOR (GREEN)	
 PARTIAL COLOR (BLUE)	
 PARTIAL COLOR (PURPLE)	

*1 Not available when shooting movies.

◆ Depending on the subject and camera settings, images may in some cases be grainy or vary in brightness and hue.

MOTION PANORAMA 360

Follow an on-screen guide to take photos that will automatically be joined to form a panorama. The camera zooms all the way out and remains fixed at the widest angle until shooting is complete.



- 1 To select the angle through which you will pan the camera while shooting, press the selector down. Press the selector left or right to highlight an angle and press **MENU/OK**.
- 2 Press the selector right to view a choice of pan directions. Press the selector left or right to highlight a pan direction and press **MENU/OK**.
- 3 Press the shutter button all the way down to start recording. There is no need to keep the shutter button pressed during recording.
- 4 Pan the camera in the direction shown by the arrow. Shooting ends automatically when the progress bar is full and the panorama is complete.

- ◆ Shooting ends if the shutter button is pressed all the way down during shooting. No panorama will be recorded if the shutter button is pressed before the camera has been panned through 120°.

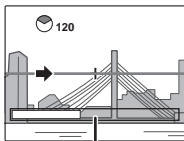

Progress bar

- ❗ Panoramas are created from multiple frames. The camera may in some cases record an greater or lesser angle than selected or be unable to stitch the frames together perfectly. The last part of the panorama may not be recorded if shooting ends before the panorama is complete.
- ❗ Shooting may be interrupted if the camera is panned too quickly or too slowly. Panning the camera in a direction other than that shown cancels shooting.
- ❗ The desired results may not be achieved with moving subjects, subjects close to the camera, unvarying subjects such as the sky or a field of grass, subjects that are in constant motion, such as waves and waterfalls, or subjects that undergo marked changes in brightness. Panoramas may be blurred if the subject is poorly lit.

For Best Results

For best results, move the camera in a small circle at a steady speed, keeping the camera horizontal and being careful only to pan in the direction shown by the guides. If the desired results are not achieved, try panning at a different speed.

Intelligent Face Detection

Intelligent Face Detection sets focus and exposure for human faces anywhere in the frame, preventing the camera from focusing on the background in group portraits. Choose for shots that emphasize portrait subjects.

To use Intelligent Face Detection, press **MENU/OK** to display the shooting menu and select **ON** for **FACE DETECTION** (📖 73). Faces can be detected with the camera in vertical or horizontal orientation; if a face is detected, it will be indicated by a green border. If there is more than one face in the frame, the camera will select the face closest to the center; other faces are indicated by white borders.

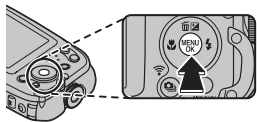

- ① In some modes, the camera may set exposure for the frame as a whole rather than the portrait subject.
- ① If the subject moves as the shutter button is pressed, their face may not be in the area indicated by the green border when the picture is taken.

Focus Lock

To compose photographs with off-center subjects:

1 Focus: Position the subject in the focus frame (⌘[+]) and press the shutter button halfway to lock focus and exposure. Focus and exposure will remain locked while the shutter button is pressed halfway (AF/AE lock).



2 Recompose: Keep the button pressed halfway.



3 Shoot: Press the button all the way down.





 **Autofocus**

Although the camera boasts a high-precision autofocus system, it may be unable to focus on the subjects listed below. If the camera is unable to focus, focus on another subject at the same distance and use focus lock to recompose the photograph.

- Very shiny subjects such as mirrors or car bodies.
- Fast-moving subjects.
- Subjects photographed through a window or other reflective object.
- Dark subjects and subjects that absorb rather than reflect light, such as hair or fur.
- Insubstantial subjects, such as smoke or flame.
- Subjects that show little contrast with the background (for example, subjects in clothing that is the same color as the background).
- Subjects positioned in front of or behind a high-contrast object that is also in the focus frame (for example, a subject photographed against a backdrop of highly contrasting elements).

Exposure Compensation

To adjust exposure compensation when photographing very bright, very dark, or high-contrast subjects, press the selector up () or down () selector. Press the selector up or down to choose an exposure compensation value and then press **MENU/OK**.

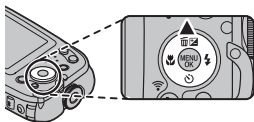

*Choose positive (+) values
to increase exposure*





*Choose negative (-) values
to reduce exposure*



- ❖ A  icon and exposure indicator are displayed at settings other than ± 0 . Exposure compensation is not reset when the camera is turned off; to restore normal exposure control, choose a value of ± 0 .
- ❖ Turn the flash off when using exposure compensation.
- ❖ Exposure compensation is available only when **P** (PROGRAM AE) is selected for shooting mode.

Macro Mode (Close-ups)

For close-ups, press the selector left () and select . When macro mode is in effect, the camera focuses on subjects near the center of the frame. Use the zoom buttons to compose pictures ( 21).

To exit macro mode, press the selector left () and select  OFF.

 Use of a tripod is recommended to prevent blur caused by camera shake.

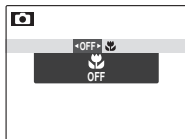
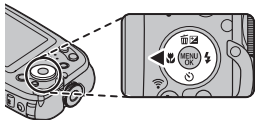





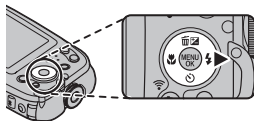

⚡ Using the Flash (Intelligent Flash)

When the flash is used, the camera's *Intelligent Flash* system instantly analyzes the scene based on such factors as the brightness of the subject, its position in the frame, and its distance from the camera. Flash output and sensitivity are adjusted to ensure that the main subject is correctly exposed while preserving the effects of ambient background lighting, even in dimly-lit indoor scenes. Use the flash when lighting is poor, for example when shooting at night or indoors under low light.





Press the selector right (⚡) and choose from the following flash modes:



Option	Description
AUTO /  (AUTO FLASH)	The flash fires when required. Recommended in most situations.
 /  (FORCED FLASH)	The flash fires whenever a picture is taken. Use for backlit subjects or for natural coloration when shooting in bright light.
 (SUPPRESSED FLASH)	The flash does not fire even when the subject is poorly lit. Use of a tripod is recommended.
S4 /  (SLOW SYNCHRO)	Capture both the main subject and the background under low light (note that brightly lit scenes may be overexposed).

- ◆ If the flash will fire,  will be displayed when the shutter button is pressed halfway (if the icon blinks yellow, the flash charging; wait for charging to complete before shooting). At slow shutter speeds,  will appear in the display to warn that pictures may be blurred; use of a tripod is recommended.
- ◆ The flash may fire several times with each shot. Do not move the camera until shooting is complete.
- ◆ The flash may cause vignetting.

Red-Eye Removal

When Intelligent Face Detection ( 33) and red-eye removal ( 79) are on, red-eye removal is available in auto (; RED EYE REDUCTION), flash on (; FORCED FLASH), and slow sync (; RED EYE & SLOW) modes. Red-eye removal minimizes “*red-eye*” caused when light from the flash is reflected from the subject’s retinas as shown in the illustration at right.



Using the Self-Timer

To use the self-timer, press the selector down (⏻) and choose from the following options:

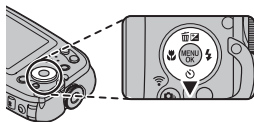
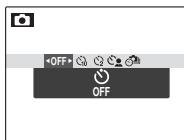

Option	Description
⏻ (OFF)	Self-timer off.
⏻ (10 SEC)	The shutter is released ten seconds after the shutter button is pressed. Use for self-portraits. The self-timer lamp on the front of the camera blinks while the timer counts down.
⏻ (2 SEC)	The shutter is released two seconds after the shutter button is pressed. Use to reduce blur caused by the camera moving when the shutter-release button is pressed. The self-timer lamp will blink as the timer counts down.
⏻ (GROUP TIMER)	The camera will start the timer when it detects the selected number of portrait subjects. Press the selector up to choose the number of subjects. ◆ To stop the timer before the picture is taken, press DISP/BACK .
⏻ (INTERVAL SHOOTING)	Shoots photos automatically at set intervals.

Interval shooting

You can automatically shoot at fixed intervals.

1 Press  (▼), and then select  **INTERVAL SHOOTING**.

2 Press **MENU/OK** to display the Interval Shooting settings screen.

3 Set the interval and the shooting duration.

Select the items by pressing ◀ or ▶, and then set the time by pressing ▲ or ▼.

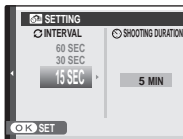

INTERVAL: Set the interval time.

SHOOTING DURATION: Set the time to stop shooting.

4 Press **MENU/OK**.

Interval shooting is set.

5 Focus and shoot.

Press the shutter button the rest of the way down to start interval shooting. A photo is automatically taken at the interval time, and interval shooting finishes when the camera reaches the set shooting duration time.

- ◆ If you press the shutter button before shooting ends, interval shooting stops.
- ◆ The LCD monitor turns off and the self-timer lamp flashes during interval shooting. The LCD monitor turns on three seconds before shooting starts.
- ◆ Only the first frame is displayed when playing back photos taken by interval shooting (📖 44).
- ① Interval shooting may end suddenly if the battery runs out. Check the amount of battery remaining.
- ① Interval shooting may end suddenly if there is not enough free space on the memory card. Check the amount of free space on the memory card.
- ① Depending on shooting settings or status, settings may not be applied or interval shooting may not be possible.
- ① You can only use the **ON/OFF** button,  button, **DISP/BACK** button, and shutter button during interval shooting.
- ① Continuous shooting mode is not available in interval shooting.

The Burst Mode Button

Press the burst mode button to toggle between single-frame shooting and the burst mode selected using the Continuous option in the shooting menu (73).

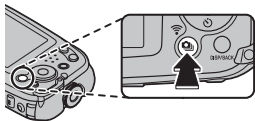

- ◆ When a burst mode is selected, the camera displays the icon for the selected mode. No icon is displayed in single-frame mode.

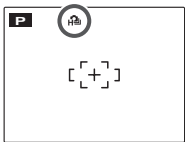

More on Playback

Playback Options

To view the most recent picture in the LCD monitor, press the  button.

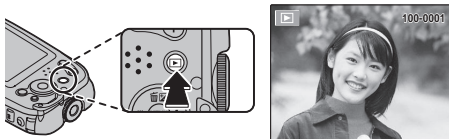

Press the selector right to view pictures in the order recorded, left to view pictures in reverse order. Keep the selector pressed to scroll rapidly to the desired frame.

- ◆ Pictures taken using other cameras are indicated by a  ("gift image") icon during playback.

Continuous Shooting

In the case of pictures taken in continuous shooting mode, only the first frame of each series will be displayed. Press the selector down to view the other pictures in the series.

- ◆ Pictures taken in continuous shooting mode have file names that start with "S". (e.g. S0010001.JPG)

★ Favorites: Rating Pictures

To rate the picture currently displayed in full-frame playback, press **DISP/BACK** and press the selector up and down to select from zero to five stars.

Playback Zoom

Press **T** to zoom in on pictures displayed in single-frame playback; press **W** to zoom out. When the picture is zoomed in, the selector can be used to view areas of the image not currently visible in the display.

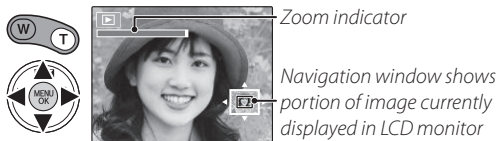

Press **DISP/BACK** to exit zoom.

- ◆ The maximum zoom ratio varies with image size. Playback zoom is not available with cropped or resized copies saved at a size of **640** or smaller.

Multi-Frame Playback

Pressing **W** when a picture is shown full-frame in the LCD monitor displays the current image with previous and following images in the background. Press **W** to increase the number of images displayed to two, nine, or one hundred, **T** to view fewer images.

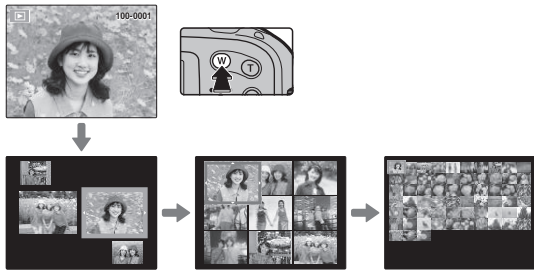

When two or more images are displayed, use the selector to highlight images and press **MENU/OK** to view the highlighted image full frame. In the nine- and hundred-frame displays, use the selector to view more pictures.

Deleting Pictures

To delete individual pictures, multiple selected pictures, or all pictures, press the selector up () , and choose from the options below. *Note that deleted pictures can not be recovered. Copy important pictures to a computer or other storage device before proceeding.*

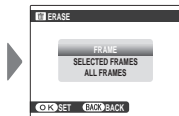

Option	Description
FRAME	Press the selector left or right to scroll through pictures and press MENU/OK to delete the current picture (a confirmation dialog is not displayed).
SELECTED FRAMES	Highlight pictures and press MENU/OK to select or deselect (pictures that are protected or in a print order are shown by ). When the operation is complete, press DISP/BACK to display a confirmation dialog, then highlight OK and press MENU/OK to delete the selected pictures.
ALL FRAMES	A confirmation dialog will be displayed; highlight OK and press MENU/OK to delete all unprotected pictures (if a memory card is inserted, only the pictures on the memory card will be affected; the pictures in internal memory are only deleted if no memory card is inserted). Pressing DISP/BACK cancels deletion; note that any pictures deleted before the button was pressed can not be recovered.











- ❖ Protected pictures can not be deleted. Remove protection from any pictures you wish to delete ( 80).
- ❖ Pictures can also be deleted by  **ERASE** from playback menu.
- ❖ If a message appears stating that the selected images are part of a DPOF print order, press **MENU/OK** to delete the pictures.

Image Search





Search for pictures.

- 1 Select  **IMAGE SEARCH** in the playback menu ( 76), highlight one of the following search criteria, and press **MENU/OK**:
 - **BY DATE**: Search by date.
 - **BY FACE**: Find all pictures containing faces.
 - **BY ★ FAVORITES**: Search by rating.
 - **BY SCENE**: Find all pictures that match a selected scene.
 - **BY TYPE OF DATA**: Find all still pictures or all movies.
 - **BY UPLOAD MARK**: Find all pictures selected for upload to a specified destination.
- 2 Select a search condition. Only pictures that match the search condition will be displayed. To delete or protect selected pictures or to view the search results in a slide show, press **MENU/OK** and choose  **ERASE** ( 47),  **PROTECT** ( 80), or  **SLIDE SHOW** ( 79).

PhotoBook Assist

Create books from your favorite photos.

Creating a PhotoBook

- 1 Select **NEW BOOK** for  **PHOTOBOOK ASSIST** in the playback menu ( 82) and choose from the following options:
 - **SELECT FROM ALL:** Choose from all available pictures.
 - **SELECT BY IMAGE SEARCH:** Choose from pictures matching selected search conditions ( 48).
 - ◆ Neither photographs  or smaller nor movies can be selected for photobooks.
 - 2 Scroll through the images and press the selector up to select or deselect. To display the current image on the cover, press the selector down. Press **MENU/OK** to exit when the book is complete.
 - ◆ The first picture selected becomes the cover image. Press the selector down to select a different image for the cover.
 - 3 Select **COMPLETE PHOTOBOOK** (to select all photos or all photos matching the specified search conditions for the book, choose **SELECT ALL**). The new book will be added to the list in the photobook assist menu.
- ⓘ Books can contain up to 300 pictures.
- ⓘ Books that contain no photos are automatically deleted.

Viewing Photobooks

Highlight a book in the photobook assist menu and press **MENU/OK** to display the book, then press the selector left or right to scroll through the pictures.

Editing and Deleting Photobooks

Display the photobook and press **MENU/OK**. The following options will be displayed; select the desired option and follow the on-screen instructions.

- **EDIT:** Edit the book as described in “Creating a PhotoBook” ( 49).
- **ERASE:** Delete the book.

Viewing Panoramas

If you press the selector down when a panorama is displayed full frame, the camera will play back the picture from left to right or from bottom to top. To pause playback, press the selector down; press the selector down again to resume. To exit to full-frame playback, press the selector up while panorama playback is in progress. Once displayed in full-frame playback, panoramas can be zoomed in or out using the zoom control or deleted by pressing the selector up (🗑).

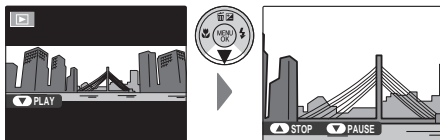

Wireless Networks

Using Wireless Networks

You can connect the camera with a smartphone or a PC. For information on using wireless networks, visit <http://fujifilm-dsc.com/wifi/>.

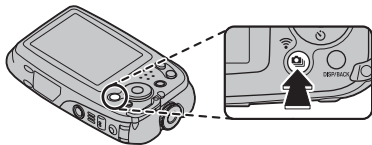

Connecting with smartphones

Press the **Wi-Fi** button of the camera during playback to connect to smartphones via a wireless network.

When connecting to smartphones, you can use the following functions:

- Taking pictures using smartphones
- Uploading pictures to smartphones
- Browsing and downloading the pictures on the camera using smartphones
- Downloading location data from smartphones

Before proceeding, download the free **FUJIFILM Camera Remote** app and install it on your smartphone.

This option can also be enabled by  **WIRELESS COMMUNICATION** from shooting or playback menu.

Saving Pictures to a Computer

Press and hold the **Wi-Fi** button during playback to save pictures to a computer over a wireless network. Before proceeding, install the free FUJIFILM PC AutoSave application to the destination computer and adjust settings as desired. This option can also be enabled by  **PC AUTO SAVE** from playback menu.

Movies





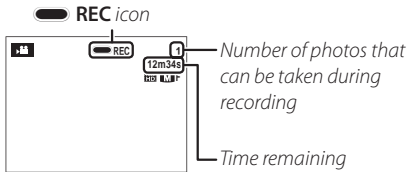
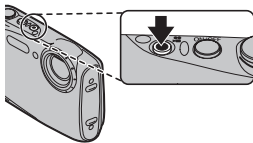

Recording Movies

Press  to shoot a movie. During recording, the following indicators will be displayed and sound will be recorded via the built-in microphone (be careful not to cover the microphone during recording).



To end recording, press the  button again. Recording ends automatically when the movie reaches maximum length or memory is full.

Automatic Scene Selection

In  mode, the camera selects the scene according to shooting conditions and the type of subject:  (portraits),  (poorly-lit landscapes),  (poorly-lit portraits),  (landscapes),  (close-ups), or  (other subjects).



Scene icon



Taking Photographs During Recording

Press the shutter button to take a photograph during recording.

- ◆ The photo is saved separately from the movie and does not appear as part of the movie.
- ① Photos can not be taken while a high-speed movie is being recorded.
- ① The number of photos that can be taken is limited.

DIGITAL IMAGE STABILIZER

You can correct camera vibrations that occur when shooting movies to shoot images with only minor vibrations using the  **DIGITAL IMAGE STABILIZER** in the setup menu (📖 89).

- ◆ Zoom can be adjusted while recording is in progress. The type of zoom can be selected using the  **MOVIE ZOOM TYPE** option in the setup menu (📖 91).
- ◆ If the subject is poorly lit, the AF-assist lamp may light to assist the focus operation. To turn the AF-assist lamp off, select **OFF** for  **AF ILLUMINATOR** (📖 91).
- ◆ Focus, exposure and white balance are adjusted automatically throughout recording (the focus mode can be selected using the  **MOVIE AF MODE** option in the shooting menu; 📖 74). The color and brightness of the image may vary from that displayed before recording begins.
- ◆ Sounds made by the camera may be recorded.
- ① Do not open the battery-chamber cover during shooting or saving a movie on a memory card. Failure to observe this precaution could prevent the movie from being played back.
- ① Vertical or horizontal streaks may appear in movies containing very bright subjects. This is normal and does not indicate a malfunction.

- ❗ The temperature of the camera may rise if it is used to record movies for an extended period or if the ambient temperature is high. This is normal and does not indicate a malfunction.
- ❗ The mode selected may vary with shooting conditions.

Viewing Movies

During playback, movies are displayed in the LCD monitor as shown at right. The following operations can be performed while a movie is displayed:

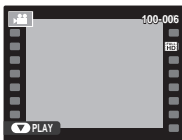

Option	Description
Start/pause playback	Press the selector down to start playback. Press again to pause.
End playback/delete	Press the selector up to end playback. If playback is not in progress, pressing the selector up will delete the movie.
Adjust speed	Press the selector left or right to adjust playback speed during playback.
Adjust volume	Press MENU/OK to pause playback and display volume controls. Press the selector up or down to adjust the volume and press MENU/OK to exit. Volume can also be adjusted from the setup menu.

Playback Speed

Press the selector left or right to adjust playback speed. Speed is shown by the number of arrows (▶ or ◀).

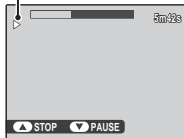

ⓘ Do not cover the speaker during playback.

Connections

Viewing Pictures on High-Definition TVs

The camera can be connected to High-Definition (HD) devices using an HDMI cable (available separately from third-party sources).

- 1 Turn the camera off and connect the HDMI cable as shown below.

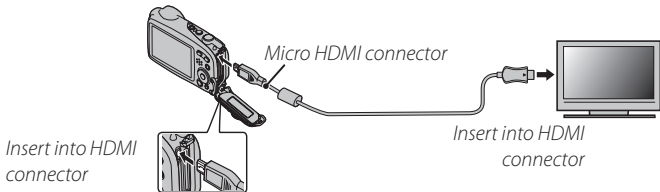

- ① Use an HDMI cable no more than 1.5 m (4.9 ft.) long.
 - ① When connecting cables, be sure the connectors are fully inserted.
 - ◆ When an HDMI cable is connected, pictures and sound are played back on the TV.
- 2 Tune the television to the HDMI input channel. See the documentation supplied with the television for details.
- 3 Press the  button for about a second to turn the camera on. The camera monitor turns off and pictures and movies are played back on the TV. Note that the camera volume controls have no effect on sounds played on the TV; use the television volume controls to adjust the volume.
 - ◆ The USB cable can not be used while an HDMI cable is connected.
 - ◆ Some televisions may briefly display a black screen when movie playback begins.

Printing Pictures via USB

If the printer supports PictBridge, the camera can be connected directly to the printer as shown below and pictures can be printed without first being copied to a computer. Note that depending on the printer, not all the functions described below may be supported.



- 1 Connect the USB cable as shown and turn the printer on.

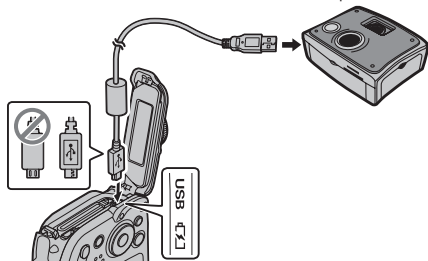

- 2 Turn the camera on.
- 3 Press the selector left or right to display a picture you wish to print.
- 4 Press the selector up or down to choose the number of copies (up to 99).
- 5 Repeat steps 3–4 to select additional pictures. Press **MENU/OK** to display a confirmation dialog when settings are complete.

6 Press **MENU/OK** to start printing. Printing can be interrupted by pressing **DISP/BACK**, but note that some printers may not respond immediately. If the printer stops before printing is complete, turn the camera off and then on again.

7 After confirming that **PRINTING** has cleared from the camera display, turn the camera off and disconnect the USB cable.

- ◆ Pictures can be printed from internal memory or a memory card that has been formatted in the camera.
- ◆ If no pictures are selected, the camera will print one copy of the current picture.
- ◆ Page size, print quality, and border selections are made using the printer.

Printing the Date of Recording

To print the date of recording on pictures, press **DISP/BACK** in the PictBridge display and select **PRINT WITH DATE**  in the PictBridge menu (to print pictures without the date of recording, select **PRINT WITHOUT DATE**).

Printing the DPOF Print Order

The  **PRINT ORDER (DPOF)** option in the playback menu can be used to create a digital “print order” for PictBridge-compatible printers (📄 93) or devices that support DPOF.

DPOF

DPOF (Digital Print Order Format) is a standard that allows pictures to be printed from “print orders” stored in internal memory or on a memory card. The information in the order includes the pictures to be printed and the number of copies of each picture.



- 1 Select playback mode and press **MENU/OK** to display the playback menu.
- 2 Highlight  **PRINT ORDER (DPOF)** and press **MENU/OK**.
- 3 Highlight one of the following options and press **MENU/OK**:
 - **WITH DATE** : Print the date of recording on pictures.
 - **WITHOUT DATE**: Do not print the date of recording on pictures.

 Some printers do not support date printing. See the printer manual for details.
- 4 Press the selector left or right to display a picture you wish to add to or remove from the print order.

- 5** Press the selector up or down to choose the number of copies (up to 99). To remove a picture from the print order, press the selector down until the number of copies is zero.
- 6** Repeat Steps 4–5 to complete the print order and press **MENU/OK** when settings are complete.
- 7** A confirmation dialog will be displayed. Press **MENU/OK** to save the print order.

 - ◆ Remove the memory card to create or modify a print order for the pictures in internal memory.
 - ◆ Print orders can contain a maximum of 999 pictures.
 - ◆ If a memory card is inserted containing a print order created by another camera, a message will be displayed. Create a new print order as described above.

Viewing Pictures on a Computer

Copying Pictures to a Computer

Windows users can use **MyFinePix Studio** to copy pictures to a computer, where they can be stored, viewed, organized, and printed.

Mac (Macintosh) users can use a standard application in Mac OS such as Image Capture to import pictures or movies to Mac. Proceed to “Connecting the Camera” (📖 67).

Windows: Downloading and Installing MyFinePix Studio to a Computer

If CD-ROM is not included in the Supplied Accessories (📖 1), download **MyFinePix Studio** from the following website:

<http://fujifilm-dsc.com/mfs/>.

Double-click the downloaded file “**MFPS_Setup.EXE**” to start the installer, and follow the on-screen instructions to install MyFinePix Studio.

When installation is complete, proceed to “Connecting the Camera” (📖 67).

Windows: Installing MyFinePix Studio

If CD-ROM is included in the Supplied Accessories, install **MyFinePix Studio** from the supplied CD-ROM.

1 Confirm that the computer meets the following system requirements:

	Windows 8/Windows 7 (SP 1)/ Windows Vista (SP 2)¹	Windows XP (SP 3)¹
CPU	3 GHz Pentium 4 or better (2.4 GHz Core 2 Duo or better) ²	2 GHz Pentium 4 or better (2.4 GHz Core 2 Duo or better) ²
RAM	1 GB or more	512 MB or more (1 GB or more) ²
Free disk space	2 GB or more	
GPU	Supports DirectX 9 or later (recommended)	Supports DirectX 7 or later (required; performance not guaranteed with other GPUs)
Video	1,024 × 768 pixels or more with 24-bit color or better	
Other	<ul style="list-style-type: none"> • Built-in USB port recommended. Operation is not guaranteed with other USB ports. • .NET Framework 3.5 Service Pack 1 required when uploading images or using Map Viewer. • Internet connection (broadband recommended) required to install .NET Framework (if necessary), to use auto update feature, and when performing such tasks as sharing pictures on-line or via e-mail. 	

1 Other versions of Windows are not supported. Only pre-installed operating systems are supported; operation is not guaranteed on home-built computers or computers that have been upgraded from earlier versions of Windows.

2 Recommended when displaying HD movies.

- 2 Start the computer. Log in to an account with administrator privileges before proceeding.
- 3 Exit any applications that may be running and insert the installer CD in a CD-ROM drive.

Windows 8/Windows 7/Windows Vista

If an AutoPlay dialog is displayed, click **SETUP.EXE**. A “User Account Control” dialog will then be displayed; click **Yes** (Windows 8/Windows 7) or **Allow** (Windows Vista).

The installer will start automatically; click **Install MyFinePix Studio** and follow the on-screen instructions to install MyFinePix Studio.

If the Installer Does Not Start Automatically (Windows 7/Windows Vista/Windows XP)

If the installer does not start automatically, select **Computer** or **My Computer** from the Start menu, then double-click the **FINEPIX** CD icon to open the FINEPIX CD window and double-click **setup** or **SETUP.EXE**.

If the Installer Does Not Start Automatically (Windows 8)

- 1 Select **Desktop** on the Start screen.
- 2 Select **File Explorer** on the taskbar.
- 3 Select **Computer** in the navigation pane.
- 4 Double-click the drive icon inserting the **FINEPIX** CD and follow the on-screen instructions to install.

- 4 If prompted to install Windows Media Player or DirectX, follow the on-screen instructions to complete installation.
- 5 Remove the installer CD from the CD-ROM drive when installation is complete. Store the installer CD in a dry location out of direct sunlight in case you need to re-install the software.

Installation is now complete. Proceed to “Connecting the Camera” (📖 67).

Windows: Uninstalling MyFinePix Studio

Only uninstall the software when it is no longer required or before beginning reinstallation.

- 1 After quitting the software and disconnecting the camera, open the control panel and use “Programs and Features” (Windows 8/Windows 7/Windows Vista) or “Add or Remove Programs” (Windows XP) to uninstall MyFinePix Studio.
- 2 Under Windows, one or more confirmation dialogs may be displayed; read the contents carefully before clicking **OK**.

Connecting the Camera

- 1** If the pictures you wish to copy are stored on a memory card, insert the card into the camera.
 - ◆ Windows users may require the Windows CD when starting the software for the first time.
 - Ⓢ Loss of power during transfer could result in loss of data or damage to internal memory or the memory card. Charge the battery before connecting the camera.
- 2** Turn the camera off and connect the supplied USB cable as shown, making sure the connectors are fully inserted. Connect the camera directly to the computer; do not use a USB hub or keyboard.

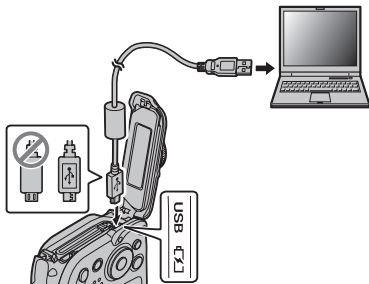

- 3** Press the  button for about a second to turn the camera on and follow the on-screen instructions to copy pictures to the computer. To exit without copying pictures, click **Cancel**.

 **Importing pictures or movies to Mac (Macintosh)**

Use a standard application in Mac OS such as Image Capture to import pictures or movies to Mac.

- ① If a memory card containing a large number of images is inserted, there may be a delay before the software starts and you may be unable to import or save images. Use a memory card reader to transfer pictures.
- ① Make sure that the computer does not display a message stating that copying is in progress before turning the camera off or disconnecting the USB cable. Failure to observe this precaution could result in loss of data or damage to internal memory or the memory card.
- ① Disconnect the camera before inserting or removing memory cards.
- ① The user bears all applicable fees charged by the phone company or Internet service provider when using services that require an Internet connection.

Menus

Using the Menus: Shooting Mode

Using the Shooting Menu

To display the shooting menu, press **MENU/OK** in shooting mode. Highlight items and press the selector right to view options, then highlight an option and press **MENU/OK**. Press **DISP/BACK** to exit when settings are complete. The options available vary with the shooting mode selected.

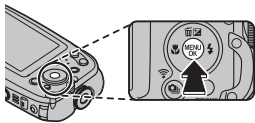

Shooting Menu Options

SHOOTING MODE

(default:  AUTO)

Choose a shooting mode according to the type of subject ( 25).

ISO

Control the camera's sensitivity to light. Higher values can reduce blur; note, however, that mottling may appear in pictures taken at high sensitivities.



Option	Description
AUTO (1600) / AUTO (800) / AUTO (400)	Sensitivity is adjusted automatically in response to shooting conditions, but will not be raised above the value in parentheses.
6400 / 3200 / 1600 / 800 / 400 / 200 / 100	Sensitivity is set to the specified value, which is shown in the display.

 **IMAGE SIZE**
(default: **L** 4:3)

Choose the image size (large, medium, or small) and aspect ratio (4 : 3, 3 : 2, 16 : 9, or 1 : 1) at which pictures are recorded. Large pictures can be printed at large sizes with no drop in quality, while small pictures require less memory, allowing more pictures to be recorded.



 When pictures are recorded to internal memory, the default value is set to **S** 4:3.

 **Size Versus Aspect Ratio**
Size

Option	Prints at sizes up to
L	34×25 cm (13.5×10 in.)
M	24×18 cm (9.5×7 in.)
S	17×13 cm (7×5 in.)

Aspect ratio

4:3: Pictures have the same proportions as the camera display.

3:2: Pictures have the same proportions as a frame of 35 mm film.

16:9: Suited for display on High Definition (HD) devices.

1:1: Pictures are square.

IMAGE QUALITY(default: **N**)

Choose how much image files are compressed.

Option	Description
FINE	Low compression. Select for higher image quality.
NORMAL	High compression. Select this option to store more pictures.

FINEPIX COLOR(default: **STD**)







Enhance contrast and color saturation or take pictures in black and white.

Option	Description
STD STANDARD	Standard contrast and saturation. Recommended in most situations.
CHROME	Vivid contrast and color. Choose for vivid shots of flowers or enhanced greens and blues in landscapes.
B&W	Take pictures in black and white.
SEPIA	Take pictures in sepia.

- Settings other than **STD STANDARD** are shown by an icon in the LCD monitor.
- Depending on the subject, the effects of **CHROME** may not be visible in the LCD monitor.

WB WHITE BALANCE**(default: AUTO)**







For natural colors, choose a setting that matches the light source.



Option	Description
AUTO	White balance adjusted automatically.
	For subjects in direct sunlight.
	For subjects in the shade.
	Use under "daylight" fluorescent lights.
	Use under "warm white" fluorescent lights.
	Use under "cool white" fluorescent lights.
	Use under incandescent lighting.
	For underwater photography.

- ◆ Results vary with shooting conditions. Play pictures back after shooting to check colors in the LCD monitor.

CONTINUOUS(default: )

Capture motion in a series of pictures.

Option	Description
 CONTINUOUS	The camera takes pictures while the shutter button is pressed.
 CONTINUOUS	
 CONTINUOUS	
 CONTINUOUS	
 FINAL	The camera shoots while the shutter button is pressed and records the last several pictures.
 FINAL	
 FINAL	



- See page 110 for the frame rate and number of pictures taken in each mode.
- Focus and exposure are determined by the first frame in each series.
- In  mode,  **IMAGE SIZE** is fixed at  **16 : 9**.
- The flash turns off automatically.
- Frame rate varies with shutter speed.
- The number of pictures that can be recorded depends on the memory available.

FACE DETECTION

Choose whether the camera automatically detects and sets focus and exposure for human portrait subjects ( 33).

AF MODE



This option controls how the camera selects the focus area. Regardless of the option selected, the camera will focus on the subject in the center of the LCD monitor when macro mode is on.

Option	Description
 CENTER	The camera focuses on the subject in the center of the frame.
 MULTI	When the shutter button is pressed halfway, the camera detects high-contrast subjects near the center of the frame and selects the focus area automatically.
 TRACKING	Position the subject in the center focus area and press the selector left. Focus will track the subject as it moves through the frame.

◆ Note that in  mode, the camera focuses continuously, increasing the drain on the battery, and that the sound of the camera focusing may be audible.

MOVIE AF MODE

This option controls how the camera selects the focus area for movies.

Option	Description
 CENTER	The camera focuses on the subject in the center of the frame.
 CONTINUOUS	The camera continuously adjusts focus to reflect changes in the distance to subjects near the center of the frame.

◆ Note that in  mode, the camera focuses continuously, increasing the drain on the battery, and that the sound of the camera focusing may be audible.

MOVIE MODE(default: **FULL HD**)

Choose a frame size for movies.

Option	Description
FULL HD 1920 × 1080 (60fps)	Full HD (High Definition).
FULL HD 1920 × 1080 (30fps)	
HD 1280 × 720 (60fps)	High Definition.
640 640 × 480 (30fps)	Standard definition.
HS 640 × 480 (120 fps)	High speed movie.
HS 320 × 240 (240 fps)	ⓘ Sound is not recorded, and focus, exposure, and white balance are not adjusted automatically.
HS 160 × 120 (320 fps)	ⓘ Zoom can not be adjusted.

ⓘ When pictures are recorded to internal memory, the default value is set to **640 640 × 480**.

ⓘ No face is detected when shooting in **HD 1920 × 1080** (60fps).

WIRELESS COMMUNICATION

When connecting to smartphones, you can use the following functions:

- Taking pictures using smartphones
- Uploading pictures to smartphones
- Browsing and downloading the pictures on the camera using smartphones
- Downloading location data from smartphones

For information on using wireless networks, visit <http://fujifilm-dsc.com/wifi/>.

Using the Menus: Playback Mode

Using the Playback Menu

To display the playback menu, press **MENU/OK** in playback mode. Highlight items and press the selector right to view options, then highlight an option and press **MENU/OK**. Press **DISP/BACK** to exit when settings are complete.

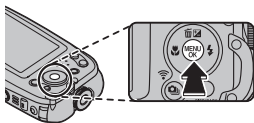

Playback Menu Options

WIRELESS COMMUNICATION

When connecting to smartphones, you can use the following functions:

- Taking pictures using smartphones
- Uploading pictures to smartphones
- Browsing and downloading the pictures on the camera using smartphones
- Downloading location data from smartphones

For information on using wireless networks, visit <http://fujifilm-dsc.com/wifi/>.

PC AUTO SAVE

Upload pictures to a computer over a wireless network. For information on using wireless networks, visit <http://fujifilm-dsc.com/wifi/>.

IMAGE SEARCH

Search for pictures ( 48).

ERASE

Delete all or selected pictures ( 47).

 **MOVIE EDIT**

Edit movies.

ⓘ Do not turn the camera off while editing movies.

MOVIE TRIMMING

Remove opening or ending footage to create an edited copy of the current movie.

- 1 Display the desired movie.
- 2 Select  **MOVIE EDIT** > **MOVIE TRIMMING** in the playback menu. To remove footage from the start of the copy, proceed to Step 3; otherwise, proceed to Step 4.
- 3 Press the selector down to begin playback and press it down again when the new opening frame is reached.
- 4 Press **MENU/OK**. To remove footage from the end of the copy, proceed to Step 5; otherwise, proceed to Step 6.
- 5 Press the selector down to begin playback and press it down again when the new closing frame is reached.
- 6 Press **MENU/OK** to save the copy.

MOVIE JOIN



Add existing footage to the end of the current movie to create an edited copy.

- 1 Display the desired movie.
 - 2 Select  **MOVIE EDIT** > **MOVIE JOIN** in the playback menu.
 - 3 Press the selector left or right to highlight a movie.
 - 4 Press **MENU/OK** to add the highlighted footage to the end of the current movie and save the resulting copy, or press **DISP/BACK** to exit without creating a copy.
- ⓘ Both movies must have been recorded at the same frame size and frame rate.

MARK FOR UPLOAD TO

Select pictures for upload to YouTube, Facebook or MyFinePix.com using MyFinePix Studio (Windows only).

■ Selecting Pictures for Upload

- 1 Select **YouTube** to choose movies for upload to YouTube, **Facebook** to choose photos and movies for upload to Facebook, or **MyFinePix.com** to choose photos for upload to MyFinePix.com.
 - 2 Press the selector left or right to display pictures and press **MENU/OK** to select or deselect. Press **DISP/BACK** to exit when all the desired pictures are selected.
- ◆ Only movies can be selected for upload to YouTube.
 - ◆ Only photos can be selected for upload to MyFinePix.com.
 - ◆ During playback, selected pictures are indicated by  **YouTube**,  **Facebook** or  **MyFinePix.com** icons.

■ RESET ALL: Deselecting All Pictures

Choose **RESET ALL** to deselect all pictures. If the number of pictures affected is very large, a message will be displayed while the operation is in progress. Press **DISP/BACK** to exit before the operation is complete.

■ Uploading Pictures (Windows Only)

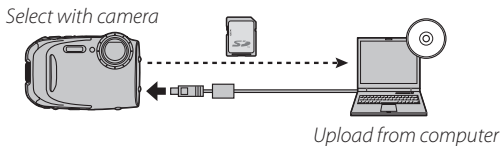

Selected pictures can be uploaded using the **YouTube/Facebook/MyFinePix.com Upload** option in MyFinePix Studio.



For information on installing MyFinePix Studio and connecting the camera to a computer, see "Viewing Pictures on a Computer" (📖 63).

SLIDE SHOW

View pictures in an automated slide show. Choose the type of show and press **MENU/OK** to start. Press **DISP/BACK** at any time during the show to view on-screen help. The show can be ended at any time by pressing **MENU/OK**.





Option	Description
NORMAL	Press selector left or right to go back or skip ahead one frame. Select FADE-IN
FADE-IN	for fade transitions between frames.
NORMAL 	As above, except that camera automatically zooms in on faces selected with
FADE-IN 	Intelligent Face detection.

 The camera will not turn off automatically while a slide show is in progress.

RED EYE REMOVAL

If the current picture is marked with a  icon to indicate that it was taken with Intelligent Face Detection, this option can be used to remove red-eye. The camera will analyze the image; if red-eye is detected, the image will be processed to create a copy with reduced red-eye.

- 1 Display the desired picture.
- 2 Select  **RED EYE REMOVAL** in the playback menu.
- 3 Press **MENU/OK**.

-  Red eye may not be removed if the camera is unable to detect a face or the face is in profile. Results may differ depending on the scene. Red eye can not be removed from pictures that have already been processed using red-eye removal or pictures created with other devices.
-  The amount of time needed to process the image varies with the number of faces detected.
-  Copies created with  **RED EYE REMOVAL** are indicated by a  icon during playback.

PROTECT

Protect pictures from accidental deletion.

- 1 Select  **PROTECT** in the playback menu.
 - 2 Highlight one of the following options and press **MENU/OK**:
 - **FRAME**: Protect selected pictures. Press the selector left or right to view pictures and press **MENU/OK** to select or deselect. Press **DISP/BACK** when the operation is complete.
 - **SET ALL**: Protect all pictures.
 - **RESET ALL**: Remove protection from all pictures.
- ⓘ Protected pictures will be deleted when the memory card or internal memory is formatted (see 86).



CROP

Create a cropped copy of the current picture.

- 1 Display the desired picture.
 - 2 Select  **CROP** in the playback menu.
 - 3 Use the zoom buttons to zoom in and out and use the selector to scroll the picture until the desired portion is displayed.
 - 4 Press **MENU/OK** to display a confirmation dialog.
 - 5 Press **MENU/OK** again to save the cropped copy to a separate file.
- ◆ Larger crops produce larger copies. If the size of the final copy will be **640**, **YES** will be displayed in yellow.



 **RESIZE**

Create a small copy of the current picture.

- 1 Display the desired picture.
 - 2 Select  **RESIZE** in the playback menu.
 - 3 Highlight a size and press **MENU/OK** to display a confirmation dialog.
 - 4 Press **MENU/OK** to save the resized copy to a separate file.
-  The sizes available vary with the size of the original image.

 **IMAGE ROTATE**

Rotate pictures taken in tall orientation so that they are displayed in tall orientation in the LCD monitor.





- 1 Display the desired picture.
 - 2 Select  **IMAGE ROTATE** in the playback menu.
 - 3 Press the selector down to rotate the picture 90° clockwise, up to rotate it 90° counterclockwise.
 - 4 Press **MENU/OK**. The picture automatically be displayed in the selected orientation whenever it is played back on the camera.
-  Protected pictures can not be rotated. Remove protection before rotating pictures (📖 80).
-  The camera may not be able to rotate pictures created with other devices.

COPY

Copy pictures from internal memory to a memory card.

1 Select  COPY in the playback menu.

2 Highlight one of the following options and press the selector right:

-  INTERNAL MEMORY →  SD CARD: Copy pictures from internal memory to a memory card.
-  SD CARD →  INTERNAL MEMORY: Copy pictures from a memory card to internal memory.

3 Highlight one of the following options and press **MENU/OK**:

- **FRAME**: Copy selected pictures. Press the selector left or right to view pictures and press **MENU/OK** to copy the current picture.
- **ALL FRAMES**: Copy all pictures.

◆ Copying ends when the destination is full.

◆ DPOF print information is not copied ( 61).

PHOTOBOOK ASSIST

Create books from your favorite photos ( 49).

PRINT ORDER (DPOF)

Select pictures for printing on DPOF- and PictBridge-compatible devices ( 61).

DISP ASPECT

Choose how High Definition (HD) devices display pictures with an aspect ratio of 4:3 (this option is available only when an HDMI cable is connected). Select **16:9** to display the image so that it fills the screen with its top and bottom cropped out, **4:3** to display the entire image with black bands at either side.

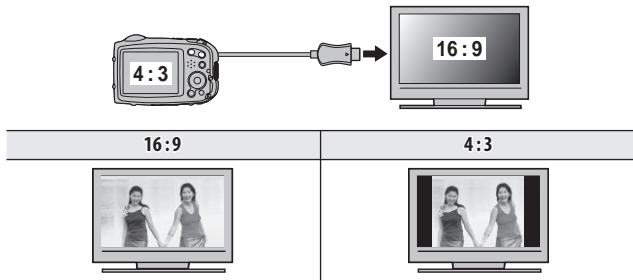

- ◆ Photographs with an aspect ratio of 16:9 are displayed full screen, those with an aspect ratio of 3:2 in a black frame.

The Setup Menu

Using the Setup Menu

1 Display the setup menu.

- 1.1 Press **MENU/OK** to display the menu for the current mode.

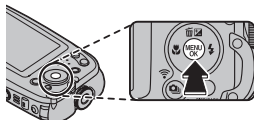

- 1.2 Press the selector left to highlight the tab for the current menu.

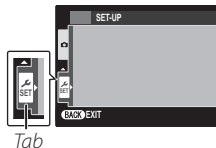

- 1.3 Press the selector down to highlight .

- 1.4 Press the selector right to place the cursor in the setup menu.

2 Adjust settings.

Highlight items and press the selector right to view options, then highlight an option and press **MENU/OK**. Press **DISP/BACK** to exit when settings are complete.



Setup Menu Options** DATE/TIME**





Set the camera clock ( 19).

 TIME DIFFERENCE**(default: )**

Switch the camera clock instantly from your home time zone to the local time at your destination when traveling. To specify the difference between local time and your home time zone:

- 1 Highlight  **LOCAL** and press the selector right.
- 2 Use the selector to choose the time difference between local time and your home time zone in increments of 15 minutes.
- 3 Press **MENU/OK**.



To switch between local time and your home time zone, highlight  **LOCAL** or  **HOME** and press **MENU/OK**.

Option	Description
 HOME	Switch to the time currently selected for  DATE/TIME (see above).
 LOCAL	Switch to local time. If this option is selected,  and the time and date will be displayed in yellow for three seconds each time the camera is turned on.

 言語/LANG.

Choose a language.

 SILENT MODE**(default: OFF)**

Select **ON** to disable the speaker, flash, and AF-assist illuminator in situations in which camera sounds or lights may be unwelcome (note that the flash will still fire in / mode).

RESET

Reset all settings except  **DATE/TIME**,  **TIME DIFFERENCE**, and  **BACKGROUND COLOR** to default values.

- 1 Highlight  **RESET** and press the selector right to display a confirmation dialog.
- 2 Highlight **OK** and press **MENU/OK**.

FORMAT

If a memory card is inserted in the camera, this option will format the memory card. If no memory card is inserted, this option will format internal memory. Select **OK** to begin formatting.

- ⓘ All data—including protected pictures—will be deleted from the memory card or internal memory. Be sure important files have been copied to a computer or other storage device.
- ⓘ Do not open the battery cover during formatting.

IMAGE DISP.

(default: **1.5 SEC**)

Choose how long pictures are displayed in the LCD monitor after shooting.

Option	Description
1.5 SEC	Pictures are displayed for 1.5 seconds (1.5 SEC) or 0.5 seconds (0.5 SEC).
0.5 SEC	Colors may differ slightly from those in the final image.
ZOOM (CONTINUOUS)	Pictures are displayed until the MENU/OK button is pressed.
OFF	Pictures are not displayed after shooting.

- ⓘ **OFF** has no effect in continuous shooting,  **ADVANCED FILTER**,  **PRO LOW-LIGHT** and  **HDR**.

FRAME NO.(default: **CONT.**)

New pictures are stored in image files named using a four-digit file number assigned by adding one to the last file number used. The file number is displayed during playback as shown at right. **FRAME NO.** controls whether file numbering is reset to 0001 when a new memory card is inserted or the current memory card or internal memory is formatted.

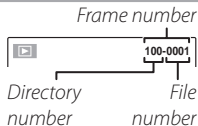

Option	Description
CONTINUOUS	Numbering continues from the last file number used or the first available file number, whichever is higher. Choose this option to reduce the number of pictures with duplicate file names.
RENEW	Numbering is reset to 0001 after formatting or when a new memory card is inserted.

- ◆ If the frame number reaches 999-9999, the shutter release will be disabled (📖 106).
- ◆ Selecting **RESET** (📖 86) sets **FRAME NO.** to **CONTINUOUS** but does not reset the file number.
- ◆ Frame numbers for pictures taken with other cameras may differ.

The Setup Menu

OPERATION VOL. (default:)

Adjust the volume of the sounds produced when camera controls are operated. Choose  OFF (mute) to disable control sounds.

SHUTTER VOLUME (default:)

Adjust the volume of the sounds produced when the shutter is released. Choose  OFF (mute) to disable the shutter sound.

SHUTTER SOUND (default:)

Choose the sound made by the shutter.

PLAYBACK VOLUME (default: **7**)

Adjust the volume for movie playback.

LCD BRIGHTNESS (default: **AUTO**)

Control the brightness of the display.

Option	Description
AUTO	Display brightness is automatically adjusted during shooting in response to ambient lighting conditions. Brightness is not adjusted during playback.
MANUAL	Press the selector up or down to adjust brightness and then press MENU/OK . Choose from values between -5 and +5.

LCD POWER SAVE (default: **ON**)

Choose whether the display automatically dims to save power in shooting mode. This option does not take effect during playback.

Option	Description
POWER SAVE ON	The display dims to save power if no operations are performed for a few seconds. Normal brightness can be restored by pressing the shutter button halfway.
POWER SAVE OFF	Automatic dimming off.

AUTO POWER OFF (default: **2 MIN**)

Choose the length of time before the camera turns off automatically when no operations are performed. Shorter times increase battery life; if **OFF** is selected, the camera must be turned off manually. Note that in some situations the camera turns off automatically even when **OFF** is selected.

IS MODE (default: **CONTINUOUS**)

Choose whether image stabilization is performed at all times when the camera is in shooting mode (**CONTINUOUS**), or only when the shutter button is pressed halfway (**SHOOTING ONLY**). Choose **OFF** to turn image stabilization off when using a tripod.

DIGITAL IMAGE STABILIZER (default: **ON**)

If **ON** is selected, camera vibrations that occur when shooting movies are corrected, allowing you to shoot images with only minor vibrations.

Digital image stabilizer is unavailable when shooting still images.

RED EYE REMOVAL (default: **ON**)

Choose **ON** to remove red-eye effects caused by the flash when shooting with Intelligent Face Detection.

Red-eye reduction is performed only when a face is detected.

INTELLIGENT DIGITAL ZOOM(default: **OFF**)

If **ON** is selected, selecting **T** at the maximum optical zoom position triggers intelligent digital zoom, further magnifying the image while processing it for sharp, high-resolution results.

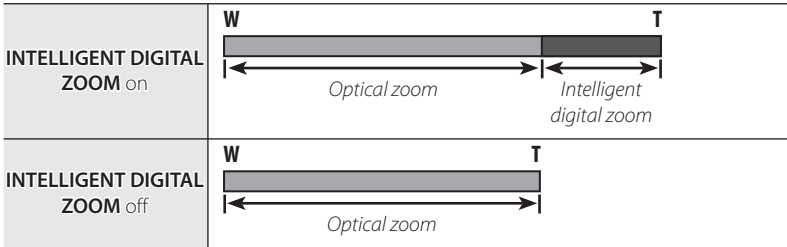
The Zoom Indicator

- ◆ Selecting another mode may end intelligent digital zoom.
- ◆ When combined with optical zoom, intelligent digital zoom offers zoom factors as high as 10x.
- ◆ Intelligent digital zoom may sometimes produce lower quality images than optical zoom.
- ◆ The time needed to record images increases.
- ◆ The effects are not visible in the display during shooting.
- ◆ Intelligent digital zoom is not available in continuous mode or during movie recording.

MOVIE ZOOM TYPE (default: **Opt**)

Choose the type of zoom available during movie recording: **Di** **DIGITAL** or **Opt** **OPTICAL**.

Movies recorded using digital zoom may be slightly “grainy”.

AF ILLUMINATOR (default: **ON**)

If **ON** is selected, the AF-assist illuminator will light to assist autofocus.

- ⓘ The camera may be unable to focus using the AF-assist illuminator in some cases. If the camera is unable to focus in macro mode, try increasing the distance to the subject.
- ⓘ Avoid shining the AF-assist illuminator directly into your subject’s eyes.

AUTOROTATE PB (default: **ON**)

Choose **ON** to automatically rotate “tall” (portrait-orientation) pictures during playback.

BACKGROUND COLOR

Choose a color scheme.

WIND FILTER

Choose **ON** to reduce the noise of the wind when shooting movies.

WIRELESS SETTINGS

Adjust settings for connection to a wireless network. For information on using wireless networks, visit <http://fujifilm-dsc.com/wifi/>.

PC AUTO SAVE SETTING

Choose a destination for images uploaded using  **PC AUTO SAVE**. For information on using wireless networks, visit <http://fujifilm-dsc.com/wifi/>.

GEOTAGGING SET-UP



Access location data options.



Option	Description
GEOTAGGING	Choose whether to save location data with pictures.
LOCATION INFO	Display locatin data.

DATE STAMP

(default: **OFF**)

Stamp the time and/or date of recording on photographs as they are taken.

Option	Description
 + 	Stamp new photographs with the date and time of recording.
	Stamp new photographs with the date of recording.
OFF	Do not stamp the time and date on new photographs.

- ① Time and date stamps can not be deleted. Turn  **DATE STAMP** off to prevent time and date stamps appearing on new photographs.
- ① If the camera clock is not set, you will be prompted to set the clock to the current date and time ( 19).
- ① We recommend that you turn the DPOF “print date” option off when printing images with a time and date stamp ( 61).
- ① Date and time can not be added to the movies and the panoramas.

Technical Notes

Optional Accessories

The camera supports a wide range of accessories from FUJIFILM and other manufacturers.

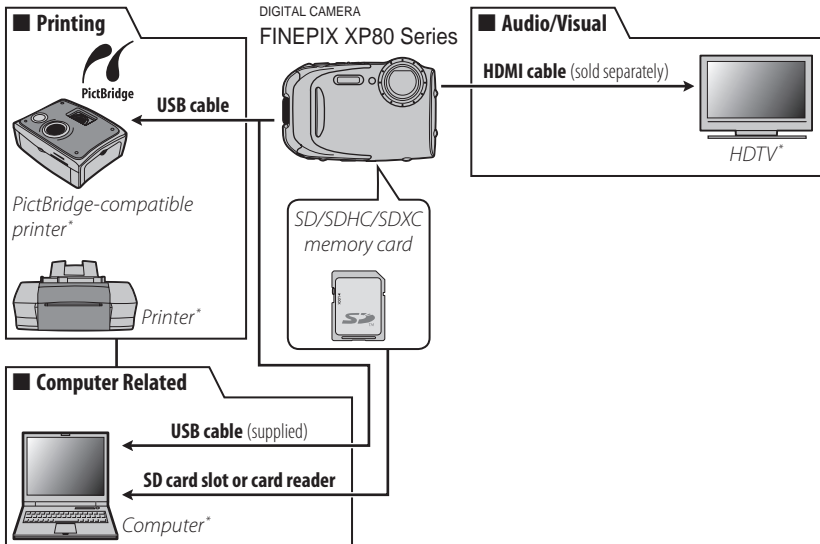

* Available separately.

Accessories from FUJIFILM

The following optional accessories are available from FUJIFILM. For the latest information on the accessories available in your region, check with your local FUJIFILM representative or visit http://www.fujifilm.com/products/digital_cameras/index.html.

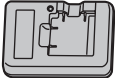
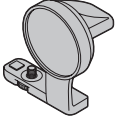
Rechargeable Li-ion batteries	NP-45S: Additional large-capacity NP-45S rechargeable batteries can be purchased as required.	
Battery chargers	BC-45W: Replacement battery chargers can be purchased as required. The BC-45W charges an NP-45S battery in about 120 minutes at +20°C (+68°F).	
ACTION CAMERA LENS	ACL-XP70: Use for wider and more impressive photos and videos.	

Caring for the Camera

To ensure continued enjoyment of the product, observe the following precautions.

Storage and Use

If the camera will not be used for an extended period, remove the battery and memory card. Do not store or use the camera in locations that are:

- exposed to rain, steam, or smoke
- very humid or extremely dusty
- exposed to direct sunlight or very high temperatures, such as in a closed vehicle on a sunny day
- extremely cold
- subject to strong vibration
- exposed to strong magnetic fields, such as near a broadcasting antenna, power line, radar emitter, motor, transformer, or magnet
- in contact with volatile chemicals such as pesticides
- next to rubber or vinyl products

■ **Condensation**

Sudden increases in temperature, such as occur when entering a heated building on a cold day, can cause condensation inside the camera. If this occurs, turn the camera off and wait an hour before turning it on again. If condensation forms on the memory card, remove the card and wait for the condensation to dissipate.

Cleaning

Use a blower to remove dust from the protective glass covering the lens and LCD monitor, then gently wipe with a soft, dry cloth. Any remaining stains can be removed by wiping gently with a piece of FUJIFILM lens-cleaning paper to which a small amount of lens-cleaning fluid has been applied. Care should be taken to avoid scratching the protective glass or LCD monitor. The camera body can be cleaned with a soft, dry cloth. Do not use alcohol, thinner, or other volatile chemicals.

Traveling

Keep the camera in your carry-on baggage. Checked baggage may suffer violent shocks that could damage the camera.

Troubleshooting

Problems and Solutions

Water in the Camera

Problem	Solution
Water in the camera.	The battery-chamber cover was not fully closed before the camera was immersed, or was opened under water: Take the camera to a FUJIFILM-authorized service technician for repairs. Do not turn the camera on.

Power and Battery

Problem	Solution
The camera does not turn on.	<ul style="list-style-type: none">• The battery is exhausted: Charge the battery or insert a fully-charged spare battery (📖 7, 14).• The battery is inserted incorrectly: Reinsert in the correct orientation (📖 8).• The battery-chamber cover is not latched: Latch the battery-chamber cover (📖 10).
The battery runs down quickly.	<ul style="list-style-type: none">• The battery is cold: Warm the battery by placing it in a pocket or other warm place and reinsert it in the camera immediately before taking a picture.• There is dirt on the battery terminals: Clean the terminals with a soft, dry cloth.• 📷 is selected for shooting mode: Select 📷 mode to reduce the drain on the battery (📖 25).• 🔍 TRACKING is selected for 📷 AF MODE: Select a different AF mode (📖 74).• The battery has been charged many times: The battery has reached the end of its charging life. Purchase a new battery.
The camera turns off suddenly.	Charge the battery or insert a fully-charged spare battery (📖 7, 14).
Charging is slow.	Charge the battery at room temperature (📖 v).

Problem	Solution
The battery does not charge. / The self-timer lamp flashes.	<p>Reinsert the battery in the correct orientation and make sure that the power connection is made (📖 7, 14).</p> <ul style="list-style-type: none"> • There is dirt on the battery terminals: Clean the terminals with a soft, dry cloth. • The battery has been charged many times: The battery has reached the end of its charging life. Purchase a new battery. If the battery still fails to charge, contact your FUJIFILM dealer. • The battery is too hot or too cold: Wait for the battery temperature to stabilize.

Menus and Displays

Problem	Solution
Menus and displays are not in English.	Select ENGLISH for  言語/LANG. (📖 19, 85).

Shooting

Problem	Solution
No picture is taken when the shutter button is pressed.	<ul style="list-style-type: none"> • Memory is full: Insert a new memory card or delete pictures (📖 9, 47). • Memory is not formatted: Format the memory card or internal memory (📖 86). • There is dirt on the memory card contacts: Clean the contacts with a soft, dry cloth. • The memory card is damaged: Insert a new memory card (📖 9). • The battery is exhausted: Charge the battery or insert a fully-charged spare battery (📖 7, 14). • The camera has turned off automatically: Turn the camera on (📖 17).
The camera does not focus.	<ul style="list-style-type: none"> • The subject is close to the camera: Select macro mode (📖 37). • The subject is far away from the camera: Cancel macro mode (📖 37). • The subject is not suited to autofocus: Use focus lock (📖 34).

Problem	Solution
Macro mode is not available.	Choose a different shooting mode (📖 25).
Intelligent Face Detection is not available.	Choose a different shooting mode (📖 25).
No face is detected.	<ul style="list-style-type: none"> • The subject's face is obscured by sunglasses, a hat, long hair, or other objects: Remove the obstructions. • The subject's face occupies only a small area of the frame: Change the composition so that the subject's face occupies a larger area of the frame (📖 33). • The subject's head is tilted or horizontal: Ask the subject to hold their head straight. • The camera is tilted: Keep the camera level (📖 21). • The subject's face is poorly lit: Shoot in bright light.
Wrong subject is selected.	The selected subject is closer to the center of the frame than the main subject. Recompose the picture or turn face detection off and frame the picture using focus lock (📖 34).
The flash does not fire.	<ul style="list-style-type: none"> • The flash is not available in the current shooting mode: Choose a different shooting mode (📖 25). • The battery is exhausted: Charge the battery or insert a fully-charged spare battery (📖 7, 14). • The camera is in continuous mode: Press the burst mode button to select single-frame mode (📖 43). • The camera is in silent mode: Turn silent mode off (📖 85). • The flash is off (🔇): Choose a different flash mode (📖 38).
Some flash modes are not available.	<ul style="list-style-type: none"> • The desired flash mode is not available in the current shooting mode: Choose a different shooting mode (📖 25). • The camera is in silent mode: Turn silent mode off (📖 85).
The flash does not fully light the subject.	<ul style="list-style-type: none"> • The subject is not in range of the flash: Position the subject in range of the flash (📖 111). • The flash window is obstructed: Hold the camera correctly (📖 21).

Problem	Solution
Pictures are blurred.	<ul style="list-style-type: none"> • The protective glass covering the lens is dirty: Clean the glass (📖 96). • The protective glass covering the lens is blocked: Keep objects away from the lens (📖 21). • !AF is displayed during shooting and the focus frame is displayed in red: Check focus before shooting (📖 104). • 🔦 is displayed during shooting: Use the flash or a tripod (📖 39).
Pictures are mottled.	<ul style="list-style-type: none"> • A slow shutter speed is selected at high temperatures: This is normal and does not indicate a malfunction. • The camera has been used continuously at high temperatures or a temperature warning is displayed: Turn the camera off and wait for it to cool down.
Vertical lines appear in pictures.	The camera has been used continuously at high temperatures. Turn the camera off and wait for it to cool down.
“Smear” in the form of vertical purple or white lines appears in the display.	Vertical purple or white lines may appear after the camera has been used continuously at high temperatures or when a very bright object is in the frame; this phenomenon is common to all CCD image sensors and does not indicate a malfunction. These lines are recorded in movies but do not appear in photographs. Avoid framing bright objects when filming movies.
Location data	Location data are incorrect. The camera has been moved since location data were last updated.
Sounds made by the camera are recorded with movies.	<ul style="list-style-type: none"> • 📺 CONTINUOUS is selected for 🎬 MOVIE AF MODE: Select a different AF mode (📖 74). • Zoom was adjusted during shooting: Do not adjust zoom during shooting. • Intelligent Face Detection is on: Turn Intelligent Face Detection off (📖 33).

Playback



Problem	Solution
Pictures are grainy.	The pictures were taken with a different make or model of camera.
Playback zoom is unavailable.	The current picture is a resized copy with a size of 640 .
No sound in movie playback.	<ul style="list-style-type: none"> • Playback volume is too low: Adjust playback volume (📖 88). • The microphone was obstructed: Hold the camera correctly during recording (📖 21, 54). • The speaker is obstructed: Hold the camera correctly during playback (📖 57).
Selected pictures are not deleted.	Some of the pictures selected for deletion are protected. Remove protection using the device with which it was originally applied (📖 80).
File numbering is unexpectedly reset.	The battery-chamber cover was opened while the camera was on. Turn the camera off before opening the battery-chamber cover (📖 17).

Connections/Miscellaneous

Problem	Solution
No picture or sound.	<ul style="list-style-type: none"> • The camera is not properly connected: Connect the camera properly (📖 58). • Input on the television is set to “TV”: Set input to “HDMI”. • The volume on the TV is too low: Adjust the volume.
The computer does not recognize the camera.	Be sure the camera and computer are correctly connected (📖 67).
Pictures can not be printed.	<ul style="list-style-type: none"> • The camera is not properly connected: Connect the camera correctly (📖 59). • The printer is off: Turn the printer on.
Only one copy is printed/ the date is not printed.	The printer is not PictBridge compatible.
The camera is unresponsive.	<ul style="list-style-type: none"> • Temporary camera malfunction: Remove and reinsert the battery (📖 7). • The battery is exhausted: Charge the battery (📖 14) or insert a fully-charged spare battery (📖 7). • The camera is connecting to a wireless network: Disconnect from the wireless network.
The camera does not function as expected.	Remove and reinsert the battery (📖 7). If the problem persists, contact your FUJIFILM dealer.
No sound.	Turn silent mode off (📖 85).
Time and date stamps	<ul style="list-style-type: none"> • Time and date stamps are not correct: Set the camera clock (📖 19). • Time and date stamps appear on photographs: Time and date stamps can not be deleted. To prevent stamps appearing on new photographs, select OFF for DATE DATE STAMP (📖 92).





Wireless Networks



For information on troubleshooting wireless networks, visit http://faq.fujifilm.com/digitalcamera/faq_product.html?pid=X.













Problem	Solution
<p>Problem connecting or uploading pictures to smartphone. Can not shoot photos using a smartphone.</p>	<ul style="list-style-type: none"> • The smartphone is too far away: Move the devices closer. • Nearby devices are causing radio interference: Move the camera and smartphone away from microwave ovens or cordless phones. <hr/> <ul style="list-style-type: none"> • The smartphone is connected to another device: The smartphone and camera can connect to only one device at a time. End the connection and try again. • There are several smartphones in the vicinity: Try connecting again. The presence of multiple smartphones can make connection difficult. <hr/> <p>The current image is a movie or was created on another device and can not be uploaded to a smartphone.</p>
<p>Smartphone will not display pictures.</p>	<p>Select ON for  WIRELESS SETTING > RESIZE IMAGE FOR SMARTPHONE . Selecting OFF increases upload times for larger images; in addition, some phones may not display images over a certain size.</p>





Warning Messages and Displays

The following warnings are displayed in the LCD monitor:

Warning	Description
 (red)	Low battery. Charge the battery (📖 14) or insert a fully-charged spare battery (📖 7).
 (blinks red)	Battery exhausted. Charge the battery (📖 14) or insert a fully-charged spare battery (📖 7).
	Slow shutter speed. Pictures may be blurred; use the flash or a tripod.
!AF (displayed in red with red focus frame)	The camera can not focus. Try one of the following solutions: <ul style="list-style-type: none">• Use focus lock to focus on another subject at the same distance, then recompose the picture (📖 34).• Use macro mode to focus when taking close-ups (📖 37).
Aperture or shutter speed displayed in red	The subject is too bright or too dark and the picture will be over- or under-exposed. If the subject is dark, use the flash (📖 38).
FOCUS ERROR	
TURN OFF THE CAMERA AND TURN ON AGAIN	Camera malfunction or moving parts of lens obstructed. Turn the camera off and then on again, taking care not to touch the lens. If the message persists, contact a FUJIFILM dealer.
LENS CONTROL ERROR	
CARD NOT INITIALIZED	<ul style="list-style-type: none">• The memory card or internal memory is not formatted or the memory card was formatted in a computer or other device: Format the memory card or internal memory using the  FORMAT option in the camera setup menu (📖 86).• The memory card contacts require cleaning: Clean the contacts with a soft, dry cloth. If the message is repeated, format the card (📖 86). If the message persists, replace the card.• Camera malfunction: Contact a FUJIFILM dealer.
PROTECTED CARD	The memory card is locked. Unlock the card (📖 9).
BUSY	The memory card is incorrectly formatted. Use the camera to format the card (📖 86).

Warning	Description
	Turn the camera off and wait for it to cool. If no action is taken, the camera will turn off automatically.
CARD ERROR	The memory card is not formatted for use in the camera. Format the card (📖 86).
	The memory card contacts require cleaning or the memory card is damaged. Clean the contacts with a soft, dry cloth. If the message is repeated, format the card (📖 86). If the message persists, replace the card.
	Incompatible memory card. Use a compatible card (📖 12).
	Camera malfunction. Contact a FUJIFILM dealer.
 MEMORY FULL	The memory card or internal memory is full and pictures can not be recorded or copied. Delete pictures or insert a memory card with more free space.
 MEMORY FULL	
INTERNAL MEMORY IS FULL INSERT A NEW CARD	
WRITE ERROR	<ul style="list-style-type: none"> • Memory card error or connection error: Reinsert the card or turn the camera off and then on again. If the message persists, contact a FUJIFILM dealer. • Not enough memory remaining to record additional pictures: Delete pictures or insert a memory card with more free space. • The memory card or internal memory is not formatted: Format the memory card or internal memory (📖 86).
READ ERROR	<ul style="list-style-type: none"> • The file is corrupt or was not created with the camera: The file can not be viewed. • The memory card contacts require cleaning: Clean the contacts with a soft, dry cloth. If the message is repeated, format the card (📖 86). If the message persists, replace the card. • Camera malfunction: Contact a FUJIFILM dealer.

Warning	Description
FRAME NO. FULL	The camera has run out of frame numbers (current frame number is 999-9999). Format the memory card and select RENEW for  FRAME NO. in the setup menu. Take a picture to reset frame numbering to 100-0001, then select CONTINUOUS for  FRAME NO ( 87).
DEACTIVATE SILENT MODE	An attempt was made to choose a flash mode or adjust the volume with the camera in silent mode. Exit silent mode before choosing a flash mode or adjusting the volume ( 85).
TOO MANY FRAMES	A search has returned more than 5,000 results, or more than 999 frames were selected for deletion. Perform a different search or select fewer pictures.
PROTECTED FRAME	An attempt was made to delete a protected picture. Remove protection and try again ( 80).
 CAN NOT CROP	 pictures can not be cropped.
CAN NOT CROP	The picture is damaged or was not created with the camera.
 CANNOT EXECUTE	An attempt was made to create a resized copy at a size equal to or larger than the original. Choose a smaller size.
 CANNOT EXECUTE	
 CANNOT EXECUTE	
CAN NOT ROTATE	An attempt was made to rotate a picture that can not be rotated.
 CAN NOT ROTATE	Movies can not be rotated.
 CANNOT EXECUTE	Resize or red-eye removal can not be applied to the selected picture.
 CANNOT EXECUTE	Red-eye removal can not be applied to movies.

Warning	Description
NO CARD	No memory card inserted when  COPY is selected in the playback menu. Insert a memory card.
 NO IMAGE  NO IMAGE	The source selected for  COPY contains no images. Select a different source.
DPOF FILE ERROR	The DPOF print order on the current memory card contains more than 999 images. Copy the pictures to internal memory and create a new print order.
CAN NOT SET DPOF  CAN NOT SET DPOF	The picture can not be printed using DPOF. Movies can not be printed using DPOF.
COMMUNICATION ERROR	A connection error occurred while pictures were being printed or copied to a computer or other device. Confirm that the device is turned on and that the USB cable is connected.
PRINTER ERROR	Printer out of paper or ink, or other printer error. Check printer (see printer manual for details). To resume printing, turn the printer off and then turn it back on.
PRINTER ERROR RESUME?	Printer out of paper or ink, or other printer error. Check printer (see printer manual for details). If printing does not resume automatically, press MENU/OK to resume.
CANNOT BE PRINTED	An attempt was made to print a movie, a picture not created with the camera, or a picture in a format not supported by the printer. Movies and some pictures created with other devices can not be printed; if the picture is a still picture created with the camera, check the printer manual to confirm that the printer supports the JFIF-JPEG or Exif-JPEG format. If it does not, the pictures can not be printed.
Ensure the battery chamber cover is locked.	Check that the battery-chamber cover is latched. Note that the cover may already be latched; this message merely encourages you to check that the cover is secure before proceeding.

Appendix

Memory Card Capacity

The following table shows the recording time or number of pictures available at different image sizes. All figures are approximate; file size varies with the scene recorded, producing wide variations in the number of files that can be stored. The number of exposures or length remaining may not diminish at an even rate. A limited number of test pictures can be taken when no memory card is inserted.

Photographs

		L				M				S			
		4:3	3:2	16:9	1:1	4:3	3:2	16:9	1:1	4:3	3:2	16:9	1:1
4 GB	FINE	580	650	770	710	1,060	1,440	1,770	1,700	2,460	2,850	3,490	2,920
	NORMAL	1,080	1,250	1,360	1,460	1,990	2,130	2,730	2,730	3,390	3,180	5,230	3,810
8 GB	FINE	1,210	1,250	1,480	1,380	2,140	2,260	3,330	2,580	4,710	4,800	6,860	5,460
	NORMAL	2,070	2,400	2,610	2,790	3,810	4,070	5,220	5,220	6,490	5,860	10,010	7,260

Movies

	FHD 1920×1080 (60 fps) ¹	FHD 1920×1080 (30 fps) ¹	HD 1280×720 (60 fps) ¹	640 640×480 (30 fps) ²	HS 640×480 (120 fps) ³	HS 320×240 (240 fps) ³	HS 160×120 (320 fps) ³
4 GB	36 min.	36 min.	40 min.	188 min.	62 min.	125 min.	137 min.
8 GB	74 min.	74 min.	82 min.	374 min.	125 min.	252 min.	276 min.

1 Use a **CLASSIC** card or better. Individual movies can not exceed 29 minutes in length.

2 Individual movies can not exceed 120 minutes in length.

3 Use a **CLASSIC** card or better. Individual movies can not exceed 30 seconds in length.

Specifications

System	
Model	Digital Camera FinePix XP80 Series
Effective pixels	16.4 million
Image sensor	½-in. square pixel CMOS with primary color filter
Storage media	• Internal memory (approx. 96 MB) • SD/SDHC/SDXC memory cards
File system	Compliant with Design Rule for Camera File System (DCF), Exif 2.3, and Digital Print Order Format (DPOF)
File format	• Still pictures: Exif 2.3 JPEG (compressed) • Movies: MOV (H.264)/Linear PCM/monaural sound
Image size (pixels)	• L 4:3: 4,608 × 3,456 • L 3:2: 4,608 × 3,072 • L 16:9: 4,608 × 2,592 • L 1:1: 3,456 × 3,456 • M 4:3: 3,264 × 2,448 • M 3:2: 3,264 × 2,176 • M 16:9: 3,264 × 1,840 • M 1:1: 2,432 × 2,432 • S 4:3: 2,048 × 1,536 • S 3:2: 2,304 × 1,536 • S 16:9: 1,920 × 1,080 • S 1:1: 1,728 × 1,728
Lens	Fujinon 5 × optical zoom lens, F3.9 (wide angle) – F4.9 (telephoto)
Focal length	f=5.0 mm–25.0 mm (35-mm format equivalent: 28 mm–140 mm)
Digital zoom	Up to about 2 × with intelligent digital zoom (up to 10 × when combined with optical zoom)
Aperture	F3.9/F6.2 (wide angle), F4.9/F8.0 (telephoto)
Focus range (distance from front of lens)	Approx. 60 cm (1.9 ft.)–infinity (wide angle); 1.0 m (3.2 ft.)–infinity (telephoto) • Macro: approx. 9 cm–80 cm/3.5 in.–2.6 ft. (wide angle); 1.0 m–3.0 m/3.2 ft.–9.8 ft. (telephoto)

System

Sensitivity Standard output sensitivity equivalent to ISO 100, 200, 400, 800, 1600, 3200, 6400 (image size **M** or **S**); AUTO (400), AUTO (800), AUTO (1600)

Metering 256-segment through-the-lens (TTL); MULTI

Exposure control Programmed AE

Exposure compensation -2 EV – +2 EV in increments of 1/3 EV







Image stabilization Optical stabilization (image-sensor shift)

Shutter speed

(combined mechanical and electronic shutter)

-  **SR AUTO**,  **P**,  **M**,  **HD**,  **FL**,  **MA**,  **Adv.**,  **N**,  **SUN**,  *****,  *****,  *****,  *****,  *****
-  **TEXT**: 1/4 S–1/2,000 S
-  **M**: 1/8 S–1/2,000 S
-  **M**: 1/30 S–1/2,000 S
-  *****: 4 S–1/2,000 S

Continuous

	Approx. frame rate (fps) ^{*1}	Continuous frames (Image size) ^{*2}
 M	3.0	10 (L M), 20 (S)
 M	5.0	10 (L M), 20 (S)
 M	10	10 (L M), 20 (S)
 M	60	70 (S 16:9)
 M	3.0	10 (L M), 20 (S)
 M	5.0	10 (L M), 20 (S)
 M	10	10 (L M), 20 (S)

*1 The frame rate varies with shooting conditions and the number of images recorded.

*2 Use a CLASSIC card or better.

Focus

- **Mode:** Single AF, continuous AF
- **Focus-area selection:** CENTER, MULTI, TRACKING
- **Autofocus system:** Contrast-detect TTL AF

System

White balance Auto, direct sunlight, shade, daylight fluorescent, warm white fluorescent, cool white fluorescent, incandescent, underwater

Self-timer Off, 2 sec., 10 sec.,  (GROUP TIMER), INTERVAL SHOOTING

Flash Auto flash; effective range when sensitivity is set to **AUTO** is approx. 70 cm–4.4 m/2.3 ft.–14.4 ft. (wide angle), 70 cm–3.8 m/2.3 ft.–12.4 ft. (telephoto); effective range in macro mode is approx. 30 cm–2.0 m/1.0 ft.–6.5 ft. (wide angle), 1.0 m–3.0 m/3.2 ft.–9.8 ft. (telephoto)

Flash mode Auto, fill flash, off, slow sync (red-eye removal off); auto with red-eye removal, fill flash with red-eye removal, off, slow sync with red-eye removal (red-eye removal on)

LCD monitor 2.7-in. (6.8 cm), 460 k-dot color LCD monitor; frame coverage approx. 100%

Movies

- **HD 1920×1080:** 1080p, 60 fps
- **HD 1280×720:** 720p, 60 fps
- **HS 640×480:** 120 fps
- **HS 160×120:** 320 fps

- **HD 1920×1080:** 1080p, 30 fps
- **640 640×480:** VGA, 30 fps
- **HS 320×240:** 240 fps

Input/output terminals

Digital input/output USB 2.0 High-Speed; MTP/PTP

HDMI output Micro HDMI connector

Specifications

Power supply/other

Power supply NP-45S rechargeable battery

Battery life (approximate number of frames that can be taken with a fully-charged battery)

Battery type	Approximate number of frames
NP-45S (type supplied with camera)	210

CIPA standard, measured in  (auto) mode using battery supplied with camera and SD memory card.

Note: Number of shots that can be taken with battery varies with battery charge level and will decline at low temperatures.

Charging time Approx. 120 minutes (+20 °C/+68 °F)

Camera dimensions (W×H×D) 104.1 mm × 66.5 mm × 25.9 mm/4.0 in. × 2.6 in. × 1.0 in., excluding projections

Shooting weight Approx. 179 g/6.3 oz., including battery and memory card

Camera weight Approx. 162 g/5.7 oz., excluding battery, accessories, and memory card

Operating conditions

- **Temperature:** -10 °C – +40 °C/+14 °F – +104 °F
- **Humidity:** 10% – 80% (no condensation)

Wireless transmitter

Standards IEEE 802.11b/g/n (standard wireless protocol)

Operating frequency

- **U. S. A., Canada, Taiwan:** 2,412 MHz–2,462 MHz (11 channels)
- **Other countries:** 2,412 MHz–2,472 MHz (13 channels)

Access protocols Infrastructure

■ Notices

- Specifications subject to change without notice. FUJIFILM shall not be held liable for damages resulting from errors in this manual.
- Although the LCD monitor is manufactured using advanced high-precision technology, small bright points and anomalous colors may appear, particularly in the vicinity of text. This is normal for this type of LCD monitor and does not indicate a malfunction; images recorded with the camera are unaffected.
- Digital cameras may malfunction when exposed to strong radio interference (e.g., electric fields, static electricity, or line noise).
- Due to the type of lens used, some distortion may occur at the periphery of images. This is normal.

FUJIFILM

FUJIFILM Corporation

7-3, AKASAKA 9-CHOME, MINATO-KU, TOKYO 107-0052, JAPAN

http://www.fujifilm.com/products/digital_cameras/index.html

Restrictions on Camera Settings

Option		Shooting Mode																			
		品品	照	P	↑	照	照	04	照	▲	照	照	照	照	照	照	照	照	照	照	照
照	照	✓	✓	✓	✓				✓	✓			✓	✓	✓	✓	✓	✓	✓	✓	✓
	照	✓	✓	✓	✓				✓	✓			✓	✓	✓	✓	✓	✓	✓	✓	✓
	照	✓	✓	✓	✓				✓	✓			✓	✓	✓	✓	✓	✓	✓	✓	✓
	照	✓	✓	✓	✓				✓	✓			✓	✓	✓	✓	✓	✓	✓	✓	✓
	照	✓	✓	✓	✓				✓	✓			✓	✓	✓	✓	✓	✓	✓	✓	✓
	照	✓	✓	✓	✓				✓	✓			✓	✓	✓	✓	✓	✓	✓	✓	✓
照	ON	✓ ¹	✓	✓		✓	✓	✓	✓		✓			✓	✓	✓	✓	✓	✓	✓	✓
	OFF		✓	✓ ¹		✓	✓	✓	✓		✓		✓	✓	✓	✓	✓	✓	✓	✓	✓
照	照	✓ ¹	✓	✓ ¹	✓ ¹	✓ ¹	✓ ¹	✓ ¹	✓ ¹	✓ ¹	✓ ¹	✓ ¹	✓ ¹	✓ ¹	✓ ¹	✓ ¹	✓ ¹	✓ ¹	✓ ¹	✓ ¹	✓ ¹
	照	✓ ¹	✓	✓																	
	照		✓	✓																	
照	照 1920×1080 (60fps)	✓	✓	✓	✓	✓	✓	✓	✓	✓	✓	✓	✓	✓	✓	✓	✓	✓	✓	✓	✓
	照 1920×1080 (30fps)	✓	✓	✓	✓	✓	✓	✓	✓	✓	✓	✓	✓	✓	✓	✓	✓	✓	✓	✓	✓
	照 1280×720 (60fps)	✓	✓	✓	✓	✓	✓	✓	✓	✓	✓	✓	✓	✓	✓	✓	✓	✓	✓	✓	✓
	照 640×480 (30fps)	✓	✓	✓	✓	✓	✓	✓	✓	✓	✓	✓	✓	✓	✓	✓	✓	✓	✓	✓	✓
	照 640×480 (120fps)	✓	✓	✓		✓	✓	✓	✓	✓	✓	✓	✓	✓	✓	✓	✓	✓	✓	✓	✓
	照 320×240 (240fps)	✓	✓	✓	✓	✓	✓	✓	✓	✓	✓	✓	✓	✓	✓	✓	✓	✓	✓	✓	✓
	照 160×120 (320fps)	✓	✓	✓		✓	✓	✓	✓	✓	✓	✓	✓	✓	✓	✓	✓	✓	✓	✓	✓
照 (照)	照	✓	✓	✓	✓	✓	✓	✓	✓	✓	✓	✓	✓	✓	✓	✓	✓	✓	✓	✓	✓
	照	✓	✓	✓	✓	✓	✓	✓	✓	✓	✓	✓	✓	✓	✓	✓	✓	✓	✓	✓	✓
照	照	✓	✓	✓	✓	✓	✓	✓	✓	✓	✓	✓	✓	✓	✓	✓	✓	✓	✓	✓	✓
	OFF	✓	✓	✓	✓	✓	✓	✓	✓	✓	✓	✓	✓	✓	✓	✓	✓	✓	✓	✓	✓
照	✓ ²	✓	✓ ²	✓ ²	✓ ²	✓	✓	✓	✓	✓ ²	✓ ²	✓	✓	✓	✓	✓	✓	✓	✓	✓	✓
照	✓	✓	✓	✓	✓	✓	✓	✓	✓	✓	✓	✓	✓	✓	✓	✓	✓	✓	✓	✓	✓
照	✓	✓	✓	✓	✓	✓	✓	✓	✓	✓ ²	✓	✓	✓	✓	✓	✓	✓	✓	✓	✓	✓
照	✓ ²	✓ ²	✓ ²	✓ ²	✓ ²	✓ ²	✓ ²	✓ ²	✓ ²	✓ ²	✓ ²	✓ ²	✓ ²	✓ ²	✓ ²	✓ ²	✓ ²	✓ ²	✓ ²	✓ ²	✓ ²
照	✓	✓	✓	✓	✓	✓	✓	✓	✓	✓	✓	✓	✓	✓	✓	✓	✓	✓	✓	✓	✓
照	✓	✓	✓	✓	✓	✓	✓	✓	✓	✓	✓	✓	✓	✓	✓	✓	✓	✓	✓	✓	✓

1 Automatically optimized for selected shooting mode.

2 OFF only.