

# FUJIFILM

DIGITAL CAMERA

# FinePix Z100fd

## OWNER'S MANUAL

This manual will show you how to use your FUJIFILM DIGITAL CAMERA FinePix Z100fd correctly. Please follow the instructions carefully.

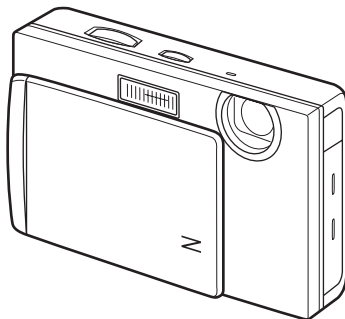

**digital**  
Tools for the Imagination.

**Exif Print**

**xD**  
xD-Picture Card™

**SD**  
HC™

**PictBridge**



Getting Ready

Using the Camera

Advanced Features • Photography

• Playback

• Movie

Settings

Camera Connection

Software  
Installation

Appendices

Troubleshooting

BL00664-201(1) **E**

# Warning

To prevent fire or shock hazard, do not expose the unit to rain or moisture.

## For customers in the U.S.A.

*Tested To Comply  
With FCC Standards  
FOR HOME OR OFFICE USE*

### FCC Statement

This device complies with Part 15 of the FCC Rules. Operation is subject to the following two conditions: (1) This device may not cause harmful interference, and (2) this device must accept any interference received, including interference that may cause undesired operation.

### CAUTION

This equipment has been tested and found to comply with the limits for a Class B digital device, pursuant to Part 15 of the FCC Rules. These limits are designed to provide reasonable protection against harmful interference in a residential installation. This equipment generates, uses, and can radiate radio frequency energy and, if not installed and used in accordance with the instructions, may cause harmful interference to radio communications. However, there is no guarantee that interference will not occur in a particular installation. If this equipment does cause harmful interference to radio or television reception, which can be determined by turning the equipment off and on, the user is encouraged to try to correct the interference by one or more of the following measures:

- Reorient or relocate the receiving antenna.
- Increase the separation between the equipment and receiver.
- Connect the equipment into an outlet on a circuit different from that to which the receiver is connected.
- Consult the dealer or an experienced radio/TV technician for help.

You are cautioned that any changes or modifications not expressly approved in this manual could void the user's authority to operate the equipment.

### Notes on the Grant:

To comply with Part 15 of the FCC Rules, this product must be used with a Fujifilm-specified ferrite-core A/V cable, USB cable, and DC supply cord.

## For customers in Canada

### CAUTION

This Class B digital apparatus complies with Canadian ICES-003.

**Please read the Safety Notes (separate note "Notes and Cautions") and make sure you understand them before using the camera.**

**Perchlorate Material-special handling may apply,  
See <http://www.dtsc.ca.gov/hazardouswaste/perchlorate>.**

## NOTICE

**BEFORE OPENING THE CD-ROM PROVIDED BY FUJIFILM CORPORATION, PLEASE READ THIS END USER LICENSE AGREEMENT CAREFULLY. ONLY IF YOU AGREE WITH THIS AGREEMENT, SHOULD YOU USE THE SOFTWARE RECORDED ON THE CD-ROM. BY OPENING THE PACKAGE, YOU ACCEPT AND AGREE TO BE BOUND BY THIS AGREEMENT.**

## End User License Agreement

This End User License Agreement ("Agreement") is an agreement between FUJIFILM Corporation ("FUJIFILM") and you, which sets forth the terms and conditions of the license granted for you to use the software provided by FUJIFILM.

The CD-ROM contains third party software. In case a separate agreement is provided by a third party supplier for its software, the provisions of such separate agreement shall apply to the use of such third party software, prevailing over those of this Agreement.

### 1. Definitions.

- (a) "Media" means the CD-ROM titled "Software for FinePix" which is provided to you together with this Agreement.
- (b) "Software" means the software which is recorded on Media.
- (c) "Documentation" means the operation manuals of Software and other related written materials which are provided to you together with Media.
- (d) "Product" means Media (including Software) and Documentation collectively.

### 2. Use of Software.

FUJIFILM grants to you a nontransferable, nonexclusive license:

- (a) to install one copy of Software onto one computer in binary machine executable form;
- (b) to use Software on the computer onto which Software is installed; and
- (c) to make one backup copy of Software.

### 3. Restrictions.

- 3.1 You shall not distribute, rent, lease or otherwise transfer all or any part of Software, Media or Documentation to any third party without FUJIFILM's prior written consent. You also shall not sublicense, assign or otherwise transfer all or any part of the rights granted to you by FUJIFILM under this Agreement without FUJIFILM's prior written consent.
- 3.2 Except as expressly granted by FUJIFILM hereunder, you shall not copy or reproduce all or any part of Software or Documentation.
- 3.3 You shall not modify, adapt or translate Software or Documentation. You also shall not alter or remove copyright and other proprietary notices that appear on or in Software or Documentation.
- 3.4 You shall not, or shall not have any third party, reverse-engineer, decompile, or disassemble Software.

### 4. Ownership.

All copyrights and other proprietary rights to Software and Documentation are owned and retained by FUJIFILM or the third party suppliers as indicated on or in Software or Documentation. Nothing contained herein shall be construed, expressly or implicitly, as transferring or granting any right, license, or title to you other than those explicitly granted under this Agreement.

### 5. Limited Warranty.

FUJIFILM warrants to you that Media is free from any defect in material and workmanship under normal use for ninety (90) days from the date of your receipt of Media. Should Media not meet the foregoing warranty, FUJIFILM shall replace such defective Media with other Media bearing no defect. FUJIFILM's entire liability and your sole and exclusive remedy with regard to any defect in Media shall be expressly limited to such FUJIFILM's replacement of Media as provided herein.

### 6. DISCLAIMER OF WARRANTY.

EXCEPT AS PROVIDED IN SECTION 5 HEREIN, FUJIFILM PROVIDES PRODUCT "AS IS" AND WITHOUT WARRANTIES OF ANY KIND, EXPRESS OR IMPLIED. FUJIFILM SHALL MAKE NO WARRANTY, EXPRESS, IMPLIED OR STATUTORY, AS TO ANY OTHER MATTERS, INCLUDING, BUT NOT LIMITED TO NON-INFRINGEMENT OF ANY COPYRIGHT, PATENT, TRADE SECRET, OR ANY OTHER PROPRIETARY RIGHTS OF ANY THIRD PARTY, MERCHANTABILITY, OR FITNESS FOR ANY PARTICULAR PURPOSE.

### 7. LIMITATION OF LIABILITY.

IN NO EVENT SHALL FUJIFILM HAVE ANY LIABILITY FOR ANY GENERAL, SPECIAL, DIRECT, INDIRECT, CONSEQUENTIAL, INCIDENTAL, OR OTHER DAMAGES (INCLUDING DAMAGES FOR LOSS OF PROFITS OR LOST SAVINGS) INCURRED FROM THE USE OF OR INABILITY TO USE PRODUCT EVEN IF FUJIFILM HAS BEEN ADVISED OF THE POSSIBILITY OF SUCH DAMAGES.

### 8. No export.

You acknowledge that neither Software nor any part thereof, will be transferred, or exported to any country or used in any manner in violation of any export control laws and regulations to which Software is subject.

### 9. Termination.

In case you breach any of the terms and conditions hereof, FUJIFILM may immediately terminate this Agreement without any notice.

### 10. Term.

This Agreement is effective until the date when you cease to use Software, unless earlier terminated in accordance with Section 9 hereof.

### 11. Obligation upon termination.

Upon termination or expiration of this Agreement, you shall, at your own responsibility and expense, delete or destroy immediately all Software (including its copies), Media and Documentation.

### 12. Governing Law.

This Agreement shall be governed by and construed in accordance with laws of Japan.

# EC Declaration of Conformity

We

Name: FUJIFILM Electronic Imaging Europe GmbH  
Address: Benzstrasse 2  
47533 Kleve, Germany

declare that the product

Product Name: FUJIFILM DIGITAL CAMERA FinePix Z100fd  
Manufacturer's Name: FUJIFILM Corporation  
Manufacturer's Address: 7-3, AKASAKA 9-CHOME  
MINATO-KU, TOKYO 107-0052, JAPAN

conforms to the following Standards:

Safety: EN60065: 2002 + A1  
EMC: EN55022: 1998 + A1: 2000 + A2: 2003 Class B  
EN55024: 1998 + A1: 2001 + A2: 2003  
EN61000-3-2: 2000 + A2: 2005  
EN61000-3-3: 1995 + A1: 2001 + A2: 2003

following the provision of the EMC Directive (2004/108/EC) and  
Low Voltage Directive (2006/95/EC).



Kleve, Germany

August 1, 2007

Place

Date

Signature/Managing Director



This product comes with batteries. When these are empty, you shouldn't throw them away but deliver them as domestic chemical refuse.

# Disposal of Electric and Electronic Equipment in Private Households

---

## Disposal of used Electrical & Electronic Equipment (Applicable in the European Union and other European countries with separate collection systems)



This symbol on the product, or in the manual and in the warranty, and/or on its packaging indicates that this product shall not be treated as household waste.

Instead it should be taken to an applicable collection point for the recycling of electrical and electronic equipment.

By ensuring this product is disposed of correctly, you will help prevent potential negative consequences to the environment and human health, which could otherwise be caused by inappropriate waste handling of this product.

If your equipment contains easy removable batteries or accumulators please dispose these separately according to your local requirements.

The recycling of materials will help to conserve natural resources. For more detailed information about recycling of this product, please contact your local city office, your household waste disposal service or the shop where you have purchased the product.

### **In Countries outside the EU:**

If you wish to discard this product, please contact your local authorities and ask for the correct way of disposal.

# Contents

Warning.....	2
IMPORTANT .....	3
EC Declaration of Conformity.....	4
Disposal of Electric and Electronic Equipment in Private Households .....	5
Contents.....	6
About this Manual .....	9
Accessories Included .....	11
Camera Parts and Features.....	12
Example of LCD Monitor Text Display .....	13

## Getting Ready













Charging the Battery .....	14
Loading the Battery .....	16
Loading the Memory Card.....	18
Turning On and Off .....	21
Setting the language, date, and time .....	22
Correcting the Date and Time.....	24
Selecting the Language .....	25
Setting Silent Mode .....	26

## Using the Camera

Taking Pictures (AUTO Mode).....	27
Using Intelligent Face Detection/Red-eye Removal when taking pictures .....	31
Using the Dual Image Stabilizer function when taking pictures .....	32
Using AF/AE lock.....	33
Adjusting the shot composition .....	35
Viewing the Images.....	36
Playback of images in the folder .....	37
 Erasing the Images/Movies.....	43

Using the erase button (  /▲) .....	43
Erasing from the [PLAYBACK MENU] .....	43
Moving or Copying the Images.....	46

## Advanced Features — Photography

Using the Shooting Functions — Procedure of Setting .....	51
Setting the Shooting Mode .....	53
Setting a Shooting mode suited to the scene.....	53
 Macro (Close-up).....	59
 Setting the Flash (Intelligent Flash).....	60
 Self-Timer .....	63
Using [SHOOTING MENU] .....	67
Setting the [SHOOTING MENU] .....	67
 [SHOOTING MENU] .....	70
Focusing the shot quickly ([  HIGH-SPEED SHOOTING]).....	70
Taking pictures continuously ([  CONTINUOUS]) .....	70
Adjusting exposure compensation ([  EXP. COMPENSATION]) .....	73
Adjusting color balance ([  WHITE BALANCE]) .....	74
Changing the quality setting ([  QUALITY]) .....	74
Changing the sensitivity setting ([  ISO] ISO) .....	75
Changing the FinePix COLOR setting ([  FinePix COLOR]).....	76
Specifying focusing mode ([  AF MODE]).....	77

## Advanced Features — Playback

[MENU] PLAYBACK MENU .....	79
Sending and receiving images ([IR] IR COMMUNICATION) .....	79
Transmitting and saving blog images ([BLOG] TRIMMING FOR BLOG) .....	82
Using [PLAYBACK MENU] .....	84
Setting the [PLAYBACK MENU] .....	84
Setting automatic playback ([SLIDE] SLIDE SHOW) .....	85
Selecting the type of image transition ([TRANSITION] TRANSITION) .....	85
Rotating the images ([IMAGE] IMAGE ROTATE) .....	86
Protecting the images ([PROTECT] PROTECT) .....	87
Adding voice memos to the images ([VOICE] VOICE MEMO) .....	89
DPOF set frame ([PRINT] PRINT ORDER (DPOF)) .....	92
Trimming the images ([TRIMMING] TRIMMING) .....	96

## Advanced Features — Movie

[RECORD] Recording Movies .....	98
Changing movie size .....	100
[PLAY] Playing Back Movies .....	101

## Settings

[SETUP] SETUP .....	103
Using the [SET-UP] menu .....	103
SET-UP menu option .....	104

## Camera Connection

Connecting to a TV .....	114
Connecting Camera Directly to Printer — PictBridge Function .....	115

## Software Installation

Installation on a Windows PC .....	119
Installation on a Mac OS X .....	121
Connecting to a PC .....	124
Using FinePixViewer .....	127

## Appendices

System Expansion Option .....	129
Accessories Guide .....	130
Using Your Camera Correctly .....	132
Notes on the <b>xD-Picture Card™</b> , the SD Memory Card and the Internal Memory .....	133
Warning Displays .....	134

## Troubleshooting

Troubleshooting .....	139
-----------------------	-----

Specifications .....	147
Explanation of Terms .....	154
FUJIFILM Digital Camera Worldwide Network .....	155

---

***Usable Memory Cards***

You can use the **xD-Picture Card**, the SD Memory Card and the SDHC Memory Card with the FinePix Z100fd. In this Owner's Manual, these cards are expressed as "Memory Card" and "SD Memory Card".

---



# About this Manual

## ■ About marks

! **CAUTION:** This mark denotes issues that may affect the camera's operation.

✓ **CHECK:** This mark denotes points to notice in the camera's operation.

📄 **MEMO:** This mark denotes additional topics that complement the basic operating procedures.

## ■ Usable Memory Cards

You can use the **xD-Picture Card**, the SD Memory Card and the SDHC Memory Card with the FinePix Z100fd. In this Owner's Manual, these cards are expressed as "Memory Card" and "SD Memory Card".

## ■ 4-direction (▲▼◀▶) button

Up, down, left, and right are indicated by black triangles in the Owner's Manual. Up or down is shown as ▲ or ▼, and left or right is shown as ◀ or ▶.

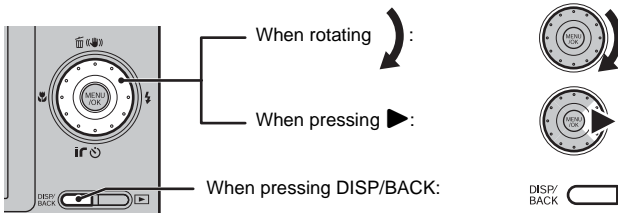

## ■ About cables

The cables used for FinePix Z100fd are following:

- A/V cable for FinePix Z100fd
- USB cable for FinePix Z100fd

In this manual, these cables are expressed as "A/V cable" and "USB cable".

## ■ About the illustration for the LCD monitor display

In this manual, the illustration for the LCD monitor display is simplified.

**Continued** ➡

## ■ Note

In this manual, the menu names or messages displayed in the LCD monitor appear in square brackets([ ]).

## ■ Using the Wheel Dial

You can select files or menus easier by rotating the wheel dial.  
We recommend using the wheel dial to select thumbnails or the top menu, etc.

### Selecting thumbnails (→p.41)

Keep rotating the wheel dial when reaching the last image in a folder to move to the next folder.



### Selecting menus (→p.53, 67, 84)

Use mainly when selecting menus in vertical tree.

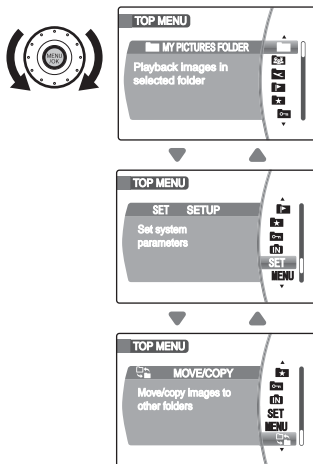

### Changing folders (→p.27)

Change the folder by rotating the wheel dial quickly one time or more.



# Accessories Included

- Rechargeable Battery NP-45 (1)



- Strap (1)

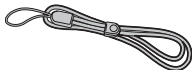

- Battery Charger BC-45 (1 set)

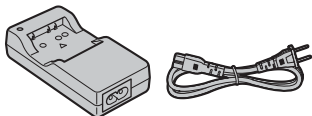

- A/V cable (1)



- USB cable (1)

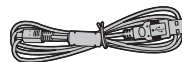

- CD-ROM (1)  
Software for FinePix



- Owner's Manual (this manual) (1)
- Notes and Cautions (1)

## Attaching the strap

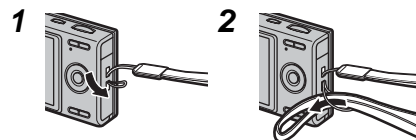

Attach the strap as shown in 1 and 2.

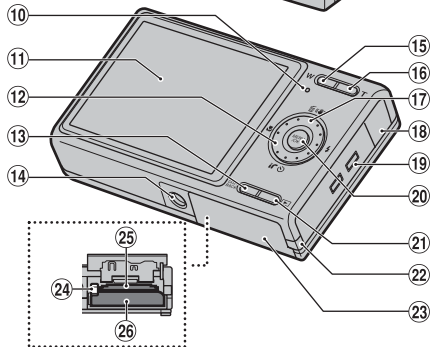
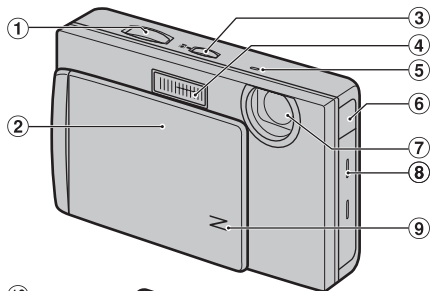

# Camera Parts and Features

- Refer to the pages in parentheses for information on using the camera parts or features.



- 1 Shutter button
- 2 POWER switch/Lens cover
- 3 Intelligent Face Detection/Red-eye Removal button (p.31)
- 4 Flash (p.60)
- 5 Microphone
- 6 Infrared port (p.80)
- 7 Lens
- 8 Speaker
- 9 Illumination lamp (p.108)/Self-timer lamp (p.66)
- 10 Indicator lamp (p.30)
- 11 LCD monitor
- 12 Wheel dial/4-direction  button (p.9)
- 13 DISP (Display)/BACK button (p.35, 36)
- 14 Tripod mount
- 15 **W** (Wide zoom) button (p.28, 39)
- 16 **T** (Tele zoom) button (p.28, 39)
- 17  Dual IS button (p.32)
- 18 Multi-connector adapter connection socket
- 19 Strap mount
- 20 MENU/OK button
- 21  (Playback) button
- 22 DC coupler cable cover
- 23 Battery cover (p.16)
- 24 Battery release catch (p.16)
- 25 Memory Card slot (p.19)
- 26 Battery compartment (p.16)

# Example of LCD Monitor Text Display

## Photography mode

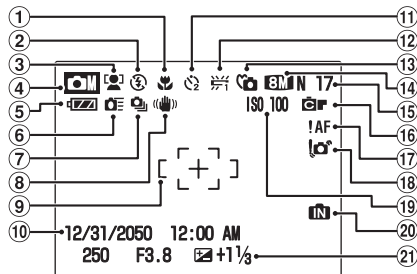

- ① Macro (close-up) (p.59)
- ② Flash (p.60)
- ③ Intelligent Face Detection (p.31)
- ④ Shooting mode (p.53)
- ⑤ Battery level indicator (p.15)
- ⑥ High-speed shooting (p.70)
- ⑦ Continuous shooting (p.70)
- ⑧ Dual IS (p.32)
- ⑨ AF frame (p.29)
- ⑩ Date/Time (p.22)
- ⑪ Self-timer (p.63)
- ⑫ White balance (p.74)
- ⑬ Silent mode (p.26)
- ⑭ EM/N Quality mode (p.74)
- ⑮ Number of available frames (p.152)
- ⑯ FinePix COLOR (p.76)
- ⑰ !AF AF warning (p.29)
- ⑱ Camera shake warning (p.30)
- ⑲ Sensitivity (p.75)
- ⑳ Internal memory (p.20)
- ㉑ Exposure compensation (p.73)

## Playback mode

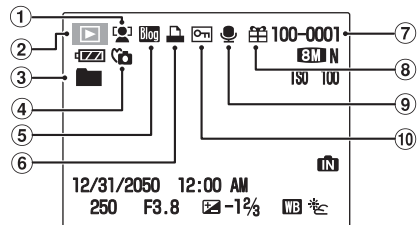

- ① Intelligent Face Detection (p.39)
- ② Playback mode (p.36)
- ③ Folder (p.27)
- ④ Silent mode (p.26)
- ⑤ Blog image (p.82)
- ⑥ DPOF (p.92)
- ⑦ Frame number (p.107)
- ⑧ Present (p.36)
- ⑨ Voice memo (p.89)
- ⑩ Protection (p.87)

FinePix Z100fd has internal memory that can store images without Memory Card. appears on the LCD monitor when the internal memory is active.

# Charging the Battery

The battery is not fully charged at shipment and must be fully charged before being used.

## Compatible battery

Rechargeable Battery NP-45 (1)

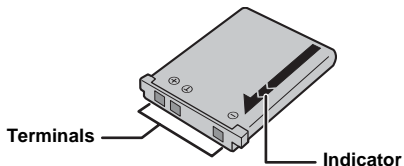

## CAUTION

- The battery is not fully charged at shipment and must be fully charged before being used.
- Do not stick labels onto the battery as this could cause the battery to become jammed inside the camera.
- Any contact between the battery terminals could cause the battery to short circuit and overheat.
- See "Notes and Cautions" for information on the battery.
- Always use the Rechargeable Battery NP-45 (included). The use of other brands of rechargeable battery could cause faults or damage to the camera.
- Do not split or peel outer labels of the battery.

## 1 Load the battery in to the battery charger BC-45.

Set the battery correctly as indicated by the polarity icon.

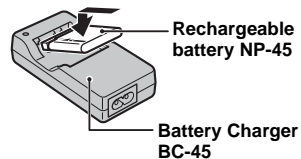

## 2 Connect the battery charger and connecting cable and plug the connecting cable into the power outlet.

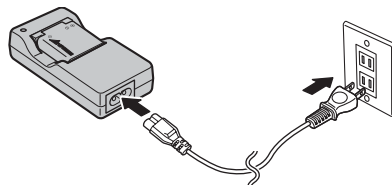

## 3 The charging indicator lights red and charging begins.

When charging is completed, the indicator turns off. Charging completes after 180 minutes.

## <Charging Indicator and Statuses>

Charging Indicator	Status	Action
Off	Battery not loaded	Load the battery to be charged.
	Fully charged (charging complete)	Remove the battery from the battery charger.
Lit red	Charging	—
Blinking red	Battery fault during charging	Unplug the battery charger and remove the battery from the battery charger.

### ! CAUTION

- Unplug the battery charger from the power outlet when it is not in use.
- If the terminals of battery are soiled, it may not be possible to charge it. Clean the battery terminals and battery charger terminals with a clean, dry cloth.
- Charging times increase at low temperatures.
- The NP-45 gradually loses its charge even when not used. Charge a NP-45 just before taking pictures (in the last day or two).

## Checking the battery charge

Turn the camera on and check the battery level indicator on the LCD monitor.

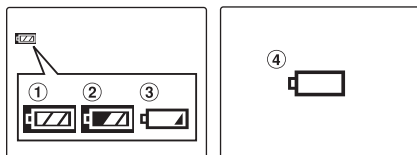

- ① There is ample battery charge. (Lit white)
- ② The battery is almost half charged. (Lit white)
- ③ There is insufficient charge left in the battery. The battery will soon run out. Have a charged battery ready. (Lit red)
- ④ The battery is depleted. The display will shortly go blank and the camera will stop working. Replace or recharge the battery. (Blinking red)

### ! CAUTION

- Due to the nature of the battery, the battery level indicator (①, ②, or ③) may appear early when the camera is used in cold locations. Try warming the battery in your pocket or a similar location before use.
- Battery with no remaining charge (④ blinking red) may cause camera faults. Always load a fully charged battery.
- Depending on the camera mode, the transition from ① to ④ may occur more quickly.

# Loading the Battery

Battery is required to operate the digital camera. At first, load the battery in the camera.

## 1 Open the battery cover.

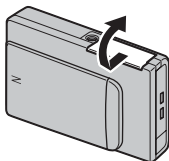

### CHECK

Check that the camera is turned off before opening the battery cover.

### CAUTION

- Do not open the battery cover while the camera is on. This could damage the Memory Card or ruin the image files on the Memory Card.
- Do not apply force to the battery cover.

## 2 Load the battery.

Make sure that the indicators are aligned. Push the battery release catch down while loading the battery. Check that the battery is firmly held in place.

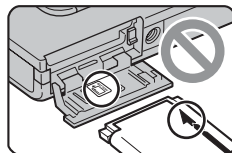
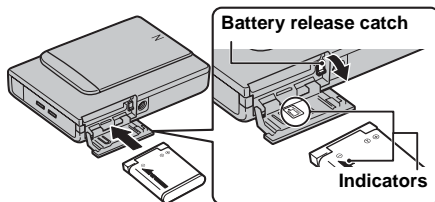

### CAUTION

Load the battery in the correct direction.



### 3 Close the battery cover.

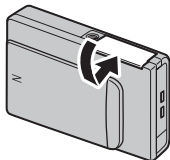

#### To remove the battery

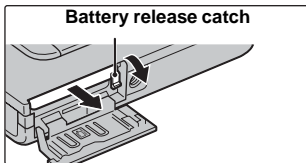

Open the battery cover, and unlock the battery release catch with your finger.

#### ⚠ CAUTION

Make sure the camera is turned off before removing the battery.

#### 📄 MEMO

If you want to use the camera powered by AC, the AC power adapter, AC-5VX (sold separately), and DC coupler, CP-45 (sold separately), are necessary. Refer to the manual provided with the AC-5VX and CP-45 for instructions.

# Loading the Memory Card

Although you can store pictures in the camera's internal memory, you can store many more images on the Memory Card (sold separately). You can use an **xD-Picture Card** and SD Memory Card with the FinePix Z100fd. In this Owner's Manual, these cards are expressed as "Memory Card".

## SD Memory Cards/SDHC Memory Cards

They are operation-checked at FUJIFILM Corporation.  
Manufacturer: SanDisk

### MEMO

- Compatible models will be updated in our web site:  
[http://www.fujifilm.com/products/digital\\_cameras/index.html](http://www.fujifilm.com/products/digital_cameras/index.html)
- Depending on the SD Memory Card, recording of movies may be interrupted. Use of above mentioned SD Memory Cards are recommended.
- The camera is not compatible with multimedia cards.

## 1 Open the battery cover.

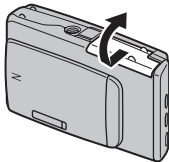

## 2 Insert an xD-Picture Card.

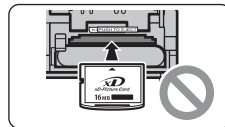
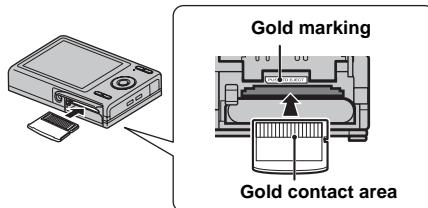

(SD Memory Card)

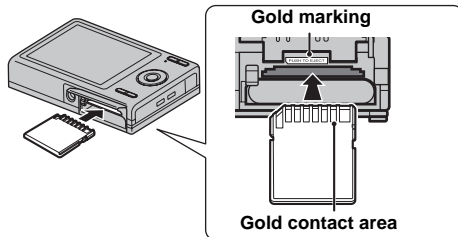

Align the gold marking with the gold contact area, then insert an SD Memory Card completely.

**! CAUTION**

Be sure to unlock the protection of the SD Memory Card before inserting it. If it is locked, recording/deleting images, as well as formatting are not available. To unlock the protection, slide the switch back, and the SD Memory Card will work normally.

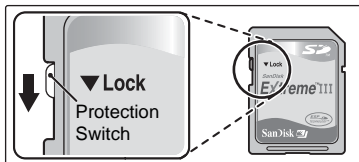
**! CAUTION**

- A new SD Memory Card or a card previously used on a PC or any device other than the camera should be formatted (→p.111) on the camera before use.
- Do not use a miniSD adaptor or a microSD adaptor which have exposed contact areas on the back. Use of these adaptors may cause a malfunction or damage due to the improper contacts.

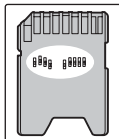
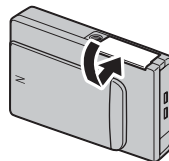
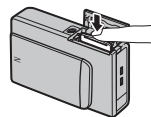
**3 Close the battery cover.****How to replace the Memory Card**

Push the Memory Card into the slot and then slowly remove your finger. The lock is released and the Memory Card is pushed out.

**Continued** ➔

### CAUTION

- When storing Memory Cards, make sure that they are kept out of the reach of children. A Memory Card could be swallowed and cause suffocation. If a child swallows a Memory Card, seek medical attention or call emergency number right away.
- If the Memory Card is oriented incorrectly, it will not go all the way into the slot. Do not apply force when inserting a Memory Card.
- Note that the Memory Card may spring out if you release your finger quickly from the card immediately after the lock is released.
- Operation of this camera is only guaranteed when it is used with FUJIFILM **xD-Picture Card** and operation checked SD Memory Card. (→p.18).
- See p.133 for information on the **xD-Picture Card** and the internal memory.

### MEMO

- The size of an image file varies depending on the subject. For this reason, the number recorded may not represent the actual number of frames.
- See p.152 for information on the standard number of available frames.

### ■ About internal memory

FinePix Z100fd has internal memory that can store images without Memory Card.  appears on the LCD monitor when internal memory is active.

#### **When a Memory Card (sold separately) is inserted**

Record images: Record images to a selected folder.  
Playback images: Playback images in a selected folder.

#### **When a Memory Card (sold separately) is not inserted**

Record images: Record images to internal memory.  
Playback images: Playback images in internal memory.

### ■ About images in the internal memory

Images held in the camera's internal memory may be corrupted or erased due to problems such as camera faults. Save your important data to another media (i.e., CD-R, CD-RW, DVD-R, hard disk, etc.).

It is possible to transfer saved images on the internal memory to a Memory Card (→p.46).

### CAUTION

Erase the unnecessary images in the internal memory.  
(→p.43)

# Turning On and Off

## Turning the camera on in Shooting mode

Open the lens cover completely to turn the camera on. Close the lens cover to turn the camera off.

• **Power-ON**

• **Power-OFF**

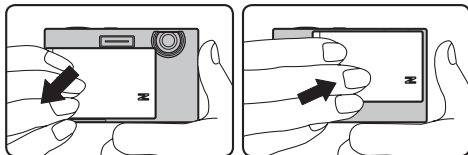



### MEMO

#### Changes between Shooting mode and Playback mode

Press  during shooting to change to Playback mode. Press the shutter button down halfway to return to Shooting mode.

### ! CAUTION

- Take care not to get fingerprints on the camera lens as this will result in impaired image quality in your shots.
- Press  to activate Playback mode when the lens cover is open. Press and hold  to turn the camera off.
- Avoid pressing the lens cover to prevent damaging the surface of the camera.

## Turning the camera on in Playback mode

① Leave the lens cover closed.

• **Close the lens cover**

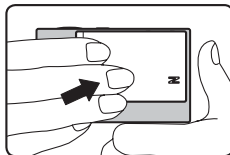

② Press  for about 1 second to turn the camera on in Playback mode.

Press  during playback to turn the camera off.

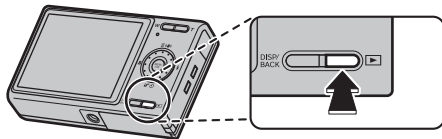

### ! CAUTION

When the lens cover is open, even if you press , the power cannot be turned off. Follow the instructions on the LCD monitor.



### MEMO

To change to Shooting mode, open the lens cover completely so that it will not move further.

## Setting the language, date, and time

When using the camera for the first time after purchasing, the language, date, and time are cleared. Set the language, date, and time.

### 1 [言語/LANG.] screen appears when turning the camera on.



① Select the language.



② Press MENU/OK to confirm the setting.

### 2 Set the date and time.

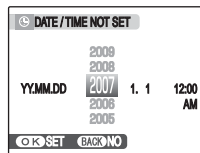

① Select Year, Month, Day, Hour, or Minute.



② Correct the setting.



#### MEMO

- Holding down ▲ or ▼ changes the numbers continuously.
- When the time displayed passes "12", the AM/PM setting changes.
- The wheel dial is useful to set the date and time.

### 3 Change the date format.



- ① Select the date format.



- ② Set the format.



- ③ Always press MENU/OK after the settings are completed.

#### **Date format**

ex. December 1, 2007  
 YY.MM.DD: 2007.12.1  
 MM/DD/YY: 12/1/2007  
 DD.MM.YY: 1.12.2007



#### **MEMO**

[START MENU] screen also appears when the battery has been removed and the camera has been left for a long period. Once the AC power adapter has been connected or the battery has been installed for 10 hours or more, the camera settings will be retained for roughly 24 hours even if both sources of power are removed.

#### **Auto power off function**

When the Auto power off function is active, if the camera is left unused for 2 or 5 minutes, this function turns the camera off (→p.111). To restore power to the camera to take pictures, briefly close the lens cover completely and then reopen it. To play back images, hold down  for about 1 second.

# Correcting the Date and Time

## 1 Open the [SET-UP] menu.

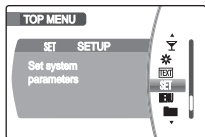

① Press MENU/OK to open the top menu.



② Select [SET] SETUP.



③ Press MENU/OK to open the [SET-UP] menu.

### MEMO

The wheel dial is useful to select thumbnails, the top menu, etc.

## 2 Display the [DATE/TIME] screen.

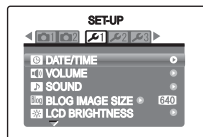

① Select 1.



② Move to menu item.



③ Select [DATE/TIME].



④ The [DATE/TIME] screen appears.  
See “2 Set the date and time.” (→p.22).



# Selecting the Language

## 1 Open the [SET-UP] menu.

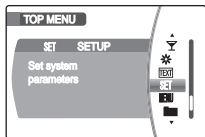

① Press MENU/OK to open the top menu.



② Select [SET] SETUP.



③ Press MENU/OK to open the [SET-UP] menu.

## 2 Display the [言語/LANG.] screen.

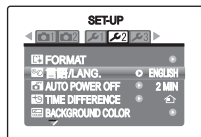

① Select 2.



② Move to menu item.



③ Select [言語/LANG.].



④ The [言語/LANG.] screen appears.  
See "1 [言語/LANG.] screen appears when turning the camera on." (→p.22).

## Setting Silent Mode

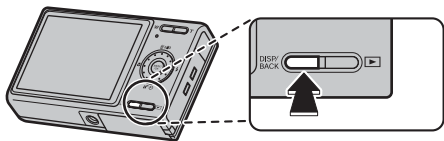

Set Silent mode pressing and holding DISP/BACK. Use this mode for taking pictures in places where the use of flash and making an operation or shutter sound are restricted.

Flash mode is set to suppressed flash and the operation sound, shutter sound, playback sound of movies or voice memo, self-timer lamp and illumination lamp are disabled.

### MEMO

- Press and hold DISP/BACK again to release Silent mode.
- Flash will light only in Natural &  mode.
- Release Silent mode to change flash mode or sound volume.

# Taking Pictures (AUTO Mode)

This section describes the basic operations.

Refer to p.51 for setting AUTO Mode.

## 1 Turn the camera on.

- ① Open the lens cover completely so that it will not move further.

### • Power-ON

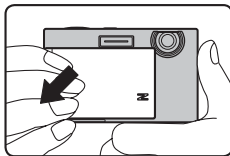

## 2 Select the folder.

You can save images or movies in the folder by category.

This camera has 5 folders ( MY PICTURES, FAMILY, TRAVEL, EVENTS, FAVORITES). Select the folder in advance.

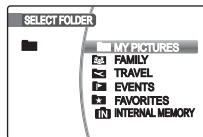
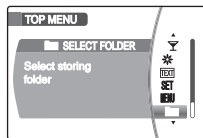

### MEMO

- If a memory card is not inserted, images or movies are saved in [INTERNAL MEMORY] folder.
- In Shooting mode, rotate the wheel dial quickly one time or more for easy access to other folders.

**Continued** ➔

### Holding the camera correctly

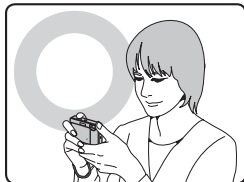

Brace your elbows against your sides and hold the camera with both hands.

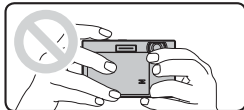

Do not cover the lens or flash with your fingers.

### CAUTION

- Moving the camera while shooting gives a blurred picture (camera shake). Hold the camera steadily with both hands.
- If the lens or flash is obscured by your fingers or the strap, subjects may be out of focus or the brightness (exposure) of your shot may be incorrect.
- Check that the lens is clean. If it is dirty (getting fingerprints on the lens etc.), clean the lens as informed on separate note.

### 3 Check the composition on the LCD monitor. To adjust zoom scale using the Zoom button:

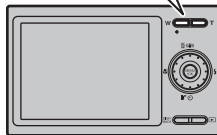
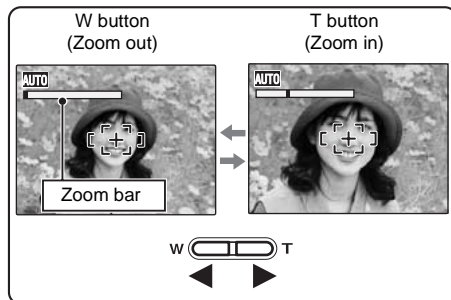

- **Focal range**  
Approx. 60 cm (2.0 ft.) to infinity
- **Optical zoom focal length (35 mm camera equivalent)**  
Approx. 36 mm to 180 mm
- **Max. zoom scale**  
5x

### MEMO

- Select Macro mode to take close-up shots (→p.59).
- Use digital zoom when you want to shoot the subject closer (→p.108).

#### 4 Focus on the main subject in the AF frame and press the shutter button down halfway.

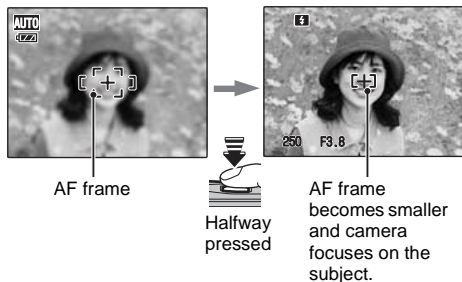

#### ✓ CHECK

- **Focus on the subject**  
Double beep is heard  
Indicator lamp lit green
- **Not focus on the subject**  
No sound  
AF frame lit red  
**!AF** indicated  
Indicator lamp blinking green

#### 📄 MEMO

The shutter button has a halfway point at which focus and exposure are automatically optimized before taking the picture by pressing fully down.

#### ⚠ CAUTION

When pressing the shutter button halfway, a lens operation sound may be heard.

#### 5 Press the shutter button fully.

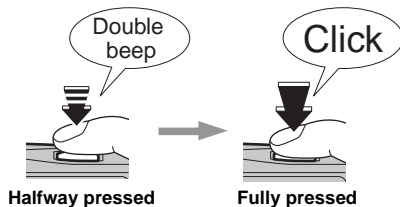

#### ⚠ CAUTION

When taking a picture using the flash, the image may disappear and go dark briefly due to flash charging. The indicator lamp blinks orange during charging.

#### 📄 MEMO

- When the subject is not in the AF frame, use AF/AE lock to take the picture (→p.33).
- When pressing the shutter button down fully in one motion, the camera takes the picture without the AF frame changing.
- When a picture is taken, the illumination lamp on the front of the camera lights to indicate that shooting is complete.
- Images are saved in the folder displayed in the top left of the LCD monitor (→p.27).

**Continued** ➔

### Flash



When pressing the shutter button down halfway, **F** appears on the LCD monitor before the flash fires.

Change the flash mode when you want to take pictures without flash. See p.60 for information on flash.

### ! CAUTION

- The image shown on the LCD monitor before the picture is taken may differ in brightness, color, etc. from the image actually recorded. Play back the recorded image to check it (→p.36).
- When selecting a slow shutter speed that will cause camera shake, **!** appears on the LCD monitor. Use flash or a tripod.
- See p.134-138 for information on Warning displays. See "Troubleshooting" (→p.139-146) for more information.

### Indicator lamp display

The indicator lamp lights or blinks when pressing the shutter button, etc. The indicator lamp shows the camera status.

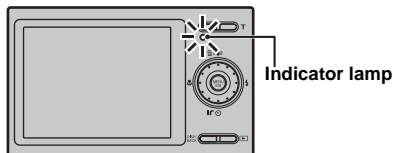

Display	Status
Lit green	Locking the focus
Blinking green	Camera shake warning, AF warning, or AE warning (ready to shoot)
Blinking green and orange alternately	Recording to Memory Card or internal memory (ready to shoot)
Lit orange	Recording to Memory Card or internal memory (not ready)
Blinking orange	Charging flash (flash will not fire)
Blinking red	<ul style="list-style-type: none"> <li>• Warnings for Memory Card and internal memory</li> <li>• Card not formatted, incorrect format, memory full, Memory Card or internal memory error</li> <li>• Lens operation error</li> </ul>

### MEMO

Detailed warning messages appear on the LCD monitor (→p.134-138).



- ② Press the shutter button down fully to take pictures.



**✓ CHECK [ FACE DETECTION REMOVAL ON ]**

When a picture is taken with [ FACE DETECTION REMOVAL ON ] set, the red-eye effect will be detected and corrected before the image is recorded. When a picture is taken with [ FACE DETECTION REMOVAL OFF ] set, the image is recorded without the red-eye effect.

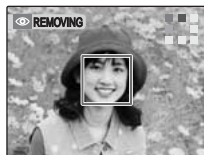

Red-eye effect in an image will be detected after the shooting.

**Subjects not suitable for Intelligent Face Detection**

Intelligent Face Detection automatically focuses on a face(s) turned towards the camera. However, difficulties will occur with the Intelligent Face Detection mode in the following situations:

- The face is obscured by glasses, sunglasses, a hat, or hair.
- A person turned sideways, or who has their head tilted.
- The subject is too far away to recognize a face.

Intelligent Face Detection will not work in cases where the subject is standing on his/her head, is not a person (pet or other animal), or if the camera is not held correctly.

**For such subjects use AF/AE lock (→p.33).**

**Using the Dual Image Stabilizer function when taking pictures**

Camera shake and blurring (of moving subject) can be reduced by the image stabilizer function and a high sensitivity setting. Both camera shake and blurring are reduced when **AUTO** is selected for the shooting mode. Only camera shake will be reduced when any other shooting mode is selected.

**Available Photography modes: All (except for )**

- ① Press to activate Dual IS (image stabilization) mode. Press again to set Dual IS mode OFF.

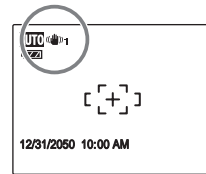
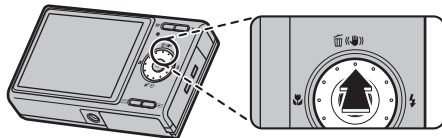

<sub>1</sub> or <sub>2</sub> will be displayed when Dual IS mode is activated.

**✓ CHECK**

The Dual IS mode can be set to [<sub>1</sub> CONTINUOUS] or [<sub>2</sub> SHOOTING ONLY] under [ DUAL IS MODE] in the [SET-UP] menu (→p.108).





- ② Press the shutter button down fully to take pictures.

**CAUTION**

Camera shake and blurring may remain depending on scenes.

## Using AF/AE lock

### Take a picture using AF/AE lock

- 1 Move the camera slightly so that one of the subjects is in the AF frame.

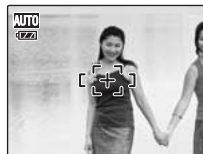

- 2 Press the shutter button down halfway to focus on the subject.

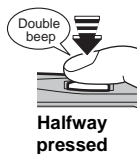

*Continued* ➔

- 3** Continue to hold the shutter button down halfway. Move the camera back to the original image and press the shutter button fully.



**!** **CAUTION**

When shooting with the AF/AE lock function, turn off Intelligent Face Detection.

**MEMO**

- AF/AE lock can be applied repeatedly before the shutter is released.
- On FinePix Z100fd, pressing the shutter button down halfway locks the focus and exposure settings (AF and AE lock).

**Subjects not suitable for autofocus**

FinePix Z100fd uses a high-precision autofocus mechanism. However, it may have difficulty focusing on the following:



**Very shiny subjects such as a mirror or car body**

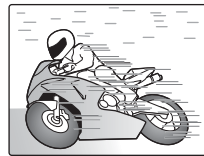

**Fast moving subjects**

- Subjects photographed through glass
- Subjects that do not reflect well, such as hair or fur
- Subjects with no substance, such as smoke or flames
- Dark subjects
- Subjects with little or no contrast between the subject and the background (such as subjects dressed in the same color as the background)
- Shots where another high-contrast object (not the subject) is close to the AF frame and is either closer or further away than your subject (such as a shot of someone against a background with strongly contrasting elements)

For such subjects use AF/AE lock (→p.33).

## Adjusting the shot composition

### Select the LCD monitor display.

Press DISP/BACK to change the LCD monitor display.

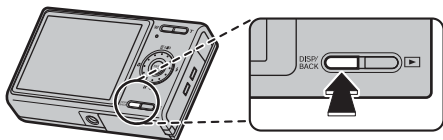

Text displayed

No text displayed



Framing guideline  
displayed

## Best framing

Position the main subject at the intersection of two lines in this frame or align one of the horizontal lines with the horizon. Use this frame as a guide to the subject's size and the balance of the shot while composing a shot.



### MEMO

Always use AF/AE lock when composing a shot. The image may be out of focus if AF/AE lock is not used.

# Viewing the Images

Play back your images to check them. For important photographs, always take a test shot and view the image to make sure that the camera is working normally.

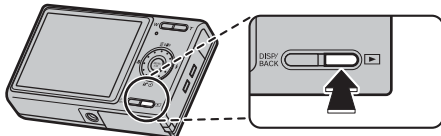

## Setting the camera to Playback mode

Press  during shooting to change to Playback mode.



When the camera is off, press  for about 1 second to turn the camera on in Playback mode.

### MEMO

- When pressing , the last image shot in the selected folder appears on the LCD monitor.
- When playing back images shot with a camera other than FinePix Z100fd, “” (present icon) appears on the LCD monitor.

### CAUTION Still images viewable on FinePix Z100fd

This camera will display still images recorded on FinePix Z100fd or still images (excluding some uncompressed images) recorded on any FUJIFILM digital camera that supports **xD-Picture Cards** or SD Memory Cards. Clear playback or playback zooming may not be possible for still images shot on cameras other than FinePix Z100fd.

## Select the LCD monitor display.

Press DISP/BACK during Playback mode to change the LCD monitor display.

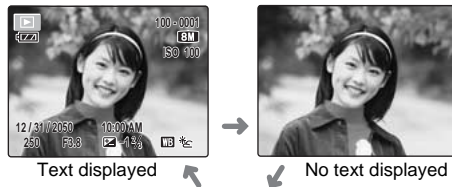
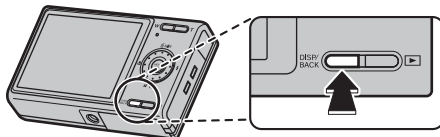

Sorting by date

## Playback of images in the folder

Play back images saved in folders. This camera has 7 folders (MY PICTURES, FAMILY, TRAVEL, EVENTS, FAVORITES, PRIVATE, INTERNAL MEMORY). You can play back other images in other folders during playback. You can also move or copy images between folders (→p.46).

- ① Press MENU/OK to open the top menu.

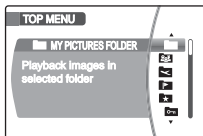

- ② Select the folder including images to play back.

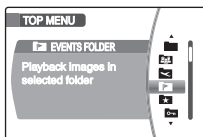

- ③ Press MENU/OK to play back.



### MEMO

- The [PRIVATE] folder is only for playback mode.
- Only the [INTERNAL MEMORY] folder is available when a memory card is not inserted.

### Setting the password

You can set a 4-digit password to the [PRIVATE] folder.

### MEMO

If you forget your password, set again.

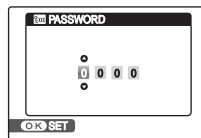

- ① Open the [SET-UP] screen. See "1 Open the [SET-UP] menu." (→p.24).



- ② Select **3**.



- ③ Move to menu item.



- ④ Select [**3**] PASSWORD].



⑤ Set the password.

#### MEMO

- The password function is only a lock function and you cannot encrypt it.
- The [PRIVATE] folder can be played back with other cameras as a normal folder.

#### Inputting password

A 4-digit password is necessary to play back, move or copy images in the [PRIVATE] folder, if you set the password.

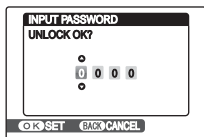

① Press MENU/OK to open the top menu.



② Select [PRIVATE FOLDER] and input the password.

## Single-frame playback



To select the required image:

Press ◀: last image

Press ▶: next image

#### Intelligent Face Detection

When playing back images taken with Intelligent Face Detection (→p.31) (IFD icon appears on the LCD monitor), press IFD (Intelligent Face Detection). A frame appears around the faces that were detected by FinePix Z100fd. Press IFD (Intelligent Face Detection) to alternate the detected face. For images shot with a camera other than FinePix Z100fd, the frame may not appear.

#### Selecting images



To select images on the thumbnail lists screen, hold down ◀ or ▶ for 1 second during playback. When releasing ◀ or ▶, camera returns to single-frame playback.

## Playback zoom

### 1 Zoom in / Zoom out.

To zoom in an image during single-frame playback:

**W** button (Zoom out)

**T** button (Zoom in)

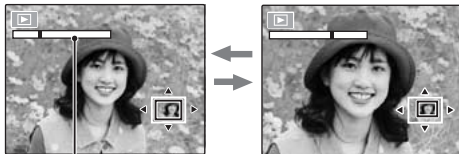

Zoom bar



Press **W** or **T** to zoom in or out on an image.

### 2 Display another part of the image.



Navigation screen  
(Current displayed  
image)



Press **▲**, **▼**, **◀**, or **▶** to display another part of the image.

## Zoom scales

Quality mode	Max. zoom scale
<b>8M</b> (3264 × 2448 pixels)	Approx. 5.1×
<b>8P</b> (3264 × 2176 pixels)	Approx. 5.1×
<b>4M</b> (2304 × 1728 pixels)	Approx. 3.6×
<b>2M</b> (1600 × 1200 pixels)	Approx. 2.5×



### MEMO

Pressing **DISP/BACK** cancels playback zoom.

### Intelligent Face Detection

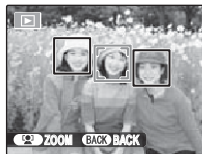

For images taken with Intelligent Face Detection (→p.31) (IFD appears on the LCD monitor), the displayed face switches each time you press **IFD** (Intelligent Face Detection). Press the **W** button (zoom out) or **T** button (zoom in) to display the selected face zoomed in or out. Press **▲**, **▼**, **◀** or **▶** to display another part of the image.

## Multi-frame playback

Use this function to display a single frame, 2 frames, 9 frames in the folder, or 100 frames regardless of the folder. You can compare and select images using the Multi-frame display. Use the zoom lever to change the display.

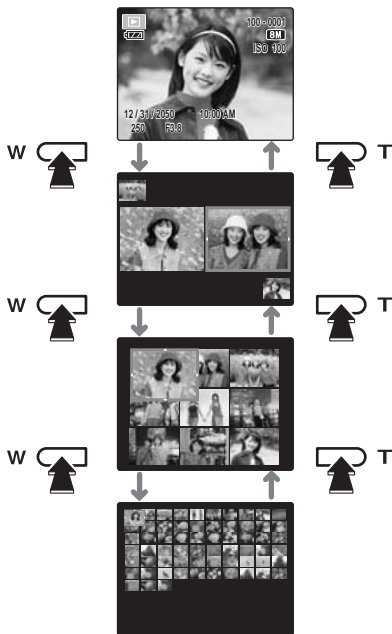

## 2 frames playback

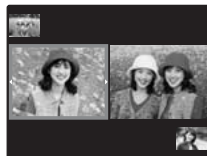

- 1 Select the image you want to compare, such as the image taken in NATURAL & 4 mode.



- 2 Press MENU/OK to enlarge the image.

## 9 frames playback

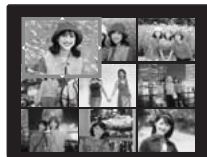

- 1 Change the colored frame and select an image. Press or repeatedly to jump to the next page.





- ② Press MENU/OK to enlarge the image.

### Micro thumbnails playback (100 frames)

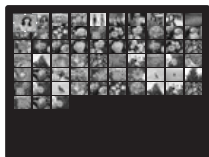

- ① Change the colored frame and select an image.  
Press ▲ or ▼ repeatedly to jump to the next page.



- ② Press MENU/OK to enlarge the image.



#### MEMO

- Keep rotating the wheel dial when reaching the last image in a folder to move to the next folder.
- The [PRIVATE] folder with a password set cannot be displayed.



### Sorting by date

In sorting by date mode (→p.36), you can view all images taken on the same day.



- ① Move the cursor (colored frame) to the selecting frame.



- ② Press MENU/OK to enlarge the image.



#### MEMO

In sorting by date mode, images in one folder are displayed in order of date.  
To display all images in the camera, use micro thumbnails playback.

## Selecting the date





- ① Move the cursor (colored frame) to  on the upper left frame.



- ② Display the selecting date.



- ③ Move the cursor (colored frame) to select the date.  
Press  or  repeatedly to jump to the next page.



- ④ Return to the image selection.

# Erasing the Images/Movies

Setting the camera to   
Playback mode (→p.36)

Use this mode to erase unnecessary images or movies to have ample free space on the Memory Card or internal memory. Your camera calls images "frames".

## Using the erase button (/▲)

Pressing  (▲) erases images easily.

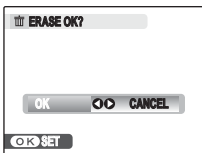

① Select the erasing image.



② Press  (▲).



③ Select [OK].



④ Press MENU/OK to erase the displayed image.

## Erasing from the [PLAYBACK MENU]

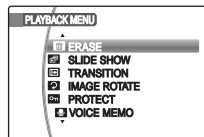

① Press MENU/OK to open the top menu.



② Select [] PLAYBACK MENU].



③ Press MENU/OK to open the [PLAYBACK MENU].



④ Select [] ERASE].



⑤ Move to setting item.

**Continued** 

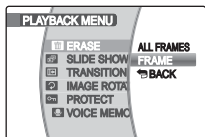

⑥ Select [FRAME] or [ALL FRAMES].



⑦ Press MENU/OK to confirm the setting.

## Erasing one frame at a time ([FRAME])

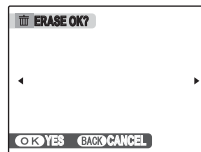

① Select the erasing frame (file).



② Press MENU/OK to erase the currently displayed frame (file).



### MEMO

To erase another frame (file), repeat above steps. When erasing frames (files) is completed, press DISP/BACK.



### CAUTION

Pressing MENU/OK repeatedly erases consecutive frames (files). Take care not to erase a frame (file) by mistake.

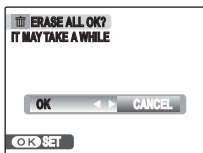
**Erasing all frames ([ALL FRAMES])**

① Select [OK].

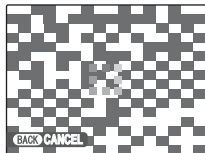

② Press MENU/OK to erase all the frames (files).

 **MEMO**

Press DISP/BACK to cancel erasing of all the frames (files). Some unprotected frames (files) will be left unerased.

 **MEMO**

- When using a Memory Card, the images in the selected folder of the Memory Card are erased. When not using a Memory Card, the images in the internal memory are erased.
- Protected frames (files) cannot be erased. Unprotect the frames (files) before erasing them (→p.87).
- If [DPOF SPECIFIED. ERASE OK?] or [DPOF SPECIFIED. ERASE ALL OK?] appears, press MENU/OK again to erase the frames (files).

 **CAUTION**

Erased frames (files) cannot be recovered. Back up important frames (files) onto your PC or another media.

It is possible to transfer saved images between folders. Your camera calls images "frames". Play back an image or folder to move or copy in advance by referring to "Playback of images in the folder" (→p.37).

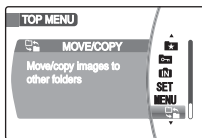

① Press MENU/OK to open the top menu.



② Select [ MOVE/COPY].



③ Press MENU/OK to move to menu item.

## Copying images to another Memory Card

Copy images from folders to the internal memory folder using the [MOVE/COPY] function, then remove the Memory Card and insert another Memory Card into the camera. Then, copy images to the Memory Card from the internal memory folder.

## MEMO

Select the [MY PICTURES] folder to play back images on a memory card shot by another camera without a folder function.

## Moving one frame at a time from a folder ([MOVE])

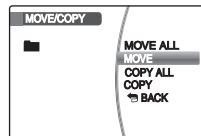

① Select [MOVE].



② Press MENU/OK to open the folder selecting screen.



③ Select the folder to move.





- ④ Press MENU/OK to move the currently displayed frame (file).

**MEMO**

- Images to move can also be selected after selecting a folder to move in step ③.
- When moving frames (files) is completed, press DISP/BACK.

## Moving all frames in a folder ([MOVE ALL])

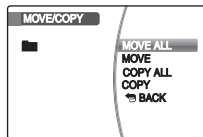

- ① Select [MOVE ALL].



- ② Press MENU/OK to open the folder selecting screen.





- ③ Select the folder to move.





- ④ Press MENU/OK to move all the frames (files).

### ! CAUTION

- When [ MEMORY FULL] or [ MEMORY FULL] appears on the LCD monitor, moving the data stops on the way.
- When moving the image that has specified DPOF setting, the DPOF setting is not moved.

## Copying one frame at a time from a folder ([COPY])

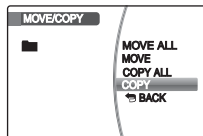

- ① Select [COPY].



- ② Press MENU/OK to open a folder selecting screen.



- ③ Select the folder to copy.







- ④ Press MENU/OK to copy the currently displayed frame (file).

**MEMO**

- Images to copy can also be selected after selecting a folder to copy in step ③.
- When copying frames (files) is completed, press DISP/BACK.

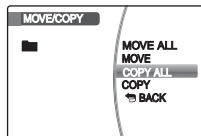
**Copying all frames in a folder ([COPY ALL])**

- ① Select [COPY ALL].



- ② Press MENU/OK to open a folder selecting screen.





- ③ Select the folder to copy.





- ④ Press MENU/OK to copy all the frames (files).

 **CAUTION**

- When [ MEMORY FULL] or [ MEMORY FULL] appears on the LCD monitor, copying the data stops on the way.
- When copying the image that has specified DPOF setting, the DPOF setting is not copied.

# Using the Shooting Functions — Procedure of Setting

Specify the camera settings for taking pictures to get the best result. A general guide is given below.

## 1 Select the Shooting mode.

Set the Shooting mode from the top menu. The camera settings are tailored to the scene being shot.

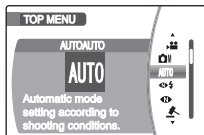

	This mode provides detailed settings that are impossible to set in AUTO mode (→p.54).
AUTO	This is the easiest mode for taking pictures (→p.54).
	Select the best Shooting mode for the scene being shot (→p.54-58).

## 2 Specify the photography settings.

Pressing buttons or selecting menu allows you to specify photography functions. You can obtain the best result for shooting.

### ■ Specifying functions using buttons

Intelligent Face Detection/ Red-eye Removal	Pressing this button allows you to focus on people's faces. Also, red eye-effect, caused by the light of the flash reflecting off the inside of the eye, can be corrected before an image is recorded. (→p.31).
Macro	Used for close-up shots (→p.59).
Flash	Used for shots in dark locations or for backlit subjects, etc. (→p.60).
Self-timer	Used in situations such as group shots where the photographer is included in the shot (→p.63).
Dual IS mode	Reduces camera shake and moving subject blurring (→p.32).

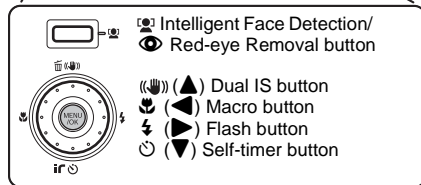
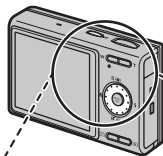

## ■ Specifying functions using [SHOOTING MENU]

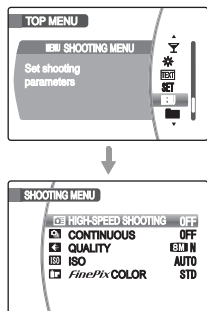

[ HIGH-SPEED SHOOTING]	Use to focus the shot quickly (→p.70).
[ CONTINUOUS]	Use to take pictures continuously (→p.70).
[ QUALITY]	Use to specify required image size (→p.74).
[ ISO]	Use to specify required sensitivity setting (→p.75).
[ FinePix COLOR]	Use to specify required color tone (→p.76).
[ EXP. COMPENSATION]	Use this setting to obtain the correct exposure (only  , ) (→p.73).
[ WHITE BALANCE]	Use to adjust the color tone (only  , ) (→p.74).
[ AF MODE]	Use to specify focusing mode (only ) (→p.77).

# Setting the Shooting Mode

You can select the most suitable setting according to the subject by selecting one of the Shooting modes.

## Setting a Shooting mode suited to the scene

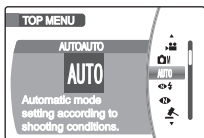

① Press MENU/OK to open the top menu.



② Select the Shooting mode.



③ Press MENU/OK to confirm.

### MEMO

- See p.61 for information on the available flash modes.
- When anything other than AUTO, , , and in the Shooting mode is selected, F-CHROME (→p.76) cannot be set.
- When anything other than in the Shooting mode is selected, only AUTO can be selected for the [ISO ISO] (sensitivity) setting.
- In the Shooting mode, you can change the folder to save images or movies by rotating the wheel dial quickly one time or more.

**Continued** ➔

## [CAM] MANUAL

Set the Photography functions to manual to easily control yourself.

Photography functions:

- [EXP] EXP. COMPENSATION] (→p.73)
- [WB] WHITE BALANCE] (→p.74)
- [AF] AF MODE] (→p.77)

## [AUTO]

This is the easiest mode for providing crisp and clear shots.

Use this mode for ordinary photography.

## [ⓘ⚡ NATURAL & ⚡]

This mode shoots 2 images continuously without flash and with flash. Shooting with flash allows you to take a picture of a main subject brightly. Shooting without flash produces beautiful images that retain the natural ambience. This mode is useful for shooting 2 different types of pictures at the same time.



When pressing the shutter button, first picture is taken without flash and next picture is taken with flash.

Always 2 pictures are taken per 1 shot.

Do not move the camera until the shooting ended.

## MEMO

This mode helps to avoid failed shots that may occur when using other Shooting modes when taking a picture against the sun, etc.

## CAUTION

- Flash fires automatically. Do not use this mode at situations where the flash cannot be used.
- When there is insufficient space on the Memory Card or internal memory for 2 shots, this mode cannot be set.
- Continuous shooting is disabled when setting ⓘ⚡.

## [N] NATURAL LIGHT

This mode produces beautiful images that retain the natural ambience when shots are taken in low-light conditions.

This mode is also ideal for shooting indoor or situations where the flash cannot be used.

Camera sets the high-sensitivity setting when selecting the Natural light mode. This mode is effective for reducing camera shake and moving-subject blurring when taking pictures in low-light conditions.



## CHECK

Flash cannot be used in the Natural light mode.

## [ AUCTION MODE ]

This mode is suitable for shooting pictures for a web auction. You can record 1 to 4 shots as a single image. It is convenient for showing items in various angles for web auctioning.

### <Setting frames>

You can select 4 types of frames:

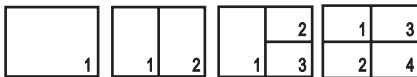

- ① Select [  AUCTION MODE ] from the top menu.



- ② Show a frame selecting display.





- ③ Select the frame.



- ④ Press MENU/OK to confirm the setting.

### CHECK

- The image is recorded in  (640 × 480) size.
- Face detection mode cannot be used.
- When  appears in the LCD monitor, the [  AUCTION MODE ] cannot be used.

## [ PORTRAIT ]

Use this mode for photography to get beautiful skin tones and soft overall tone.



## [ LANDSCAPE ]

Use this mode for shooting scenery in daylight and provides crisp, clear shots of scenery such as buildings and mountains.



### CHECK



Flash cannot be used in the Landscape mode.

## [ SPORT ]

Use this mode to take pictures of a moving subject. It gives priority to faster shutter speeds.



### CHECK

When setting  Sport mode, the camera sets to  High-speed shooting mode (→p.70) automatically.

**Continued** 

## [🌃 NIGHT]

Use this mode for shooting evening and night scenes.

A picture is taken with a slow shutter of up to 3 seconds.



### 🗨️ CHECK

We recommend using a tripod to prevent camera shake. Because a picture is taken with a slow shutter.

## [🎆 FIREWORKS]

Use this mode to shoot fireworks.

It is effective for taking more vivid shots of fireworks with a slow shutter.



### 🗨️ CHECK

- Flash cannot be used in the Fireworks mode.
- Shutter speed setting: 1/2 sec. to 4 sec.
- We recommend using a tripod to prevent camera shake. Because a picture is taken with a slow shutter.

### ■ Selecting the exposure time setting

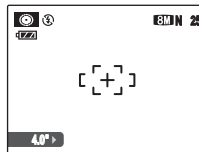

Select the exposure time.



**[🌅 SUNSET]**

Use this mode to shoot sunset, making the colors more vivid.

**[❄️ SNOW]**

Use this mode to prevent darkening images and provide crisp, clear shots, when shooting at snowy scene where the whole screen appears white.

**[🏖️ BEACH]**

Use this mode to prevent darkening images and provide crisp, clear shots, when shooting at beach under strong sunlight.

**[🐠 UNDERWATER]**

Use this mode for shooting with a waterproof case. It is effective for taking more vivid shots of ocean blue.

**[🏛️ OFF MUSEUM]**

Use this mode for taking pictures in places such as museum where the use of flash and making an operation sound and a shutter sound are restricted.

The flash mode is set to suppressed flash and the operation sound, shutter sound, and illumination lamp are disabled.

**📄 MEMO**

Check whether photography is permitted before using this mode.

**Continued** ➡

## [Y PARTY]

Use this mode for shooting at indoor wedding and party.

This mode produces beautiful images that retain the natural ambience when shots are taken in low-light conditions.



## [\* FLOWER]

Use this mode to take clear close-up shots when zooming up a flower.

It is effective for taking more vivid shots of flower petal.



### CHECK

- Flash cannot be used in the Flower mode.
- Focal range  
Wide angle:  
Approx. 9 cm to 80 cm (3.5 in. to 2.6 ft.)  
Telephoto:  
Approx. 30 cm to 80 cm (1.0 ft. to 2.6 ft.)

## [TEXT] TEXT]

Use this mode to shoot documents and white board.

It is effective for taking clearer shots of letters.









### CHECK

- Focal range  
Wide angle:  
Approx. 9 cm to 80 cm (3.5 in. to 2.6 ft.)  
Telephoto:  
Approx. 30 cm to 80 cm (1.0 ft. to 2.6 ft.)

## Macro (Close-up)

Use this mode to take close-up shots.

**Available Shooting modes:** [AUTO], , , , , ,  (→p.54, 55, 57)

Press  (◀) to select Macro mode.

Press  (◀) again to cancel Macro mode.

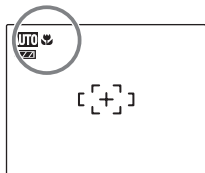
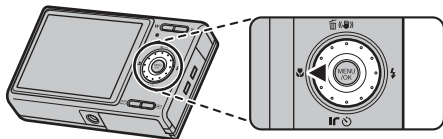



 appears on the LCD monitor indicating that you can take close-up shots.

### CHECK

- Focal range  
Wide angle:  
Approx. 9 cm to 80 cm (3.5 in. to 2.6 ft.)  
Telephoto:  
Approx. 30 cm to 80 cm (1.0 ft. to 2.6 ft.)
- Effective flash range  
Approx. 30 cm to 80 cm (1.0 ft. to 2.6 ft.)

### MEMO

- We recommend using a tripod to prevent camera shake in Macro mode.
- Turning the camera off cancels Macro mode.
- Even if the [] AF MODE is set to [] MULTI (→p.78), the camera focuses near the center of the LCD monitor.

## ⚡ Setting the Flash (Intelligent Flash)

Flash photography is useful for taking pictures at night or indoor dark locations. Choose from 7 flash modes according to the type of shot. See p.51 for information on the available Photography modes.

### 📄 MEMO What is Intelligent Flash?

The Intelligent Flash feature instantly determines the subject's position, distance from the camera, exposure, etc., and automatically adjusts the camera settings to the optimal flash volume and sensitivity for the scene. Even dimly lit indoor scenes can be shot beautifully, just as they appear, without subjects being washed out or losing background details.

The Intelligent Flash feature is always used when shooting with flash.

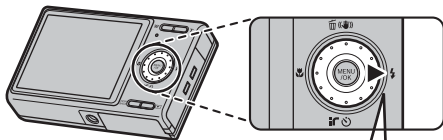

↔ AUTO ↔ ⚡ ↔  
↔ ⚡ ↔ [ ] ↔

The flash setting changes each time you press ⚡ (▶).

↔ [ ] ↔ [ ] ↔ ⚡ ↔  
↔ [ ] ↔ [ ] ↔ [ ] ↔

When [ ] FACE DETECTION REMOVAL ON] is set.

### 📄 MEMO

When pressing the shutter button down halfway, [ ] appears on the LCD monitor before the flash fires.

### [AUTO] Auto flash (not displayed)

Use this mode for ordinary photography. The flash fires as required by the shooting conditions.

### [ ] RED EYE REDUCTION

This mode is suitable for shooting portraits in low-light conditions.

Use this mode to minimize red-eye (eyes appear in red in the finished photo).



### 📄 MEMO Red-eye effect

When using the flash to take a picture of people in low-light conditions, their eyes sometimes appear red in the picture. This is caused by the light of the flash reflecting off the inside of the eye.

### [⚡ FORCED FLASH] [ ] RED EYE & FORCED FLASH

Use this mode in backlit scenes, or to get the correct colors when taking a picture under bright lighting. In this mode, the flash fires in bright as well as dark conditions. Using [ ] synchronizes Red-eye reduction mode.

**[ SUPPRESSED FLASH]**

This mode is suitable for situations where the flash cannot be used.

In dark conditions, we recommend using a tripod.

Any time, flash does not fire.

**[ SLOW SYNCHRO],  
[ RED EYE & SLOW]**

This mode allows you to take pictures of people at night that clearly show both your subjects and the night time backdrop. Always use a tripod in this mode.

Using  synchronizes Red-eye reduction mode.

Using  selects slow shutter speeds of up to 3 seconds.





















** CAUTION**

In bright scenes, overexposure may occur.

**Available flash modes in Photography modes**

Available flash modes in each Photography mode are listed below.

When [ FACE DETECTION  REMOVAL OFF] is set:

	AUTO			
AUTO	✓	✓	✓	
		✓	✓	
			✓	
	✓	✓	✓	✓
	✓	✓	✓	✓
			✓	
	✓	✓	✓	
			✓	✓
			✓	
		✓	✓	
	✓	✓	✓	
	✓	✓	✓	
	✓	✓	✓	
	✓	✓	✓	
	✓	✓	✓	
	✓			
			✓	
		✓	✓	
	✓	✓	✓	✓

Continued 

## ⚡ Setting the Flash (Intelligent Flash)

When [ FACE DETECTION REMOVAL ON] is set:

	AUTO			
AUTO	✓	✓	✓	
		✓	✓	
			✓	
	✓	✓	✓	✓
			✓	✓
		✓	✓	
	✓	✓	✓	
	✓	✓	✓	
			✓	
	✓			
	✓	✓	✓	✓

### CHECK

Effective flash range ( : [AUTO])

Wide-angle:

Approx. 70 cm to 3.6 m (2.3 ft. to 12.8 ft.)

Telephoto:

Approx. 70 cm to 2.9 m (2.3 ft. to 9.5 ft.)

If you take pictures outside of the effective flash range, the image may appear dark even if the flash is used.

### CAUTION Notes on using flash

- If pressing the shutter button while the flash is charging (indicator lamp blinking orange), the picture will be taken without the flash (when using [AUTO] and ).
- The flash charging time may increase when the battery is low on charge.
- When taking a picture using the flash, the image may disappear and go dark briefly due to flash charging. The indicator lamp blinks orange during charging.
- The flash fires several times (pre-flashes and the main flash). Do not move the camera until the picture is taken.

## Self-Timer

The self-timer is used in situations where the photographer is included in the shot.

**Available Shooting modes: All**

### Setting self-timer

The self-timer setting changes each time you press  (▼).

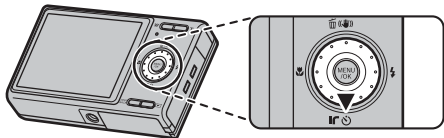

The last displayed setting is the selected mode.

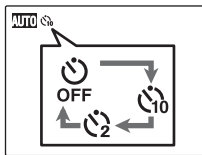

: The picture is taken after 10 seconds.

: The picture is taken after 2 seconds.

### Taking pictures using self-timer

- 1 Press the shutter button down halfway to focus on the subject and press the shutter button fully.

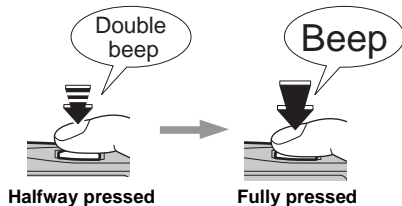

Halfway pressed

Fully pressed

Pressing the shutter button down halfway that focuses on the subject.

Without releasing the shutter button, press the button all the way down (fully pressed) to start the self-timer.

**Continued** ➔

## 2 Take pictures in selected time.

A picture is taken after the self-timer lamp changes from lit to blinking (only blinks with the 2-second self-timer).

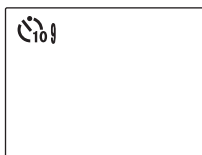
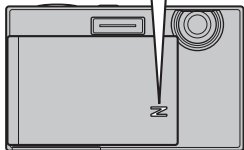
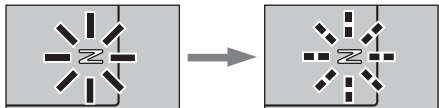

A countdown appears on the LCD monitor indicating the time remaining until the picture is taken.

### *Using the 2-second self-timer*

This is useful when you worry about camera shake even if attaching the camera on a tripod.

#### MEMO

- To stop the self-timer, once it has started running, press DISP/BACK.
- Any of the following cancels the self-timer setting:
  - Completing the shooting
  - Changing the Photography mode setting
  - Setting the camera to Playback mode
  - Turning the camera off
- Take care not to stand in front of the lens when pressing the shutter button as this can prevent the correct focus or brightness (exposure) from being achieved.



## Taking pictures with the self-timer and Intelligent Face Detection function



Available Photography modes: [AUTO], , , , 

, , , , OFF, , 

### Intelligent Face Detection

The Intelligent Face Detection function is especially useful when using the self timer since it ensures that faces will appear in focus automatically.

#### 1 Set the self-timer.

The self-timer setting changes each time you press  ().

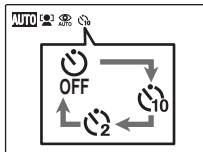
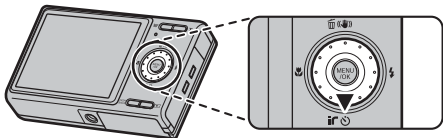

The last displayed setting is the selected mode.

: The picture is taken after 10 seconds.

: The picture is taken after 2 seconds.

#### 2 Press . Intelligent Face Detection setting changes each time you press .

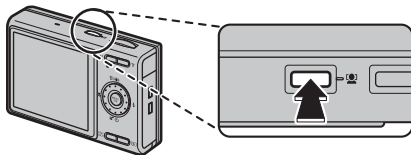

#### 3 Press the shutter button all the way down (fully pressed).



**Continued** ➔

#### 4 Take pictures in selected time.

During the timer countdown, the camera detects people's faces. Just as the picture is taken, the camera focuses on and adjusts the brightness of people's faces.

A picture is taken after the self-timer lamp changes from lit to blinking (only blinks with the 2-second self-timer).

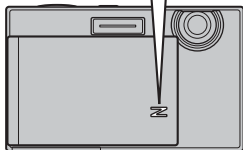
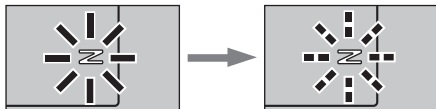

A countdown appears on the LCD monitor indicating the time remaining until the picture is taken.

#### CHECK

See p.31 for Intelligent Face Detection.

#### CAUTION

Do not move, even after countdown has completed. Wait until the picture has been taken completely.

# Using [SHOOTING MENU]

Use the [SHOOTING MENU] to adjust image quality or focus. You can take pictures in a wide range of conditions.

## Setting the [SHOOTING MENU]

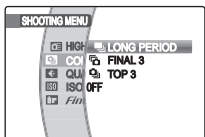

① Press MENU/OK to open the top menu.



② Select [MENU] SHOOTING MENU].



③ Press MENU/OK to open the [SHOOTING MENU].



④ Select the menu.



⑤ Move to setting item.



⑥ Change the setting.



⑦ Press MENU/OK to confirm the setting.

### ■ List of SHOOTING MENU options

Menu	Functions	Settings	Factory default
[] HIGH-SPEED SHOOTING] (→p.70)	This setting can be used when the Shooting mode is set to anything other than . This setting is always set to ON when the Shooting mode is set to . Use this setting to reduce the time required for focusing.	ON/OFF	OFF
[] CONTINUOUS] (→p.70)	This setting can be used when the Shooting mode is set to anything other than . Use this setting to select the required continuous shooting mode.	/ OFF	OFF
[] EXP. COMPENSATION] (→p.73)	This setting can be used when the Shooting mode is set to . Use this setting to obtain the correct exposure.	-2 EV to +2 EV (1/3 EV increments)	±0
[] WHITE BALANCE] (→p.74)	This setting can be used when the Shooting mode is set to . Use this setting to adjust the color balance to suit the color of the ambient light around the subject.	AUTO /  /  /	AUTO
[] QUALITY] (→p.74)	Specifies the image size. The larger image size, the better image quality is obtained. The smaller image size, the larger number of images are recorded. This setting cannot be used when the Shooting mode is set to .	/  /  /  /	
[] ISO] (→p.75)	Specifies required sensitivity setting of the ambient light around the subject. The larger value of the sensitivity, the higher sensitivity is obtained. The higher sensitivity settings will allow you to take pictures in darker locations.	AUTO/1600/800/ 400/200/100/64	AUTO
[] FinePix COLOR] (→p.76)	Specifies required color tone. This mode is effective for taking more vivid shots or black and white shots.	STD//	STD
[] AF MODE] (→p.77)	This setting can be used when the Shooting mode is set to  and . Intelligent Face Detection is set to OFF. Use this setting to specify the focusing mode.	/	

## MEMO

The options available in the [SHOOTING MENU] vary depending on whether the mode is selected.

Shooting mode: [AUTO],



Shooting mode:

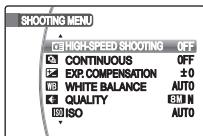

Shooting mode:

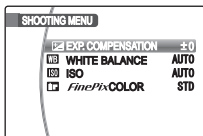

Shooting mode:

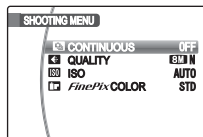

Shooting mode:



## ⚙️ Focusing the shot quickly ([MENU] HIGH-SPEED SHOOTING)

**Available Shooting modes:**

All (except for , ) (→p.54 – 58)

Use this mode to reduce the time required for focusing when pressing the shutter button down halfway. It is useful to avoid missing snapshot opportunities.

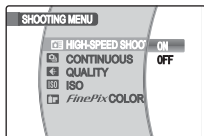



### ⚠️ CAUTION

The [LCD MODE] function on the [SET-UP] menu cannot be set in this mode (→p.109).

### 📄 MEMO

- The available shooting distance is from about 1 m (3.3 ft.) to infinity.
- When taking pictures while the High-speed shooting mode is set to ON, the battery will run down more quickly.



### ✅ CHECK

When setting  Sport mode, the camera sets to  High-speed shooting mode automatically.



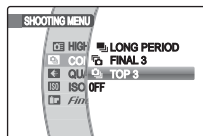

## ⚙️ Taking pictures continuously ([MENU] CONTINUOUS)

Use this mode to take pictures of a moving subject.



- : [LONG PERIOD] continuous shooting
- : [FINAL 3] continuous shooting
- : [TOP 3] continuous shooting

**! CAUTION**

- As long as the shutter button is held down, the camera will continue to take pictures.
- Number of available frames is limited depending on the available space on the Memory Card or internal memory.
- In [TOP 3] and [FINAL 3] continuous shooting mode, the focus is determined in the first frame and cannot be changed in mid-sequence.
- The exposure is determined in the first frame, but in [LONG PERIOD] continuous shooting the exposure is adjusted for the scene being shot.
- The speed of continuous shooting varies depending on the shutter speed.
- The flash cannot be used as the flash mode is set to  Suppressed flash (→p.61). However, if you switch back to the normal shooting setting, the flash mode resets to what it was before you selected continuous shooting.
- For [TOP 3] and [FINAL 3] continuous shooting, the results are always displayed after you shoot. Note that pictures taken using [LONG PERIOD] continuous shooting are recorded without displaying the results.
- Only 1 frame can be shot when using the [FINAL 3] or [LONG PERIOD] continuous shooting mode and Self-timer mode together.
- Continuous shooting cannot be selected in  NATURAL &  setting and [ AUCTION MODE].
- Recording times may be longer for files shot with [TOP 3] continuous shooting or [FINAL 3] continuous shooting.

** TOP 3] continuous shooting****Available Shooting modes:**

All (except for , ) (→p.54 – 58)



Shooting continues as long as holding the shutter button down. This mode shoots up to 3 frames (max. 2.2 frames/sec.).

### FINAL 3 continuous shooting

**Available Shooting modes:**

**All** (except for , ) (→p.54 – 58)

Shooting continues as long as holding the shutter button down.

This mode shoots up to 40 times (max. 2.2 frames/sec.). The camera records the final 3 frames shot when you release the shutter button.

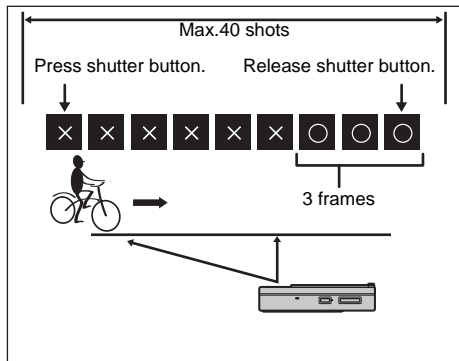

### LONG PERIOD continuous shooting

**Available Shooting modes:**

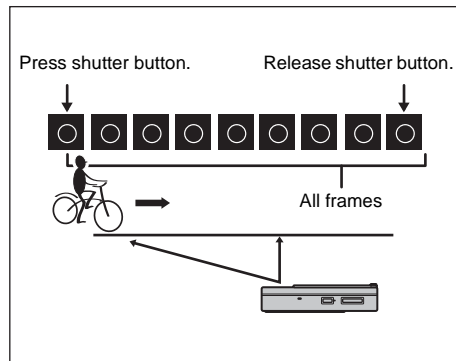

**All** (except for , ) (→p.54 – 58)

Shooting continues as long as holding the shutter button down. This mode shoots up to Memory Card or internal memory end.





## Adjusting exposure compensation ([ EXP. COMPENSATION])

Available Shooting mode: ,   
(→p.54, 55)

Use this menu for shots to get the correct brightness (exposure), such as shots with extremely high contrast between the subject and the background.

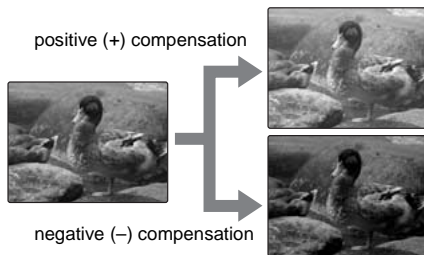
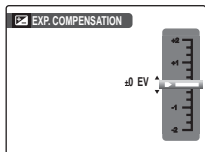

### CHECK

- Compensation range: -2 EV to +2 EV (13 steps in 1/3 EV increments)
- Explanation of Terms "EV" (→p.154)

## Guide to compensation

- Backlit portraits: +2/3 EV to +1 2/3 EV







- Very bright scenes (such as snowfields) and highly reflective subjects: +1 EV



- Shots made up predominantly of sky: +1 EV
- Spotlit subjects, particularly against dark backgrounds: -2/3 EV
- Scenes with low reflectivity, such as shots of pine trees or dark foliage: -2/3 EV

### MEMO

- The exposure compensation setting is retained when the camera is turned off ( icon appears). Set the exposure value to "±0 EV" unless compensation is required.
- Any of the following disables exposure compensation:
  - Using the flash in [AUTO] or  mode
  - Shooting dark scenes in  or  mode

## Adjusting color balance ([WB] WHITE BALANCE)

Available Shooting mode:   
(→p.54, 55)

Adjust the color balance based on white to suit the color of the ambient light around the subject.

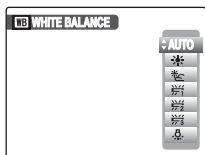

AUTO: Automatic adjustment

: Shooting outdoors in good weather

: Shooting in shade

: Shooting under Daylight fluorescent lamps

: Shooting under Warm White fluorescent lamps

: Shooting under Cool White fluorescent lamps

: Shooting in incandescent light

### MEMO

- In AUTO mode, the correct white balance may not be achieved for subjects such as close-ups of people's faces and pictures taken under a special light source. Select the correct white balance for the light source.
- When the flash fires, the white balance setting for the flash is used. Consequently, to achieve a particular effect, the flash mode should be set to Suppressed flash (→p.61).
- The color tones may vary depending on the shooting conditions (light source, etc.).

- We recommend playing back images after shooting to check the color tones (white balance).
- Explanation of Terms "White Balance" (→p.154)

## Changing the quality setting ([Q] QUALITY)

Use this menu to specify the image size (number of recorded pixels).

Select the quality setting for the scene being shot.

### Quality settings in Photography mode

Quality mode	Sample uses
(3264 × 2448)	Printing at up to 10R (25.4 × 30.5 cm / 10 × 12 in.) / A4 size For better quality, select .
(3264 × 2448)	
(3072 × 2176)	
(2304 × 1728)	Printing at up to 6R (15.2 × 20.3 cm / 6 × 8 in.) / A5 size
(1600 × 1200)	Printing at up to 4R (10.2 × 15.2 cm / 4 × 6 in.) / A6 size
(640 × 480)	To use for e-mail or web site

**Area shot and quality setting****Area shot excluding 3:2****Area shot with 3:2**

Normal shooting provides an aspect ratio of 4:3 and **3:2** shooting provides an aspect ratio of 3:2 (same aspect ratio as 35 mm film and post card).

**MEMO**

- The bigger the number of recorded pixels, the better the image quality becomes. As the number of recorded pixels becomes smaller, you will be able to record more frames to a Memory Card.
- The quality setting is retained even when the camera is turned off or the mode setting is changed.
- When changing the quality setting, the number of available frames also changes (→p.152). The numbers to the right of setting show the number of available frames.

## Changing the sensitivity setting ([ISO] ISO)

Use this menu to specify required sensitivity setting of the ambient light around the subject.

The larger value of the sensitivity, the higher sensitivity is obtained. The higher sensitivity settings will allow you to take pictures in darker locations.

**CHECK****Settings**

[AUTO]/1600/800/400/200/100/64

Selecting [AUTO] as the sensitivity setting, the camera selects the best sensitivity setting for the subject's brightness.

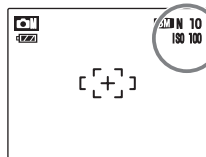

The selected sensitivity setting appears on the LCD monitor when the sensitivity setting is set to another setting excluding [AUTO].

**Continued** ➔

 **MEMO**

When anything other than [MANUAL] in the Photography mode is selected, only [AUTO] can be selected for the [ISO ISO] (sensitivity) setting.

 **CAUTION**

Although higher sensitivity settings will allow you to take pictures in darker locations, they will also increase the amount of speckling in your images. Choose the sensitivity setting that best suits the conditions.

 **Changing the FinePix COLOR setting ([FINEPIX] FinePix COLOR)**

Use this menu to specify required color tone. It is effective for taking vivid shots or black and white shots.

 **CHECK****FinePix COLOR settings**

[F-STANDARD]	The contrast and color saturation are set to standard. Use this mode for normal photography.
[CHROME] F-CHROME	The contrast and color saturation are set to high. This mode is effective for taking more vivid shots of subjects such as scenery (blue sky and greenery) and flowers.
[B&W] F-B&W	This mode converts the colors in the photographed image to black and white.

When setting [CHROME] F-CHROME or [B&W] F-B&W, the icon appears on the LCD monitor.

 **CAUTION**

When anything other than [AUTO], [MANUAL], [NATURAL & LIGHT], [NATURAL LIGHT] and [AUCTION MODE] in the Shooting mode is selected, [CHROME] does not appear on the LCD monitor.

**MEMO**

- The [FinePix COLOR] setting is retained even when the camera is off or the mode setting is changed.
- [F-CHROME] may have little visible effect with some subjects or the scene being shot. You may not be able to see any difference on the LCD monitor.



## Specifying focusing mode ([AF] AF MODE)

**Available Shooting mode:**  (→p.54)  
**(When Intelligent Face Detection is turned OFF)**

Use this mode to specify focusing mode that best suits the subject.

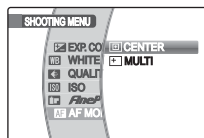

: CENTER  
: MULTI

### [] CENTER

The camera focuses on the center of the LCD monitor.  
Use this setting when taking pictures with AF/AE lock (→p.33).

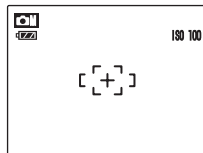

**[MULTI]**

When pressing the shutter button down halfway, the camera recognizes any strongly contrasting subject near the center of the LCD monitor and displays the AF frame over subject in focus.

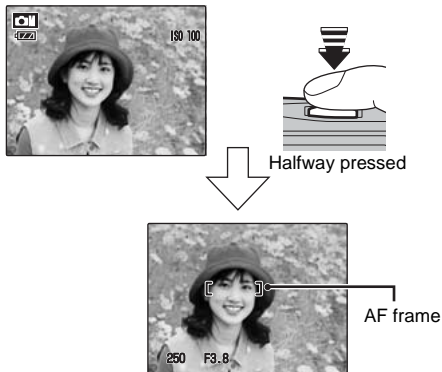
**! CAUTION**

When taking pictures in Macro mode, the camera focuses on the center of the LCD monitor.

**MEMO**

When the AF frame does not appear in the focusing position, select [CENTER] in the AF mode and use AF/AE lock (→p.33).

## Sending and receiving images ([MENU] IR COMMUNICATION)

You can send photographed images to another FUJIFILM digital camera (if it has IR Capability), other devices with high-speed infrared transmission capability, or any other mobile device with the IrSimple function. You can also receive photographed images from a FUJIFILM digital camera, another device with high-speed infrared transmission capability, or another mobile device with the IrSimpleShot™ (IrSS™) function.

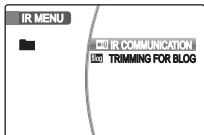

- ① Press to set the camera to Playback mode (→p.36).



- ② Press (▼) to open the [IR MENU].



- ③ Select [IR COMMUNICATION].



- ④ Press MENU/OK.



### MEMO

You can specify the infrared transmission setting in the [SET-UP] menu. See p.103, 105 for information on specifying the infrared transmission setting.



### CHECK

Refer to the manual provided with each device for more information.

## Sending image data

Sending image data to a FUJIFILM digital camera is shown as an example here. You can send the data to another device in the same way.

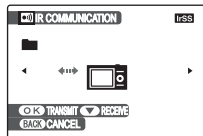

- ① Turn the camera on.



- ② Select the sending frame (file).

**Continued** ➔

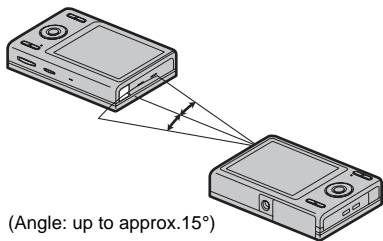

(Angle: up to approx.15°)

- ③ Point the infrared port on the transmitting camera directly at the infrared port on the receiving camera (→p.12). Transmission distance is about 5 to 20 cm (2 to 7.9 in.) within approx. 15°.



- ④ Press MENU/OK to begin transmission. When transmission is completed, [TRANSMISSION COMPLETED] will appear on the LCD monitor.

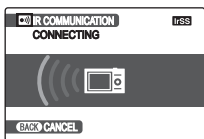

**! CAUTION**

- Make sure the receiving camera is turned on when transmitting image data.
- If the image is 3:2 ratio, white lines may appear at the top and bottom or right and left of the print, depending on the printer type.

- Movie images cannot be transmitted.
- Images photographed with a camera other than FinePix Z100fd may not be printed or transmitted.

**✓ CHECK**

- Refer to the manual provided with the receiving device for more information.
- When exchanging images with another Z100fd, images are saved automatically in the same folder as the transmitting camera.

**Receiving the image data**

Receiving the image data from a FUJIFILM digital camera is shown as an example here. You can receive data from another device in the same way.

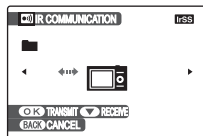

- ① Turn the camera on.



- ② Select the sending frame (file).



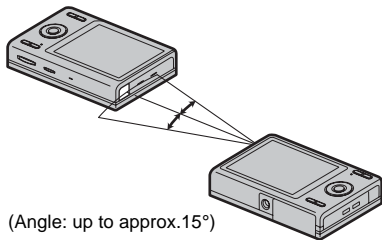

(Angle: up to approx.15°)

- ③ Point the camera's infrared port towards the front of the camera's infrared port (→p.12). Transmission distance is about 5 to 20 cm (2 to 7.9 in.) within approx. 15°.



- ④ Press ▼ to begin receiving.  
When receiving is completed, [DATA RECEIVED] will appear on the LCD monitor.

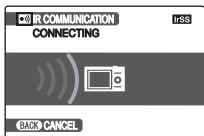

### ! CAUTION

- Movie images cannot be transmitted.
- Image data may be compressed when transmitted.
- If [COMMUNICATION ERROR], [CANNOT BE TRANSMITTED], or [CANNOT BE RECEIVED] appears, press MENU/OK or ▼ to retransmit the image data, or press DISP/BACK to cancel transmitting.
- Do not place anything between the transmitting and receiving device.
- Leaving the camera in direct sunlight or directly under fluorescent lighting may prevent successful data transfer.
- Successful transfer may not be possible when transmitting near infrared transmission devices (such as the remote controller of TV or VCR) or devices that generate electrical noise.
- Correctly aim the infrared port towards the front of the device or camera's infrared port during image data transmission.

### ✓ CHECK

When exchanging images with another Z100fd, images are saved automatically in the same folder as the transmitting camera.  
When receiving images from a camera other than Z100fd, images are saved in the [MY PICTURES] folder.

### 📝 MEMO

When playing back an image received from another camera, 📷 (present icon) will appear in the LCD monitor.

## Transmitting and saving blog images

### ([Blog] TRIMMING FOR BLOG)

You can change the pictures you take to a smaller size and then transmit or save them. This function is perfect when you want to post your pictures on a blog or other online forum. It is also possible to trim images before transmitting or saving them.

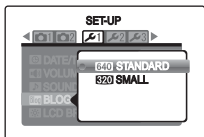

Using the [SET-UP] menu (refer to p.103), select the [Blog] BLO IMAGE SIZE. The sizes for blog images are [640 STANDARD](640 × 480) or [320 SMALL](320 × 240) (→p.104). The size will be [640 STANDARD](768 × 512) or [320 SMALL](384 × 256) for images shot at 3:2.

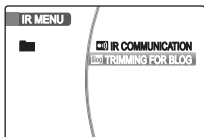

- 1 Press [▶] to set the camera to Playback mode (→p.36).



- 2 Press [IR] (▼) to open the [IR MENU].



- 3 Select [Blog] TRIMMING FOR BLOG.



- 4 The Transmit/Save screen appears.

### MEMO Trimming Images

You can trim out the desired area of an image before transmitting or saving it.

- 1 Zoom the image in or out with the **W** button (zoom out) or **T** button (zoom in).
- 2 Press ▲▼◀▶ to move the screen to the area you want to trim out.
- 3 Press MENU/OK to confirm the setting and return to the Transmit/Save screen.

### MEMO Effect on images

You can apply color effects on images, [EFFECT1] (illustration style) or [EFFECT2] (painting style).

- 1 Press ▲ to select [EFFECT1] or [EFFECT2].
- 2 Press ▼ to save effect.

## Transmitting blog images

You can resize images to VGA and then transmit them to a device that supports the IrSimple function.

## Saving blog images



① Select the frame (file) to save.



② Press **ir** (▼) to save the image.



### CHECK

- Saved blog images have filenames that start with “BLOG” when they are imported to a PC or similar device.
- When saved blog images are played back, **BLOG** appears on the screen and the images are surrounded by a black frame.



### CAUTION

Saved blog images cannot be rotated or trimmed.



### MEMO

Images rotated with [**Q** IMAGE ROTATE] are transmitted or saved in their rotated state.

# Using [PLAYBACK MENU]

Use this menu to play back photographed images.

## Setting the [PLAYBACK MENU]

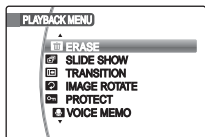

- ① Press  to set the camera to Playback mode (→p.36).



- ② Press MENU/OK to open the top menu.



- ③ Select [MENU] PLAYBACK MENU].



- ④ Press MENU/OK to open the [PLAYBACK MENU].



- ⑤ Select the menu.



- ⑥ Move to setting item.

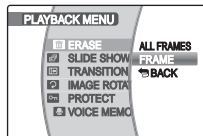

- ⑦ Change the setting.



- ⑧ Press MENU/OK to confirm the setting.

## Setting automatic playback ([ SLIDE SHOW])

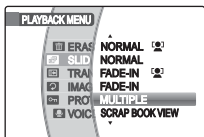

Use this mode to play back photographed images continuously. You can select playback interval and type of image transition.



### MEMO

- To interrupt [ SLIDE SHOW], press MENU/OK.
- Press ◀ or ▶ to advance or go back through the images when selecting [NORMAL] or [FADE-IN].
- You can select BGM during slide show.
- Scrap book view will select the size and position of the images automatically.
- You can watch a slide show without AV connection between camera and IR capable TV by selecting [IrSS]. For details on IR model, see our web site: [http://www.fujifilm.com/products/digital\\_cameras/support/ir.html](http://www.fujifilm.com/products/digital_cameras/support/ir.html)
- The Auto power off function (→p.111) does not operate during a slide show.
- Movie starts automatically. When the movie ends, the playback function moves it on.
- Press DISP/BACK once during playback to display on-screen help.

## Intelligent Face Detection

The camera plays back the image taken with Intelligent Face Detection (→p.31) zoomed in on the detected face when [NORMAL ] or [FADE-IN ] is selected.

## Selecting the type of image transition ([ TRANSITION])

Use this mode to wipe, slide-in or fade-in the images.

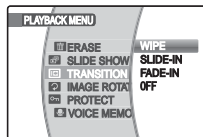

Select the image transition.

The image is displayed with selected transition.

## Rotating the images ([IMAGE ROTATE])

When shooting in the vertical position, the image appears horizontal on the LCD monitor. Use this mode to rotate an image and to display correct direction.

### CAUTION

Protected frames (files) cannot be rotated. Unprotect the frames (files) before rotating them (→p.87).

### MEMO

An image can be rotated only when playing back using FinePix Z100fd. You may not be able to rotate images that were shot with a camera other than FinePix Z100fd.

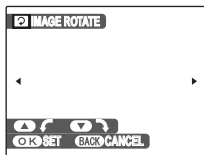

① Select the frame (file) to rotate.



② Press MENU/OK to open the top menu.



③ Select [PLAYBACK MENU].



④ Press MENU/OK to open the [PLAYBACK MENU].



⑤ Select [IMAGE ROTATE].



⑥ The image rotating screen appears.

⑦ Rotate the image.

▼: Rotates the image clockwise at a 90 degree angle.

▲: Rotates the image counterclockwise at a 90 degree angle.

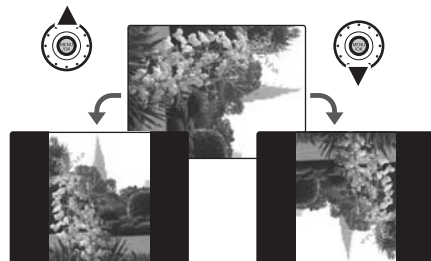



- ⑧ Press MENU/OK to confirm the setting. Next time the image is played back, it will be automatically rotated. Press DISP/BACK to cancel rotating the image.



## Protecting the images ([] PROTECT)

Use this mode to prevent frames (files) from being accidentally erased. Your camera calls images “frames”.

### [FRAME] (set or reset a frame)

To protect or unprotect only the selected frame (file):

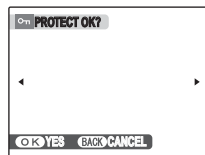

Unprotected

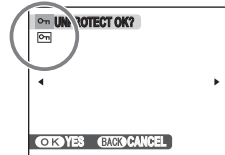

Protected ( appears)



- ① Select the protecting/unprotecting frame (file).



- ② Press MENU/OK to protect/unprotect the currently displayed frame (file).  
Unprotected: protecting frame (file)  
Protected: reset frame (file)

To protect another frame (file), repeat steps ① and ②. When protecting frames (files) is completed, press DISP/BACK.

**[SET ALL]**

Press MENU/OK to protect all the frames (files).

**[RESET ALL]**

Press MENU/OK to unprotect all the frames (files).

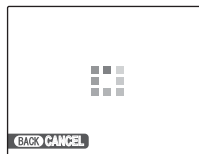
 **MEMO To stop the procedure midway**

If the images are very large, protecting or unprotecting all the frames (files) may take some time.

If you want to take a picture or record a movie during the procedure, press DISP/BACK.

 **CAUTION**

The Format function erases all the frames (files), including protected frames (files) (→p.111).



## Adding voice memos to the images ([ VOICE MEMO])

Voice memos of up to 30 seconds can be added to still images.

### Recording voice memos



- ① Press  to set the camera to Playback mode (→p.36)



- ② Select the image to add a voice memo.



- ③ Press MENU/OK to open the top menu.



- ④ Select [ PLAYBACK MENU].



- ⑤ Press MENU/OK to open the [PLAYBACK MENU].



- ⑥ Select [ VOICE MEMO].



- ⑦ The recording screen appears.

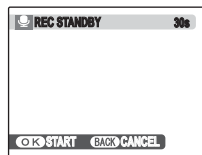

- ⑧ Press MENU/OK to start recording.

Face the microphone to record your comment. Hold the camera about 20 cm (7.9 in.) away for the best results.

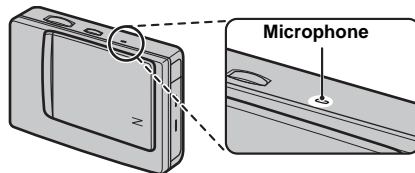

**Continued** ➔

The remaining recording time appears during recording.

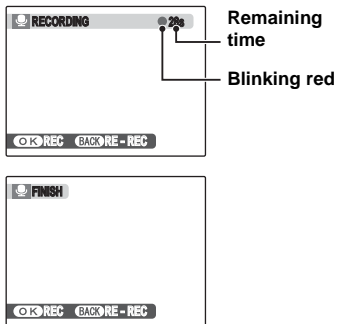

- ⑨ The voice memo ends when pressing MENU/OK midway or 30 seconds pass.

To record your comment: press MENU/OK.  
To rerecord the comment: press DISP/BACK.

## MEMO

- When the image already has a voice memo

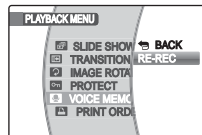





If you select an image that already has a voice memo, a screen appears in which you can select whether to rerecord the memo.

- When [PROTECTED FRAME] appears, unprotect the frame (→p.87).
- Voice memos cannot be added to movies.

## Playing back voice memo



Select an image file with a voice memo.  appears on the LCD monitor.  
(Setting the camera to  Playback mode  
(→p.36))

After playback ends, the playback repeats automatically.  
Press   during playback to go to the next file.

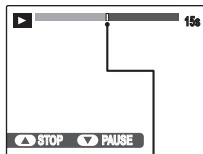

The playback time appears on the LCD monitor along with a progress bar.

**Progress bar**



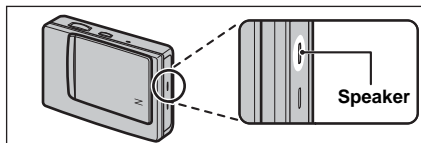

As for playback volume, please adjust from the [SET-UP] menu. (→p.103)

### CAUTION



Uncover the speaker.  
The sound may be difficult to hear.

## ■ Playing back voice memos

	Control	Description
Pause / Resume		Pauses the voice memo during playback. Press  again to resume playback.
Stop		Stops playback. Press  or  while voice memo playback is stopped to go back to the previous file or advance to the next file respectively.

### CHECK

- Audio recording format:  
WAVE (→p.154), PCM recording format
- Audio file size:  
Approx. 480 KB (for a 30-second voice memo)

### MEMO Playing back voice memo files

- You may not be able to play back some voice memo files recorded on other cameras.
- Fast Forward/Rewind function is not available in this camera.

## DPOF set frame ([ PRINT ORDER (DPOF)])

You can specify the image, number of prints, with or without date of printing with a DPOF-compatible printer.

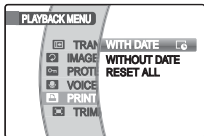



[WITH DATE ]: The date will be imprinted on your prints.

[WITHOUT DATE]: The date will not be imprinted on your prints.

[RESET ALL]: All DPOF settings will be canceled.

### [WITH DATE ] / [WITHOUT DATE]

Selecting [WITH DATE ],  appears on the LCD monitor and the date will be imprinted on your prints.

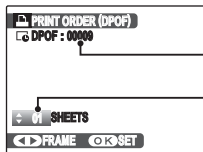

Total number of prints

Setting for that frame



① Display the frame (file) for specifying DPOF setting.



② Set a value.

Up to 99 sheets are printed.

For frames (files) that you do not want printed, set the number of prints to 0 (zero).

To specify more DPOF settings, repeat steps ① and ②.



③ Always press MENU/OK after the settings are completed.

Pressing DISP/BACK cancels those settings.







④ Press MENU/OK again.

The total number of prints appears on the LCD monitor.



### MEMO Canceling DPOF setting

- ① Press MENU/OK to open the top menu.
- ② Select [] PLAYBACK MENU].
- ③ Press MENU/OK to open the [PLAYBACK MENU].
- ④ Select [] PRINT ORDER (DPOF)].
- ⑤ Press .
- ⑥ Select [WITH DATE ] or [WITHOUT DATE] and press MENU/OK.
- ⑦ Select the frame (file) with the DPOF setting you want to cancel.
- ⑧ Press  to set the number of prints to 0 (zero).

To cancel the DPOF setting for another frame (file), repeat steps ⑦ and ⑧.

Always press MENU/OK to complete the settings.

• [RESET ALL] (→p.94)

 **MEMO**

- When DPOF settings were specified on another camera.

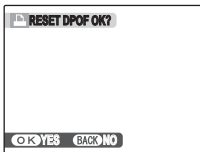

When the data includes a frame (file) with DPOF settings that were specified on another camera, [RESET DPOF OK?] appears.

Pressing MENU/OK erases all of the DPOF settings already specified for each frame (file). Specify the DPOF setting for each frame (file) again.



- Prints of up to 999 frames (files) can be ordered on the same Memory Card.
- DPOF settings cannot be specified for movies.

 **CAUTION**

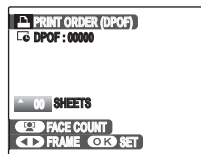
- Pressing DISP/BACK while choosing settings will cancel all current settings. If there were previous DPOF settings, only the modifications are canceled.
- When selecting the [WITH DATE] setting, the date is imprinted on your shots using the Print Service or a DPOF-compatible printer (depending on the printer specifications, the date may not be printed in some cases).
- Images photographed with a camera other than FinePix Z100fd may not be specified DPOF settings.

 **Intelligent Face Detection**

When setting images taken with Intelligent Face Detection (→p.31) (👤) appears on the LCD monitor, if you press  (Intelligent Face Detection), frames appear around the faces detected by the camera, and the number of frames is set as the number of prints. This allows you to easily prepare the same number of prints as the number of people detected by the camera.

In addition, you can adjust the number of prints by pressing  or . To reset the number of prints to the number of detected faces, press  (Intelligent Face Detection) again.

Make sure to press MENU/OK when your settings are complete.

**Continued** 

**[RESET ALL]**

To cancel all DPOF settings:

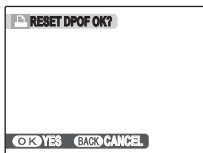

Select [RESET ALL] in the [PLAYBACK MENU] (→p.92).

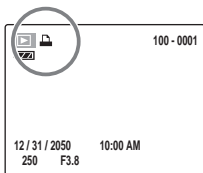

Press MENU/OK.

 **MEMO**

 appears on the LCD monitor during playback when the image has specified DPOF settings.

**PRINT ORDER (DPOF)**

DPOF stands for Digital Print Order Format and refers to a format that is used for recording printing specifications for images shot using a digital camera on media such as a Memory Card. The recorded specifications include information on which frames are to be printed.

This section gives a detailed description of how to order your prints with FinePix Z100fd.

\*Some printers do not support date and time imprinting or specification of the number of prints.

\*The warnings shown below may appear while specifying the prints.

[DPOF SPECIFIED. ERASE OK ?]

[DPOF SPECIFIED. ERASE ALL OK ?] (→p.45)

When erasing the image, the DPOF setting for that image is deleted at the same time.

[RESET DPOF OK ?] (→p.93)

When inserting a Memory Card that contains images specified for printing by another camera, those print specifications are all reset and replaced by the new print specifications.

[DPOF FILE ERROR] (→p.137)

Up to 999 images can be specified on the same Memory Card.

## Trimming the images ([TRIMMING])

Use this mode to trim the required part of the photographed image.

### CHECK

Before selecting [TRIMMING] menu, select the frame (file) to trim.

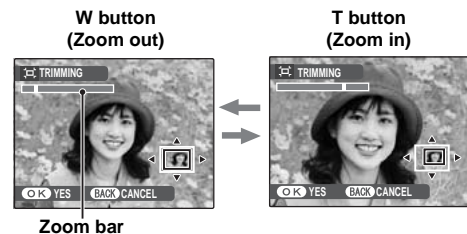

- Press **W** or **T** to zoom in or out on an image.



Navigation screen  
(Current displayed image)



- Press **▲**, **▼**, **◀**, or **▶** to display another part of the image.



- Press **MENU/OK**.

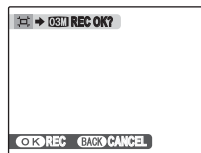

- Check the saved image size and press **MENU/OK**.  
The trimmed image is added as a separate file in the final frame.



## MEMO

- Pressing DISP/BACK in step ① or ② returns to single-frame playback.
- A saved image size varies depending on the zoom scale of step ①. For 0.3 M, **OK** YES option appears in yellow.
- Image sizes

4M	Printing at up to 6R (15.2 × 20.3 cm/6 × 8 in.) / A5 size
2M	Printing at up to 4R (10.2 × 15.2 cm/4 × 6 in.) / A6 size
0.3M	To use for e-mail or web site

- When **3:2** quality setting is selected, the image is trimmed to normal size (4:3 aspect ratio).

## CAUTION

You may not be able to trim images that were shot with a camera other than FinePix Z100fd.

## Intelligent Face Detection



For images taken with Intelligent Face Detection (→p.31) (IFD appears on the LCD monitor), you can zoom in on the focused faces and easily trim the main subject by pressing **OK** (Intelligent Face Detection). When you want the freedom to trim a particular location, you can adjust images with the normal trimming procedure.

# Recording Movies

Use this mode to record movies with sound.

## 1 Set the camera to Movie mode.

With the camera in Playback mode, press the shutter button down halfway to return to Shooting mode. Select a folder to save movies in advance by referring to “2 Select the folder” (→p.27).



① Press MENU/OK to open the top menu.



② Select [ MOVIE].



③ Press MENU/OK to confirm.

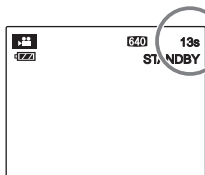

The available recording time appears on the LCD monitor.

## ■ Zooming the image

You must zoom beforehand as you cannot zoom during recording.

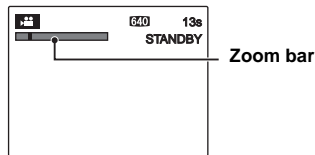

Zoom bar



Press **W** or **T** to zoom in or out on an image.

## CHECK

- Optical zoom focal length  
Approx. 36 mm to 180 mm (35 mm camera equivalent)  
Max. zoom scale: 5x
- Focal range  
Approx. 60 cm (2.0 ft.) to infinity

## 2 Record movies.



Fully pressed

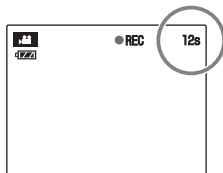

Press the shutter button down fully to start recording. During recording, [●REC] and a counter that shows the remaining time appear on the LCD monitor.



Halfway pressed

Recording ends when pressing the shutter button down halfway during recording or the remaining time runs out.



### MEMO

There is no need to hold down the shutter button during recording.



### CHECK Recording movies

- Specifications: Motion JPEG (→p.154), Monaural sound
- Quality selection method: **640** (640 × 480 pixels)  
**320** (320 × 240 pixels)
- Frame rate (→p.154): 30 frames per second (fixed)



### MEMO

- The brightness and color of the LCD monitor shown during movie recording may differ from those shown before recording begins.
- Pressing the shutter button down fully fixes the focus, however the exposure and white balance are adjusted to the scene being shot.
- If recording is stopped immediately after it begins, 1 second of the movie is recorded onto the Memory Card or internal memory.



### CAUTION

- Because a movie is recorded onto the Memory Card or internal memory as it is saved, it cannot be recorded correctly if the camera suddenly loses power (if the battery runs out or the AC power adapter is disconnected).
- A movie file taken by FinePix Z100fd may not be playable on other cameras.
- Because sound is recorded concurrently with the images, make sure that you do not cover the microphone with a finger, etc. (→p.12).
- Camera operation noises may be recorded during movie shooting.
- The size of a movie file can be up to 2GB.

## Changing movie size

Press MENU/OK to open the top menu to select [SHOOTING MENU].

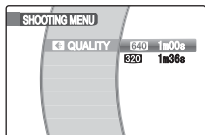

① Select [MENU/OK] QUALITY].



② Move to menu item.



③ Change the setting.



④ Press MENU/OK to confirm the setting.

### Quality settings in Movie mode

**640** (640 × 480 pixels): For better quality

**320** (320 × 240 pixels): To record longer movies

### MEMO

- The quality setting is retained even when the camera is turned off or the mode setting is changed.
- In Movie mode, you cannot set the [ISO] (sensitivity) setting and [FinePix COLOR] setting.
- See p.152 for information on recording times per **xD-Picture Card** or internal memory.

### CAUTION

If you shoot using the **xD-Picture Cards** with model numbers containing "M" such as DPC-M1GB, movie recording time may be reduced if you repeatedly record and erase (frame erase) image files. In such a case, erase all frames or format the **xD-Picture Card** before use. Back up important frames (files) onto your PC or another media.

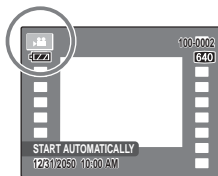

Playback starts automatically.  
After playback ends, the playback repeats automatically.  
Press ◀▶ during playback to go to the next file.

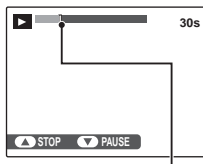



### Progress bar

As for playback volume, please adjust from the [SET-UP] menu. (→p.103)

The playback time appears on the LCD monitor along with a progress bar.

## ■ Playing back movies

	Control	Description
Pause / Resume		Pauses the movie during playback. Press ▼ again to resume playback.
Stop		Stops playback. Press ◀ or ▶ while playback is stopped to go back to the previous file or advance to the next file respectively.

### MEMO

Fast forward/Rewind and Skip playback function are not available in this camera.

**Continued** ➔

**MEMO**

If the subject of the shot is very bright, white vertical streaks or black horizontal streaks may appear in the image during playback. This is normal.

**CAUTION**

- You may not be able to play back some movie files recorded on other cameras.
- To play back movie files on a PC, save the movie file on the Memory Card or internal memory to the PC's hard disk and then play back the saved file.
- Uncover the speaker. The sound is difficult to hear.

## Using the [SET-UP] menu

### 1 Open the [SET-UP] menu.



- ① Press MENU/OK to open the top menu.



- ② Select [SET] SETUP.



- ③ Press MENU/OK to open the [SET-UP] menu.

### 2 Change the page.

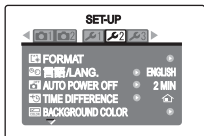

- ① Select the page.



- ② Move to menu item.

### 3 Change the setting.

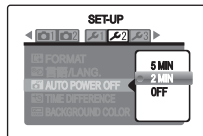

- ① Select the menu.



- ② Different type of screen appears depending on selected item.



- ③ Change the setting.



- ④ Press MENU/OK to confirm the setting.

## SET-UP menu option

	Setting	Display	Factory default	Explanation	Page
📷1	[📷] IMAGE DISP.]	[3 SEC]/[1.5 SEC]/ [ZOOM (CONTINUOUS)]	[1.5 SEC]	Sets the way for displaying the check image screen (photograph result) after taking a picture. The color tones in images recorded may differ from actual color. Play back the recorded images to check them.	106
	[📷] FRAME NO.]	[CONT.]/[RENEW]	[CONT.]	Specifies whether frame numbers are assigned consecutively from previous numbers or begin again.	107
	[📷] DUAL IS MODE]	[👉]1 CONTINUOUS/ [👉]2 SHOOTING ONLY]	👉]1	Specifies whether the Dual Image Stabilization function is activated always at photography mode or it is activated only when shutter button is pressed down halfway.	108
	[➡] ILLUMINATION]	[ON]/[OFF]	[ON]	Sets whether the illumination lamp lights at startup and after shooting is complete.	108
	[🔍] DIGITAL ZOOM]	[ON]/[OFF]	[OFF]	Specifies whether digital zoom is used together.	108
📷2	[📷] LCD MODE]	📷]/📷]	📷]	Sets the LCD monitor display to the fine mode or power save mode.	109
🔧1	[🕒] DATE/TIME]	-	-	Corrects the date or time.	24
	[🔊] VOLUME]	[SHUTTER VOLUME]/ [OPERATION VOL.]/ [PLAYBACK VOLUME]	-	Sets the volume of shutter volume, operation sound and playback volume.	109
	[🔊] SOUND]	[SHUTTER SOUND]/ [START UP SOUND]/ [OPERATION SOUND]	-	Sets the sound of shutter volume, start up sound and operation sound.	110
	[📷] BLOG IMAGE SIZE]	[640 STANDARD]/ [320 SMALL]	640	Sets the size for blog image when the image is saved or transmitted.	82
	[☀️] LCD BRIGHTNESS]	-	0	Sets the LCD monitor brightness.	110



	Setting	Display	Factory default	Explanation	Page
2	[FORMAT]	-	-	Initializes a Memory Card or internal memory. Select this menu to erase all the frames (files).	111
	[言語/LANG.]	[日本語]/[ENGLISH]/ [FRANCAIS]/[DEUTSCH]/ [ESPAÑOL]/[ITALIANO]/ [中文簡]/[繁體]/[한글]/ [РУССКИЙ]/[PORTUGUÊS]/ [NEDERLANDS]/[TÜRKEÇE]/ [ČESKY]/[MAGYARI]/ [POLSKI]/[SVENSKA]	[ENGLISH]	Specifies the language used for LCD monitor display.	25
	[AUTO POWER OFF]	[5 MIN]/[2 MIN]/[OFF]	[2 MIN]	Sets the time of turning camera off when camera is not used.	111
	[TIME DIFFERENCE]	🏠/⬆️	🏠	Specifies the time difference settings.	112
	[BACKGROUND COLOR]	-	-	Specifies the colors of menu and background.	-
3	[GUIDANCE DISPLAY]	[ON]/[OFF]	[ON]	Specifies whether guidance for function is displayed or not.	
	[VIDEO SYSTEM]	[NTSC]/[PAL]	-	Specifies whether video output is set to [NTSC] or [PAL].	-
	[IR COMMUNICATION]	[STANDARD]/[IrSS]	[STANDARD]	Specifies whether [IR COMMUNICATION] is set to [STANDARD] or [IrSS]. Select [STANDARD] when communicating with a camera or printer, select [IrSS] when communicating with a TV.	79
	[RESET]	-	-	Resets all the camera settings (other than the [DATE/TIME], [TIME DIFFERENCE], [BACKGROUND COLOR], [VIDEO SYSTEM], and [SELECT FOLDER]) to the factory default values set at shipment. A confirmation message appears when you press ▶. To reset the camera settings, press ◀ or ▶ to select OK and press MENU/OK.	-
	[PASSWORD]	-	-	Sets the password for the [PRIVATE] folder.	37

**[IMAGE DISP.]**

Use this setting to specify the way for displaying the check image screen (photograph result) after taking a picture.

**[3 SEC]/[1.5 SEC]:**

The image appears for about 3 or 1.5 seconds and is then recorded.

**[ZOOM (CONTINUOUS)]:**

The image appears enlarged. Use this mode to check details of image.

**! CAUTION**

- The color tones in images displayed when [3 SEC] or [1.5 SEC] is selected may differ slightly from those in the images actually recorded.
- [IMAGE DISP.] cannot be used when [LONG PERIOD] (→p.72) is set.

**■ Enlarging images**

Navigation screen  
(Current displayed image)



① Press **W** or **T** to zoom in or out the image.



② Display another part of the image.



③ Press MENU/OK to take another picture.  
The image is recorded automatically.

**MEMO**

- When **BM** quality setting is selected, the image cannot be enlarged.
- Press DISP/BACK to cancel the zoom setting.
- This function is disabled when setting the continuous shooting.
- This function is disabled when selecting **⏻** in the Shooting mode.



**Intelligent Face Detection**

For images taken with Intelligent Face Detection (→p.31), the displayed face switches to allow confirmation each time you press **IFD** (Intelligent Face Detection).

Press the **W** button (zoom out) or **T** button (zoom in) to display the selected face zoomed in or out. Press **▲**, **▼**, **◀**, or **▶** to display another part of the image.

**[FRAME NO.]**

Use this function to specify whether frame numbers are assigned consecutively from previous numbers or begin again.

	<CONT.>	<RENEW>
	0001 ⋮ 0005	0001 ⋮ 0005
↓		
	0006 ⋮ 0010	0001 ⋮ 0005

\* Formatted Memory Card or internal memory used for both A and B.

[CONT.] : Pictures are stored beginning from the highest file number stored on the last Memory Card or internal memory used.

[RENEW] : Pictures are stored on each Memory Card beginning with a file number 0001. Each image will be numbered consecutively from the last number used. So when recorded images in the Memory Card are erased, the number of the erased frame will not be used again.

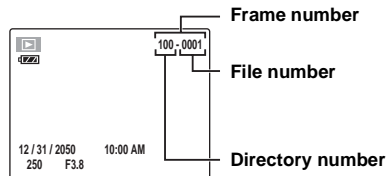
 **CHECK**

The last 4 digits of the 7-digit number in the top right corner of the LCD monitor are the file numbers, while the first 3 digits show the directory number.

 **MEMO**

- Setting this function to [CONT.] makes file management easier as it makes sure that file names are not duplicated when images are downloaded to a PC.
- When the camera settings are [RESET] (→p.105), the frame number setting ([CONT.] or [RENEW]) is changed to [CONT.] and the frame number itself does not return to 0001.
- In [CONT.] setting, images are stored beginning from the highest file number on the current Memory Card when the Memory Card already contains image files with file numbers higher than the highest file number on the last Memory Card.
- The displayed frame number may differ for images photographed on other cameras.

**Continued** ➔

**[DUAL IS MODE]**

Use this function to specify whether the Dual Image Stabilization function is always active in photography mode, or it is activated only when the shutter button is pressed down halfway.

**[1] CONTINUOUS:**

The Dual Image Stabilization function is activated always at photography mode.

**[2] SHOOTING ONLY:**

The Dual Image Stabilization is activated only when the shutter button is pressed down halfway.

**[ILLUMINATION]**

Use this function to specify whether the illumination lamp lights at startup and after shooting is complete. When turned ON, it indicates to the subjects of the picture that shooting is complete.

**[DIGITAL ZOOM]**

Use this function to shoot enlarged images than maximum optical zoom scale.

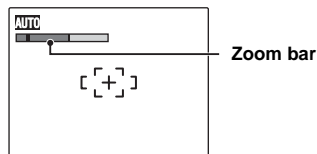
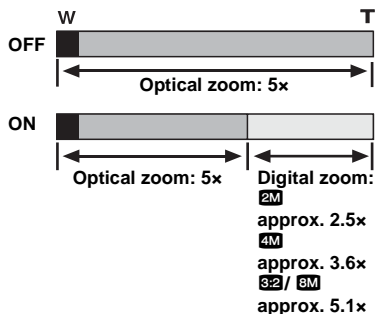
**Zoom bar display****MEMO**

When zooming changes between optical and digital, the position of the "■" indicator stops. Press the same Zoom button again to start the "■" indicator moving again.

**! CAUTION**

Using the digital zoom allows you to enlarge your subject and shoot it. However, it will lower your image quality. Set the digital zoom when requiring it.

**[LCD MODE]**

Use this function to set the LCD monitor display to standard mode or power save mode.

**■ STANDARD**

The images will be displayed finely on the monitor. Be aware of the battery charge, since the camera consumes more power.

**■ POWER SAVE**

When this function is active, you can save power and get the maximum possible running time from your battery.

**! CAUTION**

- The LCD MODE function is disabled during the High-speed shooting mode, Playback mode, and Movie mode.
- Select [POWER SAVE] when using the camera for a long time in hot places. Using the camera in the [STANDARD] setting in such circumstances may cause vertical streaks on the LCD monitor due to CCD characteristics.

**[VOLUME]**

Use this function to adjust volume. The volume can be selected from OFF, LEVEL 1, LEVEL 2, and LEVEL 3.

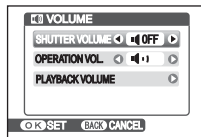

① Select the volume type.



② Change the setting.



③ Press MENU/OK to confirm the setting.

As for Playback volume, use ▲▼ to adjust volume level from 0 to 10.

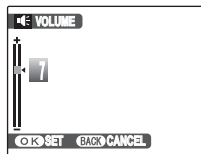

**Continued** ➔

**[SOUND]**

Use this function to adjust the sound.

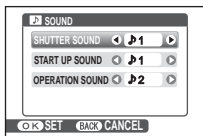

SHUTTER SOUND:  
♪1, ♪2  
START UP SOUND:  
♪1, ♪2, ♪3  
OPERATION SOUND:  
♪1, ♪2, ♪3



① Select the sound type.



② Change the setting.



③ Press MENU/OK to confirm the setting.

**[LCD BRIGHTNESS]**

Use this function to adjust the LCD monitor brightness.

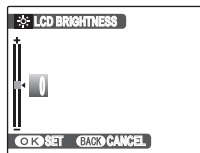

① Adjust the LCD monitor brightness.  
The indicator moves to the + to display the LCD monitor brightly or to the - to darken the LCD monitor.



② Press MENU/OK to confirm the setting.

**[FORMAT]**

Initialize (format) the Memory Card or internal memory for use with the camera.

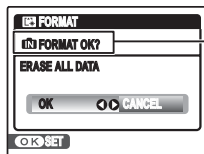

Place of initialize  
**[M] FORMAT:**  
 Internal memory  
**[C] FORMAT:**  
 Memory Card



① Select [OK].



② Pressing MENU/OK initializes the Memory Card or internal memory.

**! CAUTION**

- The Format function erases all the frames (files), including protected frames (files). Back up important frames (files) onto your PC or another media.
- Do not open the battery cover during formatting, as formatting will be interrupted.

**[AUTO POWER OFF]**

When this function is active and the camera remains unused for 2 or 5 minutes, it turns camera off. Use this function when you want to get the maximum possible running time from your battery.

**! CAUTION**

The Auto power off function is disabled during slide shows (→p.85), and when a printer or a PC connection (→p.115, 124) is being used.

**MEMO To restore power to the camera**

To take pictures, close the lens cover completely and then reopen it (→p.21). To play back images, hold down **[M]** for about 1 second (→p.21).

**Continued** →

**[TIME DIFFERENCE]**

Use this function when traveling to destinations in different time zones. This function sets a time difference relative to the date and time currently set. When this setting is enabled, the specified time difference is applied when pictures are taken.

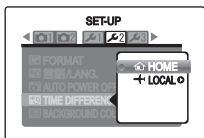
**1 Use Time difference function.**

Change between [HOME] and [+LOCAL].

To set the time difference, select [+LOCAL].

[HOME]: Your home time zone

[+LOCAL]: Your destination time zone

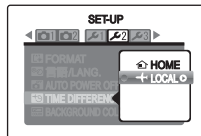
**2 Move to [TIME DIFFERENCE] screen.**

[TIME DIFFERENCE] screen appears.

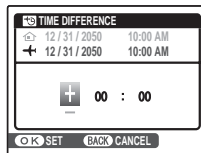
**3 Set time difference.**

① Select +/-, hour, and minute.



② Change the setting.





- ③ Always press MENU/OK after the settings are completed.

### ✓ CHECK

#### Available time setting

-23:45 to +23:45 (in 15-minute increments)

### 📄 MEMO

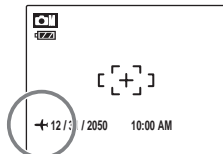

In the time difference setting, when you change to the Shooting mode,  and the date is displayed for 3 seconds, the date display turns yellow.

### ✓ CHECK

Upon returning from a trip, always change the time difference setting back to [ HOME] and then check the date and time again.

# Connecting to a TV

When connecting to a TV, images can be displayed on wider screen. You can enjoy using the slide show function (→p.85) at parties and other gatherings.

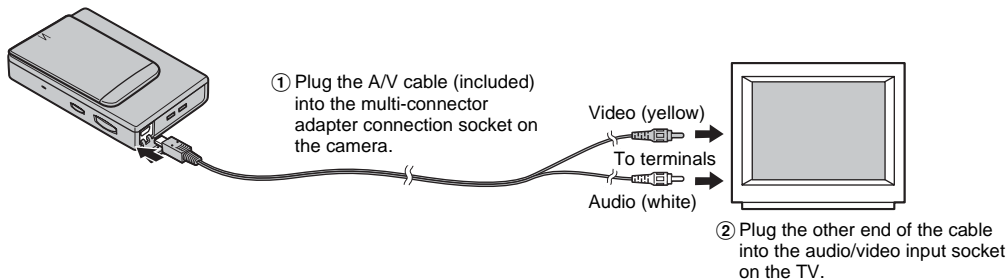

## ! CAUTION

- Plug the A/V cable (included) correctly and push it in the terminal.
- See "Notes and Cautions" (included) for information on the AC power adapter.

## 📄 MEMO

- When connecting the A/V cable (included) to TV, the LCD monitor is turned off.
- The image quality for movie playback is lower than for still images.
- When connecting to a TV, even if you adjust the volume from the [M] PLAYBACK VOLUME], the TV volume cannot be changed. Refer to the instructions provided with your TV for more information on audio/video input for your TV.
- Use the AC-5VX (sold separately) and CP-45 (sold separately) when FinePix Z100fd is connected to a TV for long periods.

# Connecting Camera Directly to Printer — PictBridge Function



When a printer that supports PictBridge is available, images can be printed by connecting the camera directly to the PictBridge-compatible printer without a PC.



## Connecting to a printer

- 1 Connect the camera to your printer using the USB cable.

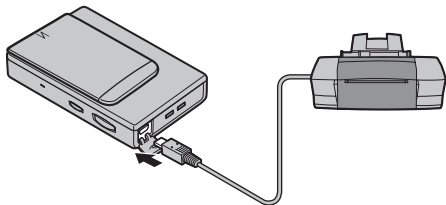

### MEMO

Use the AC-5VX (sold separately) and CP-45 (sold separately) when FinePix Z100fd is connected to a printer.

- 2 Connect the camera to a printer and turn the printer on. Press for about 1 second to turn the camera on.



"USB" appears on the LCD monitor.

- 3 The following screen appears on the LCD monitor after a moment.

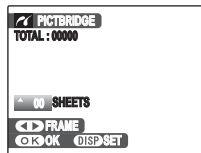

"Specifying images for printing"  
→p.116  
"Printing with DPOF setting"  
→p.117



### MEMO

Depending on the printer, some functions are disabled.

## Specifying images for printing (PRINT WITH DATE / PRINT WITHOUT DATE)

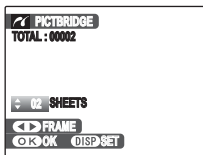

- ① Display the frame (file) for specifying PRINT setting.



- ② Set a value.  
Up to 99 sheets are printed.

To specify more PRINT settings, repeat steps ① and ②.



- ③ Press MENU/OK to display the confirm setting.

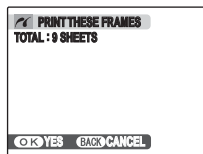

- ④ Press MENU/OK again to download the data to the printer and start printing the specified number of prints.





### MEMO

Even if MENU/OK is pressed with total number of images set at 0 (zero), the screen printing once appears on the LCD monitor. Press MENU/OK again and printing starts.

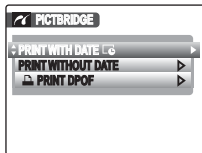

### MEMO Printing with date



- ① Press DISP/BACK to display the setting display.
- ② Select [PRINT WITH DATE ].
- ③ Press MENU/OK.



### CAUTION

[PRINT WITH DATE ] is not available when the camera is connected to a printer that does not support date printing.

## Printing with DPOF setting ([] PRINT DPOF)

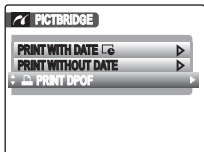

DISP/BACK  ① Press DISP/BACK to open the menu.



② Select [] PRINT DPOF.



③ Press MENU/OK to display the confirm setting.

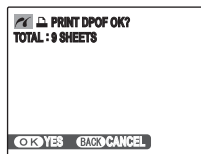

④ Press MENU/OK again to download the data to the printer and start printing the specified frames (files) continuously.

### CHECK

To select [] PRINT DPOF, the DPOF settings must be specified on FinePix Z100fd beforehand (→p.92).

### CAUTION

Even when [WITH DATE ] is specified in the DPOF settings (→p.92), the date is not inserted on printers that do not support date printing.

**Continued** ➔

 **MEMO**

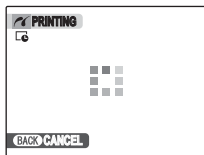

Press DISP/BACK to cancel the printing. Depending on the printer, the printing may not be canceled immediately or printing may stop midway through. When printing stops midway, press  to turn the camera off and then on again.

---

***Disconnecting the printer***

- ① Check that "PRINTING" is not displayed on the camera's LCD monitor.
  - ② Press  to turn the camera off. Unplug the USB cable.
- 

 **MEMO**

DPOF setting can be specified for images on internal memory.

 **CAUTION**

- In PictBridge function, images photographed on other than a camera may not be printed.
- The camera cannot be used to specify printer settings such as the paper size and print quality.
- Use internal memory or a Memory Card that was formatted on FinePix Z100fd.
- Movies cannot be printed.
- Images photographed with a camera other than FinePix Z100fd may not be printed.

# Installation on a Windows PC

## Pre-installation checklist

### ■ Hard ware (software) requirements and recommended system

To run this software, you must have the hardware and software described below. Check your system before you begin the installation.

requirement		Recommendation	
Operating System*1	Windows 98 SE Windows Millennium Edition (Windows Me) Windows 2000 Professional*2 Windows XP Home Edition*2 Windows XP Professional*2 Windows Vista*2	Windows XP	Windows Vista
CPU	200 MHz Pentium minimum (Windows XP/Vista users: 800MHz Pentium 4 or better recommended)	2 GHz Pentium 4 or better	3 GHz Pentium 4 or better
RAM	128 MB minimum (512 MB minimum for Windows Vista)	512 MB or better	1 GB or better
Hard disk space	Amount required for installation: 450 MB minimum Amount required for operation: 600 MB minimum	2 GB or better	15 GB or better
Display	800 × 600 pixels or better, 16-bit color or better	1024 × 768 pixels or better, Highest (32 bit)	

\*1 Models with one of the above operating systems pre-installed.

\*2 When you install the software, login using a system administrator account (e.g. "Administrator").

### ! CAUTION

- Additional USB interface board is not guaranteed.
- Windows 95, Windows 98 and Windows NT cannot be used.
- Operation is not guaranteed on home-built PCs or on PCs running updated operating system software.
- When you reinstall or remove FinePixViewer, the Internet menu and your user ID and password for the FinePix Internet Service are deleted from your PC. Click the [Register now] button, enter your registered user ID and password and download the menu again.
- Folder titles are created with the language selected on the camera. When the set language of the PC and camera differ, folder titles may not be displayed correctly.

Continued ➔

**Do not connect the camera to your PC until the software installation is completed.**

**1 Install FinePixViewer as instructed by the on-screen instructions.**

**Launching the installer manually**

- ① Double-click the "My Computer" icon.  
\* Windows XP users should click "My Computer" in the "Start" menu.  
Windows Vista users should click "Computer" in the "Start" menu.
- ② Right-click "FINEPIX" (CD-ROM drive) in the "My Computer" window (Windows Vista users: in the "Computer" window) and select "Open".
- ③ Double-click "SETUP" or "SETUP.exe" in the CD-ROM window.



- \* The way file names are displayed differs as described below depending on your PC settings.
- File extensions (3-letter suffixes indicating the file type) may be shown or hidden. (e.g. Setup.exe or Setup)
  - Text may be shown normally or all in uppercase (e.g. Setup or SETUP).

**For Windows Vista users:**

When loading the bundled CD-ROM on your PC, the "AutoPlay" window may appear. In this case, click "SETUP.exe".

When "User Account Control" window appears, click "Allow".

**2 Install DirectX as directed by the on-screen instructions and then restart your PC. If the latest version of DirectX is already installed on your PC, this installation is not performed.**

**! CAUTION**

- If the latest version is already installed, this window does not appear.
- Do not remove the CD-ROM during this procedure.

**3 After restarting the PC, a message appears stating "Installation of the FinePixViewer has been completed".**



# Installation on a Mac OS X

## Pre-installation checklist

### Hardware and software requirements

To run this software, you must have the hardware and software described below. Check your system before you begin the installation.

<b>Compatible Mac</b> *1	Power Macintosh G3*2, PowerBook G3*2, Power Macintosh G4, iMac, iBook, Power Macintosh G4 Cube, PowerBook G4, Power Macintosh G5, MacBook, MacBook Pro, or Mac mini
<b>Operating System</b>	Mac OS X (compatible with version 10.3.9 to 10.4.10)
<b>RAM</b>	256 MB minimum
<b>Hard disk space</b>	Amount required for installation: 200 MB minimum Amount required for operation: 400 MB minimum
<b>Display</b>	800 x 600 pixels or better, at least 32,000 colors
<b>Internet connection</b> *3	<ul style="list-style-type: none"><li>To use the FinePix Internet Service or mail attachment function: An Internet connection or e-mail transmission software is needed</li><li>Connection speed: 56 k or better recommended</li></ul>

\*1 PowerPC, Intel processor loaded

\*2 Models with a USB port as a standard feature

\*3 Required to use the FinePix Internet Service. The software can still be installed even if you do not have an Internet connection.

### CAUTION

- Connect the camera directly to the Macintosh using the USB cable (included). The software may not operate correctly if you use an extension cable or connect the camera via a USB hub.
- Push the USB connector fully into the socket to ensure that it is securely connected. The software may not operate correctly if the connection is faulty.
- Additional USB interface board is not guaranteed.

**Continued** ➔

- 1 Turn your Macintosh on and start up Mac OS X. Do not launch any other applications.**
- 2 When the bundled CD-ROM is loaded into the CD-ROM drive, the “FinePix” icon appears. Double-click the “FinePix” icon to open the “FinePix” volume window.**
- 3 Double-click on “Installer for MacOS X”.**
- 4 The Installer setup dialog appears. Click the [Installing FinePixViewer] button.**

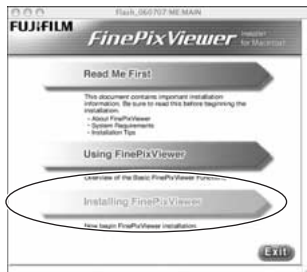

**! CAUTION**

For more information on what is installed, click the [Read Me First] button and [Using FinePixViewer] button.

- 5 The “Authenticate” dialog appears. Enter the name and password for the administrator account and then click the [OK] button.\***
- 6 Install FinePixViewer as directed by the on-screen instructions.**

\* The administrator account is the user account used for Mac OS X installation and you can confirm the user account in the Accounts dialog in the System Preferences.

**7** The “FinePixViewer installation completed” message dialog appears. Then click exit button and close it.

**!** **CAUTION**

When Safari is used as the Web browser, a message may be displayed and the CD-ROM may not be removed. If this happens, click the Safari icon in the Dock to make Safari the active application and then select “Quit Safari” in the “Safari” menu to shut down Safari.

**8** Launch “Image Capture” from the “Applications” folder.

**9** Change the Image Capture settings. Select “Preferences...” from the “Image Capture” menu.



**10** Select “Other...” from “When a camera is connected, open”.

**11** Select “FPVBridge” from “FinePixViewer” folder in the “Applications” folder and click the [Open] button.



**12** Select “Quit Image Capture” menu in the “Image Capture” menu.

# Connecting to a PC

By connecting the camera to a PC, your system can be expanded to fill a wide range of uses. Using "FinePixViewer" performs images saving, browsing and file management etc.

## FinePixViewer Overview

Enables importing images, managing files and folders, and ordering prints using the internet (only Windows users).

## ■ Operation of image transmission by USB (Windows only)

Images in this camera are saved in a sub folder according to the folder category when transmitting to a PC using FinePixViewer.

When returning images from a PC to the camera, they are saved in the [MY PICTURES] folder.

## ! CAUTION

The Windows CD-ROM may also be required during installation. In this event, change CD-ROMs as directed by the on-screen instructions.

## Refer to Software Installation (→p.119, 121) the first time you connect the camera to your PC.

Install the software first. Do not connect the camera to the PC before installing all the software.



**CD-ROM**  
(Software for FinePix)

- ① Insert the Memory Card with images into the camera (→p.18).

You can use the **xD-Picture Card** and the **SD Memory Card** with the FinePix Z100fd.

In this Owner's Manual, these cards are expressed as "Memory Card".

## ! CAUTION

- Do not format the Memory Card in the camera on the PC.
  - Use the Memory Card with images taken by a FUJIFILM Digital camera.
- ② Connect the camera to your PC using the USB cable (included).

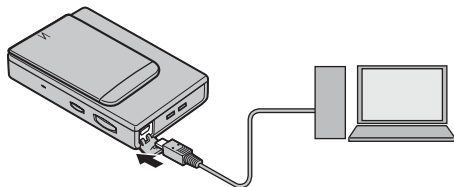

- ③ Press  for about 1 second to turn the camera on in Playback mode.
- ④ Set your PC

## MEMO

In Windows, if FinePixViewer is already installed, the driver will be set automatically. No action is required.

## ! CAUTION

- FinePix Z100fd is compatible with PTP (Picture Transfer Protocol)/MTP (Media Transfer Protocol). A PTP/MTP-compatible camera is a camera that can recognize the PC and printer automatically when connected.
- Do not disconnect the USB cable (included) when the camera is communicating with a PC. If the USB cable (included) is disconnected during communication, the files on the Memory Card or internal memory may be damaged.
- In Mac OS X, you must set automatic setup the first time you connect the camera to your PC.
- When the camera and PC are exchanging data, the indicator lamp blinks alternately green and orange.
- Auto power off is disabled during USB connection.
- Before replacing the Memory Card, always disconnect the camera from the PC.
- The camera and PC may be exchanging data even when "Copying" disappears from your PC screen. Before disconnecting the USB cable (included), always check that the indicator lamp is off.
- Always use FinePixViewer to transfer images with voice memos to a PC.
- The cost of an Internet provider for connecting to the internet is the user's responsibility.
- When using FinePixViewer to save images on a data server (network), FinePixViewer may not run as it would in a standalone PC environment.

## ! CAUTION

- Always use the FUJIFILM AC Power Adapter AC-5VX (sold separately) and DC coupler CP-45 (sold separately). If the camera suddenly loses power during data exchange, data exchange will not be performed correctly, and the Memory Card or internal memory could be damaged.
- Make sure that the USB cable (included) is connected correctly and securely.
- Connect the camera directly to the PC using the USB cable (included). The software may not operate correctly when you use an extension cable, or if you connect the camera via a USB hub.
- When your PC has more than one USB port, the camera can be connected to either port.
- When Windows 98 SE is used, the supplied software must be installed first before connecting the camera to a PC using the USB cable. The PC will not recognize the camera if it is connected before installation.
- A Memory Card, the internal memory, data in a Memory Card or data in the internal memory could be damaged if any of the following are performed;
  - the USB cable is disconnected
  - power switch or buttons are pressed, or the lens cover is interfered with

**Continued** ➔

## The following steps differ depending on the PC's operating system (Windows XP/Vista and Mac OS X case)

When your PC recognizes the camera automatically, FinePixViewer automatically starts up and the Save Image Wizard window (Save Image dialog box) appears. Follow the instructions provided on screen to save the images. To proceed without saving the images, click the [Cancel] button.

### ! CAUTION

- When there are many images stored on a Memory Card, it takes a while to display on the screen of your PC. Also, it may take a while to import images or you may be unable to save images. In this case, use an Image Memory Card Reader.
- Folder titles are created with the language selected on the camera. When the set language of your PC and camera differ, folder titles may not be displayed correctly.
- Images in the internal memory cannot be saved on your PC if a memory card is inserted in the camera. Before connecting the camera to your PC, remove the memory card from the camera to save images in the internal memory to your PC.

### MEMO

- You can only see images saved on a PC. Save images on a PC.
- If you cancel saving by clicking the [Cancel] button, close the lens cover to turn off the camera and then disconnect it from the PC.
- When the camera is connected to your PC, FinePixViewer automatically starts up by the function of Exif Launcher, which is installed in FinePixViewer.

Proceed to "Using FinePixViewer" (→p.127).

### ! CAUTION (Mac OS X)

If FinePixViewer does not start up automatically, the software may not be installed correctly. Set your PC again after disconnecting the camera and restart.

### ! CAUTION (Mac OS X) Note on disconnecting the camera

- Close all files in the camera, and make sure the camera is not exchanging data.
- The camera and PC may be exchanging data even when "Copying" disappears from your PC screen, especially in the case of copying large data amounts. Do not disconnect the USB cable (included), immediately after this message has disappeared. Always check that the indicator lamp is off first before disconnecting.

## Using FinePixViewer

### Mastering FinePixViewer

For all information on FinePixViewer functions, refer to “How to Use FinePixViewer” in the Help menu for details.

• **What is explained in “How to Use FinePixViewer”...**  
“How to Use FinePixViewer” covers a range of topics, including batch processing and ordering prints.

#### Example: Looking up slide shows

- 1 Click “How to Use FinePixViewer” in the FinePixViewer Help menu.
- 2 Click “Basic Operation” and then click “Slide Show” in the menu that appears.
- 3 The “Slide Show” information appears. Press the “<<<” key to view the previous page or the “>>>” key to view the next page.

### Uninstalling the software

Only perform this operation when you no longer require the installed software or when the software was not installed correctly.

#### Windows

- 1 Check that the camera is not connected to the PC.
- 2 Quit all currently running applications.
- 3 The steps for uninstalling software differ depending on the operating system. Follow the steps for each operating system to uninstall the software listed below.

The following software is to be uninstalled:

- FinePixViewer
- FinePix Resource
- FinePix Studio\*
- RAW FILE CONVERTER LE\*

\* May not have been installed depending on the operating system.

To remove FinePixViewer

FinePixViewer Ver. 5.\*

To remove the driver software

FUJIFILM USB Driver



**Continued** ➔

- ④ When the message appears, click the [OK] button.  
Check your selection carefully since the process cannot be canceled once you click the [OK] button.



### Macintosh

Quit FinePixViewer. Then drag the FinePixViewer folder in the application folder to the Trash and select "Empty Trash" in the "Finder" menu.



# System Expansion Option

By using FinePix Z100fd together with other optional FUJIFILM products, your system can be expanded to fill a wide range of uses.

Accessory availability may vary by country. Please check with your local Fujifilm representative to confirm product availability.

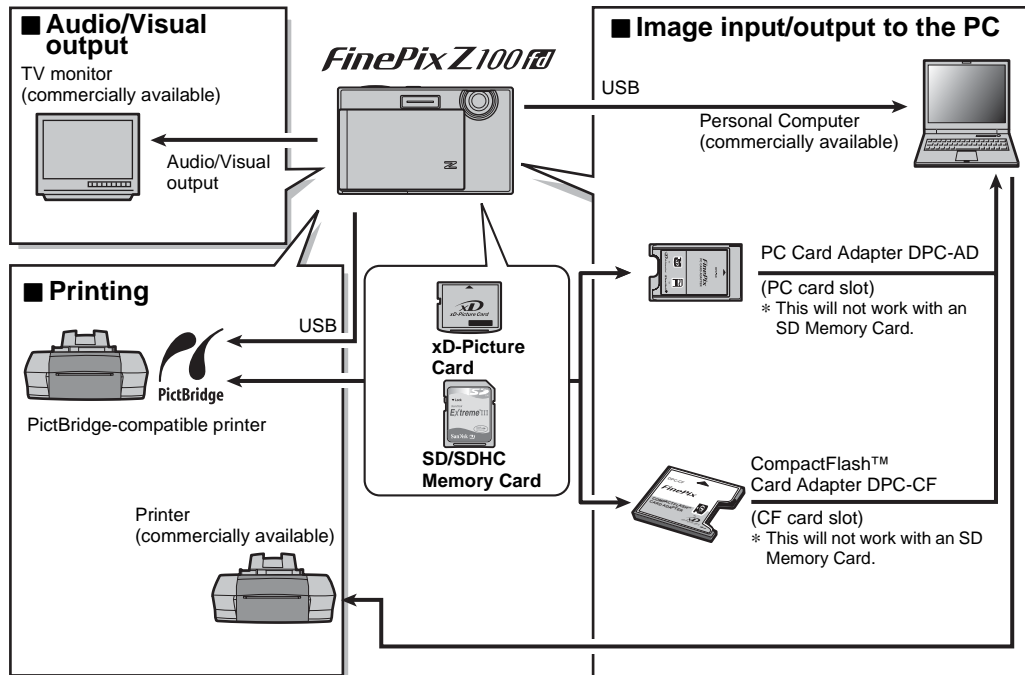

# Accessories Guide

Visit the FUJIFILM web site for the latest information on camera accessories.

[http://www.fujifilm.com/products/digital\\_cameras/index.html](http://www.fujifilm.com/products/digital_cameras/index.html)

Accessory availability may vary by country. Please check with your local Fujifilm representative to confirm product availability.

## • xD-Picture Card

Use the following **xD-Picture Cards**:

256MB/512MB/1GB/2GB

There are two types of **xD-Picture Card**: standard type and Type M (containing "M" in the model number, such as DPC-M1GB).

FinePix Z100fd is compatible with Type M, however they may not be compatible depending on the device used (Image Memory Card Reader, etc.).



## • Battery Charger BC-45

Quickly charges the rechargeable battery. The BC-45 reduces charging time to approx. 180 minutes at +23°C (for the NP-45). Use the Battery adapter when the NP-45 is being charged. The battery adapter is supplied with the BC-45.

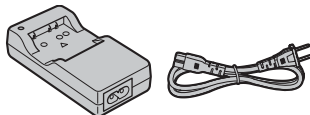

## • Rechargeable Battery NP-45 (750 mAh)

A Lithium-ion slimline rechargeable battery



## • AC Power Adapter AC-5VX

Use the AC-5VX when taking pictures or play back images for long periods or when FinePix Z100fd is connected to a PC.

Use AC-5VX AC adapter with CP-45 DC Coupler together for FinePix Z100fd.

\* The shape of the AC power adapter, the plug, and power outlet depend on the country.

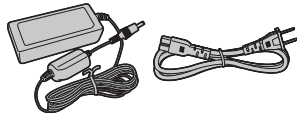

## • DC Coupler CP-45

Use the CP-45 with AC-5VX when taking pictures or play back images for long periods or when FinePix Z100fd is connected to a PC.

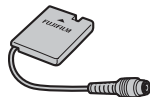

- **PC Card Adapter DPC-AD**

The PC Card Adapter allows the **xD-Picture Card** and SmartMedia to be used as a PC Card Standard ATA-compliant (PCMCIA 2.1) PC card (Type II).

-Compatible with **xD-Picture Card** of 16 MB to 512 MB, and SmartMedia of 3.3 V, 2 MB to 128 MB.  
This is not compatible with the SD Memory Card.



- **CompactFlash™ Card Adapter DPC-CF**

Loading an **xD-Picture Card** into this adapter allows you to use the card as a CompactFlash card (Type I).

-This is not compatible with the SD Memory Card.



- **Waterproof Case WP-FXZ100 (upcoming)**

This waterproof case protects your FinePix Z100fd from water damage yet allows you to make camera adjustments and use the flash.

Dive up to 40 meters (131 feet) underwater with your FinePix Z100fd digital camera.

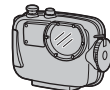

- **Soft case**

This is a special case made of polyurethane that protects the camera against soil, dust, and minor impacts when it is being carried.

# Using Your Camera Correctly

Read this information and the "Safety Notes" (→"Notes and Cautions"), to make sure you use your camera correctly.

## ■ Places to Avoid

Do not store or use the camera in the following types of locations:

- In the rain or in very humid, dirty, or dusty places
- In direct sunlight or in places subject to extreme temperature rises, such as in a closed car in summer
- Extremely cold places
- Places with strong vibration
- Places with smoke or steam
- Places subject to strong electric magnetic fields (such as near broadcasting tower, power lines, radar, motors, transformers, magnets, etc.)
- In contact with chemicals such as pesticides
- Next to rubber or vinyl products

## ■ Damaged by Water or Sand

FinePix Z100fd can be damaged on the inside and outside by water and sand. When you are at the beach or close to water, make sure that the camera is not damaged by water or sand. Take care not to place the camera on a wet surface.

## ■ Damaged by Condensation

If the camera is carried from a cold location into a warm place, water droplets (condensation) may form on the inside of the camera or on the lens. When this occurs, turn the camera off and wait an hour before using the camera. Condensation may also form on the Memory Card. In this event, remove the Memory Card and wait a short time.

## ■ When the Camera is Not Used or is stored Periods of Time

If you do not intend to use the camera for a long period of time, remove the battery and the Memory Card.

## ■ Cleaning Your Camera

- Use a blower brush to remove any dust on the lens or LCD monitor, and then gently wipe the camera with a soft, dry cloth. If any soil remains, apply a small amount of lens cleaning liquid to a piece of FUJIFILM lens cleaning paper and wipe gently.
- Do not scratch hard objects against the lens or LCD monitor.
- Clean the body of the camera with a soft, dry cloth. Do not use volatile substances or cleaning products these items can cause damage.

## ■ Using the Camera When Traveling

When traveling overseas, do not place your camera in the check-in baggage. Baggage can be subjected to violent shocks, and the camera may be damaged inside or outside.

# Notes on the xD-Picture Card™, the SD Memory Card and the Internal Memory

## ■ Handling Memory Card

- When inserting the Memory Card into the camera, hold the Memory Card straight as you push it in.
- Never remove the Memory Card or turn the camera off during data recording or erasing (Memory Card formatting) as this could be damaged to the Memory Card.
- The use of **xD-Picture Cards** is recommended with FinePix Z100fd.  
The recording quality cannot be guaranteed when **xD-Picture Cards** other than those manufactured by FUJIFILM are used.
- The Memory Card may feel warm when it is removed from the camera after taking pictures. This is normal.
- Do not put labels on the Memory Card. Peeling labels can cause the camera not to work properly.



## MEMO Type M and H of xD-Picture Card

- Type M  
There are two types of Memory Card: standard type and Type M (containing "M" in the model number, such as DPC-M2GB).  
FinePix Z100fd is compatible with Type M.
- Type H  
Type H and M share the same compatibility.
- Usable USB drive  
Type H cannot be used with **xD-Picture Card** USB drive DPC-UD1, while Type M can.

## ■ Internal Memory





- Images held in the camera's internal memory may be corrupted or erased due to problems such as camera faults. Save your important data to another media (i.e., DVD-R, CD-R, CD-RW, hard disk, etc.).
- Data stored in the camera's internal memory cannot be guaranteed in the event that the camera is submitted for repairs.
- When the camera is repaired, any data stored in the camera's internal memory is subject to checking by the repairer.

## ■ Using Memory Card or Internal Memory with a PC

- When taking pictures using a Memory Card or internal memory that has been used on a PC, reformat the Memory Card using your camera.
- When formatting, a directory (folder) is created. Image data is then recorded in this directory.
- Do not change or delete the directory (folder) or file names on the Memory Card or internal memory because this will make it impossible to use the Memory Card or internal memory in your camera.
- Always use the camera to erase image data.
- To edit image data, copy or transfer the image data to the PC and edit the copied or transferred data.

# Warning Displays

The table below lists the warnings that are displayed on the LCD monitor.

Warning Displayed	Explanation	Remedy
 (Lit red)  (Blinking red)	The battery is low or completely out of charge.	Charge the battery or load fully charged battery.
	There is a strong likelihood of camera shake because the shutter speed is slow.	Use flash photography. We recommend using a tripod.
 <b>!AF</b> (Lit red) *The shape of the AF frame differs depending on the setting in the [SHOOTING MENU].	The AF (autofocus) cannot work effectively.	<ul style="list-style-type: none"> <li>• If the image is too dark, take the picture at a distance of around 2 m (6.6 ft.) from the subject.</li> <li>• Use AF lock to take the picture (→p.33).</li> <li>• Select Macro mode when taking close-up shots.</li> </ul>
Aperture/ Shutter speed display (Lit red)	The camera cannot shoot the picture at the correct brightness due to too bright or dark shooting condition.	The picture can be taken, but the correct brightness (exposure) will not be obtained.
<b>[FOCUS ERROR]</b>  <b>[ZOOM ERROR]</b>  <b>[LENS CONTROL ERROR]</b>	Camera malfunction or fault.	<ul style="list-style-type: none"> <li>• Turn the camera on again, taking care not to touch the lens.</li> <li>• Turn the camera off and on again. If the message still appears, contact your FUJIFILM dealer.</li> </ul>
<b>[NO CARD]</b>	Memory Card is not inserted when transferring images.	Insert a Memory Card.
<b>[CARD NOT INITIALIZED]</b>	<ul style="list-style-type: none"> <li>• The Memory Card or internal memory is not formatted.</li> <li>• The Memory Card contact area is soiled.</li> <li>• Camera fault.</li> </ul>	<ul style="list-style-type: none"> <li>• Format the Memory Card or internal memory on the camera (→p.111).</li> <li>• Wipe the contact area on the Memory Card with a soft, dry cloth. It may be necessary to format the Memory Card (→p.111). If the message still appears, replace the Memory Card.</li> <li>• Contact your FUJIFILM dealer.</li> </ul>

Warning Displayed	Explanation	Remedy
<b>[CARD ERROR]</b>	<ul style="list-style-type: none"> <li>• The Memory Card contact area is soiled.</li> <li>• The Memory Card format is incorrect.</li>   <li>• Camera fault.</li> <li>• The Memory Card is damaged.</li> </ul>	<ul style="list-style-type: none"> <li>• Wipe the contact area on the Memory Card with a soft, dry cloth. It may be necessary to format the Memory Card (→p.111). If the message still appears, replace the Memory Card.</li> <li>• Contact your FUJIFILM dealer.</li> </ul>
<b>[MEMORY FULL]</b> <b>[MEMORY FULL]</b>	The internal memory or Memory Card is full.	Erase some images in internal memory or Memory Card (→p.43), or use a Memory Card that has ample free space.
<b>[WRITE ERROR]</b>	<ul style="list-style-type: none"> <li>• The data could not be recorded due to a Memory Card error or a connection error between the Memory Card and camera.</li> <li>• The image cannot be recorded as it is too large to fit in the available space on the Memory Card.</li> <li>• The Memory Card or internal memory is not formatted.</li> </ul>	<ul style="list-style-type: none"> <li>• Re-insert the Memory Card or turn the camera off and then on again. If the message still appears, contact your FUJIFILM dealer.</li> <li>• Use a new Memory Card.</li>   <li>• Format the Memory Card or internal memory on the camera (→p.111).</li> </ul>
<b>[INTERNAL MEMORY IS FULL INSERT A NEW CARD]</b>	The data could not be recorded or copied since the internal memory is full.	Erase some images from the internal memory (→p.43), or use a Memory Card that has ample free space.
<b>[BUSY]</b>	The timing for recording was incorrect because the Memory Card was formatted on a PC.	Use a Memory Card that was formatted on the camera.
<b>[FRAME NO. FULL]</b>	The frame number has reached 999-9999.	<ol style="list-style-type: none"> <li>① Insert a formatted Memory Card into the camera.</li> <li>② Set RENEW as the FRAME NO. setting in the [SET-UP] menu (→p.107).</li> <li>③ Start taking pictures (The frame number starts from "100-0001").</li> <li>④ Set CONT. as the FRAME NO. setting in the [SET-UP] menu.</li> </ol>

Continued ➔

Warning Displayed	Explanation	Remedy
<b>[READ ERROR]</b>	<ul style="list-style-type: none"> <li>• The played back file was not recorded correctly.</li> <li>• The Memory Card contact area is soiled.</li> <li>• Camera fault.</li> <li>• An attempt was made to play back the image or the movie that was not recorded on this camera.</li> </ul>	<ul style="list-style-type: none"> <li>• This file cannot be played back.</li> <li>• Wipe the contact area on the Memory Card with a soft, dry cloth. It may be necessary to format the Memory Card (→p.111). If the message still appears, replace the Memory Card.</li> <li>• Contact your FUJIFILM dealer.</li> <li>• The movie and image cannot be played back.</li> </ul>
<b>[TOO MANY FRAMES]</b>	An attempt was made to show 5,000 or more image by date sorting.	No more than 4,999 images can be shown by date sorting.
<b>[PROTECTED FRAME]</b>	<ul style="list-style-type: none"> <li>• An attempt was made to erase a protected file.</li> <li>• An attempt was made to add a voice memo to protected file.</li> <li>• An attempt was made to rotate a protected file.</li> </ul>	<ul style="list-style-type: none"> <li>• Protected files cannot be erased. Remove the protection (→p.87).</li> <li>• Protected files cannot be added to voice memos. Remove the protection (→p.87).</li> <li>• Protected files cannot be rotated. Remove the protection (→p.87).</li> </ul>
<b>[PROTECTED CARD]</b>	The SD Memory Card switch is slide to the “Lock” side.	Unlock the protection by sliding it back (→p.19).
<b>[PASSWORD INCORECT]</b>	The wrong password was entered.	Set the password again.
<b>[🔊 ERROR]</b>	<ul style="list-style-type: none"> <li>• The voice memo file is faulty.</li> <li>• Camera fault.</li> </ul>	<ul style="list-style-type: none"> <li>• The voice memo cannot be played back.</li> <li>• Contact your FUJIFILM dealer.</li> </ul>
<b>[📷 NO IMAGE]</b> <b>[📺 NO IMAGE]</b>	An attempt was made to transfer images from the Memory Card or internal memory that memory was empty.	It is impossible to copy.
<b>[📷 CAN NOT TRIM]</b>	An attempt was made to trim a 0.3M image.	The image cannot be trimmed.
<b>[CAN NOT TRIM]</b>	<ul style="list-style-type: none"> <li>• An attempt was made to trim an image shot using a camera other than FinePix Z100fd.</li> <li>• The image is damaged.</li> </ul>	The image cannot be trimmed.
<b>[📷 CAN NOT TRIM]</b>	An attempt was made to trim a blog image.	The image cannot be trimmed.



Warning Displayed	Explanation	Remedy
<b>[DPOF FILE ERROR]</b>	Prints were specified for 1000 or more frames in the DPOF frame settings.	The maximum number of frames for which prints can be specified on the same Memory Card is 999. Copy the images for which you want to order prints onto another Memory Card and then specify the DPOF settings.
<b>[CAN NOT SET DPOF]</b> <b>[📷 CAN NOT SET DPOF]</b>	An attempt was made to specify DPOF settings for an image that is not supported by DPOF.	DPOF printing cannot be used with this image format.
<b>[CAN NOT ROTATE]</b> <b>[📷 CAN NOT ROTATE]</b>	An attempt was made to rotate a movie or an image shot using a camera other than FinePix Z100fd.	These images cannot be rotated by image formats.
<b>[📷 CANNOT EXECUTE]</b> <b>[📺 CANNOT EXECUTE]</b> <b>[? CANNOT EXECUTE]</b>	An attempt was made to transmit or save an image or movie recorded with another device, or an image that cannot be played back, with TRIMMING FOR BLOG.	Some image formats cannot be transmitted or saved with TRIMMING FOR BLOG.
<b>[📷 CANNOT EXECUTE]</b>	An attempt was made to resave an image that was saved with [TRIMMING FOR BLOG].	Images saved with [TRIMMING FOR BLOG] cannot be resaved.
<b>[📷 CANNOT EXECUTE]</b>	An attempt was made to take a picture in [📷 AUCTION MODE] while [📺] appeared in the LCD monitor.	Charge the battery or replace with a charged battery.
<b>[PRESS AND HOLD THE DISP BUTTON TO DEACTIVATE SILENT MODE]</b>	An attempt was made to set flash or sound in Silent mode.	Flash or sound cannot be set in the Silent mode. Release the Silent mode to set flash or sound.
<b>[COMMUNICATION ERROR]</b>	The camera is not connected to a PC or printer.	<ul style="list-style-type: none"> <li>• Check that the USB cable is connected correctly.</li> <li>• Check that your PC or printer is turned on.</li> <li>• When using IR communication, make sure the camera and the other device are transmitting and receiving within the image transmission range.</li> </ul>

**Continued** ➔

Warning Displayed	Explanation	Remedy
<b>[CANNOT BE TRANSMITTED]</b>	<ul style="list-style-type: none"> <li>An attempt was made to send a movie or an image shot by the camera other than FinePix Z100fd (㊄) is displayed).</li> <li>Transmission was disconnected during IR communication.</li> </ul>	<ul style="list-style-type: none"> <li>The image format is not transmittable.</li> <li>A movie can not be sent.</li> <li>Do not move the camera out of the transmission distance. Do not place anything between the transmitting and receiving devices.</li> </ul>
<b>[CANNOT BE RECEIVED]</b>	Transmission was disconnected during IR communication.	Do not move the camera out of the transmission distance. Do not place anything between the transmitting and receiving devices.
<b>[PRINTER ERROR]</b>	Displayed for PictBridge.	<ul style="list-style-type: none"> <li>Check that the printer is not out of paper or out of ink.</li> <li>Turn the printer off briefly and then turn it back on.</li> <li>Refer to the user manual supplied with your printer.</li> </ul>
<b>[PRINTER ERROR RESUME?]</b>	Displayed for PictBridge.	Check that the printer is not out of paper or out of ink. Printing automatically restarts when the error is cleared. If the message still appears after checking, press MENU/OK to restart printing.
<b>[CANNOT BE PRINTED]</b>	Displayed for PictBridge.	<ul style="list-style-type: none"> <li>Refer to the user manual for the printer being used and check whether the printer supports the JFIF-JPEG or Exif-JPEG image format. If not, the printer cannot print the images.</li> <li>Movie images cannot be printed.</li> <li>Was the image data photographed using FinePix Z100fd?</li> </ul> <p>You may not be able to print some images photographed on other cameras.</p>

# Troubleshooting

## ■ Getting ready

Matters	Problems	Possible causes	Solutions	Page
Battery and power supply	Nothing happens when opening the lens cover completely.	The battery has run out.	Charge the battery or load fully charged battery.	14, 16
		The battery is loaded backward.	Load the battery in the corrected direction.	16
		The battery cover is not closed securely.	Close the battery cover securely.	17
		The AC power adapter and DC coupler are not connected correctly.	Connect the AC power adapter and DC coupler correctly.	—
	Battery runs out quickly.	Camera is used in extremely cold conditions.	Put the battery in your pocket or another warm place to heat it and then load it into the camera just before you take a picture.	15, 16
		The terminals are soiled.	Wipe the battery terminals with a clean, dry cloth.	
		Same battery has been used for a long period.	The battery can no longer be recharged. Load a new battery.	15, 16
	Power cuts out during operation.	The battery has run out.	Charge the battery or load fully charged battery.	14, 16
		The AC power adapter and DC coupler are not connected correctly.	Connect the AC power adapter and DC coupler correctly.	—

**Continued** ➔

Matters	Problems	Possible causes	Solutions	Page
Charging a battery	Charging does not begin.	There is no battery in the camera.	Load the battery.	16
		The battery is loaded backward.	Load the battery in the correct direction.	16
	The charging indicator blinks during charging and the battery won't charge.	The battery terminals are soiled.	Take the battery out briefly and wipe the battery terminals with a clean, dry cloth before reloading it.	-
		The battery can no longer be recharged.	Load a new battery. If the battery still fails to charge, contact your FUJIFILM dealer.	-







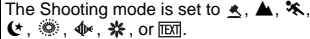
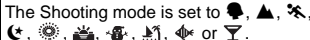













■ Setting menu etc.

Matters	Problems	Possible causes	Solutions	Page
LCD monitor display	Screens are not displayed in English.	A language other than English is selected in the 言語/LANG. setting in the [SET-UP] menu.	Select ENGLISH.	25

## ■ Shooting

Matters	Problems	Possible causes	Solutions	Page
Basic operations	No photograph is taken when pressing the shutter button.	The Memory Card or internal memory is full.	Insert a new Memory Card or erase some unnecessary frames.	18, 43
		The Memory Card or internal memory is not formatted.	Format the Memory Card or internal memory on the camera.	103, 111
		The Memory Card contact area is soiled.	Wipe the Memory Card contact area with a soft, dry cloth.	18
		The Memory Card is damaged.	Insert a new Memory Card.	18
		The battery has run out.	Charge the battery or load fully charged battery.	14, 16
	The Auto power off function has turned the camera off.	Turn the camera on.	21, 111	
	The LCD monitor darkens after taking a picture.	You took pictures with flash.	The LCD monitor may darken for charging flash. Wait a short time.	62
Focusing	Camera has difficulty in focusing on the subject.	You took a close-up shot without selecting Macro mode.	Select Macro mode.	59
		You photographed scenery with Macro mode selected.	Cancel Macro mode.	59
		You are shooting a subject that is not suited to autofocus (→p.34).	Use AF/AE lock to take the picture.	33
Intelligent Face Detection	Cannot set Intelligent Face Detection.	The Shooting mode is set to  .	Change the Shooting mode.	53
Macro (Close-up) shooting	Cannot set Macro (Close-up).	The Shooting mode is set to  .	Change the Shooting mode.	53

Continued ➔

Matters	Problems	Possible causes	Solutions	Page
Flash	Cannot use the flash.	The shutter button was pressed while the flash was charging.	Wait until the charging is completed before pressing the shutter button.	62
		The Shooting mode is set to  ,  ,  , or  .	Change the Shooting mode.	53
		The battery has run out.	Charge the battery or load fully charged battery.	14, 16
		Continuous shooting is selected.	Set continuous shooting to OFF.	70
		The flash mode is set to  .	Set the flash mode to something other than  .	61
		Silent mode is set.	Release Silent mode.	26
	The flash settings are restricted and cannot be selected.	The Shooting mode is set to AUTO,  ,  ,  ,  ,  ,  ,  ,  ,  ,  ,  ,  , or  .	The flash settings are restricted because the camera settings are tailored to the scene being shot. Change the Shooting mode for a wider range of flash settings.	53
		Silent mode is set.	Release Silent mode.	26
	The playback image is dark even though the flash was used.	The subject is too far away.	Move to within the effective flash range before taking the picture.	59, 62
		Your finger was covering the flash.	Hold the camera correctly.	28
Photographed images	The image is blurred.	The lens is dirty.	Clean the lens.	
		AF frame (lit red) and <b>!AF</b> appeared when taking pictures.	Check the focus on the subject and take pictures.	29, 134
		 appeared when taking pictures.	It may cause camera shake. Hold the camera steadily.	30, 134
	There is speckling on the image.	The picture was taken with a slow shutter speed (long exposure) in a high-temperature environment.	This is a characteristic of CCDs and does not indicate a camera fault.	-

## ■ Shooting

Matters	Problems	Possible causes	Solutions	Page
Recording images	Photographed images or movies are not recorded.	AC power adapter was connected or disconnected during turning the camera on.	Connect or disconnect the AC power adapter and DC coupler only when the camera is off. Failing to turn the camera off first can result in damage to the Memory Card or malfunctions during PC connection.	-
Continuous shooting	Only 1 frame can be shot even though continuous shooting mode was set.	A picture is taken using self-timer when setting [FINAL 3] or [LONG PERIOD] continuous shooting mode.	Only 1 frame can be shot when using [FINAL 3] or [LONG PERIOD] continuous shooting mode and Self-timer mode together.	70
Sound	No sound from the camera.	Silent mode is set.	Release Silent mode.	26
Folder	No photographed images in the camera.	You may have selected another folder from your selected folder.	Move or copy images to your selected folder using [MOVE/COPY].	46

**Continued** ➔

■ **Playing back**

Matters	Problems	Possible causes	Solutions	Page
Playing back images	It takes time to play back images.	You may have saved many images.	Use Micro thumbnails playback.	41
	Photographed images cannot be found.	You may not have selected a folder to save before shooting.	Search with Micro thumbnails playback.	41
Playing back movie / voice memo	The camera does not emit any sound.	The camera volume is set too low.	Adjust the volume.	109
		The microphone was blocked during shooting/recording.	Take care not to block the microphone during shooting/recording.	89, 99
		There is something covering the speaker during playback.	Make sure that the speaker is uncovered.	91, 102
Erasing	Erasing FRAME does not erase the frame.	Some frames may be protected.	Unprotect frames using the camera on which the protection was first applied.	87
	Erasing ALL FRAMES does not erase all the frames.			
Frame No.	CONT. in the frame number setting does not function.	You opened the battery cover without turning the camera off when replacing the battery or Memory Card.	Always turn the camera off when replacing the battery or Memory Card. Opening the battery cover without turning the camera off may cause the frame number memory to not function.	21



## ■ Connecting

Matters	Problems	Possible causes	Solutions	Page
Connecting to TV	There is no image or sound on the TV.	The camera is not connected to the TV correctly.	Connect the camera and TV correctly.	114
		The included A/V cable was connected during movie playback.	After the movie playback mode is stopped, connect the camera and TV correctly.	101, 114
		"TV" is selected as the TV input.	Set the TV input to "VIDEO".	–
		The video output setting is incorrect.	Change the setting to NTSC or PAL.	103, 105
	The TV volume is turned down.	Adjust the volume.	–	
	The TV image is black and white.	The video output setting is incorrect.	Change the setting to NTSC or PAL.	103, 105
Connecting to PC	PC does not recognize the camera.	The USB cable is not correctly connected to the PC or camera.	Set up the camera, and connect the USB cable correctly.	124
Connecting to printer	Cannot print with PictBridge.	<ul style="list-style-type: none"> <li>The USB cable is not correctly connected to the printer or camera.</li> <li>The printer is not turned on.</li> </ul>	<ul style="list-style-type: none"> <li>Set up the camera, and connect the USB cable correctly.</li> <li>Turn the printer on.</li> </ul>	115

**Continued** ➔



















■ Others

Matters	Problems	Possible causes	Solutions	Page
Camera operation etc.	Nothing happens when pressing the buttons on the camera.	Camera malfunction may be caused temporarily.	Briefly remove the battery or disconnect the AC power adapter, DC coupler. Then reload the battery or reconnect the AC power adapter and DC coupler, try again.	16
		The battery has run out.	Charge the battery or load fully charged battery.	14, 16
	The camera no longer works correctly.	Camera malfunction may be caused temporarily.	Briefly remove the battery or disconnect the AC power adapter and DC coupler. Then reload the battery or reconnect the AC power adapter and DC coupler, try again. If you think the camera is faulty, contact your FUJIFILM dealer.	16

# Specifications

System	
<b>Model</b>	Digital camera FinePix Z100fd
<b>Effective pixels</b>	8.0 million pixels
<b>CCD</b>	1/2.5-inch CCD
<b>Storage media</b>	Internal memory (approx. 54 MB)/ <b>xD-Picture Card</b> (16/32/64/128/256/512 MB/1 GB/2 GB)/SD Memory Card (512 MB/1 GB/2 GB)/SDHC Memory Card (FUJIFILM recommendation (→p.18))
<b>File format</b>	Still image: DCF-compliant Compressed: Exif ver.2.2 JPEG, DPOF-compatible *Design rule for Camera File System compliant DPOF compatible Movie: AVI format, Motion JPEG Audio: WAVE format, Monaural sound
<b>Number of recorded pixels</b>	Still image: 3264 × 2448 pixels/3264 × 2176 pixels/2304 × 1728 pixels/ 1600 × 1200 pixels/640 × 480 pixels ( <b>GM</b> / <b>62</b> / <b>4M</b> / <b>2M</b> / <b>GM</b> )
<b>File size</b>	See the table on the p.152
<b>Lens</b>	Fujinon 5× optical zoom lens F3.8-F4.8
<b>Focal length</b>	f=5.9 mm-29.5 mm (Equivalent to approx. 36 mm-180 mm on a 35 mm camera)
<b>Digital zoom</b>	Approx. 5.1× (5× optical zoom lens is used together: Max. zoom scale: approx. 25.5×)
<b>Aperture (Wide-angle)</b>	F3.8/F6.4 (up to 2 steps)
<b>Focal range</b>	Normal: approx. 60 cm (2.0 ft.) to infinity Macro: wide-angle: approx. 9 cm (3.5 in.) to 80 cm (2.6 ft.) telephoto: approx. 30 cm (1.0 ft.) to 80 cm (2.6 ft.)

Continued ➡

System	
<b>Sensitivity</b>	AUTO/Equivalent to ISO 64/100/200/400/800/1600 (normal output sensitivity)
<b>Photometry</b>	TTL 256-zones metering
<b>Exposure control</b>	Program AE
<b>Scene position</b>	 (NATURAL & LIGHT),  (NATURAL LIGHT),  (AUCTION MODE),  (PORTRAIT),  (LANDSCAPE),  (SPORT),  (NIGHT),  (FIREWORKS),  (SUNSET),  (SNOW),  (BEACH),  (UNDERWATER),  (MUSEUM),  (PARTY),  (FLOWER),  (TEXT)
<b>Dual Image Stabilizer</b>	Available (CCD Shift)
<b>Intelligent Face Detection</b>	Available
<b>Exposure compensation</b>	-2 EV to +2 EV in 1/3 EV-step increments (   )
<b>Shutter speed</b>	4 sec. to 1/1000 sec. (depend on Exposure mode)
<b>Continuous shooting</b>	Top-3: Number of recorded frames: up to 3 frames (Max. 1.4 frames/sec.) Final-3: Number of recorded frames: Last 3 frames before releasing the shutter button (Max. 1.4 frames/sec.) Long-period: Number of recorded frames: Depend on memory size 1.5 sec. interval at  depending on quality level (Max. 0.6 frames/sec.)
<b>Focus</b>	Mode: Single-AF AF system: TTL contrast-type AF frame selection: AF (CENTER), AF (MULTI)

<b>System</b>	
<b>White balance</b>	Automatic scene recognition/Preset (Fine, Shade, Fluorescent (Daylight), Fluorescent (Warm White), Fluorescent (Cool White), Incandescent)
<b>Self-timer</b>	Approx. 2 sec./10 sec.
<b>Flash type</b>	Auto flash Effective range: (ISO: AUTO) Wide-angle: approx. 70 cm-3.6 m (2.3 ft.-12.8 ft.) Telephoto: approx. 70 cm-2.9 m (2.3 ft.-9.5 ft.) Macro: approx. 30 cm-80 cm (1.0 ft.-2.6 ft.)
<b>Flash mode</b>	Auto, Red-eye Reduction, Forced Flash, Suppressed Flash, Slow Synchro, Red-eye Reduction + Slow Synchro
<b>LCD monitor</b>	2.7 inches, Aspect ratio: 4:3; 230,000 pixels Amorphous silicon TFT, Approx. 97% coverage
<b>Movie</b>	(640 × 480) pixels/(320 × 240) pixels (640 / 320) (30 frames per second with monaural sound) Images can be recorded depending on the available space on a Memory Card or internal memory. Zoom cannot be used during movie recording.
<b>Photography functions</b>	Intelligent Face Detection, Intelligent Face Detection (red-eye removal), High-speed shooting, Best framing, Frame NO. memory
<b>Playback functions</b>	Intelligent Face Detection, Micro thumbnail, Trimming for blog, Trimming, Slide show, Sorting by date, Image rotate, Voice memo, IR communication
<b>IR communication function</b>	Supported standard: IrSimple™, IrSSTM/FIR Supported communication device: IrSimple™, IrSSTM supported device, and Pivi
<b>Other functions</b>	PictBridge, Exif print, Language (日本語, English, Français, Deutsch, Español, Italiano, 中文簡, 繁體, 한글, Русский, Português, Nederlands, Türkçe, Český, Magyar, Polski, Svenska), Silent mode, Folder function, xD/SD dual slot, Time difference
<b>Input/Output Terminal</b>	
<b>A/V OUT (Audio/Visual output)</b>	NTSC/PAL-type (with monaural sound)
<b>Digital input/output</b>	USB 2.0 Full-Speed, PTP (Picture Transfer Protocol) /MTP (Media Transfer Protocol)

**Continued** ➔

**Power Supply and Others**

**Power supply** Rechargeable Battery NP-45, DC coupler CP-45 (sold separately), AC power adapter AC-5VX (sold separately)

**Guide to the number of available frames for battery operation**

Battery Type	Number of frames
NP-45 (750 mAh)	Approx. 170 frames

According to the CIPA (Camera & Imaging Products Association) standard procedure for measuring digital still camera battery consumption (extract):

When using a battery, use the battery supplied with the camera. The storage media should be **xD-Picture Card**.

Pictures should be taken at a temperature of +23°C (+73°F), with the LCD monitor turned on, the optical zoom moved from full wide-angle to full telephoto (or vice-versa) and back again to its original position every 30 seconds, the flash used at full power every second shot and the camera turned off and then on again once every 10 shots.

- Note: Because the number of available shots varies depending on the level of charge in the battery, the figures shown here for the number of available shots using the battery is not guaranteed. The number of available shots will also decline at low temperatures.

**Camera dimensions (W/H/D)** 92 mm × 55.7 mm × 19.8 mm/3.6 in. × 2.2 in. × 0.8 in. (not including accessories and attachments)

**Camera mass (weight)** Approx. 138 g/4.9 oz. (not including accessories, battery and Memory Card)

**Weight for photography** Approx. 155 g/5.5 oz. (including battery and Memory Card)

**Operating Conditions** Temperature: 0°C to +40°C (+32°F to +104°F)  
80% humidity or less (no condensation)

<b>Battery NP-45</b>	
<b>Nominal voltage</b>	DC 3.7V
<b>Nominal capacity</b>	740 mAh
<b>Operating temperature</b>	0°C to +40°C (+32°F to +104°F)
<b>Dimensions</b>	31 mm x 39.4 mm x 5.7 mm(1.2 in. x 1.6 in. x 0.2 in.)(W x H x D)
<b>Mass (Weight)</b>	Approx. 15 g (1.0 oz.)

<b>Battery Charger BC-45</b>	
<b>Rated input</b>	100-240 V AC, 50/60 Hz
<b>Input capacity</b>	9.0 VA
<b>Rated output</b>	4.2 V DC, 550 mA
<b>Applicable batteries</b>	Rechargeable Battery NP-45
<b>Charging time</b>	Approx. 180 minutes
<b>Dimensions</b>	91 mm x 46 mm x 21 mm(3.6 in. x 1.8 in. x 0.8 in.)(L x W x D)
<b>Mass (Weight)</b>	Approx. 55 g (1.9 oz.) (excluding batteries)
<b>Operating temperatures</b>	0°C to + 40°C(+ 32°F to + 104°F)

### **Notes on Using the Battery Charger**

- The battery and battery charger themselves will become warm due to the power stored inside them. This is normal and does not indicate a fault. Wherever possible, use the battery charger in a well-ventilated location.
- There may be vibration noises from inside the battery charger during use. This is normal and does not indicate a fault.
- Do not use the battery charger to charge batteries other than rechargeable battery NP-45.
- The battery charger could cause interference if placed close to a radio during charging. In this event, move the radio and charger further apart.
- Do not leave the battery charger in the following types of locations:
  - Extremely humidity or high temperatures, such as close to a heating appliance or in direct sunlight
  - Places with strong vibration
  - In very dusty places
- The battery charger accepts input voltages of 100-240 V AC at 50 or 60 Hz and can be used all over the world. However, the shape of the plug and socket-outlet depends on the country of use. Consult your travel agent for details.

**Continued** ➔

### ■ Standard number of available frames/recording time per xD-Picture Card , SD Memory Card and internal memory

The number of available frames and recording time is approximate. The actual number of frames and recording time varies depending on the type of Memory Card or shooting conditions. Also, the number of frames and recording time displayed in the LCD monitor may not decrease regularly.

Quality setting	8M F	8M N	3:2	4M	2M	8M	640 (30 fps)	320 (30 fps)	
Number of recorded pixels	3264 × 2448		3264 × 2176	2304 × 1728	1600 × 1200	640 × 480	640 × 480	320 × 240	
Image data size	3.9 MB	2.0 MB	1.8 MB	980 KB	630 KB	130 KB	32 KB	20 KB	
Internal memory (approx.54 MB)	14	28	31	55	88	432	60 sec.	96 sec.	
xD-Picture Card	16 MB	4	8	9	16	25	124	17 sec.	27 sec.
	32 MB	8	16	18	32	51	249	34 sec.	55 sec.
	64 MB	16	32	36	64	102	499	70 sec.	110 sec.
	128 MB	32	64	72	128	204	999	140 sec.	221 sec.
	256 MB	65	130	145	257	410	1999	280 sec.	7.4 min.
	512 MB	130	259	290	515	819	3995	9.3 min.	14.8 min.
	1 GB	261	520	581	1031	1640	7996	18.7 min.	29.6 min.
	2 GB	520	1031	1163	2063	3199	15995	36.8 min.	59.2 min.
SD Memory Card	512 MB	126	251	281	499	793	3868	9.0 min.	14.3 min.
	1 GB	252	503	563	999	1589	7746	18.1 min.	28.7 min.
	2 GB	504	1000	1127	2000	3100	15504	35.6 min.	57.4 min.
SDHC Memory Card	4GB	996	1977	2229	3955	6131	30655	70.5 min.*	113.5 min.*
	8GB	1995	3959	4463	7919	12275	61375	141.1 min.*	227.3 min.*

\* A movie recording will stop automatically when a movie file becomes approx. 2GB. If you want to continue recording, press the shutter button again. The available recording time is displayed based on approx. 2GB.



---

If you shoot using the **xD-Picture Cards** with model numbers containing "M" such as DPC-M2GB, movie recording time may be reduced if you repeatedly record and erase (frame erase) image files. In such a case, erase all frames or format the **xD-Picture Card** before use. Back up important frames (files) onto your PC or another media.

- \* These specifications are subject to change without notice. FUJIFILM shall not be held liable for damages resulting from errors in this Owner's Manual.
- \* The LCD monitor on your digital camera is manufactured using advanced high-precision technology. Even so, small bright points and anomalous colors (particularly around text) may appear on the monitor. These are normal display characteristics and do not indicate a fault with the monitor. This phenomenon will not appear on the recorded image.
- \* The operation error may be caused in a digital camera by the strong radio interference (i. e. electric fields, static electricity, line noise, etc.).
- \* Due to the nature of the lens, the edges of images may appear distorted. This is normal.

# Explanation of Terms

---

## **EV**

A number denotes Exposure Value. The EV is determined by the brightness of the subject and sensitivity (speed) of the film or CCD. The number is larger for bright subjects and smaller for dark subjects. As the brightness of the subject changes, a digital camera maintains the amount of light hitting the CCD at a constant level by adjusting the aperture and shutter speed. When the amount of light striking the CCD doubles, the EV increases by 1. Likewise, when the light is halved, the EV decreases by 1.

## **Frame rate (fps)**

The frame rate refers to the number of images (frames) that are photographed or played back per second. For example, when 10 frames are continuously photographed in a 1-second interval, the frame rate is expressed as 10 fps.

For reference, TV images are displayed at 30 fps (NTSC).

## **JPEG**

Joint Photographic Experts Group

A file format used for compressing and saving color images. The higher the compression rate, the greater the loss of quality in the decompressed (restored) image.

## **Motion JPEG**

A type of AVI (Audio Video Interleave) file format that handles images and sound as a single file. Images in the file are recorded in JPEG format. Motion JPEG can be played back by QuickTime 3.0 or later.

## **Smear**

A phenomenon specific to CCDs whereby white streaks appear on the image when there is a very strong light source, such as the sun or reflected sunlight, in the photography screen.

## **WAVE**

A standard format used on Windows systems for saving audio data. WAVE files have the ".WAV" file extension and the data can be saved in either compressed or uncompressed format. Uncompressed recording is used on this camera.

WAVE files can be played back on a personal computer using the following software:

Windows: MediaPlayer

Macintosh: QuickTime Player (QuickTime 3.0 or later)

## **White Balance**

Whatever the kind of the light, the human eye adapts to it so that a white object still looks white. On the other hand, devices such as digital cameras see a white subject as white by first adjusting the color balance to suit the color of the ambient light around the subject. This adjustment is called matching the white balance.



Exif Print Format is a newly revised digital camera file format that contains a variety of shooting information for optimal printing.

# FUJIFILM Digital Camera Worldwide Network

If you have technical questions or if you need repair service, ask the following local distributor.  
Please present the warranty card and your purchase receipt when you ask for repairs. Refer to the warranty card for conditions of the warranty.  
There is a case that repair and Technical support cannot be accepted for some models which your local distributor does not deal with.  
These lists are subject to change without notice.

<b>NORTH AMERICA</b>		
Canada	<b>FUJIFILM Canada Inc.</b> Technical support Repair service	600 Suffolk Court Mississauga Ontario, L5R 4G4 TEL 1-866-818-FUJI (3854) <a href="http://www.fujihelp.ca">http://www.fujihelp.ca</a> 600 Suffolk Court Mississauga Ontario, L5R 4G4 TEL 1-800-263-5018 FAX 1-905-755-2993 <a href="http://www.fujihelp.ca">http://www.fujihelp.ca</a>
U.S.A.	<b>FUJIFILM U.S.A., Inc.</b> Technical support Repair service	1100 King George Post Rd., Edison, NJ 08837 TEL 800-800-3854 FAX 732-857-3487 <a href="mailto:digitalinfo@fujifilm.com">digitalinfo@fujifilm.com</a> 1100 King George Post Rd., Edison, NJ 08837 TEL 732-857-3000 FAX 732-857-3471 <a href="mailto:njcamerarepair@fujifilm.com">njcamerarepair@fujifilm.com</a>
Hawaii	<b>FUJIFILM Hawaii, Inc.</b> Technical support & Repair service	94-468 Akoki Street, Waipahu, HI. 96797 TEL 1-808-677-3854, ext. 209 FAX 1-808-677-1443 <a href="mailto:kurt_kmett@fujifilmhawaii.com">kurt_kmett@fujifilmhawaii.com</a>
<b>CENTRAL &amp; SOUTH AMERICA</b>		
Argentina	<b>Imagen e informacion S.A.</b> Technical support & Repair service	Fondo de la Legua 936 San Isidro Pcia. de Buenos Aires TEL +54-11-4836-1000 FAX +54-11-4836-1144 <a href="mailto:servtec@imageneinformacion.com.ar">servtec@imageneinformacion.com.ar</a>
Bolivia	<b>Reifschneider Bolivia Ltda.</b> Technical support & Repair service	Calle H N.º 5 - Equipetrol Norte - Santa Cruz TEL +591 33 44 1129 FAX +591 33 45 2919 <a href="mailto:gciagral@bibosi.scz.entelnet.bo">gciagral@bibosi.scz.entelnet.bo</a>
Brazil	<b>FUJIFILM do Brasil Ltda.</b> Technical support & Repair service	Av. Vereador José Diniz, 3400 - Campo Belo, São Paulo/SP TEL 0800-12-8600 FAX +55 11 5091-4150 <a href="mailto:camarasdigitais@fujifilm.com.br">camarasdigitais@fujifilm.com.br</a>
Chile	<b>Reifschneider SA</b> Technical support & Repair service	Av. El Conquistador del Monte 5024, Huechuraba, Santiago, Chile TEL 02-4431500 FAX 02-4431596 <a href="mailto:ceciliaalvo@reifschneider.cl">ceciliaalvo@reifschneider.cl</a>
Colombia	<b>Animex de Colombia Ltda.</b> Technical support & Repair service	Calle 44 N.º 13-43 Piso 2 Apartado 18001 - Bogotá TEL +57 1 338-0299 FAX +57 1 288-2208 <a href="mailto:animex@etb.net.co">animex@etb.net.co</a>
Ecuador	<b>Espacri Cia Ltda</b> Technical support & Repair service	Bolivar 5-69 y Hermano Miguel TEL 593-72-835526 FAX 593-72-833157

## FUJIFILM Digital Camera Worldwide Network

Ecuador	<b>Importaciones Espacri Cia. Ltda.</b> Technical support & Repair service	Simón Bolívar 5-69 y Hno. Miguel - Cuenca TEL +593 783 5526 FAX +593 783 3157 portiz@fujifilm.com.ec
Mexico	<b>Fujifilm de Mexico, S.A. de C.V.</b> Technical support Repair service	Av. Ejercito Nacional 351, Col. Granada 11520 Mexico, D.F. TEL (52-55) 5263-5566 / 68 FAX (52-55) 5254-1508 jlgiraud1@fujifilm.com.mx Av. Presidente Juarez 2007, Col. Tepetlalcalko, 54090 Tlalnepanltla, Edo. de Mexico TEL (52-55) 5263-5500 FAX (52-55) 5254-1508 jlgiraud1@fujifilm.com.mx
Paraguay	<b>Errece S.R.L.</b> Technical support & Repair service	Edificio Unitas 15 de Agosto 1035, Asunción TEL +595 21 444256 FAX +595 21 444651 jmarbulo@fujifilm.com.py
Peru	<b>Procesos de Color S.A.</b> Technical support & Repair service	Pablo Bermudez 111 Apartado 3794 - Esq. Arequipa - Lima 11 TEL +51 14 33 5563 FAX +51 14 33 7177 jalvarado@fujifilm.com.pe
Uruguay	<b>Fotocamara S.R.L.</b> Technical support & Repair service	Cuareim 1439, montevideo, Uruguay TEL +598-2-9002004 FAX +598-2-9008430 fotocam@adinet.com.uy
Uruguay	<b>Kiel S.A.</b> Technical support & Repair service	Maldonado 1787 Montevideo- Uruguay TEL (05982) 419 4542 FAX (05982) 412 0046 kiel@fujifilm.com.uy
Venezuela	<b>C. Hellmund &amp; Cia Sa</b> Technical support & Repair service	Av. Ppal Diego Cisneros Caracas Venezuela Edf Oficentro TEL 0212-2022300 FAX 0212-2399796 hellmund@hellmund.com

### EUROPE

Austria	<b>Fuji Film Oesterreich</b> Technical support & Repair service	Traviatagasse/Pfarrgasse, 1230 Vienna, Austria TEL 0043 1 6162606/51 or 52 FAX 0043 1 6162606/58 kamera.service@fujifilm.at
Belgium	<b>Belgian Fuji Agency</b> Technical support & Repair service	20, Avenue Lavoisier, Wavre, 1300, Belgium TEL 3210242090 FAX 3210238562 info@fuji.be
Croatia	<b>I&amp;I d.o.o.</b> Technical support Repair service	Hondlova 2, Zagreb, Croatia TEL 38512319060 FAX 2310240 dsaravanja@fujifilm.hr Hondlova 2, Zagreb, Croatia TEL 38512316228 FAX 2310240 info@fujifilm.hr
Cyprus	<b>PMS IMAGING LTD</b> Technical support & Repair service	11, Dighenis Akritas Avenue, P.O.BOX 22315, 1586 Nicosia TEL 35722746746 FAX 35722438209 mariosashiotis@fujifilm.com.cy

Cyprus	<b>Doros Neophytou CAMERA REPAIRS</b> Technical support & Repair service	28B, Agiou Demetriou, Acropoli, Nicosia TEL 35722314719 FAX 35722515562 dorosn@logosnet.cy.net
Czech Republic	<b>Fujifilm Cz., s.r.o.</b> Technical support	U nakladoveho nadrazi 2/1949, 130 00 Praha 3 TEL 00420 234 703 411 FAX 00420 234 703 489 fricman@fujifilm.cz
Czech Republic	<b>AWH servis</b> Repair service	Milesovska 1, 130 00 Praha 3, Czech republic TEL 00420 222 721 525 FAX 00420 222 720 122 awh@awh.cz
Denmark	<b>Fujifilm Danmark A/S</b> Technical support & Repair service	Stubbeled 2, 2950 Vedbæk Denmark TEL 0045 45662244 FAX 0045 45662214 fujifilm@fujifilm.dk
Finland	<b>Fuji Finland Oy</b> Technical support & Repair service	Martinkyläntie 41, 01720 Vantaa, Finland TEL +358 9 825951 FAX +358 9 870 3818 fuji@fuji.fi
France	<b>FUJIFILM France</b> Technical support & Repair service	2, Avenue Franklin, 78186 Saint-Quentin en Yvelines, France FAX 33 1 01 30 58 58 65 direction.technique@fujifilm.fr
Germany	<b>FUJIFILM Electronic Imaging Europe GmbH</b> Technical support & Repair service	Benzstrasse 2, 47533 Kleve, Germany International call TEL +49 211 50890 FAX +49 211 5089668 service@fujifilm.de National call* TEL 0180 5898980 FAX 0180 5898982 *12 Cent/Min aus dem deutschen Festnetz
Greece	<b>FUJIFILM HELLAS S.A.</b> Technical support & Repair service	1, Ihou & Ag. Anargiron str., 175 64 P.Phailro, Athens, Greece TEL 0030 210 9404100 FAX 0030 210 9404397 fujifilm@fujifilm.gr
Hungary	<b>Fujifilm Hungary Ltd.</b> Technical support	Váci ut 19. Budapest, 1134, Hungary TEL 3612389410 FAX 3612389401 fujifilm@fujifilm.hu
Iceland	<b>Icephoto (Ljosmyndavörur)</b> Technical support & Repair service	Skipholt 31, 105 Reykjavik, Iceland TEL 354 568 0450 FAX 354 568 0455 framkollun@fujifilm.is
Italy	<b>FujiFilm Italia S.p.A.</b> Technical support Repair service	Via Dell'Unione Europea, 4 - 20097 San Donato Milanese (MI), Italy TEL 039-02895821 FAX 039-0289582912 info@fujifilm.it Fujifilm On Line - Call center TEL 039-026695272 info@fujifilm.it
Lithuania	<b>Fujifilm Lithuania</b> Technical support & Repair service	Gerosios Vilties str. 38, LT-03143 Vilnius, Lithuania TEL 370-5-2130121 FAX 3705-5-2134066 info@fujifilm.lt

## FUJIFILM Digital Camera Worldwide Network

Malta	<b>Ciancio (1913) Co.Ltd.</b> Technical support & Repair service	Fuji Tech Centre, Ciancio House, Cannon Road, Qormi, QRM05 TEL 0356-21-480500 FAX 0356-21-488328 info@fujifilm.com.mt
Norway	<b>Fujifilm Norge AS</b> Technical support	Lilleakerveien 10, 0283 Oslo, Norway TEL 0047-02273 FAX 0047-22736020 <a href="http://www.fujifilm.no/">http://www.fujifilm.no/</a> <a href="mailto:post@fujifilm.no">mailto:post@fujifilm.no</a>
	Repair service	Liaveien 1, 5132 Nyborg, Norway TEL 0047-55393880 FAX 0047-55195201 <a href="http://www.camera.no/">http://www.camera.no/</a> <a href="mailto:service@camera.no">mailto:service@camera.no</a>
Poland	<b>Fujifilm Polska Distribution Sp. z o.o.</b> Technical support	Poland Al. Jerozolimskie 178; 02-486 Warszawa TEL +48-22-517-66-00 FAX +48-22-517-66-02 fujifilm@fujifilm.pl
	Repair service	Poland, Muszkieterow 15, 02-273 Warszawa TEL +48-22-886-94-40 FAX +48-22-886-94-42 <a href="mailto:serwis@fujifilm.pl">serwis@fujifilm.pl</a>
Portugal	<b>Fujifilm Portugal, Lda</b> Technical support	Av. Fontes Pereira de Melo, 342, 4100-259 Porto, Portugal TEL (351) 226194200 FAX (351) 226194213 <a href="mailto:finpix@fujifilm.pt">finpix@fujifilm.pt</a>
	Repair service	Av. Fontes Pereira de Melo, 342, 4100-259 Porto, Portugal TEL (351) 226194200 FAX (351) 225194662 <a href="mailto:cameras@fujifilm.pt">cameras@fujifilm.pt</a>
Romania	<b>CTS-Cardinal Top Systems Ltd</b> Technical support & Repair service	112, Calea Dorobanti street, 4 flat, 1sector, Bucharest, Romania TEL 4021-230-09-82 FAX 4021-230-09-82 <a href="mailto:cts_tirla@hotmail.com">cts_tirla@hotmail.com</a>
Russia	<b>ZAO "Fujifilm RU"</b> Technical support	Bld. 1, 10, Rozanova str., Moscow, 123007, Russia TEL +7-095-956-9858 FAX +7-095-230-6217 <a href="mailto:info@fujifilm.ru">info@fujifilm.ru</a>
	Repair service	18, Shelepikhinskaya Naberezhnaya str., Moscow, 123290, Russia TEL +7-095-797-3434 FAX +7-095-797-3434
Slovakia	<b>Fujifilm Slovakia</b> Technical support	Pribylinska 2, 831 04 Bratislava, Slovakia TEL 00421 2 44 888 077 FAX 00421 2 44 889 300 <a href="mailto:fujifilm@fujifilm.sk">fujifilm@fujifilm.sk</a>
	Repair service	FIS Tatracentrum, Hodzovo nam. 4 - Tatracentrum, 811 06 Bratislava, Slovakia TEL 00421 2 54 647 347 <a href="mailto:fis.tatracentrum@stonline.sk">fis.tatracentrum@stonline.sk</a>
Spain	<b>Fujifilm España S.A.</b> Technical support	Aragón 180, 08011 Barcelona (España) TEL 902012535 FAX 934515900 / 933230330 <a href="mailto:info@fujifilm.es">info@fujifilm.es</a>
	Repair service	Aragón 180, 08011 Barcelona (España) TEL 934511515 FAX 934515900 / 933230330 <a href="mailto:tallersat@fujifilm.es">tallersat@fujifilm.es</a>
Sweden	<b>Fujifilm Sverige AB</b> Technical support	Sveavägen 167 104 35 Stockholm TEL 46 8 506 141 70 FAX 46 8 506 142 09 <a href="mailto:kamera@fujifilm.se">kamera@fujifilm.se</a>
	Repair service	Sveavägen 167 104 35 Stockholm TEL 46 8 506 513 54 FAX 46 8 506 513 99 <a href="mailto:kameraverkstaden@fujifilm.se">kameraverkstaden@fujifilm.se</a>

Switzerland / Lichtenstein	<b>Fujifilm (Switzerland) AG</b> Technical support & Repair service	Niederhaslistrasse 12, 8157 Dietlikon, Switzerland TEL +41 44 855 5154 FAX +41 44 855 5329 RepairCenter@fujifilm.ch
The Netherlands	<b>FUJIFILM Electronic Imaging Nederland</b> Technical support Repair service	Hoogstraat 37, 3011 PE Rotterdam, The Netherlands TEL +31(0)102812600 FAX +31(0)102812660 helpdesk@fujifilm-digital.nl Hoogstraat 37, 3011 PE Rotterdam, The Netherlands TEL +31(0)102812620 FAX +31(0)102812650 camerareparaties@fujifilm-digital.nl
Turkey	<b>Fujifilm Türkiye Sinfo A.S.</b> Technical support Repair service	Fujifilm Plaza, Dereboyu Cad. 39 34660 Halkali, Istanbul, Turkey TEL +90 212 696 5090 FAX +90 212 696 5009 csarp@fujifilm.com.tr Fujifilm Plaza, Dereboyu Cad. 39 34660 Halkali, Istanbul, Turkey TEL +90 212 696 5090 FAX +90 212 696 5010 servis@fujifilm.com.tr
U.K.	<b>FUJIFILM UK Ltd.</b> Technical support Repair service	St Martins Way St Martins Business Centre Bedford MK42 0LF TEL +44 (0)123 424 5383 FAX +44 (0)123 424 5285 fujitec@fuji.co.uk St Martins Way St Martins Business Centre Bedford MK42 0LF TEL +44 (0)123 421 8388 FAX +44 (0)123 424 5285 fujitec@fuji.co.uk
Ukraine	<b>Image Ukraine CJSC</b> Technical support & Repair service	12, Kontraktova ploshcha, Kyiv 04070, Ukraine TEL +380-44-4909075 FAX +380-44-4909076 d@fujifilm.ua
<b>MIDDLE EAST</b>		
Iran	<b>Tehran Fuka Co.</b> Technical support & Repair service	229,"Fuji" Bldg., Mirdamad Blvd., Tehran 19189, Iran TEL (+98-21)2254810-19 FAX (+98-21)2221002 fuka@neda.net
Israel	<b>Shimone Group Ltd.</b> Technical support Repair service	Efal 33 keyriat Arie Petah Tikva 49130, Israel TEL (+) 972 3 9250666 digital@fujifilm.co.il Efal 33 keyriat Arie Petah Tikva 49130, Israel TEL (+) 972 3 9250666 FAX 972 3 9250699 khaim@shimone.com
Jordan	<b>Grand Stores</b> Technical support & Repair service	Al- Abdali, Amman / Jordan TEL 009626-4646387 FAX 009626-4647542 gstores@go.com.jo
Qatar	<b>Techno Blue</b> Technical support	Blue Salon Bldg, 3rd Floor, Suhaim bin Hamad st, Al- Saad, Doha TEL 00974 44 66 175 FAX 00974 44 79 053 prabu@techno-blue.com
Saudi Arabia	<b>Emam Distribution Co. Ltd.</b> Technical support	P.O. Box 1716, Jeddah 21441, Saudi Arabia TEL 96626978756 FAX 96626917036 service@fujifilm.com.sa

## FUJIFILM Digital Camera Worldwide Network

Syria	<b>Film Trading Company</b>	Al-Shahbandar P.O. Box:31180 Damascus SYRIA
	Technical support	TEL + 963 11 2218049 FAX + 963 11 44673456 f.t.c@Net.SY
	Repair service	Al-cheikh Taha P.O. Box: 6171 Aleppo SYRIA
U.A.E.	<b>Grand Stores</b>	P. O. Box 2144, Saleh Bin Lahej Building, Al Garhoud, Deira, Dubai
	Technical support & Repair service	TEL + 963 21 4641903 FAX + 963 21 4641907 filmtradin@Net.SY
Yemen	<b>Al-Haidary Trading</b>	P.O.Box-2942 Haddah St. HTC, Sana'a, Yemen
	Technical support	TEL 00967-1-503980 FAX 00967-1-503983
	Repair service	P.O.Box-2942 Haddah St. HTC, Sana'a, Yemen
		TEL 00967-1-503977 FAX 00967-1-503983

### AFRICA

Egypt	<b>Foto Express Egypt</b>	426 Pyramids St., Giza, Egypt
	Technical support & Repair service	TEL (202) 7762062 FAX (202) 7760169 fotoegypt@access.com.eg
Kenya	<b>Fuji Kenya Ltd</b>	P.O.Box 41669-00100, Fuji Plaza, Chiromo Road, Nairobi, Kenya.
	Repair service	TEL (254-20)4446265-8 FAX (254-20)4448515 / 7 info@fujifilm.co.ke

### OCEANIA

Australia	<b>FUJIFILM Australia Pty Ltd</b>	Locked Bag 5100, Brookvale, NSW, 2100
	Technical support & Repair service	TEL 1800 226 355 FAX +61 (2) 9466 2854 digital@fujifilm.com.au
Fiji	<b>Brijjal &amp; Co. Ltd</b>	70-72 Cumming Street, Suva, Fiji
	Technical support & Repair service	TEL (679)3304133 FAX (679)3302777 kapadia@connect.com.fj
New Caledonia	<b>Phocidis SARL</b>	58, rue Higginson - B.P.661 - 98845
	Technical support & Repair service	TEL (00 687) 25-46-35 FAX (00 687) 28-66-70 phocidis@phocidis.nc
New Zealand	<b>Fujifilm NZ Ltd</b>	Cnr William Pickering & Bush Road Albany, Auckland
	Technical support & Repair service	TEL +64-9-4140400 FAX +64-9-4140410 glenn.beaumont@fujifilm.co.nz
Papua New Guinea	<b>Oceania PNG Limited</b>	Section 15, Allotment 1, Reke St, Boroko NCD. PNG. Mail: PO Box 2167, Boroko NCD. PNG. TEL +675 3256411 FAX +675 3250311 oceania@daltron.com.pg



<b>ASIA</b>		
Hong Kong	<b>Fuji Photo Products Co., Ltd.</b> Technical support & Repair service	8/F., TSUEN WAN IND. CENTRE, 220 TEXACO RD., TSUEN WAN, HONG KONG TEL (852)2406 3287 FAX (852)2408 3130 rsd@chinahpphoto.com.hk
Indonesia	<b>PT Modern Photo Tbk</b> Technical support & Repair service	Jl.Matraman Raya 12, Jakarta Timur 13150 TEL +62 021 2801000 FAX +62 021 8581620+62 021 2801012 assd-kmr@modernphoto.co.id
Malaysia	<b>FUJIFILM (Malaysia) Sdn. Bhd.</b> Technical support Repair service	Letter Box 1, Level 10, 11 & 12, Menara Axis, No 2, Jalan 51A/223, 46100 Petaling Jaya, Selangor Darul Ehsan, Malaysia TEL 603-79584700 FAX 603-79584110 digital@fujifilm.com.my Letter Box 1, Level 10, 11 & 12, Menara Axis, No 2, Jalan 51A/223, 46100 Petaling Jaya, Selangor Darul Ehsan, Malaysia TEL 603-79584700 FAX 603-79584110 technical@fujifilm.com.my
Philippines	<b>YKL Development &amp; Trdg. Corp.</b> Technical support Repair service	24 Sto. Domingo St., Quezon City 1100, Philippines TEL 632-7436601-06 FAX 632-7324661 digital@yklcolor.com 24 Sto. Domingo St., Quezon City 1100, Philippines TEL 632-7436601-06 FAX 632-7324661 tech_services@yklcolor.com
Singapore	<b>FUJIFILM (Singapore) Pte Ltd</b> Technical support & Repair service	10 New Industrial Road Fujifilm Building Singapore 536201 TEL 65-6380 5557 FAX 65-6281 3594 service@fujifilm.com.sg
South Korea	<b>Korea Fujifilm Co., Ltd.</b> Technical support	30-1, Mukjeung-dong, Jung-gu, Seoul, Korea TEL +82-2-3282-7363 FAX +82-2-2269-7435 photo@fujifilm.co.kr
South Korea	<b>Yonsan AS Center (Fujidigital)</b> Repair service	#301, 3F, Jeonjaland, 16-9, Hangangro3-ga, Yongsan-gu, Seoul, Korea TEL +82-2-701-1472 FAX +82-2-718-1331 1bow@hanmail.net
South Korea	<b>Kangnam AS Center (Digitalgallery)</b> Repair service	2F, Hyeongin Tower, 23-2, Bangyi-dong, Songpa-gu, Seoul, Korea TEL +82-2-2203-1472 FAX +82-2-418-5572 nurijili@hanmail.net
South Korea	<b>Busan AS Center (Digital-Sewon)</b> Repair service	241-4, Bujeon-dong, Busanjin-gu, Busan, Korea TEL +82-51-806-1472 FAX +82-51-817-0083 merahan@yahoo.co.kr
Taiwan	<b>Hung Chong Corp.</b> Technical support & Repair service	No. 38, Min-Chuan E. Rd. Sec. 6, Taipei (114), Taiwan, R.O.C. TEL 886-2-6602-8988 FAX 886-2-2791-8647 dah@mail.hungchong.com.tw
Thailand	<b>FUJIFILM (Thailand) Ltd.</b> Technical support Repair service	388 SP Building, 8th Floor, Phayathai, Bangkok 10400 TEL +662-2730029 ext. 755 FAX +662-2730239 supaleark@fujifilm.co.th 388 SP Building, 8th Floor, Phayathai, Bangkok 10400 TEL +662-2730029 ext.761,762 FAX +662-2730239 warin@fujifilm.co.th

FUJIFILM Digital Camera Worldwide Network

---

Vietnam

**International Minh Viet Co., Ltd.**

Technical support &

Repair service

99-107 Bach Van street, Ward 5, District 5, Ho chi minh city

TEL +84-8-8366807 ext.122 FAX +84-8-8380621

[diep.phanthithanh@imv.com.vn](mailto:diep.phanthithanh@imv.com.vn)

---



# FUJIFILM

---

## **FUJIFILM Corporation**

7-3, AKASAKA 9-CHOME, MINATO-KU, TOKYO 107-0052, JAPAN

[http://www.fujifilm.com/products/digital\\_cameras/index.html](http://www.fujifilm.com/products/digital_cameras/index.html)

Printed in China  
1AG6P1P3825-A

# Notes and Cautions

## IMPORTANT SAFETY INSTRUCTIONS

### Read Instructions:

All the safety and operating instructions should be read before the appliance is operated.

### Retain Instructions:

The safety and operating instructions should be retained for future reference.

### Heed Warnings:

All warnings on the appliance and in the operating instructions should be adhered to.

### Follow Instructions:

All operating and use instructions should be followed.

### Installation

**Power Sources**—This video product should be operated only from the type of power source indicated on the marking label. If you are not sure of the type of power supply to your home, consult your appliance dealer or local power company. For video products intended to operate from battery power, or other sources, refer to the operating instructions.

**Grounding or Polarization**—This video product is equipped with a polarized alternating-current line plug (a plug having one blade wider than the other). This plug will fit into the power outlet only one way. This is a safety feature. If you are unable to insert the plug fully into the outlet, try reversing the plug. If the plug should still fail to fit, contact your electrician to replace your obsolete outlet. Do not defeat the safety purpose of the polarized plug.

**Alternate Warnings**—This video product is equipped with a 3-wire grounding-type plug, a plug having a third (grounding) pin. This plug will only fit into a grounding-type power outlet. This is a safety feature. If you are unable to insert the plug into the outlet, contact your electrician to replace your obsolete outlet. Do not defeat the safety purpose of the grounding-type plug.

**Overloading**—Do not overload wall outlets and extension cords as this can result in a risk of fire or electric shock.

**Ventilation**—Slots and openings in the cabinet are provided for ventilation and to ensure reliable operation of the video product and to protect it from overheating, and these openings must not be blocked or covered.

The openings should never be blocked by placing the video product on a bed, sofa, rug, or other similar surface.

This video product should not be placed in a built-in installation such as a bookcase or rack unless proper ventilation is provided or the manufacturer's instructions have been adhered to.

This video product should never be placed near or over a radiator or heat register.

**Attachments**—Do not use attachments not recommended by the video product manufacturer as they may cause hazards.

**Water and Moisture**—Do not use this video product near water – for example, near a bath tub, wash bowl, kitchen sink, or laundry tub, in a wet basement, or near a swimming pool, and the like.

**Power-Cord Protection**—Power-Supply cords should be routed so that they are not likely to be walked on or pinched by items placed upon or against them, paying particular attention to cords at plugs, convenience receptacles, and the point where they exit from the appliance.

**Accessories**—Do not place this video product on an unstable cart, stand, tripod, bracket, or table. The video product may fall, causing serious injury to a child or adult, and serious damage to the appliance. Use only with a cart, stand, tripod, bracket, or table recommended by the manufacturer, or sold with the video product. Any mounting of the appliance should follow the manufacturer's instructions, and should use a mounting accessory recommended by the manufacturer.

An appliance and cart combination should be moved with care. Quick stops, excessive force, and uneven surfaces may cause the appliance and cart combination to overturn.



### Antennas

**Outdoor Antenna Grounding**—If an outside antenna or cable system is connected to the video product, be sure the antenna or cable system is grounded so as to provide some protection against voltage surges and built-up static charges. Section 810 of the National Electrical Code, ANSI/NFPA No. 70, provides information with respect to proper grounding of the mast and supporting structure, grounding of the lead-in wire to an antennadischarge unit, size of grounding conductors, location of antenna-discharge unit, connection to grounding electrodes, and requirements for the grounding electrode.

**Power Lines**—An outside antenna system should not be located in the vicinity of overhead power lines or other electric light or power circuits, or where it can fall into such power lines or circuits. When installing an outside antenna system, extreme care should be taken to keep from touching such power lines or circuits as contact with them might be fatal.

EXAMPLE OF ANTENNA GROUNDING AS PER NATIONAL ELECTRICAL CODE

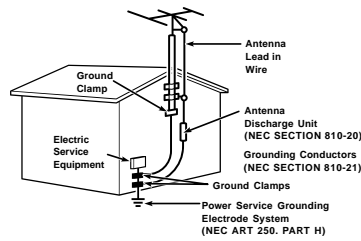

### Use

**Cleaning**—Unplug this video product from the wall outlet before cleaning. Do not use liquid cleaners or aerosol cleaners. Use a damp cloth for cleaning.

**Object and Liquid Entry**—Never push objects of any kind into this video product through openings as they may touch dangerous voltage points or shortout parts that could result in a fire or electric shock. Never spill liquid of any kind on the video product.

**Lightning**—For added protection for this video product receiver during a lightning storm, or when it is left unattended and unused for long periods of time, unplug it from the wall outlet and disconnect the antenna or cable system. This will prevent damage to the video product due to lightning and power-line surges.

### Service

**Servicing**—Do not attempt to service this video product yourself as opening or removing covers may expose you to dangerous voltage or other hazards. Refer all servicing to qualified service personnel.

**Damage Requiring Service**—Unplug this video product from the wall outlet and refer servicing to qualified service personnel under the following conditions:

When the power-supply cord or plug is damaged.

If liquid has been spilled, or objects have fallen into the video product.

If the video product has been exposed to rain or water.

If the video product has been dropped or the cabinet has been damaged.

If the video product does not operate normally be following the operating instructions. Adjust only those controls that are covered by the operating instructions as an improper adjustment of other controls may result in damage and will often require extensive work by a qualified technician to restore the video product to its normal operation.

When the video product exhibits a distinct change in performance - this indicates a need for service.

**Replacement Parts**—When replacement parts are required, be sure the service technician has used replacement parts specified by the manufacturer or have the same characteristics as the original part. Unauthorized substitutions may result in fire, electric shock or other hazards.

**Safety Check**—Upon completion of any service or repairs to this video product, ask the service technician to perform safety checks to determine that the video product is in proper operating condition.

## Before Using the Camera

Read the back side before using the camera.

### Test Shots Prior to Photography

For important photographs (such as weddings and overseas trips), always take a test shot and view the image to make sure that the camera is working normally.

• FUJIFILM Corporation cannot accept liability for any incidental losses (such as the costs of photography or the loss of income from photography) incurred as a result of faults with this product.

### Notes on Copyright

Images recorded using your digital camera system cannot be used in ways that infringe copyright laws without the consent of the owner, unless intended only for personal use. Note that some restrictions apply to the photographing of stage performances, entertainments and exhibits, even when intended purely for personal use. Users are also asked to note that the transfer of Memory Card containing images or data protected under copyright laws is only permissible within the restrictions imposed by those copyright laws.

### Handling Your Digital Camera

To ensure that images are recorded correctly, do not subject the camera to impact or shock while an image is being recorded.

### Liquid Crystal

If the LCD monitor is damaged, take particular care with the liquid crystal in the monitor. If any of the following situations arise, take the urgent action indicated.

• If liquid crystal comes in contact with your skin: Wipe the area with a cloth and then wash thoroughly with soap and running water.

• If liquid crystal gets into your eye: Flush the affected eye with clean water for at least 15 minutes and then seek medical assistance.

• If liquid crystal is swallowed: Flush your mouth thoroughly with water. Drink large quantities of water and induce vomiting. Then seek medical assistance.

### Trademark Information

- and **xD-Picture Card™** are trademarks of FUJIFILM Corporation.
- IBM PC/AT is a registered trademark of International Business Machines Corp. of the U.S.A.
- Macintosh, Power Macintosh, iMac, PowerBook, iBook and Mac OS are trademarks of Apple Inc., registered in the U.S. and other countries.
- Microsoft, Windows, the Windows logo, Windows Vista and the Windows Vista logo are trademarks or registered trademarks of Microsoft Corporation in the United States and/ or other countries. Windows is an abbreviated term referring to the Microsoft® Windows® Operating System.

- \* The "Designed for Microsoft® Windows® XP" logo refers to the camera and the driver only.
- IrSimple™ Trademark is owned by the Infrared Data Association®.
- IrSS™ Trademark or IrSimpleShot™ Trademark is owned by the Infrared Data Association®.
- SDHC logo is a trademark.
- Other company or product names are trademarks or registered trademarks of the respective companies.

### Notes on Electrical Interference

If the camera is to be used in hospitals or aircrafts, please note that this camera may cause interference to other equipment in the hospital or aircraft. For details, please check with the applicable regulations.

### Explanation of Color Television System

NTSC: National Television System Committee, color television telecasting specifications adopted mainly in the U.S.A., Canada and Japan.

PAL: Phase Alternation by Line, a color television system adopted mainly by European countries and China.

### Exif Print (Exif ver. 2.2)

Exif Print Format is a newly revised digital camera file format that contains a variety of shooting information for optimal printing.

\* See "Using Your Camera Correctly" (→OWNER'S MANUAL) for more information.

⇒ Also, read the back page.

# FUJIFILM

## FUJIFILM Corporation

7-3, AKASAKA 9-CHOME, MINATO-KU, TOKYO 107-0052, JAPAN

[http://www.fujifilm.com/products/digital\\_cameras/index.html](http://www.fujifilm.com/products/digital_cameras/index.html)

**Be sure to read this notes before using**

**Safety Notes**

- Make sure that you use your camera correctly. Read these Safety Notes and your Owner's Manual carefully before use.
- After reading these Safety Notes, store them in a safe place.

**About the Icons**

- The icons shown below are used in this document to indicate the severity of the injury or damage that can result if the information indicated by the icon is ignored and the product is used incorrectly as a result.

	<b>WARNING</b>	This icon indicates that death or serious injury can result if the information is ignored.
	<b>CAUTION</b>	This icon indicates that personal injury or material damage can result if the information is ignored.

The icons shown below are used to indicate the nature of the information which is to be observed.

- Triangular icons tell you that this information requires attention ("important").
- Circular icons with a diagonal bar tell you that the action indicated is prohibited ("Prohibited").
- Filled circles with an exclamation mark tell you an action that must be performed ("Required").

<b>WARNING</b>	
<b>If a problem arises, turn the camera off, remove the battery, disconnect and unplug the AC power adapter.</b> Continued use of the camera when it is emitting smoke, is emitting any unusual odor, or is in any other abnormal state can cause a fire or electric shock. • Contact your FUJIFILM dealer.	
<b>Do not allow water or foreign objects to enter the camera.</b> If water or foreign objects get inside the camera, turn the camera off, remove the battery and disconnect and unplug the AC power adapter. Continued use of the camera can cause a fire or electric shock. • Contact your FUJIFILM dealer.	
<b>Do not use the camera in the bathroom or shower.</b> This can cause a fire or electric shock.	
<b>Never attempt to change or take apart the camera. (Never open the casing.) Do not use the camera when it has been dropped or the casing is damaged.</b> This can cause a fire or electric shock. • Contact your FUJIFILM dealer.	
<b>Do not change, heat or unduly twist or pull the connection cord and do not place heavy objects on the connection cord.</b> These actions could damage the cord and cause a fire or electric shock. • If the cord is damaged, contact your FUJIFILM dealer.	
<b>Do not place the camera on an unstable surface.</b> This can cause the camera to fall or tip over and cause injury.	
<b>Never attempt to take pictures while in motion.</b> Do not use the camera while you are walking or driving a vehicle. This can result in you falling down or being involved in a traffic accident.	
<b>Do not touch any metal parts of the camera during a thunderstorm.</b> This can cause an electric shock due to induced current from the lightning discharge.	
<b>Do not use the battery except as specified.</b> Load the battery as aligned with the indicator.	
<b>Do not heat, change or take apart the battery. Do not drop or subject the battery to impacts. Do not store the battery with metallic products. Do not use chargers other than the specified model to charge the battery.</b> Any of these actions can cause the battery to burst or leak and cause fire or injury as a result.	

<b>WARNING</b>	
<b>Use only the battery or AC power adapters specified for use with this camera. Do not use voltages other than the power supply voltage shown.</b> The use of other power sources can cause a fire.	
<b>If the battery leaks and fluid gets in contact with your eyes, skin or clothing. Flush the affected area with clean water and seek medical attention or call an emergency number right away.</b>	
<b>Do not use the charger to charge batteries other than those specified here.</b> The Ni-MH battery charger is designed for Fujifilm HR-AA Ni-MH batteries. Using the charger to charge conventional batteries or other types of rechargeable batteries can cause the battery to leak fluid, overheat or burst.	
<b>When carrying the battery, install it in a digital camera or keep it in the hard case. When storing the battery, keep it in the hard case. When discarding, cover the battery terminals with insulation tape.</b> Contact with other metallic objects or battery could cause the battery to ignite or burst.	
<b>Keep Memory Cards out of the reach of small children.</b> Because Memory Cards are small, they can be swallowed by children. Be sure to store Memory Cards out of the reach of small children. If a child swallows a Memory Card, seek medical attention or call an emergency number.	

<b>CAUTION</b>	
<b>Do not use this camera in locations affected by oil fumes, steam, humidity or dust.</b> This can cause a fire or electric shock.	
<b>Do not leave this camera in places subject to extremely high temperatures.</b> Do not leave the camera in locations such as a sealed vehicle or in direct sunlight. This can cause a fire.	
<b>Keep out of the reach of small children.</b> This product could cause injury in the hands of a child.	
<b>Do not place heavy objects on the camera.</b> This can cause the heavy object to tip over or fall and cause injury.	
<b>Do not move the camera while the AC power adapter is still connected. Do not pull on the connection cord to disconnect the AC power adapter.</b> This can damage the power cord or cables and cause a fire or electric shock.	
<b>Do not use the AC power adapter when the plug is damaged or the plug socket connection is loose.</b> This could cause a fire or electric shock.	
<b>Do not cover or wrap the camera or the AC power adapter in a cloth or blanket.</b> This can cause heat to build up and distort the casing or cause a fire.	
<b>When you are cleaning the camera or you do not plan to use the camera for an extended period, remove the battery and disconnect and unplug the AC power adapter.</b> Failure to do so can cause a fire or electric shock.	
<b>When charging ends, unplug the charger from the power socket.</b> Leaving the charger plugged into the power socket can cause a fire.	
<b>Using a flash too close to a person's eyes may temporarily affect the eyesight.</b> Take particular care when photographing infants and young children.	
<b>When an xD-Picture Card is removed, the card could come out of the slot too quickly. Use your finger to hold it and gently release the card.</b>	
<b>Request regular internal testing and cleaning for your camera.</b> Build-up of dust in your camera can cause a fire or electric shock. • Contact your FUJIFILM dealer to request internal cleaning every 2 years. • Please note this is not a free of charge service.	

**Power Supply and Battery**

\* Confirm your battery type before reading the following descriptions.

The following explains proper use of batteries and how to prolong their life. Incorrect use of batteries can cause shorter battery life, as well as leakage, excessive heat, fire or explosion.

**1 Camera uses the Rechargeable Lithium-ion Battery**

- \* When shipped, the battery is not fully charged. Always charge the battery before using it.
- \* When carrying the battery, install it in a digital camera or keep it in the soft case.

**Battery Features**

- The battery gradually loses its charge even when not used. Use a battery that has been charged recently (in the last day or two) to take pictures.
- To maximize the life of the battery, turn the camera off as quickly as possible when it is not being used.
- The number of available frames will be lower in cold locations or at low temperatures. Take along a spare fully charged battery. You can also increase the amount of power produced by putting the battery in your pocket or another warm place to heat it and then loading it into the camera just before you take a picture.
- If you are using a heating pad, take care not to place the battery directly against the pad. The camera may not operate if you use a depleted battery in cold conditions.

**Charging the Battery**

- You can charge the battery using the battery charger (included).
  - The battery can be charged at ambient temperatures between 0°C and +40°C (+32°F and +104°F). Refer to the OWNER'S MANUAL for the time of charging battery.
  - You should charge the battery at an ambient temperature between +10°C and +35°C (+50°F and +95°F). If you charge the battery at a temperature outside this range, charging takes longer because the performance of the battery is impaired.
  - You cannot charge the battery at temperatures of 0°C (+32°F) or below.
- The Rechargeable Lithium-ion Battery does not need to be fully discharged or exhausted flat before being charged.
- The battery may feel warm after it has been charged or immediately after being used. This is perfectly normal.
- Do not recharge a fully charged battery.

**Battery Life**

At normal temperatures, the battery can be used at least 300 times. If the time for which the battery provides power shortens markedly, this indicates that the battery has reached the end of its effective life and should be replaced.

**Notes on storage**

- If a battery is stored for long periods while charged, the performance of the battery can be impaired. If the battery will not be used for some time, run the battery out before storing it.
- If you do not intend to use the camera for a long period of time, remove the battery from the camera.
- Store the battery in a cool place.
  - The battery should be stored in a dry location with an ambient temperature between +15°C and +25°C (+59°F and +77°F).
  - Do not leave the battery in hot or extremely cold places.

**Handling the Battery**

**Cautions for Your Safety:**

- Do not carry or store battery with metal objects such as necklaces or hairpins.
- Do not heat the battery or throw it into a fire.
- Do not attempt to take apart or change the battery.
- Do not recharge the battery with chargers other than those specified.
- Dispose of used battery promptly.
- Do not drop the battery or otherwise subject it to strong impacts.
- Do not expose the battery to water.
- Always keep the battery terminals clean.
- Do not store batteries in hot places. Also, if you use the battery for a long period, the camera body and the battery itself will become warm. This is normal. Use the AC power adapter if you are taking pictures or viewing images for a long period of time.

**2 Camera uses AA-size alkaline or Ni-MH (nickelmetal hydride) rechargeable batteries**

**Applicable Batteries**

- In the camera, use AA-size alkaline or Ni-MH (nickelmetal hydride) rechargeable batteries. Do not use AA-size manganese, nickel-cadmium (Ni-Cd) or lithium batteries in your camera because the heat created by the batteries could damage the camera or cause it not to work.
- The life of alkaline batteries varies between brands. The life of batteries you purchase may be shorter than those provided with the camera.

**Cautions for Using Battery**

- Do not heat the batteries or throw them into a fire.
- Do not carry or store batteries with metal objects such as necklaces or hairpins.
- Do not expose the batteries to water, and keep batteries from getting wet or stored in moist locations.
- Do not attempt to take apart or change the batteries, including battery casings.
- Do not subject the batteries to strong impacts.
- Do not use batteries that are leaking, deformed, discolored.
- Do not store batteries in warm or humid places.
- Keep the batteries out of reach of babies and small children.
- Make sure that the battery polarity (⊕ and ⊖) is correct.
- Do not use new with used batteries. Do not use charged and discharged batteries together.
- Do not use different types or brands of batteries at the same time.
- If you do not intend to use the camera for a long period of time, remove the batteries from the camera. Note if the camera is left with the batteries removed, the time and date settings are cleared.
- The batteries feel warm right after being used. Before removing the batteries, turn the camera off and wait for the batteries to cool down.
- Since batteries do not work well in cold weather or locations, warm the batteries by placing them inside your garments before use. Batteries do not work well when cold. They will work again when the temperature returns to normal.
- Soil (such as fingerprints) on the battery terminals makes the batteries charge less reducing the number of images. Carefully wipe the battery terminals with a soft dry cloth before loading.

If any liquid at all leaks from the batteries, wipe the battery compartment thoroughly and then load new batteries.

If any battery fluid comes into contact with your hands or clothing, flush the area thoroughly with water. Note that battery fluid can cause loss of eyesight if it gets into your eyes. If this occurs, do not rub your eyes. Flush the fluid out with clean water and contact your physician for treatment.

**Using the AA-size Ni-MH batteries correctly**

- Ni-MH batteries left unused in storage for long periods can become "deactivated". Also, repeatedly charging Ni-MH batteries that are only partially discharged can cause them to suffer from the "memory effect". Ni-MH batteries that are "deactivated" or affected by "memory" suffer from the problem of only providing power for a short time after being charged. To prevent this problem, discharge and recharge them several times using the camera's "Discharging rechargeable batteries" function. Deactivation and memory are specific to Ni-MH batteries and are not in fact battery faults. See OWNER'S MANUAL for the procedure for "Discharging rechargeable batteries".

Do not use the "Discharging rechargeable batteries" function when alkaline batteries being used.

- To charge Ni-MH batteries, use the quick battery charger (sold separately). Refer to the instructions supplied with the charger to make sure that the charger is used correctly.
- Do not use the battery charger to charge other batteries.
- Note that the batteries feel warm after being charged.
- Due to the way the camera is constructed, a small amount of current is used even when the camera is turned off. Note in particular that leaving Ni-MH batteries in the camera for a long period will overdischarge the batteries and may render them unusable even after recharging.
- Ni-MH batteries will self-discharge even when not used, and the time for which they can be used may be shortened as a result.
- Ni-MH batteries will deteriorate rapidly if overdischarged (e.g. by discharging the batteries in a flashlight) can be discharged to your digital camera to discharge the batteries.
- Ni-MH batteries have a limited service life. If a battery can only be used for a short time even after repeated discharge-charge cycles, it may have reached the end of its service life.

**Disposing of Batteries**

- When disposing of batteries, do so in accordance with your local waste disposal regulations.

**3 Notes on both models (1, 2)**

**AC Power Adapter**

- Always use the AC Power Adapter (sold separately) with the camera. The use of an AC Power adapter other than FUJIFILM AC Power Adapter (sold separately) can be damaged to your digital camera. For details on the AC power adapter, refer to the OWNER'S MANUAL of your camera.
- Use the AC power adapter for indoor use only.
- Plug the connection cord plug securely into the DC input terminal.
- Turn off the FUJIFILM Digital camera before disconnecting the cord from the DC input terminal. To disconnect, pull out the plug gently. Do not pull on the cord.
- Do not use the AC power adapter with any device other than your camera.
- During use, the AC power adapter will become hot to the touch. This is normal.
- Do not take apart the AC power adapter. Doing so could be dangerous.
- Do not use the AC power adapter in a hot and humid place.
- Do not subject the AC power adapter to strong shocks.
- The AC power adapter may emit a humming. This is normal.
- If used near a radio, the AC power adapter may cause static. If this happens, move the camera away from the radio.