

FUJIFILM

DIGITAL CAMERA

FINEPIX Z35
FINEPIX Z37

Owner's Manual

Thank you for your purchase of this product. This manual describes how to use your FUJIFILM FinePix Z35 or Z37 digital camera and the supplied software. Be sure that you have read and understood its contents before using the camera.

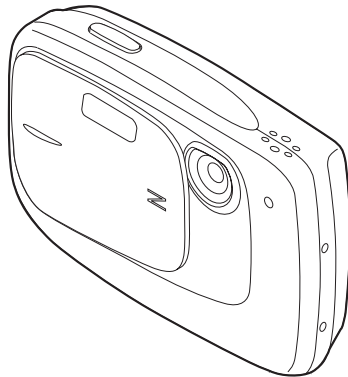

For information on related products, visit our website at
<http://www.fujifilm.com/products/index.html>

digital
Tools for the imagination.

Exif Print

SD
CC

PictBridge

CERTIFIED FOR
Windows
Vista™

BL00947-201 **EN**

Before You Begin

First Steps

Basic Photography and Playback

More on Photography

More on Playback

Movies

Connections

Menus

Technical Notes

Troubleshooting

Appendix

About This Manual

This manual is for use with the following FinePix cameras: the Z35 and Z37. All operations are identical; save where otherwise noted, the illustrations in this manual show the Z35.

Model	Monitor
FinePix Z35	2.5-inch
FinePix Z37	2.7-inch

Before using the camera, read this Owner's Manual and the other supplied documents. For information on specific topics, consult the sources below.

✓ **Camera Q & Apg. iii**

Know what you want to do but don't know the name for it? Find the answer in "Camera Q & A".

✓ **Troubleshootingpg. 80**

Having a specific problem with the camera? Find the answer here.

✓ **Glossarypg. 91**

The meanings of some technical terms may be found here.

✓ **Table of Contentspg. vi**

The "Table of Contents" gives an overview of the entire manual. The principal camera operations are listed here.

✓ **Warning Messages and Displayspg. 87**

Find out what's behind that flashing icon or error message in the monitor.

 **Memory Cards**

Pictures can be stored in the camera's internal memory or on optional SD and SDHC memory cards. In this manual, SD memory cards are referred to as "memory cards". For more information, see page 8.

Camera Q & A

Find items by task.



Camera Setup

Question	Key phrase	See page
How do I set the camera clock?	Date and time	14
Can I set the clock to local time when I travel?	Time difference	77
How do I keep the monitor from turning off automatically?	Auto power off	76
How do I make the monitor brighter or darker?	LCD brightness	76
How do I stop the camera beeping and clicking?	Silent mode	27
	Volume	75
What are the parts of the camera called?	Parts of the camera	2
What do the icons in the monitor mean?	Monitor	3
How do I use the menus?	Menus	55
What's behind that flashing icon or error message in the monitor?	Messages and displays	87
How much charge is left in the battery?	Battery level	16

Sharing Pictures

Question	Key phrase	See page
Can I print pictures on my home printer?	Printing pictures	43
Can I copy my pictures to my computer?	Viewing pictures on a computer	48

Taking Pictures

Question	Key phrase	See page
How many pictures can I take?	Memory capacity	92
Is there a quick and easy way to take snapshots?	 mode	16
How can I make good portraits?	Intelligent Face Detection	21
Can the camera automatically select the most suitable mode?	 mode	31
Is there a simple way to adjust settings for different scenes?	Shooting mode	30
How do I shoot close-ups?	Macro mode (Close-ups)	25
How do I keep the flash from firing?	Flash mode	26
How do I stop my subjects' eyes glowing red when I use the flash?		
How do I "fill-in" shadows on back-lit subjects?		
How do I take a group portrait that includes the photographer?	Self-timer mode	28
How do I frame pictures with the subject off to one side?	Focus lock	23
How do I shoot movies?	Recording movies	40

Viewing Pictures

Question	Key phrase	See page
How do I view my pictures?	Single-frame playback	34
Is there a simple way to delete one image?	Deleting pictures	20
How do I delete one or all images at once?	Erase	38
Can I zoom in on pictures during playback?	Playback zoom	35
How do I view a lot of pictures at once?	Multi-frame playback	36
How do I view all pictures taken on the same day?	Sort by date	37
Can I protect my pictures from accidental deletion?	Protect	65
Can I hide the icons in the monitor when viewing my pictures?	Choosing a display format	34
Can I view my pictures in a slide show?	Slide show	63
Can I add a short voice memo to my pictures?	Voice memo	69
Can I crop unwanted elements out of my pictures?	Crop	66
Can I copy pictures from internal memory to a memory card?	Copy	67
Can I process still images for posting to a blog?	Process still images	62
How do I view my pictures on TV?	Viewing pictures on TV	42

Table of Contents

About This Manual.....	ii
Camera Q & A.....	iii
Camera Setup.....	iii
Sharing Pictures.....	iii
Taking Pictures.....	iv
Viewing Pictures.....	v

Before You Begin

Introduction.....	1
Symbols and Conventions.....	1
Supplied Accessories.....	1
Parts of the Camera.....	2
The Monitor.....	3







First Steps

Inserting the Battery.....	4
Charging the Battery.....	6
Inserting a Memory Card.....	8
Turning the Camera On and Off.....	13
Shooting Mode.....	13
Playback Mode.....	13
Basic Setup.....	14

Basic Photography and Playback

Taking Pictures in  (AUTO) Mode.....	16
Viewing Pictures.....	20

More on Photography

 Intelligent Face Detection and Red-Eye Removal...21	21
Focus Lock.....	23
 Macro mode (Close-ups).....	25
 Using the Flash (Intelligent Flash).....	26
 Using the Self-Timer.....	28
 Shooting Mode.....	30
Selecting a Shooting Mode.....	30
Shooting Modes.....	30
 SCENE RECOGNITION.....	31

More on Playback

Single-Frame Playback.....	34
Playback Zoom.....	35
Multi-Frame Playback.....	36
Sort by Date.....	37
 Deleting Pictures.....	38

Movies

 Recording Movies.....	40
 Viewing Movies.....	41

Connections

Viewing Pictures on TV	42
Printing Pictures via USB	43
Connecting the Camera	43
Printing Selected Pictures	43
Printing the DPOF Print Order	44
Creating a DPOF Print Order	46
Viewing Pictures on a Computer	48
Installing FinePixViewer	48
Installing FinePixViewer: Windows	48
Installing FinePixViewer: Macintosh	51
Connecting the Camera	53

Menus

The Shooting Menu	55
Using the Shooting Menu	55
Shooting Menu Options	56
EXP. COMPENSATION	57
WHITE BALANCE	58
IMAGE QUALITY	58
ISO	59
FINEPIX COLOR	59
CONTINUOUS (Continuous shooting)	60

The Playback Menu	61
Using the Playback Menu	61
Playback Menu Options	61
TRIMMING FOR BLOG	62
SLIDE SHOW	63
RED EYE REMOVAL	63
IMAGE ROTATE	64
PROTECT	65
TRIMMING	66
COPY	67
VOICE MEMO	69
The Setup Menu	71
Using the Setup Menu	71
Setup Menu Options	72
IMAGE DISP.	73
FRAME NO.	74
ILLUMINATION	74
DIGITAL ZOOM	75
LCD POWER SAVE	75
VOLUME	75
SOUND	76
LCD BRIGHTNESS	76
FORMAT	76
AUTO POWER OFF	76
TIME DIFFERENCE	77

Technical Notes

Optional Accessories	78
Accessories from Fujifilm	79

Troubleshooting

Troubleshooting	80
Warning Messages and Displays	87

Appendix

Glossary	91
Internal Memory/Memory Card Capacity	92
Specifications	93
Caring for the Camera	97

Introduction

Symbols and Conventions

The following symbols are used in this manual:

 **Caution:** This information should be read before use to ensure correct operation.

 **Note:** Points to note when using the camera.

 **Tip:** Additional information that may be helpful when using the camera.

Menus and other text in the camera monitor are shown in bold. In the illustrations in this manual, the monitor display may be simplified for explanatory purposes.

Supplied Accessories

The following items are included with the camera:

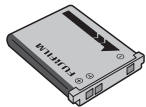

NP-45A rechargeable
battery

AC adapter
(The type of the
plug depends on the
country or region
where you purchased
the camera.)

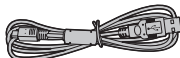

USB cable



CD-ROM

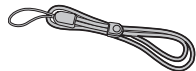

Strap

 **Attaching the Strap**
Attach the strap as shown.

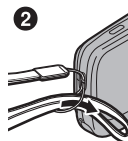
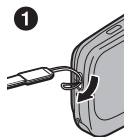

Owner's Manual
(may be distributed on
CD in some countries
or regions)

Parts of the Camera

For more information, refer to the page listed to the right of each item.

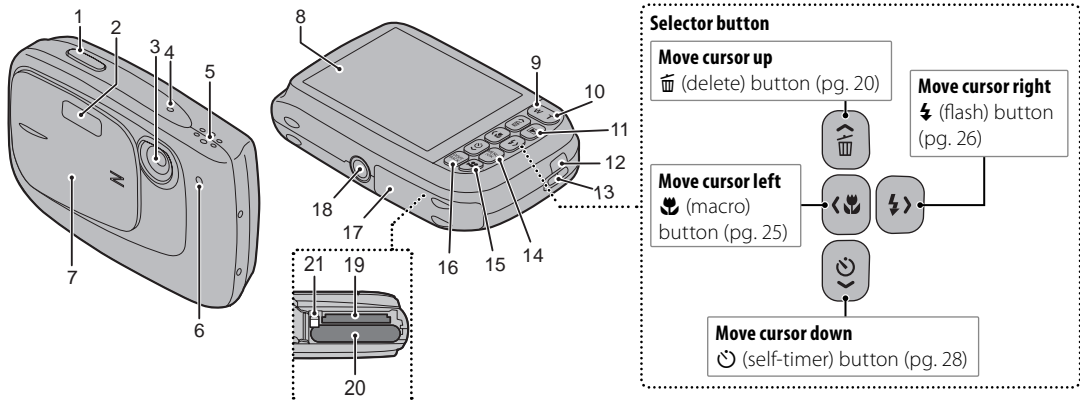

1	Shutter button.....	19	8	Monitor.....	3	16	DISP (display)/ BACK button.....	18, 34
2	Flash.....	26	9	W (zoom out) button.....	17, 35		(silent mode) button.....	27
3	Lens		10	T (zoom in) button.....	17, 35	17	Battery-chamber cover.....	4
4	Microphone.....	69	11	(playback) button.....	34	18	Tripod mount	
5	Speaker.....	70	12	USB multi-connector.....	6, 42, 43, 53	19	Memory card slot.....	9
6	Shooting indicator.....	74	13	Strap eyelet.....	1	20	Battery chamber.....	4
	Self-timer lamp.....	29	14	MENU/OK button.....	14	21	Battery latch.....	4
	Charging indicator.....	6	15	(movie recording) button.....	40			
7	ON/OFF switch and lens cover.....	13						

The Monitor

The following indicators may appear in the monitor during shooting and playback:

Shooting

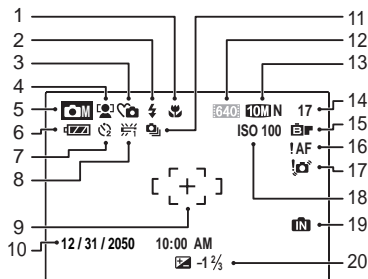

1	Macro (close-up) mode.....	25	12	Movie quality.....	40
2	Flash mode.....	26	13	Image quality.....	58
3	Silent mode.....	27	14	Number of available frames.....	92
4	Intelligent Face Detection indicator.....	21	15	FINEPIX COLOR.....	59
5	Shooting mode.....	30	16	Focus warning.....	18
6	Battery level.....	16	17	Blur warning.....	26
7	Self timer indicator.....	28	18	Sensitivity.....	59
8	White balance.....	58	19	Internal memory indicator*.....	8
9	Focus frame.....	18	20	Exposure compensation.....	57
10	Date and time.....	14			
11	Continuous mode.....	60			

* Indicates that no memory card is inserted and that pictures will be stored in the camera's internal memory (pg. 8).

Playback

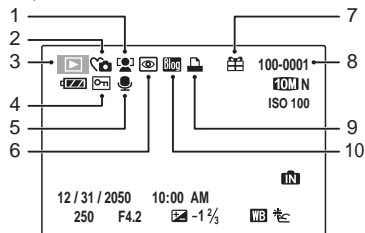

1	Intelligent Face Detection indicator.....	35	6	Red-eye removal indicator.....	63
2	Silent mode indicator.....	27	7	Gift image.....	34
3	Playback mode indicator.....	34	8	Frame number.....	74
4	Protected image.....	65	9	DPOF print indicator.....	47
5	Voice memo indicator.....	69	10	Blog image.....	62

Inserting the Battery

The following explains how to insert the battery into the camera.

1 Open the battery-chamber cover.

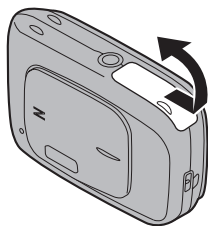

Note

Be sure the camera is off before opening the battery-chamber cover.

Cautions

- Do not turn the camera on or off while the battery-chamber cover is open. Failure to observe this precaution could result in damage to image files or memory cards.
- Do not use excessive force when handling the battery-chamber cover.

2 Insert the battery.

Face the gold terminals downward and align the orange stripe on the battery with the orange battery latch. Keeping the battery latch pressed to the side (①), slide the battery into the camera (②).

Confirm that the battery is securely latched.



Orange stripe

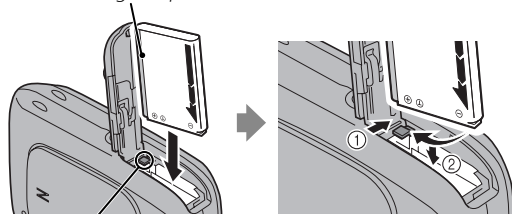

Battery latch

Caution

Insert the battery in the correct orientation. **Do not use force or attempt to insert the battery upside down or backwards.** The battery will slide in easily in the correct orientation.

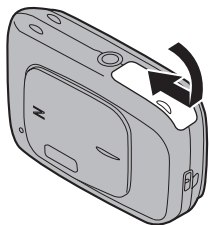
3 Close the battery-chamber cover.**Removing the Battery**

After turning the camera off, open the battery-chamber cover, press the battery latch to the side, and slide the battery out of the camera as shown.

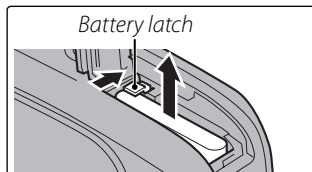
**Tips: Using an AC Adapter**

- The camera can be powered by a supplied AC adapter. See page 6 for details.
- If the camera is powered by an AC adapter, demo mode instructions will be displayed when the camera is turned on. Selecting this option starts a slide show. To cancel, press the shutter button.

Charging the Battery

The battery is not charged at shipment. Charge the battery before use.

- 1 Connect the supplied AC adapter into the USB multi-connector.

Confirm that the camera is off.

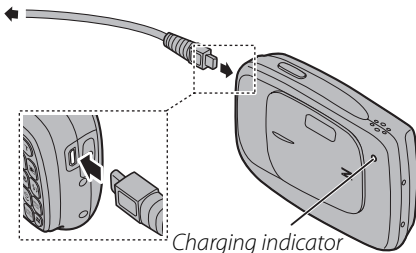

- 2 Plug the AC adapter in.

Plug the AC adapter into a power outlet. The Charging indicator will light up.

The Charging Indicator

The charging indicator shows battery charge status as follows:

Charging indicator	Battery status	Action
Off	Battery not inserted.	Check that the battery is properly inserted
	Battery fully charged.	Charging is complete
Glows	Battery charging.	—
Blinks	Battery fault.	Unplug the AC adapter (pg. 80)

- 3 Charge the battery.

Charging is complete when the charging indicator turns off.

Note

The battery cannot be charged when the camera is on.

⚠ Cautions: Caring for the Battery

- The only types of batteries you can use are NP-45A.
- Use only the camera to charge NP-45A. Failure to observe this precaution could result in product malfunction.
- Do not affix stickers or other objects to the battery. Failure to observe this precaution could make it impossible to remove the battery from the camera.
- Do not short the battery terminals. The battery could overheat.
- Do not remove the labels from the battery or attempt to split or peel the outer casing.
- The battery gradually loses its charge when not in use. Charge the battery one or two days before use.
- Read the supplied documentation for additional cautions concerning battery use.

⚠ Caution: Battery Life

A noticeable decrease in the length of time the battery will hold a charge indicates that it has reached the end of its service life and should be replaced.

⚠ Cautions: Charging the Battery

- Remove dirt from the battery terminals with a clean, dry cloth. Failure to observe this precaution could prevent the battery from charging.
- Charging times increase at low temperatures.

Inserting a Memory Card

Although the camera can store pictures in internal memory, SD memory cards (sold separately) can be used to store additional pictures.

When no memory card is inserted,  appears in the monitor and internal memory is used for recording and playback. Note that because camera malfunction could cause internal memory to become corrupted, the pictures in internal memory should periodically be transferred to a computer and saved on the computer hard disk or on removable media such as CDs or DVDs. The pictures in internal memory can also be copied to a memory card (see page 67). To prevent internal memory from becoming full, be sure to delete pictures when they are no longer needed.

When a memory card is inserted as described below, the card will be used for recording and playback.

■ **Compatible Memory Cards**

SanDisk SD and SDHC memory cards have been tested and approved for use in the camera. A complete list of approved memory cards is available at http://www.fujifilm.com/products/digital_cameras/index.html. Operation is not guaranteed with other cards. The camera can not be used with MultiMediaCard (MMC) or *xD-Picture* cards.

Caution

SD memory cards can be locked, making it impossible to format the card or to record or delete images. Before inserting an SD memory card, slide the write-protect switch to the unlocked position.

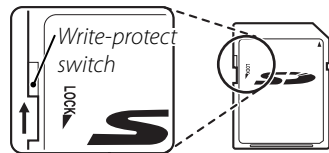

■ Inserting a Memory Card

1 Open the battery-chamber cover.

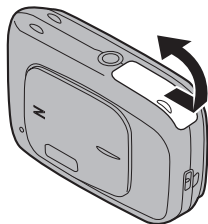

👉 Note

Be sure the camera is off before opening the battery-chamber cover.

⚠️ Cautions

- Do not turn the camera on or off while the battery-chamber cover is open. Failure to observe this precaution could result in damage to image files or memory cards.
- Do not use excessive force when handling the battery-chamber cover.

2 Insert the memory card.

Holding the memory card in the orientation shown below, slide it all the way in. Press firmly until it clicks into place.

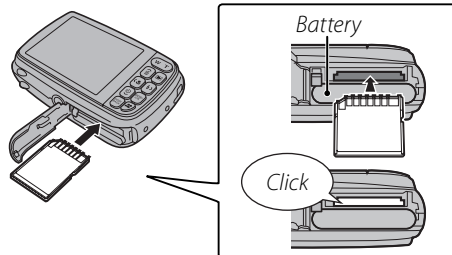

- Be sure card is at correct orientation; do not insert at an angle or use force.

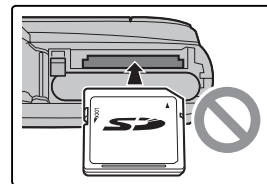

- If the battery-chamber cover cannot be closed, do not attempt to close it with excessive force, check that the card is correctly orientated.
- If the images are recorded in the internal memory after the card is inserted, check that the card is correctly inserted.

3 Close the battery-chamber cover.

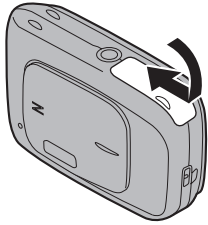

Removing Memory Cards

Be sure the camera is off before opening the battery-chamber cover. Press the card in and then release it slowly. The card can now be removed by hand.

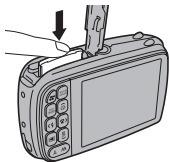

Cautions

- The memory card may spring out if you remove your finger immediately after pushing the card in.
- Memory cards may be warm to the touch after being removed from the camera. This is normal and does not indicate a malfunction.

Cautions

- Format SD memory cards before first use, and be sure to reformat all memory cards after using them in a computer or other device. For more information on formatting memory cards, see page 76.
- Memory cards are small and can be swallowed; keep out of reach of children. If a child swallows a memory card, seek medical assistance immediately.
- Do not use miniSD or microSD adapters that expose the back of the card. Failure to observe this precaution may cause damage or malfunction. Adapters that are larger or smaller than the standard dimensions of an SD card may not eject normally; if the card does not eject, take the camera to an authorized service representative. Do not forcibly remove the card.
- Do not turn the camera off or remove the memory card while the memory card is being formatted or data are being recorded to or deleted from the card. Failure to observe this precaution could damage the card.
- Do not affix labels to memory cards. Peeling labels can cause camera malfunction.
- Movie recording may be interrupted with some types of SD memory card.

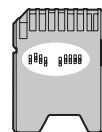

- The data in internal memory may be erased or corrupted when the camera is repaired. Please note that the repairer will be able to view pictures in internal memory.
- Formatting a memory card or internal memory in the camera creates a folder in which pictures are stored. Do not rename or delete this folder or use a computer or other device to edit, delete, or rename image files. Always use the camera to delete pictures from memory cards and internal memory; before editing or renaming files, copy them to a computer and edit or rename the copies, not the originals.

Turning the Camera On and Off

Shooting Mode

To turn the camera on, open the lens cover fully. The camera turns off when the lens cover is closed.

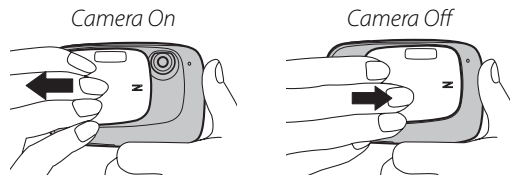

Tip: Switching to Playback Mode

Press the  button to start playback. Press the shutter button halfway to return to shooting mode.

Cautions

- Pictures can be affected by fingerprints and other marks on the lens. Keep the lens clean.
- Closing the cover does not completely cut power to the camera.

Tip: Auto Power Off

The camera will turn off automatically if no operations are performed for the length of time selected in the **AUTO POWER OFF** menu (see page 76). To turn the camera on, close and reopen the lens cover or press the  button for about a second.

Playback Mode

If the lens cover is closed, the camera can be turned on in playback mode by pressing the  button for about a second.

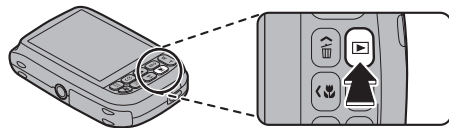

If the lens cover is closed, pressing the  button during playback will turn the camera off.

Tip: Switching to Shooting Mode

To exit to shooting mode, press the shutter button halfway. Press the  button to return to playback.

Basic Setup

A language-selection dialog is displayed the first time the camera is turned on. Set up the camera as described below (for information on resetting the clock or changing languages, see page 71).

1 Choose a language.



1.1 Press the selector up, down, left, or right to highlight a language.

1.2 Press **MENU/OK**.



2 Set the date and time.

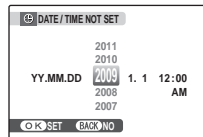

2.1 Press the selector left or right to highlight the year, month, day, hour, or minute and press up or down to change.

To change the order in which the year, month, and day are displayed, highlight the date format and press the selector up or down.

2.2 Press **MENU/OK**.



← Note

Go to the setup menu if you try to set the language and date again (pg. 71).

📄 Tip: The Camera Clock

If the battery is removed for an extended period, the camera clock will be reset when the camera is turned on. If the battery is left in the camera for about two hours, the battery can be removed for about 24 hours without resetting the clock.

Taking Pictures in (AUTO) Mode

This section describes how to take pictures in AUTO mode. AUTO mode is automatically selected the first time the camera is turned on; for information on restoring AUTO mode after shooting in other modes, see page 30.

- 1 Turn the camera on.**
Fully open the lens cover.

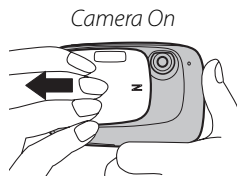

- 2 Check the battery level.**
Check the battery level in the monitor.

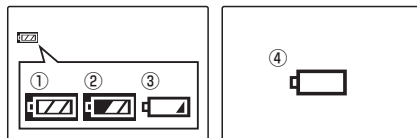

Indicator	Description
① (white)	Battery partially discharged.
② (white)	Battery more than half discharged.
③ (red)	Low battery. Charge as soon as possible.
④ (blinks red)	Battery exhausted. Turn camera off and charge battery.

3 Frame the picture.

Position the main subject in the focus area and use the zoom buttons to frame the picture in the monitor.

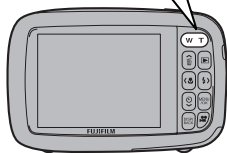
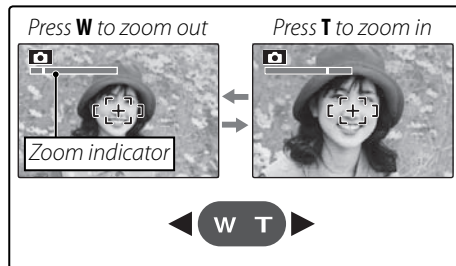

Zoom in using optical zoom, or use digital zoom (pg. 75) to zoom in closer.

Holding the Camera

Hold the camera steady with both hands and brace your elbows against your sides. Shaking or unsteady hands can blur your shots.

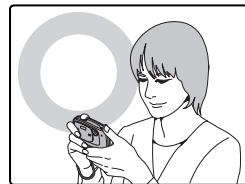

To prevent pictures that are out of focus or too dark (underexposed), keep your fingers and other objects away from the lens and flash.

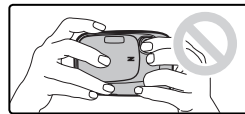

Tip: Focus Lock

Use focus lock (pg. 23) to focus on subjects that are not in the focus frame.

The Framing Grid

To display best framing (the framing grid) or to view or hide other indicators in the monitor, press the **DISP/BACK** button.

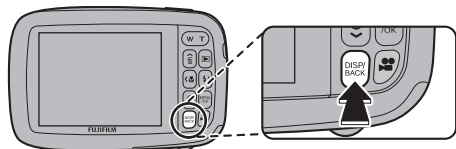

Indicators
displayed

Indicators
hidden



Best framing

To use best framing, position the main subject at the intersection of two lines or align one of the horizontal lines with the horizon. Use focus lock (pg. 23) to focus on subjects that will not be in the center of the frame in the final photograph.

4 Focus.

Press the shutter button halfway to focus on the main subject in the focus frame.

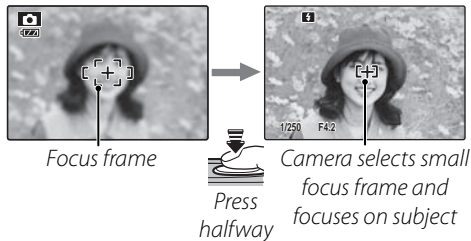

Focus frame

Camera selects small
focus frame and
focuses on subject

If the camera is able to focus, it will beep twice.

If the camera is unable to focus, the focus frame will turn red and a **!AF** indicator will appear in the monitor. Change the composition or use focus lock (pg. 23).

Note

The lens may make a noise when the camera focuses. This is normal.

5 Shoot.

Smoothly press the shutter button the rest of the way down to take the picture.



Tip: The Shutter Button

The shutter button has two positions. Pressing the shutter button halfway sets focus and exposure; to shoot, press the shutter button the rest of the way down.

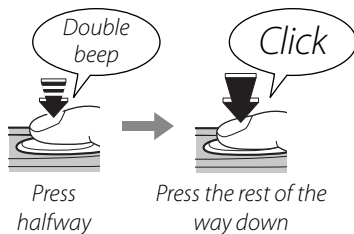

Note

If the subject is poorly lit, the flash may fire when the picture is taken. To take pictures without the flash, choose another flash mode (pg. 26).

Viewing Pictures

Pictures can be viewed in the monitor. When taking important photographs, take a test shot and check the results.

- 1 Press the  button.

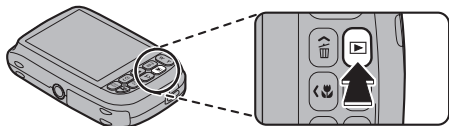

The most recent picture will be displayed in the monitor.



- 2 View additional pictures.

Press the selector right to view pictures in the order recorded, left to view pictures in reverse order.

Press the shutter button halfway to exit to shooting mode.



Deleting Pictures

To delete the picture currently displayed in the monitor, press the selector up () . The following dialog will be displayed.

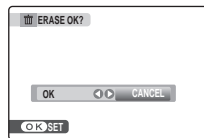
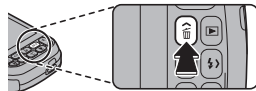

To delete the picture, press the selector left to highlight **OK** and press **MENU/OK**. To exit without deleting the picture, highlight **CANCEL** and press **MENU/OK**.

MENU
/OK

Tip: The Playback Menu

Pictures can also be deleted from the playback menu (pg. 38).

Intelligent Face Detection and Red-Eye Removal

Intelligent Face Detection allows the camera to automatically detect human faces and set focus and exposure for a face anywhere in the frame for shots that emphasize portrait subjects. Choose for group portraits to prevent the camera from focusing on the background. Intelligent Face Detection also offers a red-eye removal option for removing “red-eye” effects caused by the flash.



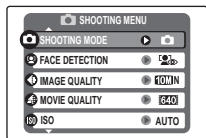

1 Turn Intelligent Face Detection on.

- 1.1 Press **MENU/OK** to display the shooting menu.



- 1.2 Press the selector up or down to highlight **FACE DETECTION**.
- 1.3 Press the selector right to display Intelligent Face Detection options.
- 1.4 Press the selector up or down to highlight the desired option.



Option	Description
 ON  ON	Intelligent Face Detection and red-eye removal on. Use with the flash.
 ON  OFF	Intelligent Face Detection on; red-eye removal off.
OFF	Intelligent Face Detection and red-eye removal off.

- 1.5 Press **MENU/OK** to select the highlighted option and return to shooting mode.



A  icon appears in the monitor when Intelligent Face Detection is on.



2 Frame the picture.

If a face is detected, it will be indicated by a green border. If there is more than one face in the frame, the camera will select the face closest to the center; other faces are indicated by white borders.



Green border

3 Focus.



Press the shutter button halfway to set focus and exposure for the subject in the green border.



4 Shoot.

Press the shutter button all the way down to shoot.



If  **ON**  **ON** is selected, the picture will be processed to reduce red-eye before it is recorded.

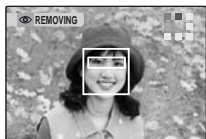

Intelligent Face Detection

Intelligent Face Detection is recommended when using the self-timer for group- or self-portraits (pg. 28).



When a picture taken with Intelligent Face Detection is displayed, the camera can automatically select faces for playback zoom (pg. 35), slide shows (pg. 63), cropping (pg. 66), red-eye removal (pg. 63), and zoom (continuous) (pg. 73).

Cautions

- If no face is detected when the shutter-release button is pressed halfway (pg. 82), the camera will focus on the subject at the center of the monitor and red-eye will not be removed. If the camera is unable to detect a face, turn Intelligent Face Detection off and use focus lock (pg. 23).
- If the subject moves as the shutter button is pressed, their face may not be in the area indicated by the green border when the picture is taken.
- In each shooting mode, the camera will detect and focus on faces but exposure will be optimized for the entire scene rather than the selected portrait subject.

Focus Lock

To compose photographs with off-center subjects:

1 Position the subject in the focus frame.



2 Focus.

Press the shutter button halfway to set focus and exposure. Focus and exposure will remain locked while the shutter button is pressed halfway (AF/AE lock).



*Press
halfway*



Repeat steps 1 and 2 as desired to refocus before taking the picture.

3 Recompose the picture.

Keeping the shutter button pressed halfway, recompose the picture.



4 Shoot.

Press the shutter-release button the rest of the way down to take the picture.



*Press the rest of
the way down*

Autofocus

Although the camera boasts a high-precision autofocus system, it may be unable to focus on the subjects listed below. If the camera is unable to focus using autofocus, use focus lock (pg. 23) to focus on another subject at the same distance and then recompose the photograph.

- Very shiny subjects such as mirrors or car bodies.



- Fast-moving subjects.

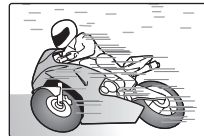

- Subjects photographed through a window or other reflective object.
- Dark subjects and subjects that absorb rather than reflect light, such as hair or fur.
- Insubstantial subjects, such as smoke or flame.
- Subjects that show little contrast with the background (for example, subjects in clothing that is the same color as the background).
- Subjects positioned in front of or behind a high-contrast object that is also in the focus frame (for example, a subject photographed against a backdrop of highly contrasting elements).

Macro mode (Close-ups)

To select macro mode, press the selector left ()

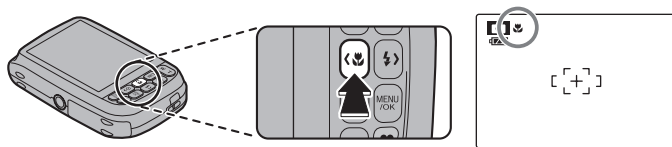

 icon appears in monitor when camera is in macro mode

When macro mode is in effect, the camera focuses on subjects near the center of the monitor. Use the zoom buttons to frame pictures.

To exit macro mode, press the selector left () . Macro mode can also be cancelled by turning the camera off or selecting another shooting mode.

Note

Use of a tripod is recommended to prevent blur caused by camera shake.

⚡ Using the Flash (Intelligent Flash)

To choose a flash mode, press the selector right (⚡). The flash mode changes each time the selector is pressed; in modes other than AUTO, the current mode is indicated by an icon in the monitor. Choose from the following options (some options are not available in all shooting modes; see the restrictions in another supplied document):

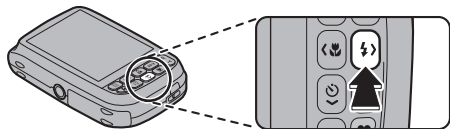

Mode	Description
AUTO (no icon)	The flash fires when required. Recommended in most situations.
⚡ (fill flash)	The flash fires whenever a picture is taken. Use for backlit subjects or for natural coloration when shooting in bright light.
⚡/ (suppressed flash)	The flash does not fire even when the subject is poorly lit. ! will appear in the monitor at slow shutter speeds to warn that pictures may be blurred. Use of a tripod is recommended.
S⚡ (slow sync)	Capture both the main subject and the background when shooting at night (note that brightly lit scenes may be overexposed). If ⚡* is selected for ⊕ SHOOTING MODE , shutter speed may be slow. Use a tripod.

⚠ Caution

The flash may fire several times with each shot. Do not move the camera until shooting is complete.

Red-Eye Removal

When **ON** is selected for Intelligent Face Detection (pg. 21), red-eye removal (👁️) is available in AUTO (👁️), fill flash (👁️⚡), and slow sync (👁️🐢) modes. Red-eye removal minimizes “red-eye” caused when light from the flash is reflected from the subject’s retinas as shown in the illustration at right.



Silent Mode

In situations in which camera sounds or light from the flash may be unwelcome, press the **DISP/BACK** button until 📷 is displayed in the monitor.

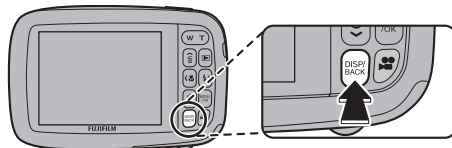

The camera speaker, shooting indicator, flash, and indicator and self-timer lamps turn off. Flash and volume settings (pg. 75) can not be adjusted while silent mode is in effect. To restore normal operation, press the **DISP/BACK** button until the 📷 icon is no longer displayed.

Using the Self-Timer

The camera offers a ten-second timer that allows photographers to appear in their own photographs, and a two-second timer that can be used to avoid blur caused by the camera moving when the shutter button is pressed.

1 Set the timer.

The current self-timer mode is displayed in the monitor. To choose a different setting, press the selector down (). The selection changes each time the selector is pressed.

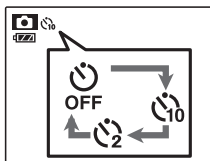
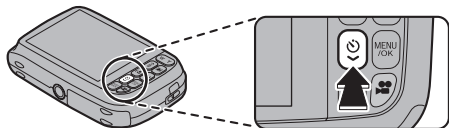

The current self-timer mode is displayed in the monitor.

 : The picture is taken after 10 seconds.

 : The picture is taken after 2 seconds.

2 Focus.

Press the shutter button halfway to focus.



Caution

Stand behind the camera when using the shutter button. Standing in front of the lens can interfere with focus and exposure.

3 Start the timer.

Press the shutter button the rest of the way down to start the timer. The display in the monitor shows the number of seconds remaining until the shutter is released. To stop the timer before the picture is taken, press **DISP/BACK**.

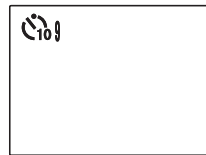

The self-timer lamp on the front of the camera will blink immediately before the picture is taken. If the two-second timer is selected, the self-timer lamp will blink as the timer counts down.

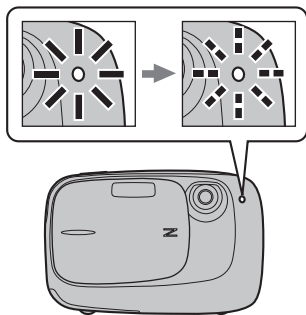

Intelligent Face Detection

Because it ensures that the faces of portrait subjects will be in focus, Intelligent Face Detection (pg. 21) is recommended when using the self-timer for group portraits or self-portraits. To use the self-timer with Intelligent Face Detection, set the timer as described in Step 1 and then press the shutter button all the way down to start the timer. The camera will detect faces while the timer is counting down and adjust focus and exposure immediately before the shutter is released. Be careful not to move until the picture has been recorded.

📷 Shooting Mode

Choose a shooting mode according to the scene or type of subject.

Selecting a Shooting Mode

- 1 Press **MENU/OK** to display the shooting menu.

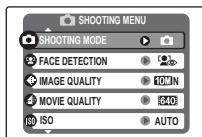

- 2 Press the selector up or down to highlight **SHOOTING MODE**.



- 3 Press the selector right to display shooting mode options.

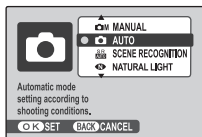

- 4 Press the selector up or down to highlight the desired mode.



- 5 Press **MENU/OK** to select the highlighted option.



← Note

See the restrictions in another supplied document for flash mode setting.

Shooting Modes

📷 MANUAL

Choose this mode for complete control of shooting settings, including exposure compensation (pg. 57), and white balance (pg. 58).

📷 AUTO

Choose for crisp, clear snapshots (pg. 16). This mode is recommended in most situations.

SR
AUTO **SCENE RECOGNITION**

Simply by pointing the camera at the subject, the camera automatically analyzes and selects the most appropriate setting using scene recognition.



The camera analyzes a subject based on scene recognition, then an icon appears in the bottom left of the monitor. (The illustration shows camera analysis of a portrait subject.)

Subject	Icon	Description
PORTRAIT		For soft-toned portraits with natural skin tones.
LANDSCAPE		For crisp, clear daylight shots of buildings and landscapes.
NIGHT		For night and twilight scenes, using a high sensitivity setting to minimize blurring.
MACRO		For clear close-ups of flowers, etc.
BACKLIGHT PORTRAIT		For a subject backlit against the sun, preventing the background from becoming dim.

Subject	Icon	Description
NIGHT PORTRAIT		For a subject in a dim place, reducing blur.

Tip

When a subject can not be analyzed by the camera, **AUTO** mode will be set.

Notes

- Intelligent Face Detection is turned on automatically.
- The camera continuously adjusts focus on a face, or the center area of the monitor.
- Continuous auto focus will be audible and battery drain will increase.

NATURAL LIGHT

Capture natural light indoors, under low light, or where the flash can not be used. The flash turns off and sensitivity is raised to reduce blur.

PORTRAIT

Choose this mode for soft-toned portraits with natural skin tones.

LANDSCAPE

Choose this mode for crisp, clear daylight shots of buildings and landscapes.

SPORT

Choose this mode when photographing moving subjects. Priority is given to faster shutter speeds.

NIGHT

A high sensitivity setting is selected automatically to minimize blurring for recording night and twilight scenes.

NIGHT (TRIPOD)

Slow shutter speeds are used to record night scenes. Use of a tripod is recommended to prevent camera shake.

SUNSET

Choose this mode to record the vivid colors in sunrises and sunsets.

SNOW

Choose for crisp, clear shots that capture the brightness of scenes dominated by shining white snow.

BEACH

Choose for crisp, clear shots that capture the brightness of sunlit beaches.

PARTY

Capture indoor background lighting under low-light conditions.

FLOWER

Choose for vivid close-ups of flowers. The camera focuses in the macro range and the flash turns off automatically.

TEXT

Take clear pictures of text or drawings in print. The camera focuses in the macro range.

ANTI-BLUR (Picture Stabilization)

Choose this mode for fast shutter speeds that reduce blur caused by camera shake or subject movement.

Single-Frame Playback

To view the most recent picture in the monitor, press the  button.

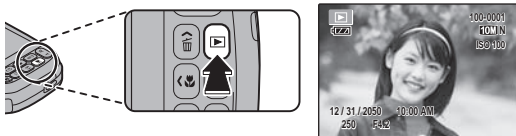

Press the selector right to view pictures in the order recorded, left to view pictures in reverse order. Keep the selector pressed to scroll rapidly to the desired frame.



Choosing a Display Format

Press the **DISP/BACK** button to cycle through playback display formats as shown below.

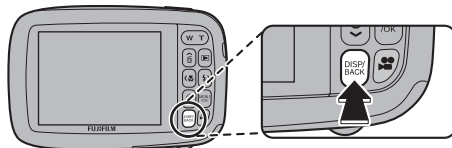

Indicators displayed

Indicators hidden



Sort by date

Note

Pictures taken using other cameras are indicated by a  ("gift image") icon during playback.

Playback Zoom

Press **T** to zoom in on images displayed in single-frame playback; press **W** to zoom out.

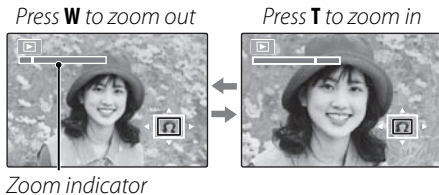

When the picture is zoomed in, the selector can be used to view areas of the image not currently visible in the display.

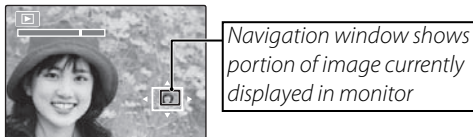



Press **DISP/BACK** to exit zoom.



Note

The maximum zoom ratio varies with image size. Playback zoom is not available with pictures taken at an image size of **Q3M**, or **Blog** blog images.

Intelligent Face Detection

If the current picture was taken using Intelligent Face Detection (pg. 21),  will appear in the monitor. Press the  button to cycle through the subjects detected by Intelligent Face Detection, or use the **W** and **T** buttons to zoom the current subject in and out as described above.



Multi-Frame Playback

To change the number of images displayed, press **W** when a picture is shown full-frame in the monitor.

W T

Use the selector to highlight images and press **MENU/OK** to view the highlighted image full frame. In the nine- and hundred-frame displays, press the selector up or down to view more pictures.



*Press the **W** button to increase the number of pictures displayed to two, nine, or a hundred.*



*Press **T** to reduce the number of images displayed.*

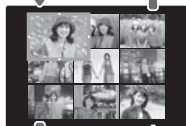

Sort by Date

- 1** In single-frame playback, press **DISP/BACK** until the sort-by-date screen is displayed.



The picture displayed in the single-frame playback remains selected.



- 2** Press the selector up or down to select a date.



- 3** Press the selector left or right to select a picture.



Tips: Rapid Scroll

- Press and hold the selector up or down to scroll dates rapidly.
- Press and hold the selector left or right to rapidly scroll pictures taken on the same date.

Deleting Pictures

The **ERASE** option in the playback menu can be used to delete still pictures and movies, increasing the amount of space available on the memory card or in internal memory (for information on deleting pictures in single-frame playback, see page 20). *Note that deleted pictures can not be recovered. Copy important pictures to a computer or other storage device before proceeding.*

- 1 Press **MENU/OK** to display the playback menu.

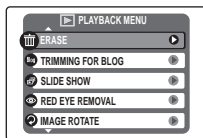

- 2 Press the selector up or down to highlight **ERASE**.

- 3 Press the selector right to display delete options.

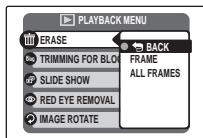

- 4 Press the selector up or down to highlight **FRAME** or **ALL FRAMES**.



- 5 Press **MENU/OK** to display options for the selected item (see pg. 39).



Tips: Deleting Pictures

- When a memory card is inserted, pictures will be deleted from the memory card; otherwise, pictures will be deleted from internal memory.
- Protected pictures can not be deleted. Remove protection from any pictures you wish to delete (pg. 65).
- If a message appears stating that the selected images are part of a DPOF print order, press **MENU/OK** to delete the pictures.

■ FRAME: *Deleting Selected Images*

Selecting **FRAME** displays the dialog shown at right.

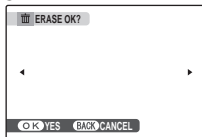

Press the selector left or right to scroll through pictures and press **MENU/OK** to delete the current picture (the picture is deleted immediately; be careful not delete the wrong picture).



Press **DISP/BACK** to exit when all the desired pictures have been deleted.

■ ALL FRAMES: *Deleting All Images*

Selecting **ALL FRAMES** displays the confirmation shown at right.

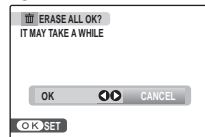

Press **MENU/OK** to delete all unprotected pictures.



The dialog shown at right is displayed during deletion. Press **DISP/BACK** to cancel before all pictures have been deleted (any pictures deleted before the button was pressed can not be recovered).

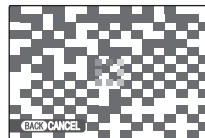

Recording Movies

The  button can be used to shoot short movies in all shooting modes. Sound is recorded via the built-in microphone; do not cover the microphone during recording.

- 1 Frame the scene using the zoom buttons.

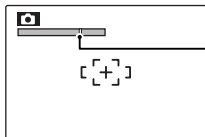

Zoom indicator

Optical zoom can not be adjusted once recording begins. Digital zoom can be used during recording if **ON** is selected for the **DIGITAL ZOOM** option in the setup menu (pg. 75).

Choosing the Frame Size

To choose the frame size, press **MENU/OK** and select **MOVIE QUALITY**.

Choose **640** (640 × 480 pixels) for better quality, **320** (320 × 240 pixels) for longer movies. Press **MENU/OK** to return to movie recording mode.

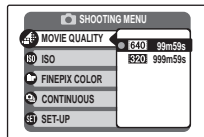

W T

- 2 Press the  button to start recording.

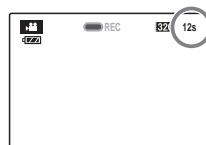

REC
and time remaining are displayed in monitor

- 3 Press the  button again to end recording. Recording ends automatically when the movie reaches maximum length or memory is full.



Notes

- Focus is set when recording begins; exposure and white balance are adjusted automatically throughout recording. The color and brightness of the image may vary from that displayed before recording begins.
- Some operating noise of the camera may be recorded during movie shooting.

▶ Viewing Movies

During playback (pg. 34), movies are displayed in the monitor as shown at right.

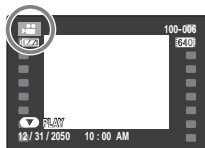

Press the selector down to start playback.

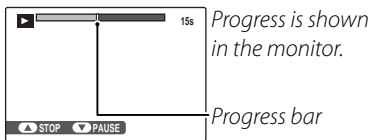

To end playback, press the selector up; to pause playback, press the selector down. Press the selector left or right to view other pictures. Volume can be adjusted in the setup menu (pg. 75).

Tip: Deleting Movies

Press the selector up to end playback. If playback is paused, pressing the selector up will delete the current movie.

Note

Fast forward and rewind are not available.

Cautions

- Do not cover the speaker during playback.
- Vertical or horizontal streaks may appear in movies containing very bright subjects. This is normal and does not indicate a malfunction.

Viewing Pictures on TV

Connect the camera to a TV and tune the television to the video channel to show pictures and slide shows (pg. 63) to a group.

- 1 Connect an A/V cable (optional), as shown below.

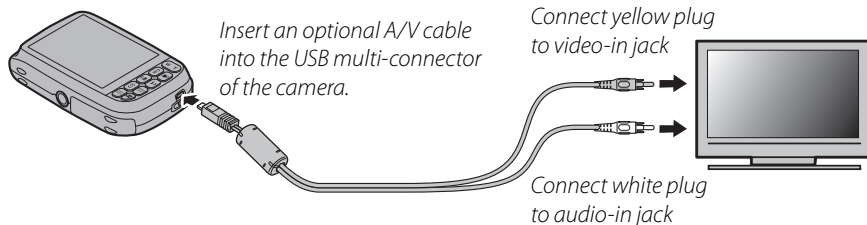

- 2 Tune the television to the video channel.
The camera monitor turns off and pictures, voice memos, and movies are played back on the TV. Note that the camera volume controls have no effect on sounds through the TV; use the television volume controls to adjust the volume.
- 3 Press the  for about a second to turn the camera on.

Note

Image quality deteriorates slightly during movie playback.

Caution

When making the A/V cable connection, be sure the connectors are fully inserted.

Printing Pictures via USB

If the printer supports PictBridge, the camera can be connected directly to a printer and pictures can be printed without first being copied to a computer. Note that depending on the printer, not all the functions described below may be supported.



Connecting the Camera

- 1 Press the  for about a second to turn the camera on.

Note

Be sure the battery is inserted for proper connection.

- 2 Connect the supplied USB cable as shown and turn the printer on.

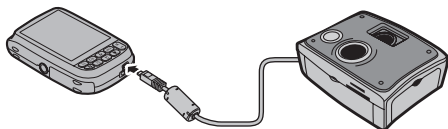

 **USB** will be displayed in the monitor, followed by the PictBridge display shown below at right.

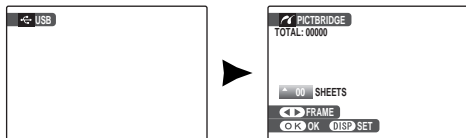

Printing Selected Pictures

- 1 Press the selector left or right to display a picture you wish to print.
- 2 Press the selector up or down to choose the number of copies (up to 99).
- 3 Repeat steps 1–2 to select additional pictures. Press **MENU/OK** to display a confirmation dialog when settings are complete.

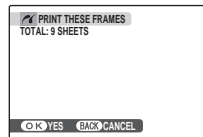

- 4 Press **MENU/OK** to start printing.



Tip: Printing the Date of Recording

To print the date of recording on pictures, press **DISP/BACK** in steps 1–2 to display the PictBridge menu (see “Printing the DPOF Print Order”). Press the selector up or down to highlight **PRINT WITH DATE**  and press **MENU/OK** to return to the PictBridge display (to print pictures without the date of recording, select **PRINT WITHOUT DATE**). The date will not be printed if the camera clock was not set when the picture was taken.

Note

If no pictures are selected when the **MENU/OK** button is pressed, the camera will print one copy of the current picture.

Printing the DPOF Print Order

To print the print order created with  **PRINT ORDER (DPOF)** in the playback menu (pg. 46):

- 1 In the PictBridge display, press **DISP/BACK** to open the PictBridge menu.

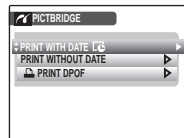

- 2 Press the selector up or down to highlight  **PRINT DPOF**.



- 3 Press **MENU/OK** to display a confirmation dialog.

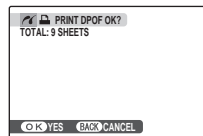

- 4 Press **MENU/OK** to start printing.



●● During Printing

The message shown at right is displayed during printing. Press **DISP/BACK** to cancel before all pictures are printed (depending on the printer, printing may end before the current picture has printed).

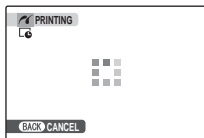

If Printing is interrupted, disconnect the USB cable from the camera, turn off the camera, and then repeat the steps on page 43.

●● Disconnecting the Camera

Confirm that "PRINTING" is not displayed in the monitor and disconnect the USB cable.

← Notes

- Print pictures from internal memory or a memory card that has been formatted in the camera.
- If the printer does not support date printing, the **PRINT WITH DATE**  option will not be available in the PictBridge menu and the date will not be printed on the pictures in the DPOF print order.
- Default printer page size and print quality settings are used when printing via direct USB connection.

Creating a DPOF Print Order

The **PRINT ORDER (DPOF)** option in the playback menu can be used to create a digital “print order” for PictBridge-compatible printers (pg. 43) or devices that support DPOF.

DPOF

DPOF (Digital Print Order Format) is standard that allows pictures to be printed from “print orders” stored in internal memory or on a memory card. The information in the order includes the pictures to be printed and the number of copies of each picture.



WITH DATE / WITHOUT DATE

To modify the DPOF print order, select **PRINT ORDER (DPOF)** in the playback menu and press the multi selector up or down to highlight **WITH DATE ** or **WITHOUT DATE**.

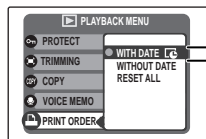

WITH DATE : Print date of recording on pictures.

WITHOUT DATE: Print pictures without date.

Press **MENU/OK** and follow the steps below.

1 Press the selector left or right to display a picture you wish to include in or remove from the print order.



2 Press the selector up or down to choose the number of copies (up to 99). To remove a picture from the order, press the selector down until the number of copies is 0.

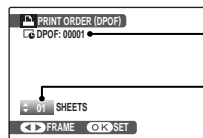

Total number of prints

Number of copies

3 Repeat steps 1–2 to complete the print order. Press **MENU/OK** to save the print order when settings are complete, or **DISP/BACK** to exit without changing the print order.



4 The total number of prints is displayed in the monitor. Press **MENU/OK** to exit.



The pictures in the current print order are indicated by a  icon during playback.

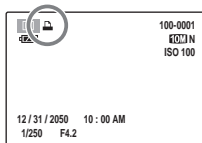

■ RESET ALL

To cancel the current print order, select **RESET ALL** in the  **PRINT ORDER (DPOF)** menu. The confirmation shown at right will be displayed; press **MENU/OK** to remove all pictures from the order.

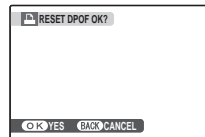

← Notes

- Remove the memory card to create or modify a print order for the pictures in internal memory.
- Print orders can contain a maximum of 999 pictures.
- If a memory card is inserted containing a print order created by another camera, the message shown at right will be displayed. Pressing **MENU/OK** cancels the print order; a new print order must be created as described above.

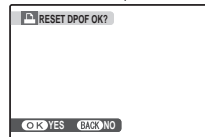

Viewing Pictures on a Computer

The supplied FinePixViewer software can be used to copy pictures to a computer, where they can be stored, viewed, organized, and printed. Before proceeding, install FinePixViewer as described below. The latest FinePixViewer is available at <http://www.fujifilm.com/>. **Do NOT connect the camera to the computer until installation is complete.**

Installing FinePixViewer

FinePixViewer is available in a Windows version and a Macintosh version. Installation instructions for Windows are on pages 48–50, those for the Macintosh on pages 51–52.

Installing FinePixViewer: Windows

1 Confirm that the computer meets the following system requirements:

OS	Preinstalled versions of Windows Vista, Windows XP Home Edition (Service Pack 2), Windows XP Professional (Service Pack 2), or Windows 2000 Professional (Service Pack 4)*
CPU	<ul style="list-style-type: none">• Windows Vista: 800 MHz Pentium 4 or better (3 GHz Pentium 4 or better recommended)• Windows XP: 800 MHz Pentium 4 or better (2 GHz Pentium 4 or better recommended)• Windows 2000: 200 MHz Pentium or better
RAM	<ul style="list-style-type: none">• Windows Vista: 512 MB or more (1 GB or more recommended)• Windows XP: 512 MB or more• Windows 2000: 128 MB or more
Free disk space	A minimum of 450 MB required for installation with 600 MB available when FinePixViewer is running (15 GB or more recommended under Windows Vista, 2 GB or more recommended under Windows XP)
Video	800 × 600 pixels or more with 16-bit color or better (1,024 × 768 pixels or more with 32-bit color recommended)
Other	<ul style="list-style-type: none">• Built-in USB port recommended. Operation is not guaranteed other USB ports.• Internet connection (56 kbps or faster recommended) required to use FinePix Internet Service; Internet connection and e-mail software required to use e-mail option

* To check if FinePixViewer is Windows® 7-compliant, please visit <http://www.fujifilm.com/support/download/camera/software/>.

 **Caution**

Other versions of Windows are not supported. Operation is not guaranteed on home-built computers or computers that have been upgraded from earlier versions of Windows.

- 2 Start the computer. Log in to an account with administrator privileges before proceeding.
- 3 Exit any applications that may be running and insert the installer CD in a CD-ROM drive.

 **Windows Vista**

If an AutoPlay dialog is displayed, click **SETUP.exe**. A "User Account Control" dialog will then be displayed; click **Allow**.

The installer will start automatically; click **Installing FinePixViewer** and follow the on-screen instructions to install FinePixViewer. Note that the Windows CD may be required during installation.

 **If the Installer Does Not Start Automatically**

If the installer does not start automatically, select **Computer** or **My Computer** from the Start menu (Windows Vista/XP) or double-click the **My Computer** icon on the desktop (Windows 2000), then double-click the **FINEPIX** CD icon to open the FINEPIX CD window and double-click **SETUP** or **SETUP.exe**.

- 4** If prompted to install Windows Media Player or DirectX, follow the on-screen instructions to complete installation.
- 5** When prompted, remove the installer CD from the CD-ROM drive and click **Restart** to restart the computer. Store the installer CD in a dry location out of direct sunlight in case you need to re-install the software. The version number is printed at the top of the CD label for reference when updating the software or contacting customer support.

Installation is now complete. Proceed to “Connecting the Camera” on page 53.

Installing FinePixViewer: Macintosh

1 Confirm that the computer meets the following system requirements:

CPU	PowerPC or Intel
OS	Preinstalled version of Mac OS X version 10.3.9–10.5 (visit http://www.fujifilm.com/ for more information)
RAM	256 MB or more
Free disk space	A minimum of 200 MB required for installation with 400 MB available when FinePixViewer is running
Video	800×600 pixels or more with thousands of colors or better
Other	<ul style="list-style-type: none"> • Built-in USB port recommended. Operation is not guaranteed other USB ports. • Internet connection (56 kbps or faster recommended) required to use FinePix Internet Service; Internet connection and e-mail software required to use e-mail option

2 After starting the computer and quitting any applications that may be running, insert the installer CD in a CD-ROM drive. Double-click the **FinePix CD** icon on the desktop and double-click **Installer for Mac OS X**.

3 An installer dialog will be displayed; click **Installing FinePixViewer** to start installation. Enter an administrator name and password when prompted and click **OK**, then follow the on-screen instructions to install FinePixViewer. Click **Exit** to quit the installer when installation is complete.

- 4** Remove the installer CD from the CD-ROM drive. Note that you may be unable to remove the CD if Safari is running; if necessary, quit Safari before removing the CD. Store the installer CD in a dry location out of direct sunlight in case you need to re-install the software. The version number is printed at the top of the CD label for reference when updating the software or contacting customer support.
- 5** Select **Applications** in the Finder **Go** menu to open the applications folder. Double-click the **Image Capture** icon and select **Preferences...** from the Image Capture application menu.



The Image Capture preferences dialog will be displayed. Choose **Other...** in the **When a camera is connected, open** menu, then select **FPVBridge** in the “Applications/FinePixViewer” folder and click **Open**.



Select **Quit Image Capture** from the Image Capture application menu.

Installation is now complete. Proceed to “Connecting the Camera” on page 53.

Connecting the Camera

- 1 If the pictures you wish to copy are stored on a memory card, insert the card into the camera (pg. 9). If no card is inserted, pictures will be copied from internal memory.

⚠ Caution

Loss of power during transfer could result in loss of data or damage to internal memory or the memory card. Check the battery level.

- 2 Press the **▶** for about a second to turn the camera on.

← Note

Be sure the battery is inserted for proper connection.

- 3 Connect the supplied USB cable as shown, making sure the connectors are fully inserted. Connect the camera directly to the computer; do not use a USB hub or keyboard.

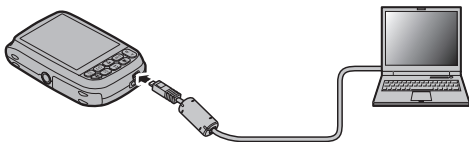

- 4 Transferring starts. FinePixViewer will start automatically and the “Save Image Wizard” will be displayed. Follow the on-screen instructions to copy pictures to the computer. To exit without copying pictures, click **CANCEL**.

⚠ Caution

If FinePixViewer does not start automatically, the software may not be correctly installed. Disconnect the camera and reinstall the software.

For more information on using FinePixViewer, select **How to Use FinePixViewer** in the FinePixViewer **Help** menu.

 **Cautions**

- Use only memory cards that have been formatted in the camera and contain pictures taken with the camera. If a memory card containing a large number of images is inserted, there may be a delay before FinePixViewer starts and FinePixViewer may be unable to import or save images. Use a memory card reader to transfer pictures.
- Opening or closing the lens cover during transfer could result in loss of data or damage to internal memory or the memory card.
- Disconnect the camera before inserting or removing memory cards.
- In some cases, it may not be possible to access pictures saved to a network server using FinePixViewer in the same way as on a standalone computer.
- The user bears all applicable fees charged by the phone company or Internet service provider when using services that require an Internet connection.

 **Disconnecting the Camera**

After confirming that transferring has finished, follow the on-screen instructions to disconnect the camera and the computer. Turn off the camera.

 **Uninstalling FinePixViewer**

Only uninstall FinePixViewer before reinstalling the software or when it is no longer required. After quitting FinePixViewer and disconnecting the camera, drag the “FinePixViewer” folder from “Applications” into the Trash and select **Empty Trash** in the **Finder** menu (Macintosh), or open the control panel and use “Programs and Features” (Windows Vista) or “Add/Remove Programs” (other versions of Windows) to uninstall FinePixViewer. Under Windows, one or more confirmation dialogs may be displayed; read the contents carefully before clicking **OK**.

The Shooting Menu

The shooting menu is used to adjust settings for a wide range of shooting conditions.

Using the Shooting Menu

- 1 Press **MENU/OK** to display the shooting menu.

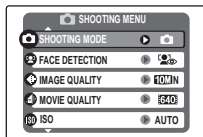

← Note

The options displayed in the shooting menu vary depending on the shooting mode.

- 2 Press the selector up or down to highlight the desired menu item.



- 3 Press the selector right to display options for the highlighted item.

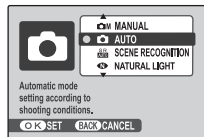

- 4 Press the selector up or down to highlight the desired option.

- 5 Press **MENU/OK** to select the highlighted option.



Shooting Menu Options

Menu item	Description	Options	Default
SHOOTING MODE	Choose a shooting mode according to the type of subject (pg. 30).		
FACE DETECTION	Turn Intelligent Face Detection and red-eye removal on or off (pg. 21).	ON ON / ON OFF / OFF	ON ON
EXP. COMPENSATION	Adjust exposure for bright, dark, or high-contrast scenes (pg. 57).	-2 EV to +2 EV in increments of 1/3 EV	± 0
WHITE BALANCE	Adjust color for different light sources (pg. 58).	AUTO /	AUTO
IMAGE QUALITY	Choose image size and quality (pg. 58).	10M F / 10M N / 9M 3:2 / 5M / 3M / 2M / 03M	10M N
MOVIE QUALITY	Choose the frame size for movies (pg. 40).	640 / 320	640
ISO	Adjust ISO sensitivity (pg. 59). Choose higher values when the subject is poorly lit.	AUTO / 1600 / 800 / 400 / 200 / 100	AUTO
FINEPIX COLOR	Shoot pictures in color or in black-and-white (pg. 59).	STD /	STD
CONTINUOUS	Shoot a series of pictures (pg. 60).	/ OFF	OFF
SET-UP	Perform basic camera setup such as choosing a language and setting the time and date (pg. 71).	1 / 2 / 3	—

EXP. COMPENSATION

Use exposure compensation when photographing very bright, very dark, or high-contrast subjects.

Choose positive (+) values
to increase exposure



Choose negative (-) values
to reduce exposure

Choosing an Exposure Compensation Value

- **Backlit subjects:** choose values from $+\frac{2}{3}$ EV to $+1\frac{2}{3}$ EV (for an explanation of the term “EV”, see the Glossary on page 91)



- **Highly reflective subjects or very bright scenes** (e.g., snowfields): $+1$ EV









- **Scenes that are mostly sky:** $+1$ EV
- **Spotlit subjects** (particularly if photographed against dark backgrounds): $-\frac{2}{3}$ EV
- **Subjects with low reflectivity** (pine trees or dark-colored foliage): $-\frac{2}{3}$ EV

Note

At settings other than ± 0 , a  icon is displayed in the monitor. Exposure compensation is not reset when the camera is turned off; to restore normal exposure control, choose a value of ± 0 .

WB WHITE BALANCE

For natural colors, choose a setting that matches the light source (for an explanation of “white balance”, see the Glossary on page 91).

Option	Displayed in
AUTO	White balance adjusted automatically.
	For subjects in direct sunlight.
	For subjects in the shade.
	Use under “daylight” fluorescent lights.
	Use under “warm white” fluorescent lights.
	Use under “cool white” fluorescent lights.
	Use under incandescent lighting.

If **AUTO** does not produce the desired results (for example, when taking close-ups), choose the option that matches the light source.

Note

Results vary with shooting conditions. Play pictures back after shooting to check colors in the monitor.

Q IMAGE QUALITY

Choose the size and quality at which still pictures are recorded. Large pictures can be printed at large sizes with no drop in quality; small pictures require less memory, allowing more pictures to be recorded.

Option	Prints at sizes up to
10M F	31 × 23 cm/12 × 9 in. (10M) or 31 × 21 cm/12 × 8 in. (9M 3:2). Choose 10M F for high-quality prints, 9M 3:2 for an aspect ratio of 3:2.
10M N	
9M 3:2	
5M	22 × 16 cm (8.5 × 6.5 in.)
3M	17 × 13 cm (7 × 5 in.)
2M	14 × 10 cm (5.3 × 4 in.)
03M	5 × 4 cm (2 × 1.5 in.). Suited to e-mail or the web.

The number of pictures that can be taken at current settings (pg. 92) is displayed to the right of the image quality icon in the monitor.

Note

Image quality is not reset when the camera is turned off or another shooting mode is selected.

Aspect Ratio

Pictures taken at an image quality setting of **9M 3:2** have an aspect ratio of 3:2, the same as a frame of 35-mm film. Pictures taken at other settings have an aspect ratio of 4:3.



4:3



3:2

ISO ISO

Control the camera's sensitivity to light with . Higher values can be used to reduce blur when lighting is poor; note, however, that mottling may appear in pictures taken at high sensitivities. If **AUTO** is selected, the camera will adjust sensitivity automatically in response to shooting conditions.

Settings other than **AUTO** are shown by an icon in the monitor if you use .

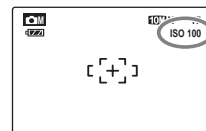

FINEPIX COLOR

Shoot pictures in color or in black-and-white.

Option	Displayed in
F-STANDARD	Standard contrast and saturation. Recommended in most situations.
F-B&W	Take pictures in black and white.

Setting of **F-B&W** is shown by an icon in the monitor.

Note

FINEPIX COLOR is not reset when the camera is turned off or another shooting mode is selected.

CONTINUOUS (Continuous shooting)

Select  **TOP 3** to capture motion in a series of pictures. The camera takes up to three pictures while the shutter-release button is pressed.

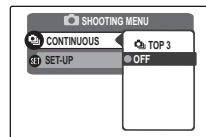

Notes

- Frame rate varies with shutter speed.
- Focus and exposure are determined by the first frame in each series.
- The number of pictures that can be recorded depends on the memory available. Additional time may be required to record pictures when shooting ends. The pictures are displayed in the monitor while recording is in progress.



The Playback Menu

The playback menu is used to manage the pictures in internal memory or on the memory card.

Using the Playback Menu

1 Press  to enter playback mode (pg. 34).



2 Press **MENU/OK** to display the playback menu.

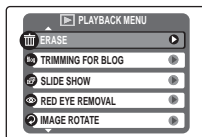

3 Press the selector up or down to highlight the desired menu item.



4 Press the selector right to display options for the highlighted item.

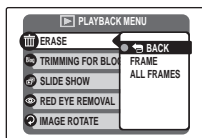

5 Press the selector up or down to highlight the desired option.













6 Press **MENU/OK** to select the highlighted option.



Playback Menu Options

The following options are available:

Option	Description
 ERASE	Delete all or selected pictures (pg. 38).
 TRIMMING FOR BLOG	Process still images for posting to a blog (pg. 62).
 SLIDE SHOW	View pictures in a slide show (pg. 63).
 RED-EYE REMOVAL	Create copies with reduced red eye (pg. 63).
 IMAGE ROTATE	Rotate pictures (pg. 64).
 PROTECT	Protect pictures from accidental deletion (pg. 65).
 TRIMMING	Create cropped copies of pictures (pg. 66).
 COPY	Copy pictures between internal memory and a memory card (pg. 67).
 VOICE MEMO	Add voice memos to pictures (pg. 69).
 PRINT ORDER (DPOF)	Select pictures for printing on DPOF- and PictBridge-compatible devices (pg. 44).
 SET-UP	Perform basic camera setup (pg. 71).

TRIMMING FOR BLOG

You can process still images for posting to a blog.

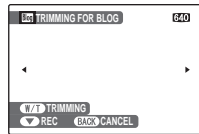

1 Select the frame (file) to process.



2 Press the selector down to process the image.
The original image remains unaltered.



Notes

- Press the **W** and **T** buttons to zoom the picture in or out and use the selector to display the portion of the picture you wish to save before processing it. Press **MENU/OK** to crop the picture and return to the image selection display.
- Blog image size is adjustable in the setup menu.
- Small copies are saved using filenames that begin with "BLOG". During playback, small copies are indicated by a  icon and a black border. Small copies can not be further cropped or rotated.

SLIDE SHOW

View pictures in an automated slide show. After choosing the background music, choose the type of show and press **MENU/OK** to start. Press **DISP/BACK** at any time during the show to view on-screen help. When a movie is displayed, movie playback will begin automatically, and the slide show will continue when the movie ends. The show can be ended at any time by pressing **MENU/OK**.

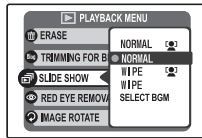

Option	Displayed in
NORMAL	Press selector left or right to go back or skip ahead one frame. Select WIPE for wipe transitions between frames.
WIPE	
NORMAL [👤]	As above, except that camera automatically zooms in on faces selected with Intelligent Face detection.
WIPE [👤]	
SELECT BGM	Choose background music.

RED EYE REMOVAL

This option is used with pictures taken using Intelligent Face Detection to create copies that have been processed to remove red eye.

- 1 Play the picture back in the monitor (pictures taken with Intelligent Face Detection are indicated by a [👤] icon) and select **RED EYE REMOVAL** in the playback menu (pg. 61).



- 2 Press **MENU/OK**. The message shown below at left will be displayed while the camera analyses the image; if red-eye is detected, the message shown below at right will be displayed while the camera processes the image to create a copy with reduced red-eye.



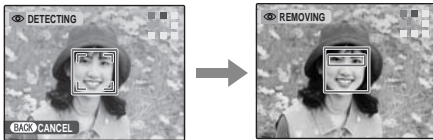

← Notes

- Red eye may not be removed if the camera is unable to detect a face or the face is in profile. Results may differ depending on the scene. Red eye can not be removed from pictures that have already been processed using red-eye removal or pictures created with other devices.
- The amount of time needed to process the image varies with the number of faces detected.
- Copies created with **REDA EYE REMOVAL** are indicated by a  icon during playback.

🔍 IMAGE ROTATE

By default, pictures taken in tall orientation are displayed in wide orientation. Use this option to display pictures in the correct orientation in the monitor. It has no effect on pictures displayed on a computer or other device.

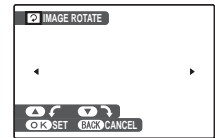

← Notes

- Protected pictures can not be rotated. Remove protection before rotating pictures (pg. 65).
- The camera may not be able to rotate pictures created with other devices.

- 1 Press the selector left or right to display the desired picture in the monitor.



- 2 Press the selector down to rotate the picture 90° clockwise, up to rotate the picture 90° counterclockwise.



- 3 Press **MENU/OK** to confirm the operation (to exit without rotating the picture, press **DISP/BACK**).

The next time the picture is played back, it will automatically be rotated.

PROTECT

Protect pictures from accidental deletion. The following options are available.

■ FRAME

Protect selected pictures.

- 1 Press the selector left or right to display the desired picture.

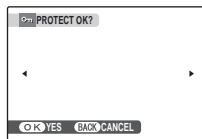

Picture not protected

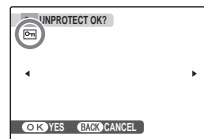

Protected picture

- 2 Press **MENU/OK** to protect the picture. If the picture is already protected, pressing **MENU/OK** will remove protection from the image.

- 3 Repeat steps 1–2 to protect additional images. Press **DISP/BACK** to exit when the operation is complete.

■ SET ALL

Press **MENU/OK** to protect all pictures, or press **DISP/BACK** to exit without changing picture status.

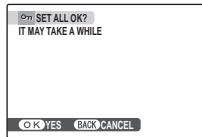

■ RESET ALL

Press **MENU/OK** to remove protection from all pictures, or press **DISP/BACK** to exit without changing picture status.

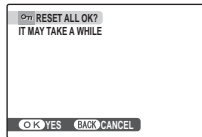

If the number of pictures affected is very large, the display at right will appear in the monitor while the operation is in progress. Press **DISP/BACK** to exit before the operation is complete.



⚠ Caution

Protected pictures will be deleted when the memory card or internal memory is formatted (pg. 76).

⊙ TRIMMING

To create a cropped copy of a picture, play the picture back and select **⊙ TRIMMING** in the playback menu (pg. 61).

- 1 Press the zoom buttons to zoom in and out and use the selector to scroll the picture until the desired portion is displayed (to exit to single-frame playback without creating a cropped copy, press **DISP/BACK**).

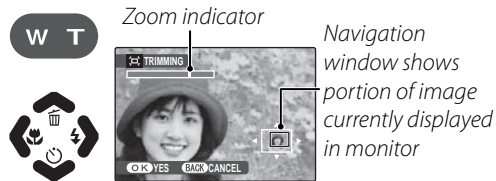

📄 Tip: Intelligent Face Detection

If the picture was shot with Intelligent Face Detection (pg. 21), 🗿 will be displayed in the monitor. Press the **▼** button to zoom in on the selected face.



- 2** Press **MENU/OK**. A confirmation dialog will be displayed.



Copy size (**5M**, **3M**, **2M**, or **03M**; see page 58) is shown at the top; if the size is **03M**, **OK** is displayed in yellow.

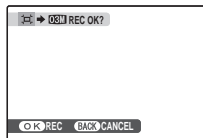

Larger crops produce larger copies; all copies have an aspect ratio of 4:3.

- 3** Press **MENU/OK** to save the cropped copy to a separate file.



← Note

Pictures taken with other cameras can not be cropped.

COPY

Copy pictures between internal memory and a memory card.

- 1** Press the selector up or down to highlight **INTERNAL MEMORY** → **SD CARD** (copy pictures from internal memory to the memory card) or **SD CARD** → **INTERNAL MEMORY** (copy pictures from a memory card to internal memory).



- 2** Press the selector right to display options for the highlighted item.

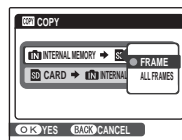

- 3** Press the selector up or down to highlight **FRAME** or **ALL FRAMES**.
- 4** Press **MENU/OK**.



■ FRAME

Copy selected frames.

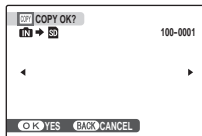

1 Press the selector left or right to display the desired picture.



2 Press **MENU/OK** to copy the picture.



3 Repeat steps 1–2 to copy additional images. Press **DISP/BACK** to exit when the operation is complete.



■ ALL FRAMES

Press **MENU/OK** to copy all pictures, or press **DISP/BACK** to exit without copying pictures.

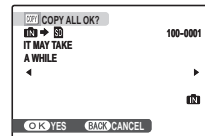

⚠ Cautions

- Copying ends when the destination is full.
- DPOF print information is not copied (pg. 44).

VOICE MEMO

To add a voice memo to a still picture, select

VOICE MEMO after displaying the picture in playback mode.

Note

Voice memos can not be added to movies or protected pictures. Remove protection from pictures before recording voice memos (pg. 65).

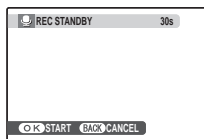
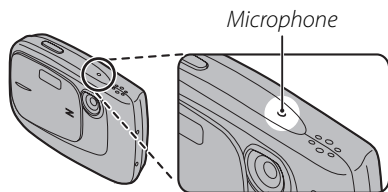

- 1 Press **MENU/OK** to start recording. Hold the camera at a distance of about 20 cm (8 in.) and face the microphone.

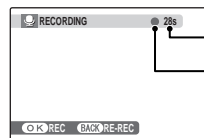

Time remaining

Blinks red

- 2 Press **MENU/OK** again to end recording. Recording ends automatically after 30 seconds.

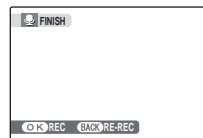

Notes

- If a voice memo already exists for the current picture, the options at right will be displayed. Select **RE-REC** to replace the existing memo.
- Voice memos are recorded as PCM-format WAV files (pg. 91) with a maximum size of about 480 KB.

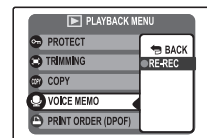

Playing Voice Memos

Voice memo playback starts automatically when a picture with a voice memo is displayed (pg. 34; pictures with voice memos are indicated by a  icon).

Playback repeats until another picture is displayed. To pause, press the selector down; to end playback, press the selector up. Press the selector left or right to view other pictures. Volume can be adjusted in the setup menu (pg. 75).

Note

The camera may not play voice memos recorded with other devices.

Caution

Do not cover the speaker during playback.

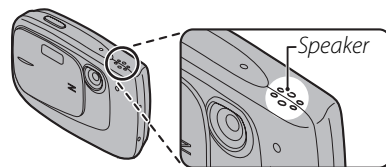
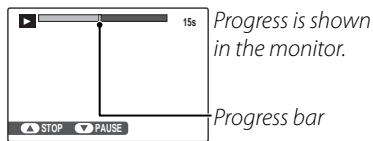

The Setup Menu

Using the Setup Menu

1 Display the setup menu.

1.1 Press **MENU/OK** to display the menu for the current mode.



1.2 Press the selector up or down to highlight **SET SET-UP**.



1.3 Press the selector right to display the setup menu.

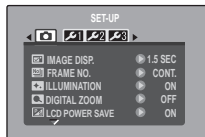

2 Choose a page.

2.1 Press the selector left or right to choose a page.



2.2 Press the selector down to enter the menu.



3 Adjust settings.

3.1 Press the selector up or down to highlight a menu item.



3.2 Press the selector right to display options for the highlighted item.

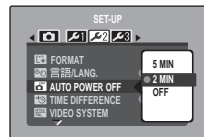



















3.3 Press the selector up or down to highlight an option.



3.4 Press **MENU/OK** to select the highlighted option.



Setup Menu Options

	Menu item	Description	Options	Default
⊕	 IMAGE DISP.	Choose how long pictures are displayed after shooting (pg. 73).	3 SEC / 1.5 SEC / ZOOM (CONTINUOUS)	1.5 SEC
	 FRAME NO.	Choose how files are named (pg. 74).	CONT. / RENEW	CONT.
	 ILLUMINATION	Turn the shooting indicator on or off (pg. 74).	ON / OFF	ON
	 DIGITAL ZOOM	Enable or disable digital zoom (pg. 75).	ON / OFF	OFF
1	 LCD POWER SAVE	Enable or disable monitor power saving (pg. 75)	ON / OFF	ON
	 DATE/TIME	Set the camera clock (pg. 14).	—	—
	 VOLUME	Adjust volume for the shutter, controls, and playback (pg. 75).	—	—
	 SOUND	Choose shutter, start-up, and control sounds (pg. 76).	—	—
⚙️	 BLOG IMAGE SIZE	Choose blog image size (pg. 62).	640 STANDARD / 320 SMALL	640
	 LCD BRIGHTNESS	Control the brightness of the monitor (pg. 76).	-5 - +5	0
2	 FORMAT	Format internal memory or memory cards (pg. 76).	—	—
	 言語/LANG.	Choose a language (pg. 14).	See page 94	ENGLISH
	 AUTO POWER OFF	Choose the auto power off delay (pg. 76).	5 MIN / 2 MIN / OFF	2 MIN
	 TIME DIFFERENCE	Set the clock to local time (pg. 77).	 / 	
3	 VIDEO SYSTEM	Choose a video mode for connection to a TV (pg. 42).	NTSC / PAL	—
	 RESET	Reset all settings except Frame number , DATE/TIME , TIME DIFFERENCE , and VIDEO SYSTEM to default values. A confirmation dialog will be displayed, press the selector left or right to highlight OK and press MENU/OK .	—	—

☑ IMAGE DISP.

Choose how long pictures are displayed in the monitor after shooting.

- **3 SEC:** Pictures are displayed for about 3 s before being recorded.
- **1.5 SEC:** Pictures are displayed for about 1.5 s before being recorded.
- **ZOOM (CONTINUOUS):** Pictures are displayed until the **MENU/OK** button is pressed. Pictures taken at qualities larger than **03M** can be zoomed in to check fine details (see page 35). Note that this option is disabled in continuous mode (pg. 60). If Intelligent Face Detection is on (pg. 21), the camera will automatically zoom in on the face used to set focus and exposure; press the selector down to cycle through the other faces detected.

👉 Note

The colors displayed at settings of **3 SEC** and **1.5 SEC** may differ from those in the final picture.

☐ FRAME NO.

New pictures are stored in image files named using a four-digit file number assigned by adding one to the last file number used. The file number is displayed during playback as shown at right. **FRAME NO.** controls whether file numbering is reset to 0001 when a new memory card is inserted or the current memory card or internal memory is formatted.

- **CONT.:** Numbering continues from the last file number used or the first available file number, whichever is higher. Choose this option to reduce the number of pictures with duplicate file names.
- **RENEW:** Numbering is reset to 0001 after formatting or when a new memory card is inserted.

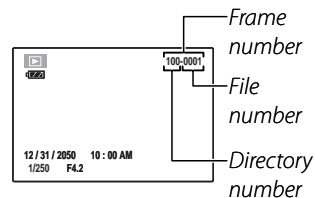
**☛ Notes**

- If the frame number reaches 999-9999, the shutter release will be disabled (pg. 88).
- Selecting **☒ RESET** (pg. 72) does not reset frame numbering.
- Frame numbers for pictures taken with other cameras may differ.

☒ ILLUMINATION

If **ON** is selected, the shooting indicator will light when the camera is turned on. It will also light after a picture is taken to let the subjects know that shooting is complete.

DIGITAL ZOOM

If **ON** is selected, pressing **T** at the maximum optical zoom position will trigger digital zoom, further magnifying the image. To cancel digital zoom, zoom out to the minimum digital zoom position and press **W**.

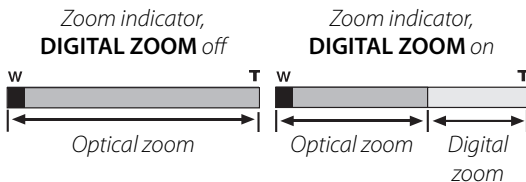
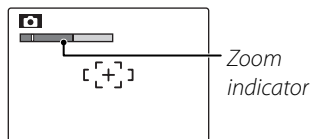

Caution

Digital zoom produces lower quality images than optical zoom.

LCD POWER SAVE

If **ON** is selected, the monitor will dim to save power if no operations are performed for several seconds. Full brightness can be restored by pressing the shutter button halfway. The monitor does not dim in movie mode or during playback.

VOLUME

Choose the volume for the shutter, camera controls, and playback.

- **SHUTTER VOLUME/OPERATION VOL.:** Choose the volume for the shutter and camera controls, or select **OFF** to turn the sound off. Press the selector left or right to highlight an option and press **MENU/OK** to select.
- **PLAYBACK VOLUME:** Press the selector right to display the menu shown at right. Press the selector up or down to choose the volume for movie and voice memo playback and press **MENU/OK** to select.

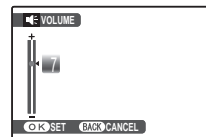

SOUND

Choose the sounds used for the shutter, at start up, and for camera controls. Press the selector up or down to highlight an option and press left or right to select a sound. Press **MENU/OK** to select.

LCD BRIGHTNESS

Press the selector up or down to choose monitor brightness and press **MENU/OK** to select.

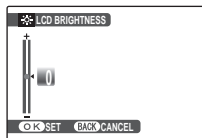
**FORMAT**

Format internal memory or a memory card. If a memory card is inserted in the camera, **SD** will be displayed and this option will format the memory card. If no memory card is inserted, **INT** will be displayed and this option will format internal memory. Press the selector left to highlight **OK** and press **MENU/OK** to begin formatting.

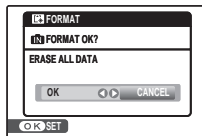
**Cautions**

- All data—including protected pictures—will be deleted. Be sure important files have been copied to a computer or other storage device.
- Do not open the battery cover during formatting.

AUTO POWER OFF

Choose the length of time before the camera turns off automatically when no operations are performed. Shorter times increase battery life; if **OFF** is selected, the camera must be turned off manually. Note that regardless of the option selected, the camera will not turn off automatically when connected to a printer (pg. 43) or computer (pg. 48), while recording or viewing a movie or when a slide show is in progress (pg. 63).

Tip: Reactivating the Camera

For shooting, close the lens cover, and then open it fully. For playback, press the **▶** button for a second.

TIME DIFFERENCE

When travelling, use this option to switch the camera clock instantly from your home time zone to the local time at your destination.

1 Specify the difference between local time and your home time zone.

1.1 Press the selector up or down to highlight  LOCAL.



1.2 Press the selector right to display the time difference.

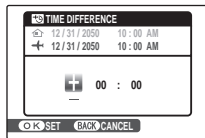

1.3 Press the selector left or right to highlight +, -, hours, or minutes; press up or down to edit. The minimum increment is 15 minutes.



1.4 Press **MENU/OK** when settings are complete.



2 Switch between local time and your home time zone.

To set the camera clock to local time, highlight  LOCAL and press **MENU/OK**.

To set the clock to the time in your home time zone, select  HOME. If  LOCAL is selected,  will be displayed in the monitor for three seconds after the camera enters shooting mode, and the date will be displayed in yellow.

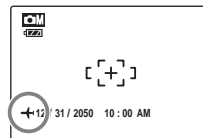

After changing time zones, check that the date and time are correct.

Optional Accessories

The camera supports a wide range of accessories from FUJIFILM and other manufacturers.

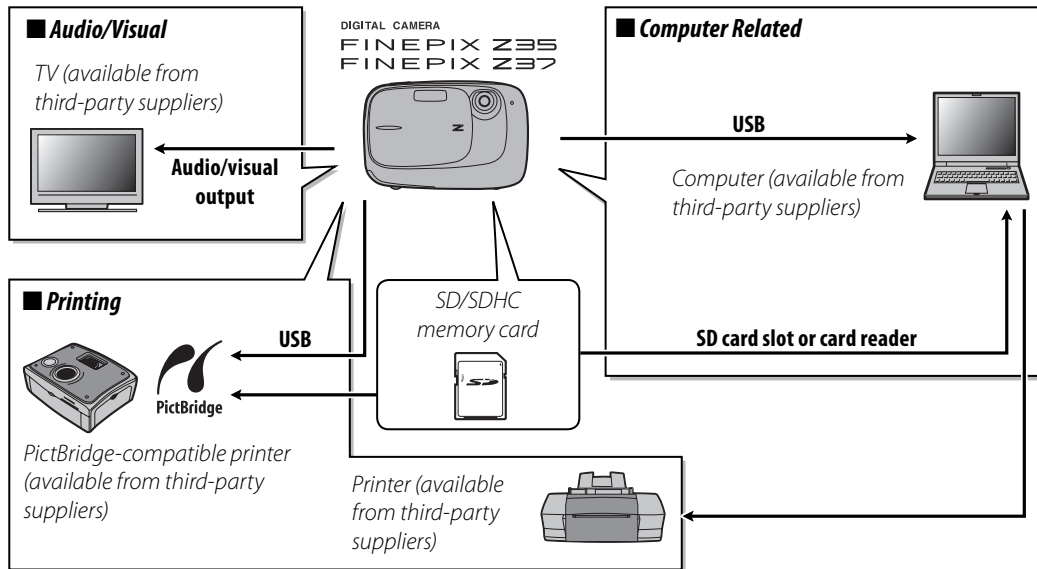

Accessories from Fujifilm

The following optional accessories are available from FUJIFILM. For the latest information on the accessories available in your region, check with your local FUJIFILM representative or visit http://www.fujifilm.com/products/digital_cameras/index.html.

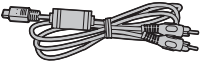
Rechargeable Li-ion battery	NP-45 (supplied)	Additional NP-45 slimline batteries can be purchased as required.	
A/V cable	AV-C1	Connects the camera and a TV.	

Troubleshooting

Power and Battery



	Problem	Possible cause	Solution	Page
Power supply	The camera does not turn on.	The battery is exhausted.	Charge the battery or insert a fully-charged spare battery.	4, 6
		The battery is not in the correct orientation.	Re-insert the battery in the correct orientation.	4
	The battery runs down quickly.	The battery is cold.	Warm the battery by placing it in a pocket or other warm place and re-insert it in the camera immediately before taking a picture.	4
		There is dirt on the battery terminals.	Clean the terminals with a soft, dry cloth.	—
		The camera is in  mode.	Choose a different shooting mode.	30
	The camera turns off suddenly.	The battery has been charged many times.	The battery has reached the end of its charging life. Purchase a new battery.	—
		The battery is exhausted.	Charge the battery or insert a fully-charged spare battery.	4, 6
Battery charger	Charging does not start.	The battery is not correctly inserted.	Re-insert the battery in the camera.	4
		The battery is not in the correct orientation.	Re-insert the battery in the correct orientation.	4
		There is dirt on the battery terminals.	Clean the terminals with a soft, dry cloth.	—
		The battery has been charged many times.	The battery has reached the end of its charging life. Purchase a new battery. If the battery still fails to charge, contact your FUJIFILM dealer.	—
		The camera is on.	Close the lens cover to turn off the camera.	13
	Charging is slow.	The temperature is low.	Charge the battery at room temperature.	7

Menus and Displays

Problem	Possible cause	Solution	Page
Menus and displays are not in English.	English is not selected for the 言語/LANG. option in the setup menu.	Select ENGLISH .	14

Shooting

Problem	Possible cause	Solution	Page
Taking pictures	Memory is full.	Insert a new memory card or delete pictures.	8, 38
	Memory is not formatted.	Format the memory card or internal memory.	76
	There is dirt on the memory card contacts.	Clean the contacts with a soft, dry cloth.	—
	The memory card is damaged.	Insert a new memory card.	8
	The battery is exhausted.	Charge the battery or insert a fully-charged spare battery.	4, 6
	The camera has turned off automatically.	Turn the camera on.	13, 76
The monitor goes dark after shooting.	The flash has fired.	The monitor may darken while the flash charges. Wait for the flash to charge.	26
Focus	The subject is close to the camera.	Select macro mode.	25
	The subject is far away from the camera.	Cancel macro mode.	
	The subject is not suited to autofocus.	Use focus lock.	23
Close-ups	Macro mode is not available.	The camera is in a shooting mode which makes macro (close-up) mode unavailable.	30



Problem		Possible cause	Solution	Page
Intelligent Face Detection	Face detection not available.	The camera is in a shooting mode which makes Intelligent Face Detection unavailable.	Choose a different shooting mode.	30
	No face is detected.	The subject's face is obscured sunglasses, a hat, long hair, or other objects.	Remove the obstructions.	21
		The subject's face occupies only a small area of the frame.	Change the composition so that the subject's face occupies a larger area of the frame.	
		The subject's head is tilted or horizontal.	Ask the subject to hold their head straight.	
		The camera is tilted.	Hold the camera straight.	17
	The subject's face is poorly lit.	Shoot in bright light.	—	
Wrong subject selected.	The selected subject is closer to the center of the frame than the main subject.	Recompose the picture or turn face detection off and frame the picture using focus lock.	21, 23	
Flash	The flash does not fire.	The camera is in a shooting mode in which the flash does not fire.	Choose a different shooting mode.	30
		The battery is exhausted.	Charge the battery or insert a fully-charged spare battery.	4, 6
		The camera is in continuous mode.	Select OFF for  CONTINUOUS .	60
		The camera is in silent mode.	Turn silent mode off.	27
	The flash is off ().	Choose a different flash mode.	26	
	Some flash modes are not available.	The camera is in a shooting mode which makes some flash modes unavailable.	Choose a different shooting mode.	30
		The camera is in silent mode.	Turn silent mode off.	27
The flash does not fully light the subject.	The subject is not in range of the flash.	Position the subject in range of the flash.	94	
	The flash window is obstructed.	Hold the camera correctly.	17	

Problem	Possible cause	Solution	Page	
Problem images		Clean the lens.	97	
		Keep objects away from the lens.	17	
	Pictures are blurred.	The lens is dirty. The lens is blocked. !AF is displayed during shooting and the focus frame is displayed in red.	Check focus before shooting.	23, 87
		!o is displayed during shooting.	Use the flash or a tripod.	26
	Pictures are mottled.	The ambient temperature is high and the subject is poorly lit.	This is normal and does not indicate a malfunction. Choose a lower sensitivity.	59

Playback

	Problem	Possible cause	Solution	Page
Pictures	Pictures are grainy.	The pictures were taken with a different make or model of camera.	—	—
	Playback zoom unavailable.	The pictures were taken at an image size of 0&M , saved as Blog Blog Images, or with a different make or model of camera.	—	—
Audio	No sound in voice memo and movie playback.	Playback volume is too low.	Adjust playback volume.	75
		The microphone was obstructed.	Hold the camera correctly during recording.	40, 69
		The speaker is obstructed.	Hold the camera correctly during playback.	41, 70
Deletion	Selected pictures are not deleted.	Some of the pictures selected for deletion are protected.	Remove protection using the device with which it was originally applied.	65
Frame no.	File numbering is unexpectedly reset.	The battery-chamber cover was opened while the camera was on.	Turn the camera off before opening the battery-chamber cover to replace the battery or insert a memory card.	74

Connections





	Problem	Possible cause	Solution	Page
TV	No picture or sound.	The camera is not properly connected.	Connect the camera correctly.	42
		The supplied A/V cable was connected during movie playback.	Connect the camera once movie playback has ended.	41, 42
		Input on the television is set to "TV".	Set input to "VIDEO".	—
		The camera is not set to the correct video standard.	Match the camera  VIDEO SYSTEM setting to the TV.	41, 71
	The volume on the television is too low.	Adjust the volume.	—	
No color.	The camera is not set to the correct video standard.	Match the camera  VIDEO SYSTEM setting to the TV.	41, 71	
Computer	The computer does not recognize the camera.	The camera is not properly connected.	Connect the camera correctly.	53
		The battery is not inserted.	Check that the battery is inserted or charge the battery.	4, 6
PictBridge	Pictures can not be printed.	The camera is not properly connected.	Connect the camera correctly.	43
		The printer is off.	Turn the printer on.	—
	Only one copy is printed. The date is not printed.	The printer is not PictBridge-compatible.	—	—





Miscellaneous











Problem	Possible cause	Solution	Page
Nothing happens when the shutter button is pressed.	Temporary camera malfunction.	Remove and reinsert the battery.	4
	The battery is exhausted.	Charge the battery or insert a fully-charged spare battery.	4, 6
The camera does not function as expected.	Temporary camera malfunction.	Remove and reinsert the battery. If the problem persists, contact your FUJIFILM dealer.	4
The camera accidentally turns off.	The memory card has been inserted or pulled out.	Insert the memory card, close the battery-chamber cover, and then turn on the camera.	9
No sound.	The camera is in silent mode.	Turn silent mode off.	27

Warning Messages and Displays

The following warnings are displayed in the monitor:

Warning	Description	Solution
 (red)	Low battery.	Charge the battery or insert a fully-charged spare battery.
 (blinks red)	Battery exhausted.	
	Slow shutter speed. Picture may be blurred.	Use the flash or mount the camera on a tripod.
!AF (displayed in red with red focus frame)	The camera can not focus.	<ul style="list-style-type: none"> • Use focus lock to focus on another subject at the same distance, then recompose the picture (pg. 23). • If the subject is poorly lit, try focusing at a distance of about 2 m (6ft. 7in.). • Use macro mode to focus when taking close-ups.
Aperture or shutter speed displayed in red	The subject is too bright or too dark. The picture will be over- or under-exposed.	If the subject is dark, use the flash.
PRESS THE SHUTTER BUTTON TO GO BACK TO SHOOTING MODE CLOSE THE LENS COVER TO TURN OFF THE CAMERA	 button pressed while lens cover is open.	To exit to shooting mode, press the shutter button. Close the lens cover to turn the camera off.
FOCUS ERROR	Camera malfunction.	Turn the camera off and then on again, taking care not to touch the lens. If the message persists, contact a FUJIFILM dealer.
ZOOM ERROR		
NO CARD	No memory card inserted when COPY is selected in the playback menu.	Insert a memory card.
CARD NOT INITIALIZED	The memory card or internal memory is not formatted.	Format the memory card or internal memory (pg. 76).
	The memory card contacts require cleaning.	Clean the contacts with a soft, dry cloth. If the message is repeated, format the memory card (pg. 76). If the message persists, replace the memory card.
	Camera malfunction.	Contact a FUJIFILM dealer.
PROTECTED CARD	The memory card is locked.	Unlock the memory card (pg. 8).
BUSY	The memory card is incorrectly formatted.	Use the camera to format the memory card (pg. 76).

Warning	Description	Solution
CARD ERROR	The memory card is not formatted for use in the camera.	Format the memory card (pg. 76).
	The memory card contacts require cleaning or the memory card is damaged.	Clean the contacts with a soft, dry cloth. If the message is repeated, format the memory card (pg. 76). If the message persists, replace the memory card.
	Camera malfunction.	Contact a FUJIFILM dealer.
 MEMORY FULL	The memory card or internal memory is full; pictures can not be recorded or copied.	Delete pictures or insert a memory card with more free space.
 MEMORY FULL		
INTERNAL MEMORY IS FULL INSERT A NEW CARD		
WRITE ERROR	Memory card error or connection error.	Re-insert the memory card or turn the camera off and then on again. If the message persists, contact a FUJIFILM dealer.
	Not enough memory remaining to record additional pictures.	Delete pictures or insert a memory card with more free space.
	The memory card or internal memory is not formatted.	Format the memory card or internal memory (pg. 76).
READ ERROR	The file is corrupt or was not created with the camera.	The file can not be played back.
	The memory card contacts require cleaning.	Clean the contacts with a soft, dry cloth. If the message is repeated, format the memory card (pg. 76). If the message persists, replace the memory card.
	Camera malfunction.	Contact a FUJIFILM dealer.
FRAME NO. FULL	The camera has run out of frame numbers (current frame number is 999-9999).	Format the memory card and select RENEW for the  FRAME NO. option in the  SETUP menu. Take a picture to reset frame numbering to 100-0001, then return to the  FRAME NO. menu and select CONT.

Warning	Description	Solution
TOO MANY FRAMES	Date for which more than 4,999 pictures exist selected in sort-by-date view.	Choose a different date.
PROTECTED FRAME	An attempt was made to delete, rotate, or add a voice memo to a protected picture.	Remove protection before deleting, rotating, or adding voice memos to pictures.
 ERROR	Voice memo file is corrupt.	The voice memo can not be played back.
	Camera malfunction.	Contact a FUJIFILM dealer.
 NO IMAGE	The source device selected in the playback COPY menu contains no pictures.	Select a different source.
 NO IMAGE		
 CAN NOT TRIM	An attempt was made to crop a O3M picture.	These pictures can not be cropped.
CAN NOT TRIM	The picture selected for cropping is damaged or was not created with the camera.	
 CAN NOT TRIM	An attempt was made to crop a blog image.	
DPOF FILE ERROR	The DPOF print order on the current memory card contains more than 999 images.	Copy the pictures to internal memory and create a new print order.
CAN NOT SET DPOF	The picture can not be printed using DPOF.	—
 CAN NOT SET DPOF	Movies can not be printed using DPOF.	—
CAN NOT ROTATE	Pictures and movies created with other devices can not be rotated.	—
 CAN NOT ROTATE		
 CAN NOT EXECUTE	TRIMMING FOR BLOG can not be used with movies, pictures created with other devices, pictures that can not be viewed, or pictures created using TRIMMING FOR BLOG .	—
 CAN NOT EXECUTE		
 CAN NOT EXECUTE		
 CAN NOT EXECUTE		
PRESS AND HOLD THE DISP BUTTON TO DEACTIVATE SILENT MODE	An attempt was made to choose a flash mode or adjust the volume with the camera in silent mode.	Exit silent mode before choosing a flash mode or adjusting the volume.
COMMUNICATION ERROR	A connection error occurred while pictures were being printed or copied to a computer or other device.	Confirm that the device is turned on. If the device is connected via USB, check that the cable is connected.

Warning	Description	Solution
PRINTER ERROR	Printer out of paper or ink, or other printer error.	Check printer (see printer manual for details). To resume printing, turn the printer off and then turn it back on.
PRINTER ERROR RESUME?		Check printer (see printer manual for details). If printing does not resume automatically, press MENU/OK to resume.
CAN NOT BE PRINTED	An attempt was made to print a movie, a picture not created with the camera, or a picture in a format not supported by the printer.	Movies and some pictures created with other devices can not be printed. If the picture was created with the camera, check the printer manual to confirm that the printer supports the JFIF-JPEG or Exif-JPEG format. If it does not, the pictures can not be printed.

Glossary

Digital zoom: Unlike optical zoom, digital zoom does not increase the amount of visible detail. Instead, details visible using optical zoom are simply enlarged, producing a slightly “grainy” image.

DPOF (Digital Print Order Format): A standard that allows pictures to be printed from “print orders” stored in internal memory or on a memory card. The information in the order includes the pictures to be printed and the number of copies of each picture.



EV (Exposure Value): The exposure value is determined by the sensitivity of the image sensor and the amount of light that enters the camera while the image sensor is exposed. Each time the amount of light doubles, EV increases by one; each time the amount of light is halved, EV decreases by one. The amount of light entering the camera can be controlled by adjusting aperture and shutter speed.

Exif Print: A standard that allows information stored with pictures to be used for optimal color reproduction during printing.

JPEG (Joint Photographic Experts Group): A compressed file format for color images. The higher the compression rate, the greater the loss of information and more noticeable drop in quality when the picture is displayed.

Smear: A phenomenon specific to CCDs which causes white streaks to appear when very bright light sources, such as the sun or reflected sunlight, appear in the frame.

WAV (Waveform Audio Format): A standard Windows audio file format. WAV files have the extension “*.WAV” and may be compressed or uncompressed. The camera uses uncompressed WAV. WAV files can be played using Windows Media Player or QuickTime 3.0 or later.

White balance: The human brain automatically adapts to changes in the color of light, with the result that objects that appear white under one light source still appear white when the color of the light source changes. Digital cameras can mimic this adjustment by processing images according to the color of the light source. This process is known as “white balance”.













Internal Memory/Memory Card Capacity

The following table shows the recording time or number of pictures available at different image qualities. All figures are approximate; file size varies with the scene recorded, producing wide variations in the number of files that can be stored. The number of exposures or length remaining may not diminish at an even rate.

	📷 IMAGE QUALITY						🎥 MOVIE QUALITY			
	10M F	10M N	9M 3:2	5M	3M	2M	03M	640i (30 fps)	320i (30 fps)	
Image size (pixels)	3648 × 2736	3648 × 2736	3648 × 2432	2592 × 1944	2048 × 1536	1600 × 1200	640 × 480	640 × 480	320 × 240	
File size	Approx. 4.8MB	Approx. 2.5 MB	Approx. 2.2 MB	Approx. 1.3 MB	Approx. 980KB	Approx. 720 KB	Approx. 200KB	—	—	
Internal memory (approx. 18 MB)	3	7	8	15	21	28	89	19 sec.	33 sec.	
SD card	512 MB	95	180	210	350	480	640	2,200	6 min.	14 min.
	1 GB	190	380	420	700	960	1,280	4,420	12 min.	28 min.
	2 GB	390	760	860	1,400	1,930	2,580	8,850	25 min.	57 min.
SDHC card	4 GB	790	1,520	1,720	2,810	3,870	5,160	17,720	50 min.	116 min.
	8 GB	1,590	3,060	3,460	5,660	7,780	10,380	35,600	102 min.	223 min.

- A movie recording will stop automatically when a movie file becomes approx. 2GB. If you want to continue recording, press the shutter button again. The available recording time is displayed based on approx. 2GB.

Specifications

System	
Model	FinePix Z35/FinePix Z37 digital camera
Effective pixels	10.0 million
CCD	½.3-in., square-pixel CCD with primary color filter
Storage media	<ul style="list-style-type: none">• Internal memory (approx. 18 MB)• SD/SDHC memory cards (see page 8)
File system	Compliant with Design Rule for Camera File System (DCF), Exif 2.2, and Digital Print Order Format (DPOF)
File format	<ul style="list-style-type: none">• Still pictures: Exif 2.2 JPEG (compressed)• Movies: Motion JPEG AVI• Audio: Monaural WAV
Image size (pixels)	<ul style="list-style-type: none">• 10M F: 3,648 × 2,736• 10M N: 3,648 × 2,736• 9M 3:2: 3,648 × 2,432• 5M: 2,592 × 1,944• 3M: 2,048 × 1,536• 2M: 1,600 × 1,200• 0.3M: 640 × 480
File size	See page 92
Lens	3× optical zoom lens, f/3.7 (wide angle) – 4.2 (telephoto)
Focal length	F=6.51 mm–18.09 mm (35-mm format equivalent: 35 mm–105 mm)
Digital zoom	Approx. 5.7× (up to 17.1× when combined with optical zoom)
Aperture	[Wide angle] F3.7 to F8.0 (three steps) / [Telephoto] F4.2 to F9.0 (three steps)
Focus range (distance from front of lens)	Approx. 60 cm (2 ft.)–infinity (wide angle/telephoto) Macro mode: approx. 8 cm–80 cm/3.1 in.–2 ft. 7 in. (wide angle); 60 cm–3 m/2 ft.–9 ft. 11 in. (telephoto)
Sensitivity	Equivalent to ISO 100, 200, 400, 800, 1600; AUTO (Standard Output Sensitivity)
Metering	256-segment through-the-lens (TTL) metering
Exposure control	Programmed autoexposure
Exposure compensation	–2 EV – +2 EV in increments of ⅓ EV (CAM mode)
Scene modes	 (NATURAL LIGHT),  (PORTRAIT),  (LANDSCAPE),  (SPORT),  (NIGHT),  (NIGHT (TRIPOD)),  (SUNSET),  (SNOW),  (BEACH),  (PARTY),  (FLOWER),  (TEXT)
Image Stabilization	Available
Intelligent Face Detection	Available

System	
Shutter speed	3 s– $\frac{1}{1,000}$ s; combined mechanical and electronic shutter
Continuous	TOP 3: Up to 1 fps; max. 3 frames
Focus	<ul style="list-style-type: none"> • Mode: Single AF • Autofocus system: Contrast-detect TTL AF • Focus-area selection: AF CENTER
White balance	Automatic scene detection; six manual preset modes for direct sunlight, shade, daylight fluorescent, warm white fluorescent, cool white fluorescent, and incandescent lighting
Self-timer	Approx. 2 sec./10 sec.
Flash	Auto flash; effective range when sensitivity is set to AUTO is approx. 70 cm–3.1 m/2 ft. 4 in.–10 ft. 2 in. (wide angle), 70 cm–2.7 m/2 ft. 4 in.–8 ft. 9 in. (telephoto), or 30 cm–80 cm/1 ft.–2 ft. 7 in. (macro mode)
Flash modes	Auto, fill flash, off, slow sync (red-eye removal off); auto with red-eye removal, fill flash with red-eye removal, off, slow sync with red-eye removal (red-eye removal on)
Monitor	<ul style="list-style-type: none"> • FinePix Z35: 2.5-in., 230k-dot color LCD monitor; frame coverage approx. 97% • FinePix Z37: 2.7-in., 230k-dot color LCD monitor; frame coverage approx. 97%
Movies	Camera can record movies with monaural sound and a frame size of 640 × 480 (640) or 320 × 240 (320) at a frame rate of 30 fps
Shooting options	Scene recognition, Intelligent Face Detection with red-eye removal, best framing, and frame number memory
Playback options	Intelligent Face Detection, Red-Eye Removal, micro thumbnail, multi-frame playback, sort-by-date, trimming for blog, cropping (still pictures), slide show, image rotation, and voice memo
Other options	PictBridge, Exif Print, language selection (Japanese / English / French / German / Spanish / Italian / Simplified Chinese / Korean / Dutch / Portuguese / Russian / Thai / Turkish / Traditional Chinese / Czech / Hungarian / Polish / Swedish / Slovak / Danish / Norwegian / Finnish / Arabic), time difference, silent mode
Input/output terminals	
A/V OUT (audio/video output)	NTSC or PAL with monaural sound
Digital input/output	USB 2.0 High Speed with MTP/PTP connection

Power supply/other					
Power sources	NP-45A rechargeable battery				
Guide to the number of available frames for battery operation	<table border="1"> <thead> <tr> <th>Battery Type</th> <th>Number of frames</th> </tr> </thead> <tbody> <tr> <td>NP-45A</td> <td>Approx. 165 frames</td> </tr> </tbody> </table>	Battery Type	Number of frames	NP-45A	Approx. 165 frames
	Battery Type	Number of frames			
NP-45A	Approx. 165 frames				
<p>According to the CIPA (Camera and Imaging Products Association) standard procedure for measuring digital still camera battery consumption (extract): When using a battery, use the battery supplied with the camera. The storage media should be SD memory card. Note that the number of shots that can be taken with a fully-charged battery varies with temperature and shooting conditions.</p>					
Camera dimensions	89.0 mm × 57.9 mm × 23.9 mm/3.5 in. × 2.3 in. × 0.9 in. (W × H × D), excluding projections				
Camera weight	<ul style="list-style-type: none"> • FinePix Z35: Approx. 115 g/4.0 oz., excluding battery, accessories, and memory cards • FinePix Z37: Approx. 115 g/4.0 oz., excluding battery, accessories, and memory cards 				
Shooting weight	<ul style="list-style-type: none"> • FinePix Z35: Approx. 132 g/4.6 oz., including battery and memory card • FinePix Z37: Approx. 132 g/4.6 oz., including battery and memory card 				
Operating conditions	<ul style="list-style-type: none"> • Temperature: 0°C – +40°C/+32°F – +104°F • Humidity: 10%–85% (no condensation) 				
NP-45A rechargeable battery					
Nominal voltage	DC 3.7V				
Operating temperature	0°C – +40°C/+32°F – +104°F				
Dimensions (W × H × D)	31 mm × 39.4 mm × 5.7 mm/ 1.2 in. × 1.6 in. × 0.2 in.				
Weight	Approx. 15 g/1.0 oz.				
AC power adapter					
Rated input	100 – 240V AC, 50/60 Hz				
Charging time	Approx. 210 minutes (measured at +20°C (+68°F))				
Operating temperature	0°C – +40°C/+32°F – +104°F				

* The weight and dimensions vary depending on the country or region of sale.

Color Television Systems

NTSC (National Television System Committee) is a color television telecasting specification adopted mainly in the U.S.A., Canada, and Japan. PAL (Phase Alternation by Line) is a color television system adopted mainly in European countries and China.

Notices

- Specifications subject to change without notice. FUJIFILM shall not be held liable for damages resulting from errors in this manual.
- Although the monitor is manufactured using advanced high-precision technology, small bright points and anomalous colors (particularly in the vicinity of text) may appear. This is normal for this type of monitor and does not indicate a malfunction; images recorded with the camera are unaffected.
- Digital cameras may malfunction when exposed to strong radio interference (e.g., electric fields, static electricity, or line noise).
- Due to the type of lens used, some distortion may occur at the periphery of images. This is normal.

Caring for the Camera

To ensure continued enjoyment of the product, observe the following precautions.

Storage and Use

If the camera will not be used for an extended period, remove the battery and memory card. Do not store or use the camera in locations that are:

- exposed to rain, steam, or smoke
- very humid or extremely dusty
- exposed to direct sunlight or very high temperatures, such as in a closed vehicle on a sunny day
- extremely cold
- subject to strong vibration
- exposed to strong magnetic fields, such as near a broadcasting antenna, power line, radar emitter, motor, transformer, or magnet
- in contact with volatile chemicals such as pesticides
- next to rubber or vinyl products

Water and Sand

Exposure to water and sand can also damage the camera and its internal circuitry and mechanisms. When using the camera at the beach or seaside, avoid exposing the camera to water or sand. Do not place the camera on a wet surface.

Condensation

Sudden increases in temperature, such as occur when entering a heated building on a cold day, can cause condensation inside the camera. If this occurs, turn the camera off and wait an hour before turning it on again. If condensation forms on the memory card, remove the card and wait for the condensation to dissipate.

Cleaning

Use a blower to remove dust from the lens and monitor, then gently wipe with a soft, dry cloth. Any remaining stains can be removed by wiping gently with a piece of FUJIFILM lens-cleaning paper to which a small amount of lens-cleaning fluid has been applied. Care should be taken to avoid scratching the lens or monitor. The camera body can be cleaned with a soft, dry cloth. Do not use alcohol, thinner, or other volatile chemicals.

Travelling

Keep the camera in your carry-on baggage. Checked baggage may suffer violent shocks that could damage the camera.

FUJIFILM

FUJIFILM Corporation

7-3, AKASAKA 9-CHOME, MINATO-KU, TOKYO 107-0052, JAPAN

http://www.fujifilm.com/products/digital_cameras/index.html