

FUJIFILM

BL00004756-201 **EN**

DIGITAL CAMERA

X-E2

Version 4.00

Owner's Manual

Thank you for your purchase of this product. This manual describes how to use your FUJIFILM X-E2 Version 4.00 digital camera. Be sure that you have read and understood its contents before using the camera.

■ **Product website:**

<http://fujifilm-x.com/x-e2/>

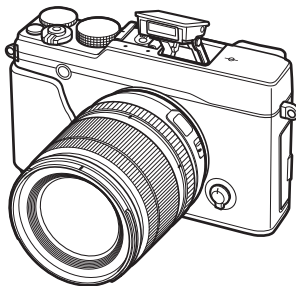

■ **Additional information may be found in online manuals available from:**

<http://fujifilm-dsc.com/manuals/>



Before You Begin

First Steps

Basic Photography
and Playback

Basic Movie Recording
and Playback

The Q (Quick Menu) Button
The Fn (Function) Buttons

More on Photography
and Playback

Menus

Connections

Technical Notes

Troubleshooting

Appendix



IMPORTANT SAFETY INSTRUCTIONS

- **Read Instructions:** All the safety and operating instructions should be read before the appliance is operated.
- **Retain Instructions:** The safety and operating instructions should be retained for future reference.
- **Heed Warnings:** All warnings on the appliance and in the operating instructions should be adhered to.
- **Follow Instructions:** All operating and use instructions should be followed.

Installation

Power Sources: This video product should be operated only from the type of power source indicated on the marking label. If you are not sure of the type of power supply to your home, consult your appliance dealer or local power company. For video products intended to operate from battery power, or other sources, refer to the operating instructions.

Grounding or Polarization: This video product is equipped with a polarized alternating-current line plug (a plug having one blade wider than the other). This plug will fit into the power outlet only one way. This is a safety feature. If you are unable to insert the plug fully into the outlet, try reversing the plug. If the plug should still fail to fit, contact your electrician to replace your obsolete outlet. Do not defeat the safety purpose of the polarized plug.

Alternate Warnings: This video product is equipped with a three-wire grounding-type plug, a plug having a third (grounding) pin. This plug will only fit into a grounding-type power outlet. This is a safety feature. If you are unable to insert the plug into the outlet, contact your electrician to replace your obsolete outlet. Do not defeat the safety purpose of the grounding type plug.

Overloading: Do not overload wall outlets and extension cords as this can result in a risk of fire or electric shock.

Ventilation: Slots and openings in the cabinet are provided for ventilation, to ensure reliable operation of the video product and to protect it from overheating, and these openings must not be blocked or covered. The openings should never be blocked by placing the video product on a bed, sofa, rug, or other similar surface.

This video product should not be placed in a built-in installation such as a bookcase or rack unless proper ventilation is provided or the manufacturer's instructions have been adhered to. This video product should never be placed near or over a radiator or heat register.

Attachments: Do not use attachments not recommended by the video product manufacturer as they may cause hazards.

Water and Moisture: Do not use this video product near water—for example, near a bath tub, wash bowl, kitchen sink, or laundry tub, in a wet basement, or near a swimming pool, and the like.

Power-Cord Protection: Power-supply cords should be routed so that they are not likely to be walked on or pinched by items placed upon or against them, paying particular attention to cords at plugs, convenience receptacles, and the point where they exit from the appliance.

Accessories: Do not place this video product on an unstable cart, stand, tripod, bracket, or table. The video product may fall, causing serious injury to a child or adult, and serious damage to the appliance. Use only with a cart, stand, tripod, bracket, or table recommended by the manufacturer, or sold with the video product. Any mounting of the appliance should follow the manufacturer's instructions, and should use a mounting accessory recommended by the manufacturer.

An appliance and cart combination should be moved with care. Quick stops, excessive force, and uneven surfaces may cause the appliance and cart combination to overturn.



Antennas

Outdoor Antenna Grounding: If an outside antenna or cable system is connected to the video product, be sure the antenna or cable system is grounded so as to provide some protection against voltage surges and built-up static charges. Section 810 of the National Electrical Code, ANSI/NFPA No. 70, provides information with respect to proper grounding of the

mast and supporting structure, grounding of the lead-in wire to an antenna discharge unit, size of grounding conductors, location of antenna discharge unit, connection to grounding electrodes, and requirements for the grounding electrode.

EXAMPLE OF ANTENNA GROUNDING AS PER NATIONAL ELECTRICAL CODE

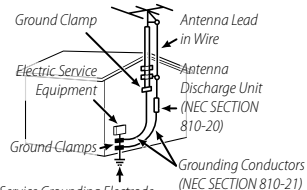

Power Service Grounding Electrode System (NEC ART 250, PART H)

Power Lines: An outside antenna system should not be located in the vicinity of overhead power lines or other electric light or power circuits, or where it can fall into such power lines or circuits. When installing an outside antenna system, extreme care should be taken to keep from touching such power lines or circuits as contact with them might be fatal.

Use

Cleaning: Unplug this video product from the wall outlet before cleaning. Do not use liquid cleaners or aerosol cleaners. Use a damp cloth for cleaning.

Object and Liquid Entry: Never push objects of any kind into this video product through openings as they may touch dangerous voltage points or short out parts that could result in a fire or electric shock. Never spill liquid of any kind on the video product.

Lightning: For added protection for this video product receiver during a lightning storm, or when it is left unattended and unused for long periods of time, unplug it from the wall outlet and disconnect the antenna or cable system. This will prevent damage to the video product due to lightning and power-line surges.

Service

Service: Do not attempt to service this video product yourself as opening or removing covers may expose you to dangerous voltage or other hazards. Refer all servicing to qualified service personnel.

Damage Requiring Service: Unplug this video product from the wall outlet and refer servicing to qualified service personnel under the following conditions:

- When the power-supply cord or plug is damaged
- If liquid has been spilled, or objects have fallen into the video product.
- If the video product has been exposed to rain or water.
- If the video product has been dropped or the cabinet has been damaged.

If the video product does not operate normally follow the operating instructions. Adjust only those controls that are covered by the operating instructions as an improper adjustment of other controls may result in damage and will often require extensive work by a qualified technician to restore the video product to its normal operation.

When the video product exhibits a distinct change in performance—this indicates a need for service.

Replacement Parts: When replacement parts are required, be sure the service technician has used replacement parts specified by the manufacturer or have the same characteristics as the original part. Unauthorized substitutions may result in fire, electric shock or other hazards.



Safety Check: Upon completion of any service or repairs to this video product, ask the service technician to perform safety checks to determine that the video product is in proper operating condition.

Be sure to read these notes before use**Safety Notes**



- Make sure that you use your camera correctly. Read these safety notes and your *Owner's Manual* carefully before use.
- After reading these safety notes, store them in a safe place.

About the Icons

The icons shown below are used in this document to indicate the severity of the injury or damage that can result if the information indicated by the icon is ignored and the product is used incorrectly as a result.

	WARNING	This icon indicates that death or serious injury can result if the information is ignored.
	CAUTION	This icon indicates that personal injury or material damage can result if the information is ignored.

The icons shown below are used to indicate the nature of the instructions which are to be observed.

	Triangular icons tell you that this information requires attention ("Important").
	Circular icons with a diagonal bar tell you that the action indicated is prohibited ("Prohibited").
	Filled circles with an exclamation mark indicate an action that must be performed ("Required").

**WARNING**

Unplug from power socket

If a problem arises, turn the camera off, remove the battery, and disconnect and unplug the AC power adapter. Continued use of the camera when it is emitting smoke, is emitting any unusual odor, or is in any other abnormal state can cause a fire or electric shock. Contact your FUJIFILM dealer.



Do not allow water or foreign objects to enter the camera. If water or foreign objects get inside the camera, turn the camera off, remove the battery, and disconnect and unplug the AC power adapter. Continued use of the camera can cause a fire or electric shock. Contact your FUJIFILM dealer.



Do not use in the bathroom or shower

Do not use the camera in the bathroom or shower. This can cause a fire or electric shock.



Do not disassemble

Never attempt to change or take apart the camera (never open the case). Failure to observe this precaution can cause fire or electric shock.



Do not touch internal parts

Should the case break open as the result of a fall or other accident, do not touch the exposed parts. Failure to observe this precaution could result in electric shock or in injury from touching the damaged parts. Remove the battery immediately, taking care to avoid injury or electric shock, and take the product to the point of purchase for consultation.













Do not change, heat or unduly twist or pull the connection cord and do not place heavy objects on the connection cord. These actions could damage the cord and cause a fire or electric shock. If the cord is damaged, contact your FUJIFILM dealer.

















Do not place the camera on an unstable surface. This can cause the camera to fall or tip over and cause injury.



Never attempt to take pictures while in motion. Do not use the camera while walking or driving. This can result in you falling down or being involved in a traffic accident.

 WARNING	
	Do not touch any metal parts of the camera during a thunderstorm. This can cause an electric shock due to induced current from the lightning discharge.
	Do not use the battery except as specified. Load the battery as shown by the indicator.
	Do not heat, change or take apart the battery. Do not drop or subject the battery to impacts. Do not store the battery with metallic products. Any of these actions can cause the battery to burst or leak and cause fire or injury as a result.
	Use only batteries or AC power adapters specified for use with this camera. Do not use voltages other than the power supply voltage shown. The use of other power sources can cause a fire.
	If the battery leaks and fluid gets in contact with your eyes, skin or clothing, flush the affected area with clean water and seek medical attention or call an emergency number right away.
	Do not use the charger to charge batteries other than those specified here. The supplied charger is for use only with batteries of the type supplied with the camera. Using the charger to charge conventional batteries or other types of rechargeable batteries can cause the battery to leak, overheat or burst.
	Using a flash too close to a person's eyes may cause visual impairment. Take particular care when photographing infants and young children.
	Do not use in the presence of flammable objects, explosive gases, or dust.
	When carrying the battery, install it in a digital camera or keep it in the hard case. When storing the battery, keep it in the hard case. When discarding, cover the battery terminals with insulation tape. Contact with other metallic objects or batteries could cause the battery to ignite or burst.

 WARNING	
	Keep memory cards, hot shoes, and other small parts out of the reach of small children. Children may swallow small parts; keep out of reach of children. Should a child swallow a small part, seek medical attention or call emergency.
	Keep out of reach of small children. Among the elements that could cause injury are the strap, which could become entangled about a child's neck, causing strangulation, and the flash, which could cause visual impairment.
	Follow the directions of airline and hospital personnel. This product generates radio-frequency emissions that could interfere with navigational or medical equipment.

 CAUTION	
	Do not use this camera in locations affected by oil fumes, steam, humidity or dust. This can cause a fire or electric shock.
	Do not leave this camera in places subject to extremely high temperatures. Do not leave the camera in locations such as a sealed vehicle or in direct sunlight. This can cause a fire.
	Do not place heavy objects on the camera. This can cause the heavy object to tip over or fall and cause injury.
	Do not move the camera while the AC power adapter is still connected. Do not pull on the connection cord to disconnect the AC power adapter. This can damage the power cord or cables and cause a fire or electric shock.
	Do not cover or wrap the camera or the AC power adapter in a cloth or blanket. This can cause heat to build up and distort the casing or cause a fire.
	When you are cleaning the camera or you do not plan to use the camera for an extended period, remove the battery and disconnect and unplug the AC power adapter. Failure to do so can cause a fire or electric shock.
	When charging ends, unplug the charger from the power socket. Leaving the charger plugged into the power socket can cause a fire.
	When a memory card is removed, the card could come out of the slot too quickly. Use your finger to hold it and gently release the card. Injury could result to those struck by the ejected card.
	Request regular internal testing and cleaning for your camera. Build-up of dust in your camera can cause a fire or electric shock. Contact your FUJIFILM dealer to request internal cleaning every two years. Please note that this service is not free of charge.
	Danger of explosion if battery is incorrectly replaced. Replace only with the same or equivalent type.

The Battery and Power Supply

Note: Check the type of battery used in your camera and read the appropriate sections.

The following describes the proper use of batteries and how to prolong their life. Incorrect use can shorten battery life or cause leakage, overheating, fire, or explosion.

Li-ion Batteries

Read this section if your camera uses a rechargeable Li-ion battery.

The battery is not charged at shipment. Charge the battery before use. Keep the battery in its case when not in use.

■ Notes on the Battery

The battery gradually loses its charge when not in use. Charge the battery one or two days before use.

Battery life can be extended by turning the camera off when not in use.

Battery capacity decreases at low temperatures; a depleted battery may not function at when cold. Keep a fully charged spare battery in a warm place and exchange as necessary, or keep the battery in your pocket or other warm place and insert it in the camera only when shooting. Do not place the battery in direct contact with hand warmers or other heating devices.

■ Charging the Battery

Charge the battery in the supplied battery charger. Charging times will increase at ambient temperatures below +10°C (+50°F) or above +35°C (+95°F). Do not attempt to charge the battery at temperatures above 40°C (+104°F); at temperatures below 0°C (+32°F), the battery will not charge.

Do not attempt to recharge a fully charged battery. The battery does not however need to be fully discharged before charging.

The battery may be warm to the touch immediately after charging or use. This is normal.

■ Battery Life

At normal temperatures, the battery can be recharged about 300 times. A noticeable decrease in the length of time the battery will hold a charge indicates that it has reached the end of its service life and should be replaced.

■ Storage

Performance may be impaired if the battery is left unused for extended periods when fully charged. Run the battery flat before storing it.

If the camera will not be used for an extended period, remove the battery and store it in a dry place with an ambient temperature of from +15°C to +25°C (+59°F to +77°F). Do not store in locations exposed to extremes of temperature.

■ Cautions: Handling the Battery

- Do not transport or store with metal objects such as necklaces or hairpins.
- Do not expose to flame or heat.
- Do not disassemble or modify.
- Use with designated chargers only.
- Dispose of used batteries promptly.
- Do not drop or subject to strong physical shocks.
- Do not expose to water.
- Keep the terminals clean.
- The battery and camera body may become warm to the touch after extended use. This is normal.

■ Disposal

Dispose of used batteries in accord with local regulations.

AC Power Adapters (Available Separately)

Use only FUJIFILM AC power adapters designated for use with this camera. Other adapters could damage the camera.

- The AC power adapter is for indoor use only.
- Be sure the DC plug is securely connected to the camera.
- Turn the camera off before disconnecting the adapter. Disconnect the adapter by the plug, not the cable.
- Do not use with other devices.
- Do not disassemble.
- Do not expose to high heat and humidity.
- Do not subject to strong physical shocks.
- The adapter may hum or become hot to the touch during use. This is normal.
- If the adapter causes radio interference, reorient or relocate the receiving antenna.

Using the Camera

- Do not aim the camera at extremely bright light sources, such as the sun in a cloudless sky. Failure to observe this precaution could damage the camera image sensor.
- Strong sunlight focused through the viewfinder may damage the panel of electronic viewfinder (EVF). Do not aim the electronic viewfinder at the sun.

Take Test Shots

Before taking photographs on important occasions (such as at weddings or before taking the camera on a trip), take a test shot and view the results to ensure that the camera is functioning normally. FUJIFILM Corporation can not accept liability for damages or lost profits incurred as a result of product malfunction.

Notes on Copyright

Unless intended solely for personal use, images recorded using your digital camera system cannot be used in ways that infringe copyright laws without the consent of the owner. Note that some restrictions apply to the photographing of stage performances, entertainments, and exhibits, even when intended purely for personal use. Users are also asked to note that the transfer of memory cards containing images or data protected under copyright laws is only permissible within the restrictions imposed by those copyright laws.

Handling

To ensure that images are recorded correctly, do not subject the camera to impact or physical shocks while images are being recorded.

Liquid Crystal

In the event that the display is damaged, care should be taken to avoid contact with liquid crystal. Take the urgent action indicated should any of the following situations arise:

- **If liquid crystal comes in contact with your skin**, clean the area with a cloth and then wash thoroughly with soap and running water.
- **If liquid crystal enters your eyes**, flush the affected eye with clean water for at least 15 minutes and then seek medical assistance.
- **If liquid crystal is swallowed**, rinse your mouth thoroughly with water. Drink large quantities of water and induce vomiting, then seek medical assistance.

Although the display is manufactured using extremely high-precision technology, it may contain pixels that are always lit or that do not light. This is not a malfunction, and images recorded with the product are unaffected.

Trademark Information

Digital Split Image is a trademark or registered trademark of FUJIFILM Corporation. **xD-Picture Card** and **xD** are trademarks of FUJIFILM Corporation. The typefaces included herein are solely developed by DynaComware Taiwan Inc. Macintosh, QuickTime, and Mac OS are trademarks of Apple Inc. in the U.S.A. and other countries. The Windows logo is a trademark of the Microsoft group of companies. Wi-Fi® and Wi-Fi Protected Setup® are registered trademarks of the Wi-Fi Alliance. Adobe and Adobe Reader are either trademarks or registered trademarks of Adobe Systems Incorporated in the U.S.A. and/or other countries. The SDHC and SDXC logos are trademarks of SD-3C, LLC. The HDMI logo is a trademark. YouTube is a trademark of Google Inc. All other trade names mentioned in this manual are the trademarks or registered trademarks of their respective owners.

Electrical Interference

This camera may interfere with hospital or aviation equipment. Consult with hospital or airline staff before using the camera in a hospital or on an aircraft.

Color Television Systems

NTSC (National Television System Committee) is a color television telecasting specification adopted mainly in the U.S.A., Canada, and Japan. PAL (Phase Alternation by Line) is a color television system adopted mainly in European countries and China.

Exif Print (Exif Version 2.3)

Exif Print is a newly revised digital camera file format in which information stored with photographs is used for optimal color reproduction during printing.

IMPORTANT NOTICE: Read Before Using the Software

Direct or indirect export, in whole or in part, of licensed software without the permission of the applicable governing bodies is prohibited.

NOTICES

To prevent fire or shock hazard, do not expose the unit to rain or moisture.

Please read the "Safety Notes" and make sure you understand them before using the camera.

Perchlorate Material—special handling may apply. See <http://www.dtsc.ca.gov/hazardouswaste/perchlorate>.

For Customers in the U.S.A.**Tested To Comply With FCC Standards****FOR HOME OR OFFICE USE**

Contains IC: 7736B-0200002

Contains FCC ID: W22-0200002

FCC Statement: This device complies with Part 15 of the FCC Rules. Operation is subject to the following two conditions: (1) This device may not cause harmful interference, and (2) this device must accept any interference received, including interference that may cause undesired operation.

CAUTION: This equipment has been tested and found to comply with the limits for a Class B digital device, pursuant to Part 15 of the FCC Rules. These limits are designed to provide reasonable protection against harmful interference in a residential installation. This equipment generates, uses, and can radiate radio frequency energy and, if not installed and used in accordance with the instructions, may cause harmful interference to radio communications. However, there is no guarantee that interference will not occur in a particular installation. If this equipment does cause harmful interference to radio or television reception, which can be determined by turning the equipment off and on, the user is encouraged to try to correct the interference by one or more of the following measures:

- Reorient or relocate the receiving antenna.
- Increase the separation between the equipment and receiver.
- Connect the equipment into an outlet on a circuit different from that to which the receiver is connected.
- Consult the dealer or an experienced radio/TV technician for help.

FCC Caution: Any changes or modifications not expressly approved by the party responsible for compliance could void the user's authority to operate this equipment.

This transmitter must not be co-located or operating in conjunction with any other antenna or transmitter.

Radiation Exposure Statement: This device meets the government's requirements for exposure to radio waves. This device is designed and manufactured not to exceed the emission limits for exposure to radio frequency (RF) energy set by the Federal Communications Commission of the U.S. Government.

The exposure standard for wireless device employs a unit of measurement known as the Specific Absorption Rate, or SAR. The SAR limit set by the FCC is 1.6W/kg. *Tests for SAR are conducted using standard operating positions accepted by the FCC with the device transmitting at its highest certified power level in all tested frequency bands.

Notes on the Grant: To comply with Part 15 of the FCC Rules, this product must be used with a Fujifilm-specified ferrite-core A/V cable, USB cable, and DC supply cord.



A lithium ion battery that is recyclable powers the product you have purchased. Please call 1-800-8-BATTERY for information on how to recycle this battery.

For Customers in Canada**CAN ICES-3 (B)/NMB-3(B)**

CAUTION: This Class B digital apparatus complies with Canadian ICES-003.

Industry Canada statement: This device complies with RSS-210 of the Industry Canada Rules. Operation is subject to the following two conditions: (1) This device may not cause harmful interference, and (2) this device must accept any interference received, including interference that may cause undesired operation.

This device and its antenna(s) must not be co-located or operating in conjunction with any other antenna or transmitter, except tested built-in radios. The County Code Selection feature is disabled for products marketed in the US/ Canada.

Radiation Exposure Statement: The available scientific evidence does not show that any health problems are associated with using low power wireless devices. There is no proof, however, that these low power wireless devices are absolutely safe. Low power Wireless devices emit low levels of radio frequency energy (RF) in the microwave range while being used. Whereas high levels of RF can produce health

effects (by heating tissue), exposure of low-level RF that does not produce heating effects causes no known adverse health effects. Many studies of low-level RF exposures have not found any biological effects. Some studies have suggested that some biological effects might occur, but such findings have not been confirmed by additional research. X-E2 has been tested and found to comply with IC radiation exposure limits set forth for an uncontrolled environment and meets RSS-102 of the IC radio frequency (RF) Exposure rules.

Disposal of Electrical and Electronic Equipment in Private Households

In the European Union, Norway, Iceland and Liechtenstein: This symbol on the product, or in the manual and in the warranty, and/or on its packaging indicates that this product shall not be treated as household waste. Instead it should be taken to an applicable collection point for the recycling of electrical and electronic equipment.



By ensuring this product is disposed of correctly, you will help prevent potential negative consequences to the environment and human health, which could otherwise be caused by inappropriate waste handling of this product.

This symbol on the batteries or accumulators indicates that those batteries shall not be treated as household waste.



If your equipment contains easy removable batteries or accumulators please dispose these separately according to your local requirements.

The recycling of materials will help to conserve natural resources. For more detailed information about recycling this product, please contact your local city office, your household waste disposal service or the shop where you purchased the product.

In Countries Outside the European Union, Norway, Iceland and Liechtenstein: If you wish to discard this product, including the batteries or accumulators, please contact your local authorities and ask for the correct way of disposal.

In Japan: This symbol on the batteries indicates that they are to be disposed of separately.



Be sure to read these notes before use



Safety Notes

Thank you for your purchase of this product. For repair, inspection, and internal testing, contact your FUJIFILM dealer.



- Make sure that you use the lens correctly. Read these safety notes and the camera *Owner's Manual* carefully before use.
- After reading these safety notes, store them in a safe place.

About the Icons



The icons shown below are used in this document to indicate the severity of the injury or damage that can result if the information indicated by the icon is ignored and the product is used incorrectly as a result.

	WARNING	This icon indicates that death or serious injury can result if the information is ignored.
	CAUTION	This icon indicates that personal injury or material damage can result if the information is ignored.



The icons shown below are used to indicate the nature of the instructions which are to be observed.

	Triangular icons tell you that this information requires attention ("Important").
	Circular icons with a diagonal bar tell you that the action indicated is prohibited ("Prohibited").
	Filled circles with an exclamation mark indicate an action that must be performed ("Required").







WARNING

	Do not immerse in or expose to water. Failure to observe this precaution can cause a fire or electric shock.
	Do not disassemble (do not open the case). Failure to observe this precaution can cause fire, electric shock, or injury due to product malfunction.
	Should the case break open as the result of a fall or other accident, do not touch the exposed parts. Failure to observe this precaution could result in electric shock or in injury from touching the damaged parts. Remove the camera battery immediately, taking care to avoid injury or electric shock, and take the product to the point of purchase for consultation.

WARNING

-  **Do not place on unstable surfaces.** The product may fall, causing injury.
-  **Do not view the sun through the lens or camera viewfinders.** Failure to observe this precaution can cause permanent visual impairment.

CAUTION

-  **Do not use or store in locations that are exposed to steam, or smoke or are very humid or extremely dusty.** Failure to observe this precaution can cause fire or electric shock.
-  **Do not leave in direct sunlight or in locations subject to very high temperatures, such as in a closed vehicle on a sunny day.** Failure to observe this precaution can cause fire.
-  **Keep out of the reach of small children.** This product could cause injury in the hands of a child.
-  **Do not handle with wet hands.** Failure to observe this precaution can cause electric shock.
-  **Keep the sun out of the frame when shooting backlit subjects.** Sunlight focused into the camera when the sun is in or close to the frame can cause fire or burns.
-  **When the product is not in use, replace the lens caps and store out of direct sunlight.** Sunlight focused by the lens can cause fire or burns.
-  **Do not carry the camera or lens while they are attached to a tripod.** The product can fall or strike other objects, causing injury.

European Union regulatory notice

This product complies with the following EU Directives:

- RoHS Directive 2011/65/EU
- R & TTE Directive 1999/5/EC

Compliance with these directives implies conformity to applicable harmonized European standards (European Norms) which are listed on the EU Declaration of Conformity issued by FUJIFILM Corporation for this product or product family.

This compliance is indicated by the following conformity marking placed on the product:



This marking is valid for non-Telecom products and EU harmonized Telecom products (e.g. Bluetooth).

Regarding the Declaration of Conformity, visit http://www.fujifilm.com/products/digital_cameras/x/fujifilm_x_e2/pdf/index/fujifilm_x_e2_cod.pdf.

IMPORTANT: Read the following notices before using the camera's built-in wireless transmitter.

- ① This product, which contains encryption function developed in the United States, is controlled by the United States Export Administration Regulations and may not be exported or re-exported to any country to which the United States embargoes goods.
- **Use only as part of a wireless network.** FUJIFILM does not accept liability for damages resulting from unauthorized use. Do not use in applications requiring a high degree of reliability, for example in medical devices or other systems that may directly or indirectly impact human life. When using the device in computer and other systems that demand a greater degree of reliability than wireless networks, be sure to take all necessary precautions to ensure safety and prevent malfunction.
- **Use only in the country in which the device was purchased.** This device conforms to regulations governing wireless network devices in the country in which it was purchased. Observe all location regulations when using the device. FUJIFILM does not accept liability for problems arising from use in other jurisdictions.
- **Wireless data (images) may be intercepted by third parties.** The security of data transmitted over wireless networks is not guaranteed.
- **Do not use the device in locations subject to magnetic fields, static electricity, or radio interference.** Do not use the transmitter in the vicinity of microwave ovens or in other locations subject to magnetic fields, static electricity, or radio interference that may prevent reception of wireless signals. Mutual interference may occur when the transmitter is used in the vicinity of other wireless devices operating in the 2.4 GHz band.
- **The wireless transmitter operates in the 2.4 GHz band using DSSS and OFDM modulation.**

Wireless Network Devices: Cautions

- **This device operates on the same frequency as commercial, educational, and medical devices and wireless transmitters.** It also operates on the same frequency as licensed transmitters and special unlicensed low-voltage transmitters used in RFID tracking systems for assembly lines and in other similar applications.
- **To prevent interference with the above devices, observe the following precautions.** Confirm that the RFID transmitter is not in operation before using this device. Should you observe that the device causes interference in licensed transmitters used for RFID tracking, immediately stop using the affected frequency or move the device to another location. If you notice that this device causes interference in low-voltage RFID tracing systems, contact a FUJIFILM representative.



This sticker indicates that this device operates in the 2.4 GHz band using DSSS and OFDM modulation and may cause interference at distances of up to 40 m.

About This Manual

Before using the camera, read this manual and the warnings in “For Your Safety” (📖 ii). For information on specific topics, consult the sources below.

Table of Contents 📖 **xiii**

The “Table of Contents” gives an overview of the entire manual. The principal camera operations are listed here.

Troubleshooting 📖 **132**

Having a specific problem with the camera? Find the answer here.

Warning Messages and Displays 📖 **137**

Find out what’s behind that flashing icon or error message in the display.

Restrictions on Camera Settings..... 📖 **148**

See page 148 for restrictions on the options available in each shooting mode.

Memory Cards

Pictures are stored on optional SD, SDHC, and SDXC memory cards (📖 19), referred to in this manual as “memory cards.”

Product Care

Camera body: For continued enjoyment of your camera, use a soft, dry cloth to clean the camera body after each use. Do not use alcohol, thinner, or other volatile chemicals, which could discolor or deform the leather on the camera body. Any liquid on the camera should be removed immediately with a soft, dry cloth. Use a blower to remove dust from the monitor, taking care to avoid scratches, and then gently wipe with a soft, dry cloth. Any remaining stains can be removed by wiping gently with a piece of FUJIFILM lens-cleaning paper to which a small amount of lens-cleaning fluid has been applied. To prevent dust entering the camera, replace the body cap when no lens is in place.

Image sensor: Dust can be removed from the image sensor using the  **SENSOR CLEANING** option in the setup menu ( 107).

Interchangeable lenses: Use a blower to remove dust, then gently wipe with a soft, dry cloth. Any remaining stains can be removed by wiping gently with a piece of FUJIFILM lens-cleaning paper to which a small amount of lens-cleaning fluid has been applied. Replace the front and rear caps when the lens is not use.

Table of Contents

For Your Safety.....	ii
IMPORTANT SAFETY INSTRUCTIONS.....	ii
Safety Notes.....	iii
NOTICES.....	vi
Safety Notes.....	viii
About This Manual.....	x
Product Care.....	xi
Before You Begin	
Symbols and Conventions.....	1
Supplied Accessories.....	1
Parts of the Camera.....	2
The Selector.....	5
The Command Dial.....	5
Camera Displays.....	6
Shooting: Viewfinder/LCD Monitor.....	6
Playback.....	8
Lenses.....	9
Parts of the Lens.....	9
Removing the Caps.....	9
Attaching the Hood.....	9
Lenses with Aperture Rings.....	10
Lenses with No Aperture Rings.....	10
Lenses with O.I.S. Switches.....	11
Manual Focus Lenses.....	11

First Steps









































Attaching the Strap.....	12
Attaching a Lens.....	14
Charging the Battery.....	15
Inserting the Battery and a Memory Card.....	16
Compatible Memory Cards.....	19
Turning the Camera on and Off.....	20
Basic Setup.....	21
Changing Basic Settings.....	22
Choosing a Display.....	23
The Viewfinder Display.....	24
Focusing the Viewfinder.....	24
Adjusting Display Brightness.....	24
The DISP/BACK Button.....	25
Viewfinder: Shooting.....	25
LCD Monitor: Shooting.....	25
Customizing the Standard Display.....	26
Viewfinder/LCD Monitor: Playback.....	27

Basic Photography and Playback		More on Photography and Playback	
Taking Photographs.....	28	Mode Selection.....	45
Viewing Pictures.....	30	P, S, A, and M Modes.....	45
Viewing Pictures Full Frame.....	30	Program AE (P).....	46
Viewing Photo Information.....	31	Shutter-Priority AE (S).....	47
Playback Zoom.....	32	Aperture-Priority AE (A).....	48
Multi-Frame Playback.....	33	Manual Exposure (M).....	49
Deleting Pictures.....	34	Long Time-Exposures (T/B).....	50
Using the Flash.....	35	Time (T).....	50
Basic Movie Recording and Playback		Bulb (B).....	50
Recording Movies.....	37	Using a Remote Release.....	51
Using an External Microphone.....	38	Exposure Compensation.....	52
Viewing Movies.....	39	Focus/Exposure Lock.....	53
The Q (Quick Menu) Button		Metering.....	55
Using the Q Button.....	40	Film Simulation.....	56
The Quick Menu Display.....	40	The DRIVE Button.....	57
Viewing and Changing Settings.....	41	Continuous Shooting (Burst Mode).....	58
Editing the Quick Menu.....	42	Bracketing.....	59
The Fn (Function) Buttons		Panoramas.....	60
Using the Function Buttons.....	43	Viewing Panoramas.....	62
Assigning Roles to the Function Buttons.....	44	Multiple Exposures.....	63
		Advanced Filter.....	64

Focus Mode	65
The Focus Indicator	66
MF Assist	67
Autofocus Options (AF Mode)	68
Focus-Point Selection	69
Single Point AF	69
Zone AF	70
Tracking (Focus Mode C Only)	71
Sensitivity	72
AUTO	73
Recording Pictures in RAW Format	74
Creating JPEG Copies of RAW Pictures	75
Using the Self-Timer	76
Interval Timer Photography	78
White Balance	79
Saving Settings	81
Using a Mount Adapter	82
Mount Adapter Settings	82
Choosing a Focal Length	82
Distortion Correction	82
Color Shading Correction	83
Peripheral Illumination Correction	83
PhotoBook Assist	84
Creating a PhotoBook	84
Viewing Photobooks	85
Editing and Deleting Photobooks	85
Image Search	86

Menus

Using the Menus: Shooting Mode	87
Shooting Menu Options (Photographs)	87
ADVANCED FILTER	87
AUTOFOCUS SETTING	87
ISO	89
IMAGE SIZE	90
IMAGE QUALITY	90
DYNAMIC RANGE	90
FILM SIMULATION	90
SELF-TIMER	90
INTERVAL TIMER SHOOTING	91
WHITE BALANCE	91
COLOR	91
SHARPNESS	91
HIGHLIGHT TONE	91
SHADOW TONE	91
NOISE REDUCTION	91
LONG EXPOSURE NR	91
LENS MODULATION OPTIMIZER	91
SELECT CUSTOM SETTING	91
EDIT/SAVE CUSTOM SETTING	91
MOUNT ADAPTOR SETTING	92
SHOOT WITHOUT LENS	92
MF ASSIST	92
AE/AF-LOCK MODE	92
AF-LOCK BUTTON	92

 PHOTOMETRY	92	The Setup Menu	102
 INTERLOCK SPOT AE & FOCUS AREA	92	Using the Setup Menu	102
 FLASH SET-UP	93	Setup Menu Options	103
 MOVIE SET-UP	93	 DATE/TIME	103
 FILM SIMULATION BKT	94	 TIME DIFFERENCE	103
 IS MODE	94	 言語/LANG	103
 WIRELESS COMMUNICATION	94	 RESET	103
 APERTURE SETTING	94	 SOUND & FLASH	103
 SHUTTER TYPE	95	 SOUND SET-UP	104
Using the Menus: Playback Mode	96	 SCREEN SET-UP	104
Playback Menu Options	96	 BUTTON/DIAL SETTING	106
 WIRELESS COMMUNICATION	96	 FOCUS RING	106
 RAW CONVERSION	96	 POWER MANAGEMENT	106
 ERASE	96	 SENSOR CLEANING	107
 CROP	97	 SAVE DATA SET-UP	107
 RESIZE	97	 COLOR SPACE	108
 PROTECT	98	 EVF/LCD SETTING	108
 IMAGE ROTATE	98	 CONNECTION SETTING	109
 RED EYE REMOVAL	99	 FORMAT	110
 SLIDE SHOW	99	Factory Defaults	111
 PHOTOBOOK ASSIST	100		
 MARK FOR UPLOAD TO	100		
 IMAGE SEARCH	100		
 PC AUTO SAVE	101		
 PRINT ORDER (DPOF)	101		
 instax PRINTER PRINT	101		
 DISP ASPECT	101		

Connections		Technical Notes	
Wireless Transfer	114	Optional Accessories	126
Wireless Connections: Smartphones	114	Accessories from FUJIFILM.....	126
Wireless Connections: Computers	114	Connecting the Camera to Other Devices.....	129
Viewing Pictures on a Computer	115	Caring for the Camera	130
Windows.....	115	Storage and Use	130
Macintosh	115	Traveling.....	130
Connecting the Camera	116	Cleaning the Image Sensor	131
Printing Pictures via USB	118	Troubleshooting	
Connecting the Camera	118	Problems and Solutions	132
Printing Selected Pictures	118	Warning Messages and Displays	137
Printing the DPOF Print Order	119	Appendix	
Creating a DPOF Print Order.....	120	Memory Card Capacity	140
WITH DATE  /WITHOUT DATE	121	Links	141
RESET ALL.....	122	FUJIFILM X-E2 Product Information	141
instax SHARE Printers	123	Firmware Updates	141
Establishing a Connection.....	123	Free FUJIFILM Apps.....	141
Printing Pictures	124	Specifications	142
Viewing Pictures on TV	125	Restrictions on Camera Settings	148

Before You Begin

Symbols and Conventions

The following symbols are used in this manual:

- ⓘ This information should be read before use to ensure correct operation.
- ◆ Additional information that may be helpful when using the camera.
- 📖 Other pages in this manual on which related information may be found.

Menus and other text in the displays are shown in **bold**. In the illustrations in this manual, displays may be simplified for explanatory purposes.

Supplied Accessories

The following items are included with the camera:



NP-W126 rechargeable battery

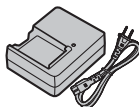

BC-W126 battery charger

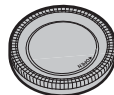

Body cap



CD-ROM



Clip attaching tool



Metal strap clips (x2)

- Owner's Manual (*this manual*)
- Shoulder strap
- Protective covers (x 2)

- ◆ If you purchased a lens kit, check that a lens is included.

Parts of the Camera

For more information, refer to the page listed to the right of each item.

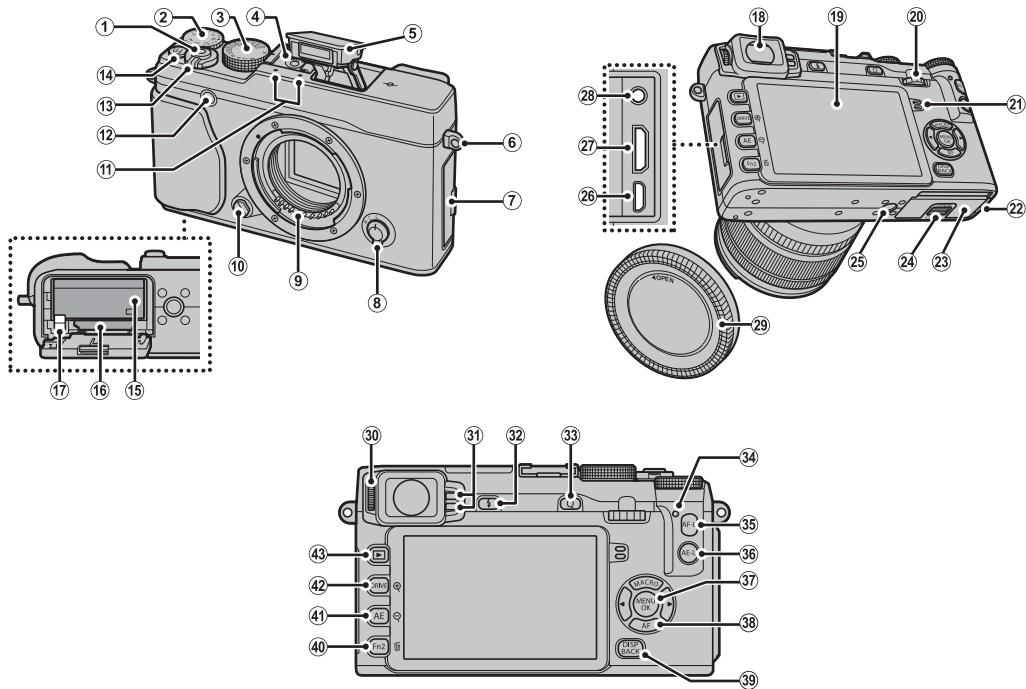

① Shutter button	29	⑲ LCD monitor	6, 23, 25	⑳ MENU/OK button	87, 96, 102
② Exposure compensation dial	52	㉑ Command dial.....	5	㉒ (control lock) button (press and hold).....	4
③ Shutter speed dial	46, 47, 48, 49	㉒ Speaker	39	㉓ Function button (Fn3—Fn6).....	43
④ Hot shoe.....	36, 129	㉔ Cable channel cover for DC coupler		Selector	5
⑤ Flash	35	㉕ Battery-chamber cover	16	㉔ DISP (display)/BACK button.....	25
⑥ Strap eyelet.....	12	㉖ Battery-chamber cover latch.....	16	㉕ Function button (Fn2)	43
⑦ Connector cover	38, 51, 116, 118, 125	㉗ Tripod mount		White balance button	79
⑧ Focus mode selector.....	28, 65	㉘ Micro USB connector	51, 116, 118	⏏ (delete) button (playback mode).....	34
⑨ Lens signal contacts	9	㉙ HDMI mini connector	125	㉕ Function button (Fn1)	43
⑩ Lens release button	14	㉚ Microphone/remote release connector	38, 51	AE (autoexposure) button.....	55
⑪ Microphone.....	37	㉛ Body cap	14	⏏ (playback zoom out) button.....	32, 33
⑫ AF-assist illuminator	89	㉜ Diopter adjustment control	24	㉖ DRIVE button	57, 58, 59, 60, 63, 64
Self-timer lamp.....	76	㉝ Eye sensor	23	⏏ (playback zoom in) button	32, 33
⑬ ON/OFF switch	20	㉞ ⚡ (flash pop-up) button.....	35	㉗ (playback) button.....	30
⑭ Function button (Fn7)	43	㉟ Q (quick menu) button*	40		
Movie-record button	37	Quick menu edit/custom settings button			
Wi-Fi button (playback mode).....	114	(press and hold)*	42, 81		
⑮ Battery chamber	16	RAW conversion button (playback mode)	75		
⑯ Memory card slot	17	㉜ Indicator lamp.....	4		
⑰ Battery latch	16	㉝ AF-L (focus lock) button.....	53, 65, 92, 106		
⑱ Electronic viewfinder (EVF)	6, 23, 25	㉞ AE-L (exposure lock) button.....	53, 92, 106		

* In shooting mode, press and release to display quick menu or press and hold to display quick menu edit options. When quick menu is displayed, press and hold to edit custom settings.

The Indicator Lamp

The indicator lamp shows camera status as follows:

Indicator lamp	Camera status
Glows green	Focus locked.
Blinks green	Blur, focus, or exposure warning. Picture can be taken.
Blinks green and orange	Recording pictures. Additional pictures can be taken.
Glows orange	Recording pictures. No additional pictures can be taken at this time.
Blinks orange	Flash charging; flash will not fire when picture is taken.
Blinks red	Lens or memory error.

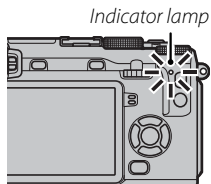





- ❖ Warnings may also appear in the display (📖 137).
- ❖ The indicator lamp remains off while the viewfinder is in use (📖 23).

Control Lock

To prevent accidental operation of the selector and **AE-L** and **AF-L** buttons during shooting, press **MENU/OK** until  is displayed. The controls can be unlocked by pressing **MENU/OK** until  is no longer displayed.

The Selector



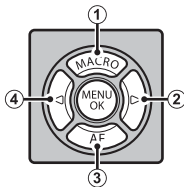

Press the selector up (①), right (③), down (④), or left (②) to highlight items. The up, left, right, and down buttons also double as the **Fn3** (AF mode;  68), **Fn4** (film simulation;  56), **Fn5** (flash mode;  35), and **Fn6/AF** (focus-frame selection;  69) buttons, respectively ( 43).



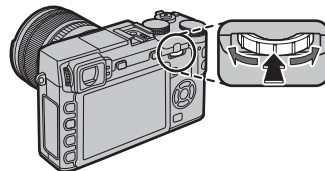

- ① Macro mode is now selected automatically as required, with the result that macro mode selection option that could formerly be assigned to the function buttons (default **Fn3**) has been replaced by AF mode selection.

The Command Dial



Rotate the command dial to select options in the quick menu display ( 41), view pictures ( 30), adjust the size of the focus area ( 69), or choose a shutter speed ( 10, 45, 47, 49, 50) or combination of shutter speed and aperture (program shift,  46).

Press the center of the command dial to zoom in on the active focus area during shooting ( 66) or playback ( 31), or press and hold the center of the command dial to choose a manual focus assist option ( 67).

Camera Displays

The following types of indicator may be displayed during shooting and playback. In the description that follows, all available indicators are shown for illustrative purposes; the indicators actually displayed vary with camera settings. Note that the LCD monitor and electronic viewfinder have different aspect ratios.

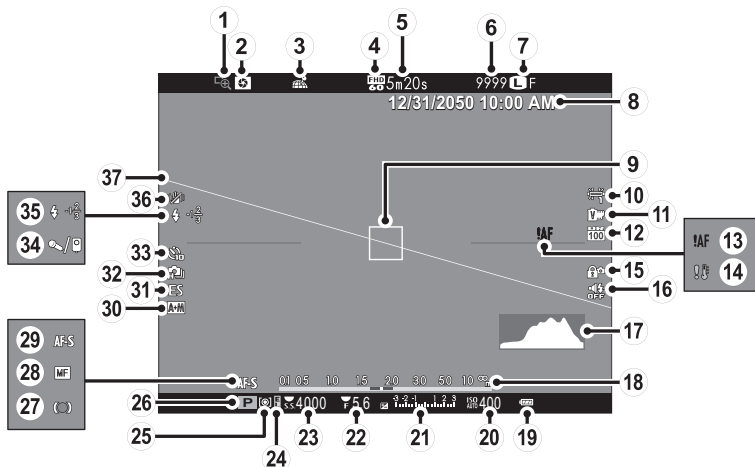
■ Shooting: Viewfinder/LCD Monitor

① Focus check.....	66	⑭ Temperature warning.....	139	⑳ Shooting mode.....	45
② Depth-of-field preview.....	48	⑮ Control lock.....	4	㉑ Focus indicator.....	66
③ Location data download status.....	109, 114	⑯ Sound and flash indicator.....	103	㉒ Manual focus indicator.....	66
④ Movie mode.....	93	⑰ Histogram.....	27	㉓ Focus mode.....	65
⑤ Time remaining.....	37	⑱ Distance indicator.....	65	㉔ AF+MF indicator.....	88
⑥ Number of available frames *.....	140	⑲ Battery level.....	20	㉕ Shutter type.....	95
⑦ Image quality and size.....	90	㉚ Sensitivity.....	72	㉖ Continuous mode.....	58
⑧ Date and time.....	21, 22	㉛ Exposure compensation/exposure indicator.....	49, 52	㉗ Self-timer indicator.....	76
⑨ Focus frame.....	53	㉜ Aperture.....	46, 48, 49	㉘ Microphone/remote release.....	38, 51, 93
⑩ White balance.....	79	㉝ Shutter speed.....	46, 47, 49	㉙ Flash mode.....	35
⑪ Film simulation.....	56	㉞ AE lock indicator.....	53	㉚ Flash compensation.....	93
⑫ Dynamic range.....	90	㉟ Metering.....	55	㉛ IS Mode.....	94
⑬ Focus warning.....	4, 134, 137			㉜ Virtual horizon.....	27

* Shows "9999" if there is space for over 9999 frames.

Control Lock



Pressing a locked control (🗨️ 4) displays a  icon.

■ Playback

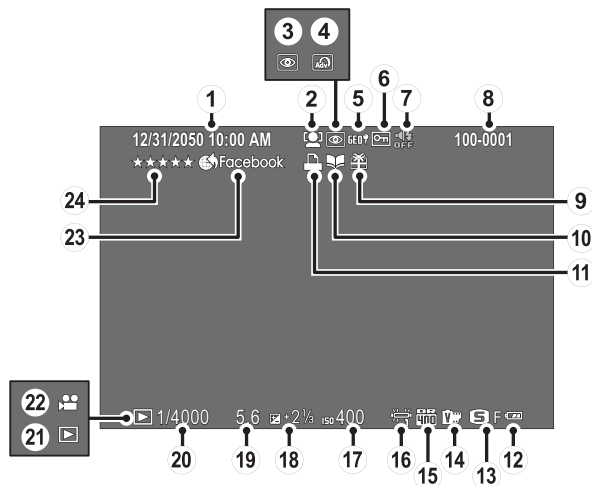

① Date and time.....	21, 22	⑨ Gift image.....	30	⑰ Sensitivity.....	72
② Intelligent face detection indicator.....	88	⑩ Photobook assist indicator.....	84	⑱ Exposure compensation.....	52
③ Red-eye removal indicator.....	93, 99	⑪ DPOF print indicator.....	120	⑲ Aperture.....	46, 48, 49
④ Advanced filter.....	64	⑫ Battery level.....	20	⑳ Shutter speed.....	46, 47, 49
⑤ Location data.....	109	⑬ Image quality and size.....	90	㉑ Playback mode indicator.....	30
⑥ Protected image.....	98	⑭ Film simulation.....	56	㉒ Movie icon.....	39
⑦ Sound and flash indicator.....	103	⑮ Dynamic range.....	90	㉓ Mark for upload to.....	100
⑧ Frame number.....	107	⑯ White balance.....	79	㉔ Rating.....	30

Lenses

The camera can be used with lenses for the FUJIFILM X-mount.

Parts of the Lens

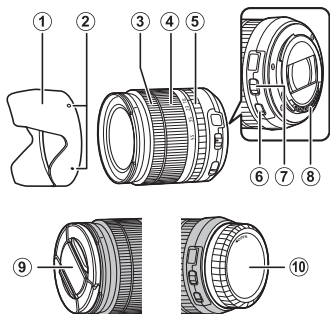

- ① Lens hood
- ② Mounting marks
- ③ Focus ring
- ④ Zoom ring
- ⑤ Aperture ring
- ⑥ O.I.S. switch
- ⑦ Aperture mode switch
- ⑧ Lens signal contacts
- ⑨ Front lens cap
- ⑩ Rear lens cap

Removing the Caps

Remove the caps as shown.

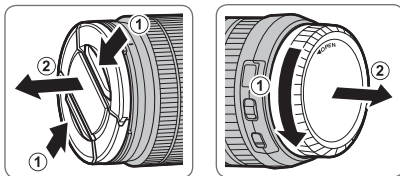

- ① Lens caps may differ from those shown.

Attaching the Hood

When attached, lens hoods reduce glare and protect the front lens element.

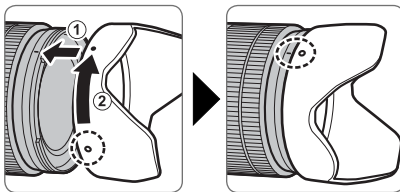

Lenses with Aperture Rings

At settings other than **A**, you can adjust aperture by rotating the lens aperture ring (exposure modes **A** and **M**).

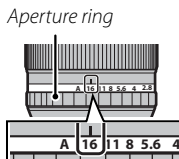
**The Aperture Mode Switch**

If the lens has an aperture mode switch, aperture can be adjusted manually by sliding the switch to **S** and rotating the aperture ring.

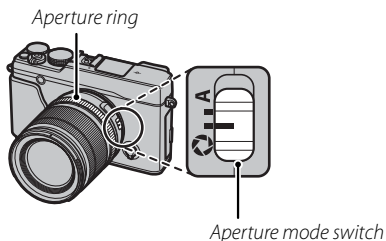
**Lenses with No Aperture Rings**

The method used to adjust aperture can be selected using the **APERTURE SETTING** option (📖 94) in the shooting menu. When an option other than **AUTO** is selected, aperture can be adjusted using the command dial.

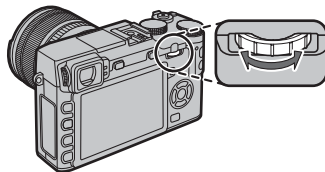

- ❖ Selecting **S.S** for **COMMAND DIAL SETTING** > **COMMAND DIAL SETTING** (📖 106) allows the command dial to be used to choose the shutter speed (📖 45, 47, 49, 95), the exposure time for long time-exposures when the shutter-speed dial is rotated to **T** (time) (📖 50), or, in program AE mode (mode **P**), different combinations of shutter speed and aperture (program shift, 📖 46).
- ❖ Assigning **COMMAND DIAL SETTING** to a function button makes it easy to switch between shutter speed and aperture (📖 44).

Lenses with O.I.S. Switches

If the lens supports optical image stabilization (O.I.S.), the image stabilization mode can be chosen in the camera menus. To activate image stabilization, slide the switch to **ON**.

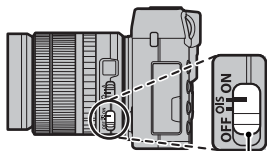

O.I.S. switch

Manual Focus Lenses

Slide the focus ring to the front for autofocus.



For manual focus, slide the focus ring to the back and rotate it while checking the results in the camera display. The focus distance and depth-of-field indicators can be used to assist manual focus. Note that manual focus may not be available in all shooting modes.

Before You Begin

● The Depth-of-Field Indicator

The depth-of-field indicator shows the approximate depth of field (the distance in front of and behind the focus point that appears to be in focus).

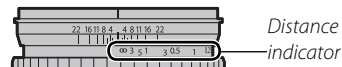

ⓘ The camera does not display the focus distance when the lens is in manual focus mode.

First Steps

Attaching the Strap

Attach the strap clips to the camera and then attach the strap.

1 Open a strap clip.

Use the clip attaching tool to open a strap clip, making sure that the tool and clip are in the orientations shown.

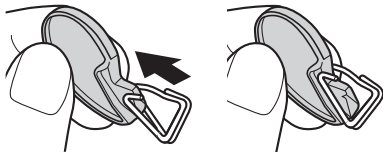

① Keep the tool in a safe place. You will need it to open the strap clips when removing the strap.

2 Place the strap clip on an eyelet.

Hook the strap eyelet in the clip opening. Remove the tool, using the other hand to keep the clip in place.

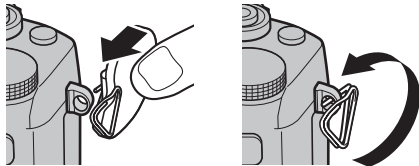

3 Pass the clip through the eyelet.

Rotate the clip fully through the eyelet until it clicks closed.

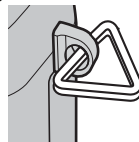

4 Attach a protective cover.

Place a protective cover over the eyelet as shown, with the black side of the cover toward the camera. Repeat Steps 1–4 for the second eyelet.

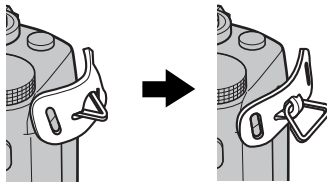

5 Insert the strap.

Insert the strap through a protective cover and strap clip.

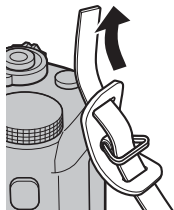
**6 Fasten the strap.**

Fasten the strap as shown. Repeat Steps 5–6 for the second eyelet.

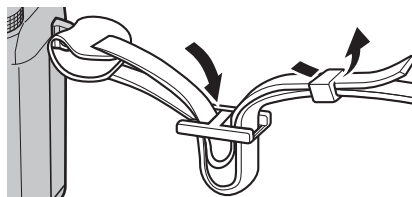

- ⓘ To avoid dropping the camera, be sure the strap is correctly secured.

Attaching a Lens

Lenses attach as described below.

① Care is required to prevent dust entering the camera while attaching and removing lenses.

1 Remove the body and rear caps.

Remove the body cap from the camera and the rear cap from the lens.

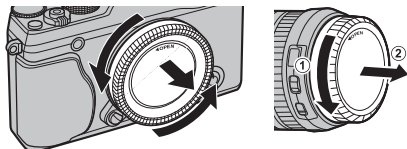

① Do not touch the camera's internal parts.

2 Attach the lens.

Place the lens on mount, keeping the marks on the lens and camera aligned, and then rotate the lens until it clicks into place.

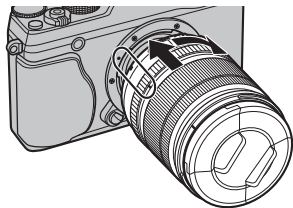

① Do not press the lens release button while attaching the lens.

Removing Lenses

To remove the lens, turn the camera off, then press the lens release button and rotate the lens as shown.

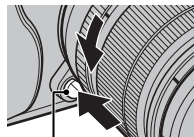

Lens release button

① To prevent dust accumulating on the lens or inside the camera, replace the lens caps and camera body cap when the lens is not attached.

Lenses and Other Optional Accessories

The camera can be used with lenses for the FUJIFILM X-mount and the other accessories listed from page 126.

Charging the Battery

The battery is not charged at shipment. Before use, charge the battery in the supplied battery charger.

1 Place the battery in the charger.

Place the battery in the supplied battery charger as shown.

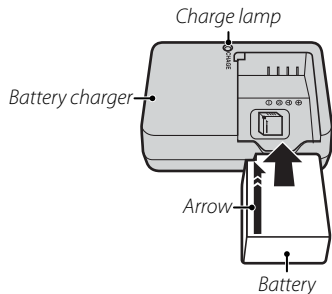

The camera uses an NP-W126 rechargeable battery.

- ◆ The supplied AC cord is for use exclusively with the supplied battery charger. Do not use the supplied charger with other cords or the supplied cord with other devices.

2 Plug the charger in.

Plug the charger into an indoor power outlet. The charging indicator will light.

The Charging Indicator

The charging indicator shows battery charge status as follows:

Charging indicator	Battery status	Action
Off	Battery not inserted.	Insert the battery.
	Battery fully charged.	Remove the battery.
On	Battery charging.	—
Blinks	Battery fault.	Unplug the charger and remove the battery.

3 Charge the battery.

Remove the battery when charging is complete. See the specifications (📖 146) for charging times (note that charging times increase at low temperatures).

- ① Unplug the charger when it is not in use.

Inserting the Battery and a Memory Card

The camera has no internal memory; instead, pictures are stored on optional SD, SDHC, and SDXC memory cards (sold separately). After charging the battery, insert the battery and memory card as described below.

1 Open the battery-chamber cover.

Slide the battery-chamber latch as shown and open the battery-chamber cover.

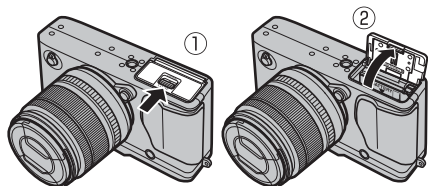

- ① Do not open the battery-chamber cover when the camera is on. Failure to observe this precaution could damage image files or memory cards.
- ① Do not use excessive force when handling the battery-chamber cover.

2 Insert the battery.

Using the battery to keep the battery latch pressed to one side, insert the battery contacts first in the direction shown by the arrow. Confirm that the battery is securely latched.

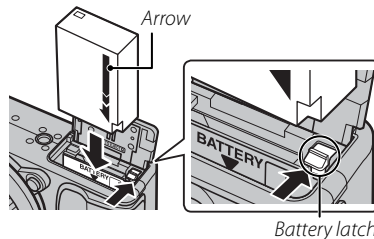

- ① Insert the battery in the correct orientation. **Do not use force or attempt to insert the battery upside down or backwards.** The battery will slide in easily in the correct orientation.

3 Insert the memory card.

Holding the memory card in the orientation shown, slide it in until it clicks into place at the back of the slot.

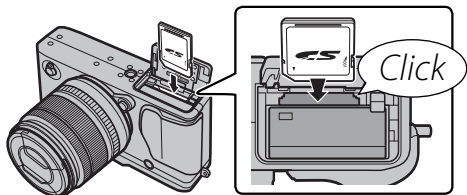

- ① Be sure card is in the correct orientation; do not insert at an angle or use force.
- ① SD/SDHC/SDXC memory cards can be locked, making it impossible to format the card or to record or delete images.

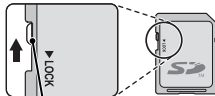

Write-protect switch

Before inserting a memory card, slide the write-protect switch to the unlocked position.

4 Close the battery-chamber cover.

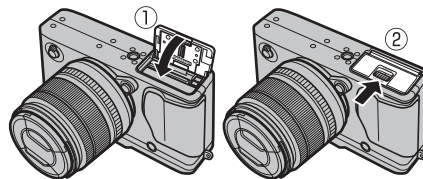

● Removing the Battery and Memory Card

Before removing the battery or memory card, **turn the camera off** and open the battery-chamber cover.

To remove the battery, press the battery latch to the side, and slide the battery out of the camera as shown.

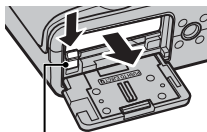

Battery latch

To remove the memory card, press it in and release it slowly. The card can then be removed by hand. When a memory card is removed, the card could be ejected too quickly. Use your finger to hold it and gently release the card.

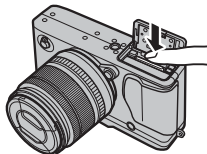

ⓘ Batteries

- Remove dirt from the battery terminals with a clean, dry cloth. Failure to observe this precaution could prevent the battery from charging.
- Do not affix stickers or other objects to the battery. Failure to observe this precaution could make it impossible to remove the battery from the camera.
- Do not short the battery terminals. The battery could overheat.
- Read the cautions in “The Battery and Power Supply” (📖 v).
- Use only battery chargers designated for use with the battery. Failure to observe this precaution could result in product malfunction.
- Do not remove the labels from the battery or attempt to split or peel the outer casing.
- The battery gradually loses its charge when not in use. Charge the battery one or two days before use.

■ Compatible Memory Cards

FUJIFILM and SanDisk SD, SDHC, and SDXC memory cards have been approved for use in the camera. A complete list of approved memory cards is available at http://www.fujifilm.com/support/digital_cameras/compatibility/. Operation is not guaranteed with other cards. The camera can not be used with *xD-Picture Cards* or **MultiMediaCard** (MMC) devices.



ⓘ Memory Cards

- ***Do not turn the camera off or remove the memory card while the memory card is being formatted or data are being recorded to or deleted from the card.*** Failure to observe this precaution could damage the card.
- Format memory cards before first use, and be sure to reformat all memory cards after using them in a computer or other device. For more information on formatting memory cards, see page 110.
- Memory cards are small and can be swallowed; keep out of reach of children. If a child swallows a memory card, seek medical assistance immediately.
- miniSD or microSD adapters that are larger or smaller than the standard dimensions of an SD/SDHC/SDXC card may not eject normally; if the card does not eject, take the camera to an authorized service representative. Do not forcibly remove the card.
- Do not affix labels to memory cards. Peeling labels can cause camera malfunction.
- Movie recording may be interrupted with some types of SD/SDHC/SDXC memory card. Use a **CLASS10** card or better for movies and burst photography.
- Formatting a memory card in the camera creates a folder in which pictures are stored. Do not rename or delete this folder or use a computer or other device to edit, delete, or rename image files. Always use the camera to delete pictures; before editing or renaming files, copy them to a computer and edit or rename the copies, not the originals. Renaming the files on the camera can cause problems during playback.

Turning the Camera on and Off

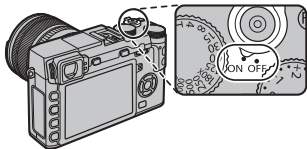



Rotate the **ON/OFF** switch to **ON** to turn the camera on. Select **OFF** to turn the camera off.



- ◆ Press the  button to start playback. Press the shutter button halfway to return to shooting mode.
- ◆ The camera will turn off automatically if no operations are performed for the length of time selected for  **POWER MANAGEMENT > AUTO POWER OFF** (📖 106). To reactivate the camera after it has turned off automatically, press the shutter button halfway or turn the **ON/OFF** switch to **OFF** and then back to **ON**.
- ◆ For information on startup options, see page 106.
- ⓘ Fingerprints and other marks on the lens or viewfinder can affect pictures or the view through the viewfinder. Keep the lens and viewfinder clean.



Battery Level

After turning the camera on, check the battery level in the display.

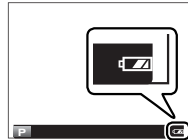
Indicator	Description
 (white)	Battery partially discharged.
 (white)	Battery more than half discharged
 (red)	Low battery. Charge as soon as possible.
 (blinks red)	Battery exhausted. Turn camera off and recharge battery.



Basic Setup

A language-selection dialog is displayed the first time the camera is turned on. Set up the camera as described below (you can reset the clock or change languages at any time using the  **DATE/TIME** or  **言語/LANG.** options in the setup menu; for information on displaying the setup menu, see page 103).

1 Choose a language.



Highlight a language and press **MENU/OK**.

◆ Press **DISP/BACK** to skip the current step. Any steps you skip will be displayed the next time the camera is turned on.



2 Set the date and time.

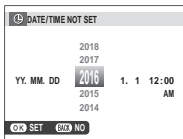

Press the selector left or right to highlight the year, month, day, hour, or minute and press up or down to change. To change the order in which the year, month, and day are displayed, highlight the date format and press the selector up or down. Press **MENU/OK** to exit to shooting mode when settings are complete.





◆ If the battery is removed for an extended period, the camera clock will be reset and the language-selection dialog will be displayed when the camera is turned on.

Changing Basic Settings

To change the language or reset the clock:

1 Display the desired option.

Display the setup menu and select  言語/LANG. to change the language or  DATE/TIME to reset the clock ( 102).

2 Adjust settings.

To choose a language, highlight the desired option and press **MENU/OK**. To set the clock, press the selector left or right to highlight the year, month, day, hour, or minute and press up or down to change, then press **MENU/OK** once the clock has been set to your satisfaction.

Choosing a Display

The camera is equipped with an electronic viewfinder (EVF) and an LCD monitor (LCD). Follow the steps below to choose a display.

1 Display the setup menu.

1.1 Press **MENU/OK** to display the menu for the current mode.



1.2 Press the selector left to highlight the tab for the current menu.



1.3 Press the selector down to highlight the setup menu tab containing **EVF EVF/LCD SETTING**.



1.4 Press the selector right to place the cursor in the setup menu.



2 Select **EVF EVF/LCD SETTING**.



Highlight **EVF EVF/LCD SETTING** and press **MENU/OK**.



3 Choose a display.

Highlight one of the following options and press **MENU/OK**.



Option	Description
 EYE SENSOR	Automatic display selection using eye sensor
LCD	LCD monitor only
EVF	Viewfinder only
EVF ONLY + 	Viewfinder only; eye sensor turns display on or off

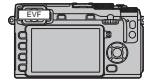
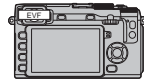
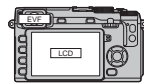

The Eye Sensor

The eye sensor turns the viewfinder on when you put your eye to the viewfinder and turns it off when you take your eye away (note that the eye sensor may respond to objects other than your eye or to light shining directly on the sensor). If automatic display selection is enabled, the LCD monitor will turn on when the viewfinder turns off.

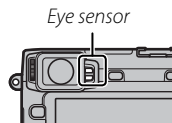

The Viewfinder Display

When **ON** is selected for **SCREEN SET-UP > EVF AUTOROTATE DISPLAYS** in the setup menu (📖 104), the indicators in the viewfinder automatically rotate to match camera orientation.

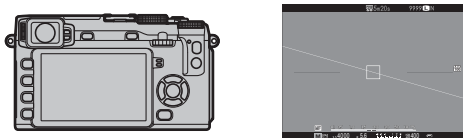

↙ Orientation changed from "wide" to "tall"

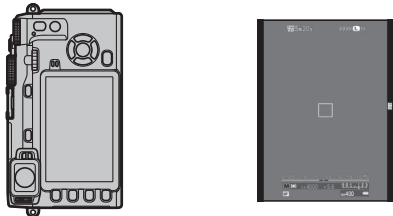

ⓘ The display in the LCD monitor is unaffected.

Focusing the Viewfinder

The camera is equipped with diopter adjustment in the range -4 to $+2\text{ m}^{-1}$ to accommodate individual differences in vision. Rotate the diopter adjustment control until the viewfinder display is in sharp focus.

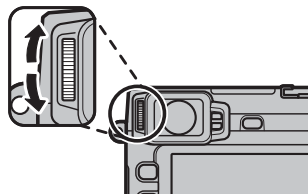

Diopter adjustment control

Adjusting Display Brightness

The brightness of the viewfinder and LCD monitor can be adjusted using the options under **SCREEN SET-UP**. Choose **EVF BRIGHTNESS** to adjust viewfinder brightness (📖 105) or **LCD BRIGHTNESS** to do the same for the LCD monitor (📖 105).

The DISP/BACK Button

The **DISP/BACK** button controls the display of indicators in the viewfinder and LCD monitor.

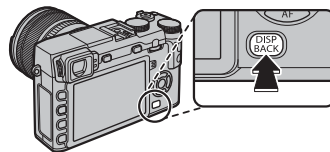

■ Viewfinder: Shooting

Standard

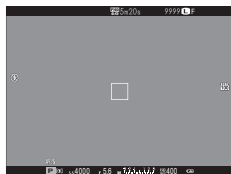

Information off



■ LCD Monitor: Shooting

Standard

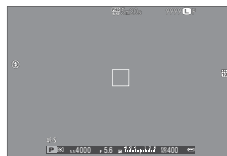

Information off

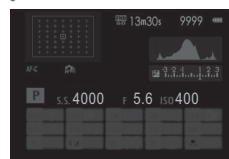

Info display

■ Customizing the Standard Display

To choose the items shown in the standard display:

1 Display standard indicators.

Press the **DISP/BACK** button until standard indicators are displayed.

2 Select **DISP. CUSTOM SETTING**.

Select  **SCREEN SET-UP > DISP. CUSTOM SETTING** in the setup menu.

3 Choose items.

Highlight items and press **MENU/OK** to select or deselect.

- FRAMING GUIDELINE
- ELECTRONIC LEVEL
- FOCUS FRAME
- AF DISTANCE INDICATOR
- MF DISTANCE INDICATOR
- HISTOGRAM
- SHOOTING MODE
- APERTURE/S-SPEED/ISO
- INFORMATION BACKGROUND
- EXPOSURE COMPENSATION
- FOCUS MODE
- PHOTOMETRY
- SHUTTER TYPE
- FLASH
- CONTINUOUS MODE
- DUAL IS MODE
- WHITE BALANCE
- FILM SIMULATION
- DYNAMIC RANGE
- FRAMES REMAINING
- IMAGE SIZE/QUALITY
- MOVIE MODE & REC. TIME
- BATTERY LEVEL

4 Save changes.

Press **DISP/BACK** to save changes.

5 Exit the menus.

Press **DISP/BACK** as needed to exit the menus and return to the shooting display.

◆ See page 6 for the locations of these items in the displays.

Virtual Horizon

Selecting **ELECTRONIC LEVEL** displays a virtual horizon. The camera is level when the two lines overlap.

❖ The virtual horizon may not be displayed if the camera lens is pointed up or down.

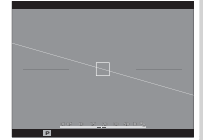

Viewfinder/LCD Monitor: Playback

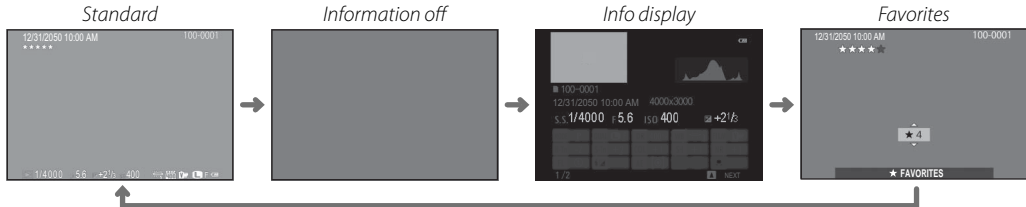

Histograms

Histograms show the distribution of tones in the image. Brightness is shown by the horizontal axis, the number of pixels by the vertical axis.

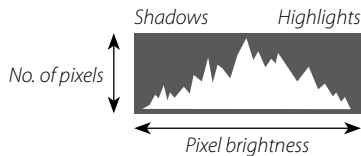

Optimal exposure: Pixels are distributed in an even curve throughout the tone range.



Overexposed: Pixels are clustered on the right side of the graph.



Underexposed: Pixels are clustered on the left side of the graph.





Basic Photography and Playback

Taking Photographs

This section describes how to take pictures using program AE (mode **P**). For information on **S**, **A**, and **M** modes, see page 45.

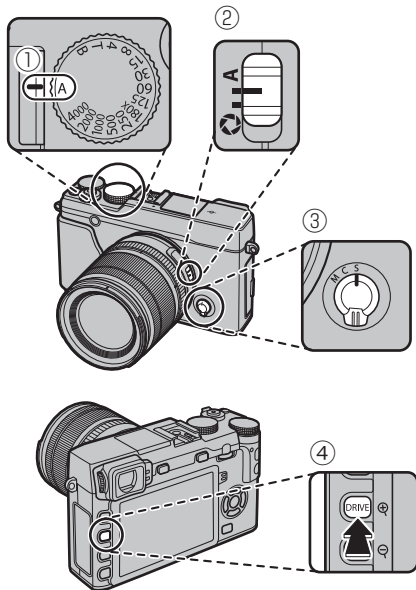
1 Adjust settings for program AE.



- ① **Shutter speed** (📖 46): Select **A** (auto)
- ② **Aperture** (📖 46): Select **A** (auto)
- ③ **Focus mode** (📖 65): Select **S** (single AF)
- ④ **DRIVE mode** (📖 57): Select  (still image)

Confirm that **P** appears in the display.

- 📌 Image stabilization (📖 11) is recommended.



The Q Button

The **Q** button can be used to view and adjust camera settings (📖 40).

2 Ready the camera.

Hold the camera steady with both hands and brace your elbows against your sides. Shaking or unsteady hands can blur your shots.



To prevent pictures that are out of focus or too dark (underexposed), keep your fingers and other objects away from the lens, flash, and AF-assist illuminator.



3 Frame the picture.

Lenses with Zoom Rings

Use the zoom ring to frame the picture in the display.

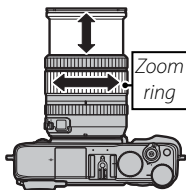

4 Focus.

Frame the picture with your subject in the center of the display and press the shutter button halfway to focus.



❖ If the subject is poorly lit, the AF-assist illuminator may light (📖 89).

If the camera is able to focus, it will beep twice and the focus indicator and area in focus will glow green. Focus and exposure will lock while the shutter button is pressed halfway.

If the camera is unable to focus, the focus frame will turn red, **!AF** will be displayed, and the focus indicator will blink white.

5 Shoot.

Smoothly press the shutter button the rest of the way down to take the picture.



Viewing Pictures

Viewing Pictures Full Frame

Pictures can be viewed in the viewfinder or LCD monitor. When taking important pictures, take a test shot and check the results.

To view pictures full frame, press .

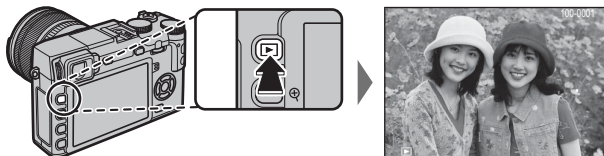

Additional pictures can be viewed by pressing the selector left or right or rotating the command dial. Press the selector or rotate the dial right to view pictures in the order recorded, left to view pictures in reverse order. Keep the selector pressed to scroll rapidly to the desired frame.



- ◆ Pictures taken using other cameras are marked with a  ("gift image") icon to warn that they may not display correctly and that playback zoom may not be available.

Favorites: Rating Pictures

To rate the current picture, press **DISP/BACK** and press the selector up and down to select from zero to five stars.

Viewing Photo Information

The photo information display changes each time the selector is pressed up.

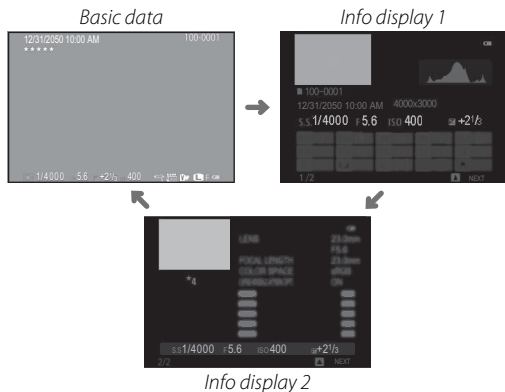

◆ Rotate the command dial to view other images.

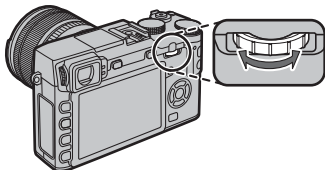



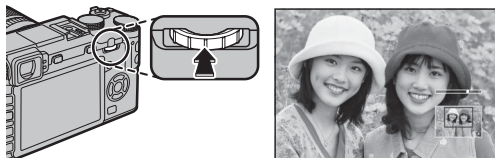

Zooming in on the Focus Point

Press the center of the command dial to zoom in on the focus point. Press the center of the command dial again to return to full-frame playback.



Playback Zoom

Press  to zoom in on the current picture,  to zoom out (to view multiple images, press  when the picture is displayed full frame;  33). When the picture is zoomed in, the selector can be used to view areas of the image not currently visible in the display. Press **DISP/BACK** or **MENU/OK** to exit zoom.

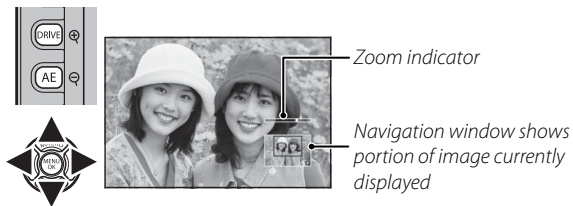



- ◆ The maximum zoom ratio varies with image size ( 90). Playback zoom is not available with cropped or resized copies saved at a size of **640**.

Multi-Frame Playback

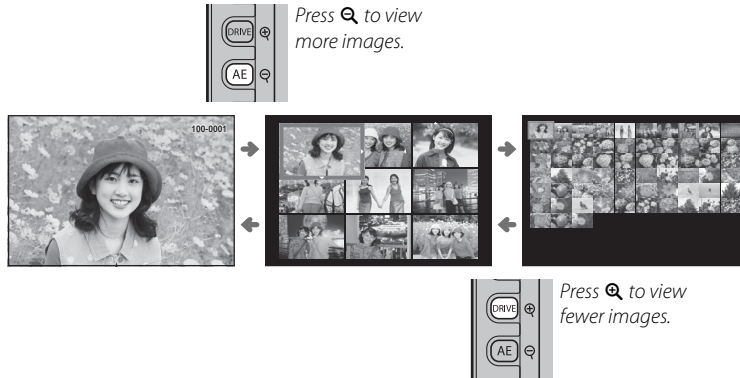
To change the number of images displayed, press  when a picture is displayed full frame.





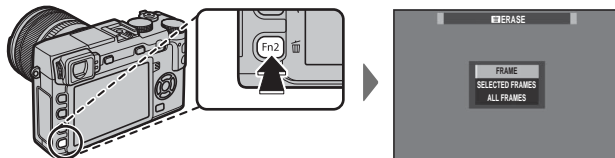

Use the selector to highlight images and press **MENU/OK** to view the highlighted image full frame (to zoom in on the selected image, press  when the picture is displayed full frame;  32). In the nine- and hundred-frame displays, press the selector up or down to view more pictures.

Deleting Pictures

To delete individual pictures, multiple selected pictures, or all pictures, press the  button when a picture is displayed full frame and choose from the options below. *Note that deleted pictures can not be recovered. Copy important pictures to a computer or other storage device before proceeding.*



Option	Description
FRAME	Press the selector left or right to scroll through pictures and press MENU/OK to delete the current picture (a confirmation dialog is not displayed).
SELECTED FRAMES	Highlight pictures and press MENU/OK to select or deselect (pictures in photobooks or print orders are shown by ). When the operation is complete, press DISP/BACK to display a confirmation dialog, then highlight OK and press MENU/OK to delete the selected pictures.
ALL FRAMES	A confirmation dialog will be displayed; highlight OK and press MENU/OK to delete all unprotected pictures. Pressing DISP/BACK cancels deletion; note that any pictures deleted before the button was pressed can not be recovered.

-  Protected pictures can not be deleted. Remove protection from any pictures you wish to delete (📖 98).
-  Pictures can also be deleted by  **ERASE** from playback menu.
-  If a message appears stating that the selected images are part of a DPOF print order, press **MENU/OK** to delete the pictures.

Using the Flash

Use the built-in flash for additional lighting when shooting at night or indoors under low light.





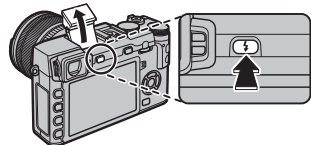



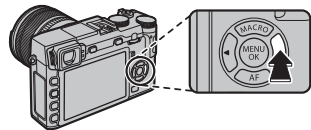

1 Press the  button to raise the flash.

- ① The flash may contact accessories mounted on the hot shoe. If necessary, remove accessories before raising the flash.



2 Press the function button (**Fn5**) to display the following options, then use the selector to highlight an option and press **MENU/OK** to select.



Mode	Description
 AUTO (AUTO FLASH)/  (RED EYE REDUCTION)*	The flash fires when required. Recommended in most situations.
 (FORCED FLASH)/  (FORCED FLASH)*	The flash fires whenever a picture is taken. Use for backlit subjects or for natural coloration when shooting in bright light.
 SLOW (SLOW SYNCHRO)/  (RED EYE & SLOW)*	Capture both the main subject and the background under low light (note that brightly lit scenes may be overexposed).
 REDR (2ND CURTAIN SYNC.)/  (2ND CURTAIN SYNC.)*	The flash fires immediately before the shutter closes.
 COMMANDER	The built-in flash can be used to control optional remote flash units.
 (SUPPRESSED FLASH)	The flash does not fire even when the subject is poorly lit. A tripod is recommended.

* Red-eye removal is available in these modes when Intelligent Face Detection is active (🗨 88) and red-eye removal is on (🗨 93). Red-eye removal minimizes “red-eye” caused when light from the flash is reflected from the subject’s retinas as shown in the illustration at right.



- ① Depending on the distance to the subject, some lenses may cast shadows in photos taken with the flash.
- 🔍 Lowering the flash turns the flash off (🔒) and prevents it firing even when the subject is poorly lit; use of a tripod is recommended. Lower the flash where flash photography is prohibited or to capture natural lighting under dim light. We also recommend that you lower the flash when the camera is off.
- 🔍 If 📷 is displayed when the shutter button is pressed halfway, the flash will fire when the photo is taken.
- 🔍 Except in commander mode, the flash may fire several times with each shot. Do not move the camera until shooting is complete.

Flash Sync Speed

The flash will synchronize with the shutter at shutter speeds of $\frac{1}{180}$ s or slower.

Optional Flash Units

The camera can also be used with optional FUJIFILM shoe-mounted flash units. Do not use third-party flash units that apply over 300V to the camera hot shoe.

Basic Movie Recording and Playback

Recording Movies

The camera can be used to record short high-definition movies. Sound is recorded in stereo via the built-in microphone; do not cover the microphone during recording.

- 1 Press the function button (**Fn7/Fn**) to start recording.

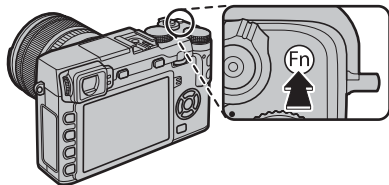

Recording indicator

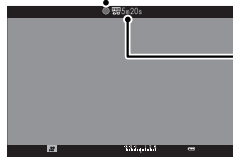

Time remaining

- 2 Press the button again to end recording. Recording ends automatically when the maximum length is reached or the memory card is full.

- ◆ Zoom can be adjusted while recording is in progress.
- ◆ Sensitivity and frame size and rate can be selected using the **MOVIE SET-UP** option (93). Focus mode is selected using the focus mode selector (65); for continuous focus adjustment, select **C**, or choose **S** and enable Intelligent Face Detection (88). Intelligent Face Detection is not available in focus mode **M**.
- ◆ During recording, exposure compensation can be adjusted by up to ± 2 EV.
- ◆ The indicator lamp lights while movies are being recorded.
- ⓘ The microphone may pick up lens noise and other sounds made by the camera during recording.
- ⓘ Vertical or horizontal streaks may appear in movies containing very bright subjects. This is normal and does not indicate a malfunction.

Depth of Field

Adjust aperture before recording begins. Choose low f-numbers to soften background details.

Using an External Microphone

Sound can be recorded with external microphones that connect using jacks 2.5 mm in diameter; microphones that require bus power can not be used. See the microphone manual for details.

- ◆ The dialog shown at right will be displayed when a microphone is connected to the microphone/remote release connector. Press **MENU/OK** and select **MIC/REMOTE RELEASE >**
🎤 **MIC.**

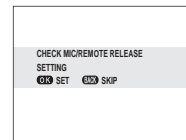
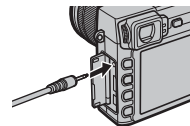

Viewing Movies

During playback, movies are displayed as shown at right. The following operations can be performed while a movie is displayed:

Operation	Description
Start/pause playback	Press the selector down to start playback. Press again to pause. While playback is paused, you can press the selector left or right to rewind or advance one frame at a time.
End playback	Press the selector up to end playback.
Adjust speed	Press the selector left or right to adjust playback speed during playback.
Adjust volume	Press MENU/OK to pause playback and display volume controls. Press the selector up or down to adjust the volume; press MENU/OK again to resume playback. Volume can also be adjusted using ▶ SOUND SET-UP > PLAYBACK VOLUME (📖 104).



Movie icon

Progress is shown in the display during playback.

- ⓘ Do not cover the speaker during playback.
- ⓘ Sound is not played back if **OFF** is selected for **🔊 SOUND & FLASH** (📖 103).

Progress bar



Playback Speed

Press the selector left or right to adjust playback speed during playback. Speed is shown by the number of arrows (▶ or ◀).

Arrow

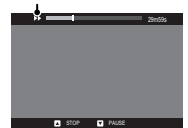

The Q (Quick Menu) Button

Using the Q Button

Press **Q** for quick access to selected options.

The Quick Menu Display

At default settings, the quick menu contains the following items.

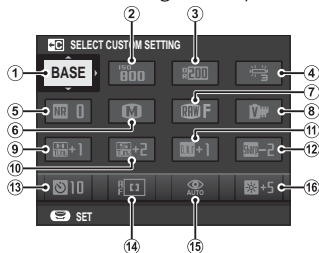

①	SELECT CUSTOM SETTING.....	81	⑨	HIGHLIGHT TONE	91
②	ISO	72	⑩	SHADOW TONE	91
③	DYNAMIC RANGE	90	⑪	COLOR	91
④	WHITE BALANCE	79	⑫	SHARPNESS	91
⑤	NOISE REDUCTION	91	⑬	SELF-TIMER	76
⑥	IMAGE SIZE	90	⑭	AF MODE	68
⑦	IMAGE QUALITY	90	⑮	FLASH MODE	35
⑧	FILM SIMULATION	56	⑯	EVF/LCD BRIGHTNESS.....	105

❖ CUSTOM and COLOR TEMPERATURE white balance options can not be accessed using the **Q** button. Use a function button or the shooting menu.

The quick menu shows the options currently selected for items ②—⑯, which can be changed as described on page 42. The SELECT CUSTOM SETTING item (item ①) shows the current custom settings bank:

- **BASE**: No custom settings bank selected.
- **C1 — C7**: Select a bank to view the settings saved using the EDIT/SAVE CUSTOM SETTING option in the shooting menu (📖 91).

Viewing and Changing Settings

1 Press **Q** to display the quick menu during shooting.

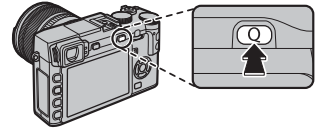

2 Use the selector to highlight items and rotate the command dial to change.



3 Press **Q** to exit when settings are complete.

Editing the Quick Menu

To choose the items displayed in the quick menu:

- 1 Press and hold the **Q** button during shooting.

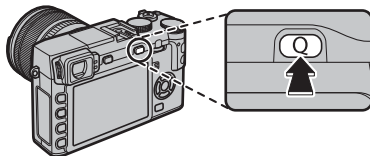

- 2 The current quick menu will be displayed; use the selector to highlight the item you wish to change and press **MENU/OK**. You will be given the following choice of items to assign to the selected position:

- SELECT CUSTOM SETTING
- ISO
- DYNAMIC RANGE
- WHITE BALANCE
- NOISE REDUCTION
- IMAGE SIZE
- IMAGE QUALITY
- FILM SIMULATION
- HIGHLIGHT TONE
- SHADOW TONE
- COLOR
- SHARPNESS
- SELF-TIMER
- FACE DETECTION
- PHOTOMETRY
- AF MODE
- FLASH MODE
- FLASH COMPENSATION
- IS MODE
- MF ASSIST
- MOVIE MODE
- MOVIE ISO
- MIC LEVEL ADJUSTMENT
- SOUND & FLASH
- EVF/LCD BRIGHTNESS
- SHUTTERTYPE
- NONE

- ◆ Select **NONE** to assign no option to the selected position. When **SELECT CUSTOM SETTING** is selected, current settings are shown in the quick menu by the label **BASE**.

- 3 Highlight the desired item and press **MENU/OK** to assign it to the selected position.

- ◆ The quick menu can also be edited using the **DISC/BUTTON/DIAL SETTING > EDIT/SAVE QUICK MENU** option in the setup menu (📖 106).

The Fn (Function) Buttons

Using the Function Buttons

The roles played by each of the function buttons can be selected by pressing and holding the button. The default options are shown below:

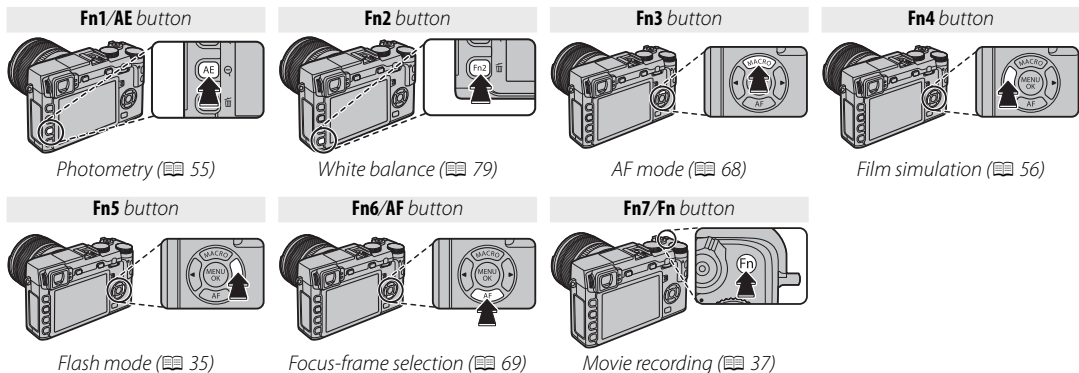

- ① Macro mode is now selected automatically as required, with the result that macro mode selection option that could formerly be assigned to the function buttons (default **Fn3**) has been replaced by AF mode selection.

Assigning Roles to the Function Buttons

To assign roles to the function buttons, press and hold the **DISP/BACK** button until the menu below is displayed. Select buttons to choose their roles.

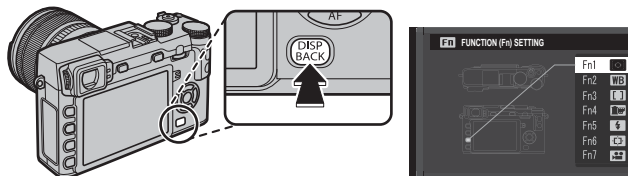

- PREVIEW DEPTH OF FIELD (📖 48)
 - ISO (📖 72)
 - SELF-TIMER (📖 76)
 - IMAGE SIZE (📖 90)
 - IMAGE QUALITY (📖 90)
 - DYNAMIC RANGE (📖 90)
 - FILM SIMULATION (📖 56)
 - WHITE BALANCE (📖 79)
 - PHOTOMETRY (📖 55)
 - AF MODE (📖 68)
 - FOCUS AREA (📖 69)
 - FLASH MODE (📖 35)
 - FLASH COMPENSATION (📖 93)
 - SELECT CUSTOM SETTING (📖 81)
 - MOVIE (📖 37)
 - FACE DETECTION (📖 88)
 - RAW (📖 74)
 - APERTURE SETTING (📖 94)
 - WIRELESS COMMUNICATION (📖 114)
 - SHUTTER TYPE (📖 95)
 - PREVIEW EXP. IN MANUAL MODE (📖 104)
 - PREVIEW PIC. EFFECT (📖 105)
 - COMMAND DIAL SETTING (📖 106)
 - EVF/LCD SETTING (📖 23)
 - NONE
- ❖ To disable the selected button, choose **NONE**.
- ❖ You can also display options for any of the function buttons by pressing and holding the button.
- ❖ The roles played by the function buttons can also be selected using **🔘 BUTTON/DIAL SETTING > FUNCTION (Fn) SETTING** (📖 106).

More on Photography and Playback

Mode Selection

P, S, A, and M Modes

Choose **P**, **S**, **A**, or **M** mode for manual control over shutter speed and/or aperture. The role of the command dial varies with the mode selected.

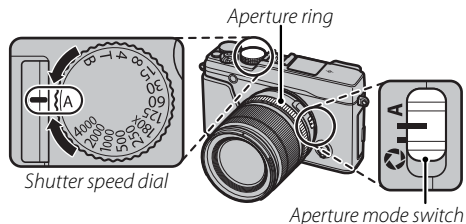

Mode	Description	Role of command dial	
P	Program AE: The camera adjusts settings automatically, but you can use the command dial to choose from combinations of shutter speed and aperture that will produce optimal exposure (program shift).	Program shift	46
S	Shutter-priority auto: You choose the shutter speed using the shutter speed and command dials and let the camera adjust aperture for optimal exposure.	Shutter speed fine-tuning	47
A	Aperture-priority auto: You choose the aperture using the aperture ring and let the camera adjust shutter-speed for optimal exposure.	—	48
M	Manual exposure: You control both shutter speed and aperture.	Shutter speed fine-tuning	49

◆ For information on the role of the command dial when the camera is used with lenses not equipped with an aperture ring, see “Lenses with No Aperture Rings” (📖 10).

■ Program AE (P)

To allow the camera to adjust both shutter speed and aperture for optimal exposure, set shutter speed and aperture to **A**. **P** will appear in the display.

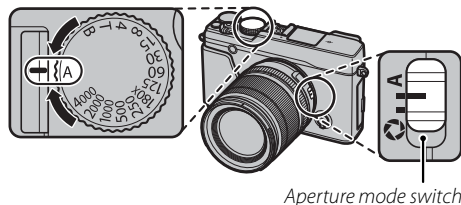

- ① If the subject is outside the metering range of the camera, the shutter speed and aperture displays will show “---”.

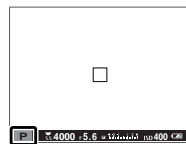

● Program Shift

If desired, you can rotate the command dial to select other combinations of shutter speed and aperture without altering exposure (program shift). The new values for shutter speed and aperture are shown in yellow. Program shift is not available if the attached flash supports TTL auto, or if an auto option is selected for **D-Ring DYNAMIC RANGE** in the shooting menu (☰ 90). To cancel program shift, turn the camera off.

- ◆ For information on the role of the command dial when the camera is used with lenses not equipped with an aperture ring, see “Lenses with No Aperture Rings” (☰ 10).

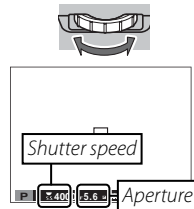

■ Shutter-Priority AE (S)

To adjust shutter speed manually while letting the camera select aperture for optimal exposure, set aperture to **A** and use the shutter speed dial. **S** will appear in the display.

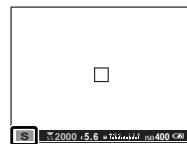
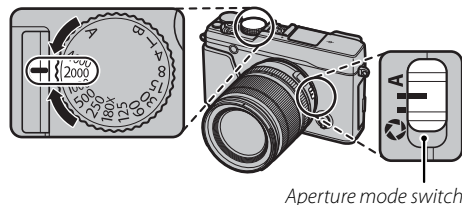

- ◆ At settings other than **180X**, shutter speed can also be adjusted in increments of $\frac{1}{3}$ EV by rotating the command dial. Shutter speed can be adjusted even while the shutter button is pressed halfway.
- ◆ For information on the role of the command dial when the camera is used with lenses not equipped with an aperture ring, see “Lenses with No Aperture Rings” (📖 10).
- ① If the correct exposure can not be achieved at the selected shutter speed, aperture will be displayed in red when the shutter button is pressed halfway. Adjust shutter speed until the correct exposure is achieved.
- ① If the subject is outside the metering range of the camera, the aperture display will show “---”.

■ Aperture-Priority AE (A)

To adjust aperture manually while letting the camera select shutter speed for optimal exposure, rotate the shutter speed dial to **A** and adjust aperture as desired. **A** will appear in the display.

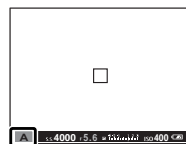
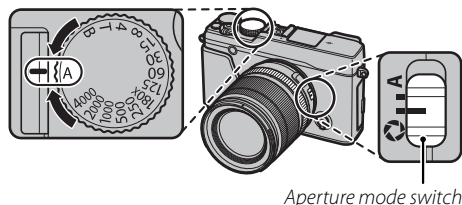

◆ Aperture can be adjusted even while the shutter button is pressed halfway.

- ① If the correct exposure can not be achieved at the selected aperture, the shutter speed will be displayed in red when the shutter button is pressed halfway. Adjust aperture until the correct exposure is achieved.
- ① If the subject is outside the metering range of the camera, the shutter speed display will show "----".

● Previewing Depth of Field

When **PREVIEW DEPTH OF FIELD** is assigned to a function button (44), pressing the button stops aperture down to the selected setting, allowing depth of field to be previewed in the display.

Depth of field can also be previewed using the depth-of-field indicator in the standard display. Press **DISP/BACK** to cycle through display modes until standard indicators are displayed.

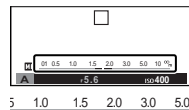

Depth of field

Manual Exposure (M)

Exposure can be altered from the value suggested by the camera by setting both shutter speed and aperture to values other than **A**. **M** will appear in the display.

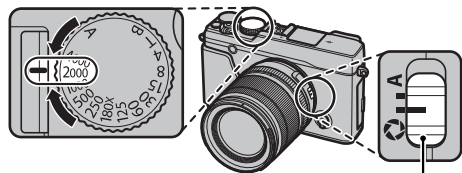

Aperture mode switch

- At settings other than **180X**, shutter speed can also be adjusted in increments of $\frac{1}{3}$ EV by rotating the command dial.

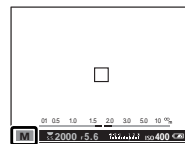

- The manual exposure display includes an exposure indicator that shows the amount the picture would be under- or over-exposed at current settings.
- For information on the role of the command dial when the camera is used with lenses not equipped with an aperture ring, see “Lenses with No Aperture Rings” (10).

Exposure Preview

To preview exposure in the LCD monitor, select **ON** for **SCREEN SET-UP > PREVIEW EXP. IN MANUAL MODE**. Select **OFF** when using the flash or on other occasions on which exposure may change when the picture is taken.

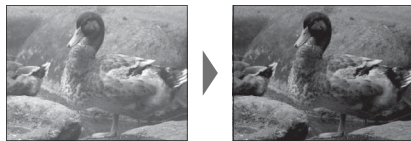

Long Time-Exposures (T/B)

Select a shutter speed of **T** (time) or **B** (bulb) for long time-exposures.

- Use of a tripod is recommended to prevent the camera from moving during the exposure.
- To reduce “noise” (mottling) in long time-exposures, select **ON** for **LONG EXPOSURE NR** in the shooting menu (📖 91). Note that this may increase the time needed to record images after shooting.

Time (T)

1 Rotate the shutter speed dial to **T**.



2 Rotate the command dial to choose the exposure time.



3 Press the shutter button all the way down to take a picture at the selected shutter speed. A count-down timer will be displayed while the exposure is in progress.



- For information on the role of the command dial when the camera is used with lenses not equipped with an aperture ring, see “Lenses with No Aperture Rings” (📖 10).

Bulb (B)

1 Rotate the shutter speed dial to **B**.



2 Press the shutter button all the way down. The shutter will remain open for up to 60 minutes while the shutter button is pressed; the display shows the time elapsed since the exposure started.



- Selecting an aperture of **A** fixes shutter speed at 30 s.

Using a Remote Release

An optional RR-90 remote release can be used for long time-exposures. See the manual provided with the RR-90 for more information.

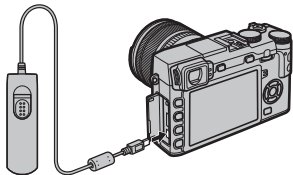

• Third-Party Remote Releases

- Third-party remote releases (available from third-party suppliers) can be connected as shown below.

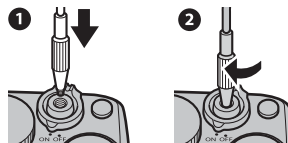

- Electronic releases from third-party suppliers can be connected via the microphone/remote release connector. A confirmation dialog will be displayed when a third-party release is connected; press **MENU/OK** and select **REMOTE** for **MIC/REMOTE RELEASE**.

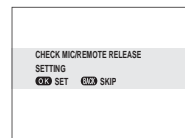
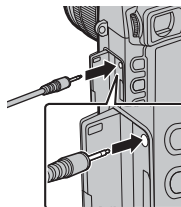

Exposure Compensation

Rotate the exposure compensation dial to adjust exposure when photographing very bright, very dark, or high-contrast subjects. The effect is visible in the display.

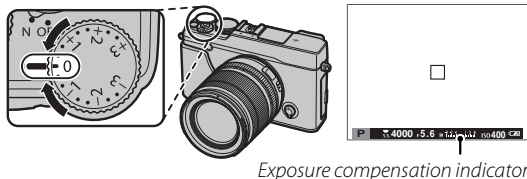

Choose positive values (+) to increase exposure



Choose negative values (-) to reduce exposure



Exposure Value (EV)

The exposure value is determined by the sensitivity of the image sensor and the amount of light to which the sensor is exposed. Doubling the amount increases EV by one, while halving it reduces EV by one. The amount of light entering the camera can be controlled by adjusting aperture and shutter speed.

Choosing an Exposure Compensation Value

- **Backlit subjects:** Choose values from $+2/3$ EV to $+12/3$ EV.



- **Highly reflective subjects or very bright scenes** (e.g., snowfields): $+1$ EV



- **Scenes that are mostly sky:** $+1$ EV

- **Spotlit subjects** (particularly if photographed against dark backgrounds): $-2/3$ EV

- **Subjects with low reflectivity** (pine trees or dark-colored foliage): $-2/3$ EV

ⓘ The amount of compensation available varies with the shooting mode.

Focus/Exposure Lock

To compose photographs with off-center subjects:

1 Focus: Position the subject in the focus frame and press the shutter button halfway to lock focus and exposure. Focus and exposure will remain locked while the shutter button is pressed halfway (AF/AE lock).



◆ Focus and exposure can also be locked with the **AF-L** and **AE-L** buttons, respectively (if **AE/AF LOCK** is selected for **AF-L AF-LOCK BUTTON** in the shooting menu, pressing the **AF-L** button will lock both focus and exposure; [page 92](#)).

2 Recompose: Keep the shutter button pressed halfway or keep the **AF-L** or **AE-L** button pressed.

◆ Focus and/or exposure will remain locked while the **AF-L** or **AE-L** button is pressed, whether or not the shutter button is pressed halfway. If **AE&AF ON/OFF SWITCH** is selected for **AE/AF-LOCK MODE** ([page 92](#)), focus and/or exposure lock when the button is pressed and remain locked until the button is pressed again.



3 Shoot: Press the shutter button all the way down.



◆ The roles of the **AE-L** and **AF-L** buttons can be reversed using the **ⓘ BUTTON/DIAL SETTING > AE-L/AF-L BUTTON SETTING** option in the setup menu.

Autofocus

Although the camera boasts a high-precision autofocus system, it may be unable to focus on the subjects listed below.

- Very shiny subjects such as mirrors or car bodies.



- Fast-moving subjects.

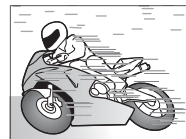



- Subjects photographed through a window or other reflective object.
- Dark subjects and subjects that absorb rather than reflect light, such as hair or fur.
- Insubstantial subjects, such as smoke or flame.
- Subjects that show little contrast with the background (for example, subjects in clothing that is the same color as the background).
- Subjects positioned in front of or behind a high-contrast object that is also in the focus frame (for example, a subject photographed against a backdrop of highly contrasting elements).

Metering

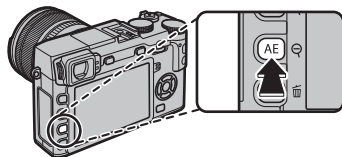
To choose how the camera meters exposure, press the function button (**Fn1/AE**) to display metering options. Use the selector to highlight an option and press **MENU/OK** to select.



ⓘ The selected option will only take effect when Intelligent Face Detection is off (📖 88).

Mode	Description
 (MULTI)	The camera instantly determines exposure based on an analysis of composition, color, and brightness distribution. Recommended in most situations.
 (SPOT)	The camera meters lighting conditions in an area at the center of the frame equivalent to 2% of the total. Recommended with backlit subjects and in other cases in which the background is much brighter or darker than the main subject.
 (AVERAGE)	Exposure is set to the average for the entire frame. Provides consistent exposure across multiple shots with the same lighting, and is particularly effective for landscapes and portraits of subjects dressed in black or white.

◆ Metering options can also be accessed from the shooting menu (📖 92).

Film Simulation

Simulate the effects of different kinds of film, including black-and-white (with or without color filters). Press the function button (**Fn4**) to display the following options, then use the selector to highlight an option and press **MENU/OK** to select.

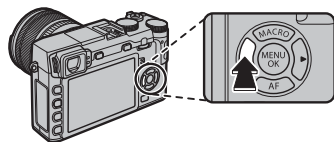

Option	Description
STD (PROVIA/STANDARD)	Standard color reproduction. Suited to a wide range of subjects, from portraits to landscapes.
VIVID (Velvia/VIVID)	A high-contrast palette of saturated colors, suited to nature photos.
SOFT (ASTIA/SOFT)	Enhances the range of hues available for skin tones in portraits while preserving the bright blues of daylight skies. Recommended for outdoor portrait photography.
CLASSIC CHROME (CLASSIC CHROME)	Soft color and enhanced shadow contrast for a calm look.
PRO Neg. Hi (PRO Neg. Hi)	Offers slightly more contrast than PRO Neg. Std . Recommended for outdoor portrait photography.
PRO Neg. Std (PRO Neg. Std)	A soft-toned palette. The range of hues available for skin tones is enhanced, making this a good choice for studio portrait photography.
MONOCHROME (MONOCHROME)	Take pictures in standard black and white.
MONOCHROME + Ye FILTER (MONOCHROME + Ye FILTER)	Take black-and-white pictures with slightly increased contrast. This setting also slightly tones down the brightness of the sky.
MONOCHROME + R FILTER (MONOCHROME + R FILTER)	Take black-and-white pictures with increased contrast. This setting also tones down the brightness of the sky.
MONOCHROME + G FILTER (MONOCHROME + G FILTER)	Soften skin tones in black-and-white portraits.
SEPIA (SEPIA)	Take pictures in sepia.

- ◆ Film simulation options can be combined with tone and sharpness settings (📖 91).
- ◆ Film simulation options can also be accessed from the shooting menu (📖 90).

The DRIVE Button

The **DRIVE** button gives you access to the following options.

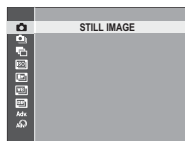
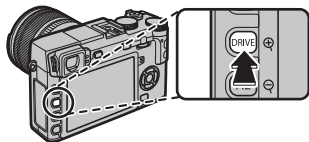





Drive mode	
STILL IMAGE	—
CONTINUOUS	58
AE BKT	59
ISO BKT	
FILM SIMULATION BKT	
WHITE BALANCE BKT	
DYNAMIC RANGE BKT	
Adv. MODE	
MOTION PANORAMA	60
MULTIPLE EXPOSURE	63
ADVANCED FILTER	64

Continuous Shooting (Burst Mode)

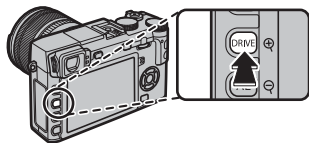
Capture motion in a series of pictures.

1 Press the **DRIVE** button to display drive options.



2 Press the selector up or down to highlight , then press the selector left or right to choose a frame rate of  (high) or  (low). Press **MENU/OK** to proceed when settings are complete.

3 Press the shutter button halfway to focus.

4 Press the shutter button the rest of the way down to start shooting. Shooting ends when the shutter button is released, the maximum number of pictures has been taken, or the memory card is full.

- ◆ Frame rate varies with the subject, shutter speed, sensitivity, and focus mode and may slow as more shots are taken.
- ◆ The flash turns off automatically; the previously-selected flash mode is restored when burst shooting is disabled.
- ◆ Additional time may be required to record pictures when shooting ends.
- ◆ If file numbering reaches 999 before shooting is complete, the remaining pictures will be recorded to a new folder (107).
- ◆ In some drive modes, shooting may not begin if the space available on the memory card is insufficient.

Focus and Exposure

To vary focus and exposure with each shot, select focus mode **C**; in other modes, focus and exposure are determined by the first shot in each series.

- ① Selecting  in focus mode **C** restricts the choice of focus frames (71).
- ① Exposure and focus tracking performance may vary with aperture, sensitivity, and shooting conditions.

Bracketing

Automatically vary settings over a series of pictures.

- 1 Press the **DRIVE** button to display drive options and press the selector up or down to highlight one of the following:

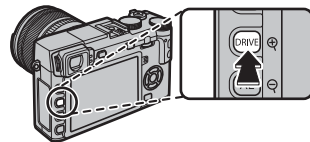

Option	Description
AE BKT	Press the selector left or right to highlight a bracketing amount. Each time the shutter button is pressed, the camera will take three shots: one using the metered value for exposure, the second overexposed by the selected amount, and the third underexposed by the same amount (regardless of the amount selected, exposure will not exceed the limits of the exposure metering system).
ISO BKT	Press the selector left or right to highlight a bracketing amount. Each time the shutter is released, the camera will take a picture at the current sensitivity (📖 72) and process it to create two additional copies, one with sensitivity raised and the other with sensitivity lowered by the selected amount (regardless of the amount selected, sensitivity will not exceed ISO 6400 or fall below ISO 200).
FILM SIMULATION BKT	Each time the shutter is released, the camera takes one shot and processes it to create copies with the film simulation settings selected for FILM SIMULATION BKT in the shooting menu (📖 94).
WHITE BALANCE BKT	Press the selector left or right to choose the bracketing amount. Each time the shutter button is pressed, the camera takes three shots: one at the current white balanced setting, one with fine-tuning increased by the selected amount, and another with fine-tuning decreased by the selected amount.
DYNAMIC RANGE BKT	Each time the shutter button is pressed, the camera takes three shots with different dynamic ranges (📖 90): 100% for the first, 200% for the second, and 400% for the third. While dynamic range bracketing is in effect, sensitivity will be restricted to a minimum of ISO 800; the sensitivity previously in effect is restored when bracketing ends.

- 2 Press **MENU/OK** to select the highlighted option.
- 3 Take photographs.

Panoramas

Follow an on-screen guide to create a panorama.

- 1 Press the **DRIVE** button to display drive options. Press the selector up or down to highlight **Adv.**, then press the selector left or right to highlight **MOTION PANORAMA** and press **MENU/OK**.

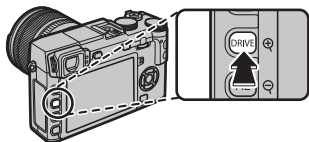

- 2 To select the size of the angle through which you will pan the camera while shooting, press the selector left. Highlight a size and press **MENU/OK**.
- 3 Press the selector right to view a choice of pan directions. Highlight a pan direction and press **MENU/OK**.
- 4 Press the shutter button all the way down to start recording. There is no need to keep the shutter button pressed during recording.

- 5 Pan the camera in the direction shown by the arrow. Shooting ends automatically when the camera is panned to the end of the guides and the panorama is complete.

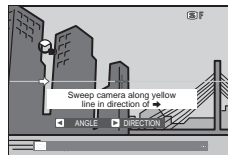



- ◆ Shooting ends if the shutter button is pressed all the way down during shooting. No panorama may be recorded if the shutter button is pressed before the panorama is complete.

- ① Panoramas are created from multiple frames; exposure for the entire panorama is determined by the first frame. The camera may in some cases record a greater or lesser angle than selected or be unable to stitch the frames together perfectly. The last part of the panorama may not be recorded if shooting ends before the panorama is complete.
- ① Shooting may be interrupted if the camera is panned too quickly or too slowly. Panning the camera in a direction other than that shown cancels shooting.
- ① The desired results may not be achieved with moving subjects, subjects close to the camera, unvarying subjects such as the sky or a field of grass, subjects that are in constant motion, such as waves and waterfalls, or subjects that undergo marked changes in brightness. Panoramas may be blurred if the subject is poorly lit.

 **For Best Results**

For best results, use a lens with a focal length of 35 mm or less (50 mm or less in 35 mm format). Prop your elbows against your sides and move the camera slowly in a small circle at a steady speed, keeping the camera parallel or at right angles to the horizon and being careful only to pan in the direction shown by the guides. Use a tripod for best results. If the desired results are not achieved, try panning at a different speed.

■ Viewing Panoramas

To zoom in on a panorama in full-frame playback, press the  button and use the  and  buttons to zoom in and out. Alternatively, you can play the panorama back using the selector. Press the selector down to start playback and press again to pause. While playback is paused, you can scroll the panorama manually by pressing the selector left or right; vertical panoramas will scroll vertically, horizontal panoramas horizontally. To exit to full-frame playback, press the selector up.

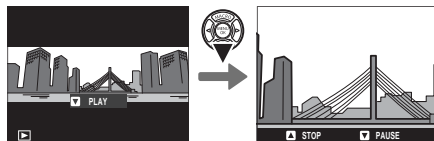

Multiple Exposures

Create a photograph that combines two exposures.



- 1 Press the **DRIVE** button to display drive options. Press the selector up or down to highlight **Adv.**, then press the selector left or right to highlight **MULTIPLE EXPOSURE** and press **MENU/OK**.
- 2 Take the first shot.
- 3 Press **MENU/OK**. The first shot will be shown superimposed on the view through the lens and you will be prompted to take the second shot.
 - ◆ To return to Step 2 and retake the first shot, press the selector left. To save the first shot and exit without creating a multiple exposure, press **DISP/BACK**.
- 4 Take the second shot, using the first frame as a guide.
- 5 Press **MENU/OK** to create the multiple exposure, or press the selector left to return to Step 4 and retake the second shot.

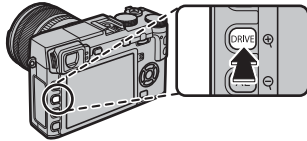





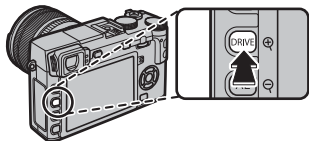

Advanced Filter







Take photos with filter effects.

- 1 Press the **DRIVE** button to display drive options. Press the selector up or down to highlight  and press **MENU/OK**.



- 2 Choose from the following filters and press **MENU/OK**.

Filter	Description
 TOY CAMERA	Choose for a retro toy camera effect.
 MINIATURE	The tops and bottoms of pictures are blurred for a diorama effect.
 POP COLOR	Create high-contrast images with saturated colors.
 HIGH-KEY	Create bright, low-contrast images.
 LOW-KEY	Create uniformly dark tones with few areas of emphasized highlights.
 DYNAMIC TONE	Dynamic tone expression is used for a fantasy effect.

Filter	Description
 SOFT FOCUS	Create a look that is evenly soft throughout the whole image.
 PARTIAL COLOR (RED)	Areas of the image that are the selected color are recorded in that color. All other areas of the image are recorded in black-and-white.
 PARTIAL COLOR (ORANGE)	
 PARTIAL COLOR (YELLOW)	
 PARTIAL COLOR (GREEN)	
 PARTIAL COLOR (BLUE)	
 PARTIAL COLOR (PURPLE)	

- ◆ Depending on the subject and camera settings, images may in some cases be grainy or vary in brightness and hue.



Focus Mode

Use the focus mode selector to choose how the camera focuses (note that regardless of the option selected, manual focus will be used when the lens is in manual focus mode).

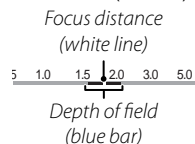
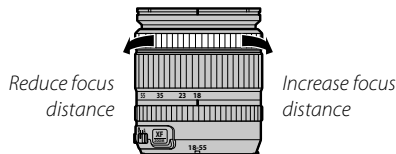
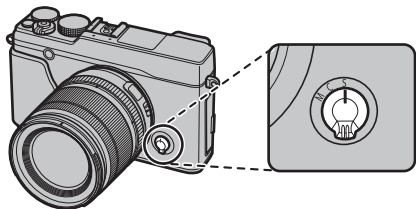
- **S** (single AF): Focus locks while the shutter button is pressed halfway. Choose for stationary subjects.
- **C** (continuous AF): Focus is continually adjusted to reflect changes in the distance to the subject while the shutter button is pressed halfway. Use for subjects that are in motion.
- **M** (manual): Focus manually using the lens focus ring. Rotate the ring left to reduce the focus distance, right to increase. The manual focus indicator indicates how closely the focus distance matches the distance to the subject in the focus brackets (the white line indicates the focus distance, the blue bar the depth of field, or in other words the distance in front of and behind the focus point that appears to be in focus); you can also check focus visually in the viewfinder or LCD monitor. Choose for manual control of focus or in situations in which the camera is unable to focus using autofocus (📖 54).



- ◆ Use the **FOCUS RING** option in the setup menu (📖 106) to reverse the direction of rotation of the focus ring.
- ◆ To use autofocus to focus on the subject in the selected focus area (📖 69), press the **AF-L** button (the size of the focus area can be chosen with the command dial). In manual focus mode, you can use this feature to quickly focus on a chosen subject using either single or continuous AF according to the option chosen for **RF AUTO-FOCUS SETTING > INSTANT AF SETTING** (📖 87).

- ◆ The camera can show focus distance in meters or feet. Use the  **SCREEN SET-UP > FOCUS SCALE UNITS** option in the setup menu (📖 105) to choose the units used.
- ◆ If **ON** is selected for  **AUTOFOCUS SETTING > PRE-AF** in the shooting menu (📖 89), focus will be adjusted continuously in modes **S** and **C** even when the shutter button is not pressed.



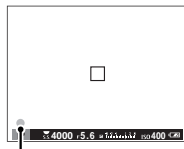

■ The Focus Indicator

The focus indicator turns green when the subject is in focus and blinks white when the camera is unable to focus. Brackets (“()”) indicate that the camera is focusing and are displayed continuously in mode **C** while the shutter button is pressed halfway.  is displayed in manual focus mode.



Focus indicator

● Checking Focus

To zoom in on the current focus area (📖 69) for precise focus, press the center of the command dial. Press again to cancel zoom. In manual focus mode, zoom can be adjusted by rotating the command dial when **STANDARD** or **FOCUS PEAK HIGHLIGHT** is selected for  **MF ASSIST**, while if **ON** is selected for  **SCREEN SET-UP > FOCUS CHECK**, the camera will automatically zoom in on the selected focus area when the focus ring is rotated. Focus zoom is not available in focus mode **C** or when  **AUTOFOCUS SETTING > PRE-AF** is on or an option other than  **SINGLE POINT** is selected for  **AUTOFOCUS SETTING > AF MODE**.



MF Assist

The **MF ASSIST** option in the setup menu can be used to check focus when pictures are framed in the LCD monitor or electronic viewfinder in manual focus mode.

The **MF ASSIST** menu can be displayed by pressing and holding the center of the command dial.

The following options are available:

- **FOCUS PEAK HIGHLIGHT:** Highlights high-contrast outlines. Rotate the focus ring until the subject is highlighted.
- **DIGITAL SPLIT IMAGE:** Displays a split, black-and-white image in the center of the frame. Frame the subject in the split-image area and rotate the focus ring until the three parts of the split image are correctly aligned.

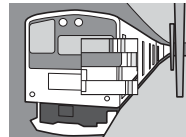

Autofocus Options (AF Mode)

To choose the AF mode for focus modes **S** and **C**, press the function button (**Fn3**) to display the options shown below, then press the selector up or down to highlight an option and press **MENU/OK** to select.

- **[] SINGLE POINT:** The camera focuses on the subject in the selected focus point. Use for pin-point focus on a selected subject.
- **[] ZONE:** The camera focuses on the subject in the selected focus zone. Focus zones include multiple focus points (5×3, 5×5, or 3×3), making it easier to focus on subjects that are in motion.
- **[] WIDE/TRACKING:** In focus mode **C**, the camera tracks focus on the subject in the selected focus point while the shutter button is pressed halfway. In focus mode **S**, the camera automatically focuses on high-contrast subjects; the areas in focus are shown in the display. The camera may be unable to focus on small objects or subjects that are moving rapidly.

◆ AF mode options can also be accessed using the **[Fn] AUTOFOCUS SETTING** option in the shooting menu (📖 87).

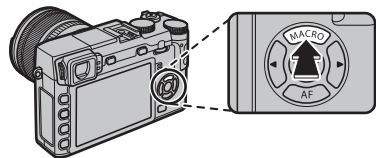

Focus-Point Selection

Choose a focus point for autofocus. The procedure for selecting the focus point varies with the option chosen for AF mode (📖 68).

- ◆ Focus-area selection can also be accessed using the **RF** **AUTOFOCUS SETTING** option in the shooting menu (📖 87).
- ◆ Focus-area selection can also be used to choose the focus point for manual focus and focus zoom.

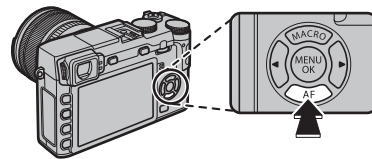

■ **Single Point AF**

Press the function button (**Fn6**) to display the focus points ("+") and focus frame. Use the selector to position the focus frame over the desired focus point, or press **DISP/BACK** to return to the center point.

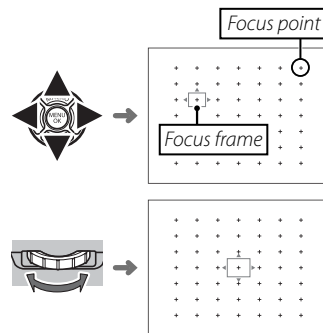

To choose the size of the focus frame, rotate the command dial. Rotate the dial left to reduce the frame by up to 50%, right to enlarge it by up to 150%, or press the center of the dial to restore the frame to its original size. Press **MENU/OK** to put your selection into effect.

Zone AF

Press the function button (**Fn6**) to display the focus zone. Use the selector to position the zone or press **DISP/BACK** to return the zone to the center of the display.

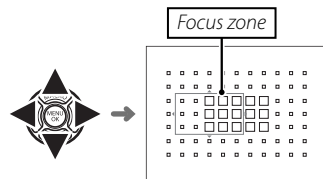

To choose the number of focus frames in the zone, rotate the command dial. Rotate the dial right to cycle through zone sizes in the order 5×5 , 3×3 , 5×3 , 5×5 ..., left to cycle through zone sizes in reverse order, or press the center of the dial to select a zone size of 5×3 . Press **MENU/OK** to put your selection into effect.

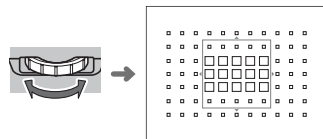

Tracking (Focus Mode C Only)

Press the function button (**Fn6**) to display the focus frame. Use the selector to position the focus frame, or press **DISP/BACK** to return the frame to the center of the display. Press **MENU/OK** to put your selection into effect. The camera will track focus on the subject while the shutter button is pressed halfway.

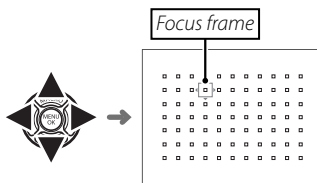

ⓘ Manual focus-frame selection is not available when wide/tracking is selected in focus mode **S**.

Burst Mode Focus-Frame Selection

During high-speed burst photography (**Ⓜ**), the number of focus frames available in focus mode **C** drops and the maximum zone size is restricted to 5×3 .

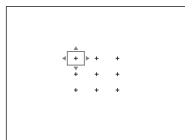

Single point

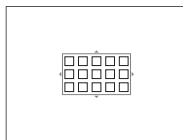

Zone

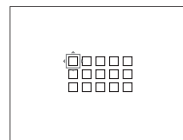

Wide/Tracking

Sensitivity

“Sensitivity” refers to the camera’s sensitivity to light. Choose from values between 200 and 6400, or select low-gain (**L (100)**) or high-gain (**H (12800)** or **H (25600)**) options for special situations. Higher values can be used to reduce blur when lighting is poor, while lower values allow slower shutter speeds or wider apertures in bright light; note, however, that mottling may appear in pictures taken at high sensitivities, particularly at higher gains, while choosing the low-gain option reduces dynamic range. Values of from ISO 200 to ISO 6400 are recommended in most situations. If **AUTO1**, **AUTO2**, or **AUTO3** is selected, the camera will adjust sensitivity automatically in response to shooting conditions.

1 Press **MENU/OK** in shooting mode to display the shooting menu. Press the selector up or down to highlight **ISO ISO** and press **MENU/OK**.

2 Press the selector up or down to highlight the desired option and press **MENU/OK** to select.

- ◆ Sensitivity is not reset when the camera is turned off.
- ◆ The low-gain option reset to ISO 200 and the high-gain options to ISO 6400 when **RAW**, **FINE+RAW**, or **NORMAL+RAW** is selected for image quality (📖 90). For more information on the settings available with low- and high-gain options, see page 148.

■ AUTO

The following options are available when **AUTO1**, **AUTO2**, or **AUTO3** is selected:

Option	Default
DEFAULT SENSITIVITY	200
MAX. SENSITIVITY	800 (AUTO1) 1600 (AUTO2) 3200 (AUTO3)
MIN. SHUTTER SPEED	1/60

The camera automatically chooses a sensitivity between the default and maximum values. Sensitivity is only raised above the default value if the shutter speed required for optimal exposure would be slower than the value selected for **MIN. SHUTTER SPEED**.

- 🔍 If the value selected for **DEFAULT SENSITIVITY** is higher than that selected for **MAX. SENSITIVITY**, **DEFAULT SENSITIVITY** will be set to the value selected for **MAX. SENSITIVITY**.
- 🔍 The camera may select shutter speeds slower than **MIN. SHUTTER SPEED** if pictures would still be underexposed at the value selected for **MAX. SENSITIVITY**.

Recording Pictures in RAW Format

To record raw, unprocessed data from the camera image sensor, select a **RAW** option for image quality in the shooting menu as described below. JPEG copies of RAW images can be created using the **RAW RAW CONVERSION** option in the playback menu, or RAW images can be viewed on a computer using the RAW FILE CONVERTER application (📖 115).

- 1 Press **MENU/OK** in shooting mode to display the shooting menu. Press the selector up or down to highlight **IMAGE QUALITY** and press **MENU/OK**.
- 2 Highlight an option and press **MENU/OK**. Select **RAW** to record only RAW images, or **FINE+RAW** or **NORMAL+RAW** to record both JPEG copy together with the RAW images. **FINE+RAW** uses lower JPEG compression ratios for higher-quality JPEG images, while **NORMAL+RAW** uses higher JPEG compression ratios to increase the number of images that can be stored.

The Function Button

To toggle RAW image quality on or off for a single shot, assign **RAW** to a function button (📖 44). If a JPEG option is currently selected for image quality, pressing the button temporarily selects the equivalent JPEG+RAW option. If a JPEG+RAW option is currently selected, pressing the button temporarily selects the equivalent JPEG option, while if **RAW** is selected, pressing the button temporarily selects **FINE**. Taking a picture or pressing the button again restores the previous setting.

🔍 Low- and high-gain ISO sensitivities are not available when RAW image quality is on (📖 72).

Creating JPEG Copies of RAW Pictures

RAW pictures store information on camera settings separately from the data captured by the camera image sensor. Using the **RAW RAW CONVERSION** option in the playback menu, you can create JPEG copies of RAW pictures using different options for the settings listed below. The original image data are unaffected, allowing a single RAW image to be processed in a multitude of different ways.

- 1 Press **MENU/OK** during playback to display the playback menu, then press the selector up or down to highlight **RAW RAW CONVERSION** and press **MENU/OK** to display the settings listed in the table at right.

◆ These options can also be displayed by pressing **Q** button during playback.

- 2 Press the selector up or down to highlight a setting and press the selector right to select. Press the selector up or down to highlight the desired option and press **MENU/OK** to select and return to the settings list. Repeat this step to adjust additional settings.

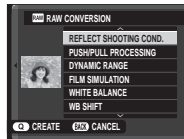



- 3 Press the **Q** button to preview the JPEG copy and press **MENU/OK** to save.

Setting	Description
REFLECT SHOOTING COND.	Create a JPEG copy using the settings in effect at the time the photo was taken.
PUSH/PULL PROCESSING	Adjust exposure by -1 EV to $+3$ EV in increments of $\frac{1}{2}$ EV (📖 52).
DYNAMIC RANGE	Enhance details in highlights for natural contrast (📖 90).
FILM SIMULATION	Simulate the effects of different types of film (📖 56).
WHITE BALANCE	Adjust white balance (📖 79).
WB SHIFT	Fine-tune white balance (📖 79).
COLOR	Adjust color density (📖 91).
SHARPNESS	Sharpen or soften outlines (📖 91).
HIGHLIGHT TONE	Adjust highlights (📖 91).
SHADOW TONE	Adjust shadows (📖 91).
NOISE REDUCTION	Process the copy to reduce mottling (📖 91).
LENS MODULATION OPTIMIZER	Improve definition by adjusting for diffraction and the slight loss of focus at the periphery of the lens (📖 91).
COLOR SPACE	Choose the color space used for color reproduction (📖 108).

Using the Self-Timer

Use the timer for self-portraits or to prevent blur caused by camera shake.

- 1 Press **MENU/OK** in shooting mode to display the shooting menu. Press the selector up or down to highlight  **SELF-TIMER** and press **MENU/OK**.
- 2 Press the selector up or down to highlight one of the following options and press **MENU/OK** to select.

Option	Description
 2 SEC	The shutter is released two seconds after the shutter button is pressed. Use to reduce blur caused by the camera moving when the shutter button is pressed.
 10 SEC	The shutter is released ten seconds after the shutter button is pressed. Use for photographs in which you wish to appear yourself.
OFF	Self-timer off.

- 3 Press the shutter button halfway to focus.
 - ① Stand behind the camera when using the shutter button. Standing in front of the lens can interfere with focus and exposure.

- 4 Press the shutter button the rest of the way down to start the timer. The display in the monitor shows the number of seconds remaining until the shutter is released. To stop the timer before the picture is taken, press **DISP/BACK**.

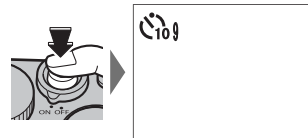

The self-timer lamp on the front of the camera will blink immediately before the picture is taken. If the two-second timer is selected, the self-timer lamp will blink as the timer counts down.

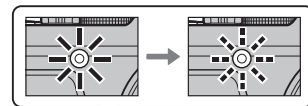

- ◆ The self-timer turns off automatically when the camera is turned off.

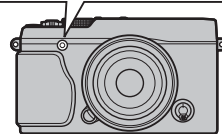

Interval Timer Photography

Follow the steps below to configure the camera to take photos automatically at a preset interval.

- 1 Press **MENU/OK** in shooting mode to display the shooting menu. Press the selector up or down to highlight  **INTERVAL TIMER SHOOTING** and press **MENU/OK**.
- 2 Use the selector to choose the interval and number of shots. Press **MENU/OK** to proceed.
- 3 Use the selector to choose the starting time and then press **MENU/OK**. Shooting will start automatically.

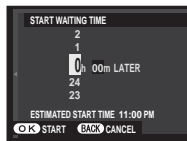
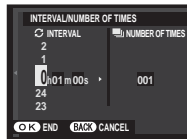







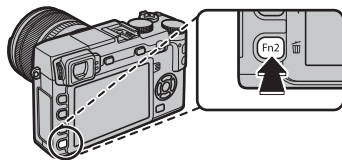

- ① Interval timer photography can not be used at a shutter speed of **B** (bulb) or during panorama or multiple exposure photography. In burst mode, only one picture will be taken each time the shutter is released.
- ◆ Use of a tripod is recommended.
- ◆ Check the battery level before starting. We recommend using an optional AC-9V AC power adapter and CP-W126 DC coupler.
- ◆ The display turns off between shots and lights a few seconds before the next shot is taken. The display can be activated at any time by pressing the shutter button all the way down.

White Balance

For natural colors, press the function button (**Fn2**) to display the following options, then use the selector to highlight an option that matches the light source and press **MENU/OK**. The dialog shown at bottom right will be displayed; use the selector to fine-tune white balance or press **DISP/BACK** to exit without fine-tuning.



Option	Description
AUTO	White balance adjusted automatically.
	Measure a value for white balance (🗨 80).
	Selecting this option displays a list of color temperatures (🗨 80); highlight a temperature and press MENU/OK to select the highlighted option and display the fine-tuning dialog.
	For subjects in direct sunlight.

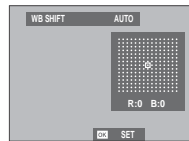

Option	Description
	For subjects in the shade.
	Use under "daylight" fluorescent lights.
	Use under "warm white" fluorescent lights.
	Use under "cool white" fluorescent lights.
	Use under incandescent lighting.
	Reduces the blue cast typically associated with underwater lighting.



- ❖ White balance is adjusted for flash lighting only in **AUTO** and  modes. Turn the flash off using other white balance options.
- ❖ Results vary with shooting conditions. Play pictures back after shooting to check colors.
- ❖ White balance options can also be accessed from the shooting menu (🗨 91).

Custom White Balance

Choose  to adjust white balance for unusual lighting conditions. White balance measurement options will be displayed; frame a white object so that it fills the display and press the shutter button all the way down to measure white balance (to select the most recent custom value and exit without measuring white balance, press **DISP/BACK**, or press **MENU/OK** to select the most recent value and display the fine-tuning dialog).

- If **"COMPLETED!"** is displayed, press **MENU/OK** to set white balance to the measured value.
- If **"UNDER"** is displayed, raise exposure compensation ( 52) and try again.
- If **"OVER"** is displayed, lower exposure compensation ( 52) and try again.

Color Temperature

Color temperature is an objective measure of the color of a light source, expressed in Kelvin (K). Light sources with a color temperature close to that of direct sunlight appear white; light sources with a lower color temperature have a yellow or red cast, while those with a higher color temperature are tinged with blue. You can match color temperature to the light source as shown in the following table, or choose options that differ sharply from the color of the light source to make pictures "warmer" or "colder."

◀ Choose for redder light sources
or "colder" pictures

Choose for bluer light sources ▶
or "warmer" pictures

2,000 K

Candlelight

Sunset/sunrise

5,000 K

Direct sunlight

15,000 K

Blue sky

Shade

Saving Settings

Save up to 7 sets of custom camera settings for commonly-encountered situations. Saved settings can be recalled using the **SELECT CUSTOM SETTING** option in the shooting menu.

- 1 Press **MENU/OK** in shooting mode to display the shooting menu. Press the selector up or down to highlight **EDIT/SAVE CUSTOM SETTING** and press **MENU/OK**.



- 2 Highlight a custom settings bank and press **MENU/OK** to select. Adjust the following as desired and press **DISP/BACK** when adjustments are complete: **ISO** ISO, **D-Ring** DYNAMIC RANGE, **Film** FILM SIMULATION, **WB** WHITE BALANCE, **Color** COLOR, **Sharp** SHARPNESS, **HL Tone** HIGHLIGHT TONE, **SH Tone** SHADOW TONE, and **NR** NOISE REDUCTION.

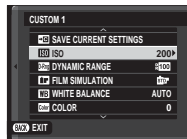

- ◆ To replace the settings in the selected bank with the settings currently selected with the camera, select **SAVE CURRENT SETTINGS** and press **MENU/OK**.

- 3 A confirmation dialog will be displayed; highlight **OK** and press **MENU/OK**.

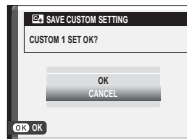

Using a Mount Adapter

When M-mount lenses are attached using an optional **FUJIFILM M MOUNT ADAPTER**, the camera processes pictures as they are taken to maintain image quality and correct for a variety of effects.

- ▶ Attaching a mount adapter enables **LENS SHOOT WITHOUT LENS** (📖 92) and hides the distance indicator in the standard display.
- ▶ Before checking focus, set the focus mode selector to **M** (📖 65).

Mount Adapter Settings

Pressing the function button on the mount adapter displays **LENS MOUNT ADAPTOR SETTING** options.

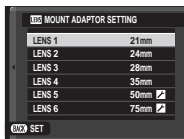

■ Choosing a Focal Length

If the lens has a focal length of 21, 24, 28, or 35 mm, choose a matching option in the **LENS MOUNT ADAPTOR SETTING** menu. For other lenses, select option 5 or 6 and use the selector to enter the focal length.

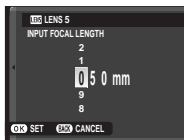

■ Distortion Correction

Choose from **STRONG**, **MEDIUM**, or **WEAK** options to correct **BARREL** or **PINCUSHION** distortion.

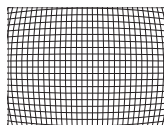
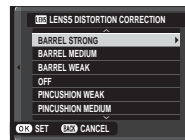

Barrel distortion

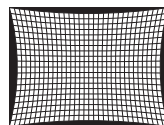

Pincushion distortion

- ▶ To determine the amount required, adjust distortion correction while taking photos of graph paper or other objects featuring repeating vertical and horizontal lines, such as the windows in a high-rise.

■ Color Shading Correction

Color (shading) variations between the center and edges of the frame can be adjusted separately for each corner.

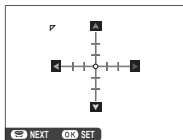

To use color shading correction, follow the steps below.

- 1 Rotate the command dial to choose a corner. The selected corner is indicated by a triangle.



- 2 Use the selector to adjust shading until there is no visible difference in color between the selected corner and the center of the image. Press the selector left or right to adjust colors on the cyan-red axis, up or down to adjust colors on the blue-yellow axis. There are a total of 19 positions available on each axis.



- ◆ To determine the amount required, adjust color shading correction while taking photos of blue sky or a sheet of gray paper.

■ Peripheral Illumination Correction

Choose from values between -5 and $+5$. Choosing positive values increases peripheral illumination, while choosing negative values reduces peripheral illumination. Positive values are recommended for vintage lenses, negative values to create the effect of images taken with an antique lens or a pinhole camera.

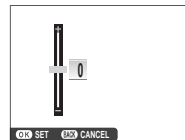





- ◆ To determine the amount required, adjust peripheral illumination correction while taking photos of blue sky or a sheet of gray paper.

PhotoBook Assist

Create books from your favorite photos.

Creating a PhotoBook

1 Select **NEW BOOK** for  **PHOTOBOOK ASSIST** in the playback menu ( 100) and choose from the following options:

- **SELECT FROM ALL:** Choose from all available pictures.
- **SELECT BY IMAGE SEARCH:** Choose from pictures matching selected search conditions ( 86).
- ◆ Neither photographs  or smaller nor movies can be selected for photobooks.

2 Scroll through the images and press the selector up to select or deselect. To display the current image on the cover, press the selector down. Press **MENU/OK** to exit when the book is complete.

- ◆ The first picture selected becomes the cover image. Press the selector down to select a different image for the cover.

3 Highlight **COMPLETE PHOTOBOOK** and press **MENU/OK** (to select all photos or all photos matching the specified search conditions for the book, choose **SELECT ALL**). The new book will be added to the list in the photobook assist menu.

- ① Books can contain up to 300 pictures.
- ① Books that contain no photos are automatically deleted.

Viewing Photobooks

Highlight a book in the photobook assist menu and press **MENU/OK** to display the book, then press the selector left or right to scroll through the pictures.

Editing and Deleting Photobooks

Display the photobook and press **MENU/OK**. The following options will be displayed; select the desired option and follow the on-screen instructions.

- **EDIT:** Edit the book as described in “Creating a PhotoBook” (📖 84).
- **ERASE:** Delete the book.

Photobooks

Photobooks can be copied to a computer using MyFinePix Studio software (📖 115).

Image Search



Follow the steps below to search for pictures.

1 Press **MENU/OK** during playback to display the playback menu. Press the selector up or down to highlight  **IMAGE SEARCH** and press **MENU/OK**.

2 Highlight an option and press **MENU/OK**.

Option	Description
BY DATE	Search by date.
BY FACE	Search for pictures that include faces.
BY ★ FAVORITES	Search by rating (🗨️ 30).
BY TYPE OF DATA	Find all still pictures, all movies, or all RAW pictures.
BY UPLOAD MARK	Find all pictures selected for upload to a specified destination.

3 Select a search condition. Only pictures that match the search condition will be displayed. To delete or protect selected pictures or to view the selected pictures in a slide show, press **MENU/OK** and choose from the options at right.

Option	See page
 ERASE	96
 PROTECT	98
 SLIDE SHOW	99

4 To end the search, select **EXIT SEARCH**.

Using the Menus: Shooting Mode

The shooting menu is used to adjust settings for a wide range of shooting conditions. To display the shooting menu, press **MENU/OK** in shooting mode. Highlight items and press the selector right to view options, then highlight an option and press **MENU/OK**. Press **DISP/BACK** to exit when settings are complete.

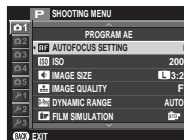

Shooting Menu Options (Photographs)

◆ The options available vary with the shooting mode selected.

ADV ADVANCED FILTER

Choose a filter (📖 64).

◆ This option is only available when **ADV** ADVANCED FILTER is selected for drive mode.

AF AUTOFOCUS SETTING

Adjust autofocus settings.





Option	Description
FOCUS AREA	Choose the focus area (📖 69).
AF MODE	Choose the AF mode for focus modes S and C (📖 68).
RELEASE/FOCUS PRIORITY	Choose how the camera focuses in focus mode AF-S or AF-C . <ul style="list-style-type: none">• RELEASE: Shutter response is prioritized over focus. Pictures can be taken when the camera is not in focus.• FOCUS: Focus is prioritized over shutter response. Pictures can be only taken when the camera is in focus.
INSTANT AF SETTING	Choose how the camera focuses when the AF-L button is pressed in manual focus mode (📖 65).

AF AUTOFOCUS SETTING (Continued)

Option	Description
AF+MF	<p>If ON is selected in focus mode S, focus can be adjusted manually by rotating the focus ring while the shutter button is pressed halfway. Both standard and focus peaking MF assist options are supported (67, 92). Lenses with a focus distance indicator must be set to manual focus mode (MF) before this option can be used. Selecting MF disables the focus distance indicator. Set the focus ring to the center of the focus distance indicator, as the camera may fail to focus if the ring is set to infinity or the minimum focus distance.</p> <div style="border: 1px solid gray; padding: 5px;"> <p>AF + MF Focus Zoom</p> <p>When ON is selected for SCREEN SET-UP > FOCUS CHECK in the setup menu and SINGLE POINT selected for AF MODE, focus zoom can be used to zoom in on the selected focus area. Focus zoom is not available when ZONE or WIDE/TRACKING is selected for AF MODE. The zoom ratio is the same as that selected in manual focus mode (from 2.5× to 6×) and can not be changed.</p> </div>
FACE DETECTION	<p>Intelligent Face Detection sets focus and exposure for human faces anywhere in the frame, preventing the camera from focusing on the background in group portraits. Choose for shots that emphasize portrait subjects.</p> <p>To use Intelligent Face Detection, press MENU/OK to display the shooting menu and select ON for AF AUTOFOCUS SETTING > FACE DETECTION. Faces can be detected with the camera in vertical or horizontal orientation; if a face is detected, it will be indicated by a green border. If there is more than one face in the frame, the camera will select the face closest to the center; other faces are indicated by white borders.</p> <ul style="list-style-type: none"> ① In some modes, the camera may set exposure for the frame as a whole rather than the portrait subject. ① If the subject moves as the shutter button is pressed, the face may not be in the area indicated by the green border when the picture is taken.



AF AUTOFOCUS SETTING (Continued)

Option	Description
EYE DETECTION AF	<p>Choose whether the camera detects and focuses on eyes when Intelligent Face Detection is on. Choose from  AUTO (the camera automatically chooses which eye to focus on),  RIGHT EYE PRIORITY (the camera focuses on the right eye),  LEFT EYE PRIORITY (the camera focuses on the left eye), and OFF (eye focus off).</p> <ul style="list-style-type: none"> ◆ If the camera is unable to detect the subject's eyes because they are hidden by hair, glasses, or other objects, the camera will instead focus on faces.
PRE-AF	<p>If ON is selected, the camera will continue to adjust focus even when the shutter button is not pressed halfway. Note that this increases the drain on the battery.</p>
AF ILLUMINATOR	<p>If ON is selected, the AF-assist illuminator will light to assist autofocus.</p> <ul style="list-style-type: none"> ◆ The AF-assist illuminator turns off automatically when OFF is selected for  SOUND & FLASH in the setup menu. ① The camera may be unable to focus using the AF-assist illuminator in some cases. If the camera is unable to focus in macro mode, try increasing the distance to the subject. ① Avoid shining the AF-assist illuminator directly into your subject's eyes.

**ISO** ISO

Control the camera's sensitivity to light ( 72).

IMAGE SIZE

Choose the size and aspect ratio at which still pictures are recorded.

Aspect Ratio

Pictures with an aspect ratio of 3:2 have the same proportions as a frame of 35 mm film, while an aspect ratio of 16:9 is suited to display on High Definition (HD) devices. Pictures with an aspect ratio of 1:1 are square.

IMAGE SIZE is not reset when the camera is turned off or another shooting mode is selected.

Option	Prints at sizes up to	Option	Prints at sizes up to
L 3:2	41 × 28 cm (16 × 11 in.)	S 3:2	21 × 14 cm (8 × 5 in.)
L 16:9	41 × 23 cm (16 × 9 in.)	S 16:9	21 × 12 cm (8 × 4 in.)
L 1:1	28 × 28 cm (11 × 11 in.)	S 1:1	14 × 14 cm (5 × 5 in.)
M 3:2	29 × 20 cm (11 × 7 in.)		
M 16:9	29 × 16 cm (11 × 6 in.)		
M 1:1	20 × 20 cm (7 × 7 in.)		

IMAGE QUALITY

Choose a file format and compression ratio. Select **FINE** or **NORMAL** to record JPEG images, **RAW** to record RAW images, or **FINE+RAW** or **NORMAL+RAW** to record both JPEG and RAW images. **FINE** and **FINE+RAW** use lower JPEG compression ratios for higher-quality JPEG images, while **NORMAL** and **NORMAL+RAW** use higher JPEG compression ratios to increase the number of images that can be stored.

DYNAMIC RANGE

Control contrast. Choose lower values to increase contrast when shooting indoors or under overcast skies, higher values to reduce loss of detail in highlights and shadows when photographing high-contrast scenes. Higher values are recommended for scenes that include both sunlight and deep shade, for such high-contrast subjects as sunlight on water, brightly-lit autumn leaves, and portraits taken against a blue sky, and for white objects or people wearing white; note, however, that mottling may appear in pictures taken at higher values.

- If **AUTO** is selected, the camera will automatically choose either **#100 100%** or **#200 200%** according to the subject and shooting conditions. Shutter speed and aperture will be displayed when the shutter button is pressed halfway.
- **#200 200%** is available at sensitivities of ISO 400 and above, **#400 400%** at sensitivities of ISO 800 and above.

FILM SIMULATION

Simulate the effects of different types of film (📖 56).

SELF-TIMER

Take pictures with the self-timer (📖 76).

 INTERVAL TIMER SHOOTING

Adjust settings for interval timer photography ( 78).

 WHITE BALANCE

Adjust colors to match the light source ( 79).

 COLOR

Adjust color density.

 SHARPNESS

Sharpen or soften outlines.

 HIGHLIGHT TONE

Adjust the appearance of highlights.

 SHADOW TONE

Adjust the appearance of shadows.

 NOISE REDUCTION

Reduce noise in pictures taken at high sensitivities.

 LONG EXPOSURE NR

Select **ON** to reduce mottling in long time-exposures ( 50).

 LENS MODULATION OPTIMIZER

Select **ON** to improve definition by adjusting for diffraction and the slight loss of focus at the periphery of the lens.

 SELECT CUSTOM SETTING

Recall settings saved with  **EDIT/SAVE CUSTOM SETTING**.

 EDIT/SAVE CUSTOM SETTING

Save settings ( 81).

MOUNT ADAPTOR SETTING

Adjust settings for M-mount lenses connected using an optional **FUJIFILM M MOUNT ADAPTER** (📖 82).

SHOOT WITHOUT LENS

Choose whether shutter release is enabled when no lens is attached.

MF ASSIST

Choose how focus is displayed in manual focus mode (📖 67).

- **STANDARD:** Focus is displayed normally (focus peaking and digital split image are not available).
- **DIGITAL SPLIT IMAGE:** A black-and-white split-image display.
- **FOCUS PEAK HIGHLIGHT:** The camera heightens high-contrast outlines. Choose a color and peaking level.

AE/AF-LOCK MODE

If **AE & AF ON WHEN PRESSING** is selected, exposure and/or focus will lock while the **AE-L** or **AF-L** button is pressed. If **AE & AF ON/OFF SWITCH** is selected, exposure and/or focus will lock when the **AE-L** or **AF-L** button is pressed and remain locked until the button is pressed again.

AF-LOCK BUTTON

Choose the role played by the **AF-L** button (📖 53).

PHOTOMETRY

Choose how the camera meters exposure when Intelligent Face Detection is off (📖 55).

INTERLOCK SPOT AE & FOCUS AREA

Select **ON** to meter the current focus frame when **SINGLE POINT** is selected for **AUTOFOCUS SETTING > AF MODE** and **SPOT** is selected for **PHOTOMETRY**.

FLASH SET-UP

Adjust flash settings.

Option	Description
FLASH MODE	Choose a flash mode (35).
FLASH COMPENSATION	Adjust flash brightness. Choose from values between +2 EV and –2 EV. Note that the desired results may not be achieved depending on shooting conditions and the distance to the subject.
RED EYE REMOVAL	Choose ON to remove red-eye effects caused by the flash. <ul style="list-style-type: none"> ◆ Red-eye reduction is performed only when a face is detected. ◆ Red-eye removal is not available with RAW images.

MOVIE SET-UP

Adjust movie settings (37).



Option	Description
MOVIE MODE	Select a frame size and rate for movie recording. <ul style="list-style-type: none"> • HD 1920×1080 60 fps: Full HD (60 fps) • HD 1920×1080 50 fps: Full HD (50 fps) • HD 1920×1080 30 fps: Full HD (30 fps) • HD 1920×1080 25 fps: Full HD (25 fps) • HD 1920×1080 24 fps: Full HD (24 fps) <ul style="list-style-type: none"> • HD 1280×720 60 fps: HD (60 fps) • HD 1280×720 50 fps: HD (50 fps) • HD 1280×720 30 fps: HD (30 fps) • HD 1280×720 25 fps: HD (25 fps) • HD 1280×720 24 fps: HD (24 fps)
MOVIE ISO	Choose the sensitivity for movie recording from AUTO or from settings between ISO 400 and 6400. <ul style="list-style-type: none"> ◆ This setting has no effect on photographs.
MIC LEVEL ADJUSTMENT	Adjust the microphone recording level.
MIC/REMOTE RELEASE	Specify whether the device connected to the microphone/remote release connector is a microphone or a remote release (38, 51).

FILM SIMULATION BKT

Choose film types for film simulation bracketing (📖 59).

IS MODE

Reduce blur. This option is available only with lenses that support image stabilization.

-  **CONTINUOUS**: Image stabilization on.
-  **SHOOTING ONLY**: Image stabilization enabled only when the shutter button is pressed halfway or the shutter is released.
- **OFF**: Image stabilization off;  appears in the display (📖 6). Recommended when using a tripod.

WIRELESS COMMUNICATION

Connect to a smartphone or tablet over a wireless network (📖 114).

- ◆ For more information, visit <http://fujifilm-dsc.com/wifi/>.

APERTURE SETTING

Choose the method used to adjust aperture when using lenses with no aperture rings.

- **AUTO +  MANUAL**: Rotate the command dial to choose the aperture. Rotate past minimum aperture to choose **A** (auto).
 - **AUTO**: Aperture is selected automatically; camera functions in exposure mode **P** (program AE) or **S** (shutter-priority AE).
 - **MANUAL**: Rotate the command dial to choose the aperture; camera functions in exposure mode **A** (aperture-priority AE) or **M** (manual).
- ◆ Aperture can not be adjusted while the view through the camera lens is zoomed in.
-

SHUTTER TYPE

Choose the shutter type. Choose the electronic shutter to mute the shutter sound.

Option	Description
MS MECHANICAL SHUTTER	Take pictures with the mechanical shutter.
ES ELECTRONIC SHUTTER	Take pictures with the electronic shutter.
MS MECHANICAL + ES ELECTRONIC	The camera chooses the shutter type according to shooting conditions.

- ◆ If **ES ELECTRONIC SHUTTER** or **MS MECHANICAL + ES ELECTRONIC** is selected, shutter speeds faster than $\frac{1}{4,000}$ s can be chosen by rotating the shutter speed dial to 4000 and then rotating the command dial.
- ◆ For information on the role of the command dial when the camera is used with lenses not equipped with an aperture ring, see “Lenses with No Aperture Rings” (p. 10).
- ◆ Regardless of the option selected, the mechanical shutter is used for motion panoramas. When the electronic shutter is used, shutter speed and sensitivity are restricted to values of $\frac{1}{32,000}$ –1 s and ISO 6400–200 respectively, and long exposure noise reduction has no effect. In burst mode, focus and exposure are fixed at the values for the first shot in each burst.
- ⓘ Distortion may be visible in shots of moving subjects with electronic shutter, while banding and fog may occur in shots taken under fluorescent lights or other flickering or erratic illumination. When taking pictures with the shutter muted, respect your subjects’ image rights and right to privacy.

Using the Menus: Playback Mode

To display the playback menu, press **MENU/OK** in playback mode. Highlight items and press the selector right to view options, then highlight an option and press **MENU/OK**. Press **DISP/BACK** to exit when settings are complete.

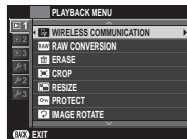

Playback Menu Options

WIRELESS COMMUNICATION

Connect to a smartphone or tablet over a wireless network (📖 114).

🔍 For more information, visit <http://app.fujifilm-dsc.com>.

RAW CONVERSION

Create JPEG copies of RAW pictures (📖 75).





ERASE

Delete all or selected pictures.

- **FRAME:** Press the selector left or right to scroll through pictures and press **MENU/OK** to delete the current picture (a confirmation dialog is not displayed).
- **SELECTED FRAMES:** Highlight pictures and press **MENU/OK** to select or deselect. When the operation is complete, press **DISP/BACK** to display a confirmation dialog, then highlight **OK** and press **MENU/OK**.
- **ALL FRAMES:** A confirmation dialog will be displayed; highlight **OK** and press **MENU/OK** to delete all unprotected pictures.

 **CROP**

Create a cropped copy of the current picture.

- 1 Display the desired picture.
 - 2 Select  **CROP** in the playback menu.
 - 3 Use the  and  buttons to zoom in and out and press the selector up, down, left, or right to scroll the picture until the desired portion is displayed.
 - 4 Press **MENU/OK** to display a confirmation dialog.
 - 5 Press **MENU/OK** again to save the cropped copy to a separate file.
- ◆ Larger crops produce larger copies; all copies have an aspect ratio of 3:2. If the size of the final copy will be , **OK** will be displayed in yellow.

 **RESIZE**

Create a small copy of the current picture.

- 1 Display the desired picture.
 - 2 Select  **RESIZE** in the playback menu.
 - 3 Highlight a size and press **MENU/OK** to display a confirmation dialog.
 - 4 Press **MENU/OK** again to save the resized copy to a separate file.
- ◆ The sizes available vary with the size of the original image.

PROTECT

Protect pictures from accidental deletion. Highlight one of the following options and press **MENU/OK**.





- **FRAME**: Protect selected pictures. Press the selector left or right to view pictures and press **MENU/OK** to select or deselect. Press **DISP/BACK** when the operation is complete.
 - **SET ALL**: Protect all pictures.
 - **RESET ALL**: Remove protection from all pictures.
- ① Protected pictures will be deleted when the memory card is formatted ( 110).

IMAGE ROTATE

Rotate pictures.

- 1 Display the desired picture.
 - 2 Select  **IMAGE ROTATE** in the playback menu.
 - 3 Press the selector down to rotate the picture 90° clockwise, up to rotate it 90° counterclockwise.
 - 4 Press **MENU/OK**. The picture automatically be displayed in the selected orientation whenever it is played back on the camera.
- ❖ Protected pictures can not be rotated. Remove protection before rotating pictures.
 - ❖ The camera may not be able to rotate pictures created with other devices. Pictures rotated on the camera will not be rotated when viewed on a computer or on other cameras.
 - ❖ Pictures taken with  **SCREEN SET-UP > AUTOROTATE PB** are automatically displayed in the correct orientation during playback ( 105).
-







 RED EYE REMOVAL

Remove red-eye from portraits. The camera will analyze the image; if red-eye is detected, the image will be processed to create a copy with reduced red-eye.

1 Display the desired picture.



2 Select ** RED EYE REMOVAL** in the playback menu.

3 Press **MENU/OK**.

-  Red eye may not be removed if the camera is unable to detect a face or the face is in profile. Results may differ depending on the scene. Red eye can not be removed from pictures that have already been processed using red-eye removal or pictures created with other devices.
-  The amount of time needed to process the image varies with the number of faces detected.
-  Copies created with ** RED EYE REMOVAL** are indicated by a **** icon during playback.
-  Red eye removal can not be performed on RAW images.

 SLIDE SHOW

View pictures in an automated slide show. Choose the type of show and press **MENU/OK** to start. Press **DISP/BACK** at any time during the show to view on-screen help. The show can be ended at any time by pressing **MENU/OK**.

Option	Description
NORMAL	Press the selector left or right to go back or skip ahead one frame. Select FADE-IN for fade transitions between frames.
FADE-IN	
NORMAL 	As above, except that camera automatically zooms in on faces.
FADE-IN 	
MULTIPLE	Display several pictures at once.

-  The camera will not turn off automatically while a slide show is in progress.

PHOTOBOOK ASSIST

Create books from your favorite photos (📖 84).

MARK FOR UPLOAD TO

Select pictures for upload to YouTube, Facebook or MyFinePix.com using MyFinePix Studio (Windows only).

- 1 Select **YouTube** to choose movies for upload to YouTube, **Facebook** to choose photos and movies for upload to Facebook, or **MyFinePix.com** to choose photos for upload to MyFinePix.com.
 - 2 Press the selector left or right to display pictures and press **MENU/OK** to select or deselect. Press **DISP/BACK** to exit when all the desired pictures are selected.
- ◆ Only movies can be selected for upload to YouTube.
 - ◆ Only photos can be selected for upload to MyFinePix.com.
 - ◆ During playback, selected pictures are indicated by 📺 **YouTube**, 📘 **Facebook** or 🌐 **MyFinepix.com** icons.
 - ◆ Choose **RESET ALL** to deselect all pictures. If the number of pictures affected is very large, some time may be required to complete the operation. Press **DISP/BACK** to exit before the operation is complete.

📺 Uploading Pictures (Windows Only)

Selected pictures can be uploaded using the **YouTube/Facebook/MyFinePix.com Upload** option in MyFinePix Studio. For information on installing MyFinePix Studio and connecting the camera to a computer, see "Viewing Pictures on a Computer" (📖 115).

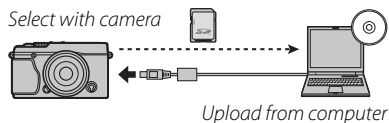

IMAGE SEARCH

Search for pictures (📖 86).

PC AUTO SAVE

Upload pictures to a computer over a wireless network (📖 114).

◆ For more information, visit <http://app.fujifilm-dsc.com>.

PRINT ORDER (DPOF)

Select pictures for printing on DPOF- and PictBridge-compatible devices (📖 120).

instax PRINTER PRINT

Print pictures on optional FUJIFILM instax SHARE printers (📖 124).

DISP ASPECT

Choose how **H**igh **D**efinition (HD) devices display pictures with an aspect ratio of 3:2 (this option is available only when an HDMI cable is connected). Select 16:9 to display the image so that it fills the screen with its top and bottom cropped out, 3:2 to display the entire image with black bands at either side.

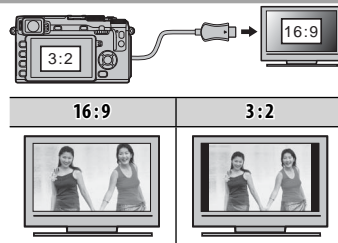

The Setup Menu

Using the Setup Menu

1 Display the setup menu.

1.1 Press **MENU/OK** to display the menu for the current mode.



1.2 Press the selector left to highlight the tab for the current menu.



1.3 Press the selector down to highlight the setup menu tab containing the desired option.

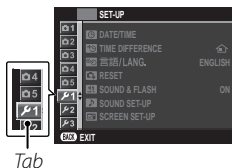

1.4 Press the selector right to place the cursor in the setup menu.



2 Adjust settings.

Highlight items and press the selector right to view options, then highlight an option and press **MENU/OK**. Press **DISP/BACK** to exit when settings are complete.

Setup Menu Options





DATE/TIME

Set the camera clock (🗨 21).

TIME DIFFERENCE

Switch the camera clock instantly from your home time zone to the local time at your destination when traveling. To specify the difference between local time and your home time zone:





- 1 Highlight  **LOCAL** and press **MENU/OK**.
- 2 Use the selector to choose the time difference between local time and your home time zone. Press **MENU/OK** when settings are complete.

To set the camera clock to local time, highlight  **LOCAL** and press **MENU/OK**. To set the clock to the time in your home time zone, select  **HOME**. If  **LOCAL** is selected,  will be displayed for three seconds when the camera is turned on.

言語/LANG.

Choose a language (🗨 21).

RESET

Reset shooting or setup menu options to default values. Custom white balance, custom settings banks created using  **EDIT/SAVE CUSTOM SETTING**,  **WIRELESS SETTINGS**, and the setup menu  **DATE/TIME**,  **TIME DIFFERENCE** options are not affected.

- 1 Highlight the desired option and press the selector right.
- 2 A confirmation dialog will be displayed; highlight **OK** and press **MENU/OK**.

SOUND & FLASH

Select **OFF** to disable the speaker, flash, and illuminator in situations in which camera sounds or lights may be unwelcome.  appears in the display when **OFF** is selected.

SOUND SET-UP

Adjust sound settings.















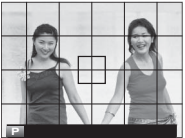

Option	Description
OPERATION VOL.	Adjust the volume of the sounds produced when camera controls are operated. Choose OFF (mute) to disable control sounds.
SHUTTER VOLUME	Adjust the volume of the sounds produced when the shutter is released. Choose OFF (mute) to disable the shutter sound.
SHUTTER SOUND	Choose the sound made by the shutter.
PLAYBACK VOLUME	Adjust the volume for movie playback.

SCREEN SET-UP

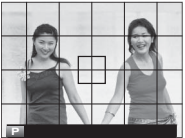
Adjust display settings.

Option	Description									
IMAGE DISP.	Choose how long images are displayed after shooting. Colors may differ slightly from those in the final image and “noise” mottling may be visible at high sensitivities.									
	<table border="1"> <thead> <tr> <th>Option</th> <th>Description</th> </tr> </thead> <tbody> <tr> <td>CONTINUOUS</td> <td>Pictures are displayed until the MENU/OK button is pressed or the shutter button is pressed halfway. To zoom in on the active focus point, press the center of the command dial; press again to cancel zoom.</td> </tr> <tr> <td>1.5 SEC</td> <td rowspan="2">Pictures are displayed for 1.5 seconds (1.5 SEC) or 0.5 seconds (0.5 SEC) or until the shutter button is pressed halfway.</td> </tr> <tr> <td>0.5 SEC</td> </tr> <tr> <td>OFF</td> <td>Pictures are not displayed after shooting.</td> </tr> </tbody> </table>	Option	Description	CONTINUOUS	Pictures are displayed until the MENU/OK button is pressed or the shutter button is pressed halfway. To zoom in on the active focus point, press the center of the command dial; press again to cancel zoom.	1.5 SEC	Pictures are displayed for 1.5 seconds (1.5 SEC) or 0.5 seconds (0.5 SEC) or until the shutter button is pressed halfway.	0.5 SEC	OFF	Pictures are not displayed after shooting.
	Option	Description								
	CONTINUOUS	Pictures are displayed until the MENU/OK button is pressed or the shutter button is pressed halfway. To zoom in on the active focus point, press the center of the command dial; press again to cancel zoom.								
	1.5 SEC	Pictures are displayed for 1.5 seconds (1.5 SEC) or 0.5 seconds (0.5 SEC) or until the shutter button is pressed halfway.								
0.5 SEC										
OFF	Pictures are not displayed after shooting.									
EVF AUTOROTATE DISPLAYS	Choose whether the indicators in the viewfinder rotate to match camera orientation (24). Regardless of the option selected, the indicators in the monitor do not rotate.									
PREVIEW EXP. IN MANUAL MODE	Select ON to enable exposure preview in manual exposure mode. Select OFF when using the flash or on other occasions on which exposure may change when the picture is taken.									

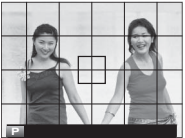
 SCREEN SET-UP (Continued)

Option	Description					
EVF BRIGHTNESS	Adjust the brightness of the display in the electronic viewfinder.					
LCD BRIGHTNESS	Adjust monitor brightness.					
PREVIEW PIC. EFFECT	<p>Choose ON to preview the effects of film simulation, white balance, and other settings in the monitor. Choose OFF to make shadows in low-contrast, back-lit scenes and other hard-to-see subjects more visible.</p> <p>◆ If OFF is selected, the effects of camera settings will not be visible in the monitor and colors and tone will differ from those in the final picture. The display will however be adjusted to show the effects of advanced filters and of monochrome and sepia settings.</p>					
FRAMING GUIDELINE	Choose the type of framing grid available in shooting mode.					
	<table border="1"> <thead> <tr> <th data-bbox="311 425 611 456"> GRID 9</th> <th data-bbox="611 425 911 456"> GRID 24</th> <th data-bbox="911 425 1212 456"> HD FRAMING</th> </tr> </thead> <tbody> <tr> <td data-bbox="311 456 611 707">  <p data-bbox="323 619 596 645"><i>For "rule of thirds" composition.</i></p> </td> <td data-bbox="611 456 911 707">  <p data-bbox="685 619 843 645"><i>A six-by-four grid.</i></p> </td> <td data-bbox="911 456 1212 707">  <p data-bbox="922 619 1212 697"><i>Frame HD pictures in the crop shown by the lines at the top and bottom of the display.</i></p> </td> </tr> </tbody> </table>	 GRID 9	 GRID 24	 HD FRAMING	 <p data-bbox="323 619 596 645"><i>For "rule of thirds" composition.</i></p>	 <p data-bbox="685 619 843 645"><i>A six-by-four grid.</i></p>
 GRID 9	 GRID 24	 HD FRAMING				
 <p data-bbox="323 619 596 645"><i>For "rule of thirds" composition.</i></p>	 <p data-bbox="685 619 843 645"><i>A six-by-four grid.</i></p>	 <p data-bbox="922 619 1212 697"><i>Frame HD pictures in the crop shown by the lines at the top and bottom of the display.</i></p>				
AUTOROTATE PB	Choose ON to automatically rotate "tall" (portrait-orientation) pictures during playback.					
FOCUS CHECK	If ON is selected, the camera will automatically zoom in on the view through the lens when the focus ring is rotated in manual focus mode (📖 66).					
FOCUS SCALE UNITS	Choose the units used for the focus distance indicator (📖 66).					
DISP. CUSTOM SETTING	Choose items for the standard display (📖 26).					

🔘 BUTTON/DIAL SETTING

Choose the roles played by camera controls.

Option	Description						
FUNCTION (Fn) SETTING	Choose the roles played by the function buttons (📖 44).						
SELECTOR BUTTON SETTING	Choose the roles played by the up, down, left, and right buttons on the selector.						
	<table border="1"> <thead> <tr> <th>Option</th> <th>Description</th> </tr> </thead> <tbody> <tr> <td>Fn BUTTON</td> <td>The selector buttons serve as function buttons.</td> </tr> <tr> <td>FOCUS AREA</td> <td>The selector buttons can be used to position the focus area.</td> </tr> </tbody> </table>	Option	Description	Fn BUTTON	The selector buttons serve as function buttons.	FOCUS AREA	The selector buttons can be used to position the focus area.
	Option	Description					
Fn BUTTON	The selector buttons serve as function buttons.						
FOCUS AREA	The selector buttons can be used to position the focus area.						
EDIT/SAVE QUICK MENU	Choose the options displayed in the quick menu (📖 42).						
COMMAND DIAL SETTING	Choose whether the command dial controls shutter speed (S.S. , the default option) or aperture (F). 👉 This option only takes effect with lenses that are not equipped with an aperture ring.						
AE-L/AF-L BUTTON SETTING	Switch the roles of the AF-L and AE-L buttons.						

🔘 FOCUS RING

Choose the direction in which the focus ring is rotated to increase the focus distance.

🔘 POWER MANAGEMENT

Adjust power management settings.

Option	Description
AUTO POWER OFF	Choose the length of time before the camera turns off automatically when no operations are performed. Shorter times increase battery life; if OFF is selected, the camera must be turned off manually. Note that in some situations the camera turns off automatically even when OFF is selected.
HIGH PERFORMANCE	Select ON for faster focus and to reduce the time needed to restart the camera after it has been turned off.

SENSOR CLEANING

Remove dust from the camera image sensor.

- **OK:** Clean sensor immediately (📖 xi).
 - **WHEN SWITCHED ON:** If this option is selected, sensor cleaning will be performed when the camera turns on.
 - **WHEN SWITCHED OFF:** If this option is selected, sensor cleaning will be performed when the camera turns off (sensor cleaning is not however performed if the camera turns off in playback mode).
- 💡 Dust that can not be removed using sensor cleaning can be removed manually (📖 131).

SAVE DATA SET-UP

Adjust file management settings.

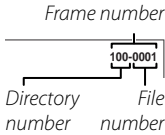
Option	Description	
FRAME NO.	New pictures are stored in image files named using a four-digit file number assigned by adding one to the last file number used. The file number is displayed during playback as shown at right. FRAME NO. controls whether file numbering is reset to 0001 when a new memory card is inserted or the current memory card is formatted.	
		
	Option	Description
	CONTINUOUS	Numbering continues from the last file number used or the first available file number, whichever is higher. Choose this option to reduce the number of pictures with duplicate file names.
RENEW	Numbering is reset to 0001 after formatting or when a new memory card is inserted.	
	<p>💡 If the frame number reaches 999-9999, the shutter release will be disabled (📖 138).</p> <p>💡 Selecting RESET (📖 103) sets FRAME NO. to CONTINUOUS but does not reset the file number.</p> <p>💡 Frame numbers for pictures taken with other cameras may differ.</p>	
SAVE ORG IMAGE	Choose ON to save unprocessed copies of pictures taken using RED EYE REMOVAL .	
EDIT FILE NAME	Change the file name prefix. sRGB images use a four-letter prefix (default "DSCF"), Adobe RGB images a three-letter prefix ("DSF") preceded by an underscore.	

COLOR SPACE

Choose the gamut of colors available for color reproduction.





Option	Description
sRGB	Recommended in most situations.
Adobe RGB	For commercial printing.

EVF/LCD SETTING

Choose a display ( 23).

📶 CONNECTION SETTING

Adjust settings for connection to wireless devices, including smartphones, computers, and FUJIFILM instax SHARE printers.

Option	Description								
WIRELESS SETTINGS	Adjust settings for connection to wireless networks.								
	<table border="1"> <thead> <tr> <th>Option</th> <th>Description</th> </tr> </thead> <tbody> <tr> <td>GENERAL SETTINGS</td> <td>Choose a name (NAME) to identify the camera on the wireless network (the camera is assigned a unique name by default) or select RESET WIRELESS SETTINGS to restore default settings.</td> </tr> <tr> <td>RESIZE IMAGE FOR SMARTPHONE </td> <td>Choose ON (the default setting, recommended in most circumstances) to resize larger images to 3M for upload to smartphones, OFF to upload images at their original size. Resizing applies only to the copy uploaded to the smartphone; the original is not affected.</td> </tr> <tr> <td>PC AUTO SAVE SETTINGS</td> <td>Choose DELETE REGISTERED DESTINATION PC to remove selected destinations, DETAILS OF PREVIOUS CONNECTION to view computers to which the camera has recently connected.</td> </tr> </tbody> </table>	Option	Description	GENERAL SETTINGS	Choose a name (NAME) to identify the camera on the wireless network (the camera is assigned a unique name by default) or select RESET WIRELESS SETTINGS to restore default settings.	RESIZE IMAGE FOR SMARTPHONE 	Choose ON (the default setting, recommended in most circumstances) to resize larger images to 3M for upload to smartphones, OFF to upload images at their original size. Resizing applies only to the copy uploaded to the smartphone; the original is not affected.	PC AUTO SAVE SETTINGS	Choose DELETE REGISTERED DESTINATION PC to remove selected destinations, DETAILS OF PREVIOUS CONNECTION to view computers to which the camera has recently connected.
	Option	Description							
	GENERAL SETTINGS	Choose a name (NAME) to identify the camera on the wireless network (the camera is assigned a unique name by default) or select RESET WIRELESS SETTINGS to restore default settings.							
RESIZE IMAGE FOR SMARTPHONE 	Choose ON (the default setting, recommended in most circumstances) to resize larger images to 3M for upload to smartphones, OFF to upload images at their original size. Resizing applies only to the copy uploaded to the smartphone; the original is not affected.								
PC AUTO SAVE SETTINGS	Choose DELETE REGISTERED DESTINATION PC to remove selected destinations, DETAILS OF PREVIOUS CONNECTION to view computers to which the camera has recently connected.								
PC AUTO SAVE SETTING	Choose an upload destination. Choose SIMPLE SETUP to connect using WPS, MANUAL SETUP to configure network settings manually.								
GEOTAGGING SET-UP	View location data downloaded from a smartphone and choose whether to save the data with your pictures.								
	<table border="1"> <thead> <tr> <th>Option</th> <th>Description</th> </tr> </thead> <tbody> <tr> <td>GEOTAGGING</td> <td>Choose whether location data downloaded from a smartphone are embedded in pictures as they are taken.</td> </tr> <tr> <td>LOCATION INFO</td> <td>Display the location data last downloaded from a smartphone.</td> </tr> </tbody> </table>	Option	Description	GEOTAGGING	Choose whether location data downloaded from a smartphone are embedded in pictures as they are taken.	LOCATION INFO	Display the location data last downloaded from a smartphone.		
	Option	Description							
GEOTAGGING	Choose whether location data downloaded from a smartphone are embedded in pictures as they are taken.								
LOCATION INFO	Display the location data last downloaded from a smartphone.								
instax PRINTER CONNECTION SETTING	Adjust settings for connection to optional FUJIFILM instax SHARE printers ( 123).								

📌 For more information on wireless connections, visit <http://fujifilm-dsc.com/wifi/>



FORMAT

To format the memory card:

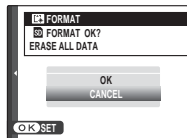







- 1 Highlight  **FORMAT** in the setup menu and press **MENU/OK**.
 - 2 A confirmation dialog will be displayed. To format the memory card, highlight **OK** and press **MENU/OK**.
To exit without formatting the memory card, select **CANCEL** or press **DISP/BACK**.
- ⓘ All data—including protected pictures—will be deleted from the memory card. Be sure important files have been copied to a computer or other storage device.
- ⓘ Do not open the battery-chamber cover during formatting.

























Factory Defaults













The factory default settings for the options in the shooting and setup menus are listed below. These settings can be restored using the  **RESET** option in the setup menu ( 103).

Shooting Menu

Menu	Default
 ADVANCED FILTER	 TOY CAMERA
 AUTOFOCUS SETTING	
AF MODE	 ZONE
RELEASE/FOCUS PRIORITY	<ul style="list-style-type: none"> • AF-S PRIORITY SELECTION: RELEASE • AF-C PRIORITY SELECTION: RELEASE
INSTANT AF SETTING	AF-S
AF+MF	OFF
FACE DETECTION	OFF
EYE DETECTION AF	 AUTO
PRE-AF	OFF
AF ILLUMINATOR	ON
 ISO	200
 IMAGE SIZE	 3:2
 IMAGE QUALITY	FINE

Menu	Default
 DYNAMIC RANGE	 100%
 FILM SIMULATION	 PROVIA/STANDARD
 SELF-TIMER	OFF
 WHITE BALANCE	AUTO
 COLOR	(0) MID
 SHARPNESS	(0) STANDARD
 HIGHLIGHT TONE	(0) STANDARD
 SHADOW TONE	(0) STANDARD
 NOISE REDUCTION	(0) STANDARD
 LONG EXPOSURE NR	ON
 LENS MODULATION OPTIMIZER	ON
 MOUNT ADAPTOR SETTING	LENS 5 (50mm)

Menu	Default
 SHOOT WITHOUT LENS	OFF
 MF ASSIST	STANDARD
 AE/AF-LOCK MODE	AE&AF ON WHEN PRESSING
 AF-LOCK MODE	AF LOCK ONLY
 PHOTOMETRY	 MULTI
 INTERLOCK SPOT AE & FOCUS AREA	ON
 FLASH SET-UP	
FLASH MODE	AUTO
FLASH COMPENSATION	±0
RED EYE REMOVAL	OFF

Menu	Default
 MOVIE SET-UP	
MOVIE MODE	 1920 × 1080 60 fps
MOVIE ISO	AUTO
MIC LEVEL ADJUSTMENT	3
MIC/REMOTE RELEASE	 MIC
 IS MODE	 CONTINUOUS
 FILM SIMULATION BKT	
FILM 1	 PROVIA/STANDARD
FILM 2	 Velvia/VIVID
FILM 3	 ASTIA/SOFT
 APERTURE SETTING	AUTO +  MANUAL
 SHUTTER TYPE	MS MECHANICAL SHUTTER

■ Setup Menu

Menu	Default
SOUND & FLASH	ON
SOUND SET-UP	
OPERATION VOL.	
SHUTTER VOLUME	
SHUTTER SOUND	1 SOUND 1
PLAYBACK VOLUME	7
SCREEN SET-UP	
IMAGE DISP.	OFF
EVF AUTOROTATE DISPLAYS	ON
PREVIEW EXP. IN MANUAL MODE	ON
EVF BRIGHTNESS	0
LCD BRIGHTNESS	0
PREVIEW PIC. EFFECT	ON
FRAMING GUIDELINE	GRID 9
AUTOROTATE PB	ON
FOCUS CHECK	OFF
FOCUS SCALE UNITS	METERS
DISP. CUSTOM SETTING	<ul style="list-style-type: none"> • FRAMING GUIDELINE: <input type="checkbox"/> • ELECTRONIC LEVEL: <input type="checkbox"/> • AF DISTANCE INDICATOR: <input type="checkbox"/> • HISTOGRAM: <input type="checkbox"/> • All other options: <input checked="" type="checkbox"/>

Menu	Default
BUTTON/DIAL SETTING	
FUNCTION (Fn) SETTING	See page 43.
SELECTOR BUTTON SETTING	Fn BUTTON
EDIT/SAVE QUICK MENU	See page 40.
AE-L/AF-L BUTTON SETTING	AE-L/AF-L
FOCUS RING	CW
POWER MANAGEMENT	
AUTO POWER OFF	2 MIN
HIGH PERFORMANCE	OFF
SENSOR CLEANING	
WHEN SWITCHED ON	OFF
WHEN SWITCHED OFF	ON
SAVE DATA SET-UP	
FRAME NO.	CONTINUOUS
SAVE ORG IMAGE	OFF
COLOR SPACE	sRGB
EVF/LCD SETTING	EYE SENSOR
CONNECTION SETTING	
WIRELESS SETTINGS	<ul style="list-style-type: none"> • RESIZE IMAGE FOR SMARTPHONE : ON • GEOTAGGING: ON • LOCATION INFO: ON
GEOTAGGING SET-UP	

Connections

Wireless Transfer

Access wireless networks and connect to computers, smartphones, or tablets. For downloads and other information, visit <http://app.fujifilm-dsc.com/>.

Wireless Connections: Smartphones

Install the “FUJIFILM Camera Remote” app on your smartphone to browse the images on the camera, download selected images, control the camera remotely, or copy location data to the camera. To connect to the smartphone, press the camera function button (**Fn7/Wi-Fi**).

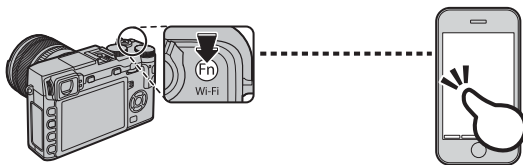

◆ You can also connect using the **WIRELESS COMMUNICATION** options in the camera shooting and playback menu.

Wireless Connections: Computers

Once you have installed the “FUJIFILM PC AutoSave” application and configured your computer as a destination for the images copied from the camera, you can upload pictures from the camera using the **PC AUTO SAVE** option in the camera playback menu or by pressing and holding the function button (**Fn7/Wi-Fi**) in playback mode.

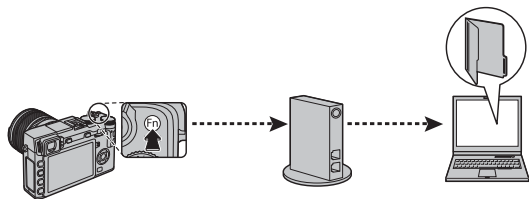

Viewing Pictures on a Computer

Read this section for information on copying pictures to a computer.

Windows

Use MyFinePix Studio to copy pictures to your computer, where they can be stored, viewed, organized, and printed. MyFinePix Studio is available for download from the following website:

<http://fujifilm-dsc.com/mfs/>

Once download is complete, double-click the downloaded file (“MFPS_Setup.EXE”) and follow the on-screen instructions to complete installation. Proceed to “Connecting the Camera” (📖 116) when installation is complete.

Macintosh

Pictures can be copied to your computer using Image Capture (supplied with your computer) or other software. Proceed to “Connecting the Camera” (📖 116).

Viewing RAW Files

To view RAW files on your computer, use the RAW FILE CONVERTER, available for download from:

<http://fujifilm-dsc.com/rfc/>

Connecting the Camera

- 1 Find a memory card containing pictures you want to copy to the computer and insert the card into the camera (📖 16).
 - ◆ Windows users may require the Windows CD when starting the software for the first time.
 - ⌚ Loss of power during transfer could result in loss of data or damage to the memory card. Insert a fresh or fully-charged battery before connecting the camera.
- 2 Turn the camera off and connect a USB cable as shown, making sure the connectors are fully inserted. Connect the camera directly to the computer; do not use a USB hub or keyboard.

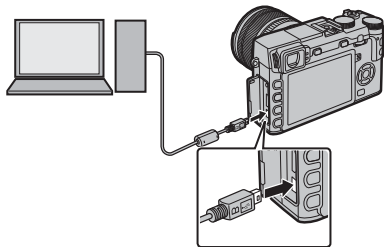

- ⌚ The USB cable must be no more than 60 cm (1.9 ft.) long and be suitable for data transfer.
- 3 Turn the camera on.
- 4 Copy pictures to the computer using MyFinePix Studio or applications provided with your operating system.

For more information on using the software, start the application and select the appropriate option from the **Help** menu.

- ❗ If a memory card containing a large number of images is inserted, there may be a delay before the software starts and you may be unable to import or save images. Use a memory card reader to transfer pictures.
- ❗ Make sure that the computer does not display a message stating that copying is in progress and that the indicator lamp is out before turning the camera off or disconnecting the USB cable (if the number of images copied is very large, the indicator lamp may remain lit after the message has cleared from the computer display). Failure to observe this precaution could result in loss of data or damage to the memory card.
- ❗ Disconnect the camera before inserting or removing memory cards.
- ❗ In some cases, it may not be possible to access pictures saved to a network server using the software in the same way as on a standalone computer.
- ❗ The user bears all applicable fees charged by the phone company or Internet service provider when using services that require an Internet connection.

Disconnecting the Camera

After confirming that the indicator lamp is out, turn the camera off and disconnect the USB cable.

Printing Pictures via USB

If the printer supports PictBridge, the camera can be connected directly to the printer and pictures can be printed without first being copied to a computer. Note that depending on the printer, not all the functions described below may be supported.



Connecting the Camera

- 1 Connect a USB cable as shown and turn the printer on.

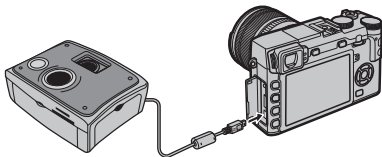

① The USB cable must be no more than 60cm (1.9ft.) long and be suitable for data transfer.

- 2 Turn the camera on.  **USB** will be displayed in the monitor, followed by the PictBridge display shown below at right.

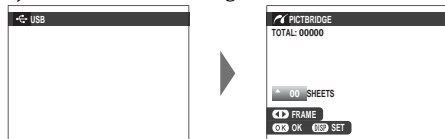

- ◆ Pictures can be printed from memory cards that has been formatted in the camera.
- ◆ Page size, print quality, and border selections are made using the printer.

Printing Selected Pictures

- 1 Press the selector left or right to display a picture you wish to print.



◆ To print one copy of the current picture, proceed directly to Step 3.

- 2 Press the selector up or down to choose the number of copies (up to 99). Repeat steps 1–2 to select additional pictures.



- 3 Press **MENU/OK** to display a confirmation dialog.

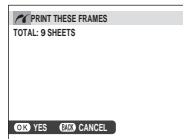



- 4 Press **MENU/OK** to start printing.



Printing the Date of Recording

To print the date of recording on pictures, press **DISP/BACK** in the PictBridge display and select **PRINT WITH DATE**  (to print pictures without the date of recording, select **PRINT WITHOUT DATE**). To ensure that the date is correct, set the camera clock before taking pictures. Some printers do not support date printing. See the printer manual for details.

Printing the DPOF Print Order

To print the print order created with  **PRINT ORDER (DPOF)** in the playback menu ( 101):

- 1 In the PictBridge display, press **DISP/BACK** to open the PictBridge menu. 
- 2 Press the selector up or down to highlight  **PRINT DPOF**. 

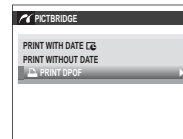

- 3 Press **MENU/OK** to display a confirmation dialog. 

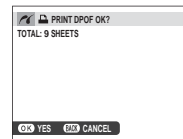

- 4 Press **MENU/OK** to start printing. 

During Printing

The message shown at right is displayed during printing. Press **DISP/BACK** to cancel before all pictures are printed (depending on the printer, printing may end before the current picture has printed).

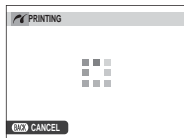

If printing is interrupted, turn the camera off and then on again.

Disconnecting the Camera

Confirm that the above message is not displayed and turn the camera off. Disconnect the USB cable.

Creating a DPOF Print Order



The  **PRINT ORDER (DPOF)** option in the playback menu can be used to create a digital “print order” for PictBridge-compatible printers or devices that support DPOF.

DPOF

DPOF (**D**igital **P**rint **O**rder **F**ormat) is standard that allows pictures to be printed from “print orders” stored on the memory card. The information in the order includes the pictures to be printed and the number of copies of each picture.



■ WITH DATE /WITHOUT DATE

To modify the DPOF print order, select  **PRINT ORDER (DPOF)** in the playback menu and press the selector up or down to highlight **WITH DATE ** or **WITHOUT DATE**.



Press **MENU/OK** and follow the steps below.

1 Press the selector left or right to display a picture you wish to include in or remove from the print order.



2 Press the selector up or down to choose the number of copies (up to 99). To remove a picture from the order, press the selector down until the number of copies is 0.

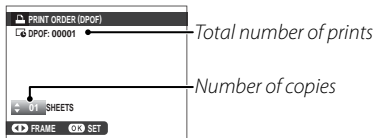

3 Repeat steps 1–2 to complete the print order. Press **MENU/OK** to save the print order when settings are complete, or **DISP/BACK** to exit without changing the print order.



4 The total number of prints is displayed in the monitor. Press **MENU/OK** to exit.



The pictures in the current print order are indicated by a  icon during playback.



■ RESET ALL

To cancel the current print order, select **RESET ALL** for **PRINT ORDER (DPOF)**. The confirmation shown at right will be displayed; press **MENU/OK** to remove all pictures from the order.

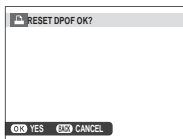

- ◆ Print orders can contain a maximum of 999 pictures.
- ◆ If a memory card is inserted containing a print order created by another camera, the message shown at right will be displayed. Pressing **MENU/OK** cancels the print order; a new print order must be created as described above.

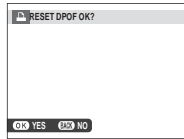

instax SHARE Printers

Print pictures from your digital camera to instax SHARE printers.

Establishing a Connection

Select **CONNECTION SETTING** > **instax PRINTER CONNECTION SETTING** in the camera setup menu and enter the instax SHARE printer name (SSID) and password.

The Printer Name (SSID) and Password

The printer name (SSID) can be found on the bottom of the printer; the default password is "1111". If you have already chosen a different password to print from a smartphone, enter that password instead.

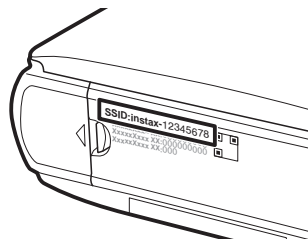



Printing Pictures

1 Turn the printer on.

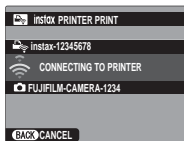

2 Select  **instax PRINTER PRINT** in the camera playback menu. The camera will connect to the printer.



◆ To print a frame from a burst sequence, display the frame before selecting  **instax PRINTER PRINT**.

3 Use the selector to display the picture you want to print, then press **MENU/OK**.

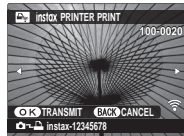

- ◆ Pictures taken with other cameras can not be printed.
- ◆ The area printed is smaller than the area visible in the LCD monitor.

4 The picture will be sent to the printer and printing will start.

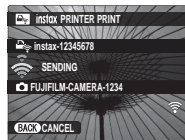

Viewing Pictures on TV

To show pictures to a group, connect the camera to a TV using an HDMI cable (available separately from third-party suppliers; note that the TV can only be used for playback, not shooting).

- 1 Turn the camera off.
- 2 Connect the cable as shown below.

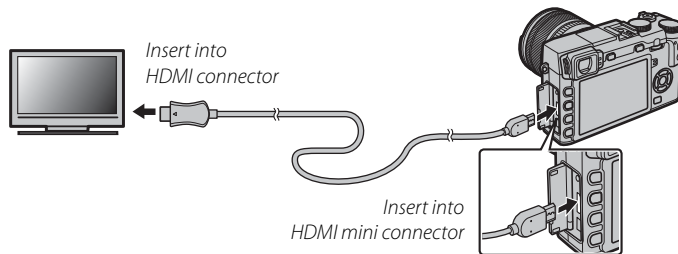

- ① Use an HDMI cable no more than 1.5 m (4.9 ft.) long.
 - ◆ Be sure the connectors are fully inserted.
- 3 Tune the television to the HDMI input channel. See the documentation supplied with the television for details.
- 4 Turn the camera on and press **▶** button. The camera monitor turns off and pictures and movies are played back on the TV. Note that the camera volume controls have no effect on sounds played on the TV; use the television volume controls to adjust the volume.
 - ◆ The USB cable can not be used while an HDMI cable is connected.
 - ◆ Some televisions may briefly display a black screen when movie playback begins.

Technical Notes

Optional Accessories

The camera supports a wide range of accessories from FUJIFILM and other manufacturers.

Accessories from FUJIFILM

The following optional accessories are available from FUJIFILM. For the latest information on the accessories available in your region, check with your local FUJIFILM representative or visit http://www.fujifilm.com/products/digital_cameras/index.html.

Rechargeable Li-ion batteries

NP-W126: Additional large-capacity NP-W126 rechargeable batteries can be purchased as required.



Battery chargers

BC-W126: Replacement battery chargers can be purchased as required. At +20°C/+68°F, the BC-W126 charges an NP-W126 in about 150 minutes.

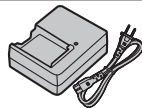

AC power adapters

AC-9V (requires CP-W126 DC coupler): Use for extended shooting and playback or when copying pictures to a computer.

DC couplers

CP-W126: Connect the AC-9V to the camera.

Remote releases

RR-90: Use to reduce camera shake or keep the shutter open during a time exposure.

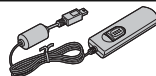
**Stereo microphones**

MIC-ST1: An external microphone for movie recording.

**FUJINON Lenses**

XF-series lenses: Interchangeable lenses for use exclusively with the FUJIFILM X-mount.



XC-series lenses: Interchangeable lenses for use exclusively with the FUJIFILM X-mount.

**Shoe-mounted flash units**

EF-20: This clip-on flash unit (powered by two AA batteries) has a Guide Number of 20/65 (ISO 100, m/ft.) and supports TTL flash control. The flash head can be rotated upwards 90° for bounce lighting.



EF-42: This clip-on flash unit (powered by four AA batteries) has a Guide Number of 42/137 (ISO 100, m/ft.) and supports TTL flash control and auto power zoom in the range 24–105 mm (35 mm format equivalent). The flash head can be rotated 90° up, 180° left, or 120° right for bounce lighting.



EF-X20: This clip-on flash unit has a Guide Number of 20/65 (ISO 100, m/ft.).



Grips

HG-XE1: Features an improved grip.

Leather cases

BLC-XE1: This case combines practicality with the luxury of leather and comes with a shoulder strap made of the same material, as well as a cloth that can be used to wrap the camera before putting it in the case and on other occasions. Pictures can be taken and batteries and memory cards inserted or removed with the camera still in its case.

Macro extension tubes

MCEX-11/16: Attach between the camera and the lens to shoot at high reproduction ratios.

Protector Filters

PRF-39/PRF-43/PRF-49S/PRF-52/PRF-58/PRF-62/PRF-67/PRF-72/PRF-77: Use to protect the lens.

Teleconverters

XF1.4X TC WR: Increases the focal length of the compatible lenses by about 1.4x.

Mount Adapters

FUJIFILM M MOUNT ADAPTER: Allows the camera to be used with a wide selection of M-mount lenses.

Front lens caps

FLCP-39/FLCP-43/FLCP-52/FLCP-58/FLCP-62/FLCP-67/FLCP-72/FLCP-72 II/FLCP-77: Protect the front lens element when the lens is not in use.

Rear lens caps

RLCP-001: Protect the rear lens element when the lens is not attached to the camera.

Body caps

BCP-001: Cover the camera lens mount when no lens is attached.

instax SHARE printers

SP-1: Connect via wireless LAN to print pictures on instax film.

Connecting the Camera to Other Devices

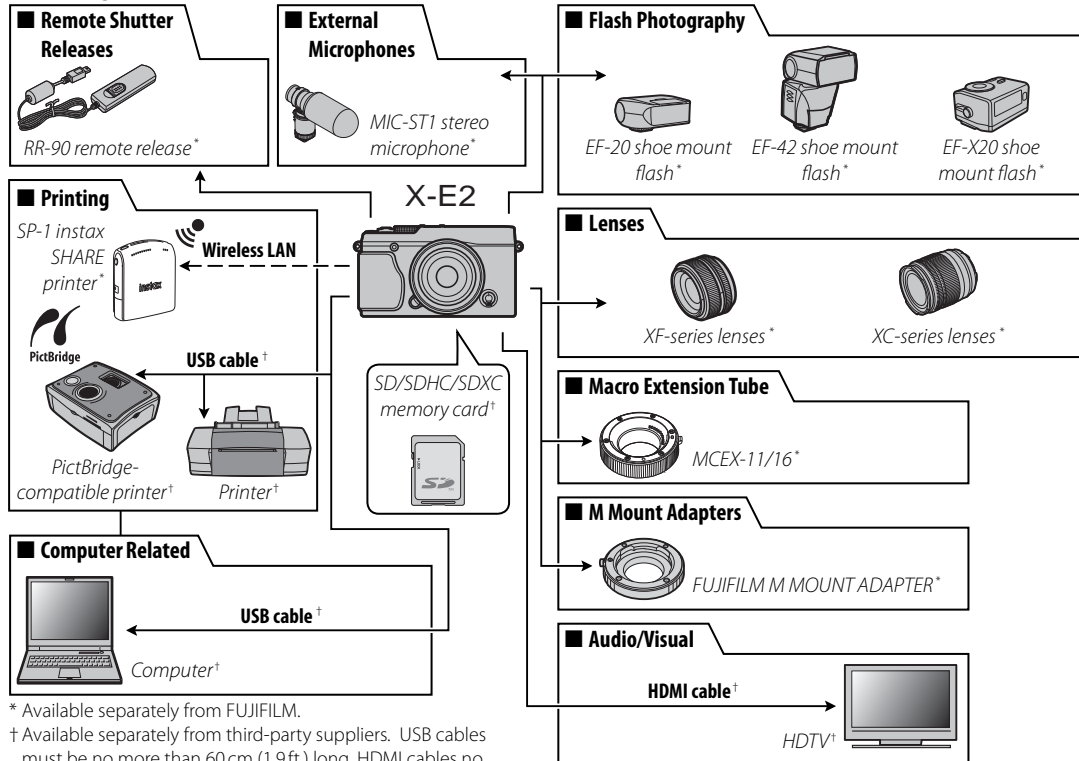

* Available separately from FUJIFILM.

† Available separately from third-party suppliers. USB cables must be no more than 60 cm (1.9ft.) long, HDMI cables no more than 1.5 m (4.9ft.) long.

Caring for the Camera

To ensure continued enjoyment of the product, observe the following precautions.

Storage and Use

If the camera will not be used for an extended period, remove the battery and memory card. Do not store or use the camera in locations that are:

- exposed to rain, steam, or smoke
- very humid or extremely dusty
- exposed to direct sunlight or very high temperatures, such as in a closed vehicle on a sunny day
- extremely cold
- subject to strong vibration
- exposed to strong magnetic fields, such as near a broadcasting antenna, power line, radar emitter, motor, transformer, or magnet
- in contact with volatile chemicals such as pesticides
- next to rubber or vinyl products

■ Water and Sand

Exposure to water and sand can also damage the camera and its internal circuitry and mechanisms. When using the camera at the beach or seaside, avoid exposing the camera to water or sand. Do not place the camera on a wet surface.

■ Condensation

Sudden increases in temperature, such as occur when entering a heated building on a cold day, can cause condensation inside the camera. If this occurs, turn the camera off and wait an hour before turning it on again. If condensation forms on the memory card, remove the card and wait for the condensation to dissipate.

Traveling

Keep the camera in your carry-on baggage. Checked baggage may suffer violent shocks that could damage the camera.

Cleaning the Image Sensor

Multiple photographs marred by spots or blotches in identical locations may indicate the presence of dust on the camera image sensor. Clean the sensor using the  **SENSOR CLEANING** option in the setup menu (📖 107); if the problem persists, you can clean the sensor manually as described below. Note that there will be a charge to repair or replace the image sensor if it is damaged during cleaning.

- 1 Use a blower (not a brush) to remove dust from the sensor.

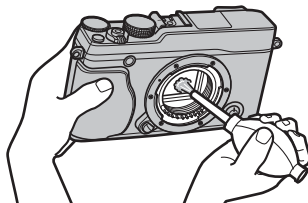

- ⓘ Do not use a brush or blower brush. Failure to observe this precaution could damage the sensor.
- 2 Check whether the dust has been successfully removed.
 - ◆ Repeat Steps 1 and 2 as necessary.
- 3 Replace the body cap or lens.

Troubleshooting

Problems and Solutions

■ Power and Battery



Problem	Solution
The camera does not turn on.	<ul style="list-style-type: none">• The battery is exhausted: Charge the battery (📖 15) or insert a fully-charged spare battery (📖 16).• The battery is inserted incorrectly: Reinsert in the correct orientation (📖 16).• The battery-chamber cover is not latched: Latch the battery-chamber cover (📖 17).
The monitor does not turn on.	The monitor may not turn on if the camera is turned off and then on again very quickly. Press the shutter button halfway to activate the monitor.
The battery runs down quickly.	<ul style="list-style-type: none">• The battery is cold: Warm the battery by placing it in a pocket or other warm place and reinsert it in the camera immediately before taking a picture.• There is dirt on the battery terminals: Clean the terminals with a soft, dry cloth.• ON is selected for [Fn] AUTOFOCUS SETTING > PRE-AF: Turn PRE-AF off (📖 89).• The battery has been charged many times: The battery has reached the end of its charging life. Purchase a new battery.
The camera turns off suddenly.	The battery is exhausted: Charge the battery (📖 15) or insert a fully-charged spare battery (📖 16).
Charging does not start.	Reinsert the battery in the correct orientation and make sure that the charger is plugged in (📖 15).
Charging is slow.	Charge the battery at room temperature (📖 v).
The charging lamp blinks, but the battery does not charge.	<ul style="list-style-type: none">• There is dirt on the battery terminals: Clean the terminals with a soft, dry cloth.• The battery has been charged many times: The battery has reached the end of its charging life. Purchase a new battery. If the battery still fails to charge, contact your FUJIFILM dealer.

■ Menus and Displays









Problem	Solution
Display is not in English.	Select ENGLISH for  言語/LANG. (📖 103).

■ Shooting

Problem	Solution
No picture is taken when the shutter button is pressed.	<ul style="list-style-type: none"> • The memory card is full: Insert a new memory card or delete pictures (📖 16, 34). • The memory card is not formatted: Format the memory card (📖 110). • There is dirt on the memory card contacts: Clean the contacts with a soft, dry cloth. • The memory card is damaged: Insert a new memory card (📖 16). • The battery is exhausted: Charge the battery (📖 15) or insert a fully-charged spare battery (📖 16). • The camera has turned off automatically: Turn the camera on (📖 20). • The indicator lamp was orange when you attempted to record a panorama: Wait until the indicator lamps turns off (📖 4).
Mottling (“noise”) appears in the monitor or viewfinder when the shutter button is pressed halfway.	Gain is increased to aid composition when the subject is poorly lit and aperture is stopped down, which may result in noticeable mottling when images are previewed in the displays. Images taken with the camera are unaffected.
The camera does not focus.	The subject is not suited to autofocus: Use focus lock (📖 53) or manual focus (📖 65).
Intelligent Face Detection is not available.	Intelligent Face Detection is not available in the current shooting mode: Choose a different shooting mode (📖 148).
No face is detected.	<ul style="list-style-type: none"> • The subject’s face is obscured by sunglasses, a hat, long hair, or other objects: Remove the obstructions. • The subject’s face occupies only a small area of the frame: Change the composition so that the subject’s face occupies a larger area of the frame. • The subject’s head is tilted or horizontal: Ask the subject to hold their head straight. • The camera is tilted: Keep the camera level. • The subject’s face is poorly lit: Shoot in bright light.
Wrong subject is selected.	The selected subject is closer to the center of the frame than the main subject. Recompose the picture or turn face detection off and frame the picture using focus lock (📖 53).

Problem	Solution
The flash does not fire.	<ul style="list-style-type: none"> • The flash can not be used at current settings: See the list of the settings that can be used with the flash (📖 148). • The flash is lowered: Raise the flash (📖 35). • The battery is exhausted: Charge the battery (📖 15) or insert a fully-charged spare battery (📖 16). • The camera is in bracketing or continuous mode: Select single frame mode (📖 57). • OFF is selected for  SOUND & FLASH: Select ON (📖 103).
Some flash modes are not available.	<p>OFF is selected for  SOUND & FLASH: Select ON (📖 103).</p>
The flash does not fully light the subject.	<ul style="list-style-type: none"> • The subject is not in range of the flash: Position the subject in range of the flash (📖 144). • The flash window is obstructed: Hold the camera correctly (📖 29). • Shutter speed is faster than $\frac{1}{180}$ s: Choose a slower shutter speed (📖 36, 47, 49).
Pictures are blurred.	<ul style="list-style-type: none"> • The lens is dirty: Clean the lens (📖 xi). • The lens is blocked: Keep objects away from the lens. • !AF is displayed during shooting and the focus frame is displayed in red: Check focus before shooting (📖 29).
Pictures are mottled.	<ul style="list-style-type: none"> • Shutter speed is slow and the ambient temperature is high: This is normal and does not indicate a malfunction. • The camera has been used continuously at high temperatures or a temperature warning is displayed: Turn the camera off and wait for it to cool down.

■ Playback













Problem	Solution
Pictures are grainy.	The pictures were taken with a different make or model of camera.
Playback zoom is unavailable.	The pictures were created using  RESIZE or with a different make or model of camera.
No sound in movie playback.	<ul style="list-style-type: none"> • Playback volume is too low: Adjust playback volume ( 104). • The microphone was obstructed: Hold the camera correctly during recording ( 2, 37). • The speaker is obstructed: Hold the camera correctly during playback ( 2, 39). • OFF is selected for  SOUND & FLASH: Select ON ( 103).
Selected pictures are not deleted.	Some of the pictures selected for deletion are protected. Remove protection using the device with which it was originally applied ( 98).
File numbering is unexpectedly reset.	The battery-chamber cover was opened while the camera was on. Turn the camera off before opening the battery-chamber cover ( 16, 20).

■ Connections/Miscellaneous

For additional information on troubleshooting wireless connections, visit:



http://faq.fujifilm.com/digitalcamera/faq_product.html?pid=X

Problem	Solution
Problem connecting or uploading pictures to smartphone.	<ul style="list-style-type: none"> • The smartphone is too far away: Move the devices closer. • Nearby devices are causing radio interference: Move the camera and smartphone away from microwave ovens or cordless phones.
Can not upload images.	<ul style="list-style-type: none"> • The smartphone is connected to another device: The smartphone and camera can connect to only one device at a time. End the connection and try again. • There are several smartphones in the vicinity: Try connecting again. The presence of multiple smartphones can make connection difficult. • The current image is a movie or was created on another device and can not be uploaded to a smartphone.





Problem	Solution
Smartphone will not display pictures.	Select ON for  CONNECTION SETTING > WIRELESS SETTING > RESIZE IMAGE FOR SMARTPHONE  . Selecting OFF increases upload times for larger images; in addition, some phones may not display images over a certain size.
No picture or sound on TV.	<ul style="list-style-type: none"> • The camera is not properly connected: Connect the camera properly ( 125). Note that once the camera is connected, pictures will be displayed on the TV instead of in the camera monitor. • Input on the television is set to "TV": Set input to "HDMI". • The volume on the TV is too low: Use the controls on the television to adjust the volume.
The computer does not recognize the camera.	Be sure the camera and computer are correctly connected ( 116).
Can not transfer RAW or JPEG files to computer.	Use MyFinePix Studio to transfer pictures (Windows only;  115).
Pictures can not be printed.	<ul style="list-style-type: none"> • The camera is not properly connected: Connect the camera correctly ( 118). • The printer is off: Turn the printer on.
Only one copy is printed/ the date is not printed.	The printer is not PictBridge compatible.
The camera is unresponsive.	<ul style="list-style-type: none"> • Temporary camera malfunction: Remove and reinsert the battery ( 16, 18). • The battery is exhausted: Charge the battery ( 15) or insert a fully-charged spare battery ( 16). • The camera is connected to a wireless LAN: End the connection.
The camera does not function as expected.	Remove and reinsert the battery ( 16, 18). If the problem persists, contact your FUJIFILM dealer.
No sound.	Select ON for  SOUND & FLASH ( 103).

Warning Messages and Displays

The following warnings appear in the display.

Warning	Description
 (red)	Low battery. Charge the battery (📖 15) or insert a fully-charged spare battery (📖 16).
 (blinks red)	Battery exhausted. Charge the battery (📖 15) or insert a fully-charged spare battery (📖 16).
! AF (displayed in red with red focus frame)	The camera can not focus. Use focus lock to focus on another subject at the same distance, then recompose the picture (📖 53).
Aperture or shutter speed displayed in red	The subject is too bright or too dark and the picture will be over- or under-exposed. Use the flash for additional lighting when taking photographs of poorly-lit subjects (📖 35).
FOCUS ERROR	
TURN OFF THE CAMERA AND TURN ON AGAIN	Camera malfunction. Turn the camera off and then on again. If the message persists, contact a FUJIFILM dealer.
LENS CONTROL ERROR	
LENS ERROR	Turn the camera off, remove the lens, and clean the mounting surfaces, then replace the lens and turn the camera on. If the problem persists, contact a FUJIFILM dealer.
BUSY	The memory card is incorrectly formatted. Use the camera to format the card (📖 110).
CARD NOT INITIALIZED	<ul style="list-style-type: none">• The memory card is not formatted or the memory card has been formatted in a computer or other device: Format the memory card using the  FORMAT option in the camera setup menu (📖 110).• The memory card contacts require cleaning: Clean the contacts with a soft, dry cloth. If the message is repeated, format the card (📖 110). If the message persists, replace the card.• Camera malfunction: Contact a FUJIFILM dealer.
PROTECTED CARD	The memory card is locked. Unlock the card (📖 17).

Warning	Description
CARD ERROR	<ul style="list-style-type: none"> • The memory card is not formatted for use in the camera: Format the card (📖 110). • The memory card contacts require cleaning or the memory card is damaged: Clean the contacts with a soft, dry cloth. If the message is repeated, format the card (📖 110). If the message persists, replace the card. • Incompatible memory card: Use a compatible card (📖 19). • Camera malfunction: Contact a FUJIFILM dealer.
SD MEMORY FULL	The memory card is full and pictures can not be recorded. Delete pictures (📖 34) or insert a memory card with more free space (📖 16).
NO CARD	The shutter can only be released when a memory card is inserted. Insert a memory card.
WRITE ERROR	<ul style="list-style-type: none"> • Memory card error or connection error: Reinsert the card or turn the camera off and then on again. If the message persists, contact a FUJIFILM dealer. • Not enough memory remaining to record additional pictures: Delete pictures (📖 34) or insert a memory card with more free space (📖 16). • The memory card is not formatted: Format the memory card (📖 110).
READ ERROR	<ul style="list-style-type: none"> • The file is corrupt or was not created with the camera: The file can not be viewed. • The memory card contacts require cleaning: Clean the contacts with a soft, dry cloth. If the message is repeated, format the card (📖 110). If the message persists, replace the card. • Camera malfunction: Contact a FUJIFILM dealer.
FRAME NO. FULL	The camera has run out of frame numbers (current frame number is 999-9999). Format the memory card and select RENEW for FRAME NO. Take a picture to reset frame numbering to 100-0001, then select CONTINUOUS for FRAME NO. (📖 107).
TOO MANY FRAMES	<ul style="list-style-type: none"> • A search has returned more than 30,000 results: Choose a search that returns fewer results. • More than 999 images are selected for deletion: Choose fewer images.

Warning	Description
PROTECTED FRAME	An attempt was made to delete or rotate a protected picture. Remove protection and try again (🗨 98).
CAN NOT CROP	The picture is damaged or was not created with the camera.
 CANNOT EXECUTE	Red-eye removal can not be applied to pictures created with other devices.
 CANNOT EXECUTE	Red-eye removal can not be applied to movies.
CAN NOT ROTATE	The selected picture can not be rotated.
 CAN NOT ROTATE	Movies can not be rotated.
DPOF FILE ERROR	The DPOF print order on the current memory card contains more than 999 images. Copy the pictures to a computer and create a new print order.
CAN NOT SET DPOF	The picture can not be printed using DPOF.
 CAN NOT SET DPOF	Movies can not be printed using DPOF.
COMMUNICATION ERROR	A connection error occurred while pictures were being printed or copied to a computer or other device. Confirm that the device is turned on and that the USB cable is connected.
PRINTER ERROR	Printer out of paper or ink, or other printer error. Check printer (see printer manual for details). To resume printing, turn the printer off and then turn it back on.
PRINTER ERROR RESUME?	Printer out of paper or ink, or other printer error. Check printer (see printer manual for details). If printing does not resume automatically, press MENU/OK to resume.
CANNOT BE PRINTED	An attempt was made to print a movie, a picture not created with the camera, or a picture in a format not supported by the printer. Movies, RAW images, and some pictures created with other devices can not be printed; if the picture is a still picture created with the camera, check the printer manual to confirm that the printer supports the JFIF-JPEG or Exif-JPEG format. If it does not, the pictures can not be printed.
	Turn the camera off and wait for it to cool. Mottling may increase in pictures taken when this warning is displayed.

Appendix

Memory Card Capacity

The following table shows the recording time or number of pictures available at different image sizes. All figures are approximate; file size varies with the scene recorded, producing wide variations in the number of files that can be stored. The number of exposures or length remaining may not diminish at an even rate.

Capacity		8 GB		16 GB	
		FINE	NORMAL	FINE	NORMAL
Photographs	3:2	1210	1910	2490	3950
	RAW	230		490	
Movies ¹	1920×1080 60 fps ²	26 min.		54 min.	
	1920×1080 50 fps ²				
	1920×1080 30 fps ²				
	1920×1080 25 fps ²				
	1920×1080 24 fps ²	51 min.		105 min.	
	1280×720 60 fps ³				
	1280×720 50 fps ³				
1280×720 30 fps ³					
1280×720 25 fps ³					
1280×720 24 fps ³					

¹ Use a CLASS¹⁰ card or better.

² Individual movies can not exceed 14 minutes in length.

³ Individual movies can not exceed 27 minutes in length.

Links

For more information on FUJIFILM digital camera, visit the websites listed below.

FUJIFILM X-E2 Product Information

Optional accessories and support information can be found on the following website.



Firmware Updates

Updates to product firmware may result in changes not described in the manual. For more information, visit:

http://www.fujifilm.com/support/digital_cameras/software/fw_table.html



Free FUJIFILM Apps

FUJIFILM apps give you more opportunities to enjoy your pictures on smartphones, tablets, and computers.

<http://fujifilm-dsc.com/>



For the latest version of MyFinePix Studio, visit:

<http://fujifilm-dsc.com/mfs/>



For the latest version of RAW FILE CONVERTER, visit:

<http://fujifilm-dsc.com/rfc/>



Specifications



System	
Model	FUJIFILM X-E2 digital camera
Effective pixels	Approx. 16.3 million
Image sensor	23.6 mm × 15.6 mm (APS-C), X-Trans CMOS II sensor with square pixels and primary color filter
Storage media	FUJIFILM-recommended SD/SDHC/SDXC memory cards
File system	Compliant with Design Rule for Camera File System (DCF), Exif 2.3, and Digital Print Order Format (DPOF)
File format	<ul style="list-style-type: none">• Still pictures: Exif 2.3 JPEG (compressed); RAW (original RAF format, special-purpose software required); RAW+JPEG available• Movies: H.264 standard with stereo sound (MOV)
Image size	<ul style="list-style-type: none">• L 3:2: 4,896 × 3,264• M 3:2: 3,456 × 2,304• S 3:2: 2,496 × 1,664• L 16:9: 4,896 × 2,760• M 16:9: 3,456 × 1,944• S 16:9: 2,496 × 1,408• L panorama: 2,160 × 9,600 (vertical) / 9,600 × 1,440 (horizontal)• M panorama: 2,160 × 6,400 (vertical) / 6,400 × 1,440 (horizontal)• L 1:1: 3,264 × 3,264• M 1:1: 2,304 × 2,304• S 1:1: 1,664 × 1,664
Lens mount	FUJIFILM X mount
Sensitivity	Standard output sensitivity equivalent to ISO 200–6400 in increments of 1/3 EV; AUTO; extended output sensitivity equivalent to ISO 100, 12800, or 25600
Metering	256-segment through-the-lens (TTL) metering; MULTI, SPOT, AVERAGE
Exposure control	Programmed AE (with program shift); shutter-priority AE; aperture-priority AE; manual exposure
Exposure compensation	–3 EV – +3 EV in increments of 1/3 EV

System

Shutter speed

- MECHANICAL SHUTTER
 - **P mode:** 4 sec. to $\frac{1}{4,000}$ sec.
 - **Bulb:** Max. 60 min.
 - ELECTRONIC SHUTTER
 - **P, S, A, and M modes:** 1 sec. to $\frac{1}{32,000}$ sec.
 - **Bulb:** Fixed at 1 sec.
 - MECHANICAL + ELECTRONIC
 - **P mode:** 4 sec. to $\frac{1}{32,000}$ sec.
 - **Bulb:** Max. 60 min.
- **Time:** 30 sec. to $\frac{1}{4,000}$ sec.
 - **All other modes:** 30 sec. to $\frac{1}{4,000}$ sec.
 - **Time:** 1 sec. to $\frac{1}{32,000}$ sec.
 - **Time:** 30 sec. to $\frac{1}{32,000}$ sec.
 - **All other modes:** 30 sec. to $\frac{1}{32,000}$ sec.

Continuous

Mode	Frame rate (fps)	Frames per burst
	 7.0	Up to approximately 18
	3.0	Until card is full

◆ Use a CLASS 10 card or better.

◆ The frame rate varies with shooting conditions and the number of images recorded.

Focus

- **Mode:** Single or continuous AF; manual focus with focus ring; AF+MF
- **Focus-area selection:** SINGLE POINT, ZONE, WIDE/TRACKING
- **Autofocus system:** Intelligent hybrid AF (TTL contrast-detect/phase-detection AF) with AF-assist illuminator

White balance

Custom, color temperature selection, auto, direct sunlight, shade, daylight fluorescent, warm white fluorescent, cool white fluorescent, incandescent, underwater

Self-timer

Off, 2 sec., 10 sec.

System	
Flash	<ul style="list-style-type: none"> • Type: Manual pop-up flash unit • Guide number: Approx. 7/22 (ISO 200, m/ft.)
Mode	Auto, fill flash, off, slow sync, rear-curtain sync, commander (red-eye removal off); auto with red-eye removal, fill flash with red-eye removal, off, slow sync with red-eye removal, rear-curtain sync with red-eye removal, commander (red-eye removal on)
Hot shoe	Accessory shoe with TTL contacts
Viewfinder	0.5-in., 2,360k-dot color OLED viewfinder with diopter adjustment (-4 to $+2m^{-1}$); eye point approx. 23 mm; frame coverage approx. 100%
LCD monitor	3.0-in/7.6 cm., 1,040k-dot color LCD monitor; frame coverage approx. 100%
Movies	<ul style="list-style-type: none"> • HD 1920 × 1080 60fps: Frame size 1,920 × 1,080 (1080p); 60 fps; stereo sound • HD 1920 × 1080 50fps: Frame size 1,920 × 1,080 (1080p); 50 fps; stereo sound • HD 1920 × 1080 30fps: Frame size 1,920 × 1,080 (1080p); 30 fps; stereo sound • HD 1920 × 1080 25fps: Frame size 1,920 × 1,080 (1080p); 25 fps; stereo sound • HD 1920 × 1080 24fps: Frame size 1,920 × 1,080 (1080p); 24 fps; stereo sound • HD 1280 × 720 60fps: Frame size 1,280 × 720 (720p); 60 fps; stereo sound • HD 1280 × 720 50fps: Frame size 1,280 × 720 (720p); 50 fps; stereo sound • HD 1280 × 720 30fps: Frame size 1,280 × 720 (720p); 30 fps; stereo sound • HD 1280 × 720 25fps: Frame size 1,280 × 720 (720p); 25 fps; stereo sound • HD 1280 × 720 24fps: Frame size 1,280 × 720 (720p); 24 fps; stereo sound

Input/output terminals

HDMI output	HDMI mini connector
Digital input/output	Micro USB connector (USB 2.0 High-Speed)
Microphone/ remote release connector	φ2.5 mm mini-stereo jack

Power supply/other

Power supply NP-W126 rechargeable battery

Battery life (approximate number of frames that can be taken with a fully-charged battery in mode P , XF 35 mm f/1.4 R lens)	Battery type	Approximate number of frames
		NP-W126 (type supplied with camera)

CIPA standard, measured using battery supplied with camera and SD memory card.

Note: Number of shots that can be taken with battery varies with battery charge level and will decline at low temperatures.

Camera size (W × H × D) 129.0 mm × 74.9 mm × 37.2 mm (30.9 mm excluding projections, measured at thinnest part)/5.0 in. × 2.9 in. × 1.4 in. (1.2 in.)

Camera weight Approx. 300 g/10.5 oz., excluding battery, accessories, and memory card

Shooting weight Approx. 350 g/12.3 oz., including battery and memory card

Operating conditions • **Temperature:** 0°C to +40°C/+32°F to +104°F • **Humidity:** 10% – 80% (no condensation)

Wireless transmitter

Standards IEEE 802.11b/g/n (standard wireless protocol)

Operating frequency • **U. S. A., Canada, Taiwan:** 2,412 MHz–2,462 MHz (11 channels)
• **Other countries:** 2,412 MHz–2,472 MHz (13 channels)

Access protocols Infrastructure

NP-W126 rechargeable battery	
Nominal voltage	7.2V DC
Nominal capacity	1,260 mAh
Operating temperature	0°C to +40°C/+32°F to +104°F
Dimensions (W×H×D)	36.4 mm × 47.1 mm × 15.7 mm/1.4 in. × 1.8 in. × 0.6 in.
Weight	Approx. 47 g/1.7 oz.
BC-W126 battery charger	
Rated input	100V–240V AC, 50/60Hz
Input capacity	13–21 VA
Rated output	8.4V DC, 0.6 A
Supported batteries	NP-W126 rechargeable batteries
Charging time	Approx. 150 minutes (+20°C/+68°F)
Operating temperature	5°C to +40°C/+41°F to +104°F
Dimensions (W×H×D)	65 mm × 91.5 mm × 28 mm/2.5 in. × 3.6 in. × 1.1 in., excluding projections
Weight	Approx. 77 g/2.7 oz., excluding battery

Weight and dimensions vary with the country or region of sale. Labels, menus, and other displays may differ from those on the actual camera.

■ Notices

- Specifications subject to change without notice; for the latest information, visit http://www.fujifilm.com/products/digital_cameras/index.html. FUJIFILM shall not be held liable for damages resulting from errors in this manual.
- Although the viewfinder and LCD monitor are manufactured using advanced high-precision technology, small bright points and anomalous colors may appear, particularly in the vicinity of text. This is normal for this type of LCD display and does not indicate a malfunction; images recorded with the camera are unaffected.
- Digital cameras may malfunction when exposed to strong radio interference (e.g., electric fields, static electricity, or line noise).
- Due to the type of lens used, some distortion may occur at the periphery of images. This is normal.

		P	S	A	M	Ⓐ	Ⓜ	Ⓜ	Ⓜ	Ⓜ	Ⓜ	Ⓜ	Ⓜ
Focus mode		✓	✓	✓	✓	✓ ¹	✓ ¹	✓ ¹	✓ ¹	✓ ¹	✓ ¹	✓ ¹	✓ ²
		✓	✓	✓	✓	✓	✓	✓	✓	✓	✓	✓	✓ ²
		✓	✓	✓	✓	✓	✓	✓	✓	✓	✓	✓	✓ ²
	S	✓	✓	✓	✓	✓ ¹	✓	✓	✓	✓	✓	✓	✓ ²
	C	✓	✓	✓	✓	✓	✓	✓	✓	✓	✓	✓	✓ ¹
MF	M	✓	✓	✓	✓	✓	✓	✓	✓	✓	✓	✓	✓ ²
		✓	✓	✓	✓	✓	✓	✓	✓	✓	✓	✓	✓ ¹
		✓	✓	✓	✓	✓	✓	✓	✓	✓	✓	✓	✓ ¹
MF	STANDARD	✓	✓	✓	✓	✓	✓ ¹	✓ ¹	✓	✓	✓	✓	✓
	DIGITAL SPLIT IMAGE	✓	✓	✓	✓	✓	✓	✓	✓	✓	✓	✓	✓
	FOCUS PEAK HIGHLIGHT	✓	✓	✓	✓	✓	✓	✓	✓	✓	✓	✓	✓
AF+MF	AF+MF	✓	✓	✓	✓	✓	✓	✓	✓	✓	✓	✓	✓
		✓	✓	✓	✓	✓	✓	✓	✓	✓	✓	✓	✓ ²
		✓	✓	✓	✓	✓	✓	✓	✓	✓	✓	✓	✓ ²
	OFF	✓	✓	✓	✓	✓	✓	✓	✓	✓	✓	✓	✓ ²
	✓	✓	✓	✓	✓	✓	✓	✓	✓	✓	✓	✓ ²	
RED EYE REMOVAL	✓	✓	✓	✓	✓	✓	✓	✓	✓	✓	✓	✓	✓
AF ILLUMINATOR	✓	✓	✓	✓	✓	✓	✓	✓	✓	✓	✓	✓	✓ ²
	✓	✓	✓	✓	✓	✓	✓	✓	✓	✓	✓	✓	✓ ²
	✓	✓	✓	✓	✓	✓	✓	✓	✓	✓	✓	✓	✓ ²
	✓	✓	✓	✓	✓	✓	✓	✓	✓	✓	✓	✓	✓ ²

		P	S	A	M	Ⓐ	Ⓜ	Ⓜ	Ⓜ	Ⓜ	Ⓜ	Ⓜ	Ⓜ
NR	NR	✓	✓	✓	✓	✓	✓	✓	✓	✓	✓	✓	✓ ²
		✓	✓	✓	✓	✓	✓	✓	✓	✓	✓	✓	✓ ²
MC/WC	MC/WC	✓	✓	✓	✓	✓	✓	✓	✓	✓	✓	✓	✓ ²
		✓	✓	✓	✓	✓	✓	✓	✓	✓	✓	✓	✓ ²
PREVIEW EXP. IN MANUAL MODE	PREVIEW EXP. IN MANUAL MODE	✓	✓	✓	✓	✓	✓	✓	✓	✓	✓	✓	✓ ²
	FOCUS CHECK (AF) ³	✓ ¹	✓ ¹	✓ ¹	✓ ¹	✓ ¹	✓ ¹	✓ ¹	✓ ¹	✓ ¹	✓ ¹	✓ ¹	✓ ¹
	FOCUS CHECK (MF) ³	✓	✓	✓	✓	✓	✓	✓	✓	✓	✓	✓	✓
	FRAMING GUIDELINE	✓	✓	✓	✓	✓	✓	✓	✓	✓	✓	✓	✓
	ELECTRONIC LEVEL	✓	✓	✓	✓	✓	✓	✓	✓	✓	✓	✓	✓
	AF DISTANCE INDICATOR	✓	✓	✓	✓	✓	✓	✓	✓	✓	✓	✓	✓
	MF DISTANCE INDICATOR	✓	✓	✓	✓	✓	✓	✓	✓	✓	✓	✓	✓
	HISTOGRAM	✓	✓	✓	✓	✓	✓	✓	✓	✓	✓	✓	✓
	APERTURE/S-SPEED/ISO	✓	✓	✓	✓	✓	✓	✓	✓	✓	✓	✓	✓
	EXP. COMPENSATION	✓	✓	✓	✓	✓	✓	✓	✓	✓	✓	✓	✓
PHOTOMETRY	✓	✓	✓	✓	✓	✓	✓	✓	✓	✓	✓	✓	
FLASH	✓	✓	✓	✓	✓	✓	✓	✓	✓	✓	✓	✓	
WHITE BALANCE	✓	✓	✓	✓	✓	✓	✓	✓	✓	✓	✓	✓	
FILM SIMULATION	✓	✓	✓	✓	✓	✓	✓	✓	✓	✓	✓	✓	
DYNAMIC RANGE	DYNAMIC RANGE	✓	✓	✓	✓	✓	✓	✓	✓	✓	✓	✓	✓
	FRAMES REMAINING	✓	✓	✓	✓	✓	✓	✓	✓	✓	✓	✓	✓
	IMAGE SIZE/QUALITY	✓	✓	✓	✓	✓	✓	✓	✓	✓	✓	✓	✓
	BATTERY LEVEL	✓	✓	✓	✓	✓	✓	✓	✓	✓	✓	✓	✓
	✓	✓	✓	✓	✓	✓	✓	✓	✓	✓	✓	✓ ¹¹	✓ ²

- 1 Fixed automatically.
- 2 Wireless remote photography.
- 3 Options available vary with shooting mode.
- 4 **A** is not available.
- 5 Available only with auto ISO sensitivity.
- 6 Varies with lens.
- 7 Available only when **SINGLE POINT** is selected for **AF MODE** in focus mode **S**.
- 8 Still photography settings are used.
- 9 Turns off automatically when interval timer is on.
- 10 Display shows shutter speed only.
- 11 sRGB selected automatically.
- 12 Flash turns off when **ELECTRONIC SHUTTER** is selected for **SHUTTER TYPE**.

FUJIFILM

FUJIFILM Corporation

7-3, AKASAKA 9-CHOME, MINATO-KU, TOKYO 107-0052, JAPAN

http://www.fujifilm.com/products/digital_cameras/index.html