

DIGITAL CAMERA

X100F

Owner's Manual

Thank you for your purchase of this product. This manual describes how to use your FUJIFILM X100F digital camera. Be sure that you have read and understood its contents before using the camera.

■ **Product website:**

<http://fujifilm-x.com/x100f/>

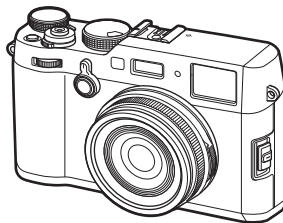

■ **Additional information may be found in online manuals available from:**

<http://fujifilm-dsc.com/manuals/>



Before You Begin

First Steps

Basic Photography
and Playback

Basic Movie Recording
and Playback

The Q (Quick Menu) Button
The Fn (Function) Buttons

More on Photography
and Playback

Menus

Connections

Technical Notes

Troubleshooting

Appendix



IMPORTANT SAFETY INSTRUCTIONS

- **Read Instructions:** All the safety and operating instructions should be read before the appliance is operated.
- **Retain Instructions:** The safety and operating instructions should be retained for future reference.
- **Heed Warnings:** All warnings on the appliance and in the operating instructions should be adhered to.
- **Follow Instructions:** All operating and use instructions should be followed.

Installation

Power Sources: This video product should be operated only from the type of power source indicated on the marking label. If you are not sure of the type of power supply to your home, consult your appliance dealer or local power company. For video products intended to operate from battery power, or other sources, refer to the operating instructions.

Grounding or Polarization: This video product is equipped with a polarized alternating-current line plug (a plug having one blade wider than the other). This plug will fit into the power outlet only one way. This is a safety feature. If you are unable to insert the plug fully into the outlet, try reversing the plug. If the plug should still fail to fit, contact your electrician to replace your obsolete outlet. Do not defeat the safety purpose of the polarized plug.

Alternate Warnings: This video product is equipped with a three-wire grounding-type plug, a plug having a third (grounding) pin. This plug will only fit into a grounding-type power outlet. This is a safety feature. If you are unable to insert the plug into the outlet, contact your electrician to replace your obsolete outlet. Do not defeat the safety purpose of the grounding-type plug.

Overloading: Do not overload wall outlets and extension cords as this can result in a risk of fire or electric shock.

Ventilation: Slots and openings in the cabinet are provided for ventilation, to ensure reliable operation of the video product and to protect it from overheating, and these openings must not be blocked or covered. The openings should never be blocked by placing the video product on a bed, sofa, rug, or other similar surface.

This video product should not be placed in a built-in installation such as a bookcase or rack unless proper ventilation is provided or the manufacturer's instructions have been adhered to. This video product should never be placed near or over a radiator or heat register.

Attachments: Do not use attachments not recommended by the video product manufacturer as they may cause hazards.

Water and Moisture: Do not use this video product near water—for example, near a bath tub, wash bowl, kitchen sink, or laundry tub, in a wet basement, or near a swimming pool, and the like.

Power-Cord Protection: Power-supply cords should be routed so that they are not likely to be walked on or pinched by items placed upon or against them, paying particular attention to cords at plugs, convenience receptacles, and the point where they exit from the appliance.

Accessories: Do not place this video product on an unstable cart, stand, tripod, bracket, or table. The video product may fall, causing serious injury to a child or adult, and serious damage to the appliance. Use only with a cart, stand, tripod, bracket, or table recommended by the manufacturer, or sold with the video product. Any mounting of the appliance should follow the manufacturer's instructions, and should use a mounting accessory recommended by the manufacturer.

An appliance and cart combination should be moved with care. Quick stops, excessive force, and uneven surfaces may cause the appliance and cart combination to overturn.



Antennas

Outdoor Antenna Grounding: If an outside antenna or cable system is connected to the video product, be sure the antenna or cable system is grounded so as to provide some protection against voltage surges and built-up static charges. Section 810 of the National Electrical Code, ANSI/NFPA No. 70, provides information with respect to proper grounding of the

mast and supporting structure, grounding of the lead-in wire to an antenna discharge unit, size of grounding conductors, location of antenna discharge unit, connection to grounding electrodes, and requirements for the grounding electrode.

EXAMPLE OF ANTENNA GROUNDING AS PER NATIONAL ELECTRICAL CODE

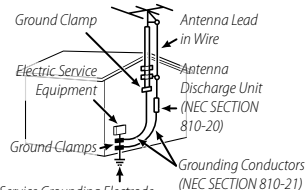

Power Service Grounding Electrode System (NEC ART 250, PART H)

Power Lines: An outside antenna system should not be located in the vicinity of overhead power lines or other electric light or power circuits, or where it can fall into such power lines or circuits. When installing an outside antenna system, extreme care should be taken to keep from touching such power lines or circuits as contact with them might be fatal.

Use

Cleaning: Unplug this video product from the wall outlet before cleaning. Do not use liquid cleaners or aerosol cleaners. Use a damp cloth for cleaning.

Object and Liquid Entry: Never push objects of any kind into this video product through openings as they may touch dangerous voltage points or short out parts that could result in a fire or electric shock. Never spill liquid of any kind on the video product.

Lightning: For added protection for this video product receiver during a lightning storm, or when it is left unattended and unused for long periods of time, unplug it from the wall outlet and disconnect the antenna or cable system. This will prevent damage to the video product due to lightning and power-line surges.

Service

Service: Do not attempt to service this video product yourself as opening or removing covers may expose you to dangerous voltage or other hazards. Refer all servicing to qualified service personnel.

Damage Requiring Service: Unplug this video product from the wall outlet and refer servicing to qualified service personnel under the following conditions:

- When the power-supply cord or plug is damaged
- If liquid has been spilled, or objects have fallen into the video product.
- If the video product has been exposed to rain or water.
- If the video product has been dropped or the cabinet has been damaged.

If the video product does not operate normally follow the operating instructions. Adjust only those controls that are covered by the operating instructions as an improper adjustment of other controls may result in damage and will often require extensive work by a qualified technician to restore the video product to its normal operation.

When the video product exhibits a distinct change in performance—this indicates a need for service.

Replacement Parts: When replacement parts are required, be sure the service technician has used replacement parts specified by the manufacturer or have the same characteristics as the original part. Unauthorized substitutions may result in fire, electric shock or other hazards.



Safety Check: Upon completion of any service or repairs to this video product, ask the service technician to perform safety checks to determine that the video product is in proper operating condition.

Be sure to read these notes before use**Safety Notes**



- Make sure that you use your camera correctly. Read these safety notes and your *Owner's Manual* carefully before use.
- After reading these safety notes, store them in a safe place.

About the Icons



The icons shown below are used in this document to indicate the severity of the injury or damage that can result if the information indicated by the icon is ignored and the product is used incorrectly as a result.

	WARNING	This icon indicates that death or serious injury can result if the information is ignored.
	CAUTION	This icon indicates that personal injury or material damage can result if the information is ignored.

The icons shown below are used to indicate the nature of the instructions which are to be observed.

	Triangular icons tell you that this information requires attention ("Important").
	Circular icons with a diagonal bar tell you that the action indicated is prohibited ("Prohibited").
	Filled circles with an exclamation mark indicate an action that must be performed ("Required").

The symbols on the product (including the accessories) represent the following:

	AC
	DC
	Class II equipment (The construction of the product is double-insulated.)

WARNING

If a problem arises, turn the camera off, remove the battery, and disconnect and unplug the AC power adapter. Continued use of the camera when it is emitting smoke, is emitting any unusual odor, or is in any other abnormal state can cause a fire or electric shock. Contact your FUJIFILM dealer.



Do not allow water or foreign objects to enter the camera. If water or foreign objects get inside the camera, turn the camera off, remove the battery, and disconnect and unplug the AC power adapter. Continued use of the camera can cause a fire or electric shock. Contact your FUJIFILM dealer.



Do not use the camera in the bathroom or shower. This can cause a fire or electric shock.



Never attempt to change or take apart the camera (never open the case). Failure to observe this precaution can cause fire or electric shock.



Should the case break open as the result of a fall or other accident, do not touch the exposed parts. Failure to observe this precaution could result in electric shock or in injury from touching the damaged parts. Remove the battery immediately, taking care to avoid injury or electric shock, and take the product to the point of purchase for consultation.











Do not change, heat or unduly twist or pull the connection cord and do not place heavy objects on the connection cord. These actions could damage the cord and cause a fire or electric shock. If the cord is damaged, contact your FUJIFILM dealer.





















Do not place the camera on an unstable surface. This can cause the camera to fall or tip over and cause injury.



Never attempt to take pictures while in motion. Do not use the camera while walking or driving. This can result in you falling down or being involved in a traffic accident.

 WARNING	
	Do not touch any metal parts of the camera during a thunderstorm. This can cause an electric shock due to induced current from the lightning discharge.
	Do not use the battery except as specified. Load the battery as shown by the indicator.
	Do not disassemble, modify, or heat batteries. Do not drop, strike, or throw batteries or otherwise subject them to strong impacts. Do not use batteries that show signs of leaking, deformation, discoloration, or other abnormalities. Use only designated chargers to recharge rechargeable batteries and do not attempt to recharge non-rechargeable Li-ion or alkaline batteries. Do not short batteries or store them with metallic objects. Failure to observe these precautions could result in the batteries overheating, igniting, rupturing, or leaking, causing fire, burns, or other injury.
	Use only batteries or AC power adapters specified for use with this camera. Do not use voltages other than the power supply voltage shown. The use of other power sources can cause a fire.
	If the battery leaks and fluid gets in contact with your eyes, skin or clothing, flush the affected area with clean water and seek medical attention or call an emergency number right away.
	Do not use the charger to charge batteries other than those specified here. The supplied charger is for use only with batteries of the type supplied with the camera. Using the charger to charge conventional batteries or other types of rechargeable batteries can cause the battery to leak, overheat or burst.
	Using a flash too close to a person's eyes may cause visual impairment. Take particular care when photographing infants and young children.

 WARNING	
	Do not remain in prolonged contact with hot surfaces. Failure to observe this precaution could result in low-temperature burns, particularly at high ambient temperatures or with users who suffer from poor circulation or reduced sensation, in which case use of a tripod or similar precautions are recommended.
	Do not leave one part of the body in contact with the product for prolonged periods while the product is on. Failure to observe this precaution could result in low-temperature burns, particularly during prolonged use, at high ambient temperatures, or with users who suffer from poor circulation or reduced sensation, in which case use of a tripod or similar precautions are recommended.
	Do not use in the presence of flammable objects, explosive gases, or dust.
	When carrying the battery, install it in a digital camera or keep it in the hard case. When storing the battery, keep it in the hard case. When discarding, cover the battery terminals with insulation tape. Contact with other metallic objects or batteries could cause the battery to ignite or burst.
	Keep memory cards, hot shoes, and other small parts out of the reach of small children. Children may swallow small parts; keep out of reach of children. Should a child swallow a small part, seek medical attention or call emergency.
	Keep out of reach of small children. Among the elements that could cause injury are the strap, which could become entangled about a child's neck, causing strangulation, and the flash, which could cause visual impairment.
	Follow the directions of airline and hospital personnel. This product generates radio-frequency emissions that could interfere with navigational or medical equipment.

 CAUTION	
	Do not use this camera in locations affected by oil fumes, steam, humidity or dust. This can cause a fire or electric shock.
	Do not leave this camera in places subject to extremely high temperatures. Do not leave the camera in locations such as a sealed vehicle or in direct sunlight. This can cause a fire.
	Do not place heavy objects on the camera. This can cause the heavy object to tip over or fall and cause injury.
	Do not move the camera while the AC power adapter is still connected. Do not pull on the connection cord to disconnect the AC power adapter. This can damage the power cord or cables and cause a fire or electric shock.
	Do not cover or wrap the camera or the AC power adapter in a cloth or blanket. This can cause heat to build up and distort the casing or cause a fire.
	When you are cleaning the camera or you do not plan to use the camera for an extended period, remove the battery and disconnect and unplug the AC power adapter. Failure to do so can cause a fire or electric shock.
	When charging ends, unplug the charger from the power socket. Leaving the charger plugged into the power socket can cause a fire.
	When a memory card is removed, the card could come out of the slot too quickly. Use your finger to hold it and gently release the card. Injury could result to those struck by the ejected card.
	Request regular internal testing and cleaning for your camera. Build-up of dust in your camera can cause a fire or electric shock. Contact your FUJIFILM dealer to request internal cleaning every two years. Please note that this service is not free of charge.
	Danger of explosion if battery is incorrectly replaced. Replace only with the same or equivalent type.

The Battery and Power Supply

Note: Check the type of battery used in your camera and read the appropriate sections.

⚠ WARNING: Battery shall not be exposed to excessive heat such as sunshine, fire or the like.

The following describes the proper use of batteries and how to prolong their life. Incorrect use can shorten battery life or cause leakage, overheating, fire, or explosion.

Li-ion Batteries

Read this section if your camera uses a rechargeable Li-ion battery.

The battery is not charged at shipment. Charge the battery before use. Keep the battery in its case when not in use.

■ Notes on the Battery

The battery gradually loses its charge when not in use. Charge the battery one or two days before use.

Battery life can be extended by turning the camera off when not in use.

Battery capacity decreases at low temperatures; a depleted battery may not function when cold. Keep a fully charged spare battery in a warm place and exchange as necessary, or keep the battery in your pocket or other warm place and insert it in the camera only when shooting. Do not place the battery in direct contact with hand warmers or other heating devices.

■ Charging the Battery

Charge the battery in the supplied battery charger. Charging times will increase at ambient temperatures below +10°C (+50°F) or above +35°C (+95°F). Do not attempt to charge the battery at temperatures above 40°C (+104°F); at temperatures below 0°C (+32°F), the battery will not charge.

Do not attempt to recharge a fully charged battery. The battery does not however need to be fully discharged before charging.

The battery may be warm to the touch immediately after charging or use. This is normal.

■ Battery Life

At normal temperatures, the battery can be recharged about 300 times. A noticeable decrease in the length of time the battery will hold a charge indicates that it has reached the end of its service life and should be replaced.

■ Storage

Performance may be impaired if the battery is left unused for extended periods when fully charged. Run the battery flat before storing it.

If the camera will not be used for an extended period, remove the battery and store it in a dry place with an ambient temperature of from +15°C to +25°C (+59°F to +77°F). Do not store in locations exposed to extremes of temperature.

■ Cautions: Handling the Battery

- Do not transport or store with metal objects such as necklaces or hairpins.
- Do not expose to flame or heat.
- Do not disassemble or modify.
- Use with designated chargers only.
- Dispose of used batteries promptly.
- Do not drop or subject to strong physical shocks.
- Do not expose to water.
- Keep the terminals clean.
- The battery and camera body may become warm to the touch after extended use. This is normal.

■ Caution: Disposal

Dispose of used batteries in accord with local regulations. Attention should be drawn to the environmental aspects of battery disposal. Use the apparatus under moderate climate.

AC Power Adapters (Available Separately)

Use only FUJIFILM AC power adapters designated for use with this camera. Other adapters could damage the camera.

- The AC power adapter is for indoor use only.
- Be sure the DC plug is securely connected to the camera.
- Turn the camera off before disconnecting the adapter. Disconnect the adapter by the plug, not the cable.
- Do not use with other devices.
- Do not disassemble.
- Do not expose to high heat and humidity.
- Do not subject to strong physical shocks.
- The adapter may hum or become hot to the touch during use. This is normal.
- If the adapter causes radio interference, reorient or relocate the receiving antenna.

Using the Camera

- Do not aim the camera at extremely bright light sources, such as the sun in a cloudless sky. Failure to observe this precaution could damage the camera image sensor.
- Strong sunlight focused through the viewfinder may damage the panel of electronic viewfinder (EVF). Do not aim the electronic viewfinder at the sun.

Take Test Shots

Before taking photographs on important occasions (such as at weddings or before taking the camera on a trip), take a test shot and view the results to ensure that the camera is functioning normally. FUJIFILM Corporation can not accept liability for damages or lost profits incurred as a result of product malfunction.

Notes on Copyright

Unless intended solely for personal use, images recorded using your digital camera system cannot be used in ways that infringe copyright laws without the consent of the owner. Note that some restrictions apply to the photographing of stage performances, entertainments, and exhibits, even when intended purely for personal use. Users are also asked to note that the transfer of memory cards containing images or data protected under copyright laws is only permissible within the restrictions imposed by those copyright laws.

Handling

To ensure that images are recorded correctly, do not subject the camera to impact or physical shocks while images are being recorded.

Liquid Crystal

In the event that the display is damaged, care should be taken to avoid contact with liquid crystal. Take the urgent action indicated should any of the following situations arise:

- **If liquid crystal comes in contact with your skin**, clean the area with a cloth and then wash thoroughly with soap and running water.
- **If liquid crystal enters your eyes**, flush the affected eye with clean water for at least 15 minutes and then seek medical assistance.
- **If liquid crystal is swallowed**, rinse your mouth thoroughly with water. Drink large quantities of water and induce vomiting, then seek medical assistance.

Although the display is manufactured using extremely high-precision technology, it may contain pixels that are always lit or that do not light. This is not a malfunction, and images recorded with the product are unaffected.

Trademark Information

Digital Split Image is a trademark or registered trademark of FUJIFILM Corporation. *xD-Picture Card* and *xD* are trademarks of FUJIFILM Corporation. The typefaces included herein are solely developed by DynaComware Taiwan Inc. Macintosh, Mac OS, and macOS are trademarks of Apple Inc. in the U.S.A. and other countries. Windows is a registered trademark of Microsoft Corporation in the U.S.A. and other countries. Wi-Fi® and Wi-Fi Protected Setup® are registered trademarks of the Wi-Fi Alliance. The SDHC and SDXC logos are trademarks of SD-3C, LLC. The HDMI logo is a trademark. All other trade names mentioned in this manual are the trademarks or registered trademarks of their respective owners.

Electrical Interference

This camera may interfere with hospital or aviation equipment. Consult with hospital or airline staff before using the camera in a hospital or on an aircraft.

Color Television Systems

NTSC (National Television System Committee) is a color television telecasting specification adopted mainly in the U.S.A., Canada, and Japan. PAL (Phase Alternation by Line) is a color television system adopted mainly in European countries and China.

Exif Print (Exif Version 2.3)

Exif Print is a newly revised digital camera file format in which information stored with photographs is used for optimal color reproduction during printing.

IMPORTANT NOTICE: Read Before Using the Software

Direct or indirect export, in whole or in part, of licensed software without the permission of the applicable governing bodies is prohibited.

NOTICES

To prevent fire or shock hazard, do not expose the unit to rain or moisture.

Please read the "Safety Notes" and make sure you understand them before using the camera.

Perchlorate Material—special handling may apply. See <http://www.dtscc.ca.gov/hazardouswaste/perchlorate>.

For Customers in the U.S.A.**Tested To Comply With FCC Standards****FOR HOME OR OFFICE USE**

Contains IC: 7736B-0200003

Contains FCC ID: W22-0200003

FCC Statement: This device complies with Part 15 of the FCC Rules. Operation is subject to the following two conditions: (1) This device may not cause harmful interference, and (2) this device must accept any interference received, including interference that may cause undesired operation.

CAUTION: This equipment has been tested and found to comply with the limits for a Class B digital device, pursuant to Part 15 of the FCC Rules. These limits are designed to provide reasonable protection against harmful interference in a residential installation. This equipment generates, uses, and can radiate radio frequency energy and, if not installed and used in accordance with the instructions, may cause harmful interference to radio communications. However, there is no guarantee that interference will not occur in a particular installation. If this equipment does cause harmful interference to radio or television reception, which can be determined by turning the equipment off and on, the user is encouraged to try to correct the interference by one or more of the following measures:

- Reorient or relocate the receiving antenna.
- Increase the separation between the equipment and receiver.
- Connect the equipment into an outlet on a circuit different from that to which the receiver is connected.
- Consult the dealer or an experienced radio/TV technician for help.

FCC Caution: Any changes or modifications not expressly approved by the party responsible for compliance could void the user's authority to operate this equipment.

This transmitter must not be co-located or operating in conjunction with any other antenna or transmitter.

Radiation Exposure Statement: This device meets the government's requirements for exposure to radio waves. This device is designed and manufactured not to exceed the emission limits for exposure to radio frequency (RF) energy set by the Federal Communications Commission of the U.S. Government.

The exposure standard for wireless device employs a unit of measurement known as the Specific Absorption Rate, or SAR. The SAR limit set by the FCC is 1.6W/kg. *Tests for SAR are conducted using standard operating positions accepted by the FCC with the device transmitting at its highest certified power level in all tested frequency bands.

Notes on the Grant: To comply with Part 15 of the FCC Rules, this product must be used with a Fujifilm-specified ferrite-core A/V cable, USB cable, and DC supply cord.



A lithium ion battery that is recyclable powers the product you have purchased. Please call 1-800-8-BATTERY for information on how to recycle this battery.

For Customers in Canada**CAN ICES-3 (B)/NMB-3(B)**

CAUTION: This Class B digital apparatus complies with Canadian ICES-003.

Industry Canada statement: This device complies with Industry Canada's licence-exempt RSSs. Operation is subject to the following two conditions: (1) This device may not cause interference; and (2) This device must accept any interference, including interference that may cause undesired operation of the device.

This device and its antenna(s) must not be co-located or operating in conjunction with any other antenna or transmitter, except tested built-in radios. The County Code Selection feature is disabled for products marketed in the US/ Canada.

Radiation Exposure Statement: The available scientific evidence does not show that any health problems are associated with using low power wireless devices. There is no proof, however, that these low power wireless devices are absolutely safe. Low power Wireless devices emit low levels of radio frequency energy (RF) in the microwave range while being used. Whereas high levels of RF can produce health

effects (by heating tissue), exposure of low-level RF that does not produce heating effects causes no known adverse health effects. Many studies of low-level RF exposures have not found any biological effects. Some studies have suggested that some biological effects might occur, but such findings have not been confirmed by additional research. X100F has been tested and found to comply with IC radiation exposure limits set forth for an uncontrolled environment and meets RSS-102 of the IC radio frequency (RF) Exposure rules.

Disposal of Electrical and Electronic Equipment in Private Households

In the European Union, Norway, Iceland and Liechtenstein: This symbol on the product, or in the manual and in the warranty, and/or on its packaging indicates that this product shall not be treated as household waste. Instead it should be taken to an applicable collection point for the recycling of electrical and electronic equipment.



By ensuring this product is disposed of correctly, you will help prevent potential negative consequences to the environment and human health, which could otherwise be caused by inappropriate waste handling of this product.

This symbol on the batteries or accumulators indicates that those batteries shall not be treated as household waste.



If your equipment contains easy removable batteries or accumulators please dispose these separately according to your local requirements.

The recycling of materials will help to conserve natural resources. For more detailed information about recycling this product, please contact your local city office, your household waste disposal service or the shop where you purchased the product.

In Countries Outside the European Union, Norway, Iceland and Liechtenstein: If you wish to discard this product, including the batteries or accumulators, please contact your local authorities and ask for the correct way of disposal.

In Japan: This symbol on the batteries indicates that they are to be disposed of separately.



European Union regulatory notice

This product complies with the following EU Directives:

- RoHS Directive 2011/65/EU
- RE Directive 2014/53/EU

Hereby, FUJIFILM Corporation declares that the radio equipment type FF160004 is in compliance with Directive 2014/53/EU.

The full text of the EU declaration of conformity is available at the following internet address: http://www.fujifilm.com/products/digital_cameras/x/fujifilm_x100f/pdf/index/fujifilm_x100f_cod.pdf

This compliance is indicated by the following conformity marking placed on the product:



This marking is valid for non-Telecom products and EU harmonized Telecom products (e.g. Bluetooth).

IMPORTANT: Read the following notices before using the camera's built-in wireless transmitter.

- ① This product, which contains encryption function developed in the United States, is controlled by the United States Export Administration Regulations and may not be exported or re-exported to any country to which the United States embargoes goods.
- **Use only as part of a wireless network.** FUJIFILM does not accept liability for damages resulting from unauthorized use. Do not use in applications requiring a high degree of reliability, for example in medical devices or other systems that may directly or indirectly impact human life. When using the device in computer and other systems that demand a greater degree of reliability than wireless networks, be sure to take all necessary precautions to ensure safety and prevent malfunction.
- **Use only in the country in which the device was purchased.** This device conforms to regulations governing wireless network devices in the country in which it was purchased. Observe all location regulations when using the device. FUJIFILM does not accept liability for problems arising from use in other jurisdictions.
- **Wireless data (images) may be intercepted by third parties.** The security of data transmitted over wireless networks is not guaranteed.
- **Do not use the device in locations subject to magnetic fields, static electricity, or radio interference.** Do not use the transmitter in the vicinity of microwave ovens or in other locations subject to magnetic fields, static electricity, or radio interference that may prevent reception of wireless signals. Mutual interference may occur when the transmitter is used in the vicinity of other wireless devices operating in the 2.4 GHz band.
- **The wireless transmitter operates in the 2.4 GHz band using DSSS and OFDM modulation.**

Wireless Network Devices: Cautions

- **This device operates on the same frequency as commercial, educational, and medical devices and wireless transmitters.** It also operates on the same frequency as licensed transmitters and special unlicensed low-voltage transmitters used in RFID tracking systems for assembly lines and in other similar applications.
- **To prevent interference with the above devices, observe the following precautions.** Confirm that the RFID transmitter is not in operation before using this device. Should you observe that the device causes interference in licensed transmitters used for RFID tracking, immediately stop using the affected frequency or move the device to another location. If you notice that this device causes interference in low-voltage RFID tracing systems, contact a FUJIFILM representative.



This sticker indicates that this device operates in the 2.4 GHz band using DSSS and OFDM modulation and may cause interference at distances of up to 40 m.

About This Manual

Before using the camera, read this manual and the warnings in “For Your Safety” (📖 ii). For information on specific topics, consult the sources below.

Table of Contents 📖 **xiii**

The “Table of Contents” gives an overview of the entire manual. The principal camera operations are listed here.

Troubleshooting 📖 **152**

Having a specific problem with the camera? Find the answer here.

Warning Messages and Displays 📖 **157**

Find out what’s behind that flashing icon or error message in the display.

Restrictions on Camera Settings..... 📖 **168**

See page 168 for restrictions on the options available in each shooting mode.

Memory Cards

Pictures are stored on optional SD, SDHC, and SDXC memory cards (📖 23), referred to in this manual as “memory cards.”

Product Care

For continued enjoyment of your camera, use a soft, dry cloth to clean the camera body after each use. Do not use alcohol, thinner, or other volatile chemicals, which could discolor or deform the leather on the camera body. Any liquid on the camera should be removed immediately with a soft, dry cloth. Use a blower to remove dust from the lens and monitor, then gently wipe with a soft, dry cloth. Any remaining stains can be removed by wiping gently with a piece of FUJIFILM lens-cleaning paper to which a small amount of lens-cleaning fluid has been applied. Care should be taken to avoid scratching the lens or monitor.

Product Features

Frequently-used options can be added to the **Q** menu or a custom “my” menu or assigned to an **Fn** (function) button for direct access. Customize camera controls to suit your style or situation.

The Q Menu (📖 43)

The **Q** menu is displayed by pressing the **Q** button.

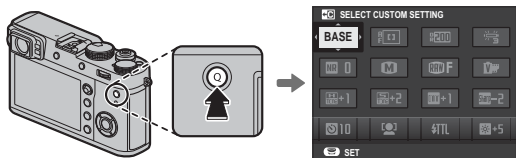

Use the **Q** menu to view or change the options selected for frequently-used menu items.

“My Menu” (📖 107)

Add frequently-used options to this custom menu, which can be viewed by pressing **MENU/OK** and selecting the **MY** (“MY MENU”) tab.

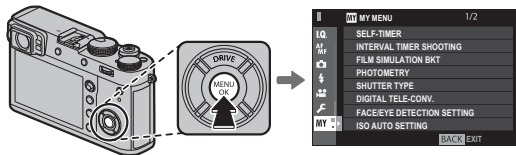

◆ The **MY** tab is only available if options have been assigned to “MY MENU”.

The Function Buttons (📖 46)

Use the function buttons for direct access to selected features.

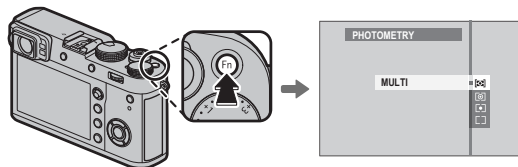

*The illustration shows the **Fn1** button being used to display metering options.*

Table of Contents

For Your Safety	ii
IMPORTANT SAFETY INSTRUCTIONS	ii
Safety Notes.....	iii
NOTICES.....	vi
About This Manual	ix
Product Care	x
Product Features	xi
The Q Menu.....	xi
“My Menu”.....	xi
The Function Buttons.....	xi
Before You Begin	
Symbols and Conventions	1
Supplied Accessories	1
Parts of the Camera	2
The Selector.....	4
The Focus Stick (Focus Lever).....	5
The Shutter-Speed/ISO Dial.....	5
The Command Dials.....	6
The Indicator Lamp.....	7
The Control Ring.....	8
The Aperture Ring and Shutter Speed Dial.....	9
Camera Displays.....	10
Shooting: Optical Viewfinder.....	10
Shooting: Electronic Viewfinder/LCD Monitor.....	12
Playback.....	14

First Steps

Attaching the Strap	16
Charging the Battery	18
Inserting the Battery and a Memory Card	20
Compatible Memory Cards.....	23
Turning the Camera on and Off	24
Basic Setup	25
Changing Basic Settings.....	26
Display Settings	27
Choosing a Display.....	27
The Viewfinder Selector.....	28
The Viewfinder Display.....	29
Focusing the Viewfinder.....	29
Adjusting Display Brightness.....	29
The DISP/BACK Button	30
Shooting: Optical Viewfinder.....	30
Shooting: Electronic Viewfinder.....	30
LCD Monitor: Shooting.....	30
Customizing the Standard Display.....	31
Viewfinder/LCD Monitor: Playback.....	32

Basic Photography and Playback



Taking Photographs	33
Viewing Pictures	35
Viewing Pictures Full Frame.....	35
Viewing Photo Information.....	36
Playback Zoom.....	37
Multi-Frame Playback.....	38
Deleting Pictures	39

Basic Movie Recording and Playback	
Recording Movies.....	40
Using an External Microphone.....	41
Viewing Movies.....	42
The Q (Quick Menu) Button	
Using the Q Button.....	43
The Quick Menu Display.....	43
Viewing and Changing Settings.....	44
Editing the Quick Menu.....	45
The Fn (Function) Buttons	
Using the Function Buttons.....	46
Assigning Roles to the Function Buttons.....	47
TTL-LOCK.....	48
MODELING FLASH.....	48
More on Photography and Playback	
Mode Selection.....	49
Program AE (P).....	49
Shutter-Priority AE (S).....	50
Aperture-Priority AE (A).....	51
Manual Exposure (M).....	53
The Digital Teleconverter.....	54
Drive Mode.....	55
📷 Burst Mode (CONTINUOUS).....	56
Bracketing.....	57
🔍 Advanced Filters.....	58
🖼️ Panoramas.....	59
Viewing Panoramas.....	60
📷 Multiple Exposures.....	61
Exposure Compensation.....	62
C (Custom).....	62
Sensitivity.....	63
Metering.....	64
Film Simulation.....	65
White Balance.....	66
Focus Mode.....	68
The Focus Indicator.....	69
MF Assist.....	70
Autofocus Options (AF Mode).....	71
Focus-Point Selection.....	72
The Focus Point Display.....	73
Single Point AF.....	73
Zone AF.....	74
Tracking (Focus Mode C Only).....	75
Long Time-Exposures (T/B).....	76
Time (T).....	76
Bulb (B).....	76
Using a Remote Release.....	77
The Self-Timer.....	78
Interval Timer Photography.....	79
Focus/Exposure Lock.....	80
Flash Photography.....	82
FLASH FUNCTION SETTING.....	83
Recording Pictures in RAW Format.....	84
Creating JPEG Copies of RAW Pictures.....	85
Saving Settings.....	86
PhotoBook Assist.....	87
Creating a PhotoBook.....	87
Viewing Photobooks.....	88
Editing and Deleting Photobooks.....	88

Menus

Using the Menus: Shooting Mode	89	FOCUS CHECK	96
Using the Shooting Menu	89	INTERLOCK SPOT AE & FOCUS AREA	96
Q IMAGE QUALITY SETTING	90	INSTANT AF SETTING	96
IMAGE SIZE	90	DEPTH-OF-FIELD SCALE	97
IMAGE QUALITY	90	RELEASE/FOCUS PRIORITY	97
RAW RECORDING	90	CORRECTED AF FRAME	97
FILM SIMULATION	91	Q SHOOTING SETTING	98
GRAIN EFFECT	91	SELF-TIMER	98
DYNAMIC RANGE	91	INTERVAL TIMER SHOOTING	98
WHITE BALANCE	91	FILM SIMULATION BKT	98
HIGHLIGHT TONE	91	PHOTOMETRY	98
SHADOW TONE	91	SHUTTER TYPE	99
COLOR	92	ISO AUTO SETTING	100
SHARPNESS	92	CONVERSION LENS	100
NOISE REDUCTION	92	DIGITAL TELE-CONV.	100
LONG EXPOSURE NR	92	ND FILTER	101
COLOR SPACE	92	WIRELESS COMMUNICATION	101
PIXEL MAPPING	93	F FLASH SETTING	102
SELECT CUSTOM SETTING	93	FLASH FUNCTION SETTING	102
EDIT/SAVE CUSTOM SETTING	93	RED EYE REMOVAL	102
M AF/MF SETTING	94	TTL-LOCK MODE	103
FOCUS AREA	94	LED LIGHT SETTING	103
AF MODE	94	MASTER SETTING	104
AF POINT DISPLAY [] []	94	CH SETTING	104
NUMBER OF THE FOCUS POINTS	94	Built-In Flash	104
PRE-AF	94	M MOVIE SETTING	105
AF ILLUMINATOR	95	MOVIE MODE	105
FACE/EYE DETECTION SETTING	95	MOVIE AF MODE	105
AF+MF	96	HDMI OUTPUT INFO DISPLAY	106
MF ASSIST	96	MIC LEVEL ADJUSTMENT	106
		MIC/REMOTE RELEASE	106
		MV MY MENU	107

Using the Menus: Playback Mode	108	OPERATION VOL.	117
Using the Playback Menu	108	SHUTTER VOLUME	117
▣ PLAY BACK MENU	109	SHUTTER SOUND	117
RAW CONVERSION.....	109	PLAYBACK VOLUME.....	117
ERASE.....	109	▣ SCREEN SETTING.....	118
CROP	109	EVF BRIGHTNESS	118
RESIZE.....	110	EVF COLOR.....	118
PROTECT.....	110	LCD BRIGHTNESS.....	118
IMAGE ROTATE.....	110	LCD COLOR	118
RED EYE REMOVAL.....	111	IMAGE DISP.	118
WIRELESS COMMUNICATION	111	EVF AUTOROTATE DISPLAYS	119
SLIDE SHOW.....	111	PREVIEW EXP/WB IN MANUAL MODE.....	119
PHOTOBOOK ASSIST	111	PREVIEW PIC. EFFECT.....	119
PC AUTO SAVE.....	111	FRAMING GUIDELINE.....	119
PRINT ORDER (DPOF).....	112	AUTOROTATE PB	120
instax PRINTER PRINT	112	FOCUS SCALE UNITS	120
DISP ASPECT	112	DISP. CUSTOM SETTING	120
The Setup Menu	113	▣ BUTTON/DIAL SETTING	121
Using the Setup Menu.....	113	FOCUS LEVER SETTING	121
▣ SET UP Menu Options.....	114	EDIT/SAVE QUICK MENU	121
▣ USER SETTING	114	FUNCTION (Fn) SETTING	121
FORMAT	114	ISO DIAL SETTING (H)	121
DATE/TIME	114	ISO DIAL SETTING (A).....	121
TIME DIFFERENCE	115	FOCUS RING	122
言語/LANG.....	115	CONTROL RING SETTING.....	122
MY MENU SETTING.....	115	AE/AF-LOCK MODE.....	122
SHUTTER COUNT.....	115	▣ POWER MANAGEMENT	123
SOUND & FLASH.....	115	AUTO POWER OFF	123
RESET	116	POWER MANAGEMENT.....	123
▣ SOUND SETTING	117	▣ SAVE DATA SETTING	124
AF BEEP VOL.....	117	FRAME NO.....	124
SELF-TIMER BEEP VOL.....	117	SAVE ORG IMAGE	124

EDIT FILE NAME	124	Technical Notes	
COPYRIGHT INFO	125	Optional Accessories	140
 CONNECTION SETTING.....	126	Accessories from FUJIFILM.....	140
WIRELESS SETTINGS.....	126	Connecting the Camera to Other Devices.....	143
PC AUTO SAVE SETTING	126	Using Shoe-Mounted Flash Units.....	144
GEOTAGGING SET-UP	126	Attaching Adapter Rings.....	148
instax PRINTER CONNECTION SETTING	126	Attaching Lens Hoods.....	149
“My Menu”	127	Attaching Protector Filters	149
Editing “My Menu”.....	127	Using Conversion Lenses.....	149
Factory Defaults	128	Caring for the Camera	151
Connections		Use and Storage Precautions	151
Wireless Transfer (FUJIFILM Camera Remote/ FUJIFILM PC AutoSave)	131	Traveling.....	151
Wireless Connections: Smartphones	131	Troubleshooting	
Wireless Connections: Computers	131	Problems and Solutions	152
Viewing Pictures on a Computer (MyFinePix Studio/ RAW FILE CONVERTER EX 2.0)	132	Warning Messages and Displays	157
Windows.....	132	Appendix	
Mac OS X/macOS.....	132	Memory Card Capacity	160
Connecting the Camera	133	Links	161
Creating a DPOF Print Order	135	FUJIFILM X100F Product Information.....	161
WITH DATE  /WITHOUT DATE	135	Firmware Updates	161
RESET ALL.....	136	Specifications	162
instax SHARE Printers	137	Restrictions on Camera Settings	168
Establishing a Connection.....	137		
Printing Pictures	138		
Viewing Pictures on TV	139		

Before You Begin

Symbols and Conventions

The following symbols are used in this manual:

- ⓘ This information should be read before use to ensure correct operation.
- ◆ Additional information that may be helpful when using the camera.
- 📖 Other pages in this manual on which related information may be found.

Menus and other text in the displays are shown in **bold**. Illustrations are for explanatory purposes only; drawings may be simplified, while photographs are not necessarily taken with the model of camera described in this manual.

Supplied Accessories

The following items are included with the camera:



NP-W126S rechargeable battery

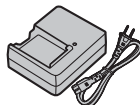

BC-W126 battery charger

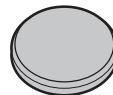

Lens cap (x 1)



Clip attaching tool



Metal strap clips (x 2)

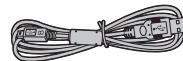

USB cable (Micro-B) (x 1)

- Protective covers (x 2)
- Shoulder strap
- Owner's Manual (*this manual*)

Parts of the Camera

For more information, refer to the page listed to the right of each item.

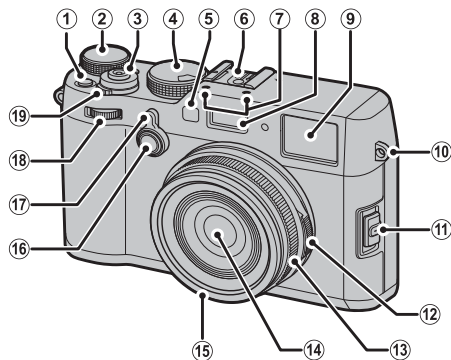

① Metering button	64	⑦ Microphone	40	⑮ Front ring.....	148
Function button (Fn1).....	46	⑧ Flash	82	⑯ Control ring options button	8
② Exposure compensation dial	62	⑨ Viewfinder window	10, 27, 30	Function button (Fn2).....	46
③ Shutter button	34	⑩ Strap eyelet	16	⑰ Viewfinder selector.....	28
④ Shutter speed dial/sensitivity dial	5, 49, 50, 51, 53	⑪ Focus mode selector	68	⑱ Front command dial	6
⑤ AF-assist illuminator.....	95	⑫ Aperture ring	9, 49, 50, 51, 53	⑲ ON/OFF switch	24
Self-timer lamp	78	⑬ Control ring.....	8, 54, 122		
⑥ Hot shoe	82	Focus ring.....	68, 69, 96, 122		
		⑭ Lens			

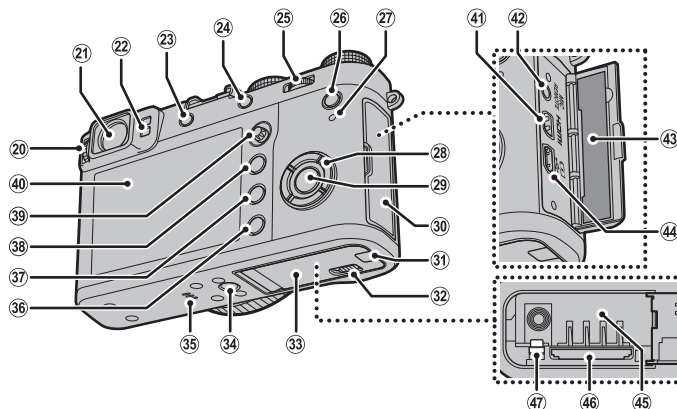



20 Diopter adjustment control.....	29	28 Selector	4, 25	37 (delete) button	6, 39
21 Viewfinder window	10, 27, 30	Function buttons	46	38 (playback) button	35
22 Eye sensor	27	29 MENU/OK button	89, 108, 113	39 Focus stick (focus lever)	5, 72, 73
23 VIEW MODE button	27	(control lock) button (press and hold)	4, 13	40 LCD monitor.....	12, 27, 30
24 AEL/AFL (autoexposure/autofocus lock) button	46, 68, 80, 122	30 Connector cover.....	41, 77, 133, 139	41 HDMI Micro connector (Type D)	139
25 Rear command dial.....	6, 46	31 Cable channel cover for DC coupler	140	42 Microphone/remote release connector	41, 77
26 Q (quick menu) button*	43	32 Battery-chamber cover latch	20	43 Serial number plate	4
Quick menu edit/custom settings button (press and hold while quick menu is displayed)*	45	33 Battery-chamber cover	20	44 Micro USB (Micro-B) USB 2.0 connector	133
RAW conversion button (playback mode)	85	34 Tripod mount		45 Battery chamber.....	20
27 Indicator lamp	7	35 Speaker.....	42	46 Memory card slot.....	21
		36 DISP (display)/ BACK button	30	47 Battery latch.....	20
		Function button role selection (press and hold).....	47		

* In shooting mode, press and release to display quick menu or press and hold to display quick menu edit options. When quick menu is displayed, press and hold to edit custom settings.





The Serial Number Plate

Do not remove the serial number plate, which provides the FCC ID, KC mark, serial number, and other important information.

Control Lock

To prevent accidental operation of the selector and **Q** button during shooting, press **MENU/OK** until  is displayed. The controls can be unlocked by pressing **MENU/OK** until  is no longer displayed.

The Selector

Press the selector up (①), right (③), down (④), or left (②) to highlight items. The up, left, right, and down buttons also double as the **DRIVE** ( 55), **Fn3** (film simulation;  65), **Fn4** (white balance;  66), and **Fn5** (AF mode;  71) buttons, respectively ( 46).

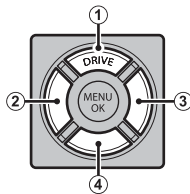

The Focus Stick (Focus Lever)

Tilt or press the focus stick to select the focus area (📖 72). The stick can also be used to scroll images during playback zoom and to navigate the menu.

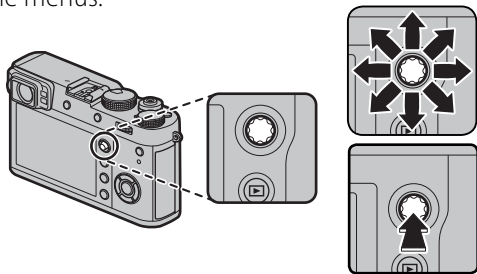
**The Shutter-Speed/ISO Dial**

Choose a shutter speed and ISO sensitivity.

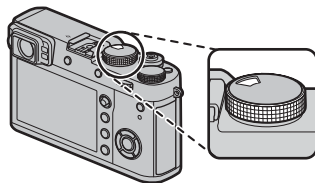

Rotate the dial to choose a shutter speed (📖 49, 50, 51, 53).

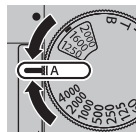

Lift and rotate the dial to choose ISO sensitivity (📖 63).



The Command Dials

Rotate or press the command dials to:

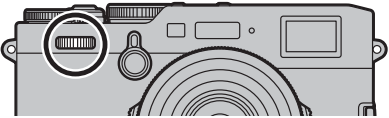
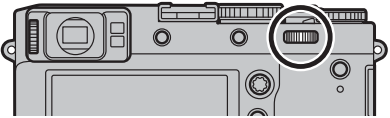
Front command dial	Rear command dial
	
<p>Select menu tabs or page through menus (see 89, 108, 113), adjust exposure compensation or sensitivity (see below), choose the size of the focus frame (see 73, 74), or view other pictures during playback without changing the zoom ratio (see 35, 37).</p>	<p>Highlight menu items (see 89, 108, 113), choose the desired combination of shutter and aperture (program shift; see 49), choose a shutter speed (see 50, 53), adjust settings in the quick menu (see 44), choose the size of the focus frame (see 73, 74), or zoom in or out in full-frame or thumbnail playback (see 37, 38).</p>
<p>Switch back and forth between exposure compensation and sensitivity (see below).</p>	<p>Zoom in on the selected focus area or (in playback mode) the active focus point. Press and hold to choose the manual focus mode focus display.</p>

Exposure Compensation and Sensitivity

The front command dial can be used to adjust exposure compensation when **C** is selected with the exposure compensation dial, and to adjust sensitivity when the sensitivity dial is set to **A** and **COMMAND** is selected for **FUNCTION/COMMAND SETTING > ISO DIAL SETTING (A)**. The center of the front command dial can be used to switch between exposure compensation and sensitivity when both of the foregoing conditions are met.

Formatting Memory Cards

The format menu can also be displayed by pressing the center of the rear command dial while pressing and holding the  button.

The Indicator Lamp

When the viewfinder is not in use (📖 27), the indicator lamp shows camera status.

Indicator lamp	Camera status
Glows green	Focus locked.
Blinks green	Focus or slow shutter speed warning. Pictures can be taken.
Blinks green and orange	Recording pictures. Additional pictures can be taken.
Glows orange	Recording pictures. No additional pictures can be taken at this time.
Blinks orange	Flash charging; flash will not fire when picture is taken.
Blinks red	Lens or memory error.

- ◆ Warnings may also appear in the display (📖 157).
- ◆ The indicator lamp does not light when your eye is to the viewfinder (📖 27).

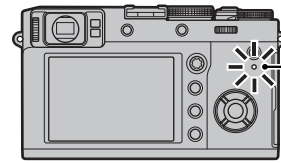

Indicator lamp

The Control Ring

Use the control ring for quick access to camera functions during shooting. The function assigned to the control ring can be selected by pressing the control ring options button. Choose from:

- DEFAULT
- FILM SIMULATION
- WHITE BALANCE
- DIGITAL TELE-CONV.

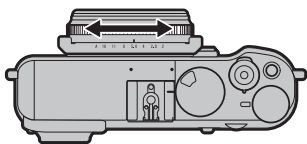

◆ The function assigned to the control ring can also be selected using **FUNCTION/DIAL SETTING > CONTROL RING SETTING** (122).

■ DEFAULT

When **DEFAULT** is selected, the function assigned to the control ring changes with the shooting mode.

Shooting mode	Function
P, S, A, M	Digital teleconverter
Advanced Filter	Filter selection
Panorama/Multiple Exposure	Film simulation

◆ Regardless of the option selected, when the focus mode selector is rotated to **M** (manual) in shooting mode **P, S, A**, or **M**, the control ring can be used only for manual focus.

The Aperture Ring and Shutter Speed Dial

Use the aperture ring and shutter speed dial to choose from modes **P**, **S**, **A**, and **M**.

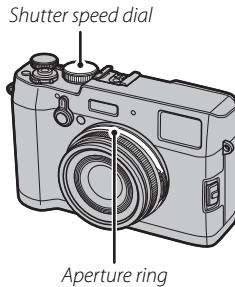

■ Mode P: Program AE

Aperture and shutter speed can be adjusted using program shift.

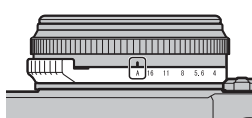

Aperture: A



Shutter speed: A

■ Mode S: Shutter-Priority AE

Take pictures at the selected shutter speed. The camera adjusts aperture automatically.

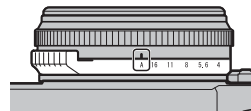

Aperture: A

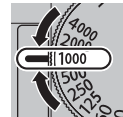

Shutter speed: Choose a speed

■ Mode A: Aperture-Priority AE

Take pictures at the selected aperture. The camera adjusts shutter speed automatically.

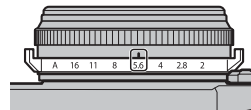

Aperture: Choose an aperture



Shutter speed: A

■ Mode M: Manual Exposure

Take pictures at the selected aperture and shutter speed.

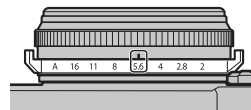

Aperture: Choose an aperture



Shutter speed: Choose a speed

① Control lock.....	4	⑭ Temperature warning.....	154, 159	⑳ Focus mode.....	68
② Sound and flash indicator.....	115	⑮ Virtual horizon.....	32	㉑ Histogram.....	32
③ ND (Neutral Density) filter indicator.....	101	⑯ Distance indicator.....	68	㉒ Dynamic range.....	91
④ Depth-of-field preview.....	52	⑰ Sensitivity.....	63	㉓ Film simulation.....	65
⑤ Conversion lens.....	149	⑱ Exposure compensation.....	62	㉔ White balance.....	66
⑥ Digital teleconverter.....	54	⑲ Aperture.....	49, 51, 53	㉕ AF lock.....	80
⑦ Location data download status.....	126	㉚ Shutter speed.....	49, 50, 53	㉖ Exposure indicator.....	53, 62
⑧ Number of available frames *.....	160	㉛ TTL lock.....	48, 103	㉗ AF+MF indicator.....	96
⑨ Image quality and size.....	90	㉜ AE lock indicator.....	80	㉘ Shutter type.....	99
⑩ Battery level.....	24	㉝ Metering.....	64	㉙ Continuous mode.....	55
⑪ Bright frame.....	150	㉞ Shooting mode.....	49, 50, 51, 53	㉚ Self-timer indicator.....	78
⑫ Focus frame.....	72, 80	㉟ Focus indicator.....	69	㉛ Microphone/remote release.....	41, 77, 106
⑬ Focus warning.....	7, 154, 157	㊱ Manual focus indicator.....	68, 69	㉜ Flash mode (TTL)/Flash compensation.....	82

* Shows "9999" if there is space for over 9999 frames.

Control Lock



Pressing a locked control (🗨️ 4) displays a  icon.

■ Shooting: Electronic Viewfinder/LCD Monitor

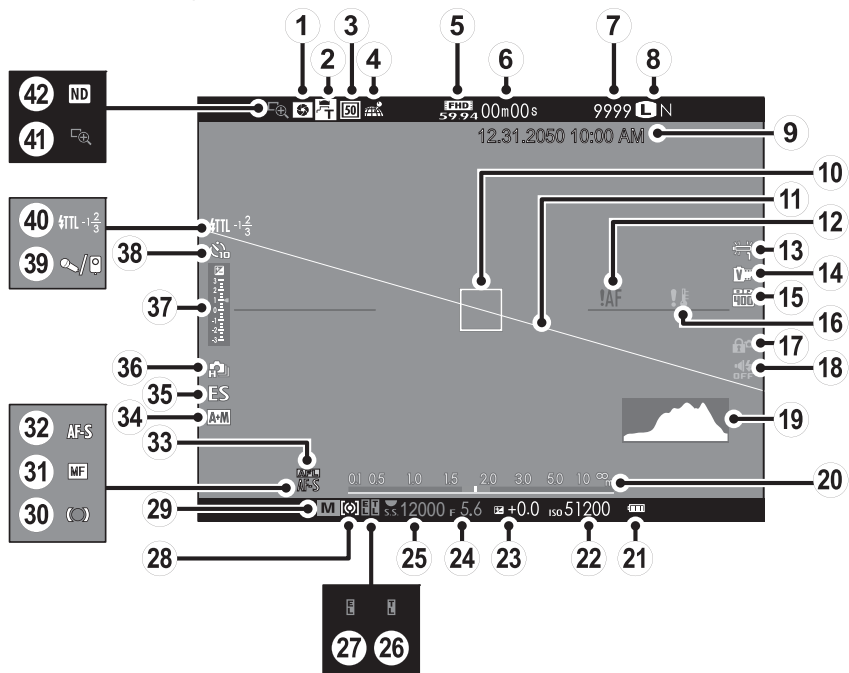

① Depth-of-field preview.....	52	⑮ Dynamic range	91	⑳ Shooting mode.....	49, 50, 51, 53
② Conversion lens.....	149	⑯ Temperature warning.....	154, 159	㉑ Focus indicator.....	69
③ Digital teleconverter.....	54	⑰ Control lock.....	4	㉒ Manual focus indicator	68, 69
④ Location data download status.....	126	⑱ Sound and flash indicator	115	㉓ Focus mode	68
⑤ Movie mode.....	40, 105	⑲ Histogram.....	32	㉔ AF lock.....	80
⑥ Time remaining	40	㉚ Distance indicator	68	㉕ AF+MF indicator	96
⑦ Number of available frames *	160	㉛ Battery level	24	㉖ Shutter type.....	99
⑧ Image quality and size.....	90	㉜ Sensitivity.....	63	㉗ Continuous mode	55
⑨ Date and time.....	25, 26	㉝ Exposure compensation.....	62	㉘ Exposure indicator	53, 62
⑩ Focus frame	72, 80	㉞ Aperture	49, 51, 53	㉙ Self-timer indicator	78
⑪ Virtual horizon.....	32	㉟ Shutter speed	49, 50, 53	㉚ Microphone/remote release	41, 77, 106
⑫ Focus warning	7, 154, 157	㊱ TTL lock.....	48, 103	㉛ Flash (TTL) mode/Flash compensation	82
⑬ White balance.....	66	㊲ AE lock indicator	80	㉜ Focus check.....	69
⑭ Film simulation.....	65	㊳ Metering.....	64	㉝ ND (Neutral Density) filter indicator	101

* Shows "9999" if there is space for over 9999 frames.

Control Lock



Pressing a locked control (🔒 4) displays a  icon.

■ Playback

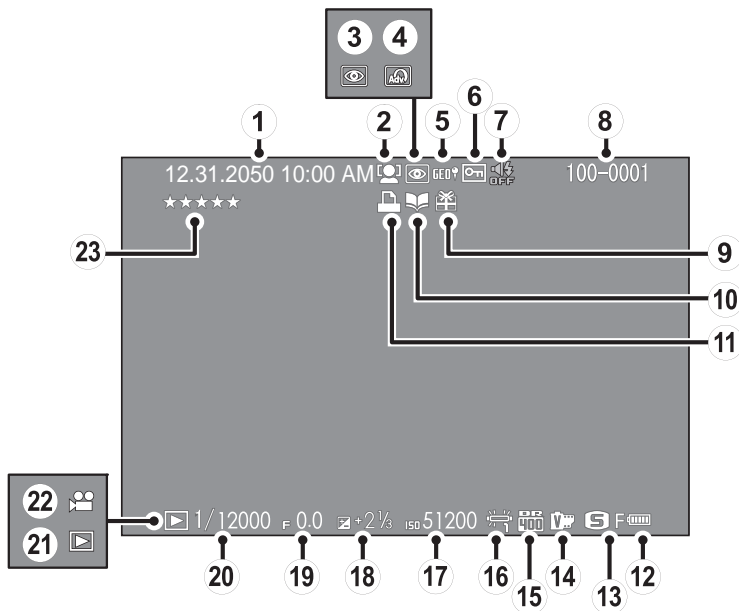

① Date and time.....	25, 26	⑨ Gift image.....	35	⑰ Sensitivity.....	63
② Face detection indicator.....	95	⑩ Photobook assist indicator.....	87	⑱ Exposure compensation.....	62
③ Red-eye removal indicator.....	111	⑪ DPOF print indicator.....	135	⑲ Aperture.....	49, 51, 53
④ Advanced filter.....	58	⑫ Battery level.....	24	⑳ Shutter speed.....	49, 50, 53
⑤ Location data.....	126	⑬ Image size/quality.....	90	㉑ Playback mode indicator.....	35
⑥ Protected image.....	110	⑭ Film simulation.....	65	㉒ Movie icon.....	42
⑦ Sound and flash indicator.....	115	⑮ Dynamic range.....	91	㉓ Rating.....	35
⑧ Frame number.....	124	⑯ White balance.....	66		

First Steps

Attaching the Strap

Attach the strap clips to the camera and then attach the strap.

1 Open a strap clip.

Use the clip attaching tool to open a strap clip, making sure that the tool and clip are in the orientations shown.



① Keep the tool in a safe place. You will need it to open the strap clips when removing the strap.

2 Place the strap clip on an eyelet.

Hook the strap eyelet in the clip opening. Remove the tool, using the other hand to keep the clip in place.

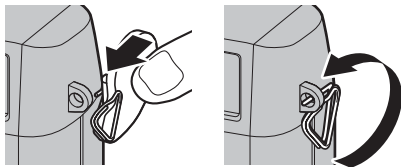

3 Pass the clip through the eyelet.

Rotate the clip fully through the eyelet until it clicks closed.

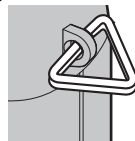

4 Attach a protective cover.

Place a protective cover over the eyelet as shown, with the black side of the cover toward the camera. Repeat Steps 1–4 for the second eyelet.

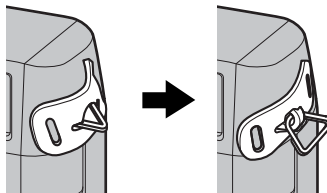

5 Insert the strap.

Insert the strap through a protective cover and strap clip.

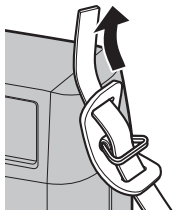
**6 Fasten the strap.**

Fasten the strap as shown. Repeat Steps 5–6 for the second eyelet.

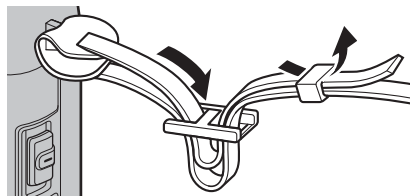

- ⓘ To avoid dropping the camera, be sure the strap is correctly secured.

Charging the Battery

The battery is not charged at shipment. Before use, charge the battery in the supplied battery charger.

1 Place the battery in the charger.

Place the battery in the supplied battery charger as shown.

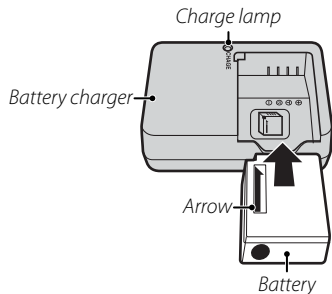

The camera uses an NP-W126S rechargeable battery.

- ◆ The supplied AC cord is for use exclusively with the supplied battery charger. Do not use the supplied charger with other cords or the supplied cord with other devices.

2 Plug the charger in.

Plug the charger into an indoor power outlet. The charging indicator will light.

The Charging Indicator

The charging indicator shows battery charge status as follows:

Charging indicator	Battery status	Action
Off	Battery not inserted.	Insert the battery.
	Battery fully charged.	Remove the battery.
On	Battery charging.	—
Blinks	Battery fault.	Unplug the charger and remove the battery.

3 Charge the battery.

Remove the battery when charging is complete. See the specifications (📖 166) for charging times (note that charging times increase at low temperatures).

- ① Unplug the charger when it is not in use.

Charging via a Computer

The battery can be charged by connecting the camera to a computer. Connect the supplied USB cable as shown, making sure the connectors are fully inserted.

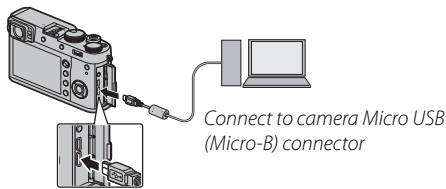

- ⓘ Connect the camera directly to the computer; do not use a USB hub or keyboard.
- ⓘ Charging stops if the computer enters sleep mode; to resume charging, activate the computer and disconnect and reconnect the USB cable.
- ⓘ Charging may not be supported depending on the model of computer, computer settings, and the computer's current state.
- ⓘ The battery will not charge while the camera is on.
- 🔦 The indicator lamp shows battery charge status as follows:

Indicator lamp	Battery status
On	Battery charging.
Off	Charging complete.
Blinks	Battery fault.

Inserting the Battery and a Memory Card

After charging the battery, insert the battery in the camera as described below.

1 Open the battery-chamber cover.

Slide the battery-chamber latch as shown and open the battery-chamber cover.

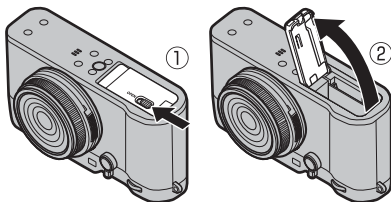

- ① Do not open the battery-chamber cover when the camera is on. Failure to observe this precaution could damage image files or memory cards.
- ① Do not use excessive force when handling the battery-chamber cover.

2 Insert the battery.

Using the battery to keep the battery latch pressed to one side, insert the battery contacts first in the direction shown by the arrow. Confirm that the battery is securely latched.

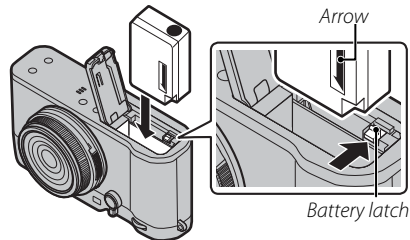

- ① Insert the battery in the orientation shown. **Do not use force or attempt to insert the battery upside down or backwards.** The battery will slide in easily in the correct orientation.

3 Insert the memory card

Holding the memory card in the orientation shown, slide it in until it clicks into place at the back of the slot.

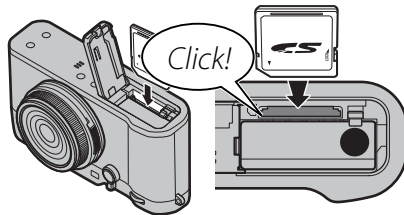

- ① Be sure card is in the correct orientation; do not insert at an angle or use force.

4 Close the battery-chamber cover.

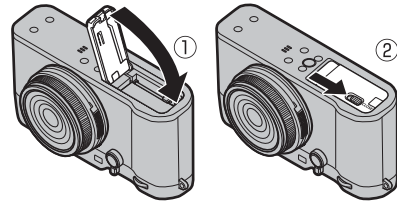

① Batteries

- Remove dirt from the battery terminals with a clean, dry cloth. Failure to observe this precaution could prevent the battery from charging.
- Do not affix stickers or other objects to the battery. Failure to observe this precaution could make it impossible to remove the battery from the camera.
- Do not short the battery terminals. The battery could overheat.
- Read the cautions in “The Battery and Power Supply” (📖 v).
- Use only battery chargers designated for use with the battery. Failure to observe this precaution could result in product malfunction.
- Do not remove the labels from the battery or attempt to split or peel the outer casing.
- The battery gradually loses its charge when not in use. Charge the battery one or two days before use.

● Removing the Battery

Before removing the battery, **turn the camera off** and open the battery-chamber cover.

To remove the battery, press the battery latch to the side, and slide the battery out of the camera as shown.

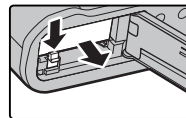

- ① The battery may become hot when used in high-temperature environments. Observe caution when removing the battery.

● Removing Memory Cards

Before removing memory cards, **turn the camera off** and open the battery-chamber cover.

Press and release the card to eject it part way (to prevent the card falling from the slot, press the center of the card and release it slowly, without removing your finger from the card). The card can then be removed by hand.

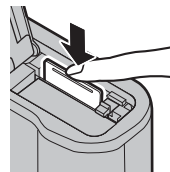

■ Compatible Memory Cards

FUJIFILM and SanDisk SD, SDHC, and SDXC memory cards have been approved for use in the camera. A complete list of approved memory cards is available at http://www.fujifilm.com/support/digital_cameras/compatibility/. Operation is not guaranteed with other cards. The camera can not be used with **xD-Picture Cards** or **MultiMediaCard** (MMC) devices.

ⓘ Memory Cards

- ***Do not turn the camera off or remove the memory card while the memory card is being formatted or data are being recorded to or deleted from the card.*** Failure to observe this precaution could damage the card.
- Format memory cards before first use, and be sure to reformat all memory cards after using them in a computer or other device. For more information on formatting memory cards, see page 114.
- Memory cards are small and can be swallowed; keep out of reach of children. If a child swallows a memory card, seek medical assistance immediately.
- miniSD or microSD adapters that are larger or smaller than the standard dimensions of an SD/SDHC/SDXC card may not eject normally; if the card does not eject, take the camera to an authorized service representative. Do not forcibly remove the card.
- Do not affix labels to memory cards. Peeling labels can cause camera malfunction.
- Movie recording may be interrupted with some types of SD/SDHC/SDXC memory card. Use a UHS speed class 1 card or better for movies and burst photography.
- Formatting a memory card in the camera creates a folder in which pictures are stored. Do not rename or delete this folder or use a computer or other device to edit, delete, or rename image files. Always use the camera to delete pictures; before editing or renaming files, copy them to a computer and edit or rename the copies, not the originals. Renaming the files on the camera can cause problems during playback.

Turning the Camera on and Off





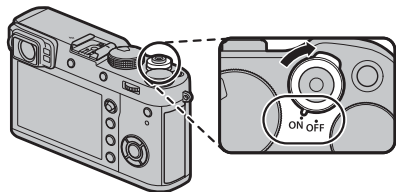

Rotate the **ON/OFF** switch to **ON** to turn the camera on. Select **OFF** to turn the camera off.

- ◆ Press the  button to start playback. Press the shutter button half-way to return to shooting mode.
 - ◆ The camera will turn off automatically if no operations are performed for the length of time selected for **POWER MANAGEMENT > AUTO POWER OFF** (📖 123). To reactivate the camera after it has turned off automatically, press the shutter button halfway or turn the **ON/OFF** switch to **OFF** and then back to **ON**.
- ⓘ Fingerprints and other marks on the lens or viewfinder can affect pictures or the view through the viewfinder. Keep the lens and viewfinder clean.



Battery Level

After turning the camera on, check the battery level in the display.

Indicator	Description
	Battery partially discharged.
	Battery about 80% full.
	Battery about 60% full.
	Battery about 40% full.
	Battery about 20% full.
 (red)	Low battery. Charge as soon as possible.
 (blinks red)	Battery exhausted. Turn camera off and recharge battery.

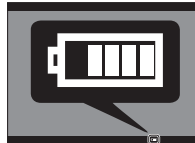

Basic Setup

A language-selection dialog is displayed the first time the camera is turned on.

1 Choose a language.

Highlight a language and press **MENU/OK**.

- Press **DISP/BACK** to skip the current step. Any steps you skip will be displayed the next time the camera is turned on.



2 Set the date and time.

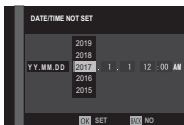

Press the selector left or right to highlight the year, month, day, hour, or minute and press up or down to change. To change the order in which the year, month, and day are displayed, highlight the date format and press the selector up or down. Press **MENU/OK** to exit to shooting mode when settings are complete.



- If the battery is removed for an extended period, the camera clock will be reset and the language-selection dialog will be displayed when the camera is turned on.

Changing Basic Settings

To change the language or reset the clock:

1 Display the desired option.

Display the setup menu and select **USER SETTING** > **言語/LANG.** to change the language or **DATE/TIME** to reset the clock (📖 113).

2 Adjust settings.

To choose a language, highlight the desired option and press **MENU/OK**. To set the clock, press the selector left or right to highlight the year, month, day, hour, or minute and press up or down to change, then press **MENU/OK** once the clock has been set to your satisfaction.

Display Settings

The camera is equipped with a hybrid optical/electronic viewfinder (OVF/EVF) and an LCD monitor (LCD).

Choosing a Display

Press the **VIEW MODE** button to cycle through displays as shown below.

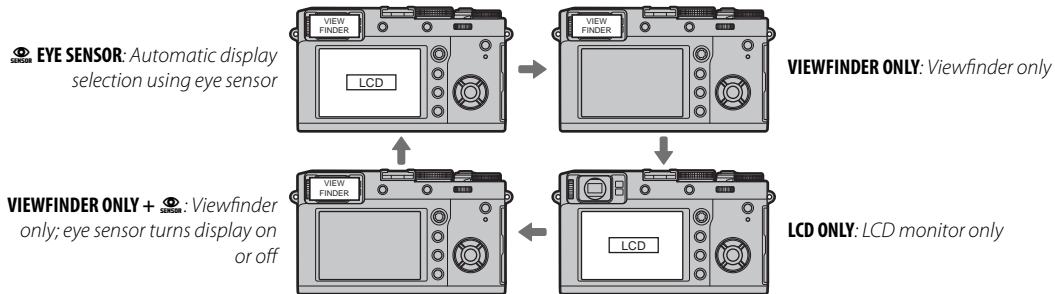
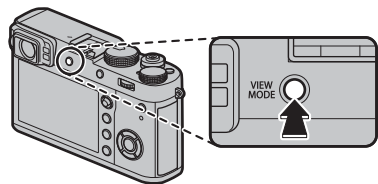

The Eye Sensor

The eye sensor turns the viewfinder on when you put your eye to the viewfinder and turns it off when you take your eye away (note that the eye sensor may respond to objects other than your eye or to light shining directly on the sensor). If automatic display selection is enabled, the LCD monitor will turn on when the viewfinder turns off.

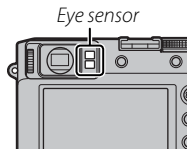

The Viewfinder Selector

Use the viewfinder selector to switch between the electronic viewfinder (EVF), the optical viewfinder (OVF), and a dual optical viewfinder/electronic range finder (ERF) display.

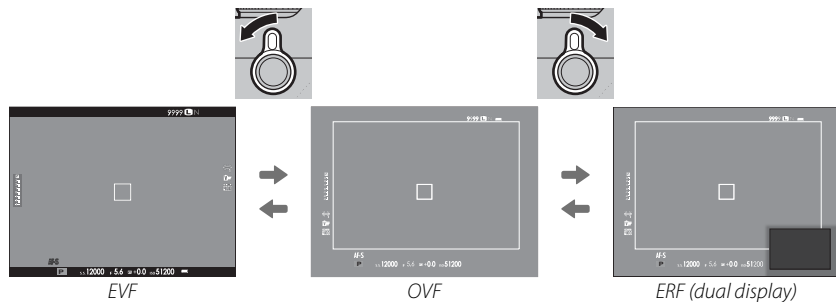
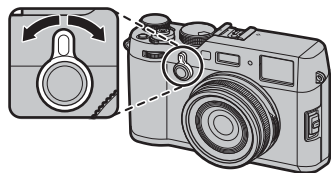

The Hybrid (EVF/OVF/ERF) Viewfinder

The features of the different displays are described below.

Display	Description
OVF	The optical display is sharp and free of blur so that your subject's expression is always visible. In addition, the OVF shows the area just outside the frame, making it easier to compose shots on the fly. Because the viewfinder window is a slight distance from the lens, the area visible in photographs may however differ slightly from the display in the viewfinder due to parallax.
EVF	The live view display gives you a preview of the final picture, including depth of field, focus, exposure, and white balance. Frame coverage is approximately 100%, ensuring accurate framing under all conditions.
ERF (dual display)	As for the optical viewfinder but with a focus preview. A magnified view of an area of the frame including the current focus position is shown at the bottom right corner of the display.

The Viewfinder Display

When **ON** is selected for **SCREEN SETTING > EVF AUTOROTATE DISPLAYS** (📖 119), the indicators in the viewfinder automatically rotate to match camera orientation.

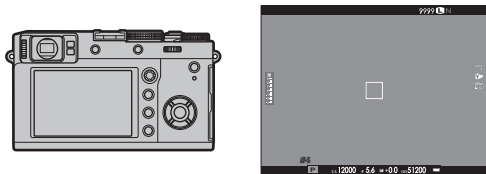

↙ Orientation changed from "wide" to "tall"

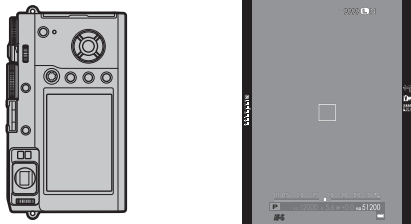

ⓘ The display in the LCD monitor is unaffected.

Focusing the Viewfinder

The camera is equipped with diopter adjustment in the range -2 to $+1$ m⁻¹ to accommodate individual differences in vision. Rotate the diopter adjustment control until the viewfinder display is in sharp focus.

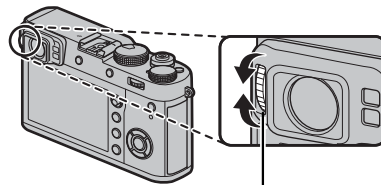

Diopter adjustment control

Adjusting Display Brightness

The brightness and hue of the viewfinder and LCD monitor can be adjusted using the options under **SCREEN SETTING**. Choose **EVF BRIGHTNESS** or **EVF COLOR** to adjust viewfinder brightness or hue (📖 118), **LCD BRIGHTNESS** or **LCD COLOR** to do the same for the LCD monitor (📖 118).

The DISP/BACK Button

The **DISP/BACK** button controls the display of indicators in the viewfinder and LCD monitor.

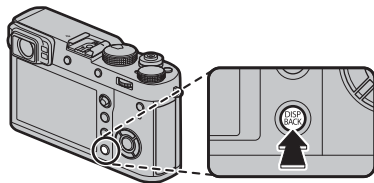

Shooting: Optical Viewfinder

Standard

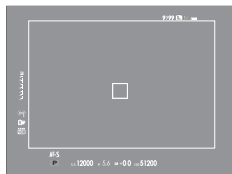

Information off



Shooting: Electronic Viewfinder

Standard

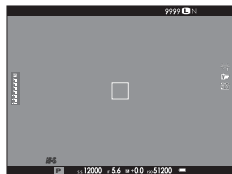

Information off



LCD Monitor: Shooting

Standard



Information off

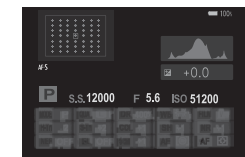

Info display

■ Customizing the Standard Display

To choose the items shown in the standard display:

1 Display standard indicators.

Press the **DISP/BACK** button until standard indicators are displayed.

2 Select **DISP. CUSTOM SETTING**.

Select  **SCREEN SETTING** > **DISP. CUSTOM SETTING** (120) in the setup menu.

3 Choose a display.

Highlight **OVF** or **EVF/LCD** and press **MENU/OK**.

4 Choose items.

Highlight items and press **MENU/OK** to select or deselect.

Option	OVF	EVF	Option	OVF	EVF	Option	OVF	EVF
FRAMING GUIDELINE	<input type="checkbox"/>	<input type="checkbox"/>	Expo. Comp. (Digit)	<input type="checkbox"/>	<input type="checkbox"/>	DYNAMIC RANGE	<input checked="" type="checkbox"/>	<input checked="" type="checkbox"/>
ELECTRONIC LEVEL	<input type="checkbox"/>	<input type="checkbox"/>	Expo. Comp. (Scale)	<input checked="" type="checkbox"/>	<input checked="" type="checkbox"/>	FRAMES REMAINING	<input checked="" type="checkbox"/>	<input checked="" type="checkbox"/>
FOCUS FRAME	<input checked="" type="checkbox"/>	<input checked="" type="checkbox"/>	FOCUS MODE	<input checked="" type="checkbox"/>	<input checked="" type="checkbox"/>	IMAGE SIZE/QUALITY	<input checked="" type="checkbox"/>	<input checked="" type="checkbox"/>
AF DISTANCE INDICATOR	<input type="checkbox"/>	<input type="checkbox"/>	PHOTOMETRY	<input checked="" type="checkbox"/>	<input checked="" type="checkbox"/>	MOVIE MODE & REC. TIME	<input type="checkbox"/>	<input checked="" type="checkbox"/>
MF DISTANCE INDICATOR	<input checked="" type="checkbox"/>	<input checked="" type="checkbox"/>	SHUTTER TYPE	<input checked="" type="checkbox"/>	<input checked="" type="checkbox"/>	DIGITAL TELE-CONV.	<input checked="" type="checkbox"/>	<input checked="" type="checkbox"/>
HISTOGRAM	<input type="checkbox"/>	<input type="checkbox"/>	FLASH	<input checked="" type="checkbox"/>	<input checked="" type="checkbox"/>	CONVERSION LENS	<input checked="" type="checkbox"/>	<input checked="" type="checkbox"/>
SHOOTING MODE	<input checked="" type="checkbox"/>	<input checked="" type="checkbox"/>	CONTINUOUS MODE	<input checked="" type="checkbox"/>	<input checked="" type="checkbox"/>	BATTERY LEVEL	<input checked="" type="checkbox"/>	<input checked="" type="checkbox"/>
APERTURE/S-SPEED/ISO	<input checked="" type="checkbox"/>	<input checked="" type="checkbox"/>	WHITE BALANCE	<input checked="" type="checkbox"/>	<input checked="" type="checkbox"/>	FRAMING OUTLINE	<input type="checkbox"/>	<input type="checkbox"/>
INFORMATION BACKGROUND	<input type="checkbox"/>	<input checked="" type="checkbox"/>	FILM SIMULATION	<input checked="" type="checkbox"/>	<input checked="" type="checkbox"/>			

5 Save changes.

Press **DISP/BACK** to save changes.

6 Exit the menus.

Press **DISP/BACK** as needed to exit the menus and return to the shooting display.

◆ See page 10 for the locations of these items in the displays.

Virtual Horizon

Selecting **ELECTRONIC LEVEL** displays a virtual horizon. The camera is level when the two lines overlap.

◆ The virtual horizon may not be displayed if the camera lens is pointed up or down.

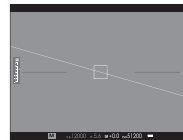

Framing Outline

Enable **FRAMING OUTLINE** to make the borders of the frame easier to see against dark backgrounds.

Viewfinder/LCD Monitor: Playback

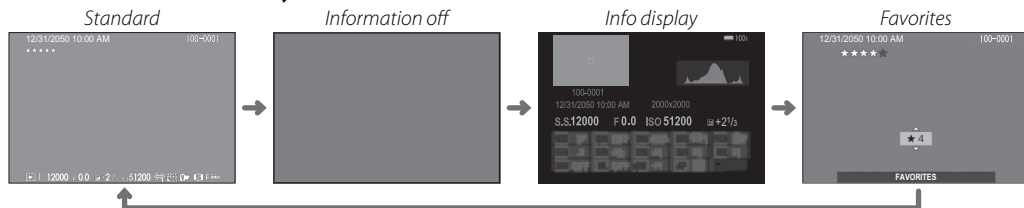

Histograms

Histograms show the distribution of tones in the image. Brightness is shown by the horizontal axis, the number of pixels by the vertical axis.

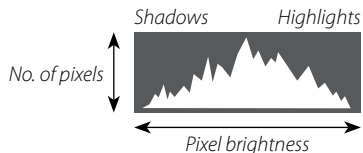

Optimal exposure: Pixels are distributed in an even curve throughout the tone range.



Overexposed: Pixels are clustered on the right side of the graph.



Underexposed: Pixels are clustered on the left side of the graph.



Basic Photography and Playback

Taking Photographs

This section describes how to take pictures using program AE (mode **P**). See pages 49–53 for information on **S**, **A**, and **M** modes.

1 Adjust settings for program AE.

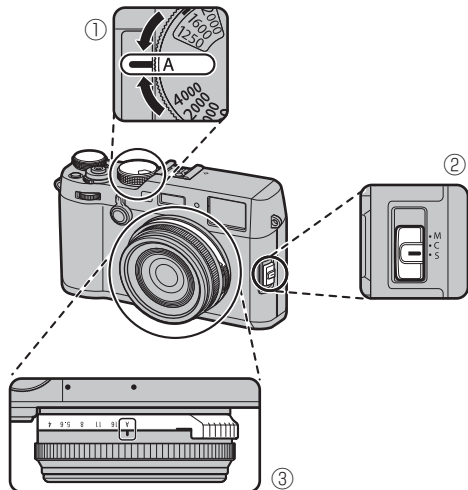

- 1 **Shutter speed:** Select **A** (auto)
- 2 **Focus mode:** Select **S** (single AF)
- 3 **Aperture:** Select **A** (auto)

Confirm that **P** appears in the display.

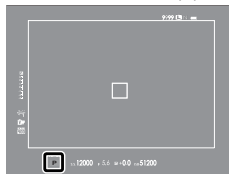

OVF



EVF/LCD

Viewfinder Display Selection

Use the viewfinder selector to switch between the optical viewfinder (OVF) and electronic viewfinder (EVF) displays.

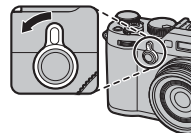

2 Ready the camera.

Hold the camera steady with both hands and brace your elbows against your sides. Shaking or unsteady hands can blur your shots.



To prevent pictures that are out of focus or too dark (underexposed), keep your fingers and other objects away from the lens and flash.

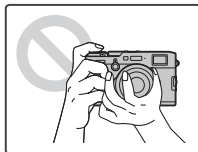

3 Frame the picture.

4 Focus.

Frame the picture with your subject in the center of the display and press the shutter button halfway to focus.



- ◆ If the subject is poorly lit, the AF-assist illuminator may light (📖 95).

If the camera is able to focus, it will beep twice and focus area and focus indicator will glow green. Focus and exposure will lock while the shutter button is pressed halfway.

If the camera is unable to focus, the focus frame will turn red, **!AF** will be displayed, and the focus indicator will blink white.

5 Shoot.

Smoothly press the shutter button the rest of the way down to take the picture.



- ◆ The flash may fire if lighting is poor. Camera settings can be changed to prevent the flash firing (📖 82).

Viewing Pictures

Viewing Pictures Full Frame

Pictures can be viewed in the viewfinder or LCD monitor. When taking important pictures, take a test shot and check the results.

To view pictures full frame, press .

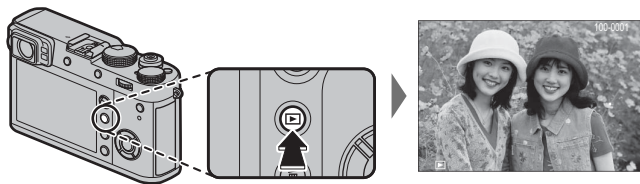

Additional pictures can be viewed by pressing the selector left or right or rotating the front command dial. Press the selector or rotate the dial right to view pictures in the order recorded, left to view pictures in reverse order. Keep the selector pressed to scroll rapidly to the desired frame.

◆ Pictures taken using other cameras are marked with a  ("gift image") icon to warn that they may not display correctly and that playback zoom may not be available.

Favorites: Rating Pictures

To rate the current picture, press **DISP/BACK** and press the selector up and down to select from zero to five stars.

Viewing Photo Information

The photo information display changes each time the selector is pressed up.

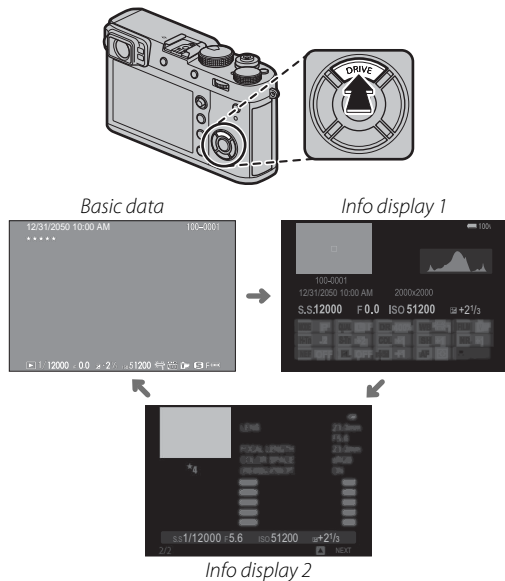

- ◆ Rotate the front command dial to view other images.

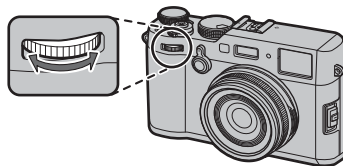

◆ Zooming in on the Focus Point

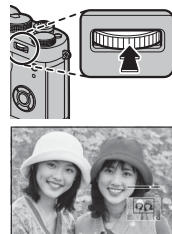

Press the center of the rear command dial to zoom in on the focus point. Press again to return to full-frame playback.

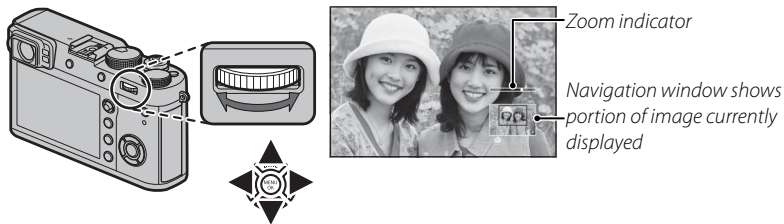

Playback Zoom

Rotate the rear command dial right to zoom in on the current picture, left to zoom out (to view multiple images, rotate the dial left when the picture is displayed full frame;  38). When the picture is zoomed in, the selector can be used to view areas of the image not currently visible in the display. To exit zoom, press the **DISP/BACK** or **MENU/OK** button.



- ◆ The maximum zoom ratio varies with image size ( 90). Playback zoom is not available with cropped or resized copies saved at a size of **640** ( 109, 110).
- ◆ Rotate the front command dial to view other pictures without changing the zoom ratio.

Multi-Frame Playback

To change the number of images displayed, rotate the rear command dial left when a picture is displayed full frame.

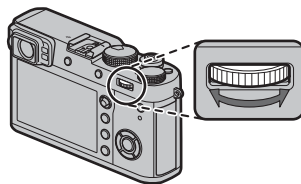

Rotate left to view more images.

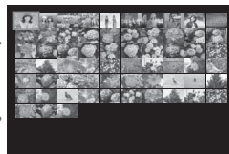



Rotate right to view fewer images.

Use the selector to highlight images and press **MENU/OK** to view the highlighted image full frame (to zoom in on the selected image, rotate the rear command dial right when the picture is displayed full frame; 37). In the nine- and hundred-frame displays, press the selector up or down to view more pictures.

Deleting Pictures

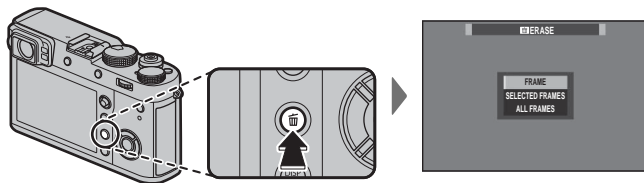
To delete individual pictures, multiple selected pictures, or all pictures, press the  button when a picture is displayed full frame and choose from the options below. *Note that deleted pictures can not be recovered. Copy important pictures to a computer or other storage device before proceeding.*



Option	Description
FRAME	Press the selector left or right to scroll through pictures and press MENU/OK to delete the current picture (a confirmation dialog is not displayed).
SELECTED FRAMES	Highlight pictures and press MENU/OK to select or deselect (pictures in photobooks or print orders are shown by ). When the operation is complete, press DISP/BACK to display a confirmation dialog, then highlight OK and press MENU/OK to delete the selected pictures.
ALL FRAMES	A confirmation dialog will be displayed; highlight OK and press MENU/OK to delete all unprotected pictures. Pressing DISP/BACK cancels deletion; note that any pictures deleted before the button was pressed can not be recovered.

- 🔒 Protected pictures can not be deleted. Remove protection from any pictures you wish to delete (📖 110).
- 🔒 Pictures can also be deleted from the menus using the **PLAY BACK MENU > ERASE** option (📖 109).
- 🔒 If a message appears stating that the selected images are part of a DPOF print order, press **MENU/OK** to delete the pictures.

Basic Movie Recording and Playback

Recording Movies

The camera can be used to record high-definition movies. Sound is recorded in stereo via the built-in microphone; do not cover the microphone during recording.

- 1 Press the **DRIVE** (**▲**) button to display drive mode options.

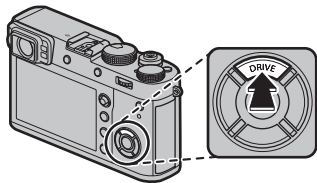

- 2 Highlight **MOVIE** and press **MENU/OK** to enter movie recording standby mode.

- 3 Press the shutter button to start recording.

Recording indicator

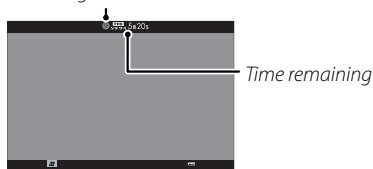

- ① The indicator lamp lights while movies are being recorded.

- 4 Press the button again to end recording. Recording ends automatically when the maximum length is reached or the memory card is full.

- ◆ Frame size and rate can be selected using **MOVIE SETTING > MOVIE MODE** (105). Focus mode is selected using the focus mode selector (68); for continuous focus adjustment, select **C**, or choose **S** and enable Intelligent Face Detection (95). Intelligent Face Detection is not available in focus mode **M**.
- ◆ The viewfinder automatically switches to the EVF display when **MOVIE** is selected for drive mode.
- ◆ During recording, exposure compensation can be adjusted by up to ± 2 EV.
- ① The microphone may pick up lens noise and other sounds made by the camera during recording.
- ① Vertical or horizontal streaks may appear in movies containing very bright subjects. This is normal and does not indicate a malfunction.

Depth of Field

Adjust aperture before recording begins. Choose low f-numbers to soften background details.

Using an External Microphone

Sound can be recorded with external microphones that connect using jacks 2.5 mm in diameter; microphones that require bus power can not be used. See the microphone manual for details.

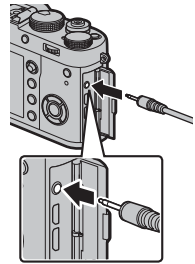

- ◆ The dialog shown at right will be displayed when a microphone is connected to the microphone/remote release connector. Press **MENU/OK** and select **MIC/REMOTE RELEASE > MIC**.

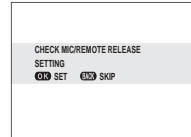

Viewing Movies

During playback, movies are displayed as shown at right. The following operations can be performed while a movie is displayed:

Operation	Description
Start/pause playback	Press the selector down to start playback. Press again to pause. While playback is paused, you can press the selector left or right to rewind or advance one frame at a time.
End playback	Press the selector up to end playback.
Adjust speed	Press the selector left or right to adjust playback speed during playback.
Adjust volume	Press MENU/OK to pause playback and display volume controls. Press the selector up or down to adjust the volume; press MENU/OK again to resume playback. Volume can also be adjusted using [F] SOUND SETTING > PLAYBACK VOLUME (117).



Movie icon

Progress is shown in the display during playback.

- ① Do not cover the speaker during playback.
- ① Selecting **OFF** for **[F] USER SETTING > SOUND & FLASH** mutes audio playback.

Progress bar



Playback Speed

Press the selector left or right to adjust playback speed during playback. Speed is shown by the number of arrows (▶ or ◀).

Arrow



The Q (Quick Menu) Button

Using the Q Button

Press **Q** for quick access to selected options.

The Quick Menu Display

At default settings, the quick menu contains the following items.

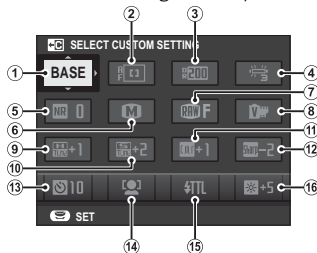

- ① SELECT CUSTOM SETTING
- ② AF MODE
- ③ DYNAMIC RANGE
- ④ WHITE BALANCE
- ⑤ NOISE REDUCTION
- ⑥ IMAGE SIZE
- ⑦ IMAGE QUALITY
- ⑧ FILM SIMULATION

- ⑨ HIGHLIGHT TONE
- ⑩ SHADOW TONE
- ⑪ COLOR
- ⑫ SHARPNESS
- ⑬ SELF-TIMER
- ⑭ FACE/EYE DETECTION SETTING
- ⑮ FLASH FUNCTION SETTING
- ⑯ EVF/LCD BRIGHTNESS

The quick menu shows the options currently selected for items ②—⑯, which can be changed as described on page 45. The **IMAGE QUALITY SETTING > SELECT CUSTOM SETTING** item (item ①) shows the current custom settings bank:

- **BASE**: No custom settings bank selected.
- **C 1** — **C 7**: Select a bank to view the settings saved using the **IMAGE QUALITY SETTING > EDIT/SAVE CUSTOM SETTING** option (86).
- **C 1** — **C 7**: The current custom settings bank.

Viewing and Changing Settings

1 Press **Q** to display the quick menu during shooting.

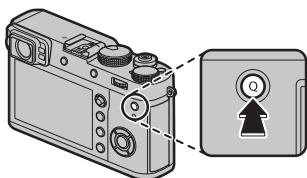

2 Use the selector to highlight items and rotate the rear command dial to change.

- Changes are not saved to the current settings bank (📖 43). Settings that differ from those in the current settings bank (**C1** — **C7**) are shown in red.



3 Press **Q** to exit when settings are complete.

Editing the Quick Menu

To choose the items displayed in the quick menu:

- 1 Press and hold the **Q** button during shooting.

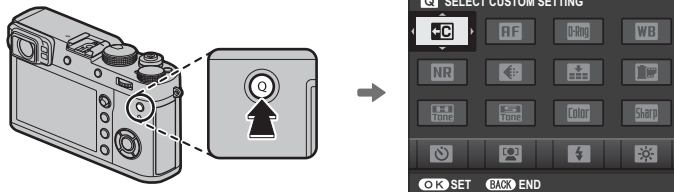

- 2 The current quick menu will be displayed; use the selector to highlight the item you wish to change and press **MENU/OK**. You will be given the following choice of items to assign to the selected position:

- IMAGE SIZE
- IMAGE QUALITY
- FILM SIMULATION *
- GRAIN EFFECT *
- DYNAMIC RANGE *
- WHITE BALANCE *
- HIGHLIGHT TONE *
- SHADOW TONE *
- COLOR *
- SHARPNESS *
- NOISE REDUCTION *
- SELECT CUSTOM SETTING *
- AF MODE
- FACE/EYE DETECTION SETTING
- MF ASSIST
- SELF-TIMER
- PHOTOMETRY
- SHUTTER TYPE
- CONVERSION LENS
- ND FILTER
- FLASH FUNCTION SETTING
- FLASH COMPENSATION
- MOVIE MODE
- MIC LEVEL ADJUSTMENT
- SOUND & FLASH
- EVF/LCD BRIGHTNESS
- EVF/LCD COLOR
- NONE

* Stored in custom settings bank.

- ◆ Select **NONE** to assign no option to the selected position. When **SELECT CUSTOM SETTING** is selected, current settings are shown in the quick menu by the label **BASE**.

- 3 Highlight the desired item and press **MENU/OK** to assign it to the selected position.

- ◆ The quick menu can also be edited using **Q BUTTON/DIAL SETTING > EDIT/SAVE QUICK MENU** (121).

The Fn (Function) Buttons

Using the Function Buttons

The roles played by each of the function buttons can be selected by pressing and holding the button. The default options are shown below:

Fn1 button

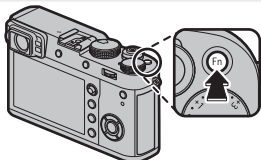

Photometry (📖 64)

Fn2 button



Control ring options (📖 8)

Fn3 button

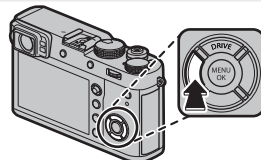

Film simulation (📖 65)

Fn4 button

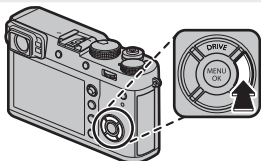

White balance (📖 66)

Fn5 button

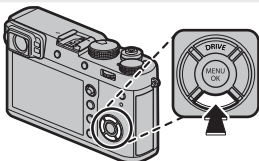

AF mode (📖 71)

AEL/AFL button

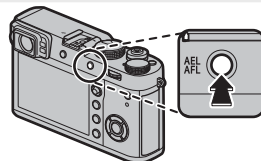

Exposure/Focus lock (📖 80)

Center of rear command dial

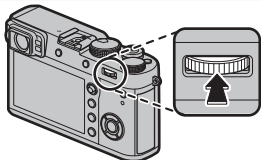

Focus check (📖 69)

Assigning Roles to the Function Buttons

To assign roles to the function buttons, press and hold the **DISP/BACK** button until the menu below is displayed. Select buttons to choose their roles.

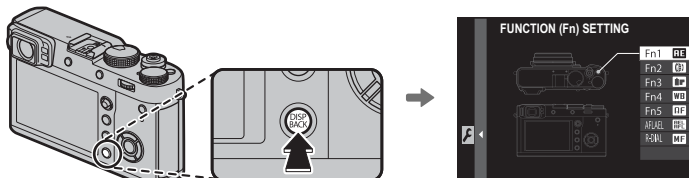

- | | | | |
|-------------------------|------------------------------|--------------------------|----------------------------------|
| • IMAGE SIZE | • FOCUS AREA | • CONVERSION LENS | • PREVIEW EXP./WB IN MANUAL MODE |
| • IMAGE QUALITY | • FOCUS CHECK | • ND FILTER | • PREVIEW PIC. EFFECT |
| • RAW | • AF MODE | • WIRELESS COMMUNICATION | • AE LOCK ONLY |
| • FILM SIMULATION | • FACE/EYE DETECTION SETTING | • FLASH FUNCTION SETTING | • AF LOCK ONLY |
| • GRAIN EFFECT | • SELF-TIMER | • TTL-LOCK | • AE/AF LOCK |
| • DYNAMIC RANGE | • PHOTOMETRY | • MODELING FLASH | • CONTROL RING SETTING |
| • WHITE BALANCE | • SHUTTER TYPE | • MIC LEVEL ADJUSTMENT | • PLAYBACK |
| • SELECT CUSTOM SETTING | • ISO AUTO SETTING | • PREVIEW DEPTH OF FIELD | • NONE |

- ◆ To disable the selected button, choose **NONE**.
- ◆ You can also display options for any of the function buttons by pressing and holding the button. This does not apply to buttons to which **FOCUS CHECK**, **AE LOCK ONLY**, **AF LOCK ONLY**, or **AE/AF LOCK** are currently assigned.
- ◆ The roles played by the six function buttons can also be selected using **FUNCTION/DIAL SETTING > FUNCTION (Fn) SETTING** (121).

■ TTL-LOCK

If **TTL-LOCK** is selected, you can press the control to lock flash output according to the option selected for **FLASH SETTING > TTL-LOCK MODE** (📖 103).

■ MODELING FLASH

If **MODELING FLASH** is selected when a compatible shoe-mounted flash unit is attached, you can press the control to test-fire the flash and check for shadows and the like (modeling flash).

More on Photography and Playback

Mode Selection

Program AE (P)

To allow the camera to adjust both shutter speed and aperture for optimal exposure, set shutter speed and aperture to **A**. **P** will appear in the display.

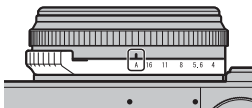

Aperture: Select **A** (auto)



Shutter speed: Select **A** (auto)



- ① If the subject is outside the metering range of the camera, the shutter speed and aperture displays will show "----".

Program Shift

If desired, you can rotate the rear command dial to select other combinations of shutter speed and aperture without altering exposure (program shift). Program shift is not available if the attached flash supports TTL auto, or if an auto option is selected for **IMAGE QUALITY SETTING > DYNAMIC RANGE** (91). To cancel program shift, turn the camera off.

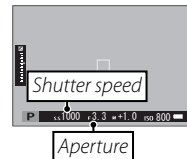

Shutter-Priority AE (S)

To adjust shutter speed manually while letting the camera select aperture for optimal exposure, set aperture to **A** and use the shutter speed dial. **S** will appear in the display.

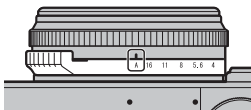

Aperture: Select **A** (auto)



Shutter speed: Choose a speed



- ◆ Shutter speed can also be adjusted in increments of $\frac{1}{3}$ EV by rotating the rear command dial. Shutter speed can be adjusted even while the shutter button is pressed halfway.
- ⓘ If the correct exposure can not be achieved at the selected shutter speed, aperture will be displayed in red when the shutter button is pressed halfway. Adjust shutter speed until the correct exposure is achieved.
- ⓘ If the subject is outside the metering range of the camera, the aperture display will show “---”.

Aperture-Priority AE (A)

To adjust aperture manually while letting the camera select shutter speed for optimal exposure, rotate the shutter speed dial to **A** and adjust aperture as desired. **A** will appear in the display.

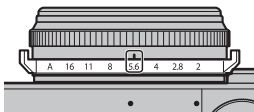

Aperture: Choose an aperture





Shutter speed: Select **A** (auto)





- ✎ Aperture can be adjusted even while the shutter button is pressed halfway.
- ⓘ If the correct exposure can not be achieved at the selected aperture, the shutter speed will be displayed in red when the shutter button is pressed halfway. Adjust aperture until the correct exposure is achieved.
- ⓘ If the subject is outside the metering range of the camera, the shutter speed display will show “---”.

Previewing Depth of Field

When **PREVIEW DEPTH OF FIELD** is assigned to a function button ( 47), pressing the button stops aperture down to the selected setting, allowing depth of field to be previewed in the display.

If both **AF DISTANCE INDICATOR** and **MF DISTANCE INDICATOR** are selected in the  **SCREEN SETTING > DISP. CUSTOM SETTING** list, depth of field can also be previewed using the depth-of-field indicator in the standard display ( 31). Press **DISP/BACK** to cycle through display modes until standard indicators are displayed.

 Use the  **AF/MF SETTING > DEPTH-OF-FIELD SCALE** option ( 97) to choose how depth of field is displayed. Choose **FILM FORMAT BASIS** to help you make practical assessments of depth of field for pictures that will be viewed as prints and the like, **PIXEL BASIS** to help you assess depth of field for pictures that will be viewed at high resolutions on computers or other electronic displays.

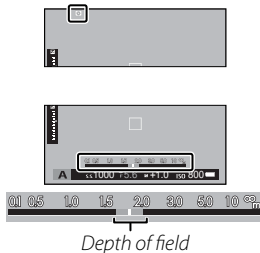

Manual Exposure (M)

Exposure can be altered from the value suggested by the camera by setting both shutter speed and aperture to values other than **A**. **M** will appear in the display.

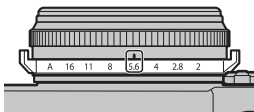

Aperture: Choose an aperture



Shutter speed: Choose a speed

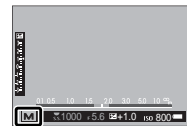

- ◆ Shutter speed can also be adjusted in increments of $\frac{1}{3}$ EV by rotating the rear command dial.
- ◆ Shutter speed and aperture can be adjusted even while the shutter button is pressed halfway.

Exposure Preview

To preview exposure in the LCD monitor, select an option other than **OFF** for **SCREEN SETTING > PREVIEW EXP./WB IN MANUAL MODE** (119). Select **OFF** when using the flash or on other occasions on which exposure may change when the picture is taken.

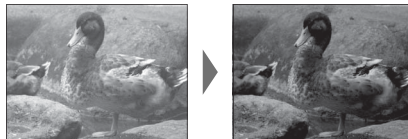

The Digital Teleconverter

Use the digital teleconverter to further magnify the image while processing it for sharp, high-resolution results.

1 Assign **DIGITAL TELE-CONV.** to the control ring (📖 8).

2 Choose the zoom angle using the control ring.

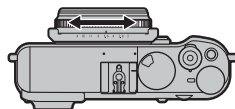

Standard (35 mm*)

* 35 mm format equivalent



50mm*



70mm*

3 Take pictures at the selected zoom angle.

- ❖ **DIGITAL TELE-CONV.** can also be accessed from the shooting menu (📖 100).
- ❖ The zoom angles available when a conversion lens is attached are 72 and 100 mm for telephoto conversion lenses (teleconverters) and 41 and 58 mm for wide-angle conversion lenses.
- ① Image quality drops slightly at **DIGITAL TELE-CONV.** settings of 50 and 70 mm.
- ① The digital teleconverter is not available when a RAW option is selected for image quality, and selecting a RAW option automatically deactivates the digital teleconverter. The digital teleconverter may be unavailable in some modes.

Drive Mode

Use the **DRIVE** (▲) button to choose the drive mode.

- 1 Press the **DRIVE** (▲) button to display drive mode options.

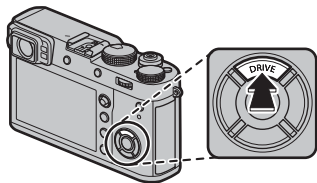

- 2 Press the selector up or down to highlight a drive mode.



Drive mode	
STILL IMAGE	—
CONTINUOUS	56
AE BKT	57
ISO BKT	
FILM SIMULATION BKT	
WHITE BALANCE BKT	
DYNAMIC RANGE BKT	
Adv. MODE	
PANORAMA	59
MULTIPLE EXPOSURE	61
ADVANCED FILTER	58
MOVIE	40

- 3 Press the selector left or right to choose a setting.

- **Burst mode (CONTINUOUS):** Choose the frame-advance rate.
- **AE/ISO/WB BKT:** Choose the bracketing increment.
- **Adv. MODE:** Choose a mode.
- **ADVANCED FILTER:** Choose a filter effect.

- 4 Press **MENU/OK**.

- 5 Take pictures.

Burst Mode (CONTINUOUS)

Capture motion in a series of pictures. The camera will take pictures while the shutter button is pressed; shooting ends when the shutter button is released, the maximum number of pictures has been taken, or the memory card is full.

- ❖ Frame rate varies with the subject, shutter speed, sensitivity, and focus mode and may slow as more shots are taken.
- ❖ Depending on shooting conditions, the frame rate may drop or the flash may not fire.
- ❖ Additional time may be required to record pictures when shooting ends.
- ❖ If file numbering reaches 999 before shooting is complete, the remaining pictures will be recorded to a new folder ( 124).
- ❖ Burst shooting may not begin if the space available on the memory card is insufficient.







Focus and Exposure

To vary focus and exposure with each shot, select focus mode **C**; in other modes, focus and exposure are determined by the first shot in each series.

- ① Selecting a frame advance rate of 8 fps in focus mode **C** restricts the choice of focus frames ( 75).
- ① Exposure and focus tracking performance may vary with aperture, sensitivity, and shooting conditions.













Bracketing

Automatically vary settings over a series of pictures.

Option	Description
 AE BKT	Select a bracketing amount. Each time the shutter button is pressed, the camera will take three shots: one using the metered value for exposure (📖 62), the second overexposed by the selected amount, and the third underexposed by the same amount (regardless of the amount selected, exposure will not exceed the limits of the exposure metering system).
 ISO BKT	Select a bracketing amount. Each time the shutter is released, the camera will take a picture at the current sensitivity (📖 63) and process it to create two additional copies, one with sensitivity raised and the other with sensitivity lowered by the selected amount (regardless of the amount selected, sensitivity will not exceed ISO 12800 or fall below ISO 200).
 FILM SIMULATION BKT	Each time the shutter is released, the camera takes one shot and processes it to create copies at the settings chosen using  SHOOTING SETTING > FILM SIMULATION BKT (📖 65, 98).
 WHITE BALANCE BKT	Select a bracketing amount. Each time the shutter button is pressed, the camera takes three shots: one at the current white balanced setting (📖 66), one with fine-tuning increased by the selected amount, and another with fine-tuning decreased by the selected amount.
 DYNAMIC RANGE BKT	Each time the shutter button is pressed, the camera takes three shots with different dynamic ranges (📖 91): 100% for the first, 200% for the second, and 400% for the third. While dynamic range bracketing is in effect, sensitivity will be restricted to a minimum of ISO 800 (or to a minimum of ISO 200 to 800 when an auto option is selected for sensitivity); the sensitivity previously in effect is restored when bracketing ends.

Advanced Filters

Take photos with filter effects.

Filter	Description
 TOY CAMERA	Choose for a retro toy camera effect.
 MINIATURE	The tops and bottoms of pictures are blurred for a diorama effect.
 POP COLOR	Create high-contrast images with saturated colors.
 HIGH-KEY	Create bright, low-contrast images.
 LOW-KEY	Create uniformly dark tones with few areas of emphasized highlights.
 DYNAMIC TONE	Dynamic tone expression is used for a fantasy effect.
 SOFT FOCUS	Create a look that is evenly soft throughout the whole image.
 PARTIAL COLOR (RED)	Areas of the image that are the selected color are recorded in that color. All other areas of the image are recorded in black-and-white.
 PARTIAL COLOR (ORANGE)	
 PARTIAL COLOR (YELLOW)	
 PARTIAL COLOR (GREEN)	
 PARTIAL COLOR (BLUE)	
 PARTIAL COLOR (PURPLE)	

- Depending on the subject and camera settings, images may in some cases be grainy or vary in brightness and hue.

Panoramas

Follow an on-screen guide to create a panorama.

- 1 Select **Adv.** >  (**PANORAMA**) for drive mode (📖 55).
- 2 To select the size of the angle through which you will pan the camera while shooting, press the selector left. Highlight a size and press **MENU/OK**.
- 3 Press the selector right to view a choice of pan directions. Highlight a pan direction and press **MENU/OK**.
- 4 Press the shutter button all the way down to start recording. There is no need to keep the shutter button pressed during recording.

- 5 Pan the camera in the direction shown by the arrow. Shooting ends automatically when the camera is panned to the end of the guides and the panorama is complete.

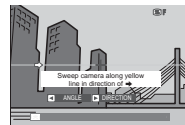

- ❖ Shooting ends if the shutter button is pressed all the way down during shooting. No panorama may be recorded if the shutter button is pressed before the panorama is complete.

For Best Results

For best results, prop your elbows against your sides and move the camera slowly in a small circle at a steady speed, keeping the camera horizontal and being careful only to pan in the direction shown by the guides. Use a tripod for best results. If the desired results are not achieved, try panning at a different speed.

- ① Panoramas are created from multiple frames; exposure for the entire panorama is determined by the first frame. The camera may in some cases record an greater or lesser angle than selected or be unable to stitch the frames together perfectly. The last part of the panorama may not be recorded if shooting ends before the panorama is complete.
- ① Shooting may be interrupted if the camera is panned too quickly or too slowly. Panning the camera in a direction other than that shown cancels shooting.
- ① The desired results may not be achieved with moving subjects, subjects close to the camera, unvarying subjects such as the sky or a field of grass, subjects that are in constant motion, such as waves and waterfalls, or subjects that undergo marked changes in brightness. Panoramas may be blurred if the subject is poorly lit.

Viewing Panoramas

In full-frame playback, you can use the rear command dial to zoom panoramas in or out. Alternatively, you can play the panorama back using the selector.





Press the selector down to start playback and press again to pause. While playback is paused, you can scroll the panorama manually by pressing the selector left or right; vertical panoramas will scroll vertically, horizontal panoramas horizontally. To exit to full-frame playback, press the selector up.

Multiple Exposures

Create a photograph that combines two exposures.



- 1 Select **Adv.** >  (**MULTIPLE EXPOSURE**) for drive mode ( 55).
- 2 Take the first shot.
- 3 Press **MENU/OK**. The first shot will be shown superimposed on the view through the lens and you will be prompted to take the second shot.



- ◆ To return to Step 2 and retake the first shot, press the selector left. To save the first shot and exit without creating a multiple exposure, press **DISP/BACK**.

- 4 Take the second shot, using the first frame as a guide.



- 5 Press **MENU/OK** to create the multiple exposure, or press the selector left to return to Step 4 and retake the second shot.



Exposure Compensation

Rotate the exposure compensation dial to adjust exposure when photographing very bright, very dark, or high-contrast subjects. The effect is visible in the display.

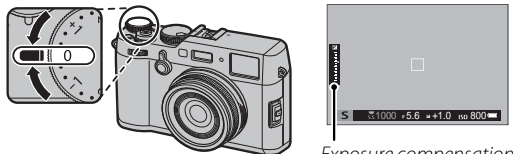

Exposure compensation indicator

Choose positive values (+) to increase exposure



Choose negative values (-) to reduce exposure



① The amount of compensation available varies with the shooting mode.

■ C (Custom)

When the exposure compensation dial is rotated to **C**, exposure compensation can be adjusted by rotating the front command dial.

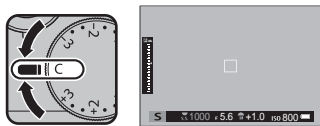

- ◆ The front command dial can be used to set exposure compensation to values between -5 and $+5$ EV.
- ◆ Press the center of the front command dial to toggle between exposure compensation and sensitivity (6).

● Choosing an Exposure Compensation Value

- **Backlit subjects:** Choose values from $+2\frac{2}{3}$ EV to $+1\frac{2}{3}$ EV.
- **Highly reflective subjects or very bright scenes** (e.g., snowfields): $+1$ EV
- **Scenes that are mostly sky:** $+1$ EV
- **Spotlit subjects** (particularly if photographed against dark backgrounds): $-2\frac{2}{3}$ EV
- **Subjects with low reflectivity** (pine trees or dark-colored foliage): $-2\frac{2}{3}$ EV



Sensitivity

“Sensitivity” refers to the camera’s sensitivity to light. Lift and rotate the shutter speed/sensitivity dial to choose from values between 200 and 12800, or select **L (100)**, **H (25600)**, or **H (51200)** for special situations (📖 121). Higher values can be used to reduce blur when lighting is poor, while lower values allow slower shutter speeds or wider apertures in bright light; note, however, that mottling may appear in pictures taken at high sensitivities, particularly at **H (51200)**, while choosing **L (100)** reduces dynamic range. Values of from ISO 200 to ISO 6400 are recommended in most situations. If **A** is selected, the camera will adjust sensitivity automatically in response to shooting conditions according to the option selected for **SHOOTING SETTING > ISO AUTO SETTING** (📖 100). Choose from **AUTO 1**, **AUTO 2**, and **AUTO 3**.

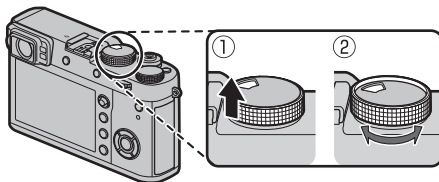



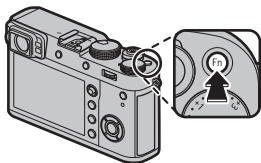

- ◆ If **COMMAND** is selected for **SHOOTING SETTING > ISO AUTO SETTING** (📖 100), sensitivity can also be adjusted by setting sensitivity to **A** and rotating the front command dial.
- ◆ Sensitivity is not reset when the camera is turned off.

Metering

Choose how the camera meters exposure. Press the function (**Fn1**) button to display the options shown below, then use the selector to highlight an option and press **MENU/OK** to select.



- ① The selected option will only take effect when **AF/MF SETTING > FACE/EYE DETECTION SETTING** is off (📖 95).

Mode	Description
 (MULTI)	The camera instantly determines exposure based on an analysis of composition, color, and brightness distribution. Recommended in most situations.
 (CENTERWEIGHTED)	The camera meters the entire frame but assigns the greatest weight to the area at the center.
 (SPOT)	The camera meters lighting conditions in an area at the center of the frame equivalent to 2% of the total. Recommended with backlit subjects and in other cases in which the background is much brighter or darker than the main subject.
 (AVERAGE)	Exposure is set to the average for the entire frame. Provides consistent exposure across multiple shots with the same lighting, and is particularly effective for landscapes and portraits of subjects dressed in black or white.

- 🔍 Metering options can also be accessed using **SHOOTING SETTING > PHOTOMETRY** (📖 98).

Film Simulation

Simulate the effects of different kinds of film, including black-and-white (with or without color filters). Press the function **(Fn3)** button to display the options shown below, then use the selector to highlight an option and press **MENU/OK** to select.

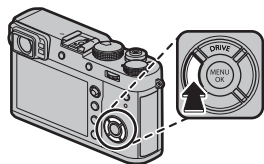

Option	Description
(PROVIA/STANDARD)	Standard color reproduction. Suited to a wide range of subjects, from portraits to landscapes.
(Velvia/VIVID)	A high-contrast palette of saturated colors, suited to nature photos.
(ASTIA/SOFT)	Enhances the range of hues available for skin tones in portraits while preserving the bright blues of day-light skies. Recommended for outdoor portrait photography.
(CLASSIC CHROME)	Soft color and enhanced shadow contrast for a calm look.
(PRO Neg. Hi)	Offers slightly more contrast than (PRO Neg. Std). Recommended for outdoor portrait photography.
(PRO Neg. Std)	A soft-toned palette. The range of hues available for skin tones is enhanced, making this a good choice for studio portrait photography.
(ACROS) *	Take black-and-white photos with rich gradation and outstanding sharpness. Available with yellow (Ye), red (R), and green (G) filters.
(MONOCHROME) *	Take pictures in standard black and white. Available with yellow (Ye), red (R), and green (G) filters.
(SEPIA)	Take pictures in sepia.

* Filters deepen shades of gray corresponding to hues complementary to the selected color. The yellow (**Ye**) filter deepens purples and blues and the red (**R**) filter blues and greens. The green (**G**) filter deepens reds and browns, including skin tones, making it a good choice for portraits.

- Film simulation options can be combined with tone and sharpness settings (📖 91, 92).
- Film simulation options can also be accessed using **IMAGE QUALITY SETTING > FILM SIMULATION** (📖 91).

White Balance

For natural colors, choose a white balance option that matches the light source. Press the function (**Fn4**) button to display the options shown below, then press the selector up or down to highlight an option and press **MENU/OK** to select.

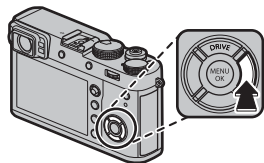

Option	Description
AUTO	White balance adjusted automatically.
1	Measure a value for white balance (📖 67).
2	
3	
K	Selecting this option displays a list of color temperatures (📖 67); highlight a temperature and press MENU/OK to select the highlighted option and display the fine-tuning dialog.

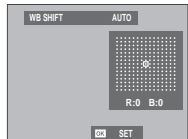

Option	Description
	For subjects in direct sunlight.
	For subjects in the shade.
	Use under “daylight” fluorescent lights.
	Use under “warm white” fluorescent lights.
	Use under “cool white” fluorescent lights.
	Use under incandescent lighting.
	Reduces the blue cast typically associated with underwater lighting.



- White balance is adjusted for flash lighting only in **AUTO** and modes. Turn the flash off using other white balance options (📖 82).
- Results vary with shooting conditions. Play pictures back after shooting to check colors.
- White balance options can also be accessed using **IMAGE QUALITY SETTING > WHITE BALANCE** (📖 91).

Custom White Balance

Choose  to adjust white balance for unusual lighting conditions. White balance measurement options will be displayed; frame a white object so that it fills the display and press the shutter button all the way down to measure white balance (to select the most recent custom value and exit without measuring white balance, press **DISP/BACK**, or press **MENU/OK** to select the most recent value and display the fine-tuning dialog).

- If **"COMPLETED!"** is displayed, press **MENU/OK** to set white balance to the measured value.
- If **"UNDER"** is displayed, raise exposure compensation ( 62) and try again.
- If **"OVER"** is displayed, lower exposure compensation ( 62) and try again.

Color Temperature

Color temperature is an objective measure of the color of a light source, expressed in Kelvin (K). Light sources with a color temperature close to that of direct sunlight appear white; light sources with a lower color temperature have a yellow or red cast, while those with a higher color temperature are tinged with blue. You can match color temperature to the light source as shown in the following table, or choose options that differ sharply from the color of the light source to make pictures "warmer" or "colder."

◀ Choose for redder light sources
or "colder" pictures

Choose for bluer light sources ▶
or "warmer" pictures

2,000 K

Candlelight

Sunset/sunrise

5,000 K

Direct sunlight

15,000 K

Blue sky

Shade

Focus Mode

Use the focus mode selector to choose how the camera focuses (note that regardless of the option selected, manual focus will be used when the lens is in manual focus mode).

- **S** (single AF): Focus locks while the shutter button is pressed halfway. Choose for stationary subjects.
- **C** (continuous AF): Focus is continually adjusted to reflect changes in the distance to the subject while the shutter button is pressed halfway. Use for subjects that are in motion. Eye-detection AF is not available.
- **M** (manual): Focus manually using the lens focus ring. Rotate the ring left to reduce the focus distance, right to increase. The manual focus indicator indicates how closely the focus distance matches the distance to the subject in the focus brackets (the white line indicates the focus distance, the blue bar the depth of field, or in other words the distance in front of and behind the focus point that appears to be in focus); you can also check focus visually in the viewfinder or LCD monitor. Choose for manual control of focus or in situations in which the camera is unable to focus using autofocus (📖 81).

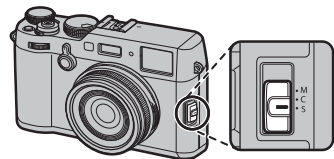

Reduce focus distance

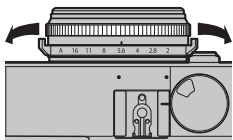

Increase focus distance



Manual focus indicator

Focus distance (white line)



- ◆ Use **📷 BUTTON/DIAL SETTING > FOCUS RING** (📖 122) to reverse the direction of rotation of the focus ring.
- ◆ To use autofocus to focus on the subject in the selected focus area (📖 72), press the **AEL/AFL** button (the size of the focus area can be chosen with the rear command dial). In manual focus mode, you can use this feature to quickly focus on a chosen subject using either single or continuous AF according to the option chosen for **📷 AF/MF SETTING > INSTANT AF SETTING** (📖 96).
- ◆ Use **📷 BUTTON/DIAL SETTING > FUNCTION (Fn) SETTING** to change the role of **AEL/AFL** button or assign its default function to other controls.

- ◆ The camera can show focus distance in meters or feet. Use **SCREEN SETTING > FOCUS SCALE UNITS** (📖 120) to choose the units used.
- ◆ If **ON** is selected for **AF/MF SETTING > PRE-AF** (📖 94), focus will be adjusted continuously in modes **S** and **C** even when the shutter button is not pressed.

■ The Focus Indicator

The focus indicator turns green when the subject is in focus and blinks white when the camera is unable to focus. Brackets (“()”) indicate that the camera is focusing and are displayed continuously in mode **C**. **MF** is displayed in manual focus mode.

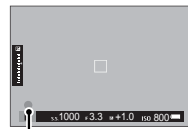

Focus indicator

● Checking Focus

To zoom in on the current focus area (📖 72) for precise focus, press the center of the rear command dial. Press the center of the rear command dial again to cancel zoom. In manual focus mode, zoom can be adjusted by rotating the rear command dial when **STANDARD** or **FOCUS PEAK HIGHLIGHT** is selected for **AF/MF SETTING > MF ASSIST** (📖 96), while if **ON** is selected for **AF/MF SETTING > FOCUS CHECK** (📖 96), the camera will automatically zoom in on the selected focus area when the focus ring is rotated. Focus zoom is not available in focus mode **C** or when **AF/MF SETTING > PRE-AF** (📖 94) is on or an option other than **SINGLE POINT** is selected for **AF MODE** (📖 71).



- ◆ Use **BUTTON/DIAL SETTING > FUNCTION (Fn) SETTING** to change the function performed by the center of the command dial or assign its default function to other controls.

MF Assist

The **AF/MF SETTING > MF ASSIST** (📖 96) option can be used to check focus when pictures are framed in the LCD monitor or electronic viewfinder in manual focus mode.

◆ The **MF ASSIST** menu can be displayed by pressing and holding the center of the rear command dial.

The following options are available:

- **FOCUS PEAK HIGHLIGHT:** Highlights high-contrast outlines. Rotate the focus ring until the subject is highlighted.
- **DIGITAL SPLIT IMAGE:** Displays a split image in the center of the frame. Frame the subject in the split-image area and rotate the focus ring until the three parts of the split image are correctly aligned.

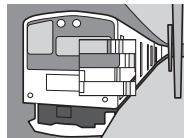

Autofocus Options (AF Mode)

To choose the AF mode for focus modes **S** and **C**, press the function button (**Fn5**) to display the options shown below, then press the selector up or down to highlight an option and press **MENU/OK** to select.

- **[] SINGLE POINT:** The camera focuses on the subject in the selected focus point (📖 73). The number of focus points available can be selected using **[AF] AF/MF SETTING > NUMBER OF THE FOCUS POINTS** (📖 94). Use for pin-point focus on a selected subject.
 - **[Z] ZONE:** The camera focuses on the subject in the selected focus zone (📖 74). Focus zones include multiple focus points (7×7, 5×5, or 3×3), making it easier to focus on subjects that are in motion.
 - **[W] WIDE/TRACKING:** In focus mode **C**, the camera tracks focus on the subject in the selected focus point while the shutter-release button is pressed halfway (📖 75). In focus mode **S**, the camera automatically focuses on high-contrast subjects; the areas in focus are shown in the display. The camera may be unable to focus on small objects or subjects that are moving rapidly.
- ◆ AF mode options can also be accessed using **[AF] AF/MF SETTING > AF MODE** (📖 94).

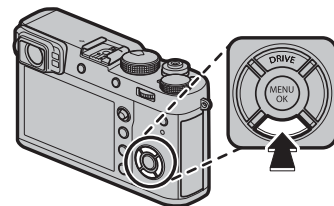

Focus-Point Selection

Use the focus stick (focus lever) to choose a focus point for autofocus. The procedure for selecting the focus point varies with the option chosen for AF mode (📖 71).

◆ Focus-area selection can also be used to choose the focus point for manual focus and focus zoom.

Tilt the focus stick to position the focus frame, or press the center of the stick to return to the center focus point.

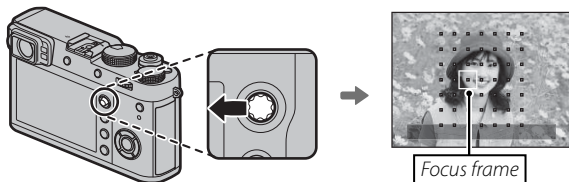
**Available Focus Points**

TTL contrast-detect AF offers more focus points than intelligent hybrid AF, which combines phase-detection with TTL contrast-detect AF.

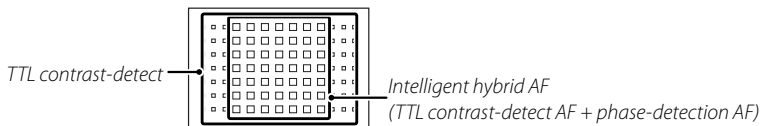

The Focus Point Display

The focus stick (focus lever) can be used to display available focus points.

◆ Focus-area selection can also be accessed using **AF/MF SETTING > FOCUS AREA** (📖 94).

■ Single Point AF

Press the center of the focus stick to display the focus points ("□") and focus frame. Use the stick to position the focus frame over the desired focus point, or press the center of the stick to return to the center point.

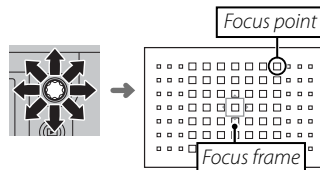

To choose the size of the focus frame, rotate the rear command dial. Rotate the dial left to reduce the frame by up to 50%, right to enlarge it by up to 150%, or press the center of the dial to restore the frame to its original size. Press **MENU/OK** to put your selection into effect.

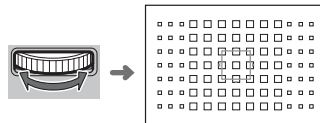

■ Zone AF

Press the center of the focus stick to display the focus zone. Use the stick to position the zone or press the center of the stick to return the zone to the center of the display.

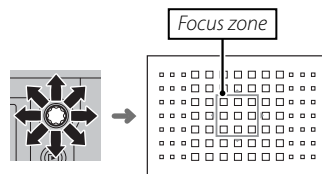

To choose the number of focus frames in the zone, rotate the rear command dial. Rotate the dial right to cycle through zone sizes in the order 3×3 , 5×5 , 7×7 , $3 \times 3 \dots$, left to cycle through zone sizes in reverse order, or press the center of the dial to select a zone size of 3×3 . Press **MENU/OK** to put your selection into effect.



Tracking (Focus Mode C Only)

Press the center of the focus stick to display the focus frame. Use the stick to position the focus frame, or press the center of the stick to return the frame to the center of the display. Press **MENU/OK** to put your selection into effect. The camera will track focus on the subject while the shutter button is pressed halfway.

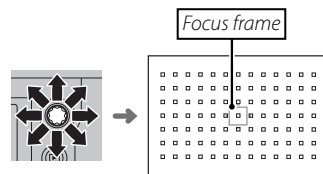

① Manual focus-frame selection is not available when wide/tracking is selected in focus mode **S**.

Burst Mode Focus-Frame Selection

When a frame rate of 8 fps is selected for drive mode, the number of focus frames available in focus mode **C** drops.

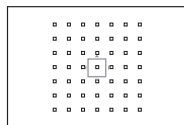

Single point

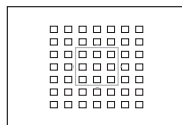

Zone

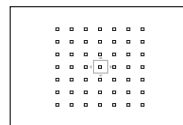

Wide/Tracking

Long Time-Exposures (T/B)

Select a shutter speed of **T** (time) or **B** (bulb) for long time-exposures.

- Use of a tripod is recommended to prevent the camera from moving during the exposure.
- To reduce “noise” (mottling) in long time-exposures, select **ON** for **IMAGE QUALITY SETTING > LONG EXPOSURE NR** (📖 92). Note that this may increase the time needed to record images after shooting.

Time (T)

1 Rotate the shutter speed dial to **T**.



2 Rotate the rear command dial to choose a shutter speed.

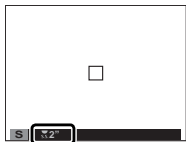

3 Press the shutter button all the way down to take a picture at the selected shutter speed. A count-down timer will be displayed while the exposure is in progress.



Bulb (B)

1 Rotate the shutter speed dial to **B**.



2 Press the shutter button all the way down. The shutter will remain open for up to 60 minutes while the shutter button is pressed; the display shows the time elapsed since the exposure started.



- Selecting an aperture of **A** fixes shutter speed at 30s.

Using a Remote Release

An optional RR-90 remote release can be used for long time-exposures. See the manual provided with the RR-90 for more information.

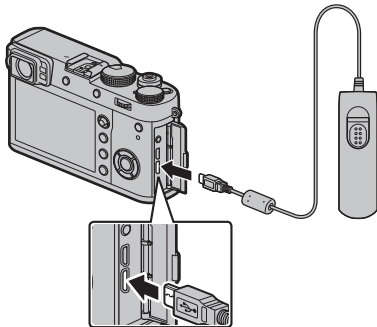

Third-Party Remote Releases

Electronic releases from third-party suppliers can be connected via the microphone/remoterelease connector. A confirmation dialog will be displayed when a third-party release is connected; press **MENU/OK** and select **REMOTE** for **MIC/RE-MOTE RELEASE**.

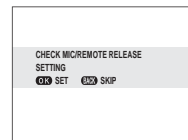
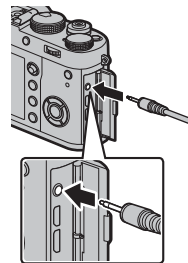

The Self-Timer

Use the timer for self-portraits or to prevent blur caused by camera shake.

- 1 Press **MENU/OK** in shooting mode to display the shooting menu.

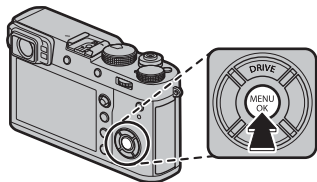

- 2 Select the **SHOOTING SETTING** tab (89), then highlight **SELF-TIMER** and press **MENU/OK**.

- 3 Press the selector up or down to highlight the desired option and press **MENU/OK** to select.

Option	Description
2 SEC	The shutter is released two seconds after the shutter button is pressed. Use to reduce blur caused by the camera moving when the shutter button is pressed.
10 SEC	The shutter is released ten seconds after the shutter button is pressed. Use for photographs in which you wish to appear yourself.
OFF	Self-timer off.

- 4 Press the shutter button halfway to focus.

① Stand behind the camera when using the shutter button. Standing in front of the lens can interfere with focus and exposure.

- 5 Press the shutter button the rest of the way down to start the timer. The display in the monitor shows the number of seconds remaining until the shutter is released. To stop the timer before the picture is taken, press **DISP/BACK**.

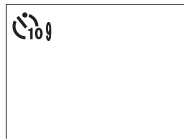

The self-timer lamp on the front of the camera will blink immediately before the picture is taken. If the two-second timer is selected, the self-timer lamp will blink as the timer counts down.

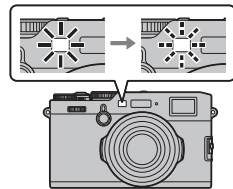

- ◆ The self-timer turns off automatically when the camera is turned off.

Interval Timer Photography

Follow the steps below to configure the camera to take photos automatically at a preset interval.

- 1 Press **MENU/OK** in shooting mode to display the shooting menu. Select the **SHOOTING SETTING** tab (89), then highlight **INTERVAL TIMER SHOOTING** and press **MENU/OK**.

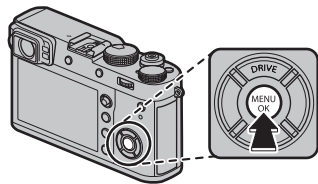

- 2 Use the selector to choose the interval and number of shots. Press **MENU/OK** to proceed.

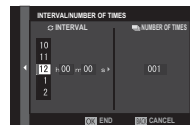

- 3 Use the selector to choose the starting time and then press **MENU/OK**. Shooting will start automatically.

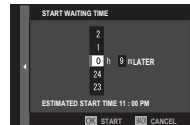

- ① Interval timer photography can not be used at a shutter speed of **B** (bulb) or with multiple exposure photography. In burst mode, only one picture will be taken each time the shutter is released.
- 🔧 Use of a tripod is recommended.
- 🔧 Check the battery level before starting. We recommend using an optional AC-9V AC power adapter and CP-W126 DC coupler.
- 🔧 The display turns off between shots and lights a few seconds before the next shot is taken. The display can be activated at any time by pressing the shutter button.

Focus/Exposure Lock

To compose photographs with off-center subjects:

- 1 Focus:** Position the subject in the focus frame and press the shutter button halfway to lock focus and exposure. Focus and exposure will remain locked while the shutter button is pressed halfway (AF/AE lock).



- ◆ **AEL/AFL** button. The role played by the **AEL/AFL** button can be chosen using **FUNCTION (Fn) SETTING** (☞ 47): choose from **AE LOCK ONLY** (pressing the **AEL/AFL** locks exposure but not focus), **AF LOCK ONLY** (pressing the **AEL/AFL** locks focus but not exposure), and **AE/AF LOCK** (pressing the **AEL/AFL** locks both focus and exposure).

- 2 Recompose:** Keep the shutter button pressed halfway or keep the **AEL/AFL** button pressed.



- ◆ Focus and/or exposure will remain locked while the **AEL/AFL** button is pressed, whether or not the shutter button is pressed halfway. If **AE&AF ON/OFF SWITCH** is selected for **FUNCTION (Fn) SETTING > AE/AF-LOCK MODE** (☞ 122), focus and/or exposure lock when the button is pressed and remain locked until the button is pressed again.

- 3 Shoot:** Press the button all the way down.



 **Autofocus**

Although the camera boasts a high-precision autofocus system, it may be unable to focus on the subjects listed below.

- Very shiny subjects such as mirrors or car bodies.
- Subjects photographed through a window or other reflective object.
- Dark subjects and subjects that absorb rather than reflect light, such as hair or fur.
- Insubstantial subjects, such as smoke or flame.
- Subjects that show little contrast with the background.
- Subjects positioned in front of or behind a high-contrast object that is also in the focus frame (for example, a subject photographed against a backdrop of highly contrasting elements).

Flash Photography

Use the built-in flash for additional lighting when shooting at night or indoors under low light.

- 1 Select **FLASH SETTING** in the shooting menu and, after confirming that **ON** is selected for **Built-In Flash**, select **FLASH FUNCTION SETTING** to display flash options.

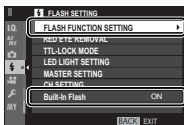

- 1 Choosing **OFF** for **Built-In Flash** disables the built-in flash.

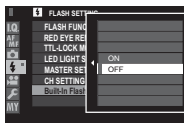

- 2 Highlight items using the selector and rotate the rear command dial to change the highlighted setting.



- 3 Press **DISP/BACK** to put the changes into effect.

- 1 The flash will not fire at some settings, for example in panorama mode or when the electronic shutter is used.
 - 1 Choose shutter speeds slower than $\frac{1}{2,000}$ when using the flash in exposure mode **S** (shutter-priority AE) or manual (**M**).

- ❖ The flash will not fire if **OFF** is selected for **SOUND & FLASH** in the **USER SETTING** menu.
- ❖ In TTL mode, the flash may fire several times with each shot. Do not move the camera until shooting is complete.
- ❖ Optional lens hoods are not recommended for use with the built-in flash as they may cast shadows that cause vignetting.

Red-Eye Removal

Red-eye removal is available when an option other than **OFF** is selected for **FLASH SETTING > RED EYE REMOVAL** and **AF/MF SETTING > FACE/EYE DETECTION SETTING** is **ON**. Red-eye removal minimizes “red-eye” caused when light from the flash is reflected from the subject’s retinas.

Flash Sync Speed

The flash will synchronize with the shutter at shutter speeds of $\frac{1}{2,000}$ s or slower.

Optional Flash Units

The camera can be used with optional FUJIFILM shoe-mounted flash units (141). Do not use third-party flash units that apply over 300V to the camera hot shoe.

FLASH FUNCTION SETTING

The following options are available with the built-in flash:

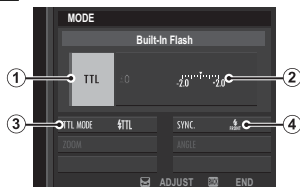

① **Flash control mode:** Choose from the options below.

- **TTL (TTL):** TTL mode. Adjust flash compensation (②) and choose a flash mode (③).
- **M (M):** The flash fires at the selected output (②) regardless of subject brightness or camera settings. Output is expressed in fractions of full power, from $\frac{1}{2}$ to $\frac{1}{64}$. The desired results may not be achieved at low values if they exceed the limits of the flash control system; take a test shot and check the results.
- **COMMANDER:** Choose if the flash is being used to control remote synced flash units, for example as part of a studio flash system.
- **OFF (OFF):** The flash does not fire.

② **Flash compensation/output:** Adjust flash level. The options available vary with the flash control mode (①).

③ **Flash mode (TTL):** Choose a flash mode for TTL flash control. The options available vary with the shooting mode (**P**, **S**, **A**, or **M**) selected.

- **FLASH AUTO:** The flash fires only as required; flash level is adjusted according to subject brightness. A **FLASH** icon displayed when the shutter button is pressed halfway indicates that the flash will fire when the photo is taken.
- **STANDARD:** The flash fires with every shot if possible; flash level is adjusted according to subject brightness. The flash will not fire if not fully charged when the shutter is released.
- **SLOW SYNC.:** Combine the flash with slow shutter speeds when photographing portrait subjects against a backdrop of night scenery. The flash will not fire if not fully charged when the shutter is released.

④ **Sync:** Choose whether the flash is timed to fire immediately after the shutter opens (**FRONT/1ST CURTAIN**) or immediately before it closes (**REAR/2ND CURTAIN**). **1ST CURTAIN** is recommended in most circumstances.

Recording Pictures in RAW Format

To record raw, unprocessed data from the camera image sensor, select a **RAW** option for image quality in the shooting menu as described below. JPEG copies of RAW images can be created using **PLAY BACK MENU > RAW CONVERSION**, or RAW images can be viewed on a computer using the RAW FILE CONVERTER EX 2.0 application (📖 85, 132).

- 1 Press **MENU/OK** in shooting mode to display the shooting menu. Select the **IMAGE QUALITY SETTING** tab (📖 89), then highlight **IMAGE QUALITY** (📖 90) and press **MENU/OK**.
- 2 Highlight an option and press **MENU/OK**. Select **RAW** to record only RAW images, or **FINE+RAW** or **NORMAL+RAW** to record both JPEG copy together with the RAW images. **FINE+RAW** uses lower JPEG compression ratios for higher-quality JPEG images, while **NORMAL+RAW** uses higher JPEG compression ratios to increase the number of images that can be stored.

The Function Buttons

To toggle RAW image quality on or off for a single shot, assign **RAW** to a function button (📖 47). If a JPEG option is currently selected for image quality, pressing the button temporarily selects the equivalent JPEG+RAW option. If a JPEG+RAW option is currently selected, pressing the button temporarily selects the equivalent JPEG option, while if **RAW** is selected, pressing the button temporarily selects **FINE**. Taking a picture or pressing the button again restores the previous setting.

Creating JPEG Copies of RAW Pictures

RAW pictures store information on camera settings separately from the data captured by the camera image sensor. Using **PLAY BACK MENU > RAW CONVERSION** (📖 109), you can create JPEG copies of RAW pictures using different options for the settings listed below. The original image data are unaffected, allowing a single RAW image to be processed in a multitude of different ways.

- Press **MENU/OK** during playback to display the playback menu, then press the selector up or down to highlight **PLAY BACK MENU > RAW CONVERSION** (📖 108) and press **MENU/OK** to display the settings listed in the table at right.

❖ These options can also be displayed by pressing **Q** button during playback.

- Press the selector up or down to highlight a setting and press the selector right to select. Press the selector up or down to highlight the desired option and press **MENU/OK** to select and return to the settings list. Repeat this step to adjust additional settings.

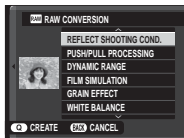

Setting	Description
REFLECT SHOOTING COND.	Create a JPEG copy using the settings in effect at the time the photo was taken.
PUSH/PULL PROCESSING	Adjust exposure by -1 EV to +3 EV in increments of ½ EV.
DYNAMIC RANGE	Enhance details in highlights for natural contrast (📖 91).
FILM SIMULATION	Simulate the effects of different types of film (📖 65).
GRAIN EFFECT	Add a film grain effect (📖 91).
WHITE BALANCE	Adjust white balance (📖 66).
WB SHIFT	Fine-tune white balance (📖 66).
HIGHLIGHT TONE	Adjust highlights (📖 91).
SHADOW TONE	Adjust shadows (📖 91).
COLOR	Adjust color density (📖 92).
SHARPNESS	Sharpen or soften outlines (📖 92).
NOISE REDUCTION	Process the copy to reduce mottling (📖 92).
COLOR SPACE	Choose the color space used for color reproduction (📖 92).

- Press the **Q** button to preview the JPEG copy and press **MENU/OK** to save.

Saving Settings

Save up to 7 sets of custom camera settings for commonly-encountered situations. Saved settings can be recalled using **IMAGE QUALITY SETTING > SELECT CUSTOM SETTING** (89).

- 1 Press **MENU/OK** in shooting mode to display the shooting menu. Select the **IMAGE QUALITY SETTING** tab (89), then highlight **EDIT/SAVE CUSTOM SETTING** (93) and press **MENU/OK**.

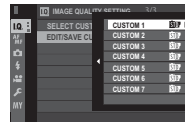

- 2 Highlight a custom settings bank and press **MENU/OK** to select. Adjust the following as desired and press **DISP/BACK** when adjustments are complete: **DYNAMIC RANGE**, **FILM SIMULATION**, **GRAIN EFFECT**, **WHITE BALANCE**, **HIGHLIGHT TONE**, **SHADOW TONE**, **COLOR**, **SHARPNESS**, and **NOISE REDUCTION**.

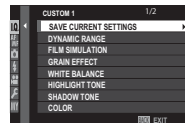

- ◆ To replace the settings in the selected bank with the settings currently selected with the camera, select **SAVE CURRENT SETTINGS** and press **MENU/OK**.

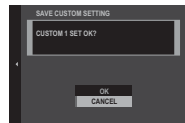

- 3 A confirmation dialog will be displayed; highlight **OK** and press **MENU/OK**.



PhotoBook Assist

Create books from your favorite photos.

Creating a PhotoBook

- 1 Select **NEW BOOK** for  **PLAY BACK MENU > PHOTOBOOK ASSIST** ( 108).
- 2 Scroll through the images and press the selector up to select or deselect. To display the current image on the cover, press the selector down. Press **MENU/OK** to exit when the book is complete.
 - ◆ Neither photographs  640 or smaller nor movies can be selected for photobooks.
 - ◆ The first picture selected becomes the cover image. Press the selector down to select a different image for the cover.
- 3 Highlight **COMPLETE PHOTOBOOK** and press **MENU/OK** (to select all photos or all photos matching the specified search conditions for the book, choose **SELECT ALL**). The new book will be added to the list in the photobook assist menu.
 - ⓘ Books can contain up to 300 pictures.
 - ⓘ Books that contain no photos are automatically deleted.

Viewing Photobooks

Highlight a book in the photobook assist menu and press **MENU/OK** to display the book, then press the selector left or right to scroll through the pictures.

Editing and Deleting Photobooks

Display the photobook and press **MENU/OK**. The following options will be displayed; select the desired option and follow the on-screen instructions.

- **EDIT:** Edit the book as described in “Creating a PhotoBook” (📖 87).
- **ERASE:** Delete the book.

Photobooks

Photobooks can be copied to a computer using MyFinePix Studio software (📖 132).

Using the Menus: Shooting Mode

The shooting menu is used to adjust settings for a wide range of shooting conditions. Frequently-used options can be saved to a personalized custom menu (“my menu”).

Using the Shooting Menu

- 1 Press **MENU/OK** in shooting mode to display the menus.

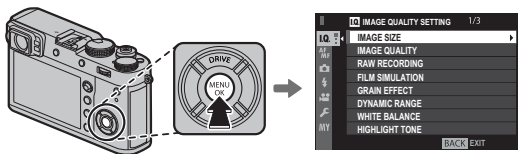

- 2 Press the selector left to highlight the tab for the current menu.

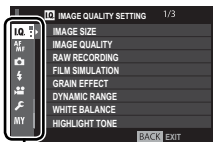

Tab

- 3 Press the selector down to highlight the tab (**IQ**, **AF/MT**, **Q**, **f**, **+**, or **MY**) containing the desired item.



- 4 Press the selector right to place the cursor in the menu.



- 5 Press the selector up or down to highlight the desired item.



- 6 Press the selector right to view options for the highlighted item.



- 7 Press the selector up or down to highlight the desired option.



- 8 Press **MENU/OK** to select the highlighted option.



- 9 Press **DISP/BACK** to return to the shooting display.



- Use the front command dial to select menu tabs or page through menus and the rear command dial to highlight menu items.

IMAGE QUALITY SETTING

To adjust shooting settings that affect image quality, press **MENU/OK** in the shooting display and select the **IMAGE QUALITY SETTING** tab (89).

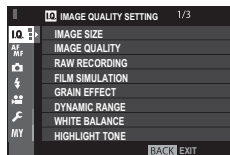
**IMAGE SIZE**

Choose the size and aspect ratio at which still pictures are recorded.

Aspect Ratio

Pictures with an aspect ratio of 3:2 have the same proportions as a frame of 35 mm film, while an aspect ratio of 16:9 is suited to display on High Definition (HD) devices. Pictures with an aspect ratio of 1:1 are square.

Option	Image size
L 3:2	6000 × 4000
L 16:9	6000 × 3376
L 1:1	4000 × 4000
M 3:2	4240 × 2832
M 16:9	4240 × 2384
M 1:1	2832 × 2832

Option	Image size
S 3:2	3008 × 2000
S 16:9	3008 × 1688
S 1:1	2000 × 2000

IMAGE SIZE is not reset when the camera is turned off or another shooting mode is selected.

IMAGE QUALITY

Choose a file format and compression ratio. Select **FINE** or **NORMAL** to record JPEG images, **RAW** to record RAW images, or **FINE+RAW** or **NORMAL+RAW** to record both JPEG and RAW images. **FINE** and **FINE+RAW** use lower JPEG compression ratios for higher-quality JPEG images, while **NORMAL** and **NORMAL+RAW** use higher JPEG compression ratios to increase the number of images that can be stored.

RAW RECORDING

Choose whether to compress RAW images.

Option	Description
UNCOMPRESSED	RAW images are not compressed.
LOSSLESS COMPRESSED	RAW images are compressed using a reversible algorithm that reduces file size with no loss of image data. The images can be viewed in RAW FILE CONVERTER EX 2.0 or other software that supports "lossless" RAW compression (132).

FILM SIMULATION

Simulate the effects of different types of film (📖 65).

GRAIN EFFECT

Add a film grain effect.

Options: STRONG/WEAK/OFF

DYNAMIC RANGE

Control contrast. Choose lower values to increase contrast when shooting indoors or under overcast skies, higher values to reduce loss of detail in highlights and shadows when photographing high-contrast scenes. Higher values are recommended for scenes that include both sunlight and deep shade, for such high-contrast subjects as sunlight on water, brightly-lit autumn leaves, and portraits taken against a blue sky, and for white objects or people wearing white; note, however, that mottling may appear in pictures taken at higher values.

- ◆ If **AUTO** is selected, the camera will automatically choose either **100 100%** or **200 200%** according to the subject and shooting conditions. Shutter speed and aperture will be displayed when the shutter button is pressed halfway.
- ◆ **200 200%** is available at sensitivities of ISO 400 and above, **400 400%** at sensitivities of ISO 800 and above.

WHITE BALANCE

Adjust colors to match the light source (📖 66).

HIGHLIGHT TONE

Adjust the appearance of highlights.

Options: +4/+3/+2/+1/0/-1/-2

SHADOW TONE

Adjust the appearance of shadows.

Options: +4/+3/+2/+1/0/-1/-2

COLOR

Adjust color density.

Options: +4/+3/+2/+1/0/-1/-2/-3/-4

SHARPNESS

Sharpen or soften outlines.

Options: +4/+3/+2/+1/0/-1/-2/-3/-4

NOISE REDUCTION

Reduce noise in pictures taken at high sensitivities.

Options: +4/+3/+2/+1/0/-1/-2/-3/-4

LONG EXPOSURE NR

Select **ON** to reduce mottling in long time-exposures (🗨 76).

Options: ON/OFF

COLOR SPACE

Choose the gamut of colors available for color reproduction.

Option	Description
sRGB	Recommended in most situations.
Adobe RGB	For commercial printing.

PIXEL MAPPING

Use this option if you notice bright spots in your pictures.

1 Press **MENU/OK** in the shooting display and select the **IMAGE QUALITY SETTING** tab (☰ 89).

2 Highlight **PIXEL MAPPING** and press **MENU/OK** to perform pixel mapping.

- ⓘ Results are not guaranteed.
- ⓘ Be sure the battery is fully charged before beginning pixel mapping.
- ⓘ Pixel mapping is not available when the camera temperature is elevated.
- ⓘ Processing may take a few seconds.

SELECT CUSTOM SETTING

Recall settings saved with **EDIT/SAVE CUSTOM SETTING**.

Options: CUSTOM 1/CUSTOM 2/CUSTOM 3/CUSTOM 4/CUSTOM 5/CUSTOM 6/CUSTOM 7

EDIT/SAVE CUSTOM SETTING

Save settings (☰ 86).

AF/MF **AF/MF SETTING**

To adjust focus settings, press **MENU/OK** in the shooting display and select the **AF/MF** (**AF/MF SETTING**) tab (89). The options available vary with the shooting mode.

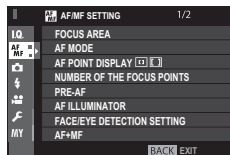
**FOCUS AREA**

Choose the focus area (73). Focus-area selection can also be used to choose the focus point for manual focus and focus zoom.

AF MODE

Choose the AF mode for focus modes **S** and **C** (71).

AF POINT DISPLAY (grid icon)

Choose whether individual focus frames are displayed when **ZONE** or **WIDE/TRACKING** is selected for **AF MODE**.

Options: ON/OFF

NUMBER OF THE FOCUS POINTS

Choose the number of focus points available for focus-point selection in manual focus mode or when **SINGLE POINT** is selected for **AF MODE**.

Option	Description
91 POINTS (7 × 13)	Choose from 91 focus points arranged in a 7- by 13-point grid.
325 POINTS (13 × 25)	Choose from 325 focus points arranged in a 13- by 25-point grid.

PRE-AF

If **ON** is selected, the camera will continue to adjust focus even when the shutter button is not pressed halfway for improved shutter response. Note that this increases the drain on the battery.

Options: ON/OFF

AF ILLUMINATOR

If **ON** is selected, the AF-assist illuminator will light to assist autofocus.

- ① The camera may be unable to focus using the AF-assist illuminator in some cases. If the camera is unable to focus in macro mode, try increasing the distance to the subject.
- ① Avoid shining the AF-assist illuminator directly into your subject's eyes.

Options: ON/OFF

FACE/EYE DETECTION SETTING

Intelligent Face Detection sets focus and exposure for human faces anywhere in the frame, preventing the camera from focusing on the background in group portraits. Choose for shots that emphasize portrait subjects. Faces can be detected with the camera in vertical or horizontal orientation; if a face is detected, it will be indicated by a green border. If there is more than one face in the frame, the camera will select the face closest to the center; other faces are indicated by white borders. You can also choose whether the camera detects and focuses on eyes when Intelligent Face Detection is on. Choose from the following options:



Option	Description
FACE ON/EYE OFF	Intelligent Face Detection only.
FACE ON/EYE AUTO	The camera automatically chooses which eye to focus on when a face is detected.
FACE ON/RIGHT EYE PRIORITY	The camera focuses on the right eye of subjects detected using Intelligent Face Detection.
FACE ON/LEFT EYE PRIORITY	The camera focuses on the left eye of subjects detected using Intelligent Face Detection.
FACE OFF/EYE OFF	Intelligent Face Detection and eye priority off.

- ⚠ If the camera is unable to detect the subject's eyes because they are hidden by hair, glasses, or other objects, the camera will instead focus on faces.
- ① In some modes, the camera may set exposure for the frame as a whole rather than the portrait subject.
- ① If the subject moves as the shutter button is pressed, the face may not be in the area indicated by the green border when the picture is taken.

AF+MF

If **ON** is selected in focus mode **S**, focus can be adjusted manually by rotating the focus ring while focus is locked. Both standard and focus peaking MF assist options are supported.

 **AF + MF Focus Zoom**

When **ON** is selected for  **AF/MF SETTING** > **FOCUS CHECK** and **SINGLE POINT** selected for **AF MODE**, focus zoom can be used to zoom in on the selected focus area. The zoom ratio (2.5x or 6x) can be selected using the rear command dial.

Options: ON/OFF

MF ASSIST

Choose how focus is displayed in manual focus mode ( 70).



Option	Description
STANDARD	Focus is displayed normally (focus peaking and digital split image are not available).
DIGITAL SPLIT IMAGE	A black-and-white (MONOCHROME) or color (COLOR) split-image display.
FOCUS PEAK HIGHLIGHT	The camera heightens high-contrast outlines. Choose a color and peaking level.

FOCUS CHECK

If **ON** is selected, the camera will automatically zoom in on the view through the lens when the focus ring is rotated in manual focus mode ( 69).

Options: ON/OFF

INTERLOCK SPOT AE & FOCUS AREA

Select **ON** to meter the current focus frame when **SINGLE POINT** is selected for **AF MODE** ( 71) and **SPOT** is selected for **PHOTOMETRY** ( 64).

Options: ON/OFF

INSTANT AF SETTING

Choose how the camera focuses when the **AEL/AFL** button is pressed in manual focus mode ( 68).

Option	Description
AF-S	The camera focuses when the button is pressed (single AF).
AF-C	The camera focuses continuously while the button is pressed (continuous AF).

DEPTH-OF-FIELD SCALE

Choose **FILM FORMAT BASIS** to help you make practical assessments of depth of field for pictures that will be viewed as prints and the like, **PIXEL BASIS** to help you assess depth of field for pictures that will be viewed at high resolutions on computers or other electronic displays.

RELEASE/FOCUS PRIORITY

Choose how the camera focuses in focus mode **AF-S** or **AF-C**.



Option	Description
RELEASE	Shutter response is prioritized over focus. Pictures can be taken when the camera is not in focus.
FOCUS	Focus is prioritized over shutter response. Pictures can be only taken when the camera is in focus.

CORRECTED AF FRAME

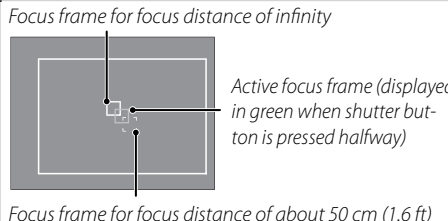
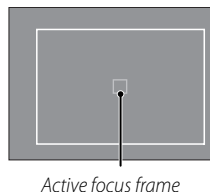
If **ON** is selected, a second focus frame for focus distances of about 50 cm (1.6 ft) will be added to the display in the optical viewfinder. The active focus frame is displayed in green when the shutter button is pressed halfway.

	ON	OFF
Focus frame	<p><i>Focus frame for focus distance of infinity</i></p>  <p><i>Active focus frame (displayed in green when shutter button is pressed halfway)</i></p> <p><i>Focus frame for focus distance of about 50 cm (1.6 ft)</i></p>	 <p><i>Active focus frame (displayed in green when shutter button is pressed halfway)</i></p>

SHOOTING SETTING

To adjust shooting options, press **MENU/OK** in the shooting display and select the  (**SHOOTING SETTING**) tab ( 89). The options available vary with the shooting mode.

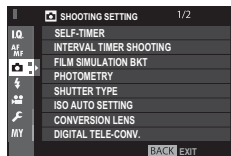

SELF-TIMER

Take pictures with the self-timer ( 78).

INTERVAL TIMER SHOOTING

Adjust settings for interval timer photography ( 79).

FILM SIMULATION BKT

Choose film types for film simulation bracketing ( 57, 65).

PHOTOMETRY

Choose how the camera meters exposure ( 64).

SHUTTER TYPE

Choose the shutter type. Choose the electronic shutter to mute the shutter sound.

Option	Description
MS MECHANICAL SHUTTER	Take pictures with the mechanical shutter.
ES ELECTRONIC SHUTTER	Take pictures with the electronic shutter.
MS MECHANICAL + ES ELECTRONIC	The camera chooses the shutter type according to shooting conditions.

- ◆ If an option other than **MS MECHANICAL SHUTTER** is selected, shutter speeds faster than $\frac{1}{4,000}$ s can be chosen by rotating the shutter speed dial to **4000** and then rotating the rear command dial.
- ◆ When the electronic shutter is used, the flash is disabled, shutter speed and sensitivity are restricted to values of $\frac{1}{32,000}$ –30 s and ISO 12800–200 respectively, and long exposure noise reduction has no effect. In burst mode, focus and exposure are fixed at the values for the first shot in each burst.
- ① Distortion may be visible in shots of moving subjects with electronic shutter, while banding and fog may occur in shots taken under fluorescent lights or other flickering or erratic illumination. When taking pictures with the shutter muted, respect your subjects' image rights and right to privacy.

ISO AUTO SETTING

Choose the base sensitivity, maximum sensitivity, and minimum shutter speed for auto ISO sensitivity control, which is activated by choosing **AUTO** for **☑** **BUTTON/DIAL SETTING > ISO DIAL SETTING (A)**. Settings for **AUTO1**, **AUTO2**, and **AUTO3** can be adjusted separately.

	Default		
	AUTO1	AUTO2	AUTO3
DEFAULT SENSITIVITY		200	
MAX. SENSITIVITY	800	1600	3200
MIN. SHUTTER SPEED		$\frac{1}{60}$	

The camera automatically chooses a sensitivity between the default and maximum values. Sensitivity is only raised above the default value if the shutter speed required for optimal exposure would be slower than the value selected for **MIN. SHUTTER SPEED**.

- ◆ If the value selected for **DEFAULT SENSITIVITY** is higher than that selected for **MAX. SENSITIVITY**, **DEFAULT SENSITIVITY** will be set to the value selected for **MAX. SENSITIVITY**.
- ◆ The camera may select shutter speeds slower than **MIN. SHUTTER SPEED** if pictures would still be underexposed at the value selected for **MAX. SENSITIVITY**.

CONVERSION LENS

Adjust settings for optional conversion lenses.

Option	Description
WIDE	Choose when using an optional WCL-X100 conversion lens.
TELE	Choose when using an optional TCL-X100 conversion lens.
OFF	Choose when no conversion lens is attached.

DIGITAL TELE-CONV.

Take pictures at different focal lengths using the digital teleconverter (📖 54).

ND FILTER

Selecting **ON** enables the camera's built-in Neutral Density (ND) filter, reducing exposure by the equivalent of 3 EV. This allows slower shutter speeds or wider apertures to be used with brightly lit subjects, making it possible to blur motion or soften background details without risk of overexposure.

Options: ON/OFF

WIRELESS COMMUNICATION

Connect to a smartphone or tablet over a wireless network (📶 131).

◆ For more information, visit <http://fujifilm-dsc.com/wifi/>.

FLASH SETTING

To adjust flash-related settings, press **MENU/OK** in the shooting display and select the **FLASH SETTING** tab (89). The options available vary with the shooting mode.

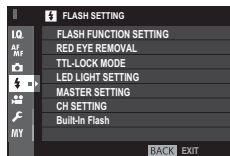
**FLASH FUNCTION SETTING**

Choose a flash control mode, flash mode, or sync mode or adjust the flash level.

◆ The options available vary with the flash unit. See “Using Shoe-Mounted Flash Units” (144) for more information.

RED EYE REMOVAL

Remove red-eye effects caused by the flash.

Option	Description
FLASH + REMOVAL	A red-eye reduction pre-flash is combined with digital red-eye removal.
FLASH	Flash red-eye reduction only.
REMOVAL	Digital red-eye removal only.
OFF	Flash red-eye reduction and digital red-eye removal off.

◆ Flash red-eye reduction can be used in TTL flash control mode. Digital red-eye removal is performed only when a face is detected and is not available with RAW images.

TTL-LOCK MODE

Instead of adjusting flash level with each shot, TTL flash control can be locked for consistent results across a series of photographs.

Option	Description
LOCK WITH LAST FLASH	Flash output is locked at the value metered for the most recent photo. An error message will be displayed if no previously metered value exists.
LOCK WITH METERING FLASH	The camera emits a series of pre-flashes and locks flash output at the metered value.

- ◆ To use TTL lock, assign **TTL-LOCK** to a camera control and then use the control to enable or disable TTL lock.
- ◆ Flash compensation can be adjusted while TTL lock is in effect.

LED LIGHT SETTING

Choose whether to use the flash unit's LED video light (if available) as a catchlight or AF-assist illuminator when taking photos.

Option	Role of LED video light in still photography
CATCHLIGHT	Catchlight
AF ASSIST	AF-assist illuminator
AF ASSIST + CATCHLIGHT	AF-assist illuminator and catchlight
OFF	None

- ◆ This option can also be accessed via the flash settings menu.

MASTER SETTING

Choose a flash group (A, B, or C) for the flash mounted on the camera hot shoe when it functions as a master flash controlling remote flash units via FUJIFILM wireless optical flash control, or choose **OFF** to limit master flash output to a level that does not affect the final picture.

◆ This option can also be accessed via the flash settings menu.

Options: Gr A/Gr B/Gr C/OFF

CH SETTING

Choose the channel used for communication between the master flash and remote flash units when using FUJIFILM optical wireless flash control. Separate channels can be used for different flash systems or to prevent interference when multiple systems are operating in close proximity.

Options: CH1/CH2/CH3/CH4

Built-In Flash

Choose from **ON** (built-in flash enabled) and **OFF** (built-in flash disabled). Choose **OFF** to disable the built-in flash when using optional shoe-mounted flash units or flash units connected to the hot shoe via a sync cable.

MOVIE SETTING

To adjust options for movie recording, press **MENU/OK** in the shooting display and select the **MOVIE SETTING** tab (89). The options available vary with the shooting mode.

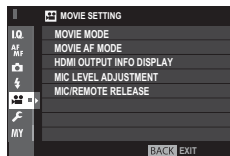
**MOVIE MODE**

Select a frame size and rate for movie recording.

- **HD 1080/59.94 P**: 1920×1080 (59.94 fps)
- **HD 1080/50 P**: 1920×1080 (50 fps)
- **HD 1080/29.97 P**: 1920×1080 (29.97 fps)
- **HD 1080/25 P**: 1920×1080 (25 fps)
- **HD 1080/24 P**: 1920×1080 (24 fps)
- **HD 1080/23.98 P**: 1920×1080 (23.98 fps)
- **HD 720/59.94 P**: 1280×720 (59.94 fps)
- **HD 720/50 P**: 1280×720 (50 fps)
- **HD 720/29.97 P**: 1280×720 (29.97 fps)
- **HD 720/25 P**: 1280×720 (25 fps)
- **HD 720/24 P**: 1280×720 (24 fps)
- **HD 720/23.98 P**: 1280×720 (23.98 fps)

MOVIE AF MODE

Choose how the camera selects the focus point for movie recording.

Option	Description
MULTI	Automatic focus-point selection.
AREA	The camera focuses on the subject in the selected focus area.

HDMI OUTPUT INFO DISPLAY

If **ON** is selected, HDMI devices to which the camera is connected will mirror the information in the camera display.

Options: ON/OFF

MIC LEVEL ADJUSTMENT

Adjust the microphone recording level.

Options: 1—4

MIC/REMOTE RELEASE

Specify whether the device connected to the microphone/remote release connector is a microphone or a remote release (📖 41, 77).

Options: 🎤 MIC/🔌 REMOTE

MY MYMENU

To display a personalized menu of frequently-used options, press **MENU/OK** in the shooting display and select the **MY (MY MENU)** tab (📖 89).

- 🔍 To edit “my menu”, select **USER SETTING > MY MENU SETTING** (📖 127).
- 🔍 The **MY** tab is only available if options have been assigned to **MY MENU**.

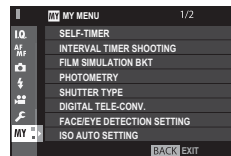

Using the Menus: Playback Mode

The playback menu is used to adjust playback settings.

Using the Playback Menu

- 1 Press **MENU/OK** in playback mode to display the menus.

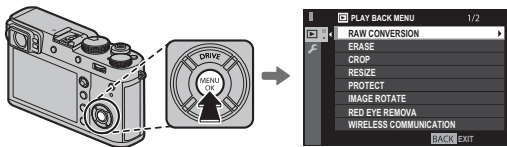

- 2 Press the selector up or down to highlight the desired item.



- 3 Press the selector right to view options for the highlighted item.



- 4 Press the selector up or down to highlight the desired option.



- 5 Press **MENU/OK** to select the highlighted option.



- 6 Press **DISP/BACK** to return to the playback display.



- Use the front command dial to select menu tabs or page through menus and the rear command dial to highlight menu items.

PLAYBACK MENU

To access playback options, press **MENU/OK** in the playback display and select the **PLAY BACK MENU** tab (108).

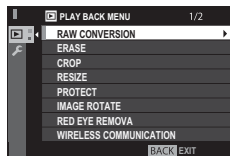
**RAW CONVERSION**

Create JPEG copies of RAW pictures (85).

ERASE

Delete pictures (39).

CROP

Create a cropped copy of the current picture.

- 1 Display the desired picture.
 - 2 Select **CROP** in the playback menu.
 - 3 Use the rear command dial to zoom in and out and press the selector up, down, left, or right to scroll the picture until the desired portion is displayed.
 - 4 Press **MENU/OK** to display a confirmation dialog.
 - 5 Press **MENU/OK** again to save the cropped copy to a separate file.
- ◆ Larger crops produce larger copies; all copies have an aspect ratio of 3:2. If the size of the final copy will be **640**, **OK** will be displayed in yellow.

RESIZE

Create a small copy of the current picture.

- 1 Display the desired picture.
- 2 Select  **RESIZE** in the playback menu.
- 3 Highlight a size and press **MENU/OK** to display a confirmation dialog.
- 4 Press **MENU/OK** again to save the resized copy to a separate file.

◆ The sizes available vary with the size of the original image.

PROTECT

Protect pictures from accidental deletion. Highlight one of the following options and press **MENU/OK**.

- **FRAME**: Protect selected pictures. Press the selector left or right to view pictures and press **MENU/OK** to select or deselect. Press **DISP/BACK** when the operation is complete.
- **SET ALL**: Protect all pictures.
- **RESET ALL**: Remove protection from all pictures.

① Protected pictures will be deleted when the memory card is formatted (📖 114).

IMAGE ROTATE

Rotate pictures.

- 1 Display the desired picture.
- 2 Select  **IMAGE ROTATE** in the playback menu.
- 3 Press the selector down to rotate the picture 90° clockwise, up to rotate it 90° counterclockwise.
- 4 Press **MENU/OK**. The picture will automatically be displayed in the selected orientation whenever it is played back on the camera.

- ◆ Protected pictures can not be rotated. Remove protection before rotating pictures.
- ◆ The camera may not be able to rotate pictures created with other devices. Pictures rotated on the camera will not be rotated when viewed on a computer or on other cameras.
- ◆ Pictures taken with  **SCREEN SETTING > AUTOROTATE PB** are automatically displayed in the correct orientation during playback (📖 120).

RED EYE REMOVAL

Remove red-eye from portraits. The camera will analyze the image; if red-eye is detected, the image will be processed to create a copy with reduced red-eye.

1 Display the desired picture.

2 Select  **RED EYE REMOVAL** in the playback menu.

3 Press **MENU/OK**.

- ◆ Red eye may not be removed if the camera is unable to detect a face or the face is in profile. Results may differ depending on the scene. Red eye can not be removed from pictures that have already been processed using red-eye removal or pictures created with other devices.
- ◆ The amount of time needed to process the image varies with the number of faces detected.
- ◆ Copies created with **RED EYE REMOVAL** are indicated by a  icon during playback.
- ◆ Red eye removal can not be performed on RAW images.

WIRELESS COMMUNICATION

Connect to a smartphone or tablet over a wireless network ( 131).

- ◆ For more information, visit <http://fujifilm-dsc.com/wifi/>.

SLIDE SHOW

View pictures in an automated slide show. Press **MENU/OK** to start. Press **DISP/BACK** at any time during the show to view on-screen help. The show can be ended at any time by pressing **MENU/OK**.

- ◆ The camera will not turn off automatically while a slide show is in progress.

PHOTOBOOK ASSIST

Create books from your favorite photos ( 87).

PC AUTO SAVE

Upload pictures to a computer over a wireless network ( 131).

- ◆ For more information, visit <http://fujifilm-dsc.com/wifi/>.

PRINT ORDER (DPOF)

Select pictures for printing (📖 135).

instax PRINTER PRINT

Print pictures on optional FUJIFILM instax SHARE printers (📖 138).

DISP ASPECT

Choose how **H**igh **D**efinition (HD) devices display pictures with an aspect ratio of 3:2 (this option is available only when an HDMI cable is connected). Select 16:9 to display the image so that it fills the screen with its top and bottom cropped out, 3:2 to display the entire image with black bands at either side.

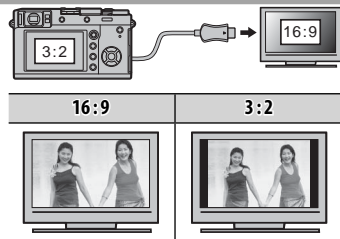

The Setup Menu

View and adjust basic camera settings.

Using the Setup Menu

- 1 Press **MENU/OK** in shooting mode to display the menus.

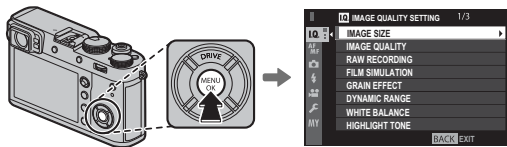

- 2 Press the selector left to highlight the tab for the current menu.

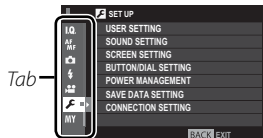

- 3 Press the selector down to highlight the **SET UP** tab.



- 4 Press the selector right to display setup menu categories.



- 5 Press the selector up or down to highlight the category containing the desired item.



- 6 Press the selector right to view the option in the highlighted category.



- 7 Press the selector up or down to highlight the desired item.



- 8 Press the selector right to view options for the highlighted item.



- 9 Press the selector up or down to highlight the desired option.



- 10 Press **MENU/OK** to select the highlighted option.



- 11 Press **DISP/BACK** to return to the shooting display.



- Use the front command dial to select menu tabs or page through menus and the rear command dial to highlight menu items.

SET UP Menu Options

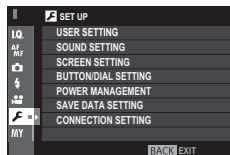

To access basic camera settings, press **MENU/OK** in the playback display and select the  (**SET UP**) tab (📖 113).



USER SETTING

FORMAT

To format a memory card:

- 1 Highlight  **USER SETTING** > **FORMAT** in the setup menu and press **MENU/OK**.
 - 2 A confirmation dialog will be displayed. To format the memory card, highlight **OK** and press **MENU/OK**. To exit without formatting the memory card, select **CANCEL** or press **DISP/BACK**.
- ⓘ All data—including protected pictures—will be deleted from the memory card. Be sure important files have been copied to a computer or other storage device.
 - ⓘ Do not open the battery-chamber cover during formatting.
 - 💡 The format menu can also be displayed by pressing the center of the rear command dial while pressing and holding the  button.

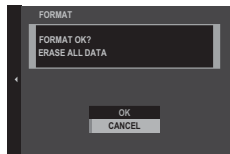

DATE/TIME

Set the camera clock (📖 25, 26).

TIME DIFFERENCE

Switch the camera clock instantly from your home time zone to the local time at your destination when traveling. To specify the difference between local time and your home time zone:

- 1 Highlight **← LOCAL** and press **MENU/OK**.
- 2 Use the selector to choose the time difference between local time and your home time zone. Press **MENU/OK** when settings are complete.

To set the camera clock to local time, highlight **← LOCAL** and press **MENU/OK**. To set the clock to the time in your home time zone, select **HOME**. If **← LOCAL** is selected, **←** will be displayed for three seconds when the camera is turned on.

言語/LANG.

Choose a language.

MY MENU SETTING

Edit “my menu” (📖 127).

SHUTTER COUNT

View the approximate number of times the shutter has been released. Other actions may also increment the counter, for example turning the camera off, changing the viewfinder display selection, or choosing playback mode.

SOUND & FLASH

Select **OFF** to disable the speaker, flash, and illuminator in situations in which camera sounds or lights may be unwelcome. **OFF** appears in the display when **OFF** is selected.

Options: ON/OFF

RESET

Reset shooting or setup menu options to default values.

- 1 Highlight the desired option and press **MENU/OK**.

Option	Description
SHOOTING MENU RESET	Reset all shooting menu settings other than custom white balance and custom settings banks created using EDIT/SAVE CUSTOM SETTING to default values.
SET-UP RESET	Reset all setup menu settings other than DATE/TIME , TIME DIFFERENCE , and CONNECTION SETTING to default values.

- 2 A confirmation dialog will be displayed; highlight **OK** and press **MENU/OK**.
-

■ SOUND SETTING

AF BEEP VOL.

Choose the volume of the beep that sounds when the camera focuses. The beep can be muted by selecting **OFF**.

Options:   /   /   /  **OFF**

SELF-TIMER BEEP VOL.

Choose the volume of the beep that sounds while the self-timer is active ( 78). The beep can be muted by selecting **OFF**.

Options:   /   /   /  **OFF**

OPERATION VOL.

Adjust the volume of the sounds produced when camera controls are operated. Choose  **OFF** (mute) to disable control sounds.

Options:   /   /   /  **OFF**



SHUTTER VOLUME

Adjust the volume of the sounds produced when the shutter is released. Choose  **OFF** (mute) to disable the shutter sound.

Options:   /   /   /  **OFF**

SHUTTER SOUND

Choose the sound made by the shutter.

Options:  1 /  2 /  3

PLAYBACK VOLUME

Adjust the volume for movie playback.

Options: 10—1/OFF

■ SCREEN SETTING

EVF BRIGHTNESS

Adjust the brightness of the display in the electronic viewfinder. Select **MANUAL** to choose from 11 options from +5 (bright) to -5 (dark), or select **AUTO** for automatic brightness adjustment.

Options: MANUAL/AUTO

EVF COLOR

Adjust the hue of the display in the electronic viewfinder.

Options: +5/+4/+3/+2/+1/0/-1/-2/-3/-4/-5

LCD BRIGHTNESS

Adjust monitor brightness.

Options: +5/+4/+3/+2/+1/0/-1/-2/-3/-4/-5

LCD COLOR

Adjust monitor hue.

Options: +5/+4/+3/+2/+1/0/-1/-2/-3/-4/-5

IMAGE DISP.

Choose how long images are displayed after shooting. Colors may differ slightly from those in the final image and “noise” mot-tling may be visible at high sensitivities.

Option	Description
CONTINUOUS	Pictures are displayed until the MENU/OK button is pressed or the shutter button is pressed halfway. To zoom in on the active focus point, press the center of the rear command dial; press again to cancel zoom.
1.5 SEC	Pictures are displayed for 1.5 seconds (1.5 SEC) or 0.5 seconds (0.5 SEC) or until the shutter button is pressed halfway.
0.5 SEC	
OFF	Pictures are not displayed after shooting.

EVF AUTOROTATE DISPLAYS

Choose whether the indicators in the viewfinder rotate to match camera orientation (📖 29). Regardless of the option selected, the indicators in the monitor do not rotate.

Options: ON/OFF

PREVIEW EXP./WB IN MANUAL MODE

Select **PREVIEW EXP./WB** to enable exposure and white balance preview in manual exposure mode (📖 53), or choose **PREVIEW WB** to preview only white balance. Select **OFF** when using a flash or on other occasions on which exposure may change when the picture is taken.

PREVIEW PIC. EFFECT

Choose **ON** to preview the effects of film simulation, white balance, and other settings in the monitor, **OFF** to make shadows in low-contrast, back-lit scenes and other hard-to-see subjects more visible.







- ❖ If **OFF** is selected, the effects of camera settings will not be visible in the monitor and colors and tone will differ from those in the final picture. The display will however be adjusted to show the effects of advanced filters and of monochrome and sepia settings.

Options: ON/OFF

FRAMING GUIDELINE

Choose the type of framing grid available in shooting mode.

- ❖ Framing guides are not shown at default settings but can be displayed using **SCREEN SETTING > DISP. CUSTOM SETTING** (📖 31).

 GRID 9	 GRID 24	 HD FRAMING
		
<p><i>For "rule of thirds" composition.</i></p>	<p><i>A six-by-four grid.</i></p>	<p><i>Frame HD pictures in the crop shown by the lines at the top and bottom of the display.</i></p>

AUTOROTATE PB

Choose **ON** to automatically rotate “tall” (portrait-orientation) pictures during playback.

Options: ON/OFF

FOCUS SCALE UNITS

Choose the units used for the focus distance indicator (📖 69).

Options: METERS/FEET

DISP. CUSTOM SETTING

Choose items for the standard display (📖 31).

■ BUTTON/DIAL SETTING

FOCUS LEVER SETTING

Choose the functions performed by the focus stick (focus lever).

Option	Description
LOCK (OFF)	The focus stick can not be used during shooting.
PUSH  TO UNLOCK	Press the stick to view the focus-point display and tilt the stick to select a focus point.
ON	Tilt the stick to view the focus-point display and select a focus point.

EDIT/SAVE QUICK MENU

Choose the options displayed in the quick menu ( 45).

FUNCTION (Fn) SETTING

Choose the roles played by the **AEL/AFL** and function buttons and the center of the rear command dial ( 46).

ISO DIAL SETTING (H)

Choose the ISO sensitivity assigned to the **H** position on the sensitivity dial.

Options: 25600/51200



ISO DIAL SETTING (A)

Choose how sensitivity is adjusted when the shutter speed/sensitivity dial is rotated to **A**.

Option	Description
AUTO	Sensitivity is adjusted automatically according to subject brightness.
COMMAND	Sensitivity is adjusted manually by rotating the front command dial.

FOCUS RING

Choose the direction in which the focus ring is rotated to increase the focus distance.

Options:  **CW** (clockwise)/  **CCW** (counterclockwise)

CONTROL RING SETTING

Set functions assigned to the control ring.

Options: **DEFAULT/WHITE BALANCE/FILM SIMULATION/DIGITAL TELE-CONV.**

AE/AF-LOCK MODE

If **AE&AF ON WHEN PRESSING** is selected, exposure and/or focus will lock while the **AEL/AFL** button is pressed ( 80). If **AE&AF ON/OFF SWITCH** is selected, exposure and/or focus will lock when the **AEL/AFL** button is pressed and remain locked until the button is pressed again.

■ POWER MANAGEMENT

AUTO POWER OFF

Choose the length of time before the camera turns off automatically when no operations are performed. Shorter times increase battery life; if **OFF** is selected, the camera must be turned off manually.

Options: 5 MIN/2 MIN/1 MIN/30 SEC/15 SEC/OFF

POWER MANAGEMENT

Adjust power management settings.

Option	AF performance (speed)	LCD/EVF display quality	Battery endurance
HIGH PERFORMANCE	Fast	Very high	Low
STANDARD	Fast	High	Normal
ECONOMY	Normal	High	High

- ◆ When **ECONOMY** is selected, the frame rate will drop when no operations are being performed. Operating camera controls returns the frame rate to normal.

SAVE DATA SETTING

FRAME NO.

New pictures are stored in image files named using a four-digit file number assigned by adding one to the last file number used. The file number is displayed during playback as shown at right. **FRAME NO.** controls whether file numbering is reset to 0001 when a new memory card is inserted or the current memory card is formatted.

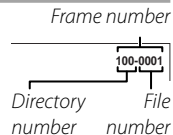

Option	Description
CONTINUOUS	Numbering continues from the last file number used or the first available file number, whichever is higher. Choose this option to reduce the number of pictures with duplicate file names.
RENEW	Numbering is reset to 0001 after formatting or when a new memory card is inserted.

- ◆ If the frame number reaches 999-9999, the shutter release will be disabled (158).
- ◆ Selecting **USER SETTING > RESET** (116) sets **FRAME NO.** to **CONTINUOUS** but does not reset the file number.
- ◆ Frame numbers for pictures taken with other cameras may differ.

SAVE ORG IMAGE

Choose **ON** to save unprocessed copies of pictures taken using **FLASH SETTING > RED EYE REMOVAL** (102).

Options: ON/OFF

EDIT FILE NAME

Change the file name prefix. sRGB images use a four-letter prefix (default "DSCF"), Adobe RGB images a three-letter prefix ("DSF") preceded by an underscore.

COPYRIGHT INFO

Copyright information, in the form of Exif tags, can be added to new images as they taken. Changes to copyright information are reflected only in images taken after the changes are made.



Option	Description
DISP COPYRIGHT INFO	View the current copyright information.
ENTER AUTHOR'S INFO	Enter the creator's name.
ENTER COPYRIGHT INFO	Enter the name of the copyright holder.
DELETE COPYRIGHT INFO	Delete the current copyright information. This change applies only to images taken after this option is selected; copyright information recorded with existing images is not affected.

■ CONNECTION SETTING

For more information on wireless connections, visit <http://fujifilm-dsc.com/wifi/>

WIRELESS SETTINGS

Adjust settings for connection to wireless networks.

Option	Description
GENERAL SETTINGS	Choose a name (NAME) to identify the camera on the wireless network (the camera is assigned a unique name by default) or select RESET WIRELESS SETTINGS to restore default settings.
RESIZE IMAGE FOR SMARTPHONE 	Choose ON (the default setting, recommended in most circumstances) to resize larger images to  for upload to smartphones, OFF to upload images at their original size. Resizing applies only to the copy uploaded to the smartphone; the original is not affected.
PC AUTO SAVE SETTINGS	Choose DELETE REGISTERED DESTINATION PC to remove selected destinations, DETAILS OF PREVIOUS CONNECTION to view computers to which the camera has recently connected.

PC AUTO SAVE SETTING

Choose an upload destination. Choose **SIMPLE SETUP** to connect using WPS, **MANUAL SETUP** to configure network settings manually.

GEOTAGGING SET-UP

View location data downloaded from a smartphone and choose whether to save the data with your pictures.

Option	Description
GEOTAGGING	Choose whether location data downloaded from a smartphone are embedded in pictures as they are taken.
LOCATION INFO	Display the location data last downloaded from a smartphone.

instax PRINTER CONNECTION SETTING

Adjust settings for connection to optional FUJIFILM instax SHARE printers ( 137).

“My Menu”

Selecting the **MY** (**MY MENU**) tab displays a personalized custom menu of frequently-used options (📖 107).

Editing “My Menu”

1 In the setup menu **USER SETTING** tab, highlight **MY MENU SETTING** and press **MENU/OK** to display the following options (📖 113).

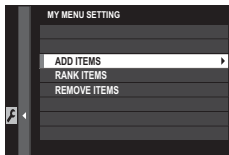

2 Press the selector up or down to highlight **ADD ITEMS** and press **MENU/OK**. Options that can be added to “my menu” are highlighted in blue.

◆ Options currently in “my menu” are indicated by check marks.

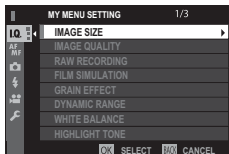

3 Highlight an item and press **MENU/OK** to add it to “my menu”.



4 Press **MENU/OK** to return to the edit display.

5 Repeat Steps 3 and 4 until all the desired items have been added.

◆ “My menu” can contain up to 16 items.

Editing “My Menu”

To reorder or delete items, select **RANK ITEMS** or **REMOVE ITEMS** in Step 1.

Factory Defaults

The factory default settings for the options in the shooting and setup menus are listed below. These settings can be restored using **USER SETTING > RESET** (116).



Shooting Menu

Menu	Default
IMAGING IMAGE QUALITY SETTING	
IMAGE SIZE	3:2
IMAGE QUALITY	FINE
RAW RECORDING	UNCOMPRESSED
FILM SIMULATION	PROVIA/STANDARD
GRAIN EFFECT	OFF
DYNAMIC RANGE	100%
WHITE BALANCE	AUTO
HIGHLIGHT TONE	0
SHADOW TONE	0
COLOR	0
SHARPNESS	0
NOISE REDUCTION	0
LONG EXPOSURE NR	ON
COLOR SPACE	sRGB
SELECT CUSTOM SETTING	CUSTOM 1

Menu	Default
AF AF/MF SETTING	
AF MODE	SINGLE POINT
AF POINT DISPLAY	ON
NUMBER OF THE FOCUS POINTS	91 POINTS (7×13)
PRE-AF	OFF
AF ILLUMINATOR	ON
FACE/EYE DETECTION SETTING	FACE OFF/EYE OFF
AF+MF	OFF
MF ASSIST	STANDARD
FOCUS CHECK	OFF
INTERLOCK SPOT AE & FOCUS AREA	ON
INSTANT AF SETTING	AF-S
RELEASE/FOCUS PRIORITY · AF-S PRIORITY SELECTION · AF-C PRIORITY SELECTION	RELEASE RELEASE
CORRECTED AF FRAME	OFF

Menu	Default
SHOOTING SETTING	
SELF-TIMER	OFF
FILM SIMULATION BKT	
• FILM 1	PROVIA/STANDARD
• FILM 2	Velvia/VIVID
• FILM 3	ASTIA/SOFT
PHOTOMETRY	MULTI
SHUTTER TYPE	MECHANICAL SHUTTER
ISO AUTO SETTING	AUTO3
CONVERSION LENS	OFF
DIGITAL TELE-CONV.	OFF
ND FILTER	OFF
FLASH SETTING	
RED EYE REMOVAL	OFF
TTL-LOCK MODE	LOCK WITH LAST FLASH
Built-In Flash	ON
MOVIE SETTING	
MOVIE MODE	 1080/59.94P
MOVIE AF MODE	MULTI
HDMI OUTPUT INFO DISPLAY	OFF
MIC LEVEL ADJUSTMENT	3
MIC/REMOTE RELEASE	MIC

Setup Menu

Menu	Default
USER SETTING	
TIME DIFFERENCE	HOME
SOUND & FLASH	ON
SOUND SETTING	
AF BEEP VOL.	 1
SELF-TIMER BEEP VOL.	 1
OPERATION VOL.	OFF
SHUTTER VOLUME	 1
SHUTTER SOUND	SOUND 1
PLAYBACK VOLUME	7

Menu	Default
SCREEN SETTING	
EVF BRIGHTNESS	AUTO
EVF COLOR	0
LCD BRIGHTNESS	0
LCD COLOR	0
IMAGE DISP.	OFF
EVF AUTOROTATE DISPLAYS	ON
PREVIEW EXP./WB IN MANUAL MODE	PREVIEW EXP./WB
PREVIEW PIC. EFFECT	ON
FRAMING GUIDELINE	GRID 9
AUTOROTATE PB	OFF
FOCUS SCALE UNITS	METERS
DISP. CUSTOM SETTING	See page 31.
BUTTON/DIAL SETTING	
FOCUS LEVER SETTING	ON
EDIT/SAVE QUICK MENU	See page 43.
FUNCTION (Fn) SETTING	See page 46.
ISO DIAL SETTING (H)	25600
ISO DIAL SETTING (A)	AUTO
FOCUS RING	↻ CW
CONTROL RING SETTING	DEFAULT
AE/AF-LOCK MODE	AE&AF ON WHEN PRESS- ING

Menu	Default
POWER MANAGEMENT	
AUTO POWER OFF	2 MIN
POWER MANAGEMENT	STANDARD
SAVE DATA SETTING	
FRAME NO.	CONTINUOUS
SAVE ORG IMAGE	OFF
CONNECTION SETTING	
WIRELESS SETTINGS • RESIZE IMAGE FOR SMARTPHONE 	ON
PC AUTO SAVE SETTING	SIMPLE SETUP
GEOTAGGING SET-UP • GEOTAGGING • LOCATION INFO	ON ON

Connections

Wireless Transfer (FUJIFILM Camera Remote/FUJIFILM PC AutoSave)

Access wireless networks and connect to computers, smartphones, or tablets. For downloads and other information, visit <http://fujifilm-dsc.com/wifi/>.



fujifilm Wi-Fi app



Wireless Connections: Smartphones

Install the “FUJIFILM Camera Remote” app on your smartphone to browse the images on the camera, download selected images, control the camera remotely, or copy location data to the camera. To connect to the smartphone, set the camera to playback mode and press the function button (Fn1).

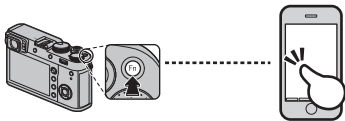

◆ You can also connect using **SHOOTING SETTING/PLAY BACK MENU > WIRELESS COMMUNICATION** (📖 101, 111).

Wireless Connections: Computers

Once you have installed the “FUJIFILM PC AutoSave” application and configured your computer as a destination for the images copied from the camera, you can upload pictures from the camera using **PLAY BACK MENU > PC AUTO SAVE** (📖 111) or by pressing and holding the function button (Fn1) in playback mode.

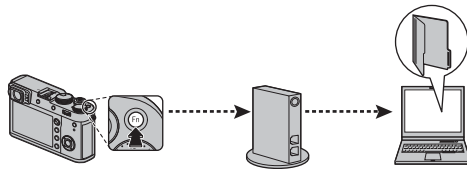

Viewing Pictures on a Computer (MyFinePix Studio/RAW FILE CONVERTER EX 2.0)

Read this section for information on copying pictures to a computer.

Windows

Use MyFinePix Studio to copy pictures to your computer, where they can be stored, viewed, organized, and printed. MyFinePix Studio is available for download from the following website:

<http://fujifilm-dsc.com/mfs/>



Once download is complete, double-click the downloaded file ("MFPS_Setup.EXE") and follow the on-screen instructions to complete installation.

Mac OS X/macOS

Pictures can be copied to your computer using Image Capture (supplied with your computer) or other software.

Viewing RAW Files

To view RAW files on your computer, use the RAW FILE CONVERTER EX 2.0, available for download from:

<http://fujifilm-dsc.com/rfc/>



Connecting the Camera

- 1** Find a memory card containing pictures you want to copy to the computer and insert the card into the camera.
 - ① Loss of power during transfer could result in loss of data or damage to the memory card. Insert a fresh or fully-charged battery before connecting the camera.
- 2** Turn the camera off and connect the supplied USB cable as shown, making sure the connectors are fully inserted. Connect the camera directly to the computer; do not use a USB hub or keyboard.
 - ① The camera uses a Micro-B USB 2.0 connector.
- 3** Turn the camera on.
- 4** Copy pictures to the computer using MyFinePix Studio or applications provided with your operating system.

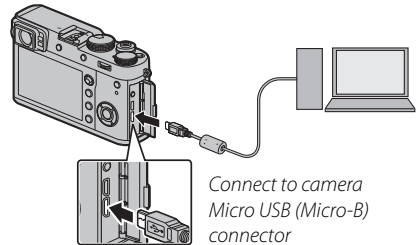

For more information on using the software, start the application and select the appropriate option from the **Help** menu.

- ❗ If a memory card containing a large number of images is inserted, there may be a delay before the software starts and you may be unable to import or save images. Use a memory card reader to transfer pictures.
- ❗ Make sure that the computer does not display a message stating that copying is in progress and that the indicator lamp is out before turning the camera off or disconnecting the USB cable (if the number of images copied is very large, the indicator lamp may remain lit after the message has cleared from the computer display). Failure to observe this precaution could result in loss of data or damage to the memory card.
- ❗ Disconnect the camera before inserting or removing memory cards.
- ❗ In some cases, it may not be possible to access pictures saved to a network server using the software in the same way as on a standalone computer.
- ❗ The user bears all applicable fees charged by the phone company or Internet service provider when using services that require an Internet connection.

Disconnecting the Camera

After confirming that the indicator lamp is out, turn the camera off and disconnect the USB cable.

Creating a DPOF Print Order

The **PLAY BACK MENU > PRINT ORDER (DPOF)** (📖 112) option can be used to create a digital “print order” for DPOF-compatible printers.

DPOF

DPOF (Digital Print Order Format) is standard that allows pictures to be printed from “print orders” stored on the memory card. The information in the order includes the pictures to be printed and the number of copies of each picture.



WITH DATE /WITHOUT DATE

To modify the DPOF print order, select **PLAY BACK MENU > PRINT ORDER (DPOF)** (📖 108) and press the selector up or down to highlight **WITH DATE ** or **WITHOUT DATE**.

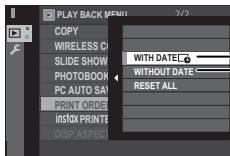

WITH DATE : Print date of recording on pictures.

WITHOUT DATE: Print pictures without date.

Press **MENU/OK** and follow the steps below.

- 1 Press the selector left or right to display a picture you wish to include in or remove from the print order.
- 2 Press the selector up or down to choose the number of copies (up to 99). To remove a picture from the order, press the selector down until the number of copies is 0.

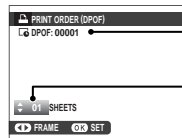

Total number of prints

Number of copies

3 Repeat steps 1–2 to complete the print order.

Press **MENU/OK** to save the print order when settings are complete, or **DISP/BACK** to exit without changing the print order.

4 The total number of prints is displayed in the monitor. Press **MENU/OK** to exit.

The pictures in the current print order are indicated by a  icon during playback.

■ **RESET ALL**

To cancel the current print order, select **RESET ALL** for  **PLAY BACK MENU > PRINT ORDER (DPOF)** (📖 108). The confirmation shown at right will be displayed; press **MENU/OK** to remove all pictures from the order.

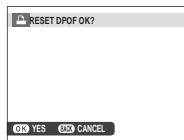

🔒 Print orders can contain a maximum of 999 pictures.

🔒 If a memory card is inserted containing a print order created by another camera, the message shown at right will be displayed. Pressing **MENU/OK** cancels the print order; a new print order must be created as described above.

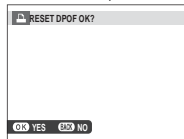

instax SHARE Printers

Print pictures from your digital camera to instax SHARE printers.

Establishing a Connection

Select **CONNECTION SETTING** > **instax PRINTER CONNECTION SETTING** (📖 126) and enter the instax SHARE printer name (SSID) and password.

🔍 The Printer Name (SSID) and Password

The printer name (SSID) can be found on the bottom of the printer; the default password is "1111". If you have already chosen a different password to print from a smartphone, enter that password instead.

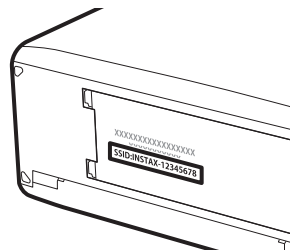

Printing Pictures

1 Turn the printer on.

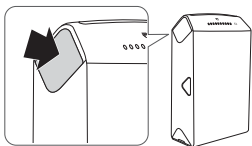

2 Select **PLAY BACK MENU** > **instax PRINTER PRINT** (🗨️ 108). The camera will connect to the printer.

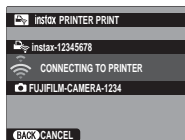

🔍 To print a frame from a burst sequence, display the frame before selecting **instax PRINTER PRINT**.

3 Use the selector to display the picture you want to print, then press **MENU/OK**.

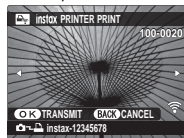

- 🔍 Pictures taken with other cameras can not be printed.
- 🔍 The area printed is smaller than the area visible in the LCD monitor.

4 The picture will be sent to the printer and printing will start.



Viewing Pictures on TV

To show pictures to a group, connect the camera to a TV using an HDMI cable (available separately from third-party suppliers; note that the TV can only be used for playback, not shooting).

- 1 Turn the camera off.
- 2 Connect the cable as shown below, making sure the connectors are fully inserted in the correct orientation.

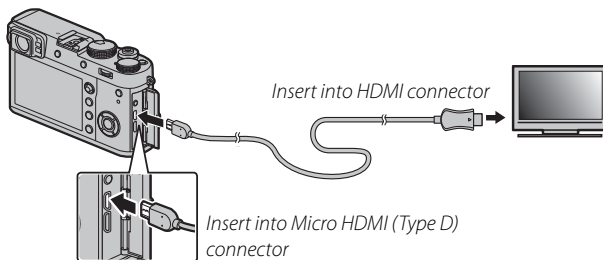

- ① Use an HDMI cable no more than 1.5 m (4.9 ft.) long with a type D (HDMI Micro) connector for connection to the camera.
 - ◆ Be sure the connectors are fully inserted.
- 3 Tune the television to the HDMI input channel. See the documentation supplied with the television for details.
- 4 Turn the camera on and press  button. The camera monitor turns off and pictures and movies are played back on the TV. Note that the camera volume controls have no effect on sounds played on the TV; use the television volume controls to adjust the volume.
 - ◆ The USB cable can not be used while an HDMI cable is connected.
 - ◆ Some televisions may briefly display a black screen when movie playback begins.

Technical Notes

Optional Accessories

The camera supports a wide range of accessories from FUJIFILM and other manufacturers.

Accessories from FUJIFILM

The following optional accessories are available from FUJIFILM. For the latest information on the accessories available in your region, check with your local FUJIFILM representative or visit http://www.fujifilm.com/products/digital_cameras/index.html.

Rechargeable Li-ion batteries

NP-W126S: Additional large-capacity NP-W126S rechargeable batteries can be purchased as required.



Battery chargers

BC-W126: Replacement battery chargers can be purchased as required. At +20°C/+68°F, the BC-W126 charges an NP-W126S in about 150 minutes.



AC power adapters

AC-9V (requires CP-W126 DC coupler): Use for extended shooting and playback or when copying pictures to a computer.

DC couplers

CP-W126: Connect the AC-9V to the camera.

Shoe-mounted flash units

EF-X500: This clip-on flash unit has a Guide Number of 50/164 (ISO 100, m/ft.) and supports FP (high-speed sync), allowing it to be used at shutter speeds that exceed the flash sync speed. Powered by four AA batteries or an optional EF-BP1 battery pack, it supports manual and TTL flash control and auto power zoom in the range 24–105 mm (35 mm format equivalent) and features FUJIFILM optical wireless flash control, allowing it to be used as a master or remote flash unit for remote wireless flash photography. The flash head can be rotated 90° up, 10° down, 135° left, or 180° right for bounce lighting.



EF-42: This clip-on flash unit (powered by four AA batteries) has a Guide Number of 42/137 (ISO 100, m/ft.) and supports TTL flash control and auto power zoom in the range 24–105 mm (35 mm format equivalent). The flash head can be rotated 90° up, 180° left, or 120° right for bounce lighting.



EF-X20: This clip-on flash unit has a Guide Number of 20/65 (ISO 100, m/ft.).



EF-20: This clip-on flash unit (powered by two AA batteries) has a Guide Number of 20/65 (ISO 100, m/ft.) and supports TTL flash control. The flash head can be rotated upwards 90° for bounce lighting.

**Remote releases**

RR-90: Use to reduce camera shake or keep the shutter open during a time exposure.

**Stereo microphones**

MIC-ST1: An external microphone for movie recording.

**Leather cases**

LC-X100F: This leather case comes with a shoulder strap made of the same material. Pictures can be taken and batteries and memory cards inserted or removed with the camera still in its case.

Grip belts

GB-001: This accessory improves your grip on the camera, allowing it to be carried in one hand.

Conversion lenses

TCL-X100II: Increases the focal length of the camera lens.

WCL-X100II: Reduces the focal length of the camera lens and increases its angle of view.

Adapter rings

AR-X100: An aluminum adapter ring used when attaching the LH-X100 lens hood or ϕ 49 mm filters available from third-party suppliers.

Lens hoods

LH-X100: This aluminum lens hood comes with an AR-X100 adapter ring made of the same material. The adapter ring is required when attaching the hood.

Protective filters

PRF-49S: A filter used to protect the lenses of X100-series cameras (requires the AR-X100 adapter ring).

instax SHARE printers

SP-1/SP-2: Connect via wireless LAN to print pictures on instax film.

Connecting the Camera to Other Devices

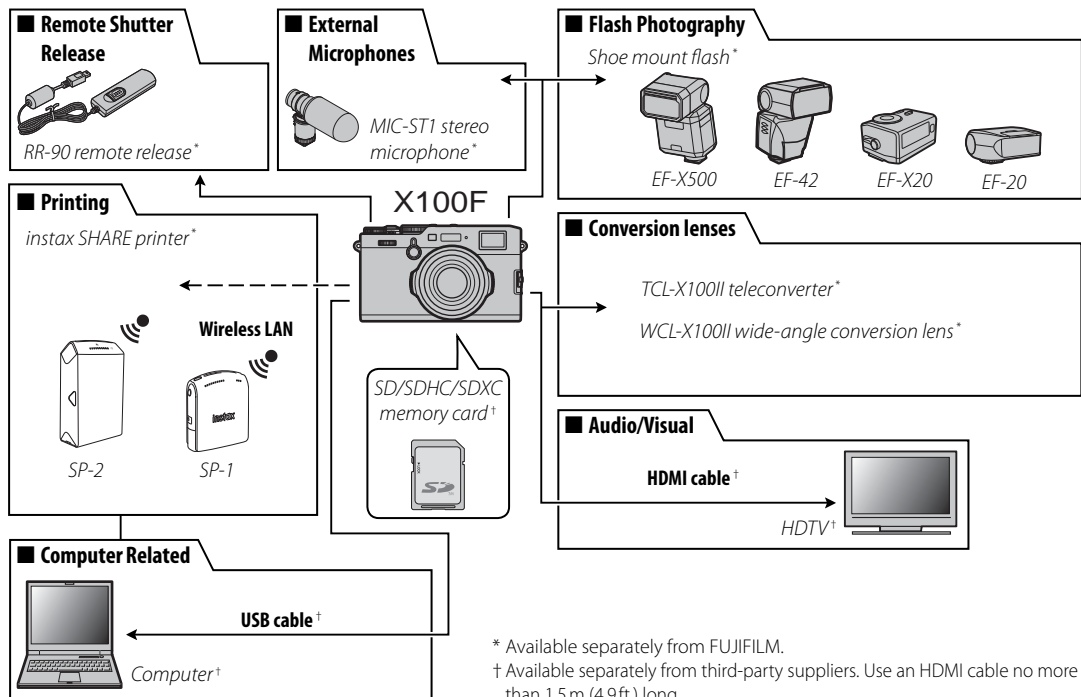

* Available separately from FUJIFILM.

† Available separately from third-party suppliers. Use an HDMI cable no more than 1.5 m (4.9ft.) long.

Using Shoe-Mounted Flash Units

External flash units are more powerful than their built-in counterparts. Some can function as master flash units controlling remote units via optical wireless flash control.

ⓘ Test firing may sometimes be unavailable, for example when the camera setup menu is displayed.

Connect the flash unit and select **FLASH SETTING > FLASH FUNCTION SETTING** in the camera shooting menu to display flash options. The options available vary with the status of the connected unit.

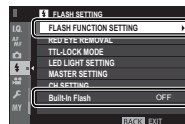

❖ To prevent the built-in flash firing when a shoe-mounted flash unit is attached, select **OFF** for **FLASH SETTING > Built-In Flash**.

Menu	Description
SHOE MOUNT FLASH	Displayed when an optional flash unit is mounted on the hot shoe and turned on (📖 145).
MASTER (OPTICAL)	Displayed if an optional flash unit functioning as a master flash for FUJIFILM optical wireless remote flash control is connected and turned on (📖 146).

- ❖ **SYNC TERMINAL** will be displayed if **OFF** is selected for **FLASH SETTING > Built-In Flash** and no supported shoe-mounted flash is attached.
- ❖ Flash units that support burst mode can be used for burst photography.

SHOE MOUNT FLASH

The following options are available with optional shoe-mounted flash units.

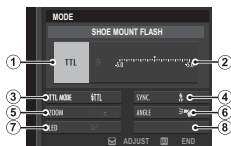

- ① **Flash control mode:** The flash control mode selected with the flash unit. This can in some cases be adjusted from the camera; the options available vary with the flash.
 - **TTL:** TTL mode. Adjust flash compensation (②).
 - **M:** The flash fires at the selected output regardless of subject brightness or camera settings. Output in some cases can be adjusted from the camera (②).
 - **MULTI:** Repeating flash. Compatible shoe-mounted flash units will fire multiple times with each shot.
 - **OFF:** The flash does not fire. Some flash units can be turned off from the camera.
- ② **Flash compensation/output:** The options available vary with flash control mode.
 - **TTL:** Adjust flash compensation (the full value may not be applied if the limits of the flash control system are exceeded). In the cases of the EF-X20, EF-20, and EF-42, the selected value is added to the value selected with the flash unit.
 - **M/MULTI:** Adjust flash output (compatible units only). Choose from values expressed as fractions of full power, from $\frac{1}{2}$ (mode **M**) or $\frac{1}{4}$ (**MULTI**) down to $\frac{1}{512}$ in increments equivalent to $\frac{1}{3}$ EV. The desired results may not be achieved at low values if they exceed the limits of the flash control system; take a test shot and check the results.

- ③ **Flash mode (TTL):** Choose a flash mode for TTL flash control. The options available vary with the shooting mode (**P**, **S**, **A**, or **M**) selected.
 - **$\frac{1}{2}$ TTL (FLASH AUTO):** The flash fires only as required; flash level is adjusted according to subject brightness. A **1/2** icon displayed when the shutter button is pressed halfway indicates that the flash will fire when the photo is taken.
 - **$\frac{1}{2}$ TTL (STANDARD):** The flash fires with every shot if possible; flash level is adjusted according to subject brightness. The flash will not fire if not fully charged when the shutter is released.
 - **$\frac{1}{2}$ TTL (SLOW SYNC.):** Combine the flash with slow shutter speeds when photographing portrait subjects against a backdrop of night scenery. The flash will not fire if not fully charged when the shutter is released.
- ④ **Sync:** Control flash timing.
 - **$\frac{1}{2}$ FRONT (1ST CURTAIN):** The flash fires immediately after the shutter opens (generally the best choice).
 - **$\frac{1}{2}$ REAR (2ND CURTAIN):** The flash fires immediately before the shutter closes.
- ⑤ **Zoom:** The angle of illumination (flash coverage) for units that support flash zoom. Some units allow the adjustment to be made from the camera. Select **AUTO** to automatically match coverage to focal length when using optional conversion lenses.

⑥ **Lighting:** If the unit supports this feature, choose from the options below.

- **FLASH POWER PRIORITY:** Gain range by slightly reducing coverage.
- **(STANDARD):** Match coverage to picture angle.
- **(EVEN COVERAGE PRIORITY):** Slightly increase coverage for more even lighting.

⑦ **LED light:** Choose how the built-in LED light functions during still photography (compatible units only). It can function as a catchlight (**CATCHLIGHT**), as an AF-assist illuminator (**AF/AF ASSIST**), or as both a catchlight and an AF-ASSIST illuminator (**AF/AF ASSIST+CATCHLIGHT**). Choose **OFF** to disable the LED during photography.

⑦ **Number of flashes:** Choose the number of times the flash fires each time the shutter is released in **MULTI** mode.*

⑧ **Frequency:** Choose the frequency at which the flash fires in **MULTI** mode.*

* Full value may not be applied if limits of flash control system are exceeded.

■ MASTER (OPTICAL)



The options at right will be displayed if the unit is currently functioning as master flash for FUJIFILM optical wireless remote flash control.

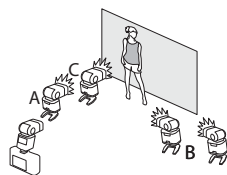

The master and remote units can be placed in up to three groups (A, B, and C) and flash mode and flash level adjusted separately for each group. Four channels are available for communication between the units; separate channels can be used for different flash systems or to prevent interference when multiple systems are operating in close proximity.



- ① **Flash control mode (group A)**/② **Flash control mode (group B)**/
③ **Flash control mode (group C)**: Choose flash control modes for groups A, B, and C. **TTL%** is available for groups A and B only.
- **TTL**: The units in the group fire in TTL mode. Flash compensation can be adjusted separately for each group.
 - **TTL%**: If **TTL%** is selected for either group A or B, you can specify the output of the selected group as a percentage of the other and adjust overall flash compensation for both groups.
 - **M**: In mode **M**, the units in the group fire at the selected output (expressed as a fraction of full power) regardless of subject brightness or camera settings.
 - **MULTI**: Choosing **MULTI** for any group sets all the units in all groups to repeating flash mode. All units will fire multiple times with each shot.
 - **OFF**: If **OFF** is selected, the units in the group will not fire.
- ④ **Flash compensation/output (group A)**/⑤ **Flash compensation/output (group B)**/⑥ **Flash compensation/output (group C)**: Adjust flash level for the selected group according to option selected for flash control mode. Note that the full value may not be applied if the limits of the flash control system are exceeded.
- **TTL**: Adjust flash compensation.
 - **M/MULTI**: Adjust flash output.
 - **TTL%**: Choose the balance between groups A and B and adjust overall flash compensation.
- ⑦ **Flash mode (TTL)**: Choose a flash mode for TTL flash control. The options available vary with the shooting mode (**P**, **S**, **A**, or **M**) selected.
- **⚡TTL (FLASH AUTO)**: The flash fires only as required; flash level is adjusted according to subject brightness. A **⚡** icon displayed when the shutter button is pressed halfway indicates that the flash will fire when the photo is taken.
 - **⚡TTL (STANDARD)**: The flash fires with every shot if possible; flash level is adjusted according to subject brightness. The flash will not fire if not fully charged when the shutter is released.
 - **⚡TTL (SLOW SYNC.)**: Combine the flash with slow shutter speeds when photographing portrait subjects against a backdrop of night scenery. The flash will not fire if not fully charged when the shutter is released.
- ⑧ **Sync**: Control flash timing.
- **⚡FRONT (1ST CURTAIN)**: The flash fires immediately after the shutter opens (generally the best choice).
 - **⚡REAR (2ND CURTAIN)**: The flash fires immediately before the shutter closes.
- ⑨ **Zoom**: The angle of illumination (flash coverage) for units that support flash zoom. Some units allow the adjustment to be made from the camera. Select **AUTO** to automatically match coverage to focal length when using optional conversion lenses.

- ⑩ **Lighting:** If the unit supports this feature, choose from the options below.
-  (**FLASH POWER PRIORITY**): Gain range by slightly reducing coverage.
 -  (**STANDARD**): Match coverage to picture angle.
 -  (**EVEN COVERAGE PRIORITY**): Slightly increase coverage for more even lighting.
- ⑪ **Master:** Assign the master flash to group A (**Gr A**), B (**Gr B**), or C (**Gr C**). If **OFF** is selected, output from the master flash will be held to a level that does not affect the final picture. Available only if the unit is mounted on the camera hot shoe as a master flash for FUJIFILM optical wireless remote flash control in **TTL**, **TTL%**, or **M** mode.
- ⑪ **Number of flashes:** Choose the number of times the flash fires each time the shutter is released in **MULTI** mode.
- ⑪ **Channel:** Choose the channel used by the master flash for communication with the remote flash units. Separate channels can be used for different flash systems or to prevent interference when multiple systems are operating in close proximity.
- ⑫ **Frequency:** Choose the frequency at which the flash fires in **MULTI** mode.

Attaching Adapter Rings

- 1 Remove the front ring.

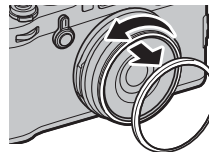

- ❖ If you have trouble removing the front ring, grip the entire ring and rotate it as shown.

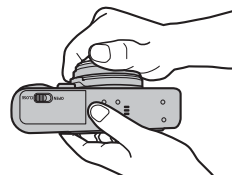

- 2 Attach the adapter ring as shown, with the projections facing out.

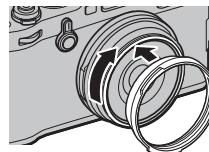

- ① Keep the front ring and lens cap in a safe place when not in use.
- ① Attach the adapter ring AR-X100 before attaching LH-X100 lens hood, PRF-49S protector filter, or third-party filters.

Attaching Lens Hoods

Attach the adapter ring before attaching the lens hood.

- ◆ Align the indentations and rotate as shown.

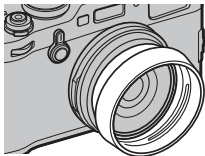
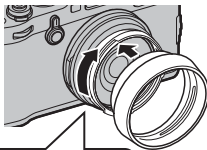
**Attaching Protector Filters**

Attach the adapter ring before attaching the filter.

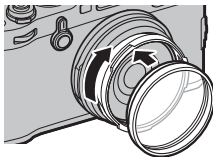
**Using Conversion Lenses****■ Attaching a Conversion Lens**

- 1 Remove the front ring.

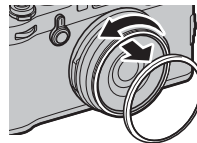

- ◆ If you have trouble removing the front ring, grip the entire ring and rotate it as shown.

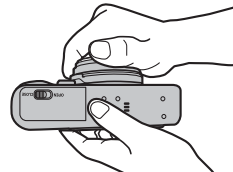

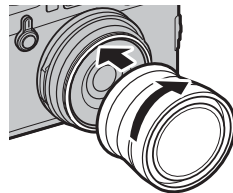

- 2 Attach the conversion lens.



- ⓘ Keep the front ring and lens cap in a safe place when not in use.

■ Using a Conversion Lens

When using an optional WCL-X100 or TCL-X100 conversion lens, select the appropriate option for **SHOOTING SETTING > CONVERSION LENS** in the shooting menu: **WIDE** for the WCL-X100 or **TELE** for the TCL-X100. The camera selects the appropriate option automatically when the WCL-X100II or TCL-X100II is used.

- ◆ An icon ( or ) is displayed when a conversion lens is attached.
- ◆ Because the optical viewfinder does not cover the full field of view of wide conversion lenses, the bright frame is replaced by brackets showing the approximate field of view when a wide conversion lens is attached. For accurate framing, compose pictures using the electronic viewfinder or LCD monitor.
- ◆ The built-in flash may fail to light the entire subject. We recommend using an optional external flash designed for use with this camera.
- ◆ Be sure **OFF** is selected for **CONVERSION LENS** when no conversion lens is attached.

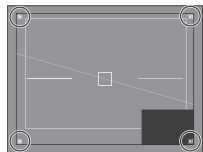

Caring for the Camera

To ensure continued enjoyment of the product, observe the following precautions.

Use and Storage Precautions

If the camera will not be used for an extended period, remove the battery and memory card. Do not store or use the camera in locations that are:

- exposed to rain, steam, or smoke
- very humid or extremely dusty
- exposed to direct sunlight or very high temperatures, such as in a closed vehicle on a very hot day
- extremely cold
- subject to strong vibration
- exposed to strong magnetic fields, such as near a broadcasting antenna, power line, radar emitter, motor, transformer, or magnet
- in contact with volatile chemicals such as pesticides
- in contact with rubber or vinyl products

■ Water and Sand

Exposure to water and sand can also damage the camera and its internal circuitry and mechanisms. When using the camera at the beach or seaside, avoid exposing the camera to water or sand. Do not place the camera on a wet surface.

■ Condensation

Sudden increases in temperature, such as occur when entering a heated building on a cold day, can cause condensation inside the camera. If this occurs, turn the camera off and wait an hour before turning it on again. If condensation forms on the memory card, remove the card and wait for the condensation to dissipate.

Traveling

Keep the camera in your carry-on baggage. Checked baggage may suffer violent shocks that could damage the camera.

Troubleshooting

Problems and Solutions

■ Power and Battery





Problem	Solution
The camera does not turn on.	<ul style="list-style-type: none">• The battery is exhausted: Charge the battery (📖 18) or insert a fully-charged spare battery (📖 20).• The battery is inserted incorrectly: Reinsert in the correct orientation (📖 20).• The battery-chamber cover is not latched: Latch the battery-chamber cover (📖 20).
The monitor does not turn on.	The monitor may not turn on if the camera is turned off and then on again very quickly. Press the shutter button halfway to activate the monitor.
The battery runs down quickly.	<ul style="list-style-type: none">• The battery is cold: Warm the battery by placing it in a pocket or other warm place and reinsert it in the camera immediately before taking a picture.• There is dirt on the battery terminals: Clean the terminals with a soft, dry cloth.• ON is selected for  AF/MF SETTING > PRE-AF: Turn PRE-AF off (📖 94).• The battery has been charged many times: The battery has reached the end of its charging life. Purchase a new battery.
The camera turns off suddenly.	The battery is exhausted: Charge the battery (📖 18) or insert a fully-charged spare battery (📖 20).
Charging does not start.	Reinsert the battery in the correct orientation and make sure that the charger is plugged in (📖 18).
Charging is slow.	Charge the battery at room temperature (📖 v).
The charging lamp blinks, but the battery does not charge.	<ul style="list-style-type: none">• There is dirt on the battery terminals: Clean the terminals with a soft, dry cloth.• The battery has been charged many times: The battery has reached the end of its charging life. Purchase a new battery. If the battery still fails to charge, contact your FUJIFILM dealer.

■ Menus and Displays

Problem	Solution
Display is not in English.	Select ENGLISH for  USER SETTING > 言語/LANG. (📖 26, 115).

■ Shooting

Problem	Solution
No picture is taken when the shutter button is pressed.	<ul style="list-style-type: none"> • The memory card is full: Insert a new memory card or delete pictures (📖 20, 39). • The memory card is not formatted: Format the memory card (📖 114). • There is dirt on the memory card contacts: Clean the contacts with a soft, dry cloth. • The memory card is damaged: Insert a new memory card (📖 20). • The battery is exhausted: Charge the battery (📖 18) or insert a fully-charged spare battery (📖 20). • The camera has turned off automatically: Turn the camera on (📖 24).
Mottling (“noise”) appears in the monitor or viewfinder when the shutter button is pressed halfway.	Gain is increased to aid composition when the subject is poorly lit and aperture is stopped down, which may result in noticeable mottling when images are previewed in the displays. Images taken with the camera are unaffected.
The camera does not focus.	The subject is not suited to autofocus: Use focus lock (📖 80) or manual focus (📖 68).
Intelligent Face Detection is not available.	Intelligent Face Detection is not available in the current shooting mode: Choose a different shooting mode (📖 168).
No face is detected.	<ul style="list-style-type: none"> • The subject’s face is obscured by sunglasses, a hat, long hair, or other objects: Remove the obstructions. • The subject’s face occupies only a small area of the frame: Change the composition so that the subject’s face occupies a larger area of the frame (📖 95). • The subject’s head is tilted or horizontal: Ask the subject to hold their head straight. • The camera is tilted: Keep the camera level. • The subject’s face is poorly lit: Shoot in bright light.
Wrong subject is selected.	The selected subject is closer to the center of the frame than the main subject. Recompose the picture or turn face detection off and frame the picture using focus lock (📖 80).

Problem	Solution
The flash does not fire.	<ul style="list-style-type: none"> • The flash can not be used at current settings: See the list of the settings that can be used with the flash (📖 168). • The battery is exhausted: Charge the battery (📖 18) or insert a fully-charged spare battery (📖 20). • The flash unit does not support the current drive mode: The built-in flash and flash units that do not support burst photography will not fire in continuous mode or when used with exposure or dynamic-range bracketing; select single-frame mode (📖 55). • OFF is selected for  USER SETTING > SOUND & FLASH: Select ON (📖 115).
The flash does not fully light the subject.	<ul style="list-style-type: none"> • The subject is not in range of the flash: Position the subject in range of the flash. • The flash window is obstructed: Hold the camera correctly. • Shutter speed is faster than 1/250 s: Choose a slower shutter speed (📖 50, 53, 82).
Pictures are blurred.	<ul style="list-style-type: none"> • The lens is dirty: Clean the lens (📖 x). • The lens is blocked: Keep objects away from the lens. • !AF is displayed during shooting and the focus frame is displayed in red: Check focus before shooting (📖 34).
Pictures are mottled.	<ul style="list-style-type: none"> • Shutter speed is slow and the ambient temperature is high: This is normal and does not indicate a malfunction. • Pixel mapping is required: Perform pixel mapping using  IMAGE QUALITY SETTING > PIXEL MAPPING (📖 93). • The camera has been used continuously at high temperatures or a temperature warning is displayed: Turn the camera off and wait for it to cool down.
Pictures are distorted.	<ul style="list-style-type: none"> •  or  is displayed: Keep the camera away from magnets.

■ Playback













Problem	Solution
Pictures are grainy.	The pictures were taken with a different make or model of camera.
Playback zoom is unavailable.	The pictures were created using RESIZE or with a different make or model of camera.
No sound in movie playback.	<ul style="list-style-type: none"> • Playback volume is too low: Adjust playback volume (🗨️ 42, 117). • The microphone was obstructed: Hold the camera correctly during recording (🗨️ 2, 40). • The speaker is obstructed: Hold the camera correctly during playback (🗨️ 2, 42). • OFF is selected for  USER SETTING > SOUND & FLASH: Select ON (🗨️ 115).
Selected pictures are not deleted.	Some of the pictures selected for deletion are protected. Remove protection using the device with which it was originally applied (🗨️ 110).
File numbering is unexpectedly reset.	The battery-chamber cover was opened while the camera was on. Turn the camera off before opening the battery-chamber cover (🗨️ 20, 24).

■ Connections/Miscellaneous

For additional information on troubleshooting wireless connections, visit:



<http://digital-cameras.support.fujifilm.com/app?pid=x>

Problem	Solution
Problem connecting or uploading pictures to smartphone.	<ul style="list-style-type: none"> • The smartphone is too far away: Move the devices closer. • Nearby devices are causing radio interference: Move the camera and smartphone away from microwave ovens or cordless phones.
Can not upload images.	<ul style="list-style-type: none"> • The smartphone is connected to another device: The smartphone and camera can connect to only one device at a time. End the connection and try again. • There are several smartphones in the vicinity: Try connecting again. The presence of multiple smartphones can make connection difficult. • The current image is a movie or was created on another device and can not be uploaded to a smartphone.

Problem	Solution
Smartphone will not display pictures.	Select ON for  CONNECTION SETTING > WIRELESS SETTING > RESIZE IMAGE FOR SMARTPHONE  . Selecting OFF increases upload times for larger images; in addition, some phones may not display images over a certain size.
No picture or sound on TV.	<ul style="list-style-type: none"> • The camera is not properly connected: Connect the camera properly ( 139). Note that once the camera is connected, pictures will be displayed on the TV instead of in the camera monitor. • Input on the television is set to "TV": Set input to "HDMI". • The volume on the TV is too low: Use the controls on the television to adjust the volume.
The computer does not recognize the camera.	Be sure the camera and computer are correctly connected ( 133).
Can not transfer RAW or JPEG files to computer.	Use MyFinePix Studio to transfer pictures (Windows only;  132).
The camera is unresponsive.	<ul style="list-style-type: none"> • Temporary camera malfunction: Remove and reinsert the battery ( 20). • The battery is exhausted: Charge the battery ( 18) or insert a fully-charged spare battery ( 20). • The camera is connected to a wireless LAN: End the connection.
The camera does not function as expected.	Remove and reinsert the battery ( 20). If the problem persists, contact your FUJIFILM dealer.
No sound.	<ul style="list-style-type: none"> • Adjust the volume ( 117). • Select ON for  USER SETTING > SOUND & FLASH ( 115).

Warning Messages and Displays

The following warnings appear in the display.

Warning	Description
 (red)	Low battery. Charge the battery (📖 18) or insert a fully-charged spare battery (📖 20).
 (blinks red)	Battery exhausted. Charge the battery (📖 18) or insert a fully-charged spare battery (📖 20).
!AF (displayed in red with red focus frame)	The camera can not focus. Use focus lock to focus on another subject at the same distance, then recompose the picture (📖 80).
Aperture or shutter speed displayed in red	The subject is too bright or too dark and the picture will be over- or under-exposed. Use the flash for additional lighting when taking photographs of poorly-lit subjects (📖 82).
FOCUS ERROR	
TURN OFF THE CAMERA AND TURN ON AGAIN	Camera malfunction. Turn the camera off and then on again. If the message persists, contact a FUJIFILM dealer.
LENS CONTROL ERROR	
BUSY	The memory card is incorrectly formatted. Use the camera to format the card (📖 114).
CARD NOT INITIALIZED	<ul style="list-style-type: none">• The memory card is not formatted or the memory card has been formatted in a computer or other device: Format the memory card using  USER SETTING > FORMAT (📖 114).• The memory card contacts require cleaning: Clean the contacts with a soft, dry cloth. If the message is repeated, format the card (📖 114). If the message persists, replace the card.• Camera malfunction: Contact a FUJIFILM dealer.
PROTECTED CARD	The memory card is locked. Unlock the card.

















Warning	Description
CARD ERROR	<ul style="list-style-type: none"> • The memory card is not formatted for use in the camera: Format the card (📖 114). • The memory card contacts require cleaning or the memory card is damaged: Clean the contacts with a soft, dry cloth. If the message is repeated, format the card (📖 114). If the message persists, replace the card. • Incompatible memory card: Use a compatible card (📖 23). • Camera malfunction: Contact a FUJIFILM dealer.
SD MEMORY FULL	The memory card is full and pictures can not be recorded. Delete pictures (📖 39) or insert a memory card with more free space (📖 20).
NO CARD	The shutter can only be released when a memory card is inserted. Insert a memory card.
WRITE ERROR	<ul style="list-style-type: none"> • Memory card error or connection error: Reinsert the card or turn the camera off and then on again. If the message persists, contact a FUJIFILM dealer. • Not enough memory remaining to record additional pictures: Delete pictures (📖 39) or insert a memory card with more free space (📖 20). • The memory card is not formatted: Format the memory card (📖 114).
READ ERROR	<ul style="list-style-type: none"> • The file is corrupt or was not created with the camera: The file can not be viewed. • The memory card contacts require cleaning: Clean the contacts with a soft, dry cloth. If the message is repeated, format the card (📖 114). If the message persists, replace the card. • Camera malfunction: Contact a FUJIFILM dealer.
FRAME NO. FULL	The camera has run out of frame numbers (current frame number is 999-9999). Format the memory card and select RENEW for SAVE DATA SETTING > FRAME NO. . Take a picture to reset frame numbering to 100-0001, then select CONTINUOUS for FRAME NO. .

Warning	Description
PROTECTED FRAME	An attempt was made to delete or rotate a protected picture. Remove protection and try again (🗨️ 110).
CAN NOT CROP	The picture is damaged or was not created with the camera.
📺 CANNOT EXECUTE	Red-eye removal can not be applied to pictures created with other devices.
🎬 CANNOT EXECUTE	Red-eye removal can not be applied to movies.
CAN NOT ROTATE	The selected picture can not be rotated.
🎬 CAN NOT ROTATE	Movies can not be rotated.
DPOF FILE ERROR	The DPOF print order on the current memory card contains more than 999 images. Copy the pictures to a computer and create a new print order.
CAN NOT SET DPOF	The picture can not be printed using DPOF.
🎬 CAN NOT SET DPOF	Movies can not be printed using DPOF.
!🌡️ (yellow)	Turn the camera off and wait for it to cool. Mottling may increase in pictures taken when this warning is displayed.
!🌡️ (red)	Turn the camera off and wait for it to cool. Display quality and burst rate will drop, and mottling may increase in pictures taken when this warning is displayed.

Appendix

Memory Card Capacity

The following table shows the recording time or number of pictures available at different image sizes. All figures are approximate; file size varies with the scene recorded, producing wide variations in the number of files that can be stored. The number of exposures or length remaining may not diminish at an even rate.

Capacity		8 GB		16 GB	
		 FINE	 NORMAL	 FINE	 NORMAL
Photographs	 3:2	540	800	1110	1660
	RAW (UNCOMPRESSED)	150		320	
	RAW (LOSSLESS COMPRESSED)	300		630	
Movies ¹	 1080/59.94 P ²	26 min.		54 min.	
	 1080/50 P ²				
	 1080/29.97 P ²				
	 1080/25 P ²				
	 1080/24 P ²				
	 1080/23.98 P ²	51 min.		105 min.	
	 720/59.94 P ³				
	 720/50 P ³				
	 720/29.97 P ³				
	 720/25 P ³				
 720/24 P ³	51 min.		105 min.		
 720/23.98 P ³					

1 Use a UHS speed class 1 card or better.

2 Individual movies can not exceed 14 minutes in length.

3 Individual movies can not exceed 28 minutes in length.

Links

For more information on FUJIFILM digital camera, visit the websites listed below.

FUJIFILM X100F Product Information

Optional accessories and support information can be found on the following website.



Firmware Updates

Updates to product firmware may result in changes not described in the manual. For more information, visit:

http://www.fujifilm.com/support/digital_cameras/software



Checking the Firmware Version

① The camera will only display the firmware version if a memory card is inserted.

- 1 Turn the camera off and check that a memory card is inserted.
- 2 Turn the camera on while pressing the **DISP/BACK** button. The current firmware version will be displayed; check the firmware version.
- 3 Turn the camera off.



Specifications

System	
Model	FUJIFILM X100F digital camera
Product Number	FF160004
Effective pixels	Approx. 24.3 million
Image sensor	23.5 mm × 15.6 mm (APS-C), X-Trans CMOS III sensor with primary color filter
Storage media	FUJIFILM-recommended SD/SDHC/SDXC memory cards
File system	Compliant with Design Rule for Camera File System (DCF), Exif 2.3, and Digital Print Order Format (DPOF)
File format	<ul style="list-style-type: none">• Still pictures: Exif 2.3 JPEG (compressed); RAW (original RAF format, uncompressed or compressed using a lossless algorithm; special purpose software required); RAW+JPEG available• Movies: H.264 standard with stereo sound (MOV)
Image size	<ul style="list-style-type: none">• L 3:2: 6,000 × 4,000• M 3:2: 4,240 × 2,832• S 3:2: 3,008 × 2,000• L 16:9: 6,000 × 3,376• M 16:9: 4,240 × 2,384• S 16:9: 3,008 × 1,688• L panorama: 2,160 × 9,600 (vertical) / 9,600 × 1,440 (horizontal)• M panorama: 2,160 × 6,400 (vertical) / 6,400 × 1,440 (horizontal)• L 1:1: 4,000 × 4,000• M 1:1: 2,832 × 2,832• S 1:1: 2,000 × 2,000
Lens	FUJINON fixed focal length lens
Focal length	f=23 mm (35 mm format equivalent: 35 mm)
Maximum aperture	F2.0
Sensitivity	Standard output sensitivity equivalent to ISO 200 – 12800; AUTO; extended output sensitivity equivalent to ISO 100, 25600, or 51200
Metering	256-segment through-the-lens (TTL) metering; MULTI, SPOT, AVERAGE, CENTER WEIGHTED
Exposure control	Programmed AE (with program shift); shutter-priority AE; aperture-priority AE; manual exposure
Exposure compensation	–5 EV – +5 EV in increments of 1/3 EV

System

Shutter speed

- MECHANICAL SHUTTER
 - **P mode:** 4 sec. to $\frac{1}{4,000}$ sec.
 - **Bulb:** Max. 60 min.
 - ELECTRONIC SHUTTER
 - **P, S, A, and M modes:** 30 sec. to $\frac{1}{32,000}$ sec.
 - **Bulb:** Fixed at 1 sec.
 - MECHANICAL + ELECTRONIC
 - **P mode:** 4 sec. to $\frac{1}{32,000}$ sec.
 - **Bulb:** Max. 60 min.
- **Time:** 30 sec. to $\frac{1}{4,000}$ sec.
 - **All other modes:** 30 sec. to $\frac{1}{4,000}$ sec.
- **Time:** 30 sec. to $\frac{1}{32,000}$ sec.
- **Time:** 30 sec. to $\frac{1}{32,000}$ sec.
 - **All other modes:** 30 sec. to $\frac{1}{32,000}$ sec.

Continuous

	Mode	Frame rate (fps)	Frames per burst
	8.0 fps	8.0	Up to approximately 53
	5.0 fps	5.0	Up to approximately 56
	4.0 fps	4.0	Up to approximately 58
	3.0 fps	3.0	Up to approximately 62

- ◆ The frame rate and number of frames per burst may vary depending on the type of memory card used. The figures above are for UHS speed class 1 cards.
- ◆ The frame rate varies with shooting conditions and the number of images recorded.

Focus















- **Mode:** Single or continuous AF; manual focus with focus ring
- **Focus-area selection:** SINGLE POINT, ZONE, WIDE/TRACKING
- **Autofocus system:** Intelligent hybrid AF (TTL contrast-detect/phase-detection AF) with AF-assist illuminator

White balance

Custom 1, Custom 2, Custom 3, color temperature selection, auto, direct sunlight, shade, daylight fluorescent, warm white fluorescent, cool white fluorescent, incandescent, underwater

Self-timer

Off, 2 sec., 10 sec.

System	
Flash	
Mode	<ul style="list-style-type: none"> • MODE: TTL MODE (FLASH AUTO, STANDARD, SLOW SYNC.), MANUAL, COMMANDER, SUPPRESSED FLASH • SYNC. MODE: 1ST CURTAIN, 2ND CURTAIN • RED EYE REMOVAL:  FLASH+REMOVAL,  FLASH,  REMOVAL, OFF
Hot shoe	Accessory shoe with TTL contacts
Hybrid viewfinder	<ul style="list-style-type: none"> • Optical viewfinder (OVF): Reverse Galilean viewfinder with electronic bright frame display and approx. 0.5× magnification; frame coverage approx. 92% • Electronic viewfinder (EVF): 0.48-in., 2,360k-dot color LCD viewfinder with diopter adjustment (−2 to +1 m⁻¹); magnification 0.64× with 50 mm lens (35 mm format equivalent) at infinity and diopter set to −1.0 m⁻¹; diagonal angle of view approximately 32.4° (horizontal angle of view approximately 27.1°); eye point approx. 15 mm
LCD monitor	Fixed 3.0-in/7.6 cm, 1040k-dot color LCD monitor
Movies	<ul style="list-style-type: none"> •  1080/59.94P: Frame size 1,920 × 1,080 (1080p); 59.94 fps; stereo sound •  1080/50P: Frame size 1,920 × 1,080 (1080p); 50 fps; stereo sound •  1080/29.97P: Frame size 1,920 × 1,080 (1080p); 29.97 fps; stereo sound •  1080/25P: Frame size 1,920 × 1,080 (1080p); 25 fps; stereo sound •  1080/24P: Frame size 1,920 × 1,080 (1080p); 24 fps; stereo sound •  1080/23.98P: Frame size 1,920 × 1,080 (1080p); 23.98 fps; stereo sound •  720/59.94P: Frame size 1,280 × 720 (720p); 59.94 fps; stereo sound •  720/50P: Frame size 1,280 × 720 (720p); 50 fps; stereo sound •  720/29.97P: Frame size 1,280 × 720 (720p); 29.97 fps; stereo sound •  720/25P: Frame size 1,280 × 720 (720p); 25 fps; stereo sound •  720/24P: Frame size 1,280 × 720 (720p); 24 fps; stereo sound •  720/23.98P: Frame size 1,280 × 720 (720p); 23.98 fps; stereo sound

Input/output terminals

HDMI output	HDMI Micro connector (Type D)
Digital input/output	USB2.0 High-Speed Micro USB connector (Micro-B)
Microphone/ remote release connector	φ2.5 mm mini-stereo jack

Power supply/other

Power supply	NP-W126S rechargeable battery
Battery life (approximate number of frames that can be taken with a fully-charged battery in mode P , XF 35 mm f/1.4 R lens)	<ul style="list-style-type: none"> • Battery type: NP-W126S (type supplied with camera)

	LCD	EVF	OVF
HIGH PERFORMANCE	260	250	390
STANDARD	280	270	390
ECONOMY	340	330	430

CIPA standard, measured using battery supplied with camera and SD memory card.

Note: Number of shots that can be taken with battery varies with battery charge level and will decline at low temperatures.

Camera size (W × H × D)	126.5 mm × 74.8 mm × 52.4 mm (32.0 mm excluding projections, measured at thinnest part)/5.0 in. × 2.9 in. × 2.1 in. (1.4 in.)
Camera weight	Approx. 419 g/14.8 oz., excluding battery, accessories, and memory card
Shooting weight	Approx. 469 g/16.5 oz., including battery and memory card
Operating conditions	<ul style="list-style-type: none"> • Temperature: 0°C to +40°C/+32°F to +104°F • Humidity: 10% – 80% (no condensation)

Wireless transmitter

Standards	IEEE 802.11b/g/n (standard wireless protocol)
Operating frequency	<ul style="list-style-type: none"> • U. S. A., Canada, Taiwan: 2,412 MHz – 2,462 MHz (11 channels) • Other countries: 2,412 MHz – 2,472 MHz (13 channels)
Maximum radio-frequency power (EIRP)	3.41 dBm
Access protocols	Infrastructure

NP-W126S rechargeable battery

Nominal voltage	7.2V DC
Nominal capacity	1,260 mAh
Operating temperature	0°C to +40°C/+32°F to +104°F
Dimensions (W×H×D)	36.4 mm × 47.1 mm × 15.7 mm/1.4 in. × 1.9 in. × 0.6 in.
Weight	Approx. 47 g/1.7 oz.

BC-W126 battery charger

Rated input	100V – 240V AC, 50/60Hz
Input capacity	13 – 21 VA
Rated output	8.4V DC, 0.6 A
Supported batteries	NP-W126S rechargeable batteries
Charging time	Approx. 150 minutes (+20°C/+68°F)
Operating temperature	+5°C to +40°C/+41°F to +104°F
Dimensions (W×H×D)	65 mm × 91.5 mm × 28 mm/2.6 in. × 3.6 in. × 1.1 in., excluding projections
Weight	Approx. 77 g/2.7 oz., excluding battery

Weight and dimensions vary with the country or region of sale. Labels, menus, and other displays may differ from those on the actual camera.



























■ Notices

- Specifications subject to change without notice; for the latest information, visit http://www.fujifilm.com/products/digital_cameras/index.html. FUJIFILM shall not be held liable for damages resulting from errors in this manual.
- Although the viewfinder and LCD monitor are manufactured using advanced high-precision technology, small bright points and anomalous colors may appear, particularly in the vicinity of text. This is normal for this type of LCD display and does not indicate a malfunction; images recorded with the camera are unaffected.
- Digital cameras may malfunction when exposed to strong radio interference (e.g., electric fields, static electricity, or line noise).
- Due to the type of lens used, some distortion may occur at the periphery of images. This is normal.

Restrictions on Camera Settings







The options available in each shooting mode are listed below. Some options may not be available for the items that are supported in any given mode, and function may be restricted depending on shooting conditions.

Shooting mode/scene position		P	S	A	M		BKT						
FLASH FUNCTION SETTING ³	TTL MODE		✓				✓ ⁶	✓ ⁶	✓ ³	✓ ³			✓ ³
			✓	✓ ¹	✓	✓ ¹	✓ ⁶	✓ ⁶	✓	✓			✓
			✓		✓		✓ ⁶	✓ ⁶	✓ ³	✓ ³			✓ ³
	SYNC. MODE	FRONT & REAR	✓	✓	✓	✓	✓ ⁶	✓ ⁶	✓	✓			✓
			✓	✓	✓	✓	✓ ⁶	✓ ⁶	✓	✓			✓
	M	✓	✓	✓	✓	✓ ⁶	✓ ⁶	✓	✓				✓
		✓	✓	✓	✓	✓ ⁶	✓ ⁶	✓	✓				✓
OFF	✓	✓	✓	✓	✓ ¹	✓	✓	✓		✓ ¹		✓	
RED EYE REMOVAL ³	FLASH+REMOVAL	✓ ³	✓ ³	✓ ³	✓ ³								
	FLASH	✓ ³	✓ ³	✓ ³	✓ ³								
	REMOVAL	✓ ³	✓ ³	✓ ³	✓ ³								
	OFF	✓	✓	✓	✓								✓ ¹
FLASH COMPENSATION		✓	✓	✓	✓			✓	✓				✓ ⁷
SELF-TIMER		✓	✓	✓	✓	✓	✓	✓	✓				✓
EXP. COMPENSATION		✓	✓	✓	✓ ⁵	✓	✓	✓	✓	✓	✓	✓ ²	✓
F		✓ ¹	✓ ¹	✓	✓	✓	✓	✓	✓	✓	✓	✓	✓
S.S.		✓ ¹	✓ ⁴	✓ ¹	✓ ⁴	✓	✓	✓	✓	✓	✓ ³	✓ ³	✓
SHUTTER TYPE	MS (to 1/4,000)	✓	✓	✓	✓	✓	✓	✓	✓	✓	✓ ¹		✓ ⁷
	MS+ES	✓	✓	✓	✓	✓	✓	✓	✓	✓			✓ ⁷
	ES (to 1/32,000)	✓	✓	✓	✓	✓	✓	✓	✓	✓		✓ ¹	✓ ⁷
Program shift		✓				✓	✓	✓	✓				✓ ⁷
AE/AF-LOCK BUTTON	AF LOCK ONLY	✓	✓	✓	✓	✓	✓	✓	✓	✓			✓ ⁷
	AE LOCK ONLY	✓	✓	✓	✓	✓	✓	✓	✓	✓			✓ ⁷
	AE/AF LOCK	✓	✓	✓		✓	✓	✓	✓	✓			✓ ⁷

Shooting mode/scene position		P	S	A	M		BKT					
Sensitivity	AUTO								<input checked="" type="checkbox"/>			<input checked="" type="checkbox"/>
	AUTO1	<input checked="" type="checkbox"/>	<input checked="" type="checkbox"/>	<input checked="" type="checkbox"/>	<input checked="" type="checkbox"/>	<input checked="" type="checkbox"/>		<input checked="" type="checkbox"/>		<input checked="" type="checkbox"/>		<input checked="" type="checkbox"/>
	AUTO2	<input checked="" type="checkbox"/>	<input checked="" type="checkbox"/>	<input checked="" type="checkbox"/>	<input checked="" type="checkbox"/>	<input checked="" type="checkbox"/>		<input checked="" type="checkbox"/>		<input checked="" type="checkbox"/>		<input checked="" type="checkbox"/>
	AUTO3	<input checked="" type="checkbox"/>	<input checked="" type="checkbox"/>	<input checked="" type="checkbox"/>	<input checked="" type="checkbox"/>	<input checked="" type="checkbox"/>		<input checked="" type="checkbox"/>		<input checked="" type="checkbox"/>		<input checked="" type="checkbox"/>
	H (51200)/H (25600)	<input checked="" type="checkbox"/>	<input checked="" type="checkbox"/>	<input checked="" type="checkbox"/>	<input checked="" type="checkbox"/>	<input checked="" type="checkbox"/>	<input checked="" type="checkbox"/>	<input checked="" type="checkbox"/>	<input checked="" type="checkbox"/>			<input checked="" type="checkbox"/>
	12800	<input checked="" type="checkbox"/>	<input checked="" type="checkbox"/>	<input checked="" type="checkbox"/>	<input checked="" type="checkbox"/>	<input checked="" type="checkbox"/>	<input checked="" type="checkbox"/>	<input checked="" type="checkbox"/>		<input checked="" type="checkbox"/>		<input checked="" type="checkbox"/>
	6400 – 1000	<input checked="" type="checkbox"/>	<input checked="" type="checkbox"/>	<input checked="" type="checkbox"/>	<input checked="" type="checkbox"/>	<input checked="" type="checkbox"/>	<input checked="" type="checkbox"/>	<input checked="" type="checkbox"/>		<input checked="" type="checkbox"/>		<input checked="" type="checkbox"/>
	800	<input checked="" type="checkbox"/>	<input checked="" type="checkbox"/>	<input checked="" type="checkbox"/>	<input checked="" type="checkbox"/>	<input checked="" type="checkbox"/>	<input checked="" type="checkbox"/>	<input checked="" type="checkbox"/>		<input checked="" type="checkbox"/>		<input checked="" type="checkbox"/>
640 – 200	<input checked="" type="checkbox"/>	<input checked="" type="checkbox"/>	<input checked="" type="checkbox"/>	<input checked="" type="checkbox"/>	<input checked="" type="checkbox"/>	<input checked="" type="checkbox"/>	<input checked="" type="checkbox"/>	<input checked="" type="checkbox"/>			<input checked="" type="checkbox"/>	
L (100)	<input checked="" type="checkbox"/>	<input checked="" type="checkbox"/>	<input checked="" type="checkbox"/>	<input checked="" type="checkbox"/>	<input checked="" type="checkbox"/>	<input checked="" type="checkbox"/>	<input checked="" type="checkbox"/>				<input checked="" type="checkbox"/>	
IMAGE SIZE		<input checked="" type="checkbox"/>	<input checked="" type="checkbox"/>	<input checked="" type="checkbox"/>	<input checked="" type="checkbox"/>	<input checked="" type="checkbox"/>	<input checked="" type="checkbox"/>	<input checked="" type="checkbox"/>	<input checked="" type="checkbox"/>			<input checked="" type="checkbox"/>
		<input checked="" type="checkbox"/>	<input checked="" type="checkbox"/>	<input checked="" type="checkbox"/>	<input checked="" type="checkbox"/>	<input checked="" type="checkbox"/>	<input checked="" type="checkbox"/>	<input checked="" type="checkbox"/>	<input checked="" type="checkbox"/>	<input checked="" type="checkbox"/>		<input checked="" type="checkbox"/>
		<input checked="" type="checkbox"/>	<input checked="" type="checkbox"/>	<input checked="" type="checkbox"/>	<input checked="" type="checkbox"/>	<input checked="" type="checkbox"/>	<input checked="" type="checkbox"/>	<input checked="" type="checkbox"/>	<input checked="" type="checkbox"/>	<input checked="" type="checkbox"/>		<input checked="" type="checkbox"/>
IMAGE QUALITY	FINE/NORMAL	<input checked="" type="checkbox"/>	<input checked="" type="checkbox"/>	<input checked="" type="checkbox"/>	<input checked="" type="checkbox"/>	<input checked="" type="checkbox"/>	<input checked="" type="checkbox"/>	<input checked="" type="checkbox"/>	<input checked="" type="checkbox"/>	<input checked="" type="checkbox"/>		<input checked="" type="checkbox"/>
	RAW	<input checked="" type="checkbox"/>	<input checked="" type="checkbox"/>	<input checked="" type="checkbox"/>	<input checked="" type="checkbox"/>	<input checked="" type="checkbox"/>	<input checked="" type="checkbox"/>					<input checked="" type="checkbox"/>
RAW RECORDING	UNCOMPRESSED	<input checked="" type="checkbox"/>	<input checked="" type="checkbox"/>	<input checked="" type="checkbox"/>	<input checked="" type="checkbox"/>	<input checked="" type="checkbox"/>	<input checked="" type="checkbox"/>					<input checked="" type="checkbox"/>
	LOSSLESS COMPRESSED	<input checked="" type="checkbox"/>	<input checked="" type="checkbox"/>	<input checked="" type="checkbox"/>	<input checked="" type="checkbox"/>	<input checked="" type="checkbox"/>	<input checked="" type="checkbox"/>					<input checked="" type="checkbox"/>
DYNAMIC RANGE	AUTO	<input checked="" type="checkbox"/>	<input checked="" type="checkbox"/>	<input checked="" type="checkbox"/>	<input checked="" type="checkbox"/>	<input checked="" type="checkbox"/>	<input checked="" type="checkbox"/>		<input checked="" type="checkbox"/>	<input checked="" type="checkbox"/>		<input checked="" type="checkbox"/>
	 /  / 	<input checked="" type="checkbox"/>	<input checked="" type="checkbox"/>	<input checked="" type="checkbox"/>	<input checked="" type="checkbox"/>	<input checked="" type="checkbox"/>	<input checked="" type="checkbox"/>	<input checked="" type="checkbox"/>	<input checked="" type="checkbox"/>	<input checked="" type="checkbox"/>		<input checked="" type="checkbox"/>
FILM SIMULATION		<input checked="" type="checkbox"/>	<input checked="" type="checkbox"/>	<input checked="" type="checkbox"/>	<input checked="" type="checkbox"/>	<input checked="" type="checkbox"/>	<input checked="" type="checkbox"/>	<input checked="" type="checkbox"/>	<input checked="" type="checkbox"/>	<input checked="" type="checkbox"/>		<input checked="" type="checkbox"/>
	 /  / 	<input checked="" type="checkbox"/>	<input checked="" type="checkbox"/>	<input checked="" type="checkbox"/>	<input checked="" type="checkbox"/>	<input checked="" type="checkbox"/>	<input checked="" type="checkbox"/>	<input checked="" type="checkbox"/>		<input checked="" type="checkbox"/>		<input checked="" type="checkbox"/>
	 / 	<input checked="" type="checkbox"/>	<input checked="" type="checkbox"/>	<input checked="" type="checkbox"/>	<input checked="" type="checkbox"/>	<input checked="" type="checkbox"/>	<input checked="" type="checkbox"/>	<input checked="" type="checkbox"/>		<input checked="" type="checkbox"/>		<input checked="" type="checkbox"/>
	 /  /  / 	<input checked="" type="checkbox"/>	<input checked="" type="checkbox"/>	<input checked="" type="checkbox"/>	<input checked="" type="checkbox"/>	<input checked="" type="checkbox"/>	<input checked="" type="checkbox"/>	<input checked="" type="checkbox"/>	<input checked="" type="checkbox"/>		<input checked="" type="checkbox"/>	<input checked="" type="checkbox"/>
	 /  /  / 	<input checked="" type="checkbox"/>	<input checked="" type="checkbox"/>	<input checked="" type="checkbox"/>	<input checked="" type="checkbox"/>	<input checked="" type="checkbox"/>	<input checked="" type="checkbox"/>	<input checked="" type="checkbox"/>	<input checked="" type="checkbox"/>		<input checked="" type="checkbox"/>	<input checked="" type="checkbox"/>
		<input checked="" type="checkbox"/>	<input checked="" type="checkbox"/>	<input checked="" type="checkbox"/>	<input checked="" type="checkbox"/>	<input checked="" type="checkbox"/>	<input checked="" type="checkbox"/>	<input checked="" type="checkbox"/>		<input checked="" type="checkbox"/>		<input checked="" type="checkbox"/>
GRAIN EFFECT	<input checked="" type="checkbox"/>	<input checked="" type="checkbox"/>	<input checked="" type="checkbox"/>	<input checked="" type="checkbox"/>	<input checked="" type="checkbox"/>	<input checked="" type="checkbox"/>	<input checked="" type="checkbox"/>		<input checked="" type="checkbox"/>		<input checked="" type="checkbox"/>	
WHITE BALANCE	<input checked="" type="checkbox"/>	<input checked="" type="checkbox"/>	<input checked="" type="checkbox"/>	<input checked="" type="checkbox"/>	<input checked="" type="checkbox"/>	<input checked="" type="checkbox"/>	<input checked="" type="checkbox"/>	<input checked="" type="checkbox"/>	<input checked="" type="checkbox"/>		<input checked="" type="checkbox"/>	
DIGITAL TELE-CONV. (50mm/70mm)	<input checked="" type="checkbox"/>	<input checked="" type="checkbox"/>	<input checked="" type="checkbox"/>	<input checked="" type="checkbox"/>								
CONVERSION LENS (WIDE/TELE)	<input checked="" type="checkbox"/>	<input checked="" type="checkbox"/>	<input checked="" type="checkbox"/>	<input checked="" type="checkbox"/>		<input checked="" type="checkbox"/>	<input checked="" type="checkbox"/>	<input checked="" type="checkbox"/>	<input checked="" type="checkbox"/>		<input checked="" type="checkbox"/>	
FACE DETECTION	<input checked="" type="checkbox"/>	<input checked="" type="checkbox"/>	<input checked="" type="checkbox"/>	<input checked="" type="checkbox"/>	<input checked="" type="checkbox"/>	<input checked="" type="checkbox"/>	<input checked="" type="checkbox"/>	<input checked="" type="checkbox"/>			<input checked="" type="checkbox"/>	
EYE DETECTION AF	<input checked="" type="checkbox"/>	<input checked="" type="checkbox"/>	<input checked="" type="checkbox"/>	<input checked="" type="checkbox"/>	<input checked="" type="checkbox"/>	<input checked="" type="checkbox"/>	<input checked="" type="checkbox"/>	<input checked="" type="checkbox"/>				

Restrictions on Camera Settings

Shooting mode/scene position		P	S	A	M		BKT						
PHOTOMETRY		✓	✓	✓	✓	✓	✓	✓	✓	✓ ¹	✓ ¹	✓ ¹	✓ ⁷
		✓	✓	✓	✓	✓	✓	✓	✓				✓ ⁷
		✓	✓	✓	✓	✓	✓	✓	✓				✓ ⁷
		✓	✓	✓	✓	✓	✓	✓	✓				✓ ⁷
Focus mode	S	✓	✓	✓	✓	✓	✓	✓	✓	✓ ¹	✓	✓	✓ ⁷
	C	✓	✓	✓	✓	✓	✓	✓	✓		✓	✓	
	M	✓	✓	✓	✓	✓	✓	✓	✓		✓	✓	✓ ⁷
AF MODE		✓	✓	✓	✓	✓	✓	✓	✓	✓	✓ ¹		✓ ¹
		✓	✓	✓	✓	✓	✓	✓	✓	✓			
		✓	✓	✓	✓	✓	✓	✓	✓	✓			
MOVIE AF MODE												✓	
												✓	
MF ASSIST	STANDARD	✓	✓	✓	✓	✓	✓	✓	✓ ¹		✓ ¹		
	DIGITAL SPLIT IMAGE	✓	✓	✓	✓	✓	✓	✓					
	FOCUS PEAK HIGHLIGHT	✓	✓	✓	✓	✓	✓	✓					
INTERLOCK SPOT AE & FOCUS AREA		✓	✓	✓	✓	✓	✓	✓					✓ ⁷
AF+MF		✓	✓	✓	✓	✓	✓	✓			✓		
AF ILLUMINATOR		✓	✓	✓	✓	✓	✓	✓	✓	✓		✓	✓ ⁷
COLOR		✓	✓	✓	✓	✓	✓	✓	✓				✓ ⁷
SHARPNESS		✓	✓	✓	✓	✓	✓	✓	✓				✓ ⁷
HIGHLIGHT TONE		✓	✓	✓	✓	✓	✓	✓	✓				✓ ⁷
SHADOW TONE		✓	✓	✓	✓	✓	✓	✓	✓				✓ ⁷
NOISE REDUCTION		✓	✓	✓	✓	✓	✓	✓	✓				✓ ⁷
LONG EXPOSURE NR		✓	✓	✓	✓	✓	✓	✓	✓	✓			✓ ⁷
SELECT CUSTOM SETTING EDIT/SAVE CUSTOM SETTING		✓	✓	✓	✓	✓	✓	✓					
PREVIEW EXP./WB IN MANUAL MODE					✓	✓	✓	✓	✓	✓	✓		✓ ⁷
FOCUS CHECK	AF ¹¹	✓ ¹⁰	✓ ¹⁰	✓ ¹⁰	✓ ¹⁰	✓ ¹⁰	✓ ¹⁰	✓ ¹⁰	✓ ¹⁰	✓ ¹⁰			
	MF ¹¹	✓	✓	✓	✓	✓	✓	✓	✓				

Shooting mode/scene position		P	S	A	M		BKT					
DISP. CUSTOM SETTING	FRAMING GUIDELINE	✓	✓	✓	✓	✓	✓	✓	✓			
	ELECTRONIC LEVEL	✓	✓	✓	✓	✓	✓	✓	✓		✓	
	FOCUS FRAME	✓	✓	✓	✓	✓	✓	✓	✓			
	AF DISTANCE INDICATOR	✓	✓	✓	✓	✓	✓	✓	✓			
	MF DISTANCE INDICATOR	✓	✓	✓	✓	✓	✓	✓			✓	
	HISTOGRAM	✓	✓	✓	✓	✓	✓	✓				
	SHOOTING MODE	✓	✓	✓	✓	✓	✓	✓	✓	✓	✓	✓
	APERTURE/S-SPEED/ISO	✓	✓	✓	✓	✓	✓	✓	✓	✓	✓	✓
	INFORMATION BACKGROUND	✓	✓	✓	✓	✓	✓	✓	✓	✓	✓	✓
	Expo. Comp. (Digit)	✓	✓	✓	✓	✓	✓	✓	✓	✓	✓	✓
	Expo. Comp. (Scale)	✓	✓	✓	✓	✓	✓	✓	✓	✓	✓	✓
	FOCUS MODE	✓	✓	✓	✓	✓	✓	✓	✓		✓	✓
	PHOTOMETRY	✓	✓	✓	✓	✓	✓	✓				
	SHUTTER TYPE	✓	✓	✓	✓	✓	✓	✓	✓			
	FLASH	✓	✓	✓	✓	✓	✓	✓	✓	✓		
	CONTINUOUS MODE	✓	✓	✓	✓	✓	✓	✓				
	WHITE BALANCE	✓	✓	✓	✓	✓	✓	✓		✓	✓	
	FILM SIMULATION	✓	✓	✓	✓	✓	✓	✓		✓	✓	
	DYNAMIC RANGE	✓	✓	✓	✓	✓	✓	✓	✓	✓	✓	
	FRAMES REMAINING	✓	✓	✓	✓	✓	✓	✓	✓	✓	✓	
IMAGE SIZE/QUALITY	✓	✓	✓	✓	✓	✓	✓	✓	✓	✓		
MOVIE MODE & REC. TIME	✓	✓	✓	✓	✓	✓	✓	✓	✓	✓	✓	
DIGITAL TELE-CONV.	✓	✓	✓	✓								
CONVERSION LENS	✓	✓	✓	✓	✓	✓	✓	✓	✓	✓	✓	
BATTERY LEVEL	✓	✓	✓	✓	✓	✓	✓	✓	✓	✓	✓	
FRAMING OUTLINE ¹³	✓	✓	✓	✓	✓	✓	✓	✓	✓	✓	✓	
COLOR SPACE	✓	✓	✓	✓	✓	✓	✓	✓	✓	✓	✓ ¹²	✓ ⁷

1 Fixed automatically.

2 Restricted to range of ± 2.0 EV during movie recording.

3 Options available vary with shooting mode.

4 **A** is not available.

5 Available only with auto ISO sensitivity.

6 Available only with optional flash units that support burst mode. Not available with the built-in flash.

7 Still photography settings are used.

8 The flash can not be used with the electronic shutter. Available when an option other than **OFF** is selected for **RED EYE REMOVAL** and **FACE DETECTION** is on.

9 Wireless remote photography.

10 Available only when **AF-S** is selected for focus mode and **SINGLE POINT** is selected for **AF MODE**.

11 Disabled automatically during interval timer photography.

12 sRGB selected automatically.

13 Available only in the LCD/EVF display.

FUJIFILM

FUJIFILM Corporation

7-3, AKASAKA 9-CHOME, MINATO-KU, TOKYO 107-0052, JAPAN

http://www.fujifilm.com/products/digital_cameras/index.html