

DIGITAL CAMERA XF1

Owner's Manual

Thank you for your purchase of this product. This manual describes how to use your FUJIFILM digital camera and the supplied software. Be sure that you have read and understood its contents and the warnings in "For Your Safety" (📖 ii) before using the camera.

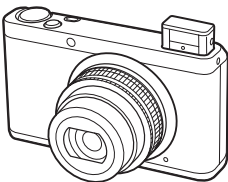

For information on related products, visit our website at http://www.fujifilm.com/products/digital_cameras/index.html

Before You Begin

First Steps

Basic Photography and Playback

More on Photography

More on Playback

Movies

Connections

Menus

Technical Notes

Troubleshooting

Appendix



IMPORTANT SAFETY INSTRUCTIONS

- **Read Instructions:** All the safety and operating instructions should be read before the appliance is operated.
- **Retain Instructions:** The safety and operating instructions should be retained for future reference.
- **Heed Warnings:** All warnings on the appliance and in the operating instructions should be adhered to.
- **Follow Instructions:** All operating and use instructions should be followed.

Installation

Power Sources: This video product should be operated only from the type of power source indicated on the marking label. If you are not sure of the type of power supply to your home, consult your appliance dealer or local power company. For video products intended to operate from battery power, or other sources, refer to the operating instructions.

Grounding or Polarization: This video product is equipped with a polarized alternating-current line plug (a plug having one blade wider than the other). This plug will fit into the power outlet only one way. This is a safety feature. If you are unable to insert the plug fully into the outlet, try reversing the plug. If the plug should still fail to fit, contact your electrician to replace your obsolete outlet. Do not defeat the safety purpose of the polarized plug.

Alternate Warnings: This video product is equipped with a three-wire grounding-type plug, a plug having a third (grounding) pin. This plug will only fit into a grounding-type power outlet. This is a safety feature. If you are unable to insert the plug into the outlet, contact your electrician to replace your obsolete outlet. Do not defeat the safety purpose of the grounding type plug.

Overloading: Do not overload wall outlets and extension cords as this can result in a risk of fire or electric shock.

Ventilation: Slots and openings in the cabinet are provided for ventilation, to ensure reliable operation of the video product and to protect it from overheating, and these openings must not be blocked or covered. The openings should never be blocked by placing the video product on a bed, sofa, rug, or other similar surface.

This video product should not be placed in a built-in installation such as a bookcase or rack unless proper ventilation is provided or the manufacturer's instructions have been adhered to. This video product should never be placed near or over a radiator or heat register.

Attachments: Do not use attachments not recommended by the video product manufacturer as they may cause hazards.

Water and Moisture: Do not use this video product near water—for example, near a bath tub, wash bowl, kitchen sink, or laundry tub, in a wet basement, or near a swimming pool, and the like.

Power-Cord Protection: Power-supply cords should be routed so that they are not likely to be walked on or pinched by items placed upon or against them, paying particular attention to cords at plugs, convenience receptacles, and the point where they exit from the appliance.

Accessories: Do not place this video product on an unstable cart, stand, tripod, bracket, or table. The video product may fall, causing serious injury to a child or adult, and serious damage to the appliance. Use only with a cart, stand, tripod, bracket, or table recommended by the manufacturer, or sold with the video product. Any mounting of the appliance should follow the manufacturer's instructions, and should use a mounting accessory recommended by the manufacturer.

An appliance and cart combination should be moved with care. Quick stops, excessive force, and uneven surfaces may cause the appliance and cart combination to overturn.



Antennas

Outdoor Antenna Grounding: If an outside antenna or cable system is connected to the video product, be sure the antenna or cable system is grounded so as to provide some protection against voltage surges and built-up static charges. Section 810 of the National Electrical Code, ANSI/NFPA No. 70, provides information with respect to proper grounding of the mast and supporting structure, grounding of the lead-in wire to an antenna discharge unit, size of grounding conductors, location of antenna discharge unit, connection to grounding electrodes, and requirements for the grounding electrode.

EXAMPLE OF ANTENNA GROUNDING AS PER NATIONAL ELECTRICAL CODE

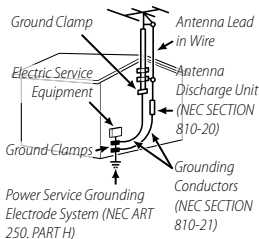

Power Lines: An outside antenna system should not be located in the vicinity of overhead power lines or other electric light or power circuits, or where it can fall into such power lines or circuits. When installing an outside antenna system, extreme care should be taken to keep from touching such power lines or circuits as contact with them might be fatal.

Use

Cleaning: Unplug this video product from the wall outlet before cleaning. Do not use liquid cleaners or aerosol cleaners. Use a damp cloth for cleaning.

Object and Liquid Entry: Never push objects of any kind into this video product through openings as they may touch dangerous voltage points or short out parts that could result in a fire or electric shock. Never spill liquid of any kind on the video product.

Lightning: For added protection for this video product receiver during a lightning storm, or when it is left unattended and unused for long periods of time, unplug it from the wall outlet and disconnect the antenna or cable system. This will prevent damage to the video product due to lightning and power-line surges.

Service

Servicing: Do not attempt to service this video product yourself as opening or removing covers may expose you to dangerous voltage or other hazards. Refer all servicing to qualified service personnel.

Damage Requiring Service: Unplug this video product from the wall outlet and refer servicing to qualified service personnel under the following conditions:

- When the power-supply cord or plug is damaged.
- If liquid has been spilled, or objects have fallen into the video product.
- If the video product has been exposed to rain or water.
- If the video product has been dropped or the cabinet has been damaged.

If the video product does not operate nor-

mally follow the operating instructions. Ad-just only those controls that are covered by the operating instructions as an improper adjustment of other controls may result in damage and will often require extensive work by a qualified technician to restore the video product to its normal operation.

When the video product exhibits a distinct change in performance—this indicates a need for service.

Replacement Parts: When replacement parts are required, be sure the service technician has used replacement parts specified by the manufacturer or have the same characteristics as the original part. Unauthorized substitutions may result in fire, electric shock or other hazards.

Safety Check: Upon completion of any service or repairs to this video product, ask the service technician to perform safety checks to determine that the video product is in proper operating condition.

Be sure to read these notes before use

Safety Notes

- Make sure that you use your camera correctly. Read these safety notes and your *Owner's Manual* carefully before use.
- After reading these safety notes, store them in a safe place.

About the Icons

The icons shown below are used in this document to indicate the severity of the injury or damage that can result if the information indicated by the icon is ignored and the product is used incorrectly as a result.



This icon indicates that death or serious injury can result if the information is ignored.



This icon indicates that personal injury or material damage can result if the information is ignored.

The icons shown below are used to indicate the nature of the instructions which are to be observed.



Triangular icons tell you that this information requires attention ("Important").



Circular icons with a diagonal bar tell you that the action indicated is prohibited ("Prohibited").



Filled circles with an exclamation mark indicate an action that must be performed ("Required").

! WARNING



If a problem arises, turn the camera off, remove the battery, and disconnect and unplug the AC power adapter. Continued use of the camera when it is emitting smoke, is emitting any unusual odor, or is in any other abnormal state can cause a fire or electric shock. Contact your FUJIFILM dealer.



Do not allow water or foreign objects to enter the camera. If water or foreign objects get inside the camera, turn the camera off, remove the battery, and disconnect and unplug the AC power adapter. Continued use of the camera can cause a fire or electric shock. Contact your FUJIFILM dealer.

! WARNING



Do not use the camera in the bathroom or shower. This can cause a fire or electric shock.



Never attempt to change or take apart the camera (never open the case). Failure to observe this precaution can cause fire or electric shock.



Should the case break open as the result of a fall or other accident, do not touch the exposed parts. Failure to observe this precaution could result in electric shock or in injury from touching the damaged parts. Remove the battery immediately, taking care to avoid injury or electric shock, and take the product to the point of purchase for consultation.



Do not change, heat or unduly twist or pull the connection cord and do not place heavy objects on the connection cord. These actions could damage the cord and cause a fire or electric shock. If the cord is damaged, contact your FUJIFILM dealer.



Do not place the camera on an unstable surface. This can cause the camera to fall or tip over and cause injury.



Never attempt to take pictures while in motion. Do not use the camera while you are walking or driving a vehicle. This can result in you falling down or being involved in a traffic accident.



Do not touch any metal parts of the camera during a thunderstorm. This can cause an electric shock due to induced current from the lightning discharge.



Do not use the battery except as specified. Load the battery as shown by the indicator.



Do not heat, change or take apart the battery. Do not drop or subject the battery to impacts. Do not store the battery with metallic products. Any of these actions can cause the battery to burst or leak and cause fire or injury as a result.



Use only the battery or AC power adapters specified for use with this camera. Do not use voltages other than the power supply voltage shown. The use of other power sources can cause a fire.



If the battery leaks and fluid gets in contact with your eyes, skin or clothing, flush the affected area with clean water and seek medical attention or call an emergency number right away.

 **WARNING**

Do not use the charger to charge batteries other than those specified here. The supplied battery charger is for use only with the type of battery supplied with the camera. Using the charger to charge conventional batteries or other types of rechargeable batteries can cause the battery to leak fluid, overheat or burst.



Danger of explosion if battery is incorrectly replaced. Replace only with the same or equivalent type.



Do not use in the presence of flammable objects, explosive gases, or dust.



When carrying the battery, install it in a digital camera or keep it in the hard case. When storing the battery, keep it in the hard case. When discarding, cover the battery terminals with insulation tape. Contact with other metallic objects or batteries could cause the battery to ignite or burst.



Keep memory cards out of the reach of small children. Because memory cards are small, they can be swallowed by children. Be sure to store memory cards out of the reach of small children. If a child swallows a memory card, seek medical attention or call an emergency number.



Turn the camera off in crowds. The camera emits radio-frequency radiation that may interfere with pacemakers.



Turn the camera off in the vicinity of automatic doors, public address systems, and other automatically controlled devices. The camera emits radio-frequency radiation that may cause these devices to malfunction.



Keep the camera at least 22 cm away from people wearing pacemakers. The camera emits radio-frequency radiation that may interfere with pacemakers.

 **CAUTION**

Do not use this camera in locations affected by oil fumes, steam, humidity or dust. This can cause a fire or electric shock.



Do not leave this camera in places subject to extremely high temperatures. Do not leave the camera in locations such as a sealed vehicle or in direct sunlight. This can cause a fire.



Keep out of the reach of small children. This product could cause injury in the hands of a child.

 **CAUTION**

Do not place heavy objects on the camera. This can cause the heavy object to tip over or fall and cause injury.



Do not move the camera while the AC power adapter is still connected. Do not pull on the connection cord to disconnect the AC power adapter. This can damage the power cord or cables and cause a fire or electric shock.



Do not use the AC power adapter when the plug is damaged or the plug socket connection is loose. This could cause a fire or electric shock.



Do not cover or wrap the camera or the AC power adapter in a cloth or blanket. This can cause heat to build up and distort the casing or cause a fire.



When you are cleaning the camera or you do not plan to use the camera for an extended period, remove the battery and disconnect and unplug the AC power adapter. Failure to do so can cause a fire or electric shock.



Unplugging from power socket

When charging ends, unplug the charger from the power socket. Leaving the charger plugged into the power socket can cause a fire.



Using a flash too close to a person's eyes may temporarily affect the eyesight. Take particular care when photographing infants and young children.



When a memory card is removed, the card could come out of the slot too quickly. Use your finger to hold it and gently release the card. Injury could result to those struck by the ejected card.



Request regular internal testing and cleaning for your camera. Build-up of dust in your camera can cause a fire or electric shock. Contact your FUJIFILM dealer to request internal cleaning every two years. Please note that this service is not free of charge.



Remove your fingers from the flash window before the flash fires. Failure to observe this precaution could result in burns.



Keep the flash window clean and do not use the flash if the window is obstructed. Failure to observe these precautions could cause smoke or discoloration.

The Battery and Power Supply

Note: Check the type of battery used in your camera and read the appropriate sections.

The following describes the proper use of batteries and how to prolong their life. Incorrect use can shorten battery life or cause leakage, overheating, fire, or explosion.

Li-ion Batteries

Read this section if your camera uses a rechargeable Li-ion battery.

The battery is not charged at shipment. Charge the battery before use. Keep the battery in its case when not in use.

Notes on the Battery

The battery gradually loses its charge when not in use. Charge the battery one or two days before use.

Battery life can be extended by turning the camera off when not in use.

Battery capacity decreases at low temperatures; a depleted battery may not function at when cold. Keep a fully charged spare battery in a warm place and exchange as necessary, or keep the battery in your pocket or other warm place and insert it in the camera only when shooting. Do not place the battery in direct contact with hand warmers or other heating devices.

Charging the Battery

Charge the battery in the supplied battery charger. Charging times will increase at ambient temperatures below +10°C (+50°F) or above +35°C (+95°F). Do not attempt to charge the battery at temperatures above 40°C (+104°F); at temperatures below 0°C (+32°F), the battery will not charge.

Do not attempt to recharge a fully charged battery. The battery does not however need to be fully discharged before charging.

The battery may be warm to the touch immediately after charging or use. This is normal.

Battery Life

At normal temperatures, the battery can be recharged about 300 times. A noticeable decrease in the length of time the battery will hold a charge indicates that it has reached the end of its service life and should be replaced.

Storage

Performance may be impaired if the battery is left unused for extended periods when fully charged. Run the battery flat before storing it.

If the camera will not be used for an extended period, remove the battery and store it in a dry place with an ambient temperature of from +15°C to +25°C (+59°F to +77°F). Do not store in locations exposed to extremes of temperature.

Cautions: Handling the Battery

- Do not transport or store with metal objects such as necklaces or hairpins.
- Do not expose to flame or heat.
- Do not disassemble or modify.
- Use with designated chargers only.
- Do not drop or subject to strong physical shocks.
- Do not expose to water.
- Keep the terminals clean.
- The battery and camera body may become warm to the touch after extended use. This is normal.

AA Alkaline/Rechargeable Ni-MH Batteries

Read this section if your camera uses AA alkaline or rechargeable AA Ni-MH batteries. Information on compatible battery types may be found elsewhere in the camera manual.

Cautions: Handling the Batteries

- Do not expose to water, flame, or heat, or store in warm or humid conditions.
- Do not transport or store with metal objects such as necklaces or hairpins.
- Do not disassemble or modify the batteries or battery casing.
- Do not subject to strong physical shocks.
- Do not use batteries that are leaking, deformed, or discolored.
- Keep out of reach of infants and small children.
- Insert in the correct orientation.

- Do not mix old and new batteries, batteries with different charge levels, or batteries of different types.
- If the camera will not be used for an extended period, remove the batteries. Note that the camera clock will be reset.
- The batteries may not be used for the touch immediately after use. Turn the camera off and allow the batteries to cool before handling.
- Battery capacity tends to decrease at low temperatures. Keep spare batteries in a pocket or other warm place and exchange as necessary. Cold batteries may recover some of their charge when warmed.
- Fingerprints and other stains on the battery terminals can impair battery performance. Thoroughly clean the terminals with a soft, dry cloth before inserting them in the camera.



If the batteries leak, clean the battery compartment thoroughly before inserting new batteries.



If fluid from the battery comes into contact with skin or clothing, flush the affected area with water. ***If fluid enters your eyes, immediately flush the affected area with water and seek medical attention. Do not rub your eyes. Failure to observe this precaution could result in permanent visual impairment.***

■ Ni-MH Batteries

The capacity of Ni-MH batteries may be temporarily reduced when new, after long periods of disuse, or if they are repeatedly recharged before being fully discharged. This is normal and does not indicate a malfunction. Capacity can be increased by repeatedly discharging the batteries using the discharge option in the camera setup menu and recharging them using a battery charger.

ⓘ **CAUTION:** Do not use the discharge option with alkaline batteries.

The camera draws a small amount of current even when off. Ni-MH batteries that have been left in the camera for an extended period may be drawn down to the point that they no longer hold a charge. Battery performance may also drop if the batteries are run down in a device such as a flashlight. Use the discharge option in the camera setup menu to discharge Ni-MH batteries. Batteries that no longer hold a charge even after repeatedly being discharged and recharged have reached the end of their service life and must be replaced.

Ni-MH batteries can be recharged in a battery charger (sold separately). Batteries may become warm to the touch after charging. Refer to the instructions provided with the charger for more information. Use the charger with compatible batteries only.

Ni-MH batteries gradually lose their charge when not in use.

■ Disposal

Dispose of used batteries in accord with local regulations.

AC Power Adapters (Available Separately)

This section applies to all camera models. Use only FUJIFILM AC power adapters designated for use with this camera. Other adapters could damage the camera.

- The AC power adapter is for indoor use only.
- Be sure the DC plug is securely connected to the camera.
- Turn the camera off before disconnecting the adapter. Disconnect the adapter by the plug, not the cable.
- Do not use with other devices.
- Do not disassemble.
- Do not expose to high heat and humidity.
- Do not subject to strong physical shocks.
- The adapter may hum or become hot to the touch during use. This is normal.
- If the adapter causes radio interference, reorient or relocate the receiving antenna.

Using the Camera

Do not aim the camera at extremely bright light sources, such as the sun in a cloudless sky. Failure to observe this precaution could damage the camera image sensor.

Take Test Shots

Before taking photographs on important occasions (such as at weddings or before taking the camera on a trip), take a test shot and view the result in the LCD monitor to ensure that the camera is functioning normally. FUJIFILM Corporation can not accept liability for damages or lost profits incurred as a result of product malfunction.

Notes on Copyright

Unless intended solely for personal use, images recorded using your digital camera system cannot be used in ways that infringe copyright laws without the consent of the owner. Note that some restrictions apply to the photographing of stage performances, entertainments, and exhibits, even when intended purely for personal use. Users are also asked to note that the transfer of memory cards containing images or data protected under copyright laws is only permissible within the restrictions imposed by those copyright laws.

Handling

To ensure that images are recorded correctly, do not subject the camera to impact or physical shocks while images are being recorded.

Liquid Crystal

In the event that the LCD monitor is damaged, care should be taken to avoid contact with liquid crystal. Take the urgent action indicated should any of the following situations arise:

- **If liquid crystal comes in contact with your skin**, clean the area with a cloth and then wash thoroughly with soap and running water.
- **If liquid crystal enters your eyes**, flush the affected eye with clean water for at least 15 minutes and then seek medical assistance.
- **If liquid crystal is swallowed**, rinse your mouth thoroughly with water. Drink large quantities of water and induce vomiting, then seek medical assistance.

Although the display is manufactured using extremely high-precision technology, it may contain pixels that are always lit or that do not light. This is not a malfunction, and images recorded with the product are unaffected.

Trademark Information

xD-Picture Card and **.x.D.** are trademarks of FUJIFILM Corporation. The typefaces included herein are solely developed by Dyna-Comware Taiwan Inc. Macintosh, QuickTime, and Mac OS are trademarks of Apple Inc. in the U.S.A. and other countries. Windows 7, Windows Vista, and the Windows logo are trademarks of the Microsoft group of companies. Adobe and Adobe Reader are either trademarks or registered trademarks of Adobe Systems Incorporated in the U.S.A. and/or other countries. The SDHC and SDXC logos are trademarks of SD-3C, LLC. The HDMI logo is a trademark. YouTube is a trademark of Google Inc. All other trade names mentioned in this manual are the trademarks or registered trademarks of their respective owners.

Electrical Interference

This camera may interfere with hospital or aviation equipment. Consult with hospital or airline staff before using the camera in a hospital or on an aircraft.

Color Television Systems

NTSC (National Television System Committee) is a color television telecasting specification adopted mainly in the U.S.A., Canada, and Japan. PAL (Phases Alternation by Line) is a color television system adopted mainly in European countries and China.

Exif Print (Exif Version 2.3)

Exif Print is a newly revised digital camera file format in which information stored with photographs is used for optimal color reproduction during printing.

IMPORTANT NOTICE: Read Before Using the Software

Direct or indirect export, in whole or in part, of licensed software without the permission of the applicable governing bodies is prohibited.

NOTICES

To prevent fire or shock hazard, do not expose the unit to rain or moisture.

Please read the "Safety Notes" and make sure you understand them before using the camera.

Perchlorate Material—special handling may apply. See <http://www.dtsc.ca.gov/hazardouswaste/perchlorate>.

For Customers in the U.S.A.

Tested To Comply With FCC Standards FOR HOME OR OFFICE USE

FCC Statement: This device complies with Part 15 of the FCC Rules. Operation is subject to the following two conditions: (1) This device may not cause harmful interference, and (2) this device must accept any interference received, including interference that may cause undesired operation.

CAUTION: This equipment has been tested and found to comply with the limits for a Class B digital device, pursuant to Part 15 of the FCC Rules. These limits are designed to provide reasonable protection against harmful interference in a residential installation. This equipment generates, uses, and can radiate radio frequency energy and, if not installed and used in accordance with the instructions, may cause harmful interference to radio communications. However, there is no guarantee that interference will not occur in a particular installation. If this equipment does cause harmful interference to radio or television reception, which can be determined by turning the equipment off and on, the user is encouraged to try to correct the interference by one or more of the following measures:

- Reorient or relocate the receiving antenna.
- Increase the separation between the equipment and receiver.
- Connect the equipment into an outlet on a circuit different from that to which the receiver is connected.
- Consult the dealer or an experienced radio/TV technician for help.
- You are cautioned that any changes or modifications not expressly approved in this manual could void the user's authority to operate the equipment.

Notes on the Grant: To comply with Part 15 of the FCC Rules, this product must be used with a Fujifilm-specified ferrite-core A/V cable, USB cable, and DC supply cord.

For Customers in Canada

CAUTION: This Class B digital apparatus complies with Canadian ICES-003.

Disposal of Electrical and Electronic Equipment in Private Households

In the European Union, Norway, Iceland and Liechtenstein: This symbol on the product, or in the manual and in the warranty, and/or on its packaging indicates that this product shall not be treated as household waste. Instead it should be taken to an applicable collection point for the recycling of electrical and electronic equipment.

By ensuring this product is disposed of correctly, you will help prevent potential negative consequences to the environment and human health, which could otherwise be caused by inappropriate waste handling of this product.

This symbol on the batteries or accumulators indicates that those batteries shall not be treated as household waste.



If your equipment contains easy removable batteries or accumulators please dispose these separately according to your local requirements.

The recycling of materials will help to conserve natural resources. For more detailed information about recycling this product, please contact your local city office, your household waste disposal service or the shop where you purchased the product.

In Countries Outside the European Union, Norway, Iceland and Liechtenstein: If you wish to discard this product, including the batteries or accumulators, please contact your local authorities and ask for the correct way of disposal.



About This Manual

Before using the camera, read this manual and the warnings in “For Your Safety” (📖 ii). For information on specific topics, consult the sources below.

Table of Contents 📖 xi

The “Table of Contents” gives an overview of the entire manual. The principal camera operations are listed here.

Warning Messages and Displays ... 📖 142

Find out what’s behind that flashing icon or error message in the display.

Troubleshooting 📖 136

Having a specific problem with the camera? Find the answer here.

🔴 ● **Memory Cards**

Pictures can be stored in the camera’s internal memory or on optional SD, SDHC, and SDXC memory cards (📖 18), referred to in this manual as “memory cards.”

🔴 ● **Temperature Warning**

The camera will turn off automatically before its temperature or the temperature of the battery rise above safe limits. Pictures taken when a temperature warning is displayed may exhibit higher levels of “noise” (mottling). Turn the camera off and wait for it to cool before turning it on again.









Table of Contents

For Your Safety	ii
IMPORTANT SAFETY INSTRUCTIONS	ii
Safety Notes	iv
About This Manual	x
Before You Begin	
Symbols and Conventions	1
Supplied Accessories	1
Parts of the Camera	2
Camera Displays	6
Shooting	6
Playback	7
Display mode	9
First Steps	
Charging the Battery	13
Inserting the Battery and a Memory Card	15
Compatible Memory Cards	18
Turning the Camera on and Off	20
Camera Mode	20
Switching from portable mode to standby mode	21
Switching from standby mode to portable mode	21
Switching from standby mode to shooting mode (Turning the camera on)	22
Switching from shooting mode to standby mode (Turning the camera off)	22
Playback Mode	23
Basic Setup	24





















































Basic Photography and Playback

Taking Pictures	25
Viewing Pictures	29

More on Photography

Shooting Mode	30
EXR (EXR AUTO/ EXR Priority)	31
EXR <small>EXTEND</small> (EXR AUTO)	31
EXR Priority	32
Adv. ADVANCED	33
ADVANCED FILTER	33
 MOTION PANORAMA 360	34
 PRO FOCUS	36
 PRO LOW-LIGHT	37
 MULTIPLE EXPOSURE	38
 INDIVID. SHUTTER 3D	39
SP SCENE POSITION	41
M MANUAL	42
A APERTURE PRIORITY AE	44
S SHUTTER PRIORITY AE	44
P PROGRAM AE	45
C1/C2 CUSTOM MODE	46
Focus Lock	47
 Exposure Compensation	49
 Macro Mode (Close-ups)	50
 Using the Flash (Super-Intelligent Flash)	51

Using the Self-Timer	53	Viewing Photobooks	77
The Fn Button	54	Editing and Deleting Photobooks.....	77
The E-Fn Button	55	Viewing Panoramas	78
Using the E-Fn BUTTON CUSTOM SETTING Menu	55	Viewing Photo Information	79
Continuous Shooting	57	Movies	
TOP <i>n</i>	58	Recording Movies	81
BEST FRAME CAPTURE.....	58	Movie Frame Size	83
AE BKT	60	Viewing Movies	84
ISO BKT	60	Connections	
FILM SIMULATION BKT	60	Viewing Pictures on TV	85
DYNAMIC RANGE BKT	61	Printing Pictures via USB	87
Focus Mode	62	Printing the DPOF Print Order.....	89
Focus Frame Selection	65	Viewing Pictures on a Computer	91
Intelligent Face Detection	66	Windows: Installing MyFinePix Studio	91
Face Recognition	67	Macintosh: Installing FinePixViewer.....	94
Adding New Faces	67	Connecting the Camera.....	96
Viewing, Editing, and Deleting Existing Data	69	Menus	
Adding Faces Automatically	69	Using the Menus: Shooting Mode	99
More on Playback		Using the Shooting Menu.....	99
Playback Options	71	Shooting Menu Options	100
Continuous Shooting.....	71	SCENE POSITION.....	100
★ Favorites: Rating Pictures	71	EXR MODE.....	100
Playback Zoom.....	72	Adv. MODE	100
Multi-Frame Playback.....	73	ISO.....	100
Deleting Pictures	74	IMAGE SIZE.....	101
Image Search	75	IMAGE QUALITY.....	101
PhotoBook Assist	76	D-RANGE DYNAMIC RANGE	102
Creating a PhotoBook.....	76	FILM SIMULATION	103
		WB WHITE BALANCE	104
		WB SHIFT	106

 COLOR.....	106	 IMAGE ROTATE	119
 SHARPNESS	106	 COPY	119
 HIGHLIGHT TONE	106	 VOICE MEMO	120
 SHADOW TONE.....	106	 ERASE FACE RECOG.	120
 NOISE REDUCTION.....	106	 PRINT ORDER (DPOF).....	121
 INTELLIGENT DIGITAL ZOOM.....	106	 DISP ASPECT	121
 CONTINUOUS	106	The Setup Menu	122
 ADVANCED ANTI BLUR	107	Using the Setup Menu.....	122
 FACE DETECTION SET-UP	107	Setup Menu Options	123
 PHOTOMETRY	107	 DATE/TIME	123
 FOCUS MODE.....	107	 TIME DIFFERENCE	123
 FOCUS AREA	108	 言語/LANG.	123
 Fn BUTTON	108	 RESET.....	124
 E-Fn BUTTON CUSTOM SETTING.....	108	 SILENT MODE.....	124
 DISP. CUSTOM SETTING	109	 SOUND SET-UP	124
 FLASH.....	109	 SCREEN SET-UP	125
 MOVIE SET-UP	110	 POWER MANAGEMENT	126
 CUSTOM SET	110	 IS MODE	127
Using the Menus: Playback Mode	111	 RED EYE REMOVAL	127
Using the Playback Menu	111	 AF ILLUMINATOR	128
Playback Menu Options.....	112	 RAW	128
 PHOTOBOK ASSIST.....	112	 SAVE DATA SET-UP	129
 IMAGE SEARCH	112	 FOCUS CONTROL DIAL.....	130
 ERASE	112	 VIDEO SYSTEM	130
 MARK FOR UPLOAD TO	113	 CUSTOM RESET	131
 SLIDE SHOW	114	 FORMAT	131
 RAW	115		
 RAW CONVERSION.....	115		
 RED EYE REMOVAL	117		
 PROTECT.....	117		
 CROP.....	118		
 RESIZE.....	118		

Technical Notes

Optional Accessories	132
Accessories from FUJIFILM.....	133
Caring for the Camera	134
Storage and Use	134
Cleaning.....	135
Traveling	135

Troubleshooting

Problems and Solutions	136
Warning Messages and Displays	142

Appendix

Memory Card Capacity	146
Specifications	147

Before You Begin

Symbols and Conventions

The following symbols are used in this manual:

- ⓘ : This information should be read before use to ensure correct operation.
- ◆ : Additional information that may be helpful when using the camera.
- 📖 : Other pages in this manual on which related information may be found.

Menus and other text in the displays are shown in **bold**. In the illustrations in this manual, displays may be simplified for explanatory purposes.

Supplied Accessories

The following items are included with the camera:



NP-50A Rechargeable
battery

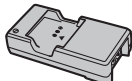

BC-50B battery charger



Plug adapter*

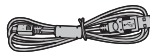

USB cable



CD-ROM (contains this
manual)

• Strap

Attaching the Strap

Attach the strap
as shown.

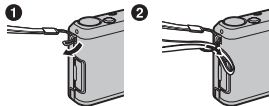

* Shape of adapter varies with region of sale.

Parts of the Camera

For more information, refer to the page listed to the right of each item.

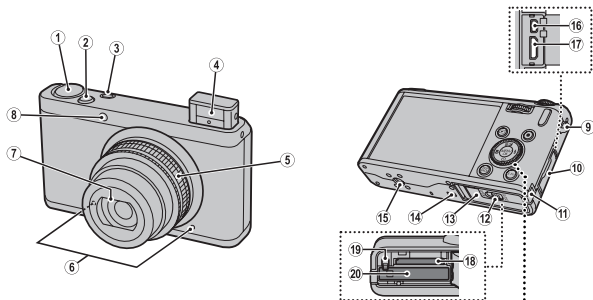

Selector button

Move cursor up

☑ (exposure compensation) button (📖 49)

🗑 (delete) button (📖 29)

MENU/OK button

Move cursor left

🌸 (macro) button (📖 50)

Move cursor right

⚡ (flash) button (📖 51)

Sub-command dial

Move cursor down

⌚ (self-timer) button (📖 53)

* The illustrations in this manual have been simplified for explanatory purposes.

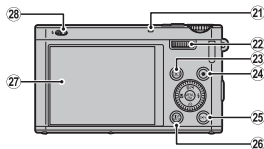

1 Mode dial.....	30	15 Tripod mount	
2 Shutter button	27	16 USB multi-connector.....	85, 87, 96
3 Fn (function) button	54	17 Connector for HDMI cable.....	86
4 Flash	51	18 Memory card slot	16
5 Zoom ring	26	19 Battery latch	15, 17
ON/OFF switch	22	20 Battery chamber	15
6 Microphone.....	81, 120	21 Indicator lamp.....	5
7 Lens cover	22	22 Main-command dial	4
8 AF-assist illuminator	128	23 (playback) button.....	29, 71
Self-timer lamp.....	53	24 (movie recording) button	81
9 Strap eyelet.....	1	25 E-Fn (extended function) button	55
10 Terminal cover.....	85, 87, 96	Monitor sunlight mode ¹	8
11 DC coupler cable cover	133	26 DISP (display)/ BACK button.....	9, 24, 79
12 Battery-chamber cover latch.....	15	(silent mode) button ²	5
13 Battery-chamber cover	15	27 LCD monitor	6
14 Speaker.....	84, 120	28 (flash pop-up) Switch	51

1 Press and hold the **E-Fn** button for monitor sunlight mode.

2 Press and hold the **DISP/BACK** button until is displayed.

Main-command dial/Sub-command dial

Rotate the main/sub-command dial to set the aperture value or shutter speed. You can also select items using the main/sub-command dial for the selector button. To adjust focus for **MANUAL**, rotate the sub-command dial (📖 62).



*Main-command
dial*



*Sub-command
dial*

Press the center of the main-command dial for some operations such as switching the setting item in **M** mode.



Control Lock

To lock the selector button (📷 / ⚡ / ⏸ / 📵) and the **E-Fn** button, press **MENU/OK** until 📷 is displayed. This prevents accidental operation during shooting. The controls can be unlocked by pressing **MENU/OK** until 📷 is no longer displayed.

The Indicator Lamp



The indicator lamp shows camera status as follows:

Indicator lamp	Camera status
Glows green	Focus locked.
Blinks green	Blur, focus, or exposure warning. Picture can be taken.
Blinks green and orange	Recording pictures. Additional pictures can be taken.
Glows orange	Recording pictures. No additional pictures can be taken at this time.
Blinks orange (fast)	Flash charging; flash will not fire when picture is taken.
Blinks orange (slow)	The zoom ring is positioned between 25 and STANDBY . Picture cannot be taken.
Blinks red	Lens or memory error.

Silent Mode

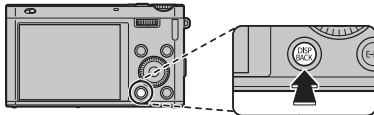
In situations in which camera sounds or lights may be unwelcome, hold the **DISP/BACK** button down until  is displayed.



The camera speaker, flash, and AF-assist illuminator/self-timer lamp turn off and flash and volume settings cannot be adjusted (note that the flash will still fire when  is selected in scene mode). To restore normal operation, press the **DISP/BACK** button until the  icon is no longer displayed.

Camera Displays

The following types of indicator may be displayed during shooting and playback. Indicators vary with camera settings.

Shooting

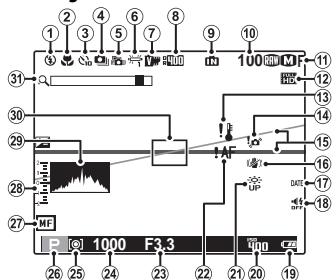

1	Flash mode	51
2	Macro (close-up) mode	50
3	Self-timer indicator	53
4	Continuous shooting mode	57
5	Advanced anti blur	32
6	White balance	104
7	Film simulation	103
8	Dynamic range	102
9	Internal memory indicator *	
10	Number of available frames	146
11	Image size/quality	101

12	Movie mode	83
13	Temperature warning.....	x, 142
14	Blur warning	52, 142
15	Electronic level	109
16	IS mode	127
17	Date stamp	130
18	Silent mode indicator	5, 124
19	Battery level	8
20	Sensitivity	100
21	Monitor sunlight mode	8
22	Focus warning	27, 142
23	Aperture.....	42, 44
24	Shutter speed	42, 44
25	Metering	107
26	Shooting mode	30
27	Manual focus indicator	62
28	Exposure indicator	49
29	Histogram	12
30	Focus frame	65
31	Intelligent digital zoom	106

* **IN**: indicates that no memory card is inserted and that pictures will be stored in the camera's internal memory (16).



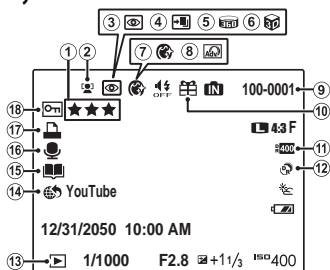

■ Playback





1	Favorites.....	71
2	Intelligent Face Detection indicator.....	66, 107
3	Red-eye removal indicator	117
4	Pro focus mode, pro low-light mode.....	36, 37
5	Motion panorama (pano)	34, 78
6	3D image.....	39
7	Portrait enhancer	41
8	Advanced Filter	33
9	Frame number	129
10	Gift image	71
11	Dynamic range.....	102
12	EXR mode	31
13	Playback mode indicator.....	29, 71
14	Mark for upload to	113
15	Photobook assist.....	76
16	Voice memo indicator	120
17	DPOF print indicator.....	89
18	Protected image.....	117

Battery Level

Battery level is shown as follows:

Indicator	Description
 (white)	Battery partially discharged.
 (white)	Battery more than half discharged.
 (red)	Low battery. Charge as soon as possible.
 (blinks red)	Battery exhausted. Charge battery.

Bright Ambient Lighting

Reflections and glare caused by bright ambient lighting may make it hard to see the display in the monitor, particularly when the camera is used outdoors. This can be addressed by holding the **E-Fn** button to trigger outdoor mode. Outdoor mode can also be enabled using the  **SCREEN SET-UP > MONITOR SUNLIGHT MODE** option ( 125).

Display mode

Press **DISP/BACK** to cycle through display modes as follows:

- Shooting

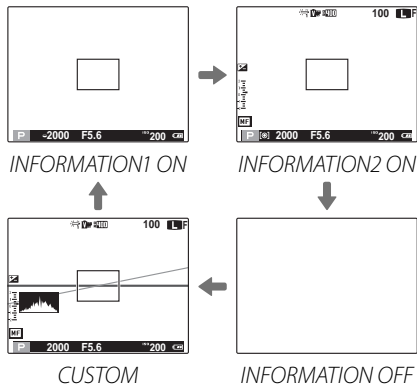

INFORMATION1 ON

INFORMATION1 ON can be displayed in a shooting mode which is **P, A, S, M, C1** or **C2**. The icons are displayed on the left side of shutter speed and aperture to change them quickly (109).



Custom Display

Choose items for display using  **DISP. CUSTOM SETTING** in the shooting menu (📖 109).

Focal Length, Aperture, Shutter Speed

Following information is displayed by rotating the zoom ring in **INFORMATION1 ON** or **INFORMATION2 ON**.



Focal length

Following information is displayed when aperture or shutter speed is set in **INFORMATION1 ON**.



Aperture



Shutter speed

- Playback

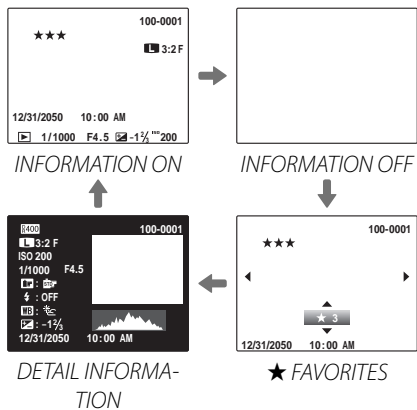

Histograms

Histograms show the distribution of tones in the image. Brightness is shown by the horizontal axis, the number of pixels by the vertical axis.

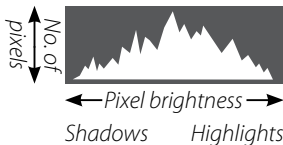

Optimal exposure: Pixels are distributed in an even curve throughout the tone range.

Overexposed: Pixels are clustered at the right side of the graph.

Underexposed: Pixels are clustered at the left side of the graph.

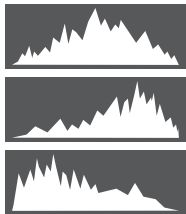

First Steps

Charging the Battery

The battery is not charged at shipment. Charge the battery before use.

1 Attach the plug adapter.

Attach the plug adapter as shown, making sure that it is fully inserted and clicks into place on the charger terminals.

- ① The plug adapter is exclusively for use with the supplied battery charger. Do not use it with other devices.

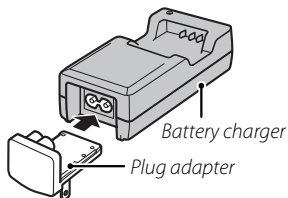

2 Place the battery in the supplied battery charger.

Insert the battery in the orientation indicated by the $\ominus \downarrow \oplus$ labels.

The camera uses an NP-50A rechargeable battery.

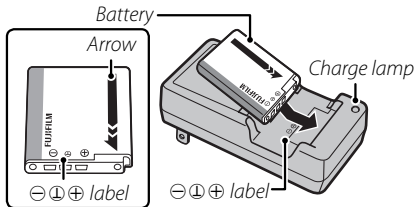

3 Plug the charger in.

Plug the charger into an indoor power outlet. The charging indicator will light.



The Charging Indicator

The charging indicator shows battery charge status as follows:

Charging indicator	Battery status	Action
Off	Battery not inserted.	Insert the battery.
	Battery fully charged.	Remove the battery.
On	Battery charging.	—
Blinks	Battery fault.	Unplug the charger and remove the battery.

4 Charge the battery.

Remove the battery when charging is complete. See the specifications (📖 151) for charging times (note that charging times increase both at high temperatures and at low temperatures).

- ⓘ Unplug the charger when it is not in use.

Inserting the Battery and a Memory Card

Although the camera can store pictures in internal memory, optional SD, SDHC, and SDXC *memory cards* (sold separately) can be used to store additional pictures. After charging the battery, insert the battery and memory card as described below.

1 Open the battery-chamber cover.

- ◆ Be sure the camera is off before opening the battery-chamber cover.
- ⚠ Do not open the battery-chamber cover when the camera is on. Failure to observe this precaution could result in damage to image files or memory cards.
- ⚠ Do not use excessive force when handling the battery-chamber cover.

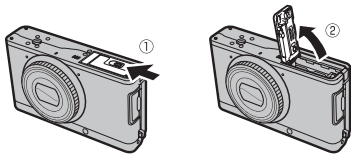

2 Insert the battery.

Align the orange stripe on the battery with the orange battery latch and slide the battery into the camera, keeping the battery latch pressed to one side. Confirm that the battery is securely latched.

- ⚠ Insert the battery in the correct orientation. **Do NOT use force or attempt to insert the battery upside down or backwards.** The battery will slide in easily in the correct orientation.

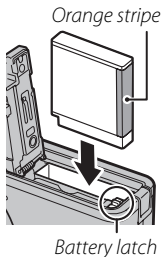

3 Insert the memory card.

Holding the memory card in the orientation shown at right, slide it in until it clicks into place at the back of the slot.

- ① Be sure card is in the correct orientation; do not insert at an angle or use force. If the memory card is not correctly inserted or no memory card is inserted, **IN** will appear in the LCD monitor and internal memory will be used for recording and playback.
- ① SD/SDHC/SDXC memory cards can be locked, making it impossible to format the card or to record or delete images. Before inserting an SD/SDHC/SDXC memory card, slide the write-protect switch to the unlocked position.

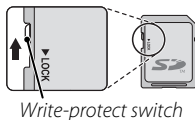
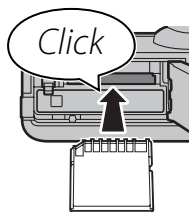

4 Close the battery-chamber cover.



◆ Using an AC Power Adapter

The camera can be powered by an optional AC power adapter and DC coupler (sold separately). See the manuals provided with the AC power adapter and DC coupler for details.

●● Removing the Battery and Memory Card

Before removing the battery or memory card, **turn the camera off** and open the battery-chamber cover.

To remove the battery, press the battery latch to the side, and slide the battery out of the camera as shown.

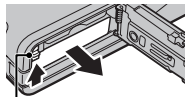

Battery latch

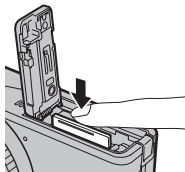

To remove the memory card, press it in and release it slowly. The card can then be removed by hand. When a memory card is removed, the card could come out of the slot too quickly. Use your finger to hold it and gently release the card.



■ Compatible Memory Cards

FUJIFILM and SanDisk SD, SDHC, and SDXC memory cards have been approved for use in the camera. A complete list of approved memory cards is available at http://www.fujifilm.com/support/digital_cameras/compatibility/. Operation is not guaranteed with other cards. The camera can not be used with *xD-Picture Cards* or MultiMediaCard (MMC) devices.

① Memory Cards

- *Do not turn the camera off or remove the memory card while the memory card is being formatted or data are being recorded to or deleted from the card.* Failure to observe this precaution could damage the card.
- Format SD/SDHC/SDXC memory cards before first use, and be sure to reformat all memory cards after using them in a computer or other device. For more information on formatting memory cards, see “ **FORMAT**” (📖 131).
- Memory cards are small and can be swallowed; keep out of reach of children. If a child swallows a memory card, seek medical assistance immediately.
- miniSD or microSD adapters that are larger or smaller than the standard dimensions of an SD/SDHC/SDXC card may not eject normally; if the card does not eject, take the camera to an authorized service representative. Do not forcibly remove the card.
- Do not affix labels to memory cards. Peeling labels can cause camera malfunction.
- Movie recording may be interrupted with some types of SD/SDHC/SDXC memory card. Use a **CLASS 4**  card or better when shooting HD or high-speed movies.

- The data in internal memory may be erased or corrupted when the camera is repaired. Please note that the repairer will be able to view pictures in internal memory.
- Formatting a memory card or internal memory in the camera creates a folder in which pictures are stored. Do not rename or delete this folder or use a computer or other device to edit, delete, or rename image files. Always use the camera to delete pictures from memory cards and internal memory; before editing or renaming files, copy them to a computer and edit or rename the copies, not the originals.

① Batteries

- Remove dirt from the battery terminals with a clean, dry cloth. Failure to observe this precaution could prevent the battery from charging.
- Do not affix stickers or other objects to the battery. Failure to observe this precaution could make it impossible to remove the battery from the camera.
- Do not short the battery terminals. The battery could overheat.
- Read the cautions in “The Battery and Power Supply” (📖 vi).
- Use only battery chargers designated for use with the battery. Failure to observe this precaution could result in product malfunction.
- Do not remove the labels from the battery or attempt to split or peel the outer casing.
- The battery gradually loses its charge when not in use. Charge the battery one or two days before use.

Turning the Camera on and Off

Camera Mode

The camera has three characteristic modes (status). Choose a camera mode according to the purpose.

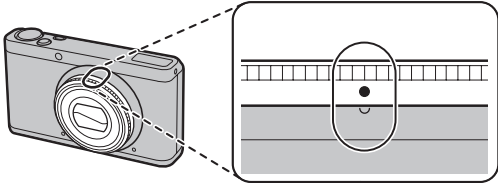
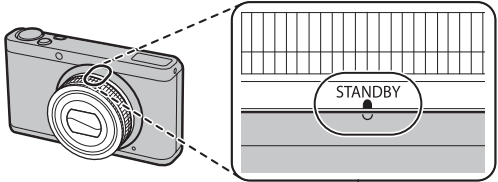
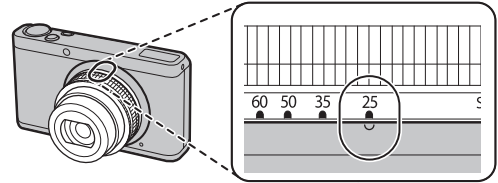
Mode	Power	Indicator
Portable mode The lens is housed and locked to carry the camera by a camera case or a bag (21).	Off	
Standby mode The camera becomes turned off temporarily in this mode (21).	Off	
Shooting mode The camera turns on and can take pictures (22).	On	

Switching from portable mode to standby mode

Portable mode

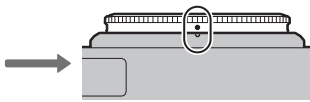

The factory default is portable mode.



Rotate the zoom ring until it stops as shown.



Standby mode

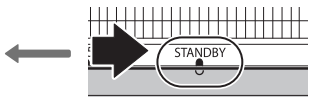

Rotate the zoom ring to **STANDBY**.

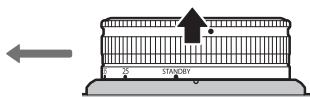

Pull the zoom ring until it clicks.

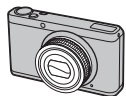
Switching from standby mode to portable mode

Standby mode

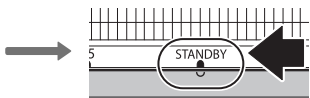

When the camera is in shooting mode, rotate the zoom ring to **STANDBY**.

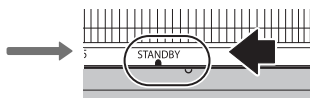

Rotate the zoom ring until it stops as shown.



Portable mode

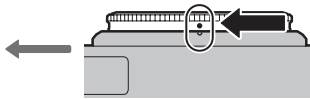

Rotate the zoom ring until fitting the red marks.

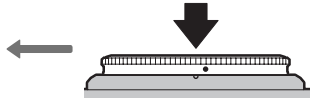

Press the zoom ring until it stops.

ⓘ If the lens is not locked correctly, it may protrude.

Switching from standby mode to shooting mode (Turning the camera on)



Standby mode

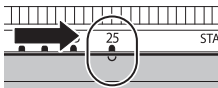

Rotate the zoom ring to **25**.
The camera turns on and the lens cover opens.



Shooting mode

Switching to Playback Mode

Press the  button to start playback. Press the shutter button halfway to return to shooting mode.

Switching from shooting mode to standby mode (Turning the camera off)



Shooting mode

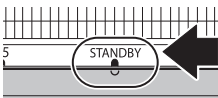

Rotate the zoom ring to
STANDBY.

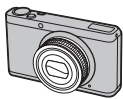



Standby mode

- ⓘ Fingerprints and other marks on the lens can affect pictures. Keep the lens clean.
- ⓘ Do not touch the lens cover during pressing or pulling the zoom ring. Failure to observe this precaution could result in damage to the camera.
- ⓘ Make sure that the camera turns off before housing the lens and the zoom ring.

Playback Mode

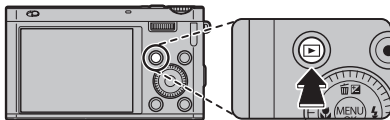
To turn the camera on and begin playback, press the  button for about a second.





Press the  button again to turn the camera off.

Auto Power Off

The camera will turn off automatically if no operations are performed for the length of time selected for  **POWER MANAGEMENT > AUTO POWER OFF** ( 126).

Basic Setup

A language-selection dialog is displayed the first time the camera is turned on. Set up the camera as described below (you can reset the clock or change languages at any time using the  **DATE/TIME** or  **言語/LANG.** options in the setup menu; for information on displaying the setup menu, see page 122).

1 Highlight a language and press **MENU/OK**.

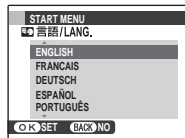

- ◆ Press **DISP/BACK** to skip the current step. Any steps you skip will be displayed the next time the camera is turned on.

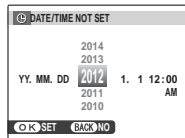

2 The date and time will be displayed. Press the selector left or right to highlight the year, month, day, hour, or minute and press up or down to change. To change the order in which the year, month, and day are displayed, highlight the date format and press the selector up or down. Press **MENU/OK** when settings are complete.



3 Power management options will be displayed. Press the selector up or down to highlight one of the following options and then press **MENU/OK**:

-  **POWER SAVE**: Save battery power.
-  **CLEAR DISPLAY**: Choose for a brighter, higher quality display.

◆ The Camera Clock

If the battery is removed for an extended period, the camera clock will be reset and the language-selection dialog will be displayed when the camera is turned on.

Basic Photography and Playback

Taking Pictures

This section describes how to take pictures in **EXR AUTO** mode.

1 Select **EXR** mode.

Turn the camera on and rotate the mode dial to **EXR**. The **EXR AUTO** display will appear in the LCD monitor.

Scene Icon (📖 31)

The camera automatically selects the appropriate scene.



The **Face Lock** Icon

In **EXR** mode, the camera continuously adjusts focus and searches for faces, increasing the drain on the battery.  is displayed in the LCD monitor.

- ◆ The camera analyses the scene and selects the preferred **EXR** mode when the shutter button is pressed halfway (📖 32).
- ◆ To raise the flash when lighting is poor, slide the flash pop-up switch (📖 51).

2 Frame the picture.

Use the zoom ring to frame the picture in the display. The zoom indicator appears.

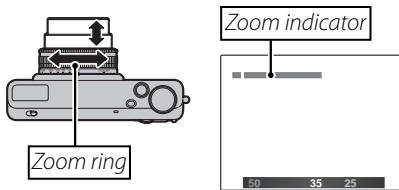

Holding the Camera

Hold the camera steady with both hands and brace your elbows against your sides. Shaking or unsteady hands can blur your shots.

To prevent pictures that are out of focus or too dark (underexposed), keep your fingers and other objects away from the lens and flash.

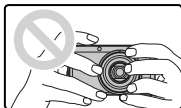

3 Focus.

Press the shutter button halfway to focus.

- ◆ The lens may make a noise when the camera focuses; this is normal. If the subject is poorly lit, the AF-assist illuminator may light; see “**AF-ILLUMINATOR**” (📖 128) for information on disabling the illuminator.

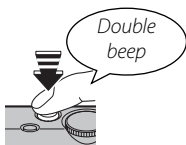

If the camera is able to focus, it will beep twice and the indicator lamp will glow green.

If the camera is unable to focus, the focus frame will turn red, **!AF** will be displayed, and the indicator lamp will blink green. Change the composition or use focus lock (📖 47).

4 Shoot.

Smoothly press the shutter button the rest of the way down to take the picture.



The Shutter Button

The shutter button has two positions. Pressing the shutter button halfway sets focus and exposure; to shoot, press the shutter button the rest of the way down.

Viewing Pictures

Pictures can be viewed in the LCD monitor. When taking important photographs, take a test shot and check the results.

1 Press the button.

The most recent picture will be displayed.

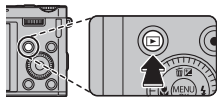

2 View additional pictures.

Press the selector right to view pictures in the order recorded, left to view pictures in reverse order.

Press the shutter button to exit to shooting mode.

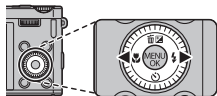

Deleting Pictures

To delete the picture currently displayed in the monitor, press the selector up () and choose from the options.



To exit without deleting the picture, highlight **CANCEL** and press **MENU/OK**.

 Pictures can also be deleted from the playback menu ( 74).

EXR (EXR AUTO/EXR Priority)

Optimize settings for your current subject or improve clarity, reduce noise, or enhance dynamic range. Rotate the mode dial to **EXR** and choose one of the following **EXR** modes in the shooting menu.

**EXR AUTO (EXR AUTO)**

The camera automatically selects the scene and **EXR** mode according to shooting conditions (📖 25).

🔍 If **AUTO** is selected for **IMAGE SIZE** in **EXR AUTO** mode, the camera will automatically select the optimal image size.



Scene icon

The Scene Icon

The camera selects from the following scenes:



Scene		AUTO	LAND-SCAPE	NIGHT	NIGHT (TRIPOD)	MACRO	BEACH	SUNSET	SNOW	SKY	GREENERY	SKY & GREENERY
Main subject		📷	🌄	🌃*	🌃*	🔍	🏖️	🌅	❄️	☁️	🌿	🌿
Non-portrait		📷	🌄	🌃*	🌃*	🔍	🏖️	🌅	❄️	☁️	🌿	🌿
Portrait	Normal	👤	👤🌄	👤🌃*	👤🌃*	—	👤🏖️	👤🌅	👤❄️	👤☁️	👤🌿	👤🌿
	Backlit	👤	👤🌄	—	—	—	👤🏖️	👤🌅	👤❄️	👤☁️	👤🌿	👤🌿
Moving object		📷	🌄	🌃	🌃	🔍	🏖️	🌅	❄️	☁️	🌿	🌿
Portrait and motion	Normal	👤	👤🌄	👤🌃	👤🌃	—	👤🏖️	👤🌅	👤❄️	👤☁️	👤🌿	👤🌿
	Backlit	👤	👤🌄	—	—	—	👤🏖️	👤🌅	👤❄️	👤☁️	👤🌿	👤🌿

* If 🌃 is displayed, the camera will take a series of shots (advanced anti-blur; 📖 32).

ⓘ The mode selected may vary with shooting conditions. If the mode and subject do not match, select 📷 mode (📖 30) or choose **SP** (📖 41) and select a scene manually.



Advanced Anti Blur

When  is displayed, the camera will take a series of exposures and combine them to form a single image, reducing “noise” (mottling) and blur.

- ◆  is available when **ON** is selected for  **ADVANCED ANTI BLUR** (📖 107) and the flash (📖 51) is off or set to auto.
- ① Some time may be required to combine the exposures into a single image. A single combined image may not be created if the subject or camera moves during shooting. Keep the camera steady during shooting and do not move the camera until shooting is complete.
- ① Frame coverage is reduced.







The **EXR** *Icon*

When the shutter button is pressed halfway, the camera chooses the preferred **EXR** mode:

-  (**RESOLUTION PRIORITY**): Produces crisp, clear shots.
-  (**HIGH ISO & LOW NOISE**): Reduces noise in pictures taken at high sensitivities.
-  (**D-RANGE PRIORITY**): Increases the amount of detail visible in highlights.

■ **EXR** Priority

Select this mode to manually choose from the following **EXR** modes:











-  (**RESOLUTION PRIORITY**): Choose for crisp, clear shots.
 -  (**HIGH ISO & LOW NOISE**): Reduce noise in pictures taken at high sensitivities.
 -  (**D-RANGE PRIORITY**): Increase the amount of detail visible in highlights.
-  **DYNAMIC RANGE** (📖 102) can be set to  (1600%) and  (800%).

Adv. *ADVANCED*

This mode combines “point-and-shoot” simplicity with sophisticated photographic techniques. The  **Adv. MODE** option can be used to choose from the following advanced modes:

**■ ADVANCED FILTER**

Take photos with filter effects. Choose from the following filters.

Filter	Description
 TOY CAMERA	Choose for a retro toy camera effect.
 MINIATURE	The tops and bottoms of pictures are blurred for a diorama effect.
 POP COLOR	Create high-contrast images with saturated colors.
 HIGH-KEY	Create bright, low-contrast images.
 DYNAMIC TONE	Dynamic tone expression is used for a fantasy effect.
 PARTIAL COLOR (RED)	Areas of the image that are the selected color are recorded in that color. All others areas of the image are recorded in black-and-white.
 PARTIAL COLOR (ORANGE)	
 PARTIAL COLOR (YELLOW)	
 PARTIAL COLOR (GREEN)	
 PARTIAL COLOR (BLUE)	
 PARTIAL COLOR (PURPLE)	

- ◆ Depending on the subject and camera settings, images may in some cases be grainy or vary in brightness and hue.

■ MOTION PANORAMA 360

Follow an on-screen guide to take photos that will automatically be joined to form a panorama. The camera zooms all the way out and remains fixed at the widest angle until shooting is complete.



- 1 Rotate the zoom ring until the zoom indicator turns white (📖 26).
- 2 To select the angle through which you will pan the camera while shooting, press the selector down. Press the selector left or right to highlight an angle and press **MENU/OK**.
- 3 Press the selector right to view a choice of pan directions. Press the selector left or right to highlight a pan direction and press **MENU/OK**.
- 4 Press the shutter button all the way down to start recording. There is no need to keep the shutter button pressed during recording.
- 5 Pan the camera in the direction shown by the arrow. Shooting ends automatically when the progress bar is full and the panorama is complete.

- ◆ Shooting ends if the shutter button is pressed all the way down during shooting. No panorama will be recorded if the shutter button is pressed before the camera has been panned through 120°.

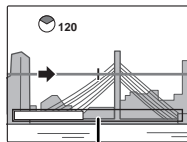





Progress bar

- ① Panoramas are created from multiple frames. The camera may in some cases record an greater or lesser angle than selected or be unable to stitch the frames together perfectly. The last part of the panorama may not be recorded if shooting ends before the panorama is complete.
- ① Shooting may be interrupted if the camera is panned too quickly or too slowly. Panning the camera in a direction other than that shown cancels shooting.
- ① The desired results may not be achieved with moving subjects, subjects close to the camera, unvarying subjects such as the sky or a field of grass, subjects that are in constant motion, such as waves and waterfalls, or subjects that undergo marked changes in brightness. Panoramas may be blurred if the subject is poorly lit.



Choose  for seamless 360° panoramas that can be played back in a loop (📖 78).

- ❖ The  **SAVE DATA SET-UP > SAVE ORG IMAGE** option can be used to record a  panorama in addition to a seamless  panorama (📖 129).
- ① Depending on the subject and shooting conditions, the camera may produce distorted results or a  panorama. The top and bottom of the area visible in the shooting display are cropped out and white strips may appear at the top and bottom of the display.

For Best Results

For best results, move the camera in a small circle at a steady speed, keeping the camera horizontal and being careful only to pan in the direction shown by the guides. If the desired results are not achieved, try panning at a different speed.

■ PRO FOCUS

The camera takes up to three shots each time the shutter button is pressed, softening the background to emphasize the main subject. The amount of softening can be adjusted before shooting by rotating the sub-command dial. Use for portraits or photos of flowers similar to those produced by SLR cameras.



- ◆ Softening can not be applied to background objects that are too close to the main subject. If a message stating that the camera can not create the effect is displayed when the camera focuses, try backing away from your subject and zooming in. The camera may also be unable to soften the background if the subject is moving; if prompted, check the results and try again.



■ PRO LOW-LIGHT

Each time the shutter button is pressed, the camera makes four exposures and combines them into a single photograph. Use to reduce noise and blur when photographing poorly lit subjects or static subjects at high zoom ratios.



- ◆ A single combined photograph may not be created with some scenes or if the subject or camera moves during shooting. Do not move the camera until shooting is complete.

PRO FOCUS/PRO LOW-LIGHT

To save unprocessed copies of pictures taken in these modes, select **ON** for  **SAVE DATA SET-UP > SAVE ORG IMAGE** ( 129).

- ① Keep the camera steady during shooting.
- ① Frame coverage is reduced.

■ MULTIPLE EXPOSURE

Create a photograph that combines two exposures.

1 Take the first shot.

2 Press **MENU/OK**. The first shot will be shown superimposed on the view through the lens as a guide to taking the second shot.

◆ To return to Step 1 and retake the first shot, press the selector left. To save the first shot and exit without creating a multiple exposure, press **DISP/BACK**.

3 Take the second shot.

4 Press **MENU/OK** to create the multiple exposure, or press the selector left to return to Step 3 and retake the second shot.

■ INDIVID. SHUTTER 3D

Take two shots from different angles to create a 3D image.

- 1 To choose the order in which the pictures are taken, press the selector right to display the current order and then press the selector left or right to choose from the options below.

1 → **2**: Take the left shot first.

2 ← **1**: Take the right shot first.

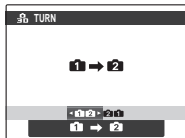

- 2 Press the shutter button to take the first shot.

❖ To exit without recording a picture, press **DISP/BACK**.

- 3 The first shot will be shown superimposed on the view through the lens. Using it as a guide, frame the second shot and press the shutter release button.

❖ The 3D effect may not be visible with some subjects or under some shooting conditions. For best results, the distance the camera is moved between shots should be about $\frac{1}{30}$ th to $\frac{1}{50}$ th of the distance to the subject.



❖ The camera will turn off automatically if no operations performed for the time selected for ** POWER MANAGEMENT > AUTO POWER OFF** (📖 126). The first shot will not be saved if the second shot is not taken before the camera turns off.

Viewing and Printing 3D Images













- **The camera** displays images in 2D. Press the selector down to toggle between the first and second shots.
 - **Devices equipped for 3D display**, such as the FINEPIX REAL 3D V3 digital photo frame or FINEPIX REAL 3D W3 digital camera, will display the images in 3D. Note that the FINEPIX REAL 3D W3 only displays images of size **M** or smaller.
 - **3D prints** can be ordered from <http://www.fujifilm.com/3d/print/>
 - **The supplied software** displays 3D anaglyph images. 3D photos can also be viewed using other applications that support the MP format.
 - **3D TVs** that support the MP format can display images in 3D. See the manual for your TV for details.
- ① Images are not output in 3D when printed directly from the camera.
- ① 3D images are displayed in 2D in slide shows and when output on a conventional TV.
- ① 3D images can not be edited or retouched.





Note: The MP (**M**ulti-**P**icture) format is a CIPA standard for files containing multiple still images. Files in MP format are referred to as "MP files" and have the extension "*.MPO". The camera uses this format for 3D images.

SP SCENE POSITION

The camera offers a choice of “scenes,” each adapted to particular shooting conditions or a specific type of subject. Use the  **SCENE POSITION** option to choose the scene assigned to the **SP** position on the mode dial.



Scene	Description
 NATURAL & 	The camera takes two shots: one without the flash and one with.
 NATURAL LIGHT	Capture natural lighting under low-light conditions.
 PORTRAIT	Choose for portraits.
 PORTRAIT ENHANCER	Choose for a smooth skin effect when shooting portraits.
 LANDSCAPE	Choose for daylight shots of buildings and landscapes.
 SPORT	Choose when photographing moving subjects.
 NIGHT	Choose this mode for poorly lit twilight or night scenes.
 NIGHT (TRIPOD)	Choose this mode for slow shutter speeds when shooting at night.
 FIREWORKS	Slow shutter speeds are used to capture the expanding burst of light from a firework.
 SUNSET	Choose this mode to record the vivid colors in sunrises and sunsets.
 SNOW	Choose for crisp, clear shots that capture the brightness of scenes dominated by shining white snow.

Scene	Description
 BEACH	Choose for crisp, clear shots that capture the brightness of sunlit beaches.
 UNDERWATER	Reduces the blue cast typically associated with underwater lighting.
 PARTY	Capture indoor background lighting under low-light conditions.
 FLOWER	Choose for vivid close-ups of flowers.
 TEXT	Take clear pictures of text or drawings in print.

M MANUAL

In this mode, you choose both shutter speed and aperture. If desired, exposure can be altered from the value suggested by the camera.



Rotate the main-command dial to set the shutter speed or aperture. Press the main-command dial to change the setting item between shutter speed and aperture.

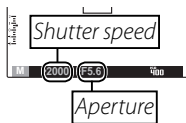

- ❖ Rotating the main-command dial changes the setting marked with .
- Ⓢ Noise in the form of randomly-spaced bright pixels may occur in long exposures.
- Ⓢ The shutter speed is restricted depending on the ISO setting.
- Ⓢ If the shutter speed is displayed in red at the selected aperture, photos will be taken without the selected shutter speed.

Sub-command dial

When an option other than **MANUAL** is selected for focus mode (62), you can use the sub-command dial to set aperture or shutter speed.

- Rotating the sub-command dial changes the setting that is marked with .
- Press the main-command dial to change the setting item.

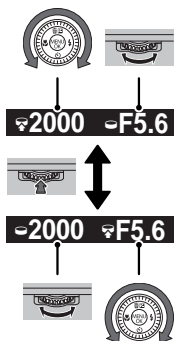

The Exposure Indicator

The amount the picture will be under- or over-exposed at current settings is shown by the exposure indicator.



A APERTURE PRIORITYAE

Choose the aperture using the main/sub-command dial, while the camera adjusts shutter speed for optimal exposure.

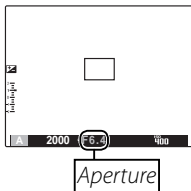

- ① If the correct exposure can not be achieved at the selected aperture, shutter speed will be displayed in red. Adjust aperture until the correct exposure is achieved. If the subject is outside the metering range of the camera, the shutter speed display will show “---”. Press the shutter button halfway to measure exposure again.

**S SHUTTER PRIORITYAE**

Choose the shutter speed using the main/sub-command dial, while the camera adjusts aperture for optimal exposure.



- ① If the correct exposure can not be achieved at the selected shutter speed, aperture will be displayed in red. Adjust shutter speed until the correct exposure is achieved. If the subject is outside the metering range of the camera, the aperture display will show “F---”. Press the shutter button halfway to measure exposure again.
- ① If the shutter speed is displayed in red at the selected aperture, photos will be taken without the selected shutter speed.

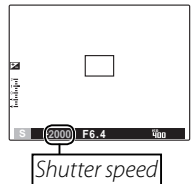

P PROGRAM AE

The camera sets exposure automatically.



- ① If the subject is outside the metering range of the camera, the shutter speed and aperture displays will show “---”. Press the shutter button halfway to measure exposure again.

Program Shift

Rotate the main/sub-command dial to choose the desired combination of shutter speed and aperture. The default values can be restored by raising the flash or turning the camera off. To use program shift, turn the flash off. Furthermore, an option other than **AUTO** must be selected for **D-Ring DYNAMIC RANGE** and **ISO ISO**.

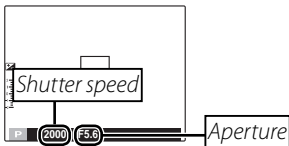

C1/C2 CUSTOM MODE

In **P, S, A, M** and all **EXR** modes except **EXR AUTO**, the **C1/C2 CUSTOM SET** option in the shooting menu can be used to save current camera and menu settings. These settings are recalled whenever the mode dial is rotated to **C1/C2** (custom mode).



Menu/setting	Settings saved
Shooting menu	ISO ISO, ◀ IMAGE SIZE, + IMAGE QUALITY, D-Rng DYNAMIC RANGE, F FILM SIMULATION, WB WB SHIFT, Color COLOR, Sharp SHARPNESS, HL HIGHLIGHT TONE, TL SHADOW TONE, NR NOISE REDUCTION, IDZ INTELLIGENT DIGITAL ZOOM, FD FACE DETECTION, FM FOCUS MODE, FL FLASH, Ph PHOTOMETRY, WB WHITE BALANCE, C CONTINUOUS
Setup menu	AF-ILL AF ILLUMINATOR, RAW RAW
Other	Macro mode (Ⓜ), flash mode (⚡), program shift, shutter speed, aperture, monitor display options (DISP/BACK), exposure compensation (±)

① Once the camera is turned off, **IDZ INTELLIGENT DIGITAL ZOOM** is deactivated.

Focus Lock

To compose photographs with off-center subjects:

1 Focus: Position the subject in the focus frame and press the shutter button halfway to lock focus and exposure. Focus and exposure will remain locked while the shutter button is pressed halfway (AF/AE lock).

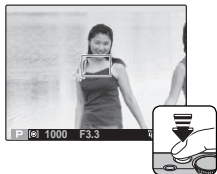

2 Recompose: Keep the button pressed halfway.



3 Shoot: Press the button all the way down.



Autofocus

Although the camera boasts a high-precision autofocus system, it may be unable to focus on the subjects listed below. If the camera is unable to focus, focus on another subject at the same distance and use focus lock to recompose the photograph.

- Very shiny subjects such as mirrors or car bodies.
- Fast-moving subjects.
- Subjects photographed through a window or other reflective object.
- Dark subjects and subjects that absorb rather than reflect light, such as hair or fur.
- Insubstantial subjects, such as smoke or flame.
- Subjects that show little contrast with the background (for example, subjects in clothing that is the same color as the background).
- Subjects positioned in front of or behind a high-contrast object that is also in the focus frame (for example, a subject photographed against a backdrop of highly contrasting elements).

Exposure Compensation

To adjust exposure compensation when photographing very bright, very dark, or high-contrast subjects, press the selector up () . Rotate the main/sub-command dial to choose an exposure compensation value and then press **MENU/OK**.

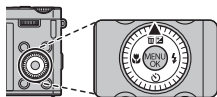



*Choose positive (+) values
to increase exposure*





*Choose negative (-) values
to reduce exposure*

- ❖ A  icon and exposure indicator are displayed at settings other than ± 0 . Exposure compensation is not reset when the camera is turned off; to restore normal exposure control, choose a value of ± 0 .
- ❖ Turn the flash off when using exposure compensation.

Macro Mode (Close-ups)

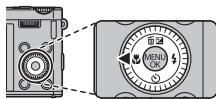
For close-ups, press the selector left () and select . Rotate the zoom ring to compose pictures ( 26).



To exit macro mode, press the selector left () and select **OFF**.

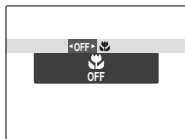

- ❖ Use of a tripod is recommended to prevent blur caused by camera shake.
- ❖ The shadow cast by the lens may appear in photographs taken with the flash at very short ranges. Zoom out or increase the distance to the subject.
- ❖ Macro mode can be performed only when autofocus is used.

⚡ Using the Flash (Super-Intelligent Flash)

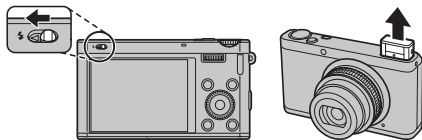

When the flash is used, the camera's *Super-Intelligent Flash* system instantly analyzes the scene based on such factors as the brightness of the subject, its position in the frame, and its distance from the camera. Flash output and sensitivity are adjusted to ensure that the main subject is correctly exposed while preserving the effects of ambient background lighting, even in dimly-lit indoor scenes. Use the flash when lighting is poor, for example when shooting at night or indoors under low light.

- 1 Slide the flash pop-up switch to raise the flash.



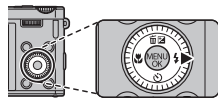

2 Press the selector right (⚡) and choose from the following flash modes:



Option	Description
AUTO/  *	The flash fires when required. Recommended in most situations.
⚡/  *	The flash fires whenever a picture is taken. Use for backlit subjects or for natural coloration when shooting in bright light.
S4/  *	Capture both the main subject and the background under low light (note that brightly lit scenes may be overexposed).



*  icon indicates that Intelligent Face Detection and red-eye removal are on and will be used to minimize “red-eye” caused by the flash reflecting from the retinas of portrait subjects.

- ❖ Lower the flash where flash photography is prohibited or to capture natural lighting under dim light. We also recommend that you lower the flash when the camera is off.
- ❖ If the flash will fire,  will be displayed when the shutter button is pressed halfway. At slow shutter speeds,  will appear in the display to warn that pictures may be blurred; use of a tripod is recommended.
- ❖ The flash may fire several times with each shot. Do not move the camera until shooting is complete.
- ❖ The flash may cause vignetting.

⏸ Using the Self-Timer

To use the self-timer, press the selector down (⏸) and choose from the following options:

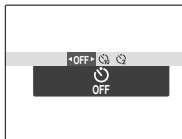
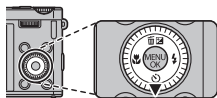

Option	Description
⏸ (OFF)	Self-timer off.
⏸ (10 SEC)	The shutter is released ten seconds after the shutter button is pressed. Use for self-portraits. The self-timer lamp on the front of the camera lights when the timer starts and begins to blink shortly before the photo is taken.
⏸ (2 SEC)	The shutter is released two seconds after the shutter button is pressed. Use to reduce blur caused by the camera moving when the shutter button is pressed. The self-timer lamp will blink as the timer counts down.

The Fn Button

The role played by the **Fn** button can be selected using the **Fn Fn BUTTON** option.

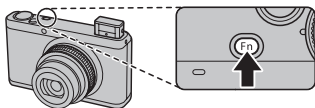

The following options are available:

ISO (📖 100)/**IMAGE SIZE** (📖 101)/**IMAGE QUALITY** (📖 101)/
RAW (📖 128)/**DYNAMIC RANGE** (📖 102)/**FILM SIMULATION** (📖 103)/
PHOTOMETRY (📖 107)/**FOCUS MODE** (📖 62)/
FACE RECOGNITION (📖 67)/**FACE DETECTION** (📖 66)/
INTELLIGENT DIGITAL ZOOM (📖 106)

- ◆ The **Fn Fn BUTTON** menu can also be displayed by pressing and holding the **Fn** button.

The E-Fn Button

Press the **E-Fn** button to use the **E-Fn** (extended function) menu.

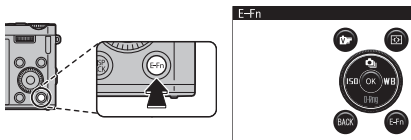

The each role played by the , the  button and the selector up, down, left and right can be used in the **E-Fn** menu.

◆ Press the **E-Fn** button again to return to shooting mode.

■ Using the E-Fn BUTTON CUSTOM SETTING Menu

The following options are available:

ISO (📖 100)/**IMAGE SIZE** (📖 101)/**IMAGE QUALITY** (📖 101)/**RAW** (📖 128)/
DYNAMIC RANGE (📖 102)/**FILM SIMULATION** (📖 103)/
WHITE BALANCE (📖 104)/**CONTINUOUS** (📖 57)/**PHOTOMETRY** (📖 107)/
FOCUS MODE (📖 62)/**FOCUS AREA** (📖 65)/**FACE DETECTION** (📖 66)/
FACE RECOGNITION (📖 67)/**INTELLIGENT DIGITAL ZOOM** (📖 106)

- 1 Select **E-Fn** **E-Fn** **BUTTON CUSTOM SETTING** in the shooting menu. The **E-Fn** **E-Fn** **BUTTON CUSTOM SETTING** menu is displayed.

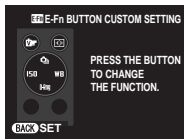

2 Press the button to adjust.









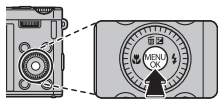



3 Highlight items and press the selector up or down to view options, then highlight an option and press **MENU/OK**.

Continuous Shooting

To capture motion in a series of pictures, press **MENU/OK**, select  **CONTINUOUS** in the shooting menu, and choose from the options listed in this section.



Option	
 STILL IMAGE	—
 TOP <i>n</i>	58
 BEST FRAME CAPTURE	58
 AE BKT	60
 ISO BKT	60
 FILM SIMULATION BKT	60
 DYNAMIC RANGE BKT	61

- ◆ The flash turns off automatically. The previously selected flash mode is restored when  is selected for  **CONTINUOUS**.
- ◆ Frame rate varies with shutter speed.
- ◆ Focus and exposure are determined by the first frame in each series.
- ◆ The number of pictures that can be taken in a single burst varies with the scene and camera settings. The number of pictures that can be recorded depends on the memory available.

TOP n

The camera takes photographs while the shutter button is pressed. To choose the frame rate:

- 1 Press the selector left or right to choose a frame rate and press **MENU/OK** to select and return to shooting mode.

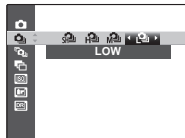

BEST FRAME CAPTURE

The camera takes a series of pictures, starting before and ending after the shutter button is pressed.

- 1 Press the selector right when the camera is in shooting mode.
- 2 Highlight the current frame rate and press the selector right, then press selector up or down to choose a new value and press **MENU/OK** to select.
 - ⓘ Some frame rates may reduce the number of shots available.

- 3 Highlight the number of shots and press the selector right. Press the selector up or down to choose the number of shots in each burst and left or right to choose their distribution (the number on the left is taken *before* and the number on the right *after* the shutter button is pressed). Press **MENU/OK** when settings are complete and press **DISP/BACK** to return to shooting mode.

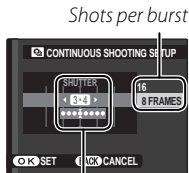

Distribution

- 4 Take photographs. The camera begins recording while the shutter button is pressed halfway, and completes the burst when the shutter button is pressed all the way down. The illustration shows a burst of eight shots, three before the shutter button is pressed and four after.

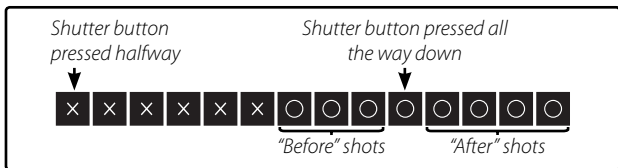

- ① If the shutter button is pressed all the way down before the number of frames selected for the "before" portion is recorded, the remaining frames will be taken after the shutter button is pressed all the way down.
- ① If the shutter button is pressed halfway for an extended period, the camera may record the burst before the shutter button is pressed all the way down.





AE BKT

Each time the shutter button is pressed, the camera takes three shots: one using the metered value for exposure, the second overexposed by the amount selected for the selector left or right, and the third underexposed by the same amount (the camera may not be able to use the selected bracketing increment if the amount of over- or under- exposure exceeds the limits of the exposure metering system).







ISO BKT

Press the selector left or right to highlight a bracketing amount. Each time the shutter is released, the camera will take a picture at the current sensitivity ( 100) and process it to create two additional copies, one with sensitivity raised and the other with sensitivity lowered by the selected amount (regardless of the amount selected, sensitivity will not exceed ISO 1600 or fall below ISO 200).

FILM SIMULATION BKT

Each time the shutter button is pressed, the camera takes one shot and processes it to create three copies with different  **FILM SIMULATION** settings ( 103):  **PROVIA/STANDARD** for the first,  **Velvia/VIVID** for the second, and  **ASTIA/SOFT** for the third.

■ DYNAMIC RANGE BKT





Each time the shutter button is pressed, the camera takes three shots at different  **DYNAMIC RANGE** settings (📖 102):  **100%** for the first,  **200%** for the second, and  **400%** for the third ( **ISO** can not exceed 3200; values less than 400 are not available when  is selected for  **IMAGE SIZE**).

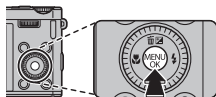

Focus Mode

To choose how the camera focuses, press **MENU/OK** to display the shooting menu and choose from the **FOCUS MODE** options.













The following options are available:

Mode	Description
 MANUAL	<p>Focus manually using the sub-command dial. Rotate the sub-command dial left to reduce the focus distance, right to increase. Choose for manual control of focus or in situations in which the camera is unable to focus using autofocus (📖 47). Intelligent Face Detection turns off automatically.</p> <p style="text-align: center;"><i>Reduce focus distance</i>  <i>Increase focus distance</i></p>
 AREA	<p>Choose the focus area manually (📖 65).</p>
 MULTI	<p>When the shutter button is pressed halfway, the camera detects high-contrast subjects near the center of the frame and selects the focus area automatically.</p>

Mode	Description
 CONTINUOUS	The camera continually adjusts focus to reflect changes in the distance to the subject even when the shutter button is not pressed halfway (note that this increases the drain on the battery). Choose for moving subjects.
 TRACKING	Position the subject in the center focus area and press the selector left. Focus will track the subject as it moves through the frame.

Manual Focus

- Use of a tripod is recommended. Focus may be affected if the camera moves.
 - Use the  **FOCUS CONTROL DIAL** option in the setup menu ( 130) to reverse the direction of rotation of the sub-command dial.
 - The camera will not focus if the sub-command dial is rotated past infinity.
 - While the  **FOCUS MODE** is selected to  **MANUAL**, macro mode cannot be used.
 - To focus using autofocus, press the selector left. This can be used to quickly focus on a chosen subject in manual focus mode.
-  Note that in  and  modes, the camera focuses continuously, increasing the drain on the battery, and that the sound of the camera focusing may be audible.
-  If a face is detected when  is selected, a  icon will be displayed and the camera will continuously adjust focus to maintain focus on the face.



MF FOCUS CHECK

If **ON** is selected for **MF FOCUS CHECK** in the setup menu (📖 125), rotating the sub-command dial magnifies the view in the LCD monitor.

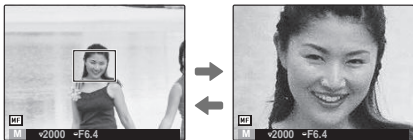
◆ The focus check area can be scrolled (📖 65).



Focus Frame Selection

When  **AREA** is selected for  **FOCUS MODE** in the shooting menu, focus position can be changed. Press **MENU/OK** to select  **FOCUS AREA** in the shooting menu and then press the selector up, down, left or right. The setting takes effect when you press the **MENU/OK** button again.

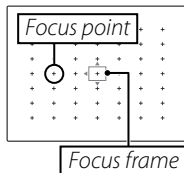

When framing a picture in the LCD monitor, you can choose the size of the focus frame. Press **MENU/OK**, select  **FOCUS AREA** in the shooting menu and then rotate the main-command dial. The frame size can be reduced up to 50% or enlarged up to 150% (returned to 100% by pressing the main-command dial). The setting takes effect when you press the **MENU/OK** again.

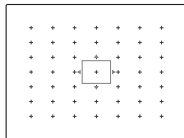

Intelligent Face Detection

Intelligent Face Detection sets focus and exposure for human faces anywhere in the frame, preventing the camera from focusing on the background in group portraits. Choose for shots that emphasize portrait subjects.

To use Intelligent Face Detection, press **MENU/OK** to display the shooting menu and select **ON** for  **FACE DETECTION SET-UP > FACE DETECTION**. Faces can be detected with the camera in vertical or horizontal orientation; if a face is detected, it will be indicated by a green border. If there is more than one face in the frame, the camera will select the face closest to the center; other faces are indicated by white borders.

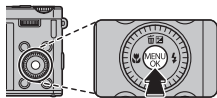

- ❶ In some modes, the camera may set exposure for the frame as a whole rather than the portrait subject.
- ❷ If the subject moves as the shutter button is pressed, their face may not be in the area indicated by the green border when the picture is taken.

Face Recognition

The camera can store information on the face and personal details (name, relationship, and birth date) of portrait subjects and assign these subjects priority for Intelligent Face Detection or display their names and other information during playback.



Adding New Faces

Follow the steps below to add faces to the face recognition database.

1 Select REGISTER.

Select **REGISTER** for  **FACE DETECTION SET-UP > FACE RECOGNITION.**

◆ To disable face recognition, select **OFF**.

2 Take a photograph.

After checking that the subject is facing the camera, frame the subject using the guides and take the photograph.

◆ If an error is displayed, take the photograph again.



3 Enter face recognition data.

Press **MENU/OK** to display face recognition data and enter the following information:

- **NAME:** Enter a name of up to 14 characters and press **MENU/OK**.
 - **BIRTHDAY:** Enter the subject's date of birth and press **MENU/OK**.
 - **CATEGORY:** Choose the option that describes your relationship to the subject and press **MENU/OK**.
- ◆ If you attempt to zoom in on the face of a person indicated by a green border in the face recognition database on their birthday, the camera will display their name and the message "Happy Birthday!"

Viewing, Editing, and Deleting Existing Data

Follow the steps below to view, edit, or delete face recognition data.

1 Select **VIEW & EDIT** for  **FACE RECOGNITION**.

2 Select a face.

3 View or edit face recognition data.

The name, category, or birth date can be edited as described in Step 3 of “Adding New Faces” (📖 68). To retake the photo, select **REPLACING IMAGE** and shoot a new portrait as described above.

◆ To delete face recognition data for the selected subject, select **ERASE**.

Adding Faces Automatically

To automatically add frequently-photographed subjects to the face recognition database, select **ON** for **AUTO REGISTRATION** in the face recognition menu. If the camera detects a face that has been photographed many times without being added to the database, it will display a message prompting you to create a new face recognition entry. Press **MENU/OK** and enter face recognition data.

◆ The camera may sometimes fail to recognize new faces automatically. If necessary, faces can be added manually using the **REGISTER** option.

Face Recognition

The camera can store up to eight faces. If you attempt to add a ninth face, a confirmation dialog will be displayed; use **ERASE** to make room for new faces by deleting existing data. **AUTO REGISTRATION** is disabled if there are already data for eight faces.

When Intelligent Face Detection ( 66) is on and the frame contains multiple subjects from the face recognition database, the camera displays the name of the subject that will be used to set focus and exposure (the subject shown by the green frame). If no name is entered, the camera will show “---”. Subjects identified using face recognition but not used to set focus and exposure are shown by orange frames, other subjects by white frames.

- ① The camera may fail to identify subjects in the face recognition database if they are not facing the camera or are only partly in the frame, or if details of the subjects' faces or expressions differ markedly from those in the database.

More on Playback

Playback Options

To view the most recent picture in the LCD monitor, press the  button.

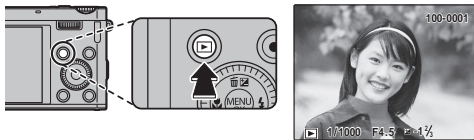

Press the selector right to view pictures in the order recorded, left to view pictures in reverse order. Keep the selector pressed to scroll rapidly to the desired frame.

❖ Pictures taken using other cameras are indicated by a  ("gift image") icon during playback.

Continuous Shooting

In the case of pictures taken in continuous shooting mode, only the first frame of each series will be displayed. Press the selector down to view the other pictures in the series.

★ Favorites: Rating Pictures

To rate the picture currently displayed in full-frame playback, press **DISP/BACK** and press the selector up and down to select from zero to five stars.

Playback Zoom

Rotate the main-command dial to zoom on pictures displayed in single-frame playback. When the picture is zoomed in, the selector can be used to view areas of the image not currently visible in the display.

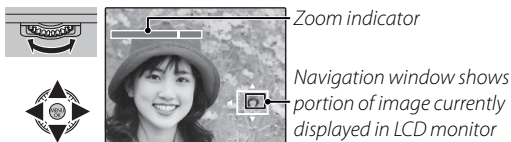

Press **DISP/BACK** to exit zoom.

- ◆ If the pictures before or after the current picture are the same size as the current picture, you can rotate the sub-command dial to view the other pictures without changing the zoom ratio. This option is not available if the pictures are not the same size as the current picture.
- ◆ The maximum zoom ratio varies with image size. Playback zoom is not available with cropped or resized copies saved at a size of **640** or smaller.

Multi-Frame Playback

To change the number of images displayed, rotate the main-command dial. Rotate the main-command dial to the left to increase the number of images displayed to two, nine, or one hundred, and rotate it to the right to view fewer images.



When two or more images are displayed, use the selector to highlight images and press **MENU/OK** to view the highlighted image full frame. In the nine- and hundred-frame displays, use the selector to view more pictures.

Deleting Pictures

To delete individual pictures, multiple selected pictures, or all pictures, press **MENU/OK**, select  **ERASE**, and choose from the options below. *Note that deleted pictures can not be recovered. Copy important pictures to a computer or other storage device before proceeding.*



Option	Description
FRAME	Press the selector left or right to scroll through pictures and press MENU/OK to delete the current picture (a confirmation dialog is not displayed).
SELECTED FRAMES	Highlight pictures and press MENU/OK to select or deselect (pictures in photobooks or print orders are shown by ). When the operation is complete, press DISP/BACK to display a confirmation dialog, then highlight OK and press MENU/OK to delete the selected pictures.
ALL FRAMES	A confirmation dialog will be displayed; highlight OK and press MENU/OK to delete all unprotected pictures (if a memory card is inserted, only the pictures on the memory card will be affected; the pictures in internal memory are only deleted if no memory card is inserted). Pressing DISP/BACK cancels deletion; note that any pictures deleted before the button was pressed can not be recovered.









- ◆ Protected pictures can not be deleted. Remove protection from any pictures you wish to delete ( 117).
- ◆ If a message appears stating that the selected images are part of a DPOF print order, press **MENU/OK** to delete the pictures.

Image Search

Search for pictures.

- 1 Select  **IMAGE SEARCH** in the playback menu, highlight one of the following search criteria, and press **MENU/OK**:
 - **BY DATE**: Search by date.
 - **BY FACE**: Search for faces from the face recognition database.
 - **BY ★ FAVORITES**: Search by rating.
 - **BY SCENE**: Search by scene.
 - **BY TYPE OF DATA**: Find all still pictures or all movies.
 - **BY UPLOAD MARK**: Find all pictures selected for upload to a specified destination.
- 2 Select a search condition. Only pictures that match the search condition will be displayed. To delete or protect selected pictures or to view the search results in a slide show, press **MENU/OK** and choose  **ERASE** ( 74),  **PROTECT** ( 117), or  **SLIDE SHOW** ( 114).

PhotoBook Assist

Create books from your favorite photos.

Creating a PhotoBook

1 Select **NEW BOOK** for  **PHOTOBOOK ASSIST** in the playback menu and choose from the following options:

- **SELECT FROM ALL:** Choose from all available pictures.
- **SELECT BY IMAGE SEARCH:** Choose from pictures matching selected search conditions ( 75).

◆ Movies, 3D photos, and photographs  640 or smaller can not be selected for photobooks.

2 Scroll through the images and press the selector up to select or deselect. To display the current image on the cover, press the selector down. Press **MENU/OK** to exit when the book is complete.

◆ The first picture selected becomes the cover image. Press the selector down to select a different image for the cover.

3 Select **COMPLETE PHOTOBOOK** (to select all photos or all photos matching the specified search conditions for the book, choose **SELECT ALL**). The new book will be added to the list in the photobook assist menu.

ⓘ Books can contain up to 300 pictures.

ⓘ Books that contain no photos are automatically deleted.

Viewing Photobooks

Highlight a book in the photobook assist menu and press **MENU/OK** to display the book, then press the selector left or right to scroll through the pictures.

Editing and Deleting Photobooks

Display the photobook and press **MENU/OK**. The following options will be displayed; select the desired option and follow the on-screen instructions.

- **EDIT:** Edit the book as described in “Creating a PhotoBook” (📖 76).
- **ERASE:** Delete the book.

Photobooks

Photobooks can be copied to a computer using the supplied MyFinePix Studio software.

Viewing Panoramas

If you press the selector down when a panorama is displayed full frame, the camera will play back the picture from left to right or from bottom to top. To pause playback, press the selector down; press the selector down again to resume. To exit to full-frame playback, press the selector up while panorama playback is in progress. Once displayed in full-frame playback, panoramas can be zoomed in or out using the main-command dial or deleted by pressing the selector up (🗑).

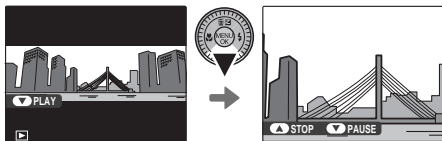

- ▶ 📺 panoramas play back in an endless loop (📖 35); the playback direction can be controlled by pressing the selector left or right. The camera will not turn off automatically while playback is in progress (📖 126).

Viewing Photo Information

Photo information can be viewed by pressing **DISP/BACK** to cycle through indicators (📖 7) until the following display appears:

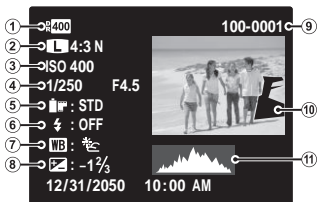

- ① Dynamic range
- ② Image size and quality
- ③ Sensitivity
- ④ Shutter speed/aperture
- ⑤ Film simulation
- ⑥ Flash mode
- ⑦ White balance
- ⑧ Exposure compensation
- ⑨ Frame number
- ⑩ Picture (overexposed areas blink on and off)
- ⑪ Histogram

Additional photo information

Additional photo information can be viewed by pressing the **E-Fn** button. Press the **E-Fn** button to cycle the display.

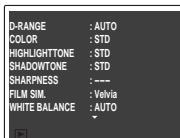

📍 The active focus point is shown by a "+" icon.

Zooming in on the Focus Point

Press the main-command dial to zoom in on the focus point.

Press **DISP/BACK** or **MENU/OK** to return to full-frame playback.



Movies

Recording Movies

Press **⏏** to shoot a movie. During recording, the following indicators will be displayed and sound will be recorded via the built-in microphone (be careful not to cover the microphone during recording).

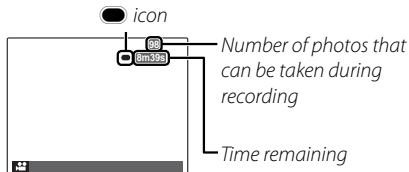

To end recording, press **⏏** again. Recording ends automatically when the movie reaches maximum length or memory is full. For information on the maximum footage that can be recorded, see page 146.

Automatic Scene Selection





In **EXR AUTO** mode, the camera selects the scene according to shooting conditions and the type of subject: **👤** (portraits), **🌄** (poorly-lit landscapes), **👤** (poorly-lit portraits), **🌄** (landscapes), **👤** (close-ups), **👤** (backlit portraits), or **👤** (other subjects).



Scene icon







Taking Photographs During Recording

Press the shutter button to take a photograph during recording.

- ◆ The method used to record photographs can be selected using the  **MOVIE SET-UP > STILL SHOOTING IN MOVIE** option ( 110).
 - ◆ The photo is saved separately from the movie and does not appear as part of the movie.
 - ① Photos can not be taken while a high-speed movie is being recorded.
 - ① The number of photos that can be taken is limited.
-
- ◆ Zoom can be adjusted while recording is in progress.
 - ◆ If the subject is poorly lit, the AF-assist lamp may light to assist the focus operation. To turn the AF-assist lamp off, select **OFF** for  **AF ILLUMINATOR** ( 128).
 - ◆ Focus, exposure, and white balance are adjusted automatically throughout recording. The color and brightness of the image may vary from that displayed before recording begins.
 - ◆ Sounds made by the camera may be recorded.
-
- ① The indicator lamp lights while movies are being recorded. Do not open the battery chamber during shooting or while the indicator lamp is lit. Failure to observe this precaution could prevent the movie from being played back.
 - ① Vertical or horizontal streaks may appear in movies containing very bright subjects. This is normal and does not indicate a malfunction.
 - ① The temperature of the camera may rise if it is used to record movies for an extended period or if the ambient temperature is high. This is normal and does not indicate a malfunction.
 - ① The mode selected may vary with shooting conditions.

Movie Frame Size

Before recording, select a frame size using the  **MOVIE SET-UP > MOVIE MODE** option.

Option	Description
 1920 × 1080	Full HD (High Definition).
 1280 × 720	High Definition.
 640 × 480	Standard definition.
 640 × 480 (70 fps)	High speed movie. Sound is not recorded, and focus, exposure, and white balance are not adjusted automatically. Black bands appear at the top and
 320 × 240 (120 fps)	bottom of movies recorded at  320 × 112 .
 320 × 112 (200 fps)	

Viewing Movies

During playback, movies are displayed in the LCD monitor as shown at right. The following operations can be performed while a movie is displayed:



Option	Description
Start/pause playback	Press the selector down to start playback. Press again to pause. While playback is paused, you can press the selector left or right to rewind or advance one frame at a time.
End playback/delete	Press the selector up to end playback.
Adjust speed	Press the selector left or right to adjust playback speed during playback.
Adjust volume	Press MENU/OK to pause playback and display volume controls. Press the selector up or down to adjust the volume and press MENU/OK to exit. Volume can also be adjusted using the [F] SOUND SET-UP > PLAYBACK VOLUME option (📖 124).

Playback Speed

Press the selector left or right to adjust playback speed. Speed is shown by the number of arrows (▶ or ◀).

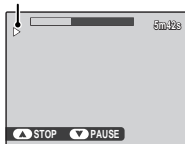

ⓘ Do not cover the speaker during playback.

Connections

Viewing Pictures on TV

Connect the camera to a TV to show pictures to a group.

- 1 Turn the camera off and connect an optional A/V cable as shown below.

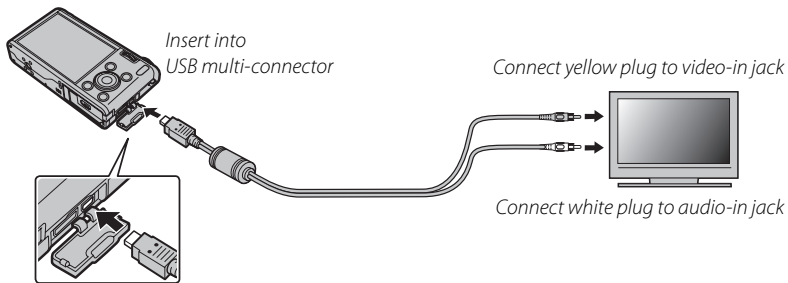

- ◆ Image quality drops during movie playback.

Connecting the Camera to High Definition (HD) TVs

An HDMI cable (available from third-party suppliers) can be used to connect the camera to High Definition (HD) devices (playback only). The USB and A/V cables can not be used while an HDMI cable is connected.

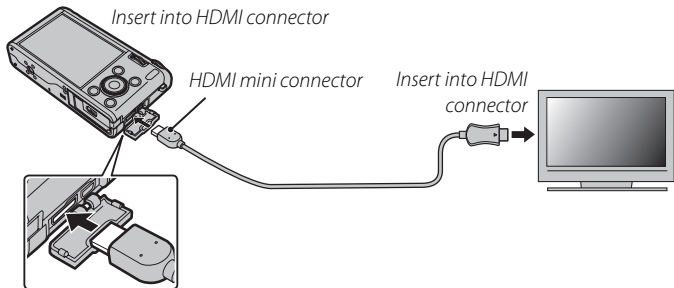

◆ When an HDMI cable is connected, pictures and sound are played back on the TV.

- ① When connecting cables, be sure the connectors are fully inserted.
- 2 Tune the television to the video or HDMI input channel. See the documentation supplied with the television for details.
- 3 Press the  button for about a second to turn the camera on. The camera monitor turns off and pictures and movies are played back on the TV. Note that the camera volume controls have no effect on sounds played on the TV; use the television volume controls to adjust the volume.

Printing Pictures via USB

If the printer supports PictBridge, the camera can be connected directly to the printer as shown below and pictures can be printed without first being copied to a computer. Note that depending on the printer, not all the functions described below may be supported.



- 1 Connect the supplied USB cable as shown and turn the printer on.

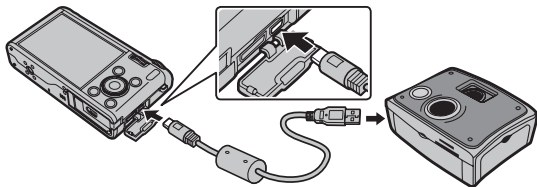

- 2 Turn the camera on.
- 3 Press the selector left or right to display a picture you wish to print.
- 4 Press the selector up or down to choose the number of copies (up to 99).
- 5 Repeat steps 3–4 to select additional pictures. Press **MENU/OK** to display a confirmation dialog when settings are complete.

6 Press **MENU/OK** to start printing. Printing can be interrupted by pressing **DISP/BACK**, but note that some printers may not respond immediately. If the printer stops before printing is complete, turn the camera off and then on again.

7 After confirming that **PRINTING** has cleared from the camera display, turn the camera off and disconnect the USB cable.

- ◆ Pictures can be printed from internal memory or a memory card that has been formatted in the camera.
- ◆ If no pictures are selected, the camera will print one copy of the current picture.
- ◆ Page size, print quality, and border selections are made using the printer.

Printing the Date of Recording

To print the date of recording on pictures, press **DISP/BACK** in the PictBridge display and select **PRINT WITH DATE**  in the PictBridge menu (to print pictures without the date of recording, select **PRINT WITHOUT DATE**). Some printers do not support date printing. See the printer manual for details.



Printing the DPOF Print Order

The  **PRINT ORDER (DPOF)** option can be used to create a digital “print order” for PictBridge-compatible printers (📖 87) or devices that support DPOF.

DPOF

DPOF (Digital Print Order Format) is a standard that allows pictures to be printed from “print orders” stored in internal memory or on a memory card. The information in the order includes the pictures to be printed and the number of copies of each picture.



- 1 Select playback mode and press **MENU/OK** to display the playback menu.
- 2 Highlight  **PRINT ORDER (DPOF)** and press **MENU/OK**.
- 3 Highlight one of the following options and press **MENU/OK**:
 - **WITH DATE** : Print the date of recording on pictures.
 - **WITHOUT DATE**: Do not print the date of recording on pictures.

 Some printers do not support date printing. See the printer manual for details.
- 4 Press the selector left or right to display a picture you wish to add to or remove from the print order.

- 5** Press the selector up or down to choose the number of copies (up to 99). To remove a picture from the print order, press the selector down until the number of copies is zero.
- 6** Repeat Steps 4–5 to complete the print order and press **MENU/OK** when settings are complete.
- 7** A confirmation dialog will be displayed. Press **MENU/OK** to save the print order.

 - ◆ Remove the memory card to create or modify a print order for the pictures in internal memory.
 - ◆ Print orders can contain a maximum of 999 pictures.
 - ◆ If a memory card is inserted containing a print order created by another camera, a message will be displayed. Create a new print order as described above.

Viewing Pictures on a Computer

The supplied software can be used to copy pictures to a computer, where they can be stored, viewed, organized, and printed. Before proceeding, install the software as described below. *Do not connect the camera to the computer until installation is complete.*

Windows: Installing MyFinePix Studio

1 Confirm that the computer meets the following system requirements:

	Windows 7 (SP 1)/Windows Vista (SP 2) ¹	Windows XP (SP 3) ¹
CPU	3 GHz Pentium 4 or better (2.4GHz Core 2 Duo or better) ²	2 GHz Pentium 4 or better (2.4GHz Core 2 Duo or better) ²
RAM	1 GB or more	512 MB or more (1 GB or more) ²
Free disk space	2 GB or more	
GPU	Supports DirectX 9 or later (recommended)	Supports DirectX 7 or later (required; performance not guaranteed with other GPUs)
Video	1,024×768 pixels or more with 24-bit color or better	
Other	<ul style="list-style-type: none">• Built-in USB port recommended. Operation is not guaranteed with other USB ports.• .NET Framework 3.5 Service Pack 1 required when uploading images or using Map Viewer.• Internet connection (broadband recommended) required to install .NET Framework (if necessary), to use auto update feature, and when performing such tasks as sharing pictures on-line or via e-mail.	

1 Other versions of Windows are not supported. Only pre-installed operating systems are supported; operation is not guaranteed on home-built computers or computers that have been upgraded from earlier versions of Windows.

2 Recommended when displaying HD movies.

- 2 Start the computer. Log in to an account with administrator privileges before proceeding.
- 3 Exit any applications that may be running and insert the installer CD in a CD-ROM drive.

 **Windows 7/Windows Vista**

If an AutoPlay dialog is displayed, click **SETUP.EXE**. A “User Account Control” dialog will then be displayed; click **Yes** (Windows 7) or **Allow** (Windows Vista).

The installer will start automatically; click **Install MyFinePix Studio** and follow the on-screen instructions to install MyFinePix Studio and RAW FILE CONVERTER.

 **If the Installer Does Not Start Automatically**

If the installer does not start automatically, select **Computer** or **My Computer** from the Start menu, then double-click the **FINEPIX** CD icon to open the FINEPIX CD window and double-click **setup** or **SETUP.EXE**.

- 4** If prompted to install Windows Media Player or DirectX, follow the on-screen instructions to complete installation.
- 5** Remove the installer CD from the CD-ROM drive when installation is complete. Store the installer CD in a dry location out of direct sunlight in case you need to re-install the software.

Installation is now complete. Proceed to “Connecting the Camera” (📖 96).

Macintosh: Installing FinePixViewer

- 1 Confirm that the computer meets the following system requirements:

CPU	PowerPC or Intel (Core 2 Duo or better)*
OS	Pre-installed copies of Mac OS X version 10.5–10.6 (visit http://www.fujifilm.com/support/digital_cameras/compatibility/ for more information). Mac OS X version 10.7 and later not supported.
RAM	256 MB or more (1 GB or more)*
Free disk space	A minimum of 200 MB required for installation with 400 MB available when FinePixViewer is running
Video	800 × 600 pixels or more with thousands of colors or better
Other	Built-in USB port recommended. Operation is not guaranteed with other USB ports.

* Recommended when displaying HD movies.

- 2 After starting the computer and quitting any applications that may be running, insert the installer CD in a CD-ROM drive and double-click **Installer for Mac OS X**.

Viewing RAW Images

RAW FILE CONVERTER software is required to view RAW images on a computer. To install RAW FILE CONVERTER, double-click **SILKYRFXCEXInstaller**. RAW FILE CONVERTER is supported under Mac OS X versions 10.5 to 10.7.

- 3** An installer dialog will be displayed; click **Installing FinePixViewer** to start installation. Enter an administrator name and password when prompted and click **OK**, then follow the on-screen instructions to install FinePixViewer. Click **Exit** to quit the installer when installation is complete.
- 4** Remove the installer CD from the CD-ROM drive. Note that you may be unable to remove the CD if Safari is running; if necessary, quit Safari before removing the CD. Store the installer CD in a dry location out of direct sunlight in case you need to re-install the software.
- 5 Mac OS X 10.5:** Open the “Applications” folder, start Image Capture, and select **Preferences...** from the Image Capture application menu. The Image Capture preferences dialog will be displayed; choose **Other...** in the **When a camera is connected, open** menu, then select **FPVBridge** in the “Applications/FinePixViewer” folder and click **Open**. Quit Image Capture.
Mac OS X 10.6: Connect the camera and turn it on. Open the “Applications” folder and start Image Capture. The camera will be listed under **DEVICES**; select the camera and choose **FPVBridge** from the **Connecting this camera opens** menu and click **Choose**. Quit Image Capture.

Installation is now complete. Proceed to “Connecting the Camera” (📖 96).

Connecting the Camera

- 1** If the pictures you wish to copy are stored on a memory card, insert the card into the camera.
 - ◆ Windows users may require the Windows CD when starting the software for the first time.
 - Ⓢ Loss of power during transfer could result in loss of data or damage to internal memory or the memory card. Charge the battery before connecting the camera.
- 2** Turn the camera off and connect the supplied USB cable as shown, making sure the connectors are fully inserted. Connect the camera directly to the computer; do not use a USB hub or keyboard.

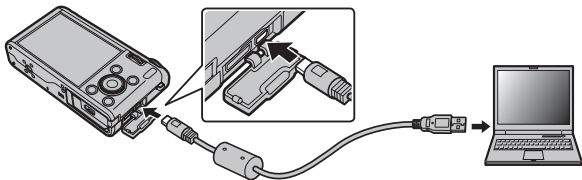

- 3** Press the  button for about a second to turn the camera on and follow the on-screen instructions to copy pictures to the computer. To exit without copying pictures, click **Cancel**.

For more information on using the supplied software, start the application and select the appropriate option from the **Help** menu.

- ❗ If a memory card containing a large number of images is inserted, there may be a delay before the software starts and you may be unable to import or save images. Use a memory card reader to transfer pictures.
- ❗ Make sure that the computer does not display a message stating that copying is in progress and that the indicator lamp is out before turning the camera off or disconnecting the USB cable (if the number of images copied is very large, the indicator lamp may remain lit after the message has cleared from the computer display). Failure to observe this precaution could result in loss of data or damage to internal memory or the memory card.
- ❗ Disconnect the camera before inserting or removing memory cards.
- ❗ In some cases, it may not be possible to access pictures saved to a network server using the supplied software in the same way as on a standalone computer.
- ❗ The user bears all applicable fees charged by the phone company or Internet service provider when using services that require an Internet connection.

Disconnecting the Camera

After confirming that the indicator lamp is out, turn the camera off and disconnect the USB cable.

Uninstalling the Supplied Software

Only uninstall the supplied software when it is no longer required or before beginning reinstallation. After quitting the software and disconnecting the camera, drag the “FinePixViewer” folder from “Applications” into the Trash and select **Empty Trash** in the **Finder** menu (Macintosh), or open the control panel and use “Programs and Features” (Windows 7/Windows Vista) or “Add or Remove Programs” (Windows XP) to uninstall MyFinePix Studio. Under Windows, one or more confirmation dialogs may be displayed; read the contents carefully before clicking **OK**.

Menus

Using the Menus: Shooting Mode

Using the Shooting Menu

1 Display the shooting menu.

- 1.1 Press **MENU/OK** during shooting to display the shooting menu.

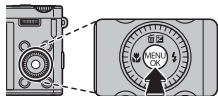

- 1.2 Press the selector left to highlight the current tab.

- 1.3 Press the selector up or down to highlight the tab containing the desired option.

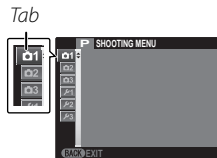

- 1.4 Press the selector right to place the cursor in the menu.

2 Adjust settings.

Highlight items and press the selector right to view options, then highlight an option and press **MENU/OK**. Press **DISP/BACK** to exit when settings are complete.

Shooting Menu Options

 **SCENE POSITION** (default: )

Choose a scene for **SP** mode ( 41).

 **EXR MODE** (default: )

Choose an option for **EXR** mode ( 31).

 **Adv. MODE** (default: **ADVANCED FILTER**)

Choose an advanced shooting mode ( 33).

 **ISO** (default: **AUTO**)

Control the camera's sensitivity to light. Higher values can reduce blur; note, however, that mottling may appear in pictures taken at high sensitivities.



Option	Description
AUTO	Sensitivity is adjusted automatically in response to shooting conditions.
AUTO (3200) / AUTO (1600) / AUTO (800) / AUTO (400)	As above, except that sensitivity will not be raised above the value in parentheses.
12800 / 6400 / 5000 / 4000 / 3200 / 2500 / 2000 / 1600 / 1250 / 1000 / 800 / 640 / 500 / 400 / 320 / 250 / 200 / 100	Sensitivity is set to the specified value, which is shown in the display.

IMAGE SIZE(default: **L** 4:3)

Choose the image size and aspect ratio at which pictures are recorded. Large pictures can be printed at large sizes with no drop in quality, while small pictures require less memory, allowing more pictures to be recorded.

**Size Versus Aspect Ratio****Size**

Option	Prints at sizes up to
L	34×25 cm (13.5×10 in.)
M	24×18 cm (9.5×7 in.)
S	17×13 cm (7×5 in.)

Aspect ratio

4:3: Pictures have the same proportions as the camera display.

3:2: Pictures have the same proportions as a frame of 35 mm film.

16:9: Suited for display on High Definition (HD) devices.

1:1: Pictures are square.

IMAGE QUALITY(default: **FINE**)

Choose how much image files are compressed.

Option	Description
FINE	Low compression. Select for higher image quality.
NORMAL	High compression. Select this option to store more pictures.

D-Range DYNAMIC RANGE(default: **AUTO**)

Control contrast. Higher values are recommended for scenes that include both sunlight and deep shade or for increased contrast with such subjects as sunlight on water, brightly-lit autumn leaves, portraits taken against a blue sky, and white objects or people wearing white; note, however, that mottling may appear in pictures taken at higher values. If **AUTO** is selected, the camera will automatically select values between 100% and 400% in response to shooting conditions.

Option		Description
AUTO	100%	Increase contrast when shooting indoors or under overcast skies.
	200%	
	400%	
800%	Reduce loss of detail in highlights and shadows when photographing high-contrast scenes.	
1600%		

1600% and **800%** are available only when **D-RANGE PRIORITY** is selected in **EXR** mode and an option other than **Velvia/VIVID** or **ASTIA/SOFT** is selected for **FILM SIMULATION**.









FILM SIMULATION(default: **STD**)

Simulate the effects of different types of film.

Option	Description
STD (PROVIA/STANDARD)	Standard color reproduction. Suited to a wide range of subjects, from portraits to landscapes.
VIVID (Velvia/VIVID)	A high-contrast palette of saturated colors, suited to nature photographs.
SOFT (ASTIA/SOFT)	A soft-toned palette of less saturated colors.
MONOCHROME	Take pictures in black and white.
MONOCHROME + Ye FILTER	Take black-and-white pictures with slightly increased contrast. This setting also slightly tones down the brightness of the sky.
MONOCHROME + R FILTER	Take black-and-white pictures with increased contrast. This setting also tones down the brightness of the sky.
MONOCHROME + G FILTER	Soften skin tones in black-and-white portraits.
SEPIA (SEPIA)	Take pictures in sepia.

WB WHITE BALANCE**(default: AUTO)**



If **AUTO** does not produce natural colors (for example, when taking close-ups), select  and measure a value for white balance or choose the option that matches the light source.

Option	Description
AUTO	White balance adjusted automatically.
	Measure a value for white balance.
	Selecting this option displays a list of color temperatures; highlight a temperature and press MENU/OK .
	For subjects in direct sunlight.
	For subjects in the shade.
	Use under “daylight” fluorescent lights.
	Use under “warm white” fluorescent lights.
	Use under “cool white” fluorescent lights.
	Use under incandescent lighting.
	For underwater photography

WB WHITE BALANCE (Continued)(default: **AUTO**)**☉ ☉: Custom White Balance**

Choose  to adjust white balance for unusual lighting conditions. White balance measurement options will be displayed; frame a white object so that it fills the display and press the shutter button all the way down to measure white balance.

- If **“COMPLETED!” is displayed**, press **MENU/OK** to set white balance to the measured value.
- If **“UNDER” is displayed**, raise exposure compensation ( 49) and try again.
- If **“OVER” is displayed**, lower exposure compensation and try again.

☛ For greater precision, adjust  **FILM SIMULATION**,  **ISO**, and  **DYNAMIC RANGE** before measuring white balance.

- ☛ At settings other than , auto white balance is used with the flash.
- ☛ Results vary with shooting conditions. Play pictures back after shooting to check colors in the display.

☉ K: Color Temperature

Color temperature is an objective measure of the color of a light source, expressed in Kelvin (K). Light sources with a color temperature close to that of direct sunlight appear white; light sources with a lower color temperature have a yellow or red cast, while those with a higher color temperature are tinged with blue. You can match color temperature to the light source as shown in the following table, or choose options that differ sharply from the color of the light source to make pictures “warmer” or “colder”.

◀ Choose for redder light sources
or “colder” pictures

Choose for bluer light sources
or “warmer” pictures ▶

2,000K

Candlelight

Sunset/sunrise

5,000K

Direct sunlight

Shade

15,000K

Blue sky

WB SHIFT

White balance can be fine-tuned. Adjust the selected color axis (**R-Cy**=Red-Cyan or **B-Ye**=Blue-Yellow) by +9 to -9 in increments of one.

COLOR

(default: **MID**)

Adjust color density.

SHARPNESS

(default: **STD**)

Choose whether to sharpen or soften outlines.

HIGHLIGHT TONE

(default: **STD**)

Adjust the appearance of highlights.

SHADOW TONE

(default: **STD**)

Adjust the appearance of shadows.

NOISE REDUCTION

(default: **STD**)

Choose the amount of noise reduction.

INTELLIGENT DIGITAL ZOOM







(default: **OFF**)

If ON is selected, intelligent digital zoom magnifies the image to 2x while processing it for sharp, high-resolution results.

- ◆ Intelligent digital zoom may end when another mode is selected.
- ◆ Intelligent digital zoom may sometimes produce lower quality images than optical zoom.
- ◆ The time needed to record images increases.
- ◆ The effects are not visible in the display during shooting.
- ◆ Intelligent digital zoom is not available in continuous mode or during movie recording.

CONTINUOUS

(default: )

Capture motion in a series of pictures (🗨 57). Choose from , , , ,  and .

ADVANCED ANTI BLUR(default: **ON**)

Select **ON** to enable advanced anti blur in **EXR** mode (📖 32).



FACE DETECTION SET-UP

Adjust face detection and face recognition options.

Option	Description
FACE DETECTION	Choose whether the camera automatically detects and sets focus and exposure for human portrait subjects (📖 66).
FACE RECOGNITION	Add portrait subjects to the face recognition database. These subjects will be given priority during Intelligent Face Detection, and their names and other information can be viewed during playback (📖 67).

PHOTOMETRY(default: )

Choose how the camera meters exposure when Intelligent Face Detection is off.

Option	Description
 MULTI	Automatic scene recognition is used to adjust exposure for a wide range of shooting conditions.
 SPOT	The camera meters lighting conditions at the center of the frame. Recommended when the background is much brighter or darker than the main subject.
<input type="checkbox"/> AVERAGE	Exposure is set to the average for the entire frame. Provides consistent exposure across multiple shots with the same lighting, and is particularly effective for landscapes and portraits of subjects dressed in black or white.

FOCUS MODE

This option controls how the camera focuses subjects (📖 62).

FOCUS AREA



This option controls how the camera selects the focus area for photographs ( 65). Regardless of the option selected, the camera will focus on the subject in the center of the frame when macro mode is on.

Fn BUTTON

(default: )

Choose the role played by the **Fn** button ( 54).

E-Fn BUTTON CUSTOM SETTING

Choose the role played by the  button, the  button and the selector up, down, left and right ( 55).

DISP. CUSTOM SETTING

Choose the items displayed in the LCD monitor. The following items can be displayed:

FRAMING GUIDELINE*	ELECTRONIC LEVEL
WHITE BALANCE	APERTURE/S-SPEED/ISO
HISTOGRAM	FRAMES REMAINING
IMAGE SIZE/QUALITY	BATTERY LEVEL
PHOTOMETRY	FLASH
FILM SIMULATION	DYNAMIC RANGE
EXP. COMPENSATION	

* You can also select the grid type (125).

See pages 6 – 7 for the locations of these items in the displays.

Virtual Horizon

Selecting ELECTRONIC LEVEL displays a virtual horizon. The camera is level when the two lines overlap.

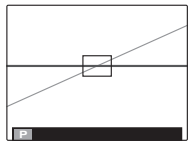









◆ The virtual horizon may not be displayed if the camera lens is pointed up or down.

FLASH**(default: ±0)**

Adjust flash brightness. Choose from values between +2/3 EV and -2/3 EV. The default setting is ±0. Note that the desired results may not be achieved depending on shooting conditions and the distance to the subject.

 **MOVIE SET-UP**

Adjust movie settings.

Option	Description
MOVIE MODE	Choose a frame size for movies ( 83).
MOVIE AF MODE	<p>This option controls how the camera selects the focus area for movies.</p> <ul style="list-style-type: none">  CENTER: When shooting starts, the camera focuses on the subject in the center of the frame.  CONTINUOUS: The camera continuously adjusts focus to reflect changes in the distance to subjects near the center of the frame. <p>◆ Note that in  mode, the camera focuses continuously, increasing the drain on the battery, and that the sound of the camera focusing may be audible.</p> <p>◆ If a face is detected when  is selected, a  icon will be displayed and the camera will continuously adjust focus to maintain focus on the face.</p>
STILL SHOOTING IN MOVIE	<p>Choose how the camera records photographs taken during movie recording.</p> <ul style="list-style-type: none"> MOVIE PRIORITY: The camera takes a photograph without interrupting movie recording. Image size is determined by the option selected for MOVIE MODE. STILL IMAGE PRIORITY: The camera interrupts filming to take the photograph and resumes filming automatically when recording is complete. Image size is determined by the option selected for  IMAGE SIZE, but note that the photograph will be recorded at size  if  is selected.

 **CUSTOM SET**Save settings for **P, S, A, M** and all **EXR** modes except  ( 46).

Using the Menus: Playback Mode

Using the Playback Menu

1 Display the playback menu.

- 1.1 Press **MENU/OK** during playback to display the playback menu.

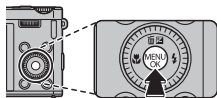

- 1.2 Press the selector left to highlight the current tab.

- 1.3 Press the selector up or down to highlight the tab containing the desired option.

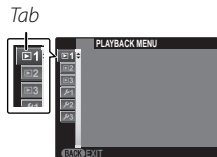

- 1.4 Press the selector right to place the cursor in the menu.

2 Adjust settings.

Highlight items and press the selector right to view options, then highlight an option and press **MENU/OK**. Press **DISP/BACK** to exit when settings are complete.

Playback Menu Options

PHOTOBOOK ASSIST

Create books from your favorite photos ( 76).

IMAGE SEARCH

Search for pictures ( 75).

ERASE

Delete all or selected pictures ( 74).

📷 MARK FOR UPLOAD TO

Select pictures for upload to YouTube or Facebook using MyFinePix Studio (Windows only).

■ Selecting Pictures for Upload

- 1 Select **YouTube** to choose movies for upload to YouTube, **FACEBOOK** to choose photos and movies for upload to Facebook.
- 2 Press the selector left or right to display pictures and press **MENU/OK** to select or deselect. Press **DISP/BACK** to exit when all the desired pictures are selected.

- 📷 Only movies can be selected for upload to YouTube.
- 📷 During playback, selected pictures are indicated by 📺 **YouTube** or 📺 **FACEBOOK** icons.

■ RESET ALL: Deselecting All Pictures

Choose **RESET ALL** to deselect all pictures. If the number of pictures affected is very large, a message will be displayed while the operation is in progress. Press **DISP/BACK** to exit before the operation is complete.

■ Uploading Pictures (Windows Only)

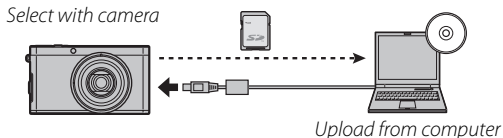

Selected pictures can be uploaded using the **YouTube/Facebook Upload** option in MyFinePix Studio.



For information on installing MyFinePix Studio and connecting the camera to a computer, see "Viewing Pictures on a Computer" (📖 91).

SLIDE SHOW(default: **MULTIPLE**)

View pictures in an automated slide show. Choose the type of show and press **MENU/OK** to start. Press **DISP/BACK** at any time during the show to view on-screen help. The show can be ended at any time by pressing **MENU/OK**.

Option	Description
NORMAL	Press selector left or right to go back or skip ahead one frame. Select FADE-IN for fade transitions between frames.
NORMAL 	As above, except that camera automatically zooms in on faces selected with Intelligent Face detection.
FADE-IN 	
MULTIPLE	Display several pictures at once.

◆ The camera will not turn off automatically while a slide show is in progress.

RAW RAW CONVERSION

Create JPEG copies of RAW pictures. The original image data are unaffected, allowing a single RAW image to be processed in a multitude of different ways.

1 Select **RAW RAW CONVERSION** in the playback menu.

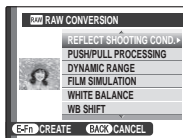

2 Press the selector up or down to highlight a setting and press the selector right to select. Press the selector up or down to highlight the desired option and press **MENU/OK** to select and return to the settings list. Repeat this step to adjust additional settings.

3 Press the **E-Fn** button to preview the JPEG copy. Press **MENU/OK** to save the copy or press **DISP/BACK** to return to Step 2.





RAW RAW CONVERSION (Continued)

Setting	Description
REFLECT SHOOTING COND.	Create a JPEG copy using the settings in effect at the time the photo was taken.
PUSH/PULL PROCESSING	Adjust exposure by -1 EV to +1 EV in increments of 1/3 EV (📖 49).
DYNAMIC RANGE	Enhance details in highlights for natural contrast (📖 102).
FILM SIMULATION	Simulate the effects of different types of film (📖 103).
WHITE BALANCE	Adjust white balance (📖 104).
WB SHIFT	Fine-tune white balance (📖 106).
COLOR	Adjust color density (📖 106).
SHARPNESS	Sharpen or soften outlines (📖 106).
NOISE REDUCTION	Process the copy to reduce mottling (📖 106).
HIGHLIGHT TONE	Adjust highlights (📖 106).
SHADOW TONE	Adjust shadows (📖 106).

RED EYE REMOVAL

If the current picture is marked with a  icon to indicate that it was taken with Intelligent Face Detection, this option can be used to remove red-eye. The camera will analyze the image; if red-eye is detected, the image will be processed to create a copy with reduced red-eye.

- 1 Display the desired picture.
- 2 Select  **RED EYE REMOVAL** in the playback menu.
- 3 Press **MENU/OK**.

- ◆ Red eye may not be removed if the camera is unable to detect a face or the face is in profile. Results may differ depending on the scene. Red eye can not be removed from pictures that have already been processed using red-eye removal or pictures created with other devices.
- ◆ The amount of time needed to process the image varies with the number of faces detected.
- ◆ Copies created with  **RED EYE REMOVAL** are indicated by a  icon during playback.

PROTECT

Protect pictures from accidental deletion.

- 1 Select  **PROTECT** in the playback menu.
- 2 Highlight one of the following options and press **MENU/OK**:
 - **FRAME**: Protect selected pictures. Press the selector left or right to view pictures and press **MENU/OK** to select or deselect. Press **DISP/BACK** when the operation is complete.
 - **SET ALL**: Protect all pictures.
 - **RESET ALL**: Remove protection from all pictures.

① Protected pictures will be deleted when the memory card or internal memory is formatted (see 131).

CROP

Create a cropped copy of the current picture.

- 1 Display the desired picture.
 - 2 Select  **CROP** in the playback menu.
 - 3 Rotate the main-command dial to zoom in and out and use the selector to scroll the picture until the desired portion is displayed.
 - 4 Press **MENU/OK** to display a confirmation dialog.
 - 5 Press **MENU/OK** again to save the cropped copy to a separate file.
- ◆ Larger crops produce larger copies; all copies have an aspect ratio of 4:3. If the size of the final copy will be **640**, **OK** will be displayed in yellow.

RESIZE

Create a small copy of the current picture.

- 1 Display the desired picture.
 - 2 Select  **RESIZE** in the playback menu.
 - 3 Highlight a size and press **MENU/OK** to display a confirmation dialog.
 - 4 Press **MENU/OK** to save the resized copy to a separate file.
- ◆ The sizes available vary with the size of the original image.
-

IMAGE ROTATE

Rotate pictures taken in tall orientation so that they are displayed in tall orientation in the LCD monitor.

- 1 Display the desired picture.
 - 2 Select **IMAGE ROTATE** in the playback menu.
 - 3 Press the selector down to rotate the picture 90° clockwise, up to rotate it 90° counterclockwise.
 - 4 Press **MENU/OK**. The picture automatically be displayed in the selected orientation whenever it is played back on the camera.
- ◆ Protected pictures can not be rotated. Remove protection before rotating pictures (📖 117).
 - ◆ The camera may not be able to rotate pictures created with other devices.

COPY COPY

Copy pictures from internal memory to a memory card.

- 1 Select **COPY COPY** in the playback menu.
 - 2 Highlight one of the following options and press the selector right:
 - **INTERNAL MEMORY → SD CARD**: Copy pictures from internal memory to a memory card.
 - **SD CARD → INTERNAL MEMORY**: Copy pictures from a memory card to internal memory.
 - 3 Highlight one of the following options and press **MENU/OK**:
 - **FRAME**: Copy selected pictures. Press the selector left or right to view pictures and press **MENU/OK** to copy the current picture.
 - **ALL FRAMES**: Copy all pictures.
- ◆ Copying ends when the destination is full.
 - ◆ DPOF print information is not copied (📖 89).

VOICE MEMO

Add a voice memo to the current photograph. Holding the camera at a distance of about 20 cm, face the microphone and press **MENU/OK** to begin recording. Press **MENU/OK** again to end recording (recording ends automatically after 30 seconds).

- ◆ Voice memos can not be added to movies or protected pictures. Remove protection from pictures before recording voice memos.
- ◆ If a voice memo already exists for the current picture, the options will be displayed. Select **RE-REC** to replace the existing memo.

Playing Voice Memos

Pictures with voice memos are indicated by a  icon during playback. To play the voice memo back, select **PLAY** for  **VOICE MEMO**.

- ◆ The camera may not play voice memos recorded with other devices.
- ◆ Do not cover the speaker during playback.

ERASE FACE RECOG.

Remove face recognition links from the current image. When this option is selected, the camera will zoom in on an area in the current picture that it has matched with a face in the face recognition database. If the match is not correct, press **MENU/OK** to remove the link to the face recognition database.

- ◆ Face recognition links can not be removed from copies with a size of **640** or smaller.

PRINT ORDER (DPOF)

Select pictures for printing on DPOF- and PictBridge-compatible devices (📖 89).

DISP ASPECT

Choose how High Definition (HD) devices display pictures with an aspect ratio of 4:3 (this option is available only when an HDMI cable is connected). Select **16:9** to display the image so that it fills the screen with its top and bottom cropped out, **4:3** to display the entire image with black bands at either side.

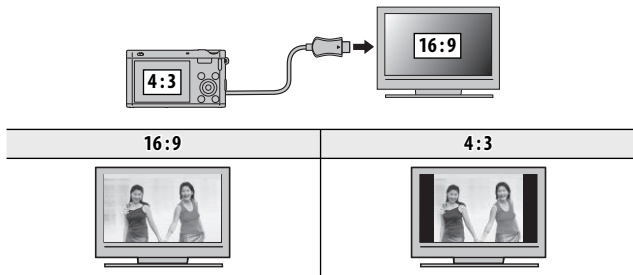

- ◆ Photographs with an aspect ratio of 16:9 are displayed full screen, those with an aspect ratio of 3:2 in a black frame.

The Setup Menu

Using the Setup Menu

1 Display the setup menu.

- 1.1 Press **MENU/OK** to display the menu for the current mode.

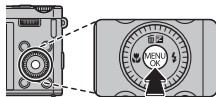

- 1.2 Press the selector left to highlight the tab for the current menu.

- 1.3 Press the selector down to highlight the tab containing the desired option.

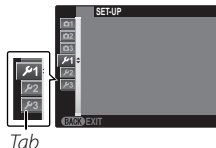

- 1.4 Press the selector right to place the cursor in the menu.

2 Adjust settings.

Highlight items and press the selector right to view options, then highlight an option and press **MENU/OK**. Press **DISP/BACK** to exit when settings are complete.



Setup Menu Options** DATE/TIME**





Set the camera clock ( 24).

 TIME DIFFERENCE**(default: )**

Switch the camera clock instantly from your home time zone to the local time at your destination when traveling. To specify the difference between local time and your home time zone:

- 1 Highlight  **LOCAL** and press the selector right.
- 2 Use the selector to choose the time difference between local time and your home time zone.
- 3 Press **MENU/OK**.

To switch between local time and your home time zone, highlight  **LOCAL** or  **HOME** and press **MENU/OK**.

Option	Description
 HOME	Switch to the time currently selected for  DATE/TIME (see above).
 LOCAL	Switch to local time. If this option is selected,  and the time and date will be displayed in yellow for three seconds each time the camera is turned on.

 言語/LANG.

Choose a language.

RESET

Reset all settings except  **DATE/TIME**,  **TIME DIFFERENCE**,  **SCREEN SET-UP > BACKGROUND COLOR**, and  **VIDEO SYSTEM** to default values.

1 Highlight  **RESET** and press the selector right to display a confirmation dialog.

2 Highlight **OK** and press **MENU/OK**.



SILENT MODE

(default: **OFF**)

Select **ON** to disable the speaker, flash, and AF-assist illuminator in situations in which camera sounds or lights may be unwelcome (note that the flash will still fire in  mode).





SOUND SET-UP

Adjust sound settings.

Option	Description
OPERATION VOL.	Adjust the volume of the sounds produced when camera controls are operated. Choose  OFF (mute) to disable control sounds.
SHUTTER VOLUME	Adjust the volume of the sounds produced when the shutter is released. Choose  OFF (mute) to disable the shutter sound.
SHUTTER SOUND	Choose the sound made by the shutter.
PLAYBACK VOLUME	Adjust the volume for movie and voice memo playback.



 **SCREEN SET-UP**

Adjust display settings.

Option	Description
IMAGE DISP.	Choose how long pictures are displayed in the LCD monitor after shooting. <ul style="list-style-type: none"> • 3 SEC, 1.5 SEC: Pictures are displayed for three seconds (3 SEC) or 1.5 seconds (1.5 SEC). Colors may differ slightly from those in the final image. • ZOOM (CONTINUOUS): Pictures are displayed until the MENU/OK button is pressed. • OFF: Pictures are not displayed after shooting.
LCD BRIGHTNESS	Control the brightness of the display.
MONITOR SUNLIGHT MODE	Select ON to make the display in the monitor easier to read in bright light.
FRAMING GUIDELINE	Choose the type of framing grid available in shooting mode. <ul style="list-style-type: none"> •  GRID 9: For “rule of thirds” composition. •  GRID 24: A six-by-four grid. •  HD FRAMING: Frame HD pictures in the crop shown by the lines at the top and bottom of the display.
AUTOROTATE PB	Choose ON to automatically rotate “tall” (portrait-orientation) pictures during playback.
BACKGROUND COLOR	Choose a color scheme.
GUIDANCE DISPLAY	Choose whether to display tool tips.
FOCUS CHECK	If ON is selected for  FOCUS CHECK , the image will be magnified in the display to assist focus when the sub-command dial is rotated in manual focus mode (📖 62). The camera must be in manual focus mode.





POWER MANAGEMENT

Adjust power management settings.

Option	Description
AUTO POWER OFF	Choose the length of time before the camera turns off automatically when no operations are performed. Shorter times increase battery life; if OFF is selected, the camera must be turned off manually. Note that in some situations the camera turns off automatically even when OFF is selected.
QUICK START MODE	Allow the camera to restart in a fast manner after turned off (ON/OFF). Ⓜ This option will increase drain on the battery.
POWER MANAGEMENT	Optimize camera performance for increased battery life or display quality. <ul style="list-style-type: none"> •  POWER SAVE: The display dims to save power if no operations are performed for a short period, but can be restored by operating camera controls. Select this option to save power. •  CLEAR DISPLAY: Choose this option for a brighter, higher quality display and for a longer delay before the monitor dims to save power. •  POWER SAVE does not take effect when Intelligent Face Detection is on.

IS MODE(default: )

Choose from the following image stabilization options:

Option	Description
 CONTINUOUS + MOTION	Image stabilization on. If + MOTION is selected, the camera will adjust shutter speed to reduce motion blur when a moving objects are detected.
 CONTINUOUS	
 SHOOTING + MOTION	As above, except that image stabilization is performed only when the shutter button is pressed halfway or the shutter is released.
 SHOOTING ONLY	
OFF	Image stabilization off. Choose this option when using a tripod.

❖ **+ MOTION** has no effect when sensitivity is set to a fixed value, and may also be unavailable at some other combinations of settings. The effect may vary with lighting conditions and the speed at which the object is moving.

RED EYE REMOVAL(default: **ON**)

Choose **ON** to remove red-eye effects caused by the flash when shooting with Intelligent Face Detection.

- ❖ Red-eye reduction is performed only when a face is detected.
- ❖ Red-eye removal is not available with RAW images.

AF ILLUMINATOR

(default: **ON**)

If **ON** is selected, the AF-assist illuminator will light to assist autofocus.

- ❗ The camera may be unable to focus using the AF-assist illuminator in some cases. If the camera is unable to focus in macro mode, try increasing the distance to the subject.
- ❗ Avoid shining the AF-assist illuminator directly into your subject's eyes.

RAW

(default: **OFF**)

Choose **RAW+JPEG** or **RAW** to record RAW pictures (note that RAW pictures are unprocessed data read from the image sensor). If **RAW+JPEG** is selected, JPEG copies will also be recorded. Choose **OFF** to record pictures in JPEG format only.

- ❖ To convert RAW files for display on the camera, use  **RAW CONVERSION** in the playback menu (🗨 115).
 - ❖ To convert RAW files for display on a computer, use the supplied RAW File Converter software.
 - ❗ Crop, resize, and red-eye removal are not available with RAW images. The maximum zoom available when viewing RAW images is 3.2x.
-

SAVE DATA SET-UP

Adjust file-management settings.

Option	Description
FRAME NO.	<p>New pictures are stored in image files named using a four-digit file number assigned by adding one to the last file number used. The file number is displayed during playback as shown at right. FRAME NO. controls whether file numbering is reset to 0001 when a new memory card is inserted or the current memory card or internal memory is formatted.</p> <div data-bbox="764 184 985 326" style="text-align: right; margin-bottom: 10px;"> </div> <ul style="list-style-type: none"> • CONTINUOUS: Numbering continues from the last file number used or the first available file number, whichever is higher. Choose this option to reduce the number of pictures with duplicate file names. • RENEW: Numbering is reset to 0001 after formatting or when a new memory card is inserted. <ul style="list-style-type: none"> ◆ If the frame number reaches 999-9999, the shutter release will be disabled (144). ◆ Selecting RESET (124) sets FRAME NO. to CONTINUOUS but does not reset the file number. ◆ Frame numbers for pictures taken with other cameras may differ.
SAVE ORG IMAGE	<p>Choose ON to save unprocessed copies of seamless panoramas or pictures taken using RED EYE REMOVAL, PRO LOW-LIGHT MODE, or PRO FOCUS MODE.</p>

SAVE DATA SET-UP (Continued)

Option	Description
DATE STAMP	<p>Stamp the time and/or date of recording on photographs as they are taken.</p> <ul style="list-style-type: none"> • [31]+⊕: Stamp new photographs with the date and time of recording. • [31]: Stamp new photographs with the date of recording. • OFF: Do not stamp the time and date on new photographs. <p>① Time and date stamps can not be deleted. Turn DATE STAMP off to prevent time and date stamps appearing on new photographs.</p> <p>① If the camera clock is not set, you will be prompted to set the clock to the current date and time (📖 24).</p> <p>① We recommend that you turn the DPOF “print date” option off when printing images with a time and date stamp (📖 89).</p> <p>① Time and date stamps do not appear on movies, panoramas, or 3D photos.</p>

FOCUS CONTROL DIAL

(default: **CW**)

Choose the direction in which the sub-command dial is rotated to increase the focus distance.

VIDEO SYSTEM

Choose a video mode for connection to a TV.

Option	Description
NTSC	Select this mode for connection to video devices in North America, the Caribbean, parts of Latin America, and some East Asian countries.
PAL	Select this mode for connection to video devices in the United Kingdom and much of Europe, Australia, New Zealand, and parts of Asia and Africa.

CUSTOM RESET

Reset all settings for mode **C1/C2**. A confirmation dialog will be displayed, press the selector up or down to highlight **OK** and press **MENU/OK**.

FORMAT

If a memory card is inserted in the camera, this option will format the memory card. If no memory card is inserted, this option will format internal memory.

- ⓘ All data—including protected pictures—will be deleted from the memory card or internal memory. Be sure important files have been copied to a computer or other storage device.
- ⓘ Do not open the battery-chamber cover during formatting.

Technical Notes

Optional Accessories



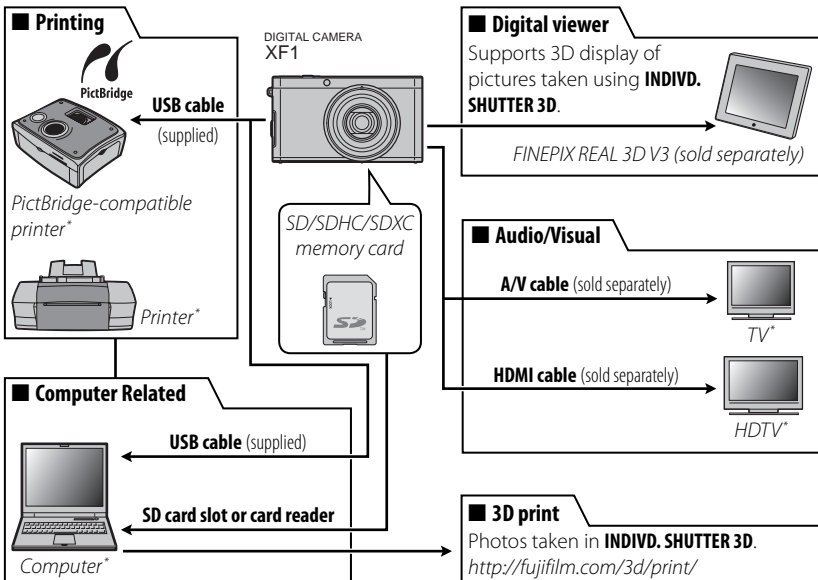

The camera supports a wide range of accessories from FUJIFILM and other manufacturers.

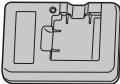

* Available separately.

Accessories from FUJIFILM

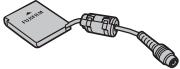
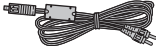
The following optional accessories are available from FUJIFILM. For the latest information on the accessories available in your region, check with your local FUJIFILM representative or visit http://www.fujifilm.com/products/digital_cameras/index.html.

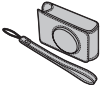
Rechargeable Li-ion batteries	NP-50: Additional large-capacity NP-50 rechargeable batteries can be purchased as required. Note that the NP-50 may record fewer photos per charge than the NP-50A.	
Battery chargers	BC-45W: Replacement battery chargers can be purchased as required. The BC-45W charges an NP-50A/NP-50 battery in about 150 minutes at +20 °C (+68 °F).	
AC power adapters	AC-5VX (requires CP-50 DC coupler): Use for extended playback or when copying pictures to a computer (shape of adapter and plug vary with region of sale).	
DC couplers	CP-50: Connect the AC-5VX to the camera.	
A/V cable	AV-C1: Use for viewing pictures on TV.	
Digital viewer	FINEPIX REAL 3D V3: View 3D images without 3D glasses.	
Camera case	SC-XF: The camera case and the strap are exclusively for use with the XF1.	

Caring for the Camera

To ensure continued enjoyment of the product, observe the following precautions.

Storage and Use

If the camera will not be used for an extended period, remove the battery and memory card. Do not store or use the camera in locations that are:

- exposed to rain, steam, or smoke
- very humid or extremely dusty
- exposed to direct sunlight or very high temperatures, such as in a closed vehicle on a sunny day
- extremely cold
- subject to strong vibration
- exposed to strong magnetic fields, such as near a broadcasting antenna, power line, radar emitter, motor, transformer, or magnet
- in contact with volatile chemicals such as pesticides
- next to rubber or vinyl products

■ **Water and Sand**

Exposure to water and sand can also damage the camera and its internal circuitry and mechanisms. When using the camera at the beach or seaside, avoid exposing the camera to water or sand. Do not place the camera on a wet surface.

■ **Condensation**

Sudden increases in temperature, such as occur when entering a heated building on a cold day, can cause condensation inside the camera. If this occurs, turn the camera off and wait an hour before turning it on again. If condensation forms on the memory card, remove the card and wait for the condensation to dissipate.

Cleaning

Use a blower to remove dust from the lens and LCD monitor, then gently wipe with a soft, dry cloth. Any remaining stains can be removed by wiping gently with a piece of FUJIFILM lens-cleaning paper to which a small amount of lens-cleaning fluid has been applied. Care should be taken to avoid scratching the lens or LCD monitor. The camera body can be cleaned with a soft, dry cloth. Do not use alcohol, thinner, or other volatile chemicals.

Traveling

Keep the camera in your carry-on baggage. Checked baggage may suffer violent shocks that could damage the camera.

Troubleshooting

Problems and Solutions

■ Power and Battery

Problem	Solution
The camera does not turn on.	<ul style="list-style-type: none">• The zoom ring (ON/OFF switch) is not correctly rotated: Rotate the zoom ring to STANDBY and then rotate the zoom ring again to the point between 25 and 100 (📖 20).• The battery is exhausted: Charge the battery or insert a fully-charged spare battery (📖 13).• The battery is inserted incorrectly: Reinsert in the correct orientation (📖 15).• The battery-chamber cover is not latched: Latch the battery-chamber cover (📖 15).• The AC power adapter and DC coupler are connected incorrectly: Reconnect the AC power adapter and DC coupler.
The battery runs down quickly.	<ul style="list-style-type: none">• The battery is cold: Warm the battery by placing it in a pocket or other warm place and reinsert it in the camera immediately before taking a picture.• There is dirt on the battery terminals: Clean the terminals with a soft, dry cloth.• 🗑️ CLEAR DISPLAY is selected for 📷 POWER MANAGEMENT > POWER MANAGEMENT: Select 🔋 POWER SAVE to reduce the drain on the battery (📖 126).• ON is selected for 📺 SCREEN SET-UP > MONITOR SUNLIGHT MODE: Select OFF to reduce the drain on the battery (📖 8).• 📷 is selected for shooting mode: Select 📷 mode to reduce the drain on the battery (📖 30).• 📷 CONTINUOUS or 📷 TRACKING is selected for 📷 FOCUS MODE: Select a different AF mode (📖 62).• The battery has been charged many times: The battery has reached the end of its charging life. Purchase a new battery.
The camera turns off suddenly.	<ul style="list-style-type: none">• The battery is exhausted: Charge the battery or insert a fully-charged spare battery (📖 13).• The AC power adapter or DC coupler has been disconnected: Reconnect the AC power adapter and DC coupler.
Charging does not start.	Reinsert the battery in the correct orientation and make sure that the charger is plugged in (📖 13).

Problem	Solution
Charging is slow.	Charge the battery at room temperature (📖 vi).
The charging lamp lights, but the battery does not charge.	<ul style="list-style-type: none"> • There is dirt on the battery terminals: Clean the terminals with a soft, dry cloth. • The battery has been charged many times: The battery has reached the end of its charging life. Purchase a new battery. If the battery still fails to charge, contact your FUJIFILM dealer. • The battery is too hot or too cold: Wait for the battery temperature to stabilize (📖 13).

■ Menus and Displays

Problem	Solution
Menus and displays are not in English.	Select ENGLISH for 🗣️ 言語/LANG. (📖 24, 123).

■ Shooting

Problem	Solution
No picture is taken when the shutter button is pressed.	<ul style="list-style-type: none"> • Memory is full: Insert a new memory card or delete pictures (📖 16, 74). • Memory is not formatted: Format the memory card or internal memory (📖 131). • There is dirt on the memory card contacts: Clean the contacts with a soft, dry cloth. • The memory card is damaged: Insert a new memory card (📖 16). • The battery is exhausted: Charge the battery or insert a fully-charged spare battery (📖 13). • The camera has turned off automatically: Turn the camera on (📖 23). • The indicator lamp was orange when you attempted to record a panorama: Wait until the indicator lamps turns off (📖 5).
The LCD monitor goes dark after shooting.	The LCD monitor may darken while the flash charges. Wait for the flash to charge (📖 51).
3D images do not turn out as expected.	Use a tripod or change the distance the camera is moved between the first and second shots (📖 39).

Problem	Solution
The camera does not focus.	<ul style="list-style-type: none"> • The subject is close to the camera: Select macro mode (📖 50). • The subject is far away from the camera: Cancel macro mode (📖 50). • The subject is not suited to autofocus: Use focus lock (📖 47).
Pictures are not the same size.	If AUTO is selected for IMAGE SIZE in EXTRAFINE mode, the camera will optimize not only sensitivity and other settings, but also image size. To record all pictures at the same size, choose another shooting mode or select another option for IMAGE SIZE (📖 101).
Macro mode is not available.	Choose a different shooting mode (📖 30).
Intelligent Face Detection is not available.	Intelligent Face Detection is not available in the current shooting mode: Choose a different shooting mode (📖 30).
No face is detected.	<ul style="list-style-type: none"> • The subject's face is obscured by sunglasses, a hat, long hair, or other objects: Remove the obstructions. • The subject's face occupies only a small area of the frame: Change the composition so that the subject's face occupies a larger area of the frame (📖 47). • The subject's head is tilted or horizontal: Ask the subject to hold their head straight. • The camera is tilted: Keep the camera level (📖 26). • The subject's face is poorly lit: Shoot in bright light.
Wrong subject is selected.	The selected subject is closer to the center of the frame than the main subject. Recompose the picture or turn face detection off and frame the picture using focus lock (📖 47).
The flash does not fire.	<ul style="list-style-type: none"> • The flash is not available in the current shooting mode: Choose a different shooting mode (📖 30). • The battery is exhausted: Charge the battery or insert a fully-charged spare battery (📖 13). • The camera is in continuous mode: Select 📷 for CONTINUOUS (📖 57). • The camera is in silent mode: Turn silent mode off (📖 124). • The flash is not raised: Raise the flash (📖 51).
Some flash modes are not available.	<ul style="list-style-type: none"> • The desired flash mode is not available in the current shooting mode: Choose a different shooting mode (📖 30). • The camera is in silent mode: Turn silent mode off (📖 124).



Problem	Solution
The flash does not fully light the subject.	<ul style="list-style-type: none"> • The subject is not in range of the flash: Position the subject in range of the flash (📖 149). • The flash window is obstructed: Hold the camera correctly (📖 26). • Fast shutter speed selected: Choose a slower shutter speed (📖 42, 44).
Pictures are blurred.	<ul style="list-style-type: none"> • The lens is dirty: Clean the lens (📖 135). • The lens is blocked: Keep objects away from the lens (📖 26). • !AF is displayed during shooting and the focus frame is displayed in red: Check focus before shooting (📖 142). • ! is displayed during shooting: Use the flash or a tripod (📖 52).
Pictures are mottled.	<ul style="list-style-type: none"> • A slow shutter speed is selected at high temperatures: This is normal and does not indicate a malfunction. • The camera has been used continuously at high temperatures or a temperature warning is displayed: Turn the camera off and wait for it to cool down.
Pictures are not recorded.	Power was interrupted during shooting. Before connecting the AC power adapter or DC coupler, turn the camera off. Leaving the camera on can result in corrupted files or damage to the memory card or internal memory.
Sounds made by the camera are recorded with movies.	<ul style="list-style-type: none"> • ☑ CONTINUOUS is selected for  MOVIE SET-UP > MOVIE AF MODE: Select a different AF mode (📖 110). • Zoom was adjusted during shooting: Do not adjust zoom during shooting. • Intelligent Face Detection is on: Turn Intelligent Face Detection off (📖 66).



■ Playback

Problem	Solution
Pictures are grainy.	The pictures were taken with a different make or model of camera.
Playback zoom unavailable.	The picture has been saved at 640 , or is from another make or model of camera (📖 72).

Problem	Solution
No sound in movie playback.	<ul style="list-style-type: none"> • Playback volume is too low: Adjust playback volume (📖 124). • The microphone was obstructed: Hold the camera correctly during recording (📖 2, 26). • The speaker is obstructed: Hold the camera correctly during playback (📖 2, 26).
Selected pictures are not deleted.	Some of the pictures selected for deletion are protected. Remove protection using the device with which it was originally applied (📖 117).
File numbering is unexpectedly reset.	The battery-chamber cover was opened while the camera was on. Turn the camera off before opening the battery-chamber cover.





■ Connections/Miscellaneous

Problem	Solution
No picture or sound.	<ul style="list-style-type: none"> • The camera is not properly connected: Connect the camera properly (📖 85). • An A/V cable was connected during movie playback: Connect the camera once movie playback has ended. • Input on the television is set to “TV”: Set input to “VIDEO”. • The camera is not set to the correct video standard: Match the camera  VIDEO SYSTEM setting to the TV (📖 130). • The volume on the TV is too low: Adjust the volume.
No color.	Match the camera  VIDEO SYSTEM setting to the TV (📖 130).
The computer does not recognize the camera.	Be sure the camera and computer are correctly connected (📖 96).
Can not transfer RAW or JPEG files to computer.	Use the bundled software to transfer pictures (📖 91).













Problem	Solution
Pictures can not be printed.	<ul style="list-style-type: none"> • The camera is not properly connected: Connect the camera correctly (📖 87). • The printer is off: Turn the printer on.
Only one copy is printed/ the date is not printed.	The printer is not PictBridge compatible.
The camera is unresponsive.	<ul style="list-style-type: none"> • Temporary camera malfunction: Remove and reinsert the battery (📖 15) or disconnect and reconnect the AC power adapter/DC coupler. • The battery is exhausted: Charge the battery (📖 13) or insert a fully-charged spare battery (📖 15).
The camera does not function as expected.	Remove and reinsert the battery (📖 15) or disconnect and reconnect the AC power adapter/DC coupler. If the problem persists, contact your FUJIFILM dealer.
I want to use an AC power adapter and DC coupler overseas.	Check the label on the AC power adapter. The AC power adapter can be used with voltages of 100 – 240 V. Consult your travel agent for information on plug adapters.
No sound.	Turn silent mode off (📖 124).
Hue or content of display changes unexpectedly.	Choose OFF for  SCREEN SET-UP > MONITOR SUNLIGHT MODE (📖 8).
Time and date stamps	<ul style="list-style-type: none"> • Time and date stamps are not correct: Set the camera clock (📖 24). • Time and date stamps appear on photographs: Time and date stamps can not be deleted. To prevent stamps appearing on new photographs, select OFF for  SAVE DATA SET-UP > DATE STAMP (📖 130).
FinePixViewer can not be installed or does not start.	FinePixViewer does not support Mac OS X version 10.7 or later. Use one of the applications supplied with Mac OS X or purchase other software.



Warning Messages and Displays

The following warnings are displayed in the LCD monitor:

Warning	Description
 (red)	Low battery. Charge the battery (📖 13) or insert a fully-charged spare battery (📖 15).
 (blinks red)	Battery exhausted. Charge the battery (📖 13) or insert a fully-charged spare battery (📖 15).
	Slow shutter speed. Pictures may be blurred; use the flash or a tripod.
!AF (displayed in red with red focus frame)	The camera can not focus. Try one of the following solutions: <ul style="list-style-type: none">• Use focus lock to focus on another subject at the same distance, then recompose the picture (📖 47).• Use macro mode to focus when taking close-ups (📖 50).
Aperture or shutter speed displayed in red	The subject is too bright or too dark and the picture will be over- or under-exposed. If the subject is dark, use the flash (📖 51).
FOCUS ERROR	
TURN OFF THE CAMERA AND TURN ON AGAIN	Camera malfunction or moving parts of lens obstructed. Turn the camera off and then on again, taking care not to touch the lens. If the message persists, contact a FUJIFILM dealer.
LENS CONTROL ERROR	
CARD NOT INITIALIZED	<ul style="list-style-type: none">• The memory card or internal memory is not formatted or the memory card was formatted in a computer or other device: Format the memory card or internal memory using the  FORMAT option in the camera setup menu (📖 131).• The memory card contacts require cleaning: Clean the contacts with a soft, dry cloth. If the message is repeated, format the card (📖 131). If the message persists, replace the card.• Camera malfunction: Contact a FUJIFILM dealer.
PROTECTED CARD	The memory card is locked. Unlock the card (📖 16).
BUSY	The memory card is incorrectly formatted. Use the camera to format the card (📖 131).
	Turn the camera off and wait for it to cool. If no action is taken, the camera will turn off automatically.

Warning	Description
CARD ERROR	The memory card is not formatted for use in the camera. Format the card (📖 131).
	The memory card contacts require cleaning or the memory card is damaged. Clean the contacts with a soft, dry cloth. If the message is repeated, format the card (📖 131). If the message persists, replace the card.
	Incompatible memory card. Use a compatible card (📖 18).
	Camera malfunction. Contact a FUJIFILM dealer.
MEMORY FULL	
INTERNAL MEMORY IS FULL INSERT A NEW CARD	The memory card or internal memory is full and pictures can not be recorded or copied. Delete pictures or insert a memory card with more free space.
WRITE ERROR	<ul style="list-style-type: none"> • Memory card error or connection error: Reinsert the card or turn the camera off and then on again. If the message persists, contact a FUJIFILM dealer. • Not enough memory remaining to record additional pictures: Delete pictures or insert a memory card with more free space. • The memory card or internal memory is not formatted: Format the memory card or internal memory (📖 131).
READ ERROR	<ul style="list-style-type: none"> • The file is corrupt or was not created with the camera: The file can not be viewed. • The memory card contacts require cleaning: Clean the contacts with a soft, dry cloth. If the message is repeated, format the card (📖 131). If the message persists, replace the card. • Camera malfunction: Contact a FUJIFILM dealer.













Warning	Description
FRAME NO. FULL	The camera has run out of frame numbers (current frame number is 999-9999). Format the memory card and select RENEW for  SAVE DATA SET-UP > FRAME NO. Take a picture to reset frame numbering to 100-0001, then select CONTINUOUS for FRAME NO. ( 129).
PRESS AND HOLD THE DISP BUTTON TO DEACTIVATE SILENT MODE	An attempt was made to choose a flash mode or adjust the volume with the camera in silent mode. Exit silent mode before choosing a flash mode or adjusting the volume ( 124).
TOO MANY FRAMES	<ul style="list-style-type: none"> • A search has returned more than 30,000 results: Choose a search that returns fewer results. • More than 999 images are selected for deletion: Choose fewer images.
PROTECTED FRAME	An attempt was made to delete, rotate, or add a voice memo to a protected picture. Remove protection and try again ( 117).
 CAN NOT CROP	 pictures can not be cropped.
CAN NOT CROP	The picture is damaged or was not created with the camera.
 CANNOT EXECUTE	An attempt was made to create a resized copy at a size equal to or larger than the original. Choose a smaller size.
 CANNOT EXECUTE	
 CANNOT EXECUTE	
CAN NOT ROTATE	An attempt was made to rotate a picture that can not be rotated.
 CAN NOT ROTATE	Movies can not be rotated.
 CANNOT EXECUTE	Red-eye removal can not be applied to the selected picture.
 CANNOT EXECUTE	Red-eye removal can not be applied to movies.
NO CARD	No memory card inserted when  COPY is selected. Insert a memory card.

Warning	Description
NO IMAGE	The source selected for  COPY contains no images. Select a different source.
 ERROR	<ul style="list-style-type: none"> • The voice memo file is corrupt: The voice memo can not be played back. • Camera malfunction: Contact a FUJIFILM dealer.
DPOF FILE ERROR	The DPOF print order on the current memory card contains more than 999 images. Copy the pictures to internal memory and create a new print order.
CAN NOT SET DPOF	The picture can not be printed using DPOF.
 CAN NOT SET DPOF	Movies can not be printed using DPOF.
COMMUNICATION ERROR	A connection error occurred while pictures were being printed or copied to a computer or other device. Confirm that the device is turned on and that the USB cable is connected.
PRINTER ERROR	Printer out of paper or ink, or other printer error. Check printer (see printer manual for details). To resume printing, turn the printer off and then turn it back on.
PRINTER ERROR RESUME?	Printer out of paper or ink, or other printer error. Check printer (see printer manual for details). If printing does not resume automatically, press MENU/OK to resume.
CANNOT BE PRINTED	An attempt was made to print a movie, a picture not created with the camera, or a picture in a format not supported by the printer. Movies and some pictures created with other devices can not be printed; if the picture is a still picture created with the camera, check the printer manual to confirm that the printer supports the JFIF-JPEG or Exif-JPEG format. If it does not, the pictures can not be printed.

Appendix

Memory Card Capacity

The following table shows the recording time or number of pictures available at different image sizes. All figures are approximate; file size varies with the scene recorded, producing wide variations in the number of files that can be stored, and the number of exposures or length remaining may not diminish at an even rate. A limited number of test pictures can be taken when no memory card is inserted.





		Medium	4 GB		8 GB	
			FINE	NORMAL	FINE	NORMAL
Photographs	 L 4:3		800	1,260	1,590	2,520
	 L 16:9		1,060	1,670	2,120	3,320
	 M 4:3		1,280	2,460	2,550	4,890
	 M 16:9		1,690	3,260	3,370	6,470
	 S 4:3		2,360	4,460	4,700	8,870
	 S 16:9		3,440	5,020	6,850	9,980
Movies	 HS 1920 × 1080 ¹		37 min.		74 min.	
	 HD 1280 × 720 ¹		47 min.		95 min.	
	 640 640 × 480 ²		112 min.		223 min.	
	 HS 640 × 480 ³		83 min.		166 min.	
	 HS 320 × 240 ³		167 min.		332 min.	
	 HS 320 × 112 ³		83 min.		166 min.	

1 Use a **CLASS 4** card or better. Individual movies can not exceed 29 minutes in length.

2 Individual movies can not exceed 120 minutes in length.

3 Use a **CLASS 4** card or better. Individual movies can not exceed 30 seconds in length.

Specifications

System	
Model	XF1
Effective pixels	12 million
Image sensor	2/3-in., EXR CMOS with primary color filter
Storage media	• Internal memory (approx. 25 MB) • SD/SDHC/SDXC memory cards
File system	Compliant with Design Rule for Camera File System (DCF), Exif 2.3, and Digital Print Order Format (DPOF)
File format	• Still pictures: Exif 2.3 JPEG (compressed); RAW (original RAF format, special-purpose software required); RAW+JPG available • Still pictures (3D): MPO • Movies: MOV (H.264) • Audio: WAV (stereo)
Image size (pixels)	• L 4:3: 4,000 × 3,000 • L 3:2: 4,000 × 2,664 • L 16:9: 4,000 × 2,248 • L 1:1: 2,992 × 2,992 • M 4:3: 2,816 × 2,112 • M 3:2: 2,816 × 1,864 • M 16:9: 2,816 × 1,584 • M 1:1: 2,112 × 2,112 • S 4:3: 2,048 × 1,536 • S 3:2: 2,048 × 1,360 • S 16:9: 1,920 × 1,080 • S 1:1: 1,536 × 1,536 •  MOTION PANORAMA 16:9: 1,624 × 11,520 (tall)/11,520 × 1,080 (wide) •  MOTION PANORAMA 10:3: 1,624 × 5,760 (tall)/5,760 × 1,080 (wide) •  MOTION PANORAMA 12:5: 1,624 × 3,840 (tall)/3,840 × 1,080 (wide) •  MOTION PANORAMA 16:9: 1,624 × 11,520 (tall)/11,520 × 1,080 (wide)
Lens	Fujinon 4 × optical zoom lens, F1.8 (wide angle) – F4.9 (telephoto)
Focal length	f=6.4 mm–25.6 mm (35-mm format equivalent: 25 mm–100 mm)
Digital zoom	Up to about 2 × with intelligent digital zoom (up to 8 × when combined with optical zoom)
Aperture	F1.8–F11 (wide angle)/F4.9–F11 (telephoto) in increments of 1/3 EV

System

Focus range (distance from front of lens)	Approx. 50 cm (1.6 ft.)–infinity (wide angle); 80 cm (2.6 ft.)–infinity (telephoto) • Macro: approx. 3 cm–3.0 m/1.1 in.–9.8 ft. (wide angle); 50 cm–3.0 m/1.6 ft.–9.8 ft. (telephoto)
Sensitivity	Standard output sensitivity equivalent to ISO 100, 200, 250, 320, 400, 500, 640, 800, 1000, 1250, 1600, 2000, 2500, 3200, 4000 ¹ , 5000 ¹ , 6400 ¹ , 12800 ² ; AUTO, AUTO (400), AUTO (800), AUTO (1600), AUTO (3200) 1 image size M or S 2 image size S
Metering	256-segment through-the-lens (TTL) metering; MULTI, SPOT, AVERAGE
Exposure control	Programmed AE; aperture-priority AE; shutter-priority AE; manual exposure
Exposure compensation	–2 EV – +2 EV in increments of 1/3 EV
Picture stabilization	Optical stabilization (lens-shift type)
Shutter speed (combined mechanical and electronic shutter)	• C : 1/4 s–1/1,000 s • ⌘ : 3 s–1/1,000 s • ⌚ : 4 s–1/2 s • EXR, Ⓜ, Adv., SP (except C , ⌘ , and ⌚): 1/4 s–1/2,000 s • P : 4 s–1/2,000 s • Other modes: 30 s–1/2,000 s
Continuous	• Ⓜ : max. 200 frames; frame rate can be selected from 10, 7, 5, and 3 fps (The frame rate varies depending on the shooting conditions or numbers of frames in continuous shooting.) • Ⓜ : 16 or 8 frames (RAW+JPEG/RAW: max. 8 frames); frame rate can be selected from 10, 7, 5, and 3 fps • Ⓜ : 3 frames (selected exposure, overexposure, underexposure) • ISO : 3 frames (selected sensitivity, sensitivity raised, sensitivity lowered) • Ⓜ : 3 frames (PROVIA, Velvia, ASTIA) • DR : 3 frames (100%, 200%, 400%)
Focus	• Mode: Single AF, continuous AF, manual focus • Focus-area selection: Multi, area, tracking • Autofocus system: Contrast-detect TTL AF
White balance	Automatic scene detection; 8 manual preset modes for direct sunlight, shade, daylight fluorescent, warm white fluorescent, cool white fluorescent, incandescent lighting, underwater, color temperature; custom white balance
Self-timer	Off, 2 sec., 10 sec.

System

Flash Manual pop-up flash; effective range when sensitivity is set to **800** is approx. 50 cm–7.4 m/1.6 ft.–24.2 ft. (wide angle; note that lens may block flash at short ranges), 80 cm–2.7 m/2.6 ft.–8.8 ft. (telephoto)

Flash mode Auto, fill flash, off, slow sync (red-eye removal off); auto with red-eye removal, fill flash with red-eye removal, off, slow sync with red-eye removal (red-eye removal on)

LCD monitor 3.0-in., 460k-dot color LCD monitor; frame coverage approx. 100%

Movies

- **FHD** 1920×1080: 1080p, 30 fps
- **HD** 1280×720: 720p, 30 fps
- **640** 640×480: VGA, 30 fps
- **HS** 640×480: 70 fps
- **HS** 320×240: 120 fps
- **HS** 320×112: 200 fps

Note: **FHD**, **HD**, and **640** movies are recorded with stereo sound.

Input/output terminals

A/V OUT (audio/video output) NTSC or PAL output with monaural sound

Digital input/output USB 2.0 High-Speed; shares A/V OUT connector; MTP/PTP

HDMI output HDMI mini connector

Power supply/other

Power supply

- NP-50A rechargeable battery
- AC-5VX AC power adapter and CP-50 DC coupler (sold separately)

Battery life (approximate number of frames that can be taken with a fully-charged battery)

Battery type	Approximate number of frames
NP-50A (type supplied with camera)	300

CIPA standard, measured in  (auto) mode using battery supplied with camera and SD memory card.

Note: Number of shots that can be taken with battery varies with battery charge level and will decline at low temperatures.

Dimensions (W × H × D)

107.9 mm × 61.5 mm × 33.0 mm/4.2 in. × 2.4 in. × 1.2 in., excluding projections (minimum depth 24.1 mm/0.9 in.)

Shooting weight

Approx. 225 g/7.9 oz., including battery and memory card

Camera weight

Approx. 204 g/7.1 oz., excluding battery, accessories, and memory card

Operating conditions

- **Temperature:** 0 °C – +40 °C/+32 °F – +104 °F
- **Humidity:** 10–80% (no condensation)

NP-50A rechargeable battery

Nominal voltage	DC 3.7 V
Nominal capacity	1000 mAh
Operating temperature	0 °C – +40 °C / +32 °F – +104 °F
Dimensions (W × H × D)	35.4 mm × 40.0 mm × 6.6 mm / 1.3 in. × 1.5 in. × 0.2 in.
Weight	Approx. 20 g / 0.7 oz.

BC-50B battery charger

Rated input	100 V–240 V AC, 50/60 Hz	
Input capacity	• 100 V: 8.0 VA	• 240 V: 12 VA
Rated output	4.2 V DC, 600 mA	
Supported batteries	NP-50A rechargeable batteries	
Charging time	Approx. 110 minutes (+20 °C / +68 °F)	
Operating temperature	0 °C – +40 °C / +32 °F – +104 °F	
Dimensions (W × H × D)	90 mm × 46 mm × 28 mm / 3.5 in. × 1.8 in. × 1.1 in., excluding projections	
Weight	Approx. 63 g / 2.2 oz., excluding battery	

Weight and dimensions vary with the country or region of sale.

■ Notices

- Specifications subject to change without notice; for the latest information, visit http://www.fujifilm.com/products/digital_cameras/index.html. FUJIFILM shall not be held liable for damages resulting from errors in this manual.
- Although the LCD monitor is manufactured using advanced high-precision technology, small bright points and anomalous colors may appear, particularly in the vicinity of text. This is normal for this type of LCD monitor and does not indicate a malfunction; images recorded with the camera are unaffected.
- Digital cameras may malfunction when exposed to strong radio interference (e.g., electric fields, static electricity, or line noise).
- Due to the type of lens used, some distortion may occur at the periphery of images. This is normal.

FUJIFILM

FUJIFILM Corporation

7-3, AKASAKA 9-CHOME, MINATO-KU, TOKYO 107-0052, JAPAN

http://www.fujifilm.com/products/digital_cameras/index.html

