

GARMIN®

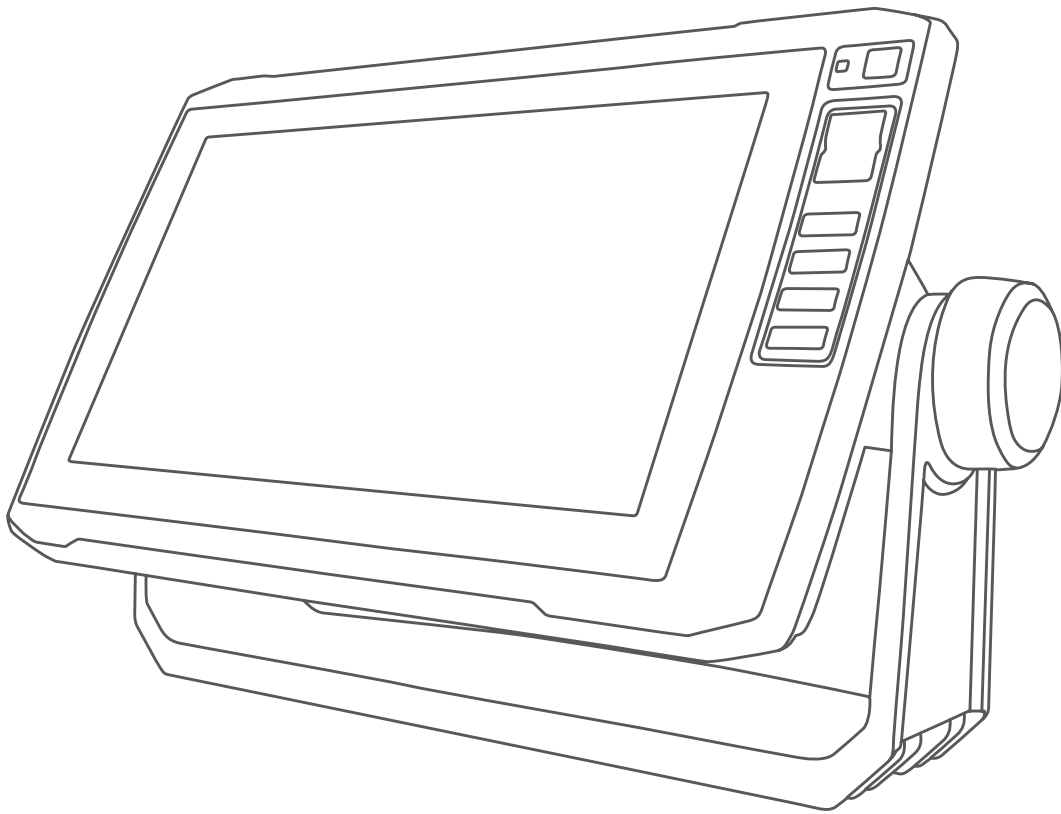

ECHOMAP™ PLUS

Owner's Manual

© 2017–2020 Garmin Ltd. or its subsidiaries

All rights reserved. Under the copyright laws, this manual may not be copied, in whole or in part, without the written consent of Garmin. Garmin reserves the right to change or improve its products and to make changes in the content of this manual without obligation to notify any person or organization of such changes or improvements. Go to www.garmin.com for current updates and supplemental information concerning the use of this product.

Garmin®, the Garmin logo, BlueChart®, and FUSION® are trademarks of Garmin Ltd. or its subsidiaries, registered in the USA and other countries. ActiveCaptain®, ECHOMAP™, FUSION-Link™, Garmin ClearVü™, Garmin Connect™, Garmin Express™, Garmin Quickdraw™, GXM™, HomePort™, LiveScope™, OneChart™, and Panoptix™ are trademarks of Garmin Ltd. or its subsidiaries. These trademarks may not be used without the express permission of Garmin.

The BLUETOOTH® word mark and logos are owned by the Bluetooth SIG, Inc. and any use of such marks by Garmin is under license. NMEA®, NMEA 2000®, and the NMEA 2000 logo are registered trademarks of the National Marine Electronics Association. microSD® and the microSD logo are trademarks of SD-3C, LLC. SiriusXM® is a registered trademark of SiriusXM Radio Inc. Wi-Fi® is a registered mark of Wi-Fi Alliance Corporation. Windows® is a registered trademark of Microsoft Corporation in the United States and other countries. All other trademarks and copyrights are the property of their respective owners.

Table of Contents

Introduction	1
ECHOMAP Plus 40 Device View	1
Device Keys	1
ECHOMAP Plus 60 Front View	1
Device Keys	1
ECHOMAP Plus 70/90 Front View	1
Device Keys	2
Assigning a Shortcut Key	2
Tips and Shortcuts	2
Downloading the Manuals from the Web	2
Garmin Support Center	2
Inserting Memory Cards	2
Acquiring GPS Satellite Signals	2
Selecting the GPS Source	2
Customizing the Chartplotter	2
Customizing the Home Screen	2
Customizing Pages	2
Creating a New Combination Page with the ECHOMAP Plus 70/90	2
Creating a New Combination Page with the ECHOMAP Plus 60	3
Creating a New Combination Page with the ECHOMAP Plus 40	3
Setting the Vessel Type	3
Adjusting the Backlight	3
Adjusting the Color Mode	3
Changing the Background Image	3
ActiveCaptain App	3
ActiveCaptain Roles	3
Getting Started with the ActiveCaptain App	3
Enabling Smart Notifications	4
Updating Software with the ActiveCaptain App	4
Updating Charts with ActiveCaptain	4
Charts and 3D Chart Views	4
Navigation Chart and Fishing Chart	5
Zooming In and Out of the Chart	5
Panning the Chart with the Keys	5
Selecting an Item on the Map Using the Device Keys	5
Chart Symbols	5
Measuring a Distance on the Chart	5
Creating a Waypoint on the Chart	5
Navigating to a Point on the Chart	5
Viewing Location and Object Information on a Chart	5
Viewing Details about Nav aids	6
Heading Line and Angle Markers	6
Premium Charts	6
Viewing Tide Station Information	6
Showing Satellite Imagery on the Navigation Chart	7
Viewing Aerial Photos of Landmarks	7
Automatic Identification System	7
AIS Targeting Symbols	7
Heading and Projected Course of Activated AIS Targets	7
Activating a Target for an AIS Vessel	8
Viewing a List of AIS Threats	8
Setting the Safe-Zone Collision Alarm	8
AIS Aids to Navigation	8
AIS Distress Signals	8
Turning Off AIS Reception	9
Chart Menu	9
Chart Layers	9
Fish Eye 3D Settings	10
Supported Maps	10
Garmin Quickdraw Contours Mapping	10

Mapping a Body of Water Using the Garmin Quickdraw Contours Feature	11
Adding a Label to a Garmin Quickdraw Contours Map	11
Garmin Quickdraw Community	11
Connecting to the Garmin Quickdraw Community with ActiveCaptain	11
Connecting to the Garmin Quickdraw Community with Garmin Connect	11
Garmin Quickdraw Contours Settings	12
Navigation with a Chartplotter	12
Basic Navigation Questions	12
Destinations	13
Searching for a Destination by Name	13
Selecting a Destination Using the Navigation Chart	13
Searching for a Marine Services Destination	13
Setting and Following a Direct Course Using Go To	13
Stopping Navigation	13
Waypoints	13
Marking Your Present Location as a Waypoint	13
Creating a Waypoint at a Different Location	13
Marking an MOB Location	13
Projecting a Waypoint	13
Viewing a List of all Waypoints	13
Editing a Saved Waypoint	13
Moving a Saved Waypoint	13
Browsing for and Navigating to a Saved Waypoint	14
Deleting a Waypoint or an MOB	14
Deleting All Waypoints	14
Routes	14
Creating and Navigating a Route From Your Present Location	14
Creating and Saving a Route	14
Viewing a List of Routes and Auto Guidance Paths	14
Editing a Saved Route	14
Browsing for and Navigating a Saved Route	14
Browsing for and Navigating Parallel to a Saved Route	15
Deleting a Saved Route	15
Deleting All Saved Routes	15
Auto Guidance	15
Setting and Following an Auto Guidance Path	15
Creating and Saving an Auto Guidance Path	15
Adjusting an Auto Guidance Path	15
Canceling an Auto Guidance Calculation in Progress	15
Setting a Timed Arrival	15
Auto Guidance Path Configurations	15
Tracks	16
Showing Tracks	16
Setting the Color of the Active Track	16
Saving the Active Track	16
Viewing a List of Saved Tracks	16
Editing a Saved Track	16
Saving a Track as a Route	16
Browsing for and Navigating a Recorded Track	16
Deleting a Saved Track	17
Deleting All Saved Tracks	17
Retracing the Active Track	17
Clearing the Active Track	17
Managing the Track Log Memory During Recording	17
Configuring the Recording Interval of the Track Log	17
Boundaries	17
Creating a Boundary	17
Converting a Route to a Boundary	17
Converting a Track to a Boundary	17
Editing a Boundary	17
Setting a Boundary Alarm	17
Deleting a Boundary	17

Deleting All Saved Waypoints, Routes, and Tracks	18	Autopilot Screen	28
Sailing Features	18	Adjusting the Step Steering Increment	28
Setting the Vessel Type	18	Setting the Power Saver	28
Sail Racing	18	Selecting the Preferred Heading Source	28
Starting Line Guidance	18	Engaging the Autopilot	28
Using the Race Timer	18	Steering Patterns	28
Setting the Distance between the Bow and the GPS		Following the U-Turn Pattern	28
Antenna	18	Setting Up and Following the Circles Pattern	28
Laylines Settings	18	Setting Up and Following the Zigzag Pattern	28
Setting the Keel Offset	18	Following the Williamson Turn Pattern	28
Sailboat Autopilot Operation	19	Reactor™ Autopilot Remote Control	28
Wind Hold	19	Pairing a Reactor Autopilot Remote Control With a	
Tack and Gybe	19	Chartplotter	29
Sonar Fishfinder	19	Changing the Functions of the Reactor Autopilot Remote	
Stopping the Transmission of Sonar Signals	20	Control Action Keys	29
Changing the Sonar View	20	Force™ Trolling Motor Control	29
Traditional Sonar View	20	Connecting to a Trolling Motor	29
Split-Frequency Sonar View	20	Adding the Trolling Motor Controls to Screens	29
Split-Zoom Sonar View	20	Trolling Motor Control Bar	29
Garmin ClearVü Sonar View	20	Trolling Motor Settings	29
SideVü Sonar View	20	Assigning a Shortcut to the Trolling Motor Remote Control	
SideVü Scanning Technology	20	Shortcut Keys	30
Panoptix™ Sonar Views	21	Calibrating the Trolling Motor Compass	30
LiveVü Down Sonar View	21	Setting the Bow Offset	30
LiveVü Forward Sonar View	21	Digital Selective Calling	30
RealVü 3D Forward Sonar View	21	Chartplotter and NMEA 0183 VHF Radio Functionality	30
RealVü 3D Down Sonar View	21	Turning On DSC	30
RealVü 3D Historical Sonar View	22	DSC List	30
FrontVü Sonar View	22	Viewing the DSC List	30
Panoptix LiveScope™ Sonar View	22	Adding a DSC Contact	30
Flasher View	22	Incoming Distress Calls	30
Flasher Page Shortcuts	22	Navigating to a Vessel in Distress	30
Selecting the Transducer Type	22	Position Tracking	30
Calibrating the Compass	23	Viewing a Position Report	31
Selecting a Sonar Source	23	Navigating to a Tracked Vessel	31
Renaming a Sonar Source	23	Creating a Waypoint at the Position of a Tracked Vessel	31
Creating a Waypoint on the Sonar Screen	23	Editing Information in a Position Report	31
Pausing the Sonar Display	23	Deleting a Position-Report Call	31
Measuring Distance on the Sonar Screen	23	Viewing Vessel Trails on the Chart	31
Viewing Sonar History	23	Individual Routine Calls	31
Sonar Sharing	23	Selecting a DSC Channel	31
Adjusting the Level of Detail	23	Making an Individual Routine Call	31
Adjusting the Color Intensity	23	Making an Individual Routine Call to an AIS Target	31
Sonar Recordings	24	Gauges and Graphs	31
Recording the Sonar Display	24	Viewing the Compass	31
Stopping the Sonar Recording	24	Viewing Trip Gauges	31
Deleting a Sonar Recording	24	Resetting Trip Gauges	31
Traditional, Garmin ClearVü, and SideVü Sonar Setup	24	Viewing Engine and Fuel Gauges	31
Setting the Zoom Level on the Sonar Screen	24	Selecting the Number of Engines Shown in Gauges	32
Setting the Scroll Speed	24	Customizing the Engines Shown in Gauges	32
Adjusting the Range of the Depth or Width Scale	24	Enabling Status Alarms for Engine Gauges	32
Sonar Appearance Settings	25	Enabling Some Engine Gauge Status Alarms	32
Sonar Alarms	25	Setting the Fuel Alarm	32
Advanced Sonar Settings	25	Setting the Fuel Capacity of the Vessel	32
Transducer Installation Settings	25	Synchronizing the Fuel Data with the Actual Vessel Fuel	32
Sonar Frequencies	25	Viewing the Wind Gauges	32
Turning On the A-Scope	26	Configuring the Sailing Wind Gauge	32
Panoptix Sonar Setup	26	Configuring the Speed Source	32
Adjusting the RealVü Viewing Angle and Zoom Level	26	Configuring the Heading Source of the Wind Gauge	32
Adjusting the RealVü Sweep Speed	26	Customizing the Close-Hauled Wind Gauge	32
LiveVü Forward and FrontVü Sonar Menu	26	Digital Switching	32
LiveVü and FrontVü Appearance Settings	27	Adding and Editing a Digital Switching Page	33
RealVü Appearance Settings	27	Tide, Current, and Celestial Information	33
Panoptix Transducer Installation Settings	27	Tide Station Information	33
Autopilot	27		

Current Station Information	33	Sharing and Managing User Data	39
Celestial Information	33	Connecting to a Garmin Device to Share User Data	39
Viewing Tide Station, Current Station, or Celestial Information for a Different Date	33	User Data Sharing Cable Wiring Diagram	39
Viewing Information for a Different Tide or Current Station	33	Selecting a File Type for Third-Party Waypoints and Routes	40
Media Player	33	Copying User Data from a Memory Card	40
Opening the Media Player	33	Copying User Data to a Memory Card	40
Media Player Icons	33	Backing Up Data to a Computer	40
Selecting the Media Source	33	Restoring Backup Data to a Chartplotter	40
Playing Music	33	Saving System Information to a Memory Card	40
Browsing for Music	33	Clearing Saved Data	40
Setting a Song to Repeat	33	Appendix	40
Setting All Songs to Repeat	33	Registering Your Device Using the Garmin Express App	40
Setting Songs to Shuffle	33	Software Update	41
Adjusting the Volume	34	Installing the Garmin Express App on a Computer	41
Enabling and Disabling Zones	34	Loading the New Software on a Memory Card Using Garmin Express	41
Muting the Media Volume	34	Updating the Device Software Using a Memory Card	41
VHF Radio	34	Cleaning the Screen	41
Scanning VHF Channels	34	Screenshots	41
Adjusting the VHF Squelch	34	Capturing Screenshots	41
Radio	34	Copying Screenshots to a Computer	41
Setting the Tuner Region	34	Troubleshooting	41
Changing the Radio Station	34	My device will not acquire GPS signals	41
Changing the Tuning Mode	34	My device will not turn on or keeps turning off	42
Presets	34	My sonar does not work	42
DAB Playback	34	My device is not creating waypoints in the correct location	42
Setting the DAB Tuner Region	34	My device does not display the correct time	42
Scanning for DAB Stations	34	Specifications	42
Changing DAB Stations	34	All Models	42
DAB Presets	34	4-Inch Models	42
SiriusXM® Satellite Radio	35	6-Inch Models	42
Locating a SiriusXM Radio ID	35	7-Inch Models	43
Activating a SiriusXM Subscription	35	9-Inch Models	43
Customizing the Channel Guide	35	Sonar Models Specifications	43
Saving a SiriusXM Channel to the Presets List	35	NMEA 0183 Information	43
Unlocking SiriusXM Parental Controls	35	NMEA 2000 PGN Information	43
Setting the Device Name	35	Index	45
Updating the Media Player Software	35		
Device Configuration	36		
Turning On the Chartplotter Automatically	36		
System Settings	36		
Display Settings	36		
GPS Settings	36		
Viewing the Event Log	36		
Viewing System Software Information	36		
Viewing E-label Regulatory and Compliance Information	36		
My Vessel Settings	36		
Setting the Keel Offset	36		
Setting the Water Temperature Offset	37		
Calibrating a Water Speed Device	37		
Setting the Fuel Capacity of the Vessel	37		
Synchronizing the Fuel Data with the Actual Vessel Fuel	37		
Customizing Engine Gauge and Fuel Gauge Limits	37		
Communications Settings	37		
NMEA 0183	38		
NMEA 2000 Settings	38		
Wi-Fi Network	38		
Setting Alarms	38		
Navigation Alarms	38		
System Alarms	38		
Setting the Fuel Alarm	38		
Units Settings	38		
Navigation Settings	39		
Other Vessel Settings	39		
Restoring the Original Chartplotter Factory Settings	39		

Introduction

⚠ WARNING

See the *Important Safety and Product Information* guide in the product box for product warnings and other important information.

ECHOMAP Plus 40 Device View



①	Device keys
②	microSD® memory card slot
③	Power and transducer connectors
④	Beeper

NOTICE

Each time you place the device in the bracket, you should make sure the device is firmly secured in the cradle, the cables are fully pushed into the device and cradle, and the locking bracket is snapped firmly closed. There is an audible click when the device or locking bracket is installed correctly. If the cables are not fully seated and the device is not firmly secured, it can lose power or stop working. The device can also fall out of the cradle and become damaged if it is not firmly secured.

Device Keys

⏻	Turns on and off the device when held. Opens a shortcut menu to backlight, color mode, and sonar transmission when quickly pressed and released. Scrolls through the brightness levels when pressed repeatedly.
⏪	Zooms out of a chart or view.
⏩	Zooms in to a chart or view.
⏴ ⏵ ⏶ ⏷	Scrolls, highlights options, and moves the cursor.
SELECT	Acknowledges messages and selects options.
BACK	Returns to the previous screen.
MARK	Saves the present location as a waypoint.
HOME	Returns to the Home screen. Takes a screenshot when held.
MENU	Opens a menu of options for the page, when applicable. Closes a menu, when applicable. Takes a screenshot when held.

ECHOMAP Plus 60 Front View



①	Power key
②	Automatic backlight sensor
③	Keys
④	microSD memory card slot

NOTICE

Each time you place the device in the cradle, you should make sure the device is firmly secured in the cradle, the cables are fully pushed into the device and cradle, and the locking bracket is snapped firmly closed. There is an audible click when the locking bracket is installed correctly. If the cables are not fully seated and the device is not firmly secured, it can lose power or stop working. The device can also fall out of the cradle and become damaged if it is not firmly secured.

Device Keys

⏻	Turns on and off the device when held. Opens a shortcut menu to backlight, color mode, and sonar transmission when quickly pressed and released. Scrolls through the brightness levels when pressed repeatedly.
⏪	Zooms out of a chart or view.
⏩	Zooms in to a chart or view.
⏴ ⏵ ⏶ ⏷	Scrolls, highlights options, and moves the cursor.
SELECT	Acknowledges messages and selects options.
BACK	Returns to the previous screen.
MARK	Saves the present location as a waypoint.
HOME	Returns to the Home screen. Takes a screenshot when held.
MENU	Opens a menu of options for the page, when applicable. Closes a menu, when applicable. Takes a screenshot when held.

ECHOMAP Plus 70/90 Front View



①	Power key
②	Automatic backlight sensor
③	Touchscreen
④	Shortcut keys
⑤	microSD memory card slot

Device Keys

⏻	Turns on and off the device when held.
	Opens a shortcut menu to backlight, color mode, and sonar transmission when quickly pressed and released.
	Scrolls through the brightness levels when pressed repeatedly.
1 2 3 4	Assigns a shortcut key to the active screen when held. Opens the assigned screen when pressed.

Assigning a Shortcut Key

You can quickly open commonly used screens by assigning a shortcut key. You can create a shortcut to screens such as sonar screens and charts.

- 1 Open a screen.
- 2 Hold a shortcut key, and select **OK**.

TIP: The shortcut is also saved to the Frequently Used category with the shortcut key number.

Tips and Shortcuts

- Press ⏻ to turn on the chartplotter.
- From any screen, press ⏻ repeatedly to scroll through the brightness levels. This can be helpful when the brightness is so low you cannot see the screen.
- Hold a numbered key to create a shortcut to a screen.
- Select **HOME** from any screen to return to the Home screen.
- Select **MENU** to open additional settings about that screen.
- Select **MENU** to close the menu when finished.
- Press ⏻ to open additional options, such as adjusting the backlight and locking the touchscreen.
- Press ⏻, and select **Power > Turn Off Device**, or hold ⏻ until the **Turn Off Device** bar fills to turn off the chartplotter, when available.
- Press ⏻, and select **Power > Sleep Device** to set the chartplotter to standby mode, when available.

Downloading the Manuals from the Web

You can get the latest owner's manual and translations of manuals from the Garmin® website.

- 1 Go to garmin.com/manuals/echomapplus60-70-90.
- 2 Download the manual.

Garmin Support Center

Go to support.garmin.com for help and information, such as product manuals, frequently asked questions, videos, software updates, and customer support.

Inserting Memory Cards

You can use optional memory cards with the chartplotter. Map cards allow you to view high-resolution satellite imagery and aerial reference photos of ports, harbors, marinas, and other points of interest. You can use blank memory cards to record Garmin Quickdraw™ Contours mapping, record sonar (with a compatible transducer), transfer data such as waypoints and routes to another compatible chartplotter or a computer, and use the ActiveCaptain® app.

This device supports up to a 32 GB microSD memory card, formatted to FAT32. Speed class 4 or greater required.

- 1 Open the access flap or door ① on the front of the chartplotter.



- 2 Insert the memory card ②.
- 3 Press the card in until it clicks.
- 4 Close the door.



Acquiring GPS Satellite Signals

The device may need a clear view of the sky to acquire satellite signals. The time and date are set automatically based on the GPS position.

- 1 Turn on the device.
- 2 Wait while the device locates satellites.

It may take 30 to 60 seconds to acquire satellite signals.

When the device acquires satellite signals,  appears at the top of the Home screen.

If the device loses satellite signals,  disappears and a flashing question mark appears over  on the chart.

For more information about GPS, go to garmin.com/aboutGPS. For help acquiring satellite signals, see (*My device will not acquire GPS signals*, page 41).

Selecting the GPS Source

You can select your preferred source for GPS data, if you have more than one GPS source.

- 1 Select **Settings > System > GPS > Source**.
- 2 Select the source for GPS data.

Customizing the Chartplotter

Customizing the Home Screen

You can add items to and rearrange items on the Home screen.

- 1 From the Home screen, select **Customize Home**.
- 2 Select an option:
 - To rearrange an item, select **Rearrange**, select the item to move, and select the new location.
 - To add an item to the Home screen, select **Add**, and select the new item.
 - To remove an item you have added to the Home screen, select **Remove**, and select the item.
 - To change the Home screen background image, select **Background**, and select an image.

Customizing Pages

Creating a New Combination Page with the ECHOMAP Plus 70/90

You can create a custom combination page to suit your needs.

- 1 Select **Combos > Customize > Add**.
- 2 Select a layout.



- 3 Select an area.
- 4 Select a function for the area.
- 5 Repeat these steps for each area of the page.
- 6 Drag the arrows to resize the areas.
- 7 Hold an area to rearrange it.
- 8 Hold a data field to select new data.
- 9 Select **Done** when you have finished customizing the page.
- 10 Enter a name for the page, and select **Done**.

Creating a New Combination Page with the ECHOMAP Plus 60

You can create a custom combination page to suit your needs.

- 1 Select **Combos > Customize > Add**.
- 2 Select a layout.

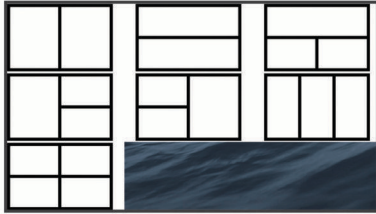

- 3 Select an area.
- 4 Select a function for the area.
- 5 Repeat these steps for each area of the page.
- 6 Select **Data**, and customize the data shown.
- 7 Select **Next** when you are done customizing the page.
- 8 Enter a name for the page, and select **Done**.
- 9 Use the arrow keys to resize the windows.
- 10 Select to **BACK** to exit.

Creating a New Combination Page with the ECHOMAP Plus 40

You can create a custom combination page to suit your needs.

- 1 Select **Combos > Customize > Add**.
- 2 Select the first function.
- 3 Select the second function.
- 4 Select **Split** to choose the direction of the split screen (optional).
- 5 Select **Next**.
- 6 Enter a name for the page.
TIP: Select **SELECT** to select the letter.
- 7 Use the arrow keys to resize the windows.
- 8 Use the arrow keys to select a location on the home screen.
- 9 Select **BACK** to exit.

Setting the Vessel Type

You can select your boat type to configure the chartplotter settings and to use features customized for your boat type.

- 1 Select **Settings > My Vessel > Vessel Type**.
- 2 Select an option.

Adjusting the Backlight

- 1 Select **Settings > System > Display > Backlight**.
- 2 Adjust the backlight.

TIP: From any screen, press **⏮** repeatedly to scroll through the brightness levels. This can be helpful when the brightness is so low you cannot see the screen.

Adjusting the Color Mode

- 1 Select **Settings > System > Display > Color Mode**.

TIP: Select **⏮** > **Display > Color Mode** from any screen to access the color settings.

- 2 Select an option.

Changing the Background Image

- 1 From the home screen, select **MENU > Background**.

TIP: You can also adjust this setting from **Settings > System > Display > Background**.

- 2 Select an image.

ActiveCaptain App

⚠ CAUTION

This feature allows users to submit information. Garmin makes no representations about the accuracy, completeness or timeliness of information submitted by users. Any use or reliance on the information submitted by users is at your own risk.

NOTE: The ActiveCaptain feature is only available on models that have Wi-Fi® technology.

If you connect to a Wi-Fi adapter The ActiveCaptain feature is only available on models that have Wi-Fi technology.

The ActiveCaptain app provides a connection to your ECHOMAP Plus device, charts, maps, and the community for a connected boating experience.

On your mobile device with the ActiveCaptain app, you can download, purchase, and update maps and charts. You can use the app to easily and quickly transfer user data, such as waypoints and routes, connect to the Garmin Quickdraw Contours Community, and update device software. You can also plan your trip from the app.

You can connect to the ActiveCaptain community for up-to-date feedback on marinas and other points of interest. The app can push smart notifications, such as calls and texts, to your chartplotter display when paired.

ActiveCaptain Roles

Your level of interaction with the ECHOMAP Plus device using the ActiveCaptain app depends on your role.

Feature	Owner	Guest
Register device, built-in maps, and supplemental map cards to account	Yes	No
Update software	Yes	Yes
Automatically transfer Garmin Quickdraw contours you have downloaded or created	Yes	No
Push smart notifications	Yes	Yes
Begin navigating to a specific waypoint or navigating a specific route	Yes	Yes
Manually synchronize waypoints and routes with the ECHOMAP Plus device	Yes	Yes

Getting Started with the ActiveCaptain App

You can connect a mobile device to the ECHOMAP Plus device using the ActiveCaptain app. The app provides a quick and easy way for you to interact with your ECHOMAP Plus device and complete such tasks as sharing data, registering, updating the device software, and receiving mobile device notifications.

- 1 Insert a memory card in one of the ECHOMAP Plus device's card slots (*Inserting Memory Cards*, page 2).
Be sure the card is inserted each time you want to use the ActiveCaptain feature.
- 2 Select **ActiveCaptain > Create ActiveCaptain Memory Card**.

NOTICE

You might be prompted to format the memory card. Formatting the card deletes all information saved on the card. This includes any saved user data, such as waypoints. Formatting the card is recommended, but not required. Before formatting the card, you should save the data from the memory card onto the device internal memory (*Copying User Data from a Memory Card*, page 40). After formatting the card for the ActiveCaptain app, you can transfer the user data back to the card (*Copying User Data to a Memory Card*, page 40).

- 3 From the **ActiveCaptain** page, select **MENU > Wi-Fi Setup > Wi-Fi Network > Wi-Fi > On**.
- 4 Enter a name and password for this network.
- 5 From the application store on your mobile device, install and open the ActiveCaptain app.
- 6 Bring the mobile device within 32 m (105 ft.) of the ECHOMAP Plus device.
- 7 From your mobile device settings, open the Wi-Fi connections page and connect to the Garmin device, using the name and password you entered.

Enabling Smart Notifications

⚠ WARNING

Do not read or reply to notifications while operating the vessel. Failure to pay attention to the conditions on the water can result in vessel damage, personal injury, or death.

Before your ECHOMAP Plus device can receive notifications, you must connect it to your mobile device and to the ActiveCaptain app.

- 1 From the ECHOMAP Plus device, select **ActiveCaptain > Smart Notifications > Enable Notifications**.
- 2 Turn on Bluetooth® technology in the mobile device settings.
- 3 Bring the devices within 10 m (33 ft.) of each other.
- 4 From the ActiveCaptain app on the mobile device, select **Smart Notifications > Pair with Chartplotter**.
- 5 Follow the on-screen instructions to pair the app to the ECHOMAP Plus device.
- 6 When prompted, enter the key on your mobile device.
- 7 If necessary, adjust which notifications you receive in your mobile device settings.

Updating Software with the ActiveCaptain App

If your device has Wi-Fi technology, you can use the ActiveCaptain app to download and install the latest software updates for your device.

NOTICE

Software updates may require the app to download large files. Regular data limits or charges from your Internet service provider apply. Contact your Internet service provider for more information about data limits or charges.

The installation process can take several minutes.

- 1 Connect the mobile device to the ECHOMAP Plus device (*Getting Started with the ActiveCaptain App*, page 3).
- 2 When a software update is available and you have internet access on your mobile device, select **Software Updates > Download**.

The ActiveCaptain app downloads the update to the mobile device. When you reconnect the app to the ECHOMAP Plus device, the update is transferred to the device. After the transfer is complete, you are prompted to install the update.

- 3 When you are prompted by the ECHOMAP Plus device, select an option to install the update.
 - To update the software immediately, select **OK**.
 - To delay the update, select **Cancel**. When you are ready to install the update, select **ActiveCaptain > Software Updates > Install Now**.

Updating Charts with ActiveCaptain

You can use the ActiveCaptain app to download and transfer the latest chart updates for your device. To save space on your mobile device, space on the ActiveCaptain card, and download time, consider using the ActiveCaptain app to download only the areas of the chart you need.

If you are downloading an entire chart, you can use the Garmin Express™ app to download the map onto a memory card. The Garmin Express app downloads large charts more quickly than the ActiveCaptain app. For more information, go to garmin.com/express.

NOTICE

Chart updates may require the app to download large files. Regular data limits or charges from your internet service provider apply. Contact your internet service provider for more information about data limits or charges.

- 1 Connect the mobile device to the ECHOMAP Plus device (*Getting Started with the ActiveCaptain App*, page 3).
- 2 When a chart update is available, and you have internet access on your mobile device, select **OneChart > My Charts**.
- 3 Select the map to update.
- 4 Select the area to download.
- 5 Select **Download**

The ActiveCaptain app downloads the update to the mobile device. When you reconnect the app to the ECHOMAP Plus device, the update is transferred to the device. After the transfer is complete, the updated charts are available for use.

Charts and 3D Chart Views

The charts and 3D chart views that are available depend on the map data and accessories used.

NOTE: 3D chart views are available with premium charts, in some areas.

You can access the charts and 3D chart views by selecting **Charts**.

Navigation Chart: Shows navigation data available on your pre-loaded maps and from supplemental maps, if available. The data includes buoys, lights, cables, depth soundings, marinas, and tide stations in an overhead view.

Fishing Chart: Provides a detailed view of the bottom contours and depth soundings on the chart. This chart removes navigational data from the chart, provides detailed bathymetric data, and enhances bottom contours for depth recognition. This chart is best for offshore deep-sea fishing.

NOTE: The Fishing chart is available with premium charts, in some areas.

Perspective 3D: Provides a view from above and behind the boat (according to your course) and provides a visual navigation aid. This view is helpful when navigating tricky shoals, reefs, bridges, or channels, and is beneficial when trying to identify entry and exit routes in unfamiliar harbors or anchorages.

Mariner's Eye 3D: Shows a detailed, three-dimensional view from above and behind the boat (according to your course) and provides a visual navigation aid. This view is helpful when navigating tricky shoals, reefs, bridges, or channels,

and when trying to identify entry and exit routes in unfamiliar harbors or anchorages.

Fish Eye 3D: Provides an underwater view that visually represents the sea floor according to the chart information. When a sonar transducer is connected, suspended targets (such as fish) are indicated by red, green, and yellow spheres. Red indicates the largest targets and green indicates the smallest.

Relief Shading: Provides high resolution elevation shading of lakes and coastal waters. This chart can be helpful for fishing and diving.

NOTE: The Relief Shading chart is available with premium charts, in some areas.

Navigation Chart and Fishing Chart

NOTE: The Fishing chart is available with premium charts, in some areas.

The Navigation Chart is optimized for navigation. You can plan a course, view map information, and use the chart as a navigational aid. To open the Navigation Chart, select **Charts > Navigation Chart**.

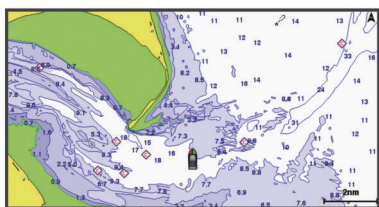

The Fishing Chart provides a detailed view with more bottom detail and fishing content. This chart is optimized for use when fishing. To open the Fishing Chart, select **Charts > Fishing Chart**.

Zooming In and Out of the Chart

The zoom level is indicated by the scale number at the bottom of the chart. The bar under the scale number represents that distance on the chart.

- To zoom out, select **—** or pinch two fingers together on the touchscreen.
- To zoom in, select **+** or spread two fingers apart on the touchscreen.

Panning the Chart with the Keys

You can move the chart to view an area other than your present location.

- 1 From the chart, use the arrow keys.
- 2 Select **BACK** to stop panning and return the screen to your present location.

NOTE: To pan from a combination screen, select **SELECT**.

Selecting an Item on the Map Using the Device Keys

- 1 From a chart or 3D chart view, select **←**, **→**, **↓**, or **↑** to move the cursor.
- 2 Select **SELECT**.

Chart Symbols

This table contains some of the common symbols you might see on the detailed charts.

Icon	Description
	Buoy
	Information
	Marine services
	Tide station
	Current station

Icon	Description
	Overhead photo available
	Perspective photo available

Other features common to most charts include depth contour lines, intertidal zones, spot soundings (as depicted on the original paper chart), navigational aids and symbols, obstructions, and cable areas.

Measuring a Distance on the Chart

- 1 From a chart, select a location.
- 2 Select **Measure Distance**.
A push pin appears on the screen at your present location. The distance and angle from the pin is listed in the corner.

TIP: To reset the pin and measure from the current location of the cursor, select **Set Reference**.

Creating a Waypoint on the Chart

- 1 From a chart, select a location or object.
- 2 Select **Create Waypoint**.

Navigating to a Point on the Chart

WARNING

All route and navigation lines displayed on the chartplotter are only intended to provide general route guidance or to identify proper channels, and are not intended to be precisely followed. Always defer to the nav aids and conditions on the water when navigating to avoid groundings or hazards that could result in vessel damage, personal injury, or death.

The Auto Guidance feature is based on electronic chart information. That data does not ensure obstacle and bottom clearance. Carefully compare the course to all visual sightings, and avoid any land, shallow water, or other obstacles that may be in your path.

When using **Go To**, a direct course and a corrected course may pass over land or shallow water. Use visual sightings, and steer to avoid land, shallow water, and other dangerous objects.

NOTE: The Fishing chart is available with premium charts, in some areas.

NOTE: Auto Guidance is available with premium charts, in some areas.

- 1 From the Navigation chart or Fishing chart, select a location.
- 2 If necessary, select **Navigate To**.
- 3 Select an option:
 - To navigate directly to the location, select **Go To**.
 - To create a route to the location, including turns, select **Route To**.
 - To use Auto Guidance, select **Auto Guidance**.
- 4 Review the course indicated by the magenta line.

NOTE: When using Auto Guidance, a gray segment within any part of the magenta line indicates that Auto Guidance cannot calculate part of the Auto Guidance line. This is due to the settings for minimum safe water depth and minimum safe obstacle height.

- 5 Follow the magenta line, steering to avoid land, shallow water, and other obstacles.

Viewing Location and Object Information on a Chart

You can view information, such as tide, current, celestial, chart notes, or local services, about a location or an object on the Navigation chart or the Fishing chart.

- 1 From the Navigation chart or Fishing chart, select a location or object.

A list of options appears along the top of the chart. The options that appear vary based on the location or object you selected.

2 Select Information.

Viewing Details about Nav aids

From the Navigation chart, Fishing chart, Perspective 3D chart view, or Mariner's Eye 3D chart view, you can view details about various types of navigation aids, including beacons, lights, and obstructions.

NOTE: The Fishing chart is available with premium charts, in some areas.

NOTE: 3D chart views are available with premium charts, in some areas.

- 1 From a chart or 3D chart view, select a nav aid.
- 2 Select the name of the nav aid.

Heading Line and Angle Markers

The heading line is an extension drawn on the map from the bow of the boat in the direction of travel. Angle markers indicate relative position from the heading or course over ground, which are helpful for casting or finding reference points.

Setting the Heading Line and Angle Markers

The heading line is an extension drawn on the map from the bow of the boat in the direction of travel. Angle markers indicate relative position from the heading or course over ground, which are helpful for casting or finding reference points.

You can show the heading line and the course over ground (COG) line on the chart.

COG is your direction of movement. Heading is the direction the bow of the boat is pointed, when a heading sensor is connected.

- 1 From a chart, select **MENU > Layers > My Vessel > Heading Line**.
- 2 Angle Markers
- 3 If necessary, select **Source**, and select an option:
 - To automatically use the available source, select **Auto**.
 - To use the GPS antenna heading for COG, select **GPS Heading (COG)**.
 - To use data from a connected heading sensor, select **Heading**.
 - To use data from both a connected heading sensor and the GPS antenna, select **COG and Heading**.
This displays both the heading line and the COG line on the chart.
- 4 Select **Display**, and select an option:
 - Select **Distance > Distance**, and enter the length of the line shown on the chart.
 - Select **Time > Time**, and enter the time used to calculate the distance your boat will travel in the specified time at your present speed.

Turning on Angle Markers

You can add angle markers to the map along the heading line. Angle markers can be helpful for casting when fishing.

- 1 Set the heading line ([Setting the Heading Line and Angle Markers, page 6](#)).
- 2 Select **Angle Markers**.

Premium Charts

WARNING

All route and navigation lines displayed on the chartplotter are only intended to provide general route guidance or to identify proper channels, and are not intended to be precisely followed. Always defer to the nav aids and conditions on the water when

navigating to avoid groundings or hazards that could result in vessel damage, personal injury, or death.

The Auto Guidance feature is based on electronic chart information. That data does not ensure obstacle and bottom clearance. Carefully compare the course to all visual sightings, and avoid any land, shallow water, or other obstacles that may be in your path.

NOTE: Not all models support all charts.

Optional premium charts, such as BlueChart® g3 Vision, allow you to get the most out of your chartplotter. In addition to detailed marine charting, premium charts may contain these features, which are available in some areas.

Mariner's Eye 3D: Provides a view from above and behind the boat for a three-dimensional navigation aid.

Fish Eye 3D: Provides an underwater, three-dimensional view that visually represents the sea floor according to the information on the chart.

Fishing Charts: Shows the chart with enhanced bottom contours and without navigational data. This chart works well for offshore deep-sea fishing.

High Resolution Satellite Imagery: Provides high-resolution satellite images for a realistic view of the land and water on the Navigation chart ([Showing Satellite Imagery on the Navigation Chart, page 7](#)).

Aerial Photos: Shows marinas and other navigationally significant aerial photos to help you visualize your surroundings ([Viewing Aerial Photos of Landmarks, page 7](#)).

Detailed Roads and POI data: Shows detailed road and point of interest (POI) data, which includes highly detailed coastal roads and POIs such as restaurants, lodging, and local attractions.

Auto Guidance: Uses specified information about your vessel and chart data to determine the best path to your destination.

Viewing Tide Station Information

The  icon on the chart indicates a tide station. You can view a detailed graph for a tide station to help predict the tide level at different times or on different days.

NOTE: This feature is available with premium charts, in some areas.

- 1 From the Navigation chart or Fishing chart, select a tide station.
Tide direction and tide level information appear near .
- 2 Select the station name.

Animated Tide and Current Indicators

NOTE: This feature is available with premium charts, in some areas.

You can view indicators for animated tide station and current direction on the Navigation chart or the Fishing chart. You must also enable animated icons in the chart settings ([Chart Layer Settings, page 9](#)).

An indicator for a tide station appears on the chart as a vertical bar graph with an arrow. A red arrow pointing downward indicates a falling tide, and a blue arrow pointing upward indicates a rising tide. When you move the cursor over the tide station indicator, the height of the tide at the station appears above the station indicator.

Current direction indicators appear as arrows on the chart. The direction of each arrow indicates the direction of the current at a specific location on the chart. The color of the current arrow indicates the range of speed for the current at that location. When you move the cursor over the current direction indicator, the specific current speed at the location appears above the direction indicator.

Color	Current Speed Range
Yellow	0 to 1 knot
Orange	1 to 2 knots
Red	2 or more knots

Showing Tides and Current Indicators

NOTE: This feature is available with premium charts, in some areas.

You can show static or animated tide and current station indicators on the Navigation chart or Fishing chart.

- From the Navigation or Fishing chart, select **MENU > Layers > Chart > Tides & Currents**.
- Select an option:
 - To show animated tide station indicators and animated current direction indicators on the chart, select **Animated**.
 - To enable the tides and current slider, which sets the time for which tides and currents are reported on the map, select **Slider**.

Showing Satellite Imagery on the Navigation Chart

NOTE: This feature is available with premium charts, in some areas.

You can overlay high-resolution satellite images on the land or on both land and sea portions of the Navigation chart.

NOTE: When enabled, high-resolution satellite images are present only at lower zoom levels. If you cannot see high-resolution images in your optional chart region, you can select **+** to zoom in. You also can set the detail level higher by changing the map zoom detail.

- From the Navigation chart, select **MENU > Layers > Chart > Satellite Photos**.
- Select an option:
 - Select **Land Only** to show standard chart information on the water, with photos overlaying the land.



NOTE: This setting must be enabled to view Standard Mapping® charts.
 - Select **Photo Map Blend** to show photos on both the water and the land at a specified opacity. Use the slider bar to adjust the photo opacity. The higher you set the percentage, the more the satellite photos cover both land and water.

Viewing Aerial Photos of Landmarks

Before you can view aerial photos on the Navigation chart, you must turn on the Photo Points setting in the chart setup.

NOTE: This feature is available with premium charts, in some areas.

You can use aerial photographs of landmarks, marinas, and harbors to help orient yourself to your surroundings or to acquaint yourself with a marina or a harbor prior to arrival.

- From the Navigation chart, select a camera icon:
 - To view an overhead photo, select .
 - To view a perspective photo, select . The photo was taken from the location of the camera, pointed in the direction of the cone.
- Select **Photo**.







Automatic Identification System

The Automatic Identification System (AIS) enables you to identify and track other vessels, and alerts you to area traffic. When connected to an external AIS device, the chartplotter can show some AIS information about other vessels that are within range, that are equipped with a transponder, and that are actively transmitting AIS information.

The information reported for each vessel includes the Maritime Mobile Service Identity (MMSI), location, GPS speed, GPS heading, time that has elapsed since the last position of the vessel was reported, nearest approach, and time to the nearest approach.

Some chartplotter models also support Blue Force Tracking. Vessels being tracked with Blue Force Tracking are indicated on the chartplotter with a blue-green color.

AIS Targeting Symbols

Symbol	Description
	AIS vessel. The vessel is reporting AIS information. The direction in which the triangle is pointing indicates the direction in which the AIS vessel is moving.
	Target is selected.
	Target is activated. The target appears larger on the chart. A green line attached to the target indicates the heading of the target. The MMSI, speed, and direction of the vessel appear beneath the target, if the details setting has been set to Show. If the AIS transmission from the vessel is lost, a message banner appears.
	Target is lost. A green X indicates that the AIS transmission from the vessel is lost, and the chartplotter displays a message banner asking whether the vessel should continue to be tracked. If you discontinue vessel tracking, the lost target symbol disappears from the chart or the 3D chart view.
	Dangerous target in range. The target flashes while an alarm sounds and a message banner appears. After the alarm has been acknowledged, a solid red triangle with a red line attached to it indicates the location and the heading of the target. If the safe-zone collision alarm has been set to Off, the target flashes, but the audible alarm does not sound and the alarm banner does not appear. If the AIS transmission from the vessel is lost, a message banner appears.
	Dangerous target is lost. A red X indicates that the AIS transmission from the vessel is lost, and the chartplotter displays a message banner asking whether the vessel should continue to be tracked. If you discontinue vessel tracking, the lost dangerous target symbol disappears from the chart or the 3D chart view.
	The location of this symbol indicates the closest point of approach to a dangerous target, and the numbers near the symbol indicate the time to the closest point of approach to that target.

NOTE: Vessels being tracked with the Blue Force Tracking feature are indicated with a blue-green color regardless of their status.

Heading and Projected Course of Activated AIS Targets

When heading and course over ground information are provided by an activated AIS target, the heading of the target appears on a chart as a solid line attached to the AIS target symbol. A heading line does not appear on a 3D chart view.

The projected course of an activated AIS target appears as a dashed line on a chart or a 3D chart view. The length of the projected course line is based on the value of the projected heading setting. If an activated AIS target is not transmitting speed information, or if the vessel is not moving, a projected course line does not appear. Changes in the speed, course over ground, or rate of turn information transmitted by the vessel can impact the calculation of the projected course line.

When course over ground, heading, and rate of turn information are provided by an activated AIS target, the projected course of the target is calculated based on the course over ground and the rate of turn information. The direction in which the target is turning, which is also based on the rate of turn information, is indicated by the direction of the barb at the end of the heading line. The length of the barb does not change.



When course over ground and heading information are provided by an activated AIS target, but rate of turn information is not provided, the projected course of the target is calculated based on the course over ground information.

Activating a Target for an AIS Vessel

- 1 From a chart or a 3D chart view, select an AIS vessel.
- 2 Select **AIS Vessel > Activate Target**.

Viewing Information about a Targeted AIS Vessel

You can view the AIS signal status, MMSI, GPS speed, GPS heading, and other information that is reported about a targeted AIS vessel.

- 1 From a chart or a 3D chart view, select an AIS vessel.
- 2 Select **AIS Vessel**.

Deactivating a Target for an AIS Vessel

- 1 From a chart or a 3D chart view, select an AIS vessel.
- 2 Select **AIS Vessel > Deactivate Target**.

Viewing a List of AIS Threats

From a chart or 3D chart view, select **MENU > Other Vessels > AIS List**.

Setting the Safe-Zone Collision Alarm

Before you can set a safe-zone collision alarm, you must have a compatible chartplotter connected to an AIS device.

The safe-zone collision alarm is used only with AIS. The safe zone is used for collision avoidance, and can be customized.

- 1 Select **Settings > Alarms > AIS > AIS Alarm > On**.

A message banner appears and an alarm sounds when an AIS-activated vessel enters the safe-zone area around your boat. The object is also labeled as dangerous on the screen. When the alarm is off, the message banner and audible alarm are disabled, but the object is still labeled as dangerous on the screen.

- 2 Select **Range**.
- 3 Select a distance for the safe-zone radius around your vessel.
- 4 Select **Time To**.
- 5 Select a time at which the alarm will sound if a target is determined to intersect the safe zone.

For example, to be notified of a pending intersection 10 minutes before it will likely occur, set Time To to 10, and the alarm will sound 10 minutes before the vessel intersects the safe zone.

AIS Aids to Navigation

An AIS aid to navigation (ATON) is any kind of navigational aid that is transmitted over the AIS radio. ATONs are displayed on the charts and have identifying information, such as position and type.

There are three main kinds of AIS ATONs. Real ATONs physically exist and send their identifying and location information from their actual location. Synthetic ATONs physically exist, and their identifying and location information is sent from another location. Virtual ATONs do not actually exist, and their identifying and location information is sent from another location.

You can view AIS ATONs on the chart when the chartplotter is connected to a compatible AIS radio. To show AIS ATONs, from a chart, select **MENU > Layers > Chart > Navaid > ATONs**. You can view more information about an ATON if you select the ATON on the chart.

Symbol	Meaning
	Real or synthetic ATON
	Real or synthetic ATON: Topmark North
	Real or synthetic ATON: Topmark South
	Real or synthetic ATON: Topmark East
	Real or synthetic ATON: Topmark West
	Real or synthetic ATON: Topmark Special
	Real or synthetic ATON: Topmark Safe
	Real or synthetic ATON: Topmark Danger
	Virtual ATON
	Virtual ATON: Topmark North
	Virtual ATON: Topmark South
	Virtual ATON: Topmark East
	Virtual ATON: Topmark West
	Virtual ATON: Topmark Special
	Virtual ATON: Topmark Safe
	Virtual ATON: Topmark Danger

AIS Distress Signals

Self-contained AIS distress signal devices transmit emergency position reports when activated. The chartplotter can receive signals from Search and Rescue Transmitters (SART), Emergency Position Indicating Radio Beacons (EPIRB), and other man overboard signals. Distress signal transmissions are different than standard AIS transmissions, so they appear differently on the chartplotter. Instead of tracking a distress signal transmission for collision avoidance, you track a distress signal transmission to locate and assist a vessel or person.

Navigating to a Distress Signal Transmission

When you receive a distress signal transmission, a distress signal alarm appears.

Select **Review > Go To** to begin navigation to the transmission.

AIS Distress Signal Device Targeting Symbols

Symbol	Description
	AIS distress signal device transmission. Select to see more information about the transmission and begin navigation.
	Transmission lost.
	Transmission test. Appears when a vessel initiates a test of their distress signal device, and does not represent a true emergency.
	Transmission test lost.

Enabling AIS Transmission Test Alerts

To avoid a large number of test alerts and symbols in crowded areas such as marinas, you can select to receive or ignore AIS test messages. To test an AIS emergency device, you must enable the chartplotter to receive test alerts.

- 1 Select **Settings > Alarms > AIS**.
- 2 Select an option:
 - To receive or ignore Emergency Position Indicating Radio Beacon (EPIRB) test signals, select **AIS-EPIRB Test**.
 - To receive or ignore Man Overboard (MOB) test signals, select **AIS-MOB Test**.
 - To receive or ignore Search and Rescue Transponder (SART) test signals, select **AIS-SART Test**.

Turning Off AIS Reception

AIS signal reception is turned on by default.

Select **Settings > Other Vessels > AIS > Off**.

All AIS functionality on all charts and 3D chart views is disabled. This includes AIS vessel targeting and tracking, collision alarms that result from AIS vessel targeting and tracking, and the display of information about AIS vessels.

Chart Menu

NOTE: Not all settings apply to all chart views. Some options require premium maps or connected accessories.

NOTE: The menus may contain some settings that are not supported by your installed charts or your present location. If you make changes to those settings, the changes will not impact the chart view.

These settings apply to the chart views, except Fish Eye 3D (*Fish Eye 3D Settings, page 10*).

From a chart, select MENU.

Layers: Adjusts the appearance of the different items on the charts (*Chart Layers, page 9*).

Waypoints & Tracks: Adjusts how waypoints and tracks are shown (*User Data Layer Settings, page 10*).

Quickdraw Contours: Turns on bottom contour drawing, and allows you to create fishing map labels (*Garmin Quickdraw Contours Mapping, page 10*).

Chart Setup: Adjusts the orientation and level of detail shown on the chart and adjusts the data shown on the screen.

Chart Layers

You can turn on and off chart layers and customize features of the charts. Each setting is specific to the chart or chart view being used.

NOTE: Not all settings apply to all charts and chartplotter models. Some options require premium maps or connected accessories.

NOTE: The menus may contain some settings that are not supported by your installed charts or your present location. If you make changes to those settings, the changes will not impact the chart view.

From a chart, select **MENU > Layers**.

Chart: Shows and hides chart-related items (*Chart Layer Settings, page 9*).

My Vessel: Shows and hides items relating to the boat (*My Vessel Layer Settings, page 9*).

User Data: Shows and hides user data, such as waypoints, boundaries, and tracks, and opens user data lists (*User Data Layer Settings, page 10*).

Other Vessels: Adjusts how other vessels are shown (*Other Vessels Layer Settings, page 10*).

Water: Shows and hides depth items (*Water Layer Settings, page 10*).

Quickdraw Contours: Shows and hides Garmin Quickdraw Contours data (*Garmin Quickdraw Contours Settings, page 12*).

Chart Layer Settings

From a chart, select **MENU > Layers > Chart**.

Satellite Photos: Shows high-resolution satellite images on the land or on both land and sea portions of the Navigation chart, when certain premium maps are used (*Showing Satellite Imagery on the Navigation Chart, page 7*).

NOTE: This setting must be enabled to view Standard Mapping charts.

Tides & Currents: Shows current station indicators and tide station indicators on the chart and enables the tides and

current slider, which sets the time for which tides and currents are reported on the map.

Land POIs: Shows points of interest on land.

Navaid: Shows navigational aids, such as ATONs and flashing lights, on the chart. Allows you to select NOAA or IALA navaid type.

Service Points: Shows locations for marine services.

Depth: Adjusts the items on the depth layer (*Water Layer Settings, page 10*).

Restricted Areas: Shows information about restricted areas on the chart.

Photo Points: Shows camera icons for aerial photos (*Viewing Aerial Photos of Landmarks, page 7*).

My Vessel Layer Settings

From a chart, select **MENU > Layers > My Vessel**.

Heading Line: Shows and adjusts the heading line, which is a line drawn on the map from the bow of the boat in the direction of travel (*Setting the Heading Line and Angle Markers, page 6*).

Laylines: Adjusts the laylines, when in sailing mode (*Laylines Settings, page 9*).

Roses: Allows you to display roses on the chart. Wind roses show a visual representation of the wind angle or direction provided by the connected wind sensor. The compass rose indicates the compass direction oriented to the heading of the boat.

Vessel Icon: Sets the icon that represents your present location on the chart.

Laylines Settings

To use the laylines features, you must connect a wind sensor to the chartplotter.

When in sailing mode (*Setting the Vessel Type, page 3*), you can display laylines on the navigation chart. Laylines can be very helpful when racing.

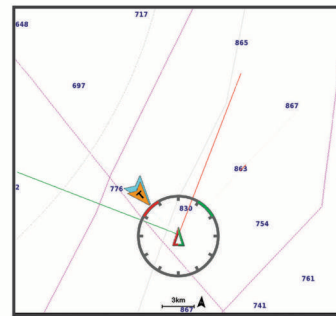

From the navigation chart, select **MENU > Layers > My Vessel > Laylines > Setup**.

Display: Sets how the laylines and vessel appear on the chart, and sets the length of the laylines.

Sailing Angle: Allows you to select how the device calculates laylines. The Actual option calculates the laylines using the measured wind angle from the wind sensor. The Manual option calculates the laylines using manually entered windward and leeward angles.

Windward Angle: Allows you to set a layline based on the windward sailing angle.

Leeward Angle: Allows you to set a layline based on the leeward sailing angle.

Tide Correction: Corrects the laylines based on the tide.

Filter Time Constant: Filters the layline data based on the time interval entered. For a smoother layline that filters out some of the changes in the boat's heading or true wind angle, enter a higher number. For laylines that display a higher sensitivity

to changes in the boat's heading or true wind angle, enter a lower number.

User Data Layer Settings

You can show user data, such as waypoints, boundaries, and tracks, on the charts.

From a chart, select **MENU > Layers > User Data**.

Waypoints: Shows waypoints on the chart and opens the list of waypoints.

Boundaries: Shows boundaries on the chart and opens the list of boundaries.

Tracks: Shows tracks on the chart.

Other Vessels Layer Settings

NOTE: These options require connected accessories, such as an AIS receiver, radar, or VHF radio.

From a chart, select **MENU > Layers > Other Vessels**.

DSC: Sets how DSC vessels and trails appear on the chart, and shows the DSC list.

AIS: Sets how AIS vessels and trails appear on the chart, and shows the AIS list.

Details: Shows other vessel details on the chart.

Projected Heading: Sets the projected heading time for AIS-activated and MARPA-tagged vessels.

AIS Alarm: Sets the safe-zone collision alarm ([Setting the Safe-Zone Collision Alarm, page 8](#)).

Water Layer Settings

From a chart, select **MENU > Layers > Water**.

NOTE: The menu may contain some settings that are not supported by your installed charts or your present location. If you make changes to those settings, the changes will not impact the chart view.

Depth Shading: Specifies an upper and lower depth to shade between.

Shallow Shading: Sets the shades from the shoreline to the specified depth.

Spot Depths: Turns on spot soundings and sets a dangerous depth. Spot depths that are equal to or more shallow than the dangerous depth are indicated by red text.

Fishing Contours: Sets the zoom level for a detailed view of bottom contours and depth soundings and simplifies map presentation for optimal use while fishing.

Relief Shading: Shows the gradient of the bottom with shading. This feature is available only with some premium maps.

Sonar Imagery: Shows sonar imagery to help show the density of the bottom. This feature is available only with some premium maps.

Lake Level: Sets the present water level of the lake. This feature is available only with some premium maps.

Depth Range Shading

You can set color ranges on your map to show the water depths where your target fish are currently biting. You can set deeper ranges to monitor how quickly the bottom depth changes within a specific depth range. You can create up to ten depth ranges. For inland fishing, a maximum of five depth ranges can help reduce map clutter. The depth ranges apply to all charts and all bodies of water.

Some Garmin LakeVü™ and premium supplemental charts have multiple depth range shading by default.

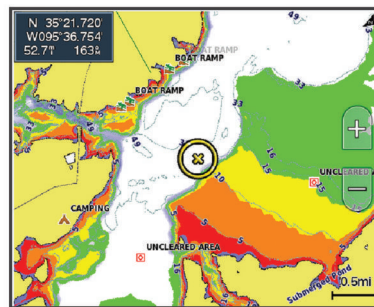

Red	From 0 to 1.5 m (from 0 to 5 ft.)
Orange	From 1.5 to 3 m (from 5 to 10 ft.)
Yellow	From 3 to 4.5 m (from 10 to 15 ft.)
Green	From 4.5 to 7.6 m (from 15 to 25 ft.)

Fish Eye 3D Settings

NOTE: This feature is available with premium charts, in some areas.

From the Fish Eye 3D chart view, select **MENU**.

View: Sets the perspective of the 3D chart view.

Tracks: Shows tracks.

Sonar Cone: Shows a cone that indicates the area covered by the transducer.

Fish Symbols: Shows suspended targets.

Supported Maps

To help you have a safe and enjoyable time on the water, Garmin devices only support official maps produced by Garmin or an approved third party producer.

You can purchase maps from Garmin. If you purchase maps from a seller other than Garmin, investigate the seller before purchasing. Be extra cautious with online sellers. If you have purchased an unsupported map, return it to the seller.

Garmin Quickdraw Contours Mapping

⚠ WARNING

The Garmin Quickdraw Contours mapping feature allows users to generate maps. Garmin makes no representations about the accuracy, reliability, completeness or timeliness of the maps generated by third parties. Any use or reliance on the maps generated by third parties is at your own risk.

The Garmin Quickdraw Contours mapping feature allows you to instantly create maps with contours and depth labels for any body of water.

When Garmin Quickdraw Contours records data, a colored circle surrounds the vessel icon. This circle represents the approximate area of the map that is scanned by each pass.



A green circle indicates good depth and GPS position, and a speed under 16 km/h (10 mph). A yellow circle indicates good depth and GPS position, and a speed between 16 and 32 km/h (10 and 20 mph). A red circle indicates poor depth or GPS position, and a speed above 32 km/h (20 mph).

You can view Garmin Quickdraw Contours in a combination screen or as a single view on the map.

The amount of saved data depends on the size of your memory card, your sonar source, and the speed of your boat as you record data. You can record longer when you use a single-beam sonar. It is estimated that you might be able to record about 1,500 hours of data onto a 2 GB memory card.

When you record data on a memory card in your chartplotter, the new data is added to your existing Garmin Quickdraw Contours map, and is saved on the memory card. When you insert a new memory card, the existing data does not transfer onto the new card.

Mapping a Body of Water Using the Garmin Quickdraw Contours Feature

Before you can use the Garmin Quickdraw Contours feature, you must have sonar depth, your GPS position, and a memory card with free space.

- 1 From a chart view, select **MENU > Quickdraw Contours > Start Recording**.
- 2 When recording is complete, select **MENU > Quickdraw Contours > Stop Recording**.
- 3 Select **Manage > Name**, and enter a name for the map.

Adding a Label to a Garmin Quickdraw Contours Map

You can add labels to a Garmin Quickdraw Contours map to mark hazards or points of interest.

- 1 From the Navigation chart, select a location.
- 2 Select **Add Quickdraw Label**.
- 3 Enter text for the label, and select **Done**.

Garmin Quickdraw Community

The Garmin Quickdraw Community is a free, public, online community that enables you to share your Garmin Quickdraw Contours maps with others. You can also download maps other users have created.

If your device has Wi-Fi technology, you can use the ActiveCaptain app to access the Garmin Quickdraw Community (*Connecting to the Garmin Quickdraw Community with ActiveCaptain*, page 11).

If your device does not have Wi-Fi technology, you can use the Garmin Connect™ website to access the Garmin Quickdraw Community (*Connecting to the Garmin Quickdraw Community with Garmin Connect*, page 11).

Connecting to the Garmin Quickdraw Community with ActiveCaptain

- 1 From your mobile device, open the ActiveCaptain app and connect to the ECHOMAP Plus device (*Getting Started with the ActiveCaptain App*, page 3).
- 2 From the app, select **Quickdraw Community**.

You can download contours from others in the community (*Downloading Garmin Quickdraw Community Maps Using ActiveCaptain*, page 11) and share the contours you have created (*Sharing Your Garmin Quickdraw Contours Maps with the Garmin Quickdraw Community Using ActiveCaptain*, page 11).

Downloading Garmin Quickdraw Community Maps Using ActiveCaptain

You can download Garmin Quickdraw Contours maps that other users have created and shared with the Garmin Quickdraw Community.

- 1 From the ActiveCaptain app on your mobile device, select **Quickdraw Community > Search for Contours**.

- 2 Use the map and search features to locate an area to download.

The red dots represent Garmin Quickdraw Contours maps that have been shared for that area.

- 3 Select **Select Download Region**.
- 4 Drag the box to select the area to download.
- 5 Drag the corners to change the download area.
- 6 Select **Download Area**.

The next time you connect the ActiveCaptain app to the ECHOMAP Plus device, the downloaded contours are transferred to the device automatically.

Sharing Your Garmin Quickdraw Contours Maps with the Garmin Quickdraw Community Using ActiveCaptain

You can share Garmin Quickdraw Contours maps that you have created with others in the Garmin Quickdraw Community.

When you share a contour map, only the contour map is shared. Your waypoints are not shared.

When you set up your ActiveCaptain app, you may have selected to share your contours with the community automatically. If not, follow these steps to enable sharing.

From the ActiveCaptain app on your mobile device, select **Sync with Plotter > Contribute to Community**.

The next time you connect the ActiveCaptain app to the ECHOMAP Plus device, your contour maps are transferred to the community automatically.

Connecting to the Garmin Quickdraw Community with Garmin Connect

- 1 Go to connect.garmin.com.
- 2 Select **Getting Started > Quickdraw Community > Getting Started**.
- 3 If you do not have a Garmin Connect account, create one.
- 4 Sign in to your Garmin Connect account.
- 5 Select **Marine** in the upper-right to open the Garmin Quickdraw widget.

TIP: Make sure you have a memory card in your computer to share Garmin Quickdraw Contours maps.

Sharing Your Garmin Quickdraw Contours Maps with the Garmin Quickdraw Community Using Garmin Connect

You can share Garmin Quickdraw Contours maps that you have created with others in the Garmin Quickdraw Community.

When you share a contour map, only the contour map is shared. Your waypoints are not shared.

- 1 Insert a memory card into the card slot (*Inserting Memory Cards*, page 2).
- 2 Insert the memory card into your computer.
- 3 Access the Garmin Quickdraw Community (*Connecting to the Garmin Quickdraw Community with Garmin Connect*, page 11).
- 4 Select **Share Your Contours**.
- 5 Browse to your memory card, and select the Garmin folder.
- 6 Open the Quickdraw folder, and select the file named **ContoursLog.svy**.

After the file is uploaded, delete the **ContoursLog.svy** file from your memory card to avoid issues with future uploads. Your data will not be lost.

Downloading Garmin Quickdraw Community Maps Using Garmin Connect

You can download Garmin Quickdraw Contours maps that other users have created and shared with the Garmin Quickdraw Community.

If your device does not have Wi-Fi technology, you can access the Garmin Quickdraw Community using the Garmin Connect website.

If your device has Wi-Fi technology, you should access the Garmin Quickdraw Community using the ActiveCaptain app (*Connecting to the Garmin Quickdraw Community with ActiveCaptain*, page 11).

- 1 Insert the memory card into your computer.
- 2 Access the Garmin Quickdraw Community (*Connecting to the Garmin Quickdraw Community with Garmin Connect*, page 11).
- 3 Select **Search for Contours**.
- 4 Use the map and search features to locate an area to download.
The red dots represent Garmin Quickdraw Contours maps that have been shared for that region.
- 5 Select **Select an Area to Download**.
- 6 Drag the edges of the box to select the area to download.
- 7 Select **Start Download**.
- 8 Save the file to your memory card.
TIP: If you cannot find the file, look in the "Downloads" folder. The browser may have saved the file there.
- 9 Remove the memory card from your computer.
- 10 Insert the memory card into the card slot (*Inserting Memory Cards*, page 2).
The chartplotter automatically recognizes the contours maps. The chartplotter may take a few minutes to load the maps.

Garmin Quickdraw Contours Settings

From a chart, select **MENU > Quickdraw Contours > Settings**.

Recording Offset: Sets the distance between the sonar depth and the contour recording depth. If the water level has changed since your last recording, adjust this setting so the recording depth is the same for both recordings.

For example, if the last time you recorded had a sonar depth of 3.1 m (10.5 ft.), and today's sonar depth is 3.6 m (12 ft.), enter -0.5 m (-1.5 ft.) for the a Recording Offset value.

User Display Offset: Sets differences in contour depths and depth labels on your own contours maps to compensate for changes in the water level of a body of water, or for depth errors in recorded maps.

Comm. Display Offset: Sets differences in contour depths and depth labels on the community contours maps to compensate for changes in the water level of a body of water, or for depth errors in recorded maps.

Survey Coloring: Sets the color of the Garmin Quickdraw Contours display. When this setting is turned on, the colors indicate the quality of the recording. When this setting is turned off, the contour areas use standard map colors.
Green indicates good depth and GPS position, and a speed under 16 km/h (10 mph). Yellow indicates good depth and GPS position, and a speed between 16 and 32 km/h (10 and 20 mph). Red indicates poor depth or GPS position, and a speed above 32 km/h (20 mph).

Navigation with a Chartplotter

⚠ WARNING

All route and navigation lines displayed on the chartplotter are only intended to provide general route guidance or to identify proper channels, and are not intended to be precisely followed. Always defer to the nav aids and conditions on the water when navigating to avoid groundings or hazards that could result in vessel damage, personal injury, or death.

The Auto Guidance feature is based on electronic chart information. That data does not ensure obstacle and bottom clearance. Carefully compare the course to all visual sightings, and avoid any land, shallow water, or other obstacles that may be in your path.

When using Go To, a direct course and a corrected course may pass over land or shallow water. Use visual sightings, and steer to avoid land, shallow water, and other dangerous objects.

⚠ CAUTION

If your vessel has an autopilot system, a dedicated autopilot control display must be installed at each steering helm in order to disable the autopilot system.

NOTE: Some chart views are available with premium charts, in some areas.

To navigate, you must choose a destination, set a course or create a route, and follow the course or route. You can follow the course or the route on the Navigation chart, Fishing chart, Perspective 3D chart view, or Mariner's Eye 3D chart view.

You can set and follow a course to a destination using one of three methods: Go To, Route To, or Auto Guidance.

Go To: Takes you directly to the destination. This is the standard option for navigating to a destination. The chartplotter creates a straight-line course or navigation line to the destination. The path may run over land and other obstacles.

Route To: Creates a route from your location to a destination, allowing you to add turns along the way. This option provides a straight-line course to the destination, but allows you to add turns into the route to avoid land and other obstacles.

Auto Guidance: Uses the specified information about your vessel and chart data to determine the best path to your destination. This option is available only when using a compatible premium chart in a compatible chartplotter. It provides a turn-by-turn navigation path to the destination, avoiding land and other obstacles (*Auto Guidance*, page 15).

When you are using a compatible Garmin autopilot connected to the chartplotter using NMEA 2000®, the autopilot follows the Auto Guidance route.

NOTE: Auto Guidance is available with premium charts, in some areas.

Basic Navigation Questions

Question	Answer
How do I make the chartplotter point me in the direction in which I want to go (bearing)?	Navigate using Go To (<i>Setting and Following a Direct Course Using Go To</i> , page 13).
How do I make the device guide me along a straight line (minimizing cross track) to a location using the shortest distance from the present location?	Build a single-leg route and navigate it using Route To (<i>Creating and Navigating a Route From Your Present Location</i> , page 14).
How do I make the device guide me to a location while avoiding charted obstacles?	Build a multi-leg route and navigate it using Route To (<i>Creating and Navigating a Route From Your Present Location</i> , page 14).
How do I make the device steer my automatic pilot?	Navigate using Route To (<i>Creating and Navigating a Route From Your Present Location</i> , page 14).

Question	Answer
Can the device create a path for me?	If you have premium maps that support Auto Guidance and are in an area covered by Auto Guidance, navigate using Auto Guidance (Setting and Following an Auto Guidance Path, page 15).
How do I change the Auto Guidance settings for my boat?	See (Auto Guidance, page 15).

Destinations

You can select destinations using various charts and 3D chart views or using the lists.

Searching for a Destination by Name

You can search for saved waypoints, saved routes, saved tracks, and marine services destinations by name.

- 1 Select **Nav Info** > **Search by Name**.
- 2 Enter at least a portion of the name of your destination.
- 3 If necessary, select **Done**.
The 50 nearest destinations that contain your search criteria appear.
- 4 Select the destination.

Selecting a Destination Using the Navigation Chart

From the Navigation chart, select a destination.

Searching for a Marine Services Destination

NOTE: This feature is available with premium charts, in some areas.

The chartplotter contains information for thousands of destinations offering marine services.

- 1 Select **Nav Info**.
- 2 Select **Offshore Services** or **Inland Services**.
- 3 If necessary, select the marine service category.
The chartplotter shows a list of the nearest locations and the distance and bearing to each.
- 4 Select a destination.
You can select **<** or **>** to view additional information or to show the location on a chart.

Setting and Following a Direct Course Using Go To

WARNING

When using Go To, a direct course and a corrected course may pass over land or shallow water. Use visual sightings, and steer to avoid land, shallow water, and other dangerous objects.

You can set and follow a direct course from your current location to a selected destination.

- 1 Select a destination ([Destinations, page 13](#)).
- 2 Select **Navigate To** > **Go To**.
A magenta line appears. In the center of the magenta line is a thinner purple line that represents the corrected course from your current location to the destination. The corrected course is dynamic, and it moves with your boat when you are off course.
- 3 Follow the magenta line, steering to avoid land, shallow water, and other obstacles.
- 4 If you are off course, follow the purple line (corrected course) to go to your destination, or steer back to the magenta line (direct course).
You can also use the orange course-to-steer arrow, which shows a proposed turning radius to return your boat to the course.

WARNING

Review the path for obstacles before negotiating the turn. If the path is unsafe, reduce your boat speed and determine a safe path back to the course.

Stopping Navigation

From the Navigation chart or Fishing chart, select **MENU** > **Stop Navigation**.

Waypoints

Waypoints are locations you record and store in the device. Waypoints can mark where you are, where you are going, or where you have been. You can add details about the location, such as name, elevation, and depth.

Marking Your Present Location as a Waypoint

From any screen, select **MARK**.

Creating a Waypoint at a Different Location

- 1 Select **Nav Info** > **Waypoints** > **New Waypoint**.
- 2 Select an option:
 - To create the waypoint by entering position coordinates, select **Enter Coordinates**, and enter the coordinates.
 - To create the waypoint using a chart, select **Use Chart**, select the location, and select **SELECT**.
 - To create the waypoint using a range (distance) and bearing, select **Enter Range/Bearing**, and enter the information.

Marking an MOB Location

Select **MARK** > **Man Overboard**.

An international man overboard (MOB) symbol marks the active MOB point and the chartplotter sets a direct course back to the marked location.

Projecting a Waypoint

You can create a new waypoint by projecting the distance and bearing from a different location. This can be helpful when creating sail racing start and finish lines.

- 1 Select **Nav Info** > **Waypoints** > **New Waypoint** > **Enter Range/Bearing**.
- 2 If necessary, select a reference point on the chart.
- 3 Select **Enter Range/Bearing**.
- 4 Enter the distance, and select **Done**.
- 5 Enter the bearing, and select **Done**.
- 6 Select **Position**.

Viewing a List of all Waypoints

Select **Nav Info** > **Waypoints**.

Editing a Saved Waypoint

- 1 Select **Nav Info** > **Waypoints**.
- 2 Select a waypoint.
- 3 Select **Edit Waypoint**.
- 4 Select an option:
 - To add a name, select **Name**, and enter a name.
 - To change the symbol, select **Symbol**.
 - To change the depth, select **Depth**.
 - To change the water temperature, select **Water Temp..**
 - To change the comment, select **Comment**.
 - To move the position of the waypoint, select **Move**.

Moving a Saved Waypoint

- 1 Select **Nav Info** > **Waypoints**.
- 2 Select a waypoint.

- 3 Select **Review > Move**.
- 4 Indicate a new location for the waypoint:
 - To move the waypoint while using the chart, select **Use Chart**, select a new location on the chart, and select **Move**.
 - To move the waypoint using coordinates, select **Enter Coordinates**, and enter the new coordinates.
 - To move the waypoint using a range (distance) and bearing, select **Enter Range/Bearing**, and enter the information.

Browsing for and Navigating to a Saved Waypoint

WARNING

All route and navigation lines displayed on the chartplotter are only intended to provide general route guidance or to identify proper channels, and are not intended to be precisely followed. Always defer to the nav aids and conditions on the water when navigating to avoid groundings or hazards that could result in vessel damage, personal injury, or death.

The Auto Guidance feature is based on electronic chart information. That data does not ensure obstacle and bottom clearance. Carefully compare the course to all visual sightings, and avoid any land, shallow water, or other obstacles that may be in your path.

When using Go To, a direct course and a corrected course may pass over land or shallow water. Use visual sightings, and steer to avoid land, shallow water, and other dangerous objects.

NOTE: Auto Guidance is available with premium charts, in some areas.

Before you can navigate to a waypoint, you must create a waypoint.

- 1 Select **Nav Info > Waypoints**.
- 2 Select a waypoint.
- 3 Select **Navigate To**.
- 4 Select an option:
 - To navigate directly to the location, select **Go To**.
 - To create a route to the location, including turns, select **Route To**.
 - To use Auto Guidance, select **Auto Guidance**.
- 5 Review the course indicated by the magenta line.

NOTE: When using Auto Guidance, a gray segment within any part of the magenta line indicates that Auto Guidance cannot calculate part of the Auto Guidance line. This is due to the settings for minimum safe water depth and minimum safe obstacle height.

- 6 Follow the magenta line, steering to avoid land, shallow water, and other obstacles.

Deleting a Waypoint or an MOB

- 1 Select **Nav Info > Waypoints**.
- 2 Select a waypoint or an MOB.
- 3 Select **Delete**.

Deleting All Waypoints

Select **Nav Info > Manage Data > Clear User Data > Waypoints > All**.

Routes

A route is a path from one location to one or more destinations.

Creating and Navigating a Route From Your Present Location

You can create and immediately navigate a route on the Navigation chart or the Fishing chart. This method does not save the route or the waypoint data.

- 1 From the Navigation chart or Fishing chart, select a destination.
- 2 Select **SELECT > Navigate To > Route To**.
- 3 Select the location of the last turn before the destination.
- 4 Select **SELECT > Add Turn**.
- 5 If necessary, repeat to add turns, working backward from the destination to the present location of your vessel.

The last turn you add should be the first turn you make, starting from your present location. It should be the turn closest to your vessel.
- 6 If necessary, select **MENU**.
- 7 Select **SELECT > Done**.
- 8 Review the course indicated by the magenta line.
- 9 Follow the magenta line, steering to avoid land, shallow water, and other obstacles.

Creating and Saving a Route

This procedure saves the route and all the waypoints in it. The starting point can be your present location or another location.

You can add up to 250 waypoints, or turns, to one route.

- 1 Select **Nav Info > Routes > New > Routes**.
- 2 Select the starting location of the route.
- 3 Select **Add Turn**.
- 4 Select the location of the next turn on the chart.
- 5 Select **Add Turn**.

The chartplotter marks the location of the turn with a waypoint.

- 6 If necessary, repeat steps 4 and 5 to add more turns.
- 7 Select the final destination.

Viewing a List of Routes and Auto Guidance Paths

- 1 Select **Nav Info > Routes**.
- 2 If necessary, select **Filter** to see routes only or Auto Guidance paths only.

Editing a Saved Route

You can change the name of a route or change the turns the route contains.

- 1 Select **Nav Info > Routes**.
- 2 Select a route.
- 3 Select **Edit Route**.
- 4 Select an option:
 - To change the name, select **Name**, and enter the name.
 - To select a waypoint from the turn list, select **Edit Turns > Use Turn List**, and select a waypoint from the list.
 - To select a turn using the chart, select **Edit Turns > Use Chart**, and select a location on the chart.

Browsing for and Navigating a Saved Route

Before you can browse a list of routes and navigate to one of them, you must create and save at least one route.

- 1 Select **Nav Info > Routes**.
- 2 Select a route.
- 3 Select **Navigate To**.
- 4 Select an option:
 - To navigate the route from the starting point used when the route was created, select **Forward**.
 - To navigate the route from the destination point used when the route was created, select **Backward**.

A magenta line appears. In the center of the magenta line is a thinner purple line that represents the corrected course from your present location to the destination. The corrected

course is dynamic, and it moves with your boat when you are off course.

- 5 Review the course indicated by the magenta line.
- 6 Follow the magenta line along each leg in the route, steering to avoid land, shallow water, and other obstacles.
- 7 If you are off course, follow the purple line (corrected course) to go to your destination, or steer back to the magenta line (direct course).

Browsing for and Navigating Parallel to a Saved Route

Before you can browse a list of routes and navigate to one of them, you must create and save at least one route.

- 1 Select **Nav Info > Routes**.
- 2 Select a route.
- 3 Select **Navigate To**.
- 4 Select **Offset** to navigate parallel to the route, offset from it by a specific distance.
- 5 Indicate how to navigate the route:
 - To navigate the route from the starting point used when the route was created, to the left of the original route, select **Forward - Port**.
 - To navigate the route from the starting point used when the route was created, to the right of the original route, select **Forward - Starboard**.
 - To navigate the route from the destination point used when the route was created, to the left of the original route, select **Backward - Port**.
 - To navigate the route from the destination point used when the route was created, to the right of the original route, select **Backward - Starboard**.
- 6 If necessary, select **Done**.

A magenta line appears. In the center of the magenta line is a thinner purple line that represents the corrected course from your present location to the destination. The corrected course is dynamic, and it moves with your boat when you are off course.

- 7 Review the course indicated by the magenta line.
- 8 Follow the magenta line along each leg in the route, steering to avoid land, shallow water, and other obstacles.
- 9 If you are off course, follow the purple line (corrected course) to go to your destination, or steer back to the magenta line (direct course).

Deleting a Saved Route

- 1 Select **Nav Info > Routes**.
- 2 Select a route.
- 3 Select **Review > Delete**.

Deleting All Saved Routes

Select **Nav Info > Manage Data > Clear User Data > Routes**.

Auto Guidance

WARNING

The Auto Guidance feature is based on electronic chart information. That data does not ensure obstacle and bottom clearance. Carefully compare the course to all visual sightings, and avoid any land, shallow water, or other obstacles that may be in your path.

All route and navigation lines displayed on the chartplotter are only intended to provide general route guidance or to identify proper channels, and are not intended to be precisely followed. Always defer to the navaids and conditions on the water when

navigating to avoid groundings or hazards that could result in vessel damage, personal injury, or death.

NOTE: Auto Guidance is available with premium charts, in some areas.

You can use Auto Guidance to plot the best path to your destination. Auto Guidance uses your chartplotter to scan chart data, such as water depth and known obstacles, to calculate a suggested path. You can adjust the path during navigation.

Setting and Following an Auto Guidance Path

- 1 Select a destination (*Destinations, page 13*).
- 2 Select **Navigate To > Auto Guidance**.
- 3 Review the path, indicated by the magenta line.
- 4 Select **Start Navigation**.
- 5 Follow the magenta line, steering to avoid land, shallow water, and other obstacles.

NOTE: When using Auto Guidance, a gray segment within any part of the magenta line indicates that Auto Guidance cannot calculate part of the Auto Guidance line. This is due to the settings for minimum safe water depth and minimum safe obstacle height.

Creating and Saving an Auto Guidance Path

- 1 Select **Nav Info > Routes > New > Auto Guidance**.
- 2 Select a starting point, and select **Next**.
- 3 Select a destination, and select **Next**.
- 4 Select an option:
 - To view a hazard and adjust the path near a hazard, select **Hazard Review**.
 - To adjust the path, select **Adjust Path**, and follow the on-screen instructions.
 - To delete the path, select **Delete**.
 - To save the path, select **Done**.

Adjusting an Auto Guidance Path

- 1 Select **Nav Info > Routes**.
- 2 Select a path, and select **Review > Edit > Adjust Path**.

TIP: When navigating an Auto Guidance path, select the path on the navigation chart, and select **Adjust Path**.
- 3 Select a location on the path.
- 4 Use the arrow keys or drag the point to a new location.
- 5 If necessary, select a point, and select **Remove**.
- 6 Select **Done**.

Canceling an Auto Guidance Calculation in Progress

From the Navigation chart, select **MENU > Cancel**.

TIP: You can select **BACK** to quickly cancel the calculation.

Setting a Timed Arrival

You can use this feature on a route or an Auto Guidance path to get feedback about when you should arrive at a selected point. This allows you to time your arrival at a location, such as a bridge opening or a race starting line.

- 1 From the Navigation chart, select **MENU**.
- 2 Select **Timed Arrival**.

TIP: You can quickly open the Timed Arrival menu by selecting a point on the path or route.

Auto Guidance Path Configurations

CAUTION

The Preferred Depth and Vertical Clearance settings influence how the chartplotter calculates an Auto Guidance path. If an area has an unknown water depth or an unknown obstacle height, the Auto Guidance path is not calculated in that area. If

an area at the beginning or the end of an Auto Guidance path is shallower than the Preferred Depth or lower than the Vertical Clearance settings, the Auto Guidance path may not be calculated in that area, depending on the map data. On the chart, the course through those areas appears as a gray line or a magenta and gray striped line. When your boat enters one of those areas, a warning message appears.

NOTE: Auto Guidance is available with premium charts, in some areas.

NOTE: Not all settings apply to all maps.

You can set the parameters the chartplotter uses when calculating an Auto Guidance path.

Preferred Depth: Sets the minimum water depth, based on chart depth data, that your boat can safely travel over.

NOTE: The minimum water depth for the premium charts (made before 2016) is 3 feet. If you enter a value of less than 3 feet, the charts only use depths of 3 feet for Auto Guidance path calculations.

Vertical Clearance: Sets the minimum height of a bridge or obstacle, based on chart data, that your boat can safely travel under.

Shoreline Distance: Sets how close to the shore you want the Auto Guidance path to be placed. The Auto Guidance path may move if you change this setting while navigating. The available values for this setting are relative, not absolute. To ensure that the Auto Guidance line is placed the appropriate distance from shore, you can assess the placement of the Auto Guidance path using one or more familiar destinations that require navigation through a narrow waterway ([Adjusting the Distance from Shore, page 16](#)).

Adjusting the Distance from Shore

The Shoreline Distance setting indicates how close to the shore you want the Auto Guidance line to be placed. The Auto Guidance line may move if you change this setting while navigating. The available values for the Shoreline Distance setting are relative, not absolute. To ensure the Auto Guidance line is placed the appropriate distance from shore, you can assess the placement of the Auto Guidance line using one or more familiar destinations that require navigation through a narrow waterway.

- 1 Dock your vessel or drop the anchor.
- 2 Select **Settings > Navigation > Auto Guidance > Shoreline Distance > Normal**.
- 3 Select a destination that you have navigated to previously.
- 4 Select **Navigate To > Auto Guidance**.
- 5 Review the placement of the Auto Guidance line, and determine whether the line safely avoids known obstacles and the turns enable efficient travel.
- 6 Select an option:
 - If the placement of the Auto Guidance line is satisfactory, select **MENU > Stop Navigation**, and proceed to step 10.
 - If the Auto Guidance line is too close to known obstacles, select **Settings > Navigation > Auto Guidance > Shoreline Distance > Far**.
 - If the turns in the Auto Guidance line are too wide, select **Settings > Navigation > Auto Guidance > Shoreline Distance > Near**.
- 7 If you selected **Near** or **Far** in step 6, review the placement of the Auto Guidance line, and determine whether the line safely avoids known obstacles and the turns enable efficient travel.

Auto Guidance maintains a wide clearance from obstacles in open water, even if you set the Shoreline Distance setting to Near or Nearest. As a result, the chartplotter may not

reposition the Auto Guidance line, unless the destination selected requires navigation through a narrow waterway.

- 8 Select an option:
 - If the placement of the Auto Guidance line is satisfactory, select **MENU > Stop Navigation**, and proceed to step 10.
 - If the Auto Guidance line is too close to known obstacles, select **Settings > Navigation > Auto Guidance > Shoreline Distance > Farthest**.
 - If the turns in the Auto Guidance line are too wide, select **Settings > Navigation > Auto Guidance > Shoreline Distance > Nearest**.
- 9 If you selected **Nearest** or **Farthest** in step 8, review the placement of the **Auto Guidance** line, and determine whether the line safely avoids known obstacles and the turns enable efficient travel.

Auto Guidance maintains a wide clearance from obstacles in open water, even if you set the Shoreline Distance setting to Near or Nearest. As a result, the chartplotter may not reposition the Auto Guidance line, unless the destination selected requires navigation through a narrow waterway.
- 10 Repeat steps 3 through 9 at least once more, using a different destination each time, until you are familiar with the functionality of the Shoreline Distance setting.

Tracks

A track is a recording of the path of your boat. The track currently being recorded is called the active track, and it can be saved. You can show tracks in each chart or 3D chart view.

Showing Tracks

- 1 From a chart, select **MENU > Layers > User Data > Tracks**.
- 2 Select the tracks to display.

A trailing line on the chart indicates your track.

Setting the Color of the Active Track

- 1 Select **Nav Info > Tracks > Active Track Options > Track Color**.
- 2 Select a track color.

Saving the Active Track

The track currently being recorded is called the active track.

- 1 Select **Nav Info > Tracks > Save Active Track**.
- 2 Select an option:
 - Select the time the active track began.
 - Select **Entire Log**.
- 3 Select **Save**.

Viewing a List of Saved Tracks

Select **Nav Info > Tracks > Saved Tracks**.

Editing a Saved Track

- 1 Select **Nav Info > Tracks > Saved Tracks**.
- 2 Select a track.
- 3 Select **Edit Track**.
- 4 Select an option:
 - Select **Name**, and enter the new name.
 - Select **Track Color**, and select a color.

Saving a Track as a Route

- 1 Select **Nav Info > Tracks > Saved Tracks**.
- 2 Select a track.
- 3 Select **Edit Track > Save As > Save as Route**.

Browsing for and Navigating a Recorded Track

Before you can browse a list of tracks and navigate to them, you must record and save at least one track ([Tracks, page 16](#)).

- 1 Select **Nav Info > Tracks > Saved Tracks**.
- 2 Select a track.
- 3 Select **Follow Track**.
- 4 Select an option:
 - To navigate the track from the starting point used when the track was created, select **Forward**.
 - To navigate the track from the destination point used when the track was created, select **Backward**.
- 5 Review the course indicated by the colored line.
- 6 Follow the line along each leg in the route, steering to avoid land, shallow water, and other obstacles.

Deleting a Saved Track

- 1 Select **Nav Info > Tracks > Saved Tracks**.
- 2 Select a track.
- 3 Select **Delete**.

Deleting All Saved Tracks

Select **Nav Info > Manage Data > Clear User Data > Saved Tracks**.

Retracing the Active Track

The track currently being recorded is called the active track.

- 1 Select **Nav Info > Tracks > Follow Active Track**.
- 2 Select an option:
 - Select the time the active track began.
 - Select **Entire Log**.
- 3 Review the course indicated by the colored line.
- 4 Follow the colored line, steering to avoid land, shallow water, and other obstacles.

Clearing the Active Track

Select **Nav Info > Manage Data > Tracks > Clear Active Track**.

The track memory is cleared, and the active track continues to be recorded.

Managing the Track Log Memory During Recording

- 1 Select **Nav Info > Tracks > Active Track Options**.
- 2 Select **Record Mode**.
- 3 Select an option:
 - To record a track log until the track memory is full, select **Fill**.
 - To continuously record a track log, replacing the oldest track data with new data, select **Wrap**.

Configuring the Recording Interval of the Track Log

You can indicate the frequency at which the track plot is recorded. Recording more frequent plots is more accurate but fills the track log faster. The resolution interval is recommended for the most efficient use of memory.

- 1 Select **Nav Info > Tracks > Active Track Options > Record Interval**.
- 2 Select an option:
 - To record the track based on a distance between points, select **Interval > Distance > Change**, and enter the distance.
 - To record the track based on a time interval, select **Interval > Time > Change**, and enter the time interval.
 - To record the track plot based on a variance from your course, select **Interval > Resolution > Change**, and enter the maximum error allowed from the true course before recording a track point. This is the recommended recording option.

Boundaries

Boundaries allow you to avoid or remain in designated areas in a body of water. You can set an alarm to alert you when you enter or exit a boundary.

You can create boundary areas, lines, and circles using the map. You can also convert saved tracks and routes into boundary lines. You can create a boundary area using waypoints by creating a route from the waypoints, and converting the route into a boundary line.

You can select a boundary to act as the active boundary. You can add the active boundary data to the data fields on the chart.

Creating a Boundary

- 1 Select **Nav Info > Boundaries > New**.
- 2 Select a boundary shape.
- 3 Follow the on-screen instructions.

Converting a Route to a Boundary

Before you can convert a route to a boundary, you must create and save at least one route ([Creating and Saving a Route, page 14](#)).

- 1 Select **Nav Info > Routes**.
- 2 Select a route.
- 3 Select **Edit Route > Save as Boundary**.

Converting a Track to a Boundary

Before you can convert a track to a boundary, you must record and save at least one track ([Saving the Active Track, page 16](#)).

- 1 Select **Nav Info > Tracks > Saved Tracks**.
- 2 Select a track.
- 3 Select **Edit Track > Save As > Save as Boundary**.

Editing a Boundary

- 1 Select **Nav Info > Boundaries**.
- 2 Select a boundary.
- 3 Select **Edit Boundary**.
- 4 Select an option:
 - To edit the appearance of the boundary on the chart, select **Display Options**.
 - To change the boundary lines or name, select **Edit Boundary**.
 - To edit the boundary alarm, select **Alarm**.

Setting a Boundary Alarm

Boundary alarms alert you when you are within a specified distance of a set boundary. This can be helpful when attempting to avoid certain areas or when you should be very alert in certain areas, such as shipping lanes.

- 1 Select **Nav Info > Boundaries**.
- 2 Select a boundary.
- 3 Select **Alarm > On**.
- 4 Select an option.
 - To set an alarm for when your boat is a specified distance from the boundary, select **Warning Distance**, enter a distance, and select **Done**.
 - To set an alarm when you enter the boundary, select **Area > Entering > Exiting**.
 - To set an alarm when you exit the boundary, select **Area > Exiting**.

Deleting a Boundary

- 1 Select **Nav Info > Boundaries**.
- 2 Select a boundary.
- 3 Select **Edit Boundary > Delete**.

Deleting All Saved Waypoints, Routes, and Tracks

Select **Nav Info > Manage Data > Clear User Data > All > OK**.

Sailing Features

Setting the Vessel Type

You can select your boat type to configure the chartplotter settings and to use features customized for your boat type.

- 1 Select **Settings > My Vessel > Vessel Type**.
- 2 Select an option.

Sail Racing

You can use the device to increase the likelihood that your boat will cross the start line of a race exactly when the race begins. When you synchronize the race timer with the official race countdown timer, you are alerted at one-minute intervals as the race start approaches. When you combine the race timer with the virtual start line, the device measures your speed, bearing, and remaining time on the countdown timer. The device uses this data to indicate whether your boat will cross the start line before, after, or at the correct time to start the race.

Starting Line Guidance

Sailing start line guidance is a visual representation of the information you need to cross the start line at the optimal time and speed.

After you set the starboard and port start line pins, and the target speed and time, and after you start the race timer, a predictor line appears. The predictor line extends from your current location toward the start line and the laylines that extend from each pin.

The end point and color of the predictor line indicate where the boat will be when the timer expires, based on your current boat speed.

When the end point is before the start line, the line is white. This indicates the boat must increase speed to reach the start line on time.

When the end point is past the start line, the line is red. This indicates the boat must reduce speed to avoid a penalty for reaching the start line before the timer expires.

When the end point is on the start line, the line is white. This indicates the boat is moving at an optimal speed to reach the start line when the timer expires.

By default, the start line guidance window and the race timer window appear in the Sail Racing combination screen.

Setting the Starting Line

- 1 From the starting line guidance gauge, select **MENU > Start Line**.
- 2 Select an option:
 - To mark the port and starboard starting line marks as you sail past them, select **Ping Marks**.
 - To mark the port and starboard starting line marks by entering their coordinates, select **Enter Coordinates**.
 - To switch the position of the port and starboard marks after you have set them, select **Swap Port & Strbd..**

Using the Starting Line Guidance

You can use the starting line guidance feature to help get you cross the start line, at the optimal speed during a sailing race.

- 1 Mark the starting line ([Setting the Starting Line, page 18](#)).
- 2 From the Start Line Guidance gauge, select **MENU > Target Speed**, and select your target speed when crossing the starting line.

- 3 Select **Target Time**, and select the target time to cross the starting line.
- 4 Select **BACK**.
- 5 Start the racing timer ([Using the Race Timer, page 18](#)).

Using the Race Timer

- 1 From the starting line guidance gauge, select **—** or **+** to set the timer.
- 2 Select **SELECT** to start and stop the timer.

Setting the Distance between the Bow and the GPS Antenna

You can enter the distance between the bow of your boat and the location of your GPS antenna. This helps ensure the bow of your boat crosses the starting line at the precise start time.

- 1 From the starting line guidance gauge, select **MENU > Start Line > GPS Bow Offset**.
- 2 Enter the distance.
- 3 Select **Done**.

Laylines Settings

To use the laylines features, you must connect a wind sensor to the chartplotter.

When in sailing mode ([Setting the Vessel Type, page 3](#)), you can display laylines on the navigation chart. Laylines can be very helpful when racing.

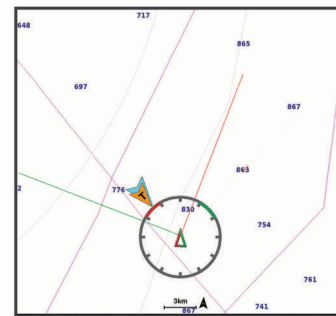

From the navigation chart, select **MENU > Layers > My Vessel > Laylines > Setup**.

Display: Sets how the laylines and vessel appear on the chart, and sets the length of the laylines.

Sailing Angle: Allows you to select how the device calculates laylines. The Actual option calculates the laylines using the measured wind angle from the wind sensor. The Manual option calculates the laylines using manually entered windward and leeward angles.

Windward Angle: Allows you to set a layline based on the windward sailing angle.

Leeward Angle: Allows you to set a layline based on the leeward sailing angle.

Tide Correction: Corrects the laylines based on the tide.

Filter Time Constant: Filters the layline data based on the time interval entered. For a smoother layline that filters out some of the changes in the boat's heading or true wind angle, enter a higher number. For laylines that display a higher sensitivity to changes in the boat's heading or true wind angle, enter a lower number.

Setting the Keel Offset

You can enter a keel offset to compensate the water depth reading for the transducer installation location. This allows you to view the depth of the water below the keel or the true depth of the water, depending on your needs.

If you want to know the water depth below the keel or the lowest point of your boat and the transducer is installed at the water

line or anywhere above the end of the keel, measure the distance from the transducer location to the keel of the boat. If you want to know the true water depth and the transducer is installed below the water line, measure the distance from the bottom of the transducer up to the water line.

NOTE: This option is only available when you have valid depth data.

1 Measure the distance:

- If the transducer is installed at the water line ① or anywhere above the end of the keel, measure the distance from the transducer location to the keel of the boat. Enter this value as a positive number.
- If the transducer is installed at the bottom of the keel ② and you want to know the true depth of the water, measure the distance from the transducer to the water line. Enter this value in as a negative number.

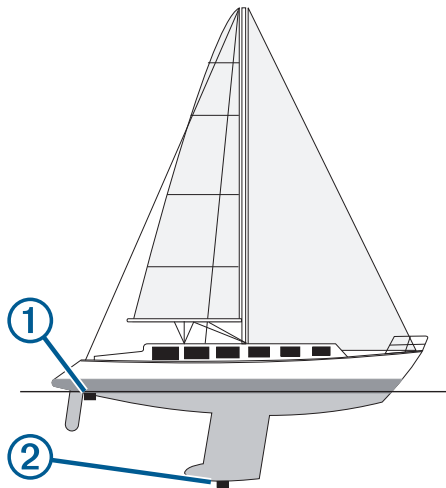

2 Select **Settings > My Vessel > Keel Offset**.

3 Select **+** if the transducer is installed at the water line, or select **-** if the transducer is installed at the bottom of the keel.

Sailboat Autopilot Operation

⚠ CAUTION

When engaged, the autopilot controls only the rudder. You and your crew remain responsible for the sails while the autopilot is engaged.

In addition to heading hold, you can use the autopilot to maintain a wind hold. You can also use the autopilot to control the rudder while tacking and gybing.

Wind Hold

You can set the autopilot to maintain a specific bearing relative to the current wind angle. Your device must be connected to a NMEA 2000 or NMEA® 0183 compatible wind sensor to perform a wind hold or a wind-based tack or gybe.

Setting the Wind Hold Type

Before you can enable the wind hold type, you must connect a NMEA 2000 or NMEA 0183 wind sensor to the autopilot.

For advanced autopilot configuration, see the installation instructions included with your autopilot.

- 1** From the autopilot screen, select **MENU > Autopilot Setup > Wind Hold Type**.
- 2** Select **Apparent** or **True**.

Engaging Wind Hold

Before you can enable the wind hold type, you must connect a NMEA 2000 or NMEA 0183 wind sensor to the autopilot.

When the autopilot is in standby mode, select **Wind Hold**.

Engaging Wind Hold from Heading Hold

Before you can enable the wind hold type, you must connect a NMEA 2000 or NMEA 0183 wind sensor to the autopilot.

With heading hold engaged, select **MENU > Wind Hold**.

Adjusting the Wind Hold Angle with the Autopilot

You can adjust the wind hold angle on the autopilot when wind hold is engaged.

- To adjust the wind hold angle in increments of 1°, select **◀** or **▶**.
- To adjust the wind hold angle in increments of 10°, hold **◀** or **▶**.

Tack and Gybe

You can set the autopilot to perform a tack or gybe while heading hold or wind hold is engaged.

Tacking and Gybing from Heading Hold

- 1** Engage heading hold ([Engaging the Autopilot, page 28](#)).
- 2** Select **MENU**.
- 3** Select an option.

The autopilot steers your boat through a tack or gybe.

Tacking and Gybing from Wind Hold

Before you can engage wind hold, you must have a wind sensor installed.

- 1** Engage wind hold ([Engaging Wind Hold, page 19](#)).
- 2** Select **MENU**.
- 3** Select an option.

The autopilot steers your boat through a tack or gybe, and information about the progress of the tack or gybe appears on the screen.

Setting a Tack and Gybe Delay

The tack and gybe delay allows you to delay steering a tack and gybe after you initiate the maneuver.

- 1** From the autopilot screen, select **MENU > Autopilot Setup > Sailing Setup > Tack/Gybe Delay**.
- 2** Select the length of the delay.
- 3** If necessary, select **Done**.

Enabling the Gybe Inhibitor

NOTE: The gybe inhibitor does not prevent you from manually performing a gybe using the helm or step steering.

The gybe inhibitor prevents the autopilot from performing a gybe.

- 1** From the autopilot screen, select **MENU > Autopilot Setup > Sailing Setup > Gybe Inhibitor**.
- 2** Select **Enabled**.

Sonar Fishfinder

When properly connected to a compatible transducer, your ECHOMAP Plus device can be used as a fishfinder.

For more information about which transducer is best for your needs, go to garmin.com/transducers.

Different sonar views can help you view the fish in the area. The sonar views available vary depending on the type of transducer and sounder module connected to the chartplotter. For example, you can view Garmin ClearVü™ sonar screens only if you have a compatible Garmin ClearVü transducer connected.

There are four basic styles of sonar views available: a full-screen view, a split-screen view that combines two or more views, a split-zoom view, and a split-frequency view that displays two different frequencies. You can customize the settings for each view in the screen. For example, if you are

viewing the split-frequency view, you can separately adjust the gain for each frequency.

If you do not see an arrangement of sonar views to suit your needs, you can create a custom combination screen (*Creating a New Combination Page with the ECHOMAP Plus 70/90*, page 2).

Stopping the Transmission of Sonar Signals

- To disable the active sonar, from the sonar screen, select **MENU > Sonar Transmit**.
- To disable all sonar transmissions, press \odot , and select **Disable Sonar**.

Changing the Sonar View

- From a combination screen with sonar, select **MENU > Configure Combination > Edit Combination**.
- Select the window to change.
- Select a sonar view.

Traditional Sonar View

There are several full-screen views available, depending on the transducer that is connected.

The full-screen Traditional sonar view shows a large image of the sonar readings from a transducer. The range scale along the right side of the screen shows the depth of detected objects as the screen scrolls from the right to the left.

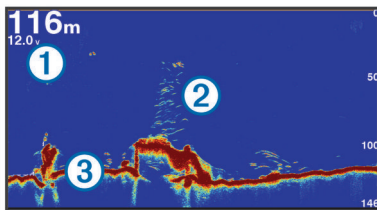

①	Depth information
②	Suspended targets or fish
③	Bottom of the body of water

Split-Frequency Sonar View

In the split-frequency sonar view, the two sides of the screen show a full-view graph of sonar data of different frequencies.

NOTE: The split-frequency sonar view requires the use of a dual-frequency transducer.

Split-Zoom Sonar View

The split-zoom sonar view shows a full-view graph of sonar readings, and a magnified portion of that graph, on the same screen.

Garmin ClearVü Sonar View

NOTE: To receive Garmin ClearVü scanning sonar, you need a compatible chartplotter or fishfinder and a compatible transducer. For information about compatible transducers, go to garmin.com/transducers.

Garmin ClearVü high-frequency sonar provides a detailed picture of the fishing environment around the boat in a detailed representation of structures the boat is passing over.



Traditional transducers emit a conical beam. The Garmin ClearVü scanning sonar technology emits two narrow beams, similar to the shape of the beam in a copying machine. These beams provide a clearer, picture-like image of what is beneath the boat.

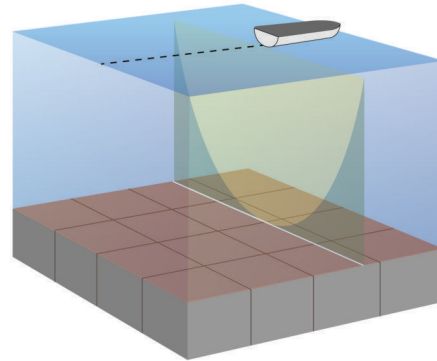

SideVü Sonar View

NOTE: Not all models provide built-in SideVü sonar support. If your model does not provide built-in SideVü sonar, you need a compatible sounder module and compatible SideVü transducer.

If your model does provide built-in SideVü sonar, you need a compatible SideVü transducer.

SideVü scanning sonar technology shows you a picture of what lies to the sides of the boat. You can use this as a search tool to find structures and fish.

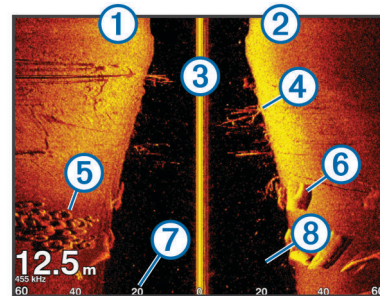

①	Left side of the boat
②	Right side of the boat
③	The transducer on your vessel
④	Trees
⑤	Old tires
⑥	Logs
⑦	Distance from the side of the boat
⑧	Water between the vessel and the bottom

SideVü Scanning Technology

Instead of a more common conical beam, the SideVü transducer uses a flat beam to scan the water and bottom to the sides of your boat.

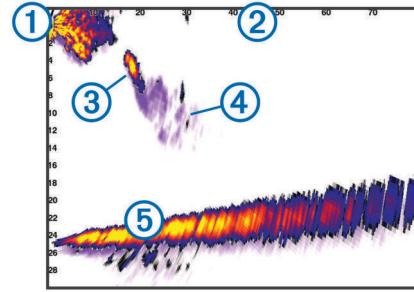
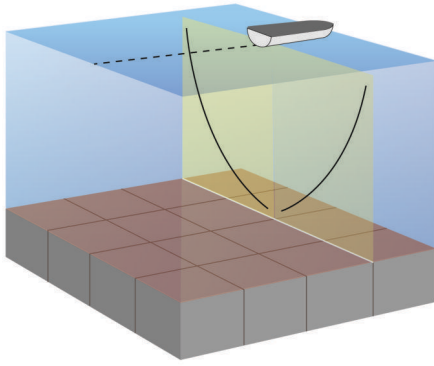

①	Boat
②	Range
③	Fish
④	Trails
⑤	Bottom

Panoptix™ Sonar Views

NOTE: Not all models support Panoptix transducers.

To receive Panoptix sonar, you need a compatible chartplotter and a compatible transducer.

The Panoptix sonar views allow you to see all around the boat in real time. You can also watch your bait underwater and bait schools in front of or below your boat.

The LiveVü sonar views provide you a view of the live movement either in front of or below your boat. The screen updates very quickly, producing sonar views that look more like live video.

The RealVü 3D sonar views provide three-dimensional views of either what is in front of or below your boat. The screen updates with each sweep of the transducer.

To see all five Panoptix sonar views, you need one transducer to show the down views and a second transducer to show the forward views.

To access the Panoptix sonar views, select Sonar, and select a view.

RealVü 3D Forward Sonar View

This sonar view shows a three-dimensional view of what is in front of the transducer. This view can be used when you are stationary and you need to see the bottom and the fish approaching the boat.

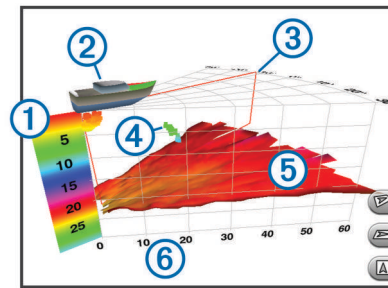

①	Color legend
②	Boat
③	Ping indicator
④	Fish
⑤	Bottom
⑥	Range

LiveVü Down Sonar View

This sonar view shows a two-dimensional view of what is below the boat and can be used to see a bait ball and fish.

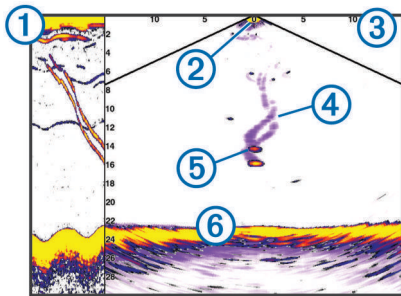

①	Panoptix down view history in a scrolling sonar view
②	Boat
③	Range
④	Trails
⑤	Drop shot rig
⑥	Bottom

RealVü 3D Down Sonar View

This sonar view shows a three-dimensional view of what is below the transducer and can be used when you are stationary and want to see what is around your boat.

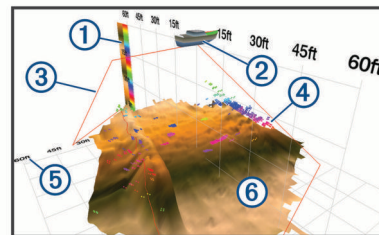

①	Color legend
②	Boat
③	Sonar beam
④	Range
⑤	Fish
⑥	Bottom

LiveVü Forward Sonar View

This sonar view shows a two-dimensional view of what is in front of the boat and can be used to see a bait ball and fish.

RealVü 3D Historical Sonar View

This sonar view provides a three-dimensional view of what is behind your boat as you are moving and shows the entire water column in 3D, from the bottom to the top of the water. This view is used for finding fish.

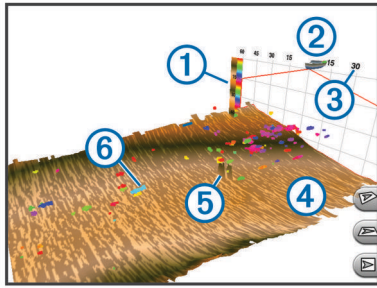

①	Color legend
②	Boat
③	Range
④	Bottom
⑤	Structure
⑥	Fish

FrontVü Sonar View

The Panoptix FrontVü sonar view increases your situational awareness by showing obstructions under the water, up to 91 meters (300 feet) in front of the boat.

The ability to effectively avoid forward collisions with FrontVü sonar decreases as your speed rises above 8 knots.

To see the FrontVü sonar view, you must install and connect a compatible transducer, such as a PS21 transducer. You may need to update the transducer software.

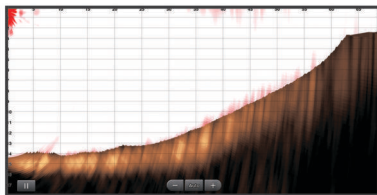

Panoptix LiveScope™ Sonar View

This sonar view shows a live view of what is in front of or below the boat and can be used to see fish and structures.

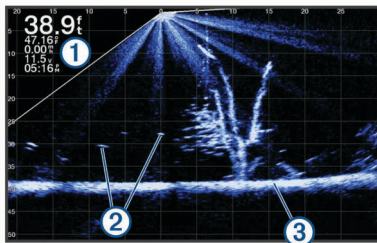

①	Depth information
②	Suspended targets or fish
③	Bottom of the body of water

Flasher View

The flasher shows sonar information on a circular depth scale, indicating what is beneath your boat. It is organized as a ring that starts at the top and progresses clockwise. Depth is indicated by the scale inside the ring. Sonar information flashes on the ring when it is received at the depth indicated.

The flasher colors indicate different strengths of the sonar return. The default color scheme follows a traditional sonar color palette, in which yellow indicates the strongest return, orange indicates a strong return, red indicates a weaker return, and blue indicates the weakest return.

Select Flasher.

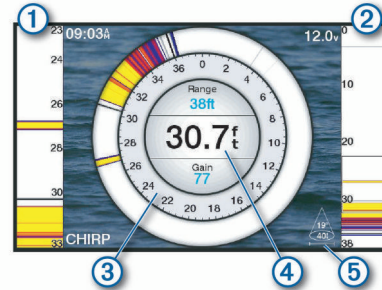

①	A-scope, zoomed-in view of the right side view*
②	A-scope with zoom area outlined**
③	Depth scale
④	Depth at your present location
⑤	Angle and span of the transducer cone at the current frequency

*The A-scopes are not available on ECHOMAP Plus 40 models.

**On the ECHOMAP Plus 60 models, you can press ▲ and ▼ to move the zoom area up and down.

Flasher Page Shortcuts

On touchscreen devices, you can interact with the flasher and a-scopes.

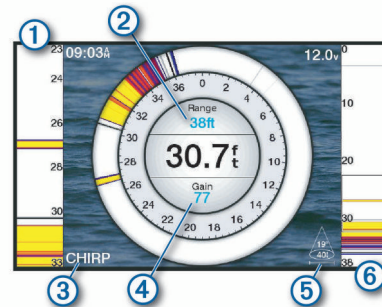

①	Drag up and down to move the zoom area.
②	Select to adjust the range.
③	Select to adjust the frequency.
④	Select to adjust the gain.
⑤	Select to adjust the beam width.
⑥	Drag the zoom window to move the zoom area on the left A-scope. Spread two fingers apart to zoom in. Pinch two fingers together to zoom out.

Selecting the Transducer Type

Before you can select the transducer type, you must know what kind of transducer you have.

This chartplotter is compatible with a range of accessory transducers, including the Garmin ClearVü transducers, which are available at garmin.com/transducers.

If you are connecting a transducer that was not included with the chartplotter, you may need to set the transducer type to make the sonar function properly.

- From a sonar view, select **MENU > Sonar Setup > Installation > Transducer Type**.

- 2 Select the transducer to change.
- 3 Select an option:
 - If your transducer is listed, select it from the list.
 - If you have a 200/77 kHz, dual-beam transducer, select **Dual Beam (200/77 kHz)**.
 - If you have a 200/50 kHz, dual-frequency transducer, select **Dual Frequency (200/50 kHz)**.

Calibrating the Compass

Before you can calibrate the compass, the transducer must be installed on the shaft far enough away from the trolling motor to avoid magnetic interference, and deployed in the water. Calibration must be of sufficient quality to enable the internal compass.

NOTE: To use the compass, you must mount the transducer on the transom or the trolling motor shaft. The compass may not work when you mount the transducer on the motor.

NOTE: For best results, you should use a heading sensor such as the SteadyCast™ heading sensor. The heading sensor shows the direction the transducer is pointing relative to the boat.

NOTE: Compass calibration is available only for transducers with an internal compass, such as the PS21-TR transducer.

You can begin turning your boat before calibrating, but you must fully rotate your boat 1.5 times during calibration.

- 1 From an applicable sonar view, select **MENU > Sonar Setup > Installation**.
- 2 If necessary, select **Use AHRS** to turn on the AHRS sensor.
- 3 Select **Calibrate Compass**.
- 4 Follow the on-screen instructions.

Selecting a Sonar Source

This feature may not be available with all models.

When you are using more than one sonar data source for a particular sonar view, you can select the source to use for that sonar view. For example, if you have two sources for Garmin ClearVü, you can select the source to use from the Garmin ClearVü sonar view.

- 1 Open the sonar view for which you will change the source.
- 2 Select **MENU > Sonar Setup > Source**.
- 3 Select the source for this sonar view.

Renaming a Sonar Source

You can rename a sonar source to easily identify that source. For example, you use "Bow" as the name of the transducer on the bow of your boat.

To rename a source, you must be in the applicable sonar view for the source. For example, to rename the Garmin ClearVü sonar source, you must open the Garmin ClearVü sonar view.

- 1 From the sonar view, select **MENU > Sonar Setup > Source > Rename Sources**.
- 2 Enter the name.

Creating a Waypoint on the Sonar Screen

- 1 From a sonar view, select **MENU > II**.
- 2 Select a location.
- 3 Select **Q** or **SELECT**.
- 4 If necessary, edit the waypoint information, such as the waypoint name.

Pausing the Sonar Display

From a sonar view, select **MENU > II**.

Measuring Distance on the Sonar Screen

You can measure the distance between two points on the SideVü sonar view.

- 1 From the SideVü sonar view, select **II**.
- 2 Select a location on the screen.
- 3 Select **A**.
A push pin appears on the screen at the selected location.
- 4 Select another location.
The distance and angle from the pin is listed in the upper-left corner.

TIP: To reset the pin and measure from the current location of the pin, select **Set Reference**.

Viewing Sonar History

You can scroll the sonar display to view historical sonar data.

NOTE: Not all transducers save historical sonar data.

Select **BACK** to exit history.

Sonar Sharing

This feature may not be available on all chartplotter models.

You can view the sonar data from other compatible ECHOMAP models connected on the Garmin Marine Network.

Each chartplotter on the network can display sonar data from every compatible sonar module and transducer on the network, no matter where the chartplotters and transducers are mounted on your boat. For example, from one ECHOMAP Plus 93sv device mounted at the back of the boat, you can view the sonar data from another ECHOMAP Plus device and Garmin ClearVü transducer mounted at the front of your boat.

When sharing sonar data, the values of some sonar settings, such as Range and Gain, are synchronized across the devices on the network. The values of other sonar settings, such as the Appearance settings, are not synchronized and should be configured on each individual device. In addition, the scroll rates of the various traditional and Garmin ClearVü sonar views are synchronized to make the split views more cohesive.

NOTE: Using multiple transducers simultaneously can create cross talk, which can be removed by adjusting the Interference sonar setting.

Adjusting the Level of Detail

You can control the level of detail and noise shown on the sonar screen either by adjusting the gain for traditional transducers or by adjusting the brightness for Garmin ClearVü transducers.

If you want to see the highest intensity signal returns on the screen, you can lower the gain or brightness to remove lower intensity returns and noise. If you want to see all return information, you can increase the gain or brightness to see more information on the screen. This also increases noise, and can make it more difficult to recognize actual returns.

- 1 From a sonar view, select **MENU**.
- 2 Select **Gain** or **Brightness**.
- 3 Select an option:
 - To increase or decrease the gain or brightness manually, select **Up** or **Down**.
 - To allow the chartplotter to adjust the gain or brightness automatically, select an automatic option.

Adjusting the Color Intensity

You can adjust the intensity of colors and highlight areas of interest on the sonar screen by adjusting the color gain for traditional transducers or the contrast for Garmin ClearVü and SideVü/ClearVü transducers. This setting works best after you

have adjusted the level of detail shown on the screen using the gain or brightness settings.

If you want to highlight smaller fish targets or create a higher intensity display of a target, you can increase the color gain or contrast setting. This causes a loss in the differentiation of the high intensity returns at the bottom. If you want to reduce the intensity of the return, you can reduce the color gain or contrast.

- 1 From a sonar view, select **MENU**.
- 2 Select an option:
 - While in the Garmin ClearVü or SideVü sonar view, select **Contrast**.
 - While in a Panoptix LiveVü sonar view, select **Color Gain**.
 - While in another sonar view, select **Sonar Setup > Appearance > Color Gain**.
- 3 Select an option:
 - To increase or decrease the color intensity manually, select **Up** or **Down**.
 - To use the default setting, select **Default**.

Sonar Recordings

Recording the Sonar Display

NOTE: Not all models support sonar recording.

- 1 Insert a memory card into the card slot.
- 2 From a sonar view, select **MENU > Record Sonar**.

15 minutes of sonar recording uses approximately 200 MB of space of the inserted memory card. An individual recording automatically ends after it reaches 4 GB in size. You can record sonar data until the card reaches capacity.

Stopping the Sonar Recording

From a sonar view, select **MENU > Stop Recording**.

Deleting a Sonar Recording

- 1 Insert a memory card with sonar recordings into the card slot.
- 2 Select **Sonar > Sonar Recordings**.
- 3 Select a recording.
- 4 Select **Delete**.

Traditional, Garmin ClearVü, and SideVü Sonar Setup

NOTE: Not all options and settings apply to all models, sounder modules, and transducers.

From a sonar view, select **MENU > Sonar Setup**.

Depth Line: Shows a quick-reference depth line.

Scroll Speed: Sets the rate at which the sonar scrolls from right to left.

In shallow water you might want to slow the scroll speed to extend the length of time the information is displayed on screen. In deeper water you can increase the scroll speed.

Range Lines: Shows the vertical lines indicating the distance to the right and left of the boat. This setting is available for SideVü sonar view.

Color Scheme: Sets the color scheme of the sonar view. This setting might be available in the Appearance menu.

The high contrast color schemes provide darker color assignments to the low intensity returns. The low contrast color schemes provide color assignments to the low intensity returns that are similar to the background color.

Appearance: See [Sonar Appearance Settings, page 25](#).

Overlay Numbers: Sets the data shown on the sonar screen.

Advanced: See [Advanced Sonar Settings, page 25](#).

Installation: Restores the default sonar settings.

Setting the Zoom Level on the Sonar Screen

- 1 From a sonar view, select **MENU > Zoom**.
- 2 Select an option:
 - To set the depth and zoom automatically, select **Auto**.

TIP: You can select **»»** for more options.
 - To set the depth range of the magnified area manually, select **Manual > »»**, select **View Up** or **View Down** to set the depth range of the magnified area, and select **Zoom In** or **Zoom Out** to increase or decrease the magnification of the magnified area.
 - To magnify one particular area of the screen, select **Magnify**.

TIP: You can drag the magnification box to a new location on the screen.
 - To zoom in on the sonar data from the bottom depth, select **Bottom Lock**.

To cancel the zoom, deselect the option.

Setting the Scroll Speed

You can set the rate at which the sonar image moves across the screen. A higher scroll speed shows more detail until there is no additional detail to show, at which point it starts stretching out the existing detail. This can be useful while moving or trolling, or when you are in very deep water where the sonar is pinging very slowly. A lower scroll speed displays sonar information on the screen longer.

For most situations, the Default setting provides a good balance between a quickly scrolling image and less distorted targets.

- 1 From a sonar view, select **MENU > Sonar Setup > Scroll Speed**.
- 2 Select an option:
 - To adjust the scroll speed automatically using speed-over-ground or water speed data, select **Auto**.

The **Auto** setting selects a scroll rate to match the boat speed, so targets in the water are drawn with the correct aspect ratio and appear less distorted. When viewing Garmin ClearVü or SideVü sonar views or searching for structure, it is recommend to use the **Auto** setting.
 - To scroll faster, select **Up**.
 - To scroll more slowly, select **Down**.

Adjusting the Range of the Depth or Width Scale

You can adjust the range of the depth scale traditional and Garmin ClearVü sonar views and the range of the width scale for the SideVü sonar view.

Allowing the device to adjust the range automatically keeps the bottom within the lower or outer third of the sonar screen, and can be useful for tracking a bottom that has minimal or moderate terrain changes.

Manually adjusting the range enables you to view a specified range, which can be useful for tracking a bottom that has large terrain changes, such as a drop-offs or cliffs. The bottom can appear on the screen as long as it appears within the range you have set.

- 1 From a sonar view, select **MENU > Range**.
 - 2 Select an option:
 - To allow the chartplotter to adjust the range automatically, select **Auto**.
 - To increase or decrease the range manually, select **Up** or **Down**.

TIP: From the sonar screen, you can select **+** or **-** to manually adjust the range.
- TIP:** When viewing multiple sonar screens, you can select **SELECT** to choose the active screen.

Sonar Appearance Settings





From a sonar view, select **MENU > Sonar Setup > Appearance**.

Color Scheme: Sets the color scheme.

A-Scope: Displays a vertical flasher along the right side of the screen that shows instantaneously the range to targets along a scale.

Edge: Highlights the strongest signal from the bottom to help define the hardness or softness of the signal.

Fish Symbols: Sets how the sonar interprets suspended targets.

	Shows suspended targets as symbols and background sonar information.
	Shows suspended targets as symbols with target depth information and background sonar information.
	Shows suspended targets as symbols.
	Shows suspended targets as symbols with target depth information.

Sonar Alarms

NOTE: Not all options are available on all transducers.

Select **Settings > Alarms > Sonar**.

Shallow Water: Sets an alarm to sound when the depth is less than the specified value.



Deep Water: Sets an alarm to sound when the depth is greater than the specified value.

FrontVü Alarm: Sets an alarm to sound when the depth in front of the vessel is less than the specified value, which can help you avoid running aground ([Setting the FrontVü Depth Alarm, page 26](#)). This alarm is available only with Panoptix FrontVü transducers.

Water Temp.: Sets an alarm to sound when the transducer reports a temperature that is 2°F (1.1°C) above or below the specified temperature.

Fish

Fish: Sets an alarm to sound when the device detects a suspended target.

-  sets the alarm to sound when fish of all sizes are detected.
-  sets the alarm to sound only when medium or large fish are detected.
-  sets the alarm to sound only when large fish are detected.

Advanced Sonar Settings

NOTE: Not all options and settings apply to all models and transducers.

From a sonar view, select **MENU > Sonar Setup > Advanced**.

Interference: Adjusts the sensitivity to reduce the effects of interference from nearby sources of noise.

The lowest interference setting that achieves the desired improvement should be used to remove interference from the screen. Correcting installation issues that cause noise is the best way to eliminate interference.

Surface Noise: Hides surface noise to help reduce clutter. Wider beam widths (lower frequencies) can show more targets, but can generate more surface noise.

Color Gain: See [Adjusting the Level of Detail, page 23](#).

TVG: Adjusts the appearance of returns to compensate for weakened sonar signals in deeper water, and reduces the appearance of noise near the surface. When the value of this setting is increased, the colors associated with low-level noise and fish targets appear more consistent through

various water depths. This setting also reduces the noise near the surface of the water.

Transducer Installation Settings

NOTE: Not all options and settings apply to all models and transducers.

From a sonar view, select **MENU > Sonar Setup > Installation**.

Restore Sonar Defaults: Restores the factory default settings for the sonar view.

Transducer Type: Allows you to select the type of transducer that is connected to the device.

Flip Left/Right: Changes the orientation of the SideVü sonar view when the transducer is installed backward.

Flipped: Sets the orientation of the Panoptix sonar view when the transducer is installed with the cables pointing toward the port side of the boat.

Beam Width: Sets the width of the Panoptix transducer beam.

Narrow beam widths allow you to see deeper and farther. Wider beam widths allow you to see more coverage area.

Use AHRS: Allows the internal attitude heading and reference system (AHRS) sensors to detect the installation angle of the Panoptix transducer. When this setting is turned off, it is assumed the transducer is installed at a 45-degree angle.

Sonar Frequencies

NOTE: The frequencies available depend on the chartplotter, sounder modules, and transducer being used.

Adjusting the frequency helps adapt the sonar for your particular goals and the present depth of the water.

Higher frequencies use narrow beam widths, and are better for high-speed operation and rough sea conditions. Bottom definition and thermocline definition can be better when using a higher frequency.

Lower frequencies use wider beam widths, which can let the fisherman see more targets, but could also generate more surface noise and reduce bottom signal continuity during rough sea conditions. Wider beam widths generate larger arches for fish target returns, making them ideal for locating fish. Wider beam widths also perform better in deep water, because the lower frequency has better deep water penetration.

CHIRP frequencies allow you to sweep each pulse through a range of frequencies, resulting in better target separation in deep water. CHIRP can be used to distinctly identify targets, like individual fish in a school, and for deep water applications. CHIRP generally performs better than single frequency applications. Because some fish targets may show up better using a fixed frequency, you should consider your goals and water conditions when using CHIRP frequencies.

Some sonar black boxes and transducers also provide the ability to customize preset frequencies for each transducer element, which enables you to change the frequency quickly using the presets as the water and your goals change.

Viewing two frequencies concurrently using the split-frequency view allows you to see deeper with the lower frequency return and, at the same time, see more detail from the higher frequency return.

Selecting the Transducer Frequency

NOTE: You cannot adjust the frequency for all sonar views and transducers.

You can select which frequencies appear on the sonar screen.

NOTICE

Always be aware of local regulations on sonar frequencies. For example, to protect orca whale pods, you might be prohibited from using frequencies between 50 to 80 khz with in ½ mile of

an orca whale pod. It is your responsibility to use the device in compliance with all applicable laws and ordinances.

- 1 From a sonar view, select **MENU > Frequency**.
- 2 Select a frequency suited to your needs and water depth.
For more information on frequencies, see [Sonar Frequencies, page 25](#).

Creating a Frequency Preset

NOTE: Not available with all transducers.

You can create a preset to save a specific sonar frequency, which allows you to change frequencies quickly.

- 1 From a sonar view, select **MENU > Frequency**.
- 2 Select **Add**.
- 3 Enter a frequency.

Turning On the A-Scope

NOTE: This feature is available in the Traditional sonar views.

The a-scope is a vertical flasher along the right side of the view, showing you what is underneath the transducer right now. You can use the a-scope to identify target returns that may be missed when the sonar data is quickly scrolling across the screen, such as when your boat is moving at high speeds. It can also be helpful for detecting fish that are close to the bottom.

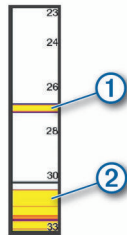

The a-scope above shows fish returns ① and a soft bottom return ②.

From a sonar view, select **MENU > Sonar Setup > Appearance > A-Scope**.

Panoptix Sonar Setup

Adjusting the RealVü Viewing Angle and Zoom Level

You can change the viewing angle of the RealVü sonar views. You can also zoom in and out of the view.

From a RealVü sonar view, select an option:

- To adjust the viewing angle, use the arrow keys.
- To zoom in and out, turn the knob.

Adjusting the RealVü Sweep Speed

You can update how quickly the transducer sweeps back and forth. A faster sweep rate creates a less detailed image, but the screen refreshes faster. A slower sweep rate creates a more detailed image, but the screen refreshes more slowly.

NOTE: This feature is not available for the RealVü 3D Historical sonar view.

- 1 From a RealVü sonar view, select **MENU > Sweep Speed**.
- 2 Select an option.

LiveVü Forward and FrontVü Sonar Menu

From the LiveVü Forward or FrontVü sonar view, select **MENU**.

Gain: Controls the level of detail and noise shown on the sonar screen.

If you want to see the highest intensity signal returns on the screen, you can lower the gain to remove lower intensity returns and noise. If you want to see all return information, you can increase the gain to see more information on the

screen. This also increases noise, and can make it more difficult to recognize actual returns.

Depth Range: Adjusts the range of the depth scale.

Allowing the device to adjust the range automatically keeps the bottom within the lower portion of the sonar screen, and can be useful for tracking a bottom that has minimal or moderate terrain changes.

Manually adjusting the range enables you to view a specified range, which can be useful for tracking a bottom that has large terrain changes, such as a drop-offs or cliffs. The bottom can appear on the screen as long as it appears within the range you have set.

Forward Range: Adjusts the range of the forward scale.

Allowing the device to adjust the range automatically adjusts the forward scale in relation to the depth. Manually adjusting the range enables you to view a specified range. The bottom can appear on the screen as long as it appears within the range you have set. Manually reducing this option can reduce the effectiveness of the FrontVü Alarm, reducing your reaction time to low depth readings.

Transmit Angle: Adjusts the focus of the transducer to the port or starboard side. This feature is available only with RealVü capable Panoptix transducers, such as the PS30, PS31, and PS60.

Sonar Transmit: Stops the active transducer from transmitting.

FrontVü Alarm: Sets an alarm to sound when the depth in front of the vessel is less than the specified value ([Setting the FrontVü Depth Alarm, page 26](#)). This is available only with Panoptix FrontVü transducers.

Sonar Setup: Adjusts the setup of the transducer and the appearance of the sonar returns.

Setting the LiveVü and FrontVü Transducer Transmit Angle

This feature is available only with RealVü capable Panoptix transducers, such as the PS30, PS31, and PS60.

You can change the transducer transmit angle to aim the transducer at a particular area of interest. For example, you might aim the transducer to follow a bait ball or focus on a tree as you pass it.

- 1 From a LiveVü or FrontVü sonar view, select **MENU > Transmit Angle**.
- 2 Select an option.

Setting the FrontVü Depth Alarm

⚠ WARNING

The FrontVü depth alarm is a tool for situational awareness only, and may not prevent groundings in all circumstances. It is the obligation of the vessel operator to ensure safe operation of the vessel.

This alarm is available only with Panoptix FrontVü transducers.

You can set an alarm to sound when the depth is below a specified level. For best results, you should set the bow offset when using the front collision alarm ([Setting the Bow Offset, page 27](#)).

- 1 From the FrontVü sonar view, select **MENU > FrontVü Alarm**.
- 2 Select **On**.
- 3 Enter the depth at which the alarm is triggered, and select **Done**.

On the FrontVü screen, a depth line shows the depth at which the alarm is set. The line is green when you are in a safe depth. The line turns yellow when you are going faster than the forward range gives you time to react (10 seconds). It turns red and sounds an alarm when the system detects an obstruction or the depth is less than the entered value.

⚠ CAUTION

The ability to effectively avoid running aground with FrontVü sonar decreases as your speed rises above 8 knots.

LiveVü and FrontVü Appearance Settings

From a LiveVü or FrontVü Panoptix sonar view, select **MENU > Sonar Setup > Appearance**.

Color Scheme: Sets the color palette.

Color Gain: Adjusts the intensity of colors shown on the screen.

You can select a higher color gain value to see targets higher in the water column. A higher color gain value also allow you to differentiate low intensity returns higher in the water column, but this causes a loss in the differentiation of the returns at the bottom. You can select a lower color gain value when targets are near the bottom, to help you distinguish between targets and high intensity returns such as sand, rock, and mud.

Trails: Sets the how long the trails appear on the screen. The trails show the movement of the target.

Bottom Fill: Colors the bottom brown to distinguish it from the water returns.

Grid Overlay: Shows a grid of range lines.

Scroll History: Shows the sonar history in a traditional sonar view.

RealVü Appearance Settings

From a RealVü sonar view, select **MENU > Sonar Setup > Appearance**.

Point Colors: Sets a different color palette for the sonar return points.

Bottom Colors: Sets the color scheme for the bottom.

Bottom Style: Sets the style for the bottom. When you are in deep water, you can select the Points option and manually set the range to a shallower value.

Color Key: Shows a legend of the depths the colors represent.

Panoptix Transducer Installation Settings

From a Panoptix sonar view, select **MENU > Sonar Setup > Installation**.

Install Depth: Sets the depth below the water line where the Panoptix transducer is mounted. Entering the actual depth at which the transducer is mounted results in a more accurate visual presentation of what is in the water.

Bow Offset: Sets the distance between the bow and the forward view Panoptix transducer installation location. This allows you to view the forward distance from the bow instead of the transducer location.

This applies to Panoptix transducers in the FrontVü, LiveVü Forward, and RealVü 3D Forward sonar views.

Beam Width: Sets the width of the down view Panoptix transducer beam. Narrow beam widths allow you to see deeper and farther. Wider beam widths allow you to see more coverage area.

This applies to Panoptix transducers in the FrontVü, LiveVü Down, and LiveVü Forward sonar views.

Use AHRS: Enables the internal attitude heading and reference system (AHRS) sensors to detect the installation angle of the Panoptix transducer automatically. When this setting is turned off, you can enter the specific installation angle for the transducer using the Pitch Angle setting. Many forward view transducers are installed at a 45-degree angle and down view transducers are installed at a zero-degree angle.

Flipped: Sets the orientation of the Panoptix sonar view when the down view transducer is installed with the cables pointing toward the port side of the boat.

This applies to Panoptix transducers in the LiveVü Down, RealVü 3D Down, and RealVü 3D Historical sonar views.

Calibrate Compass: Calibrates the internal compass in the Panoptix transducer ([Transducer Installation Settings, page 25](#)).

This applies to Panoptix transducers with an internal compass, such as the PS21-TR transducer.

Orientation: Controls if the transducer is in down or forward installation mode. The Auto setting uses the AHRS sensor to determine the orientation.

This applies to PS22 and LiveScope transducers.

Focus: Adjusts the sonar view to compensate for the speed of sound in water. The Auto setting uses the temperature of the water to calculate the speed of sound.

This applies to LiveScope transducers.

Restore Sonar Defaults: Restores the sonar settings to the factory default values.

Setting the Bow Offset

For forward view Panoptix transducers, you can enter a bow offset to compensate the forward distance readings for the transducer installation location. This allows you to view the forward distance from the bow instead of the transducer installation location.

This feature applies to Panoptix transducers in the FrontVü, LiveVü Forward, and RealVü 3D Forward sonar views.

1 Measure the horizontal distance ① from the transducer to the bow.

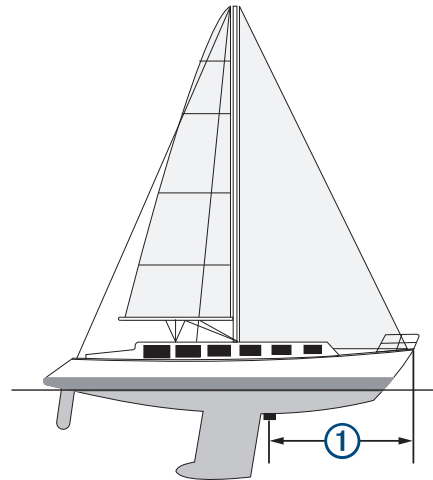

2 From an applicable sonar view, select **MENU > Sonar Setup > Installation > Bow Offset**.

3 Enter the distance measured, and select **Done**.

On the applicable sonar view, the forward range shifts by the distance you entered.

Autopilot

⚠ WARNING

You can use the autopilot feature only at a station installed next to a helm, throttle, and helm control device.

You are responsible for the safe and prudent operation of your vessel. The autopilot is a tool that enhances your capability to operate your boat. It does not relieve you of the responsibility of safely operating your boat. Avoid navigational hazards and never leave the helm unattended.

Always be prepared to promptly regain manual control of your boat.

Learn to operate the autopilot on calm and hazard-free open water.

Use caution when operating the autopilot near hazards in the water, such as docks, pilings, and other boats.

NOTE: This feature is only available on models with NMEA 2000 network capabilities.

The autopilot system continuously adjusts the steering of your boat to maintain a constant heading (heading hold). The system also allows manual steering and several modes of automatic-steering functions and patterns.

When the compatible chartplotter is connected to a compatible Garmin autopilot system, you can engage and control the autopilot from the chartplotter.

For information about compatible Garmin autopilot systems, go to garmin.com.

Autopilot Screen



①	Actual heading
②	Intended heading (heading the autopilot is steering toward)
③	Actual heading (when in standby mode) Intended heading (when engaged)
④	Rudder position indicator (This functionality is available only when a rudder sensor is connected.)

Adjusting the Step Steering Increment

- 1 From the Autopilot screen, select **MENU > Autopilot Setup > Step Turn Size**.
- 2 Select an increment.

Setting the Power Saver

You can adjust the level of rudder activity.

- 1 From the autopilot screen, select **MENU > Autopilot Setup > Power Mode Setup > Power Saver**.
- 2 Select a percentage.

Selecting a higher percentage reduces rudder activity and heading performance. The higher the percentage, the more the course deviates before the autopilot corrects it.

TIP: In choppy conditions at low speeds, increasing the Power Saver percentage reduces rudder activity.

Selecting the Preferred Heading Source

NOTICE

For best results, use the autopilot CCU internal compass for the heading source. Using a third-party GPS compass can cause the data to be delivered erratically and may result in excessive delays. The autopilot needs timely information, and therefore cannot often use third-party GPS compass data for GPS location or speed. If a third-party GPS compass is used, the autopilot will likely report loss of navigation data and speed source periodically.

If you have more than one heading source on the network, you can select a your preferred source. The source could be a compatible GPS compass or a magnetic heading sensor.

- 1 From the autopilot screen, select **MENU > Autopilot Setup > Preferred Sources**

- 2 Select a source.

If the selected heading source is unavailable, the autopilot screen does not display any data.

Engaging the Autopilot

When you engage the autopilot, the autopilot takes control of the helm and steers the boat to maintain your heading.

From any screen, select **Engage**.

Your intended heading shows in the center of the Autopilot screen.

Steering Patterns

WARNING

You are responsible for the safe operation of your boat. Do not begin a pattern until you are certain that the water is clear of obstacles.

The autopilot can steer the boat in preset patterns for fishing, and it can also perform other specialty maneuvers such as U-turns and Williamson turns.

Following the U-Turn Pattern

You can use the u-turn pattern to turn the boat around 180 degrees and maintain the new heading.

- 1 From the autopilot screen, select **MENU > Pattern Steering > U-Turn**.
- 2 Select **Engage Port** or **Engage Starboard**.

Setting Up and Following the Circles Pattern

You can use the circles pattern to steer the boat in a continuous circle, in a specified direction, and at a specified time interval.

- 1 From the autopilot screen, select **MENU > Pattern Steering > Circles**.
- 2 If necessary, select **Time**, and select a time for the autopilot to steer one complete circle.
- 3 Select **Engage Port** or **Engage Starboard**.

Setting Up and Following the Zigzag Pattern

You can use the zigzag pattern to steer the boat from port to starboard and back, over a specified time and angle, across your present heading.

- 1 From the autopilot screen, select **MENU > Pattern Steering > Zigzag**.
- 2 If necessary, select **Amplitude**, and select a degree.
- 3 If necessary, select **Period**, and select a length of time.
- 4 Select **Engage Zigzag**.

Following the Williamson Turn Pattern

You can use the Williamson turn pattern to steer the boat around with the intent of running alongside the location where the Williamson turn pattern was initiated. The Williamson turn pattern can be used in man overboard situations.

- 1 From the autopilot screen, select **MENU > Pattern Steering > Williamson Turn**.
- 2 Select **Engage Port** or **Engage Starboard**.

Reactor™ Autopilot Remote Control

WARNING

You are responsible for the safe and prudent operation of your vessel. The autopilot is a tool that enhances your capability to operate your boat. It does not relieve you of the responsibility of safely operating your boat. Avoid navigational hazards and never leave the helm unattended.

You can wirelessly connect a Reactor autopilot remote control to the chartplotter to control the compatible Reactor autopilot system.

For more information about using the remote, see the Reactor autopilot remote control instructions at garmin.com

Pairing a Reactor Autopilot Remote Control With a Chartplotter

- 1 Select **Settings > Communications > Wireless Devices > Autopilot Remote**.
- 2 If necessary, select **Enable**.
- 3 Select **New Connection**.
- 4 On the remote control, select  **Pair with MFD**.
The chartplotter beeps and shows a confirmation message.
- 5 On the chartplotter, select **Yes** to complete the pairing process.

Changing the Functions of the Reactor Autopilot Remote Control Action Keys

You can change the patterns or actions assigned to the Reactor autopilot remote control action keys.

- 1 Select **Settings > Communications > Wireless Devices > Autopilot Remote > Button Actions**.
- 2 Select an action key to change.
- 3 Select a pattern or action to assign to the action key.

Force™ Trolling Motor Control

⚠ WARNING

Do not run the motor when the propeller is out of the water. Contact with the rotating propeller may result in severe injury.

Do not use the motor in areas where you or other people in the water may come into contact with the rotating propeller.

Always disconnect the motor from the battery before cleaning or servicing the propeller to avoid injury.

You are responsible for the safe and prudent operation of your vessel. The autopilot is a tool that enhances your capability to operate your boat. It does not relieve you of the responsibility of safely operating your boat. Avoid navigational hazards and never leave the helm unattended.

Learn to operate the autopilot on calm and hazard-free open water.

Use caution when operating the autopilot near hazards in the water, such as docks, pilings, and other boats.

⚠ CAUTION

When using the autopilot features, be prepared for sudden stops, acceleration, and turns.

When stowing or deploying the motor, be aware of the risk of entrapment or pinching from moving parts, which can result in injury.



When stowing or deploying the motor, be aware of slick surfaces around the motor. Slipping when stowing or deploying the motor may result in injury.

You can connect the Force trolling motor to the chartplotter to view and control the motor using the chartplotter.

Connecting to a Trolling Motor

You can connect the chartplotter wirelessly to a compatible Garmin Force trolling motor on your boat to control the trolling motor from the chartplotter.

- 1 Turn on the chartplotter and the trolling motor.
- 2 Enable the Wi-Fi network on the chartplotter ([Setting Up the Wi-Fi Wireless Network, page 38](#)).

- 3 If multiple chartplotters are connected on the Garmin Marine Network, make sure this chartplotter is the host of the Wi-Fi network.
- 4 On the chartplotter, select **Settings > Communications > Wireless Devices > Garmin Trolling Motor**.
- 5 On the trolling motor display panel, press  three times to enter pairing mode.
 on the trolling motor display panel is solid blue as it searches for a connection to the chartplotter, and turns green when the connection is successful.

After the chartplotter and trolling motor connect successfully, enable the trolling motor overlay bar to control the motor ([Adding the Trolling Motor Controls to Screens, page 29](#)).

Adding the Trolling Motor Controls to Screens

After you have connected the chartplotter to the Force trolling motor, you must add the trolling motor control bar to screens to control the trolling motor.

- 1 Open a screen from which you would like to control the trolling motor.
- 2 Select an option:
 - From a combination page or SmartMode™ layout, select **MENU > Edit > Overlay Numbers**.
 - From a full screen, select **MENU > xxx**.
- 3 Select **Top Bar** or **Bottom Bar**.
- 4 Select **Trolling Motor Bar**.









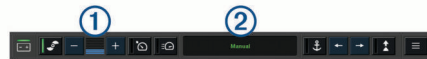



Repeat these steps to add the trolling motor controls to all of the screens from which you would like to control the trolling motor.

Trolling Motor Control Bar

The trolling motor control bar allows you to control a Force trolling motor and see the status of the motor.

Select an item to engage it. The button illuminates when selected. Select the item again to disengage it.



	Trolling motor battery status.
	Turns the propeller on and off.
	Reduces the speed.
	Speed indicator.
	Increases the speed.
	Enables the cruise control at the current speed over ground (SOG).
	Engages the propeller at full speed.
	Trolling motor status.
	Enables anchor lock, which uses the trolling motor to hold your position.
	Steers the trolling motor. When in anchor lock, jogs the anchor lock position forward, backward, left, or right.
	Enables heading hold (set and maintain the current heading). When the trolling motor is in heading hold, an autopilot bar appears in the trolling motor bar.
	Opens the trolling motor settings.

Trolling Motor Settings

From the trolling motor bar, select .

Calibrate: Calibrates the trolling motor compass ([Calibrating the Trolling Motor Compass, page 30](#)) and sets the trolling motor bow offset ([Setting the Bow Offset, page 30](#)).

Anchor Gain: Sets the response of the trolling motor when in anchor lock mode. If you need the trolling motor to be more responsive and move quicker, increase the value. If the motor is moving too much, decrease the value.

Navigation Gain: Sets the response of the trolling motor when navigating. If you need the trolling motor to be more responsive and move quicker, increase the value. If the motor is moving too much, decrease the value.

Heading Hold Mode: Sets the heading hold mode. The Vessel Align option attempts to keep the boat pointing in the same direction. The Navigate To option attempts to navigate a straight line in the requested direction.

Auto Power On: Turns on the trolling motor when you apply power to the system.

Prop. Stow Side: Sets which side of the trolling motor the propeller rotates to when stowing the trolling motor. This is helpful when you store other items near the stowed propeller.

Shortcut Keys: Enables the shortcut keys on the trolling motor remote control to work with this particular chartplotter. The keys work with only one chartplotter at a time.

Restore Defaults: Resets the trolling motor settings to the factory default values.

Assigning a Shortcut to the Trolling Motor Remote Control Shortcut Keys

You can quickly open commonly used screens by assigning a shortcut key on the trolling motor remote control. You can create a shortcut to screens, such as sonar screens and charts.

NOTE: If you have more than one chartplotter on the network, you can assign shortcut keys to one chartplotter only.

- 1 Open a screen.
- 2 Hold a shortcut key.

TIP: The shortcut is also saved to the Frequently Used category with the shortcut key number.



Calibrating the Trolling Motor Compass

You must calibrate the compass in the trolling motor before you can use the autopilot features.

- 1 Drive the boat to an open area of calm water.
- 2 From the trolling motor bar, select  > **Calibrate** > **Compass Cal.**
- 3 Follow the on-screen instructions.

Setting the Bow Offset

Based on the installation angle, the trolling motor may not align with the center line of your boat. For the best results, you should set the bow offset.

- 1 Adjust the angle of the trolling motor  so it aligns with the center line of your boat , pointing straight forward.

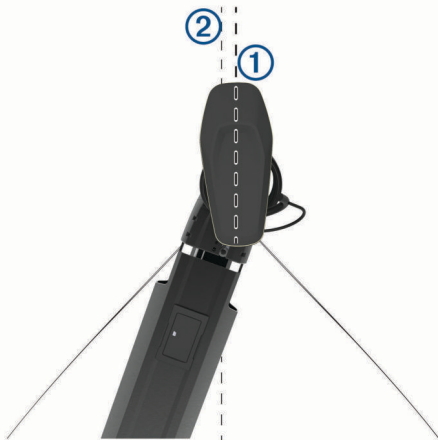

- 2 From the trolling motor bar, select  > **Calibrate** > **Bow Offset**.

Digital Selective Calling

Chartplotter and NMEA 0183 VHF Radio Functionality

When your chartplotter is connected to a NMEA 0183 VHF radio, these features are enabled.

- The chartplotter can transfer your GPS position to your radio. If your radio is capable, GPS position information is transmitted with DSC calls.
- The chartplotter can receive digital selective calling (DSC) distress and position information from the radio.
- The chartplotter can track the positions of vessels sending position reports.

Turning On DSC

Select **Settings** > **Other Vessels** > **DSC**.

DSC List

The DSC list is a log of the most recent DSC calls and other DSC contacts you have entered. The DSC list can contain up to 100 entries. The DSC list shows the most recent call from a boat. If a second call is received from the same boat, it replaces the first call in the call list.

Viewing the DSC List

Before you can view the DSC list, the chartplotter must be connected to a VHF radio that supports DSC.

Select **Nav Info** > **Other Vessels** > **DSC List**.

Adding a DSC Contact

You can add a vessel to your DSC list. You can make calls to a DSC contact from the chartplotter.

- 1 Select **Nav Info** > **Other Vessels** > **DSC List** > **Add Contact**.
- 2 Enter the Maritime Mobile Service Identity (MMSI) of the vessel.
- 3 Enter the name of the vessel.

Incoming Distress Calls

If your compatible chartplotter and VHF radio are connected using NMEA 0183, your chartplotter alerts you when your VHF radio receives a DSC distress call. If position information was sent with the distress call, that information is also available and recorded with the call.

 designates a distress call in the DSC list and marks the position of the vessel on the Navigation chart at the time of the DSC distress call.

Navigating to a Vessel in Distress

 designates a distress call in the DSC list and marks the position of a vessel on the Navigation chart at the time of the DSC distress call.

- 1 Select **Nav Info** > **Other Vessels** > **DSC List**.
- 2 Select a position-report call.
- 3 Select **Navigate To**.
- 4 Select **Go To** or **Route To**.

Position Tracking

When you connect the chartplotter to a VHF radio using NMEA 0183, you can track vessels that send position reports.

This feature is also available with NMEA 2000, when the vessel sends the correct PGN data (PGN 129808; DSC Call Information).

Every position report call received is logged in the DSC list (*DSC List*, page 30).

Viewing a Position Report

- 1 Select **Nav Info > Other Vessels > DSC List**.
- 2 Select a position-report call.
- 3 Select an option:
 - To view the position report details, select **>**.
 - To view to a chart marking the location, select **<**.

Navigating to a Tracked Vessel

- 1 Select **Nav Info > Other Vessels > DSC List**.
- 2 Select a position-report call.
- 3 Select **Navigate To**.
- 4 Select **Go To** or **Route To**.

Creating a Waypoint at the Position of a Tracked Vessel

- 1 Select **Nav Info > Other Vessels > DSC List**.
- 2 Select a position-report call.
- 3 Select **Create Waypoint**.

Editing Information in a Position Report

- 1 Select **Nav Info > Other Vessels > DSC List**.
- 2 Select a position-report call.
- 3 Select **Edit**.
 - To enter the name of the vessel, select **Name**.
 - To select a new symbol, select **Symbol**, if available.
 - To enter a comment, select **Comment**.
 - To show a trail line for the vessel if your radio is tracking the position of the vessel, select **Trail**.
 - To select a color for the trail line, select **Trail Line**.

Deleting a Position-Report Call

- 1 Select **Nav Info > Other Vessels > DSC List**.
- 2 Select a position-report call.
- 3 Select **Edit > Clear Report**.

Viewing Vessel Trails on the Chart

You can view trails for all tracked vessels on some chart views. By default, a black line indicates the path of the vessel, a black dot indicates each previously reported position of a tracked vessel, and a blue flag indicates the last reported position of the vessel.

- 1 From a chart or 3D chart view, select **MENU > Layers > Other Vessels > DSC > DSC Trails**.
- 2 Select the number of hours to show tracked vessels on the chart.

For example, if you select 4 Hours, all trail points that are less than four hours old appear for all tracked vessels.

Individual Routine Calls

When you connect the chartplotter to a Garmin VHF radio, you can use the chartplotter interface to set up an individual routine call.

When setting up an individual routine call from your chartplotter, you can select the DSC channel on which you want to communicate. The radio transmits this request with your call.

Selecting a DSC Channel

NOTE: The selection of a DSC channel is limited to those channels that are available in all frequency bands. The default

channel is 72. If you select a different channel, the chartplotter uses that channel for subsequent calls until you call using another channel.

- 1 Select **Nav Info > Other Vessels > DSC List**.
- 2 Select a vessel or a station to call.
- 3 Select **Call with Radio > Channel**.
- 4 Select an available channel.

Making an Individual Routine Call

NOTE: When initiating a call from the chartplotter, if the radio does not have an MMSI number programmed, the radio will not receive call information.

- 1 Select **Nav Info > Other Vessels > DSC List**.
- 2 Select a vessel or a station to call.
- 3 Select **Call with Radio**.
- 4 If necessary, select **Channel**, and select a new channel.
- 5 Select **Send**.

The chartplotter sends information about the call to the radio.
- 6 On your Garmin VHF radio, complete the call.

Making an Individual Routine Call to an AIS Target

- 1 From a chart or 3D chart view, select an AIS target.
- 2 Select **AIS Vessel > Call with Radio**.
- 3 If necessary, select **Channel**, and select a new channel.
- 4 Select **Send**.

The chartplotter sends information about the call to the radio.
- 5 On your Garmin VHF radio, complete the call.

Gauges and Graphs

The gauges and graphs provide various information about the engine and environment. To view the information, a compatible transducer or sensor must be connected to the network.

Viewing the Compass

You can view information about your bearing, heading, and route using the compass.

Select **Gauges > Compass**.

Viewing Trip Gauges

Trip gauges show information for odometer, speed, time, and fuel for your present trip.

Select **Gauges > Trip**.

Resetting Trip Gauges

- 1 Select **Gauges > Trip > MENU**.
- 2 Select an option:
 - To set all the readings for the present trip to zero, select **Reset Trip**.
 - To set the maximum speed reading to zero, select **Reset Maximum Speed**.
 - To set the odometer reading to zero, select **Reset Odometer**.
 - To set all the readings to zero, select **Reset All**.

Viewing Engine and Fuel Gauges

Before you can view engine and fuel gauges, you must be connected to a NMEA 2000 network capable of sensing engine and fuel data. See the installation instructions for details.

Select **Gauges > Engine**.

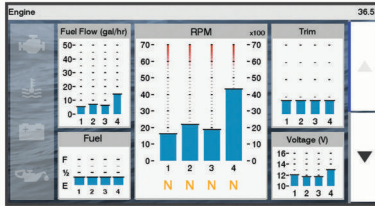

Selecting the Number of Engines Shown in Gauges

You can show information for up to four engines.

- 1 From the engine gauges screen, select **MENU > Gauge Setup > Engine Selection > Number of Engines**.
- 2 Select an option:
 - Select the number of engines.
 - Select **Auto Configure** to automatically detect the number of engines.

Customizing the Engines Shown in Gauges

Before you can customize how the engines are shown in the gauges, you must manually select the number of engines ([Selecting the Number of Engines Shown in Gauges, page 32](#)).

- 1 From the engine gauges screen, select **MENU > Gauge Setup > Engine Selection > Number of Engines**.
- 2 Select **First Engine**.
- 3 Select the engine to display in the first gauge.
- 4 Repeat for the remaining engine bars.

Enabling Status Alarms for Engine Gauges

You can enable the chartplotter to display engine status alarms.

From the engine gauges screen, select **MENU > Gauge Setup > Status Alarms > On**.

When an engine alarms is triggered, a gauge status alarm message appears and the gauge may become red depending on the type of alarm.

Enabling Some Engine Gauge Status Alarms

- 1 From the engine gauges screen, select **MENU > Gauge Setup > Status Alarms > Custom**.
- 2 Select one or more engine gauge alarms to turn on or off.

Setting the Fuel Alarm

Before you can set a fuel level alarm, a compatible fuel flow sensor must be connected to the chartplotter.

You can set an alarm to sound when the total amount of remaining onboard fuel reaches the level you specify.

- 1 Select **Settings > Alarms > Fuel > Set Total Fuel Onboard > On**.
- 2 Enter the remaining amount of fuel that triggers the alarm, and select **Done**.

Setting the Fuel Capacity of the Vessel

- 1 Select **Settings > My Vessel > Fuel Capacity**.
- 2 Enter the combined total capacity of the fuel tanks.

Synchronizing the Fuel Data with the Actual Vessel Fuel

You can synchronize the fuel levels in the chartplotter with the actual fuel in the vessel when you add fuel to your vessel.

- 1 Select **Gauges > Engine > MENU**.
- 2 Select an option:
 - After you have filled up all the fuel tanks on the vessel, select **Fill Up All Tanks**. The fuel level is reset to maximum capacity.
 - After you have added less than a full tank of fuel, select **Add Fuel to Boat**, and enter the amount added.

- To specify the total fuel in the vessel tanks, select **Set Total Fuel Onboard**, and enter the total amount of fuel in the tanks.

Viewing the Wind Gauges

Before you can view wind information, you must have a wind sensor connected to the chartplotter.

Select **Gauges > Wind**.

Configuring the Sailing Wind Gauge

You can configure the sailing wind gauge to show true or apparent wind speed and angle.

- 1 From the wind gauge, select **MENU > Sailing Wind Gauge**.
- 2 Select an option:
 - To show true or apparent wind angle, select **Needle**, and select an option.
 - To show true or apparent wind speed, select **Wind Speed**, and select an option.

Configuring the Speed Source

You can specify whether the vessel speed data displayed on the gauge and used for wind calculations is based on water speed or GPS speed.

- 1 From the wind gauge, select **MENU > Compass Gauge > Speed Display**.
- 2 Select an option:
 - To calculate the vessel speed based on data from the water-speed sensor, select **Water Speed**.
 - To calculate the vessel speed based on GPS data, select **GPS Speed**.

Configuring the Heading Source of the Wind Gauge

You can specify the source of the heading displayed on the wind gauge. Magnetic heading is the heading data received from a heading sensor, and GPS heading is calculated by your chartplotter GPS (course over ground).

- 1 From the wind gauge, select **MENU > Compass Gauge > Heading Source**.
- 2 Select **GPS Hdg** or **Magnetic**.

NOTE: When moving at low speeds or when stationary, the magnetic compass source is more accurate than the GPS source.

Customizing the Close-Hauled Wind Gauge

You can specify the range of the close-hauled wind gauge for both the upwind scale and the downwind scale.

- 1 From the wind gauge, select **MENU > Compass Gauge > Set Gauge Type > Close Hauled Gauge**.
- 2 Select an option:
 - To set the maximum and minimum values that appear when the upwind close-hauled wind gauge appears, select **Change Upwind Scale**, and set the angles.
 - To set the maximum and minimum values that appear when the downwind close-hauled wind gauge appears, select **Change Downwind Scale**, and set the angles.
 - To view true or apparent wind, select **Wind**, and select an option.

Digital Switching

NOTE: This feature is not available on all models.

Your chartplotter can be used to monitor and control circuits when a compatible system is connected.

For example, you can control the interior lights and navigation lights on the vessel. You can also monitor live well circuits.

To access the digital switching controls, select **Switching**.

For more information about purchasing and configuring a digital switching system, contact your Garmin dealer.

Adding and Editing a Digital Switching Page

You can add and customize digital switching pages to the chartplotter.

- 1 Select **Switching > MENU**.
- 2 Select **Add Page** or select a page to edit. .
- 3 Set up the page as needed:
 - To enter a name for the page, select **Name**.
 - To set up the switches, select **Edit Switches**.

Tide, Current, and Celestial Information

Tide Station Information

You can view information about a tide station for a specific date and time, including the tide height, and when the next high and low tides will occur. By default, the chartplotter shows tide information for the most recently viewed tide station, present date, and past hour.

Select **Nav Info > Tides & Currents > Tides**.

Current Station Information

NOTE: Current station information is available with certain detailed maps.

You can view information about a current station for a specific date and time, including the current speed and level of the current. By default, the chartplotter shows current information for the most recently viewed current station and for the present date and time.

Select **Nav Info > Tides & Currents > Currents**.

Celestial Information

You can view information about sunrise, sunset, moonrise, moonset, moon phase, and the approximate sky view location of the sun and moon. The center of the screen represents the sky overhead, and the outermost rings represent the horizon. By default, the chartplotter shows celestial information for the present date and time.

Select **Nav Info > Tides & Currents > Celestial**.

Viewing Tide Station, Current Station, or Celestial Information for a Different Date

- 1 Select **Nav Info > Tides & Currents**.
- 2 Select **Tides, Currents, or Celestial**.
- 3 Select an option:
 - To view information for a different date, select **Change Date > Manual**, and enter a date.
 - To view information for today, select **Change Date > Use Current Date**.
 - If available, to view information for the day after the date shown, select **Next Day**.
 - If available, to view information for the day before the date shown, select **Previous Day**.

Viewing Information for a Different Tide or Current Station

- 1 Select **Nav Info > Tides & Currents**.
- 2 Select **Tides** or **Currents**.
- 3 Select **Nearby Stations**.
- 4 Select a station.

Media Player

NOTE: The media player feature is not compatible with all chartplotter models.

NOTE: Not all features are available on all connected media players.

If you have a compatible stereo connected to the NMEA 2000 network, you can control the stereo using the chartplotter. The chartplotter should automatically detect the media player when it is first connected.

You can play media from sources connected to the media player and sources connected to the NMEA 2000 network.

Opening the Media Player

Before you can open the media player, you must connect a compatible device to the chartplotter.

Select **Media**.

Media Player Icons

NOTE: Not all devices have these icons.

Icon	Description
★	Saves or deletes a channel as a preset
↺	Repeats all songs
↺ ¹	Repeats one song
↻	Scans for stations
⏮⏭	Searches for stations or skips songs
🔄	Shuffles

Selecting the Media Source

When you have multiple media devices connected on a network, such as the NMEA 2000 network, you can select the media source you want to control from your chartplotter.

NOTE: You can play media only from sources that are connected to the device.

NOTE: Not all features are available on all media sources.

- 1 From the media screen, select **MENU > Source**.

NOTE: The source menu appears only for devices that support multiple media sources.
- 2 Select a source.

Playing Music

Browsing for Music

- 1 From the media screen, select **Browse** or **MENU > Browse**.
- 2 Select **SELECT** or select an option.

Enabling Alphabetical Search

You can enable the alphabetical search feature to find a song or album in a large list.

From the media screen, select **MENU > Installation > Alpha Search**.

Setting a Song to Repeat

- 1 While playing a song, select **MENU > Repeat**.
- 2 If necessary, select **Single**.

Setting All Songs to Repeat

From the media screen, select **MENU > Repeat > All**.

Setting Songs to Shuffle

- 1 From the media screen, select **MENU > Shuffle**.
- 2 If necessary, select an option.

Adjusting the Volume

Enabling and Disabling Zones

If you have wired your vessel's speakers into zones, you can enable needed zones and disable unused zones.

- 1 From the media screen, select **MENU > Audio Levels > Enable/Disable Zones**.
- 2 Select a zone.

Muting the Media Volume

- 1 From the media screen, select .
- 2 If necessary, select **SELECT**.

VHF Radio

NOTE: These features are available on some stereos with a VHF receiver.

Scanning VHF Channels

Before you can scan VHF channels, you must set the source to VHF.

You can monitor VHF channels saved as presets for activity and automatically switch to an active channel.

From the VHF media screen, select **MENU > Scan**.

Adjusting the VHF Squelch

NOTE: This feature is available on some stereos with a VHF receiver.

- 1 From the VHF source page, select **MENU > Squelch**.
- 2 Use the slider bar to adjust the VHF squelch.

Radio



To listen to AM or FM radio, you must have a suitable marine AM/FM antenna properly connected to the stereo and be within range of a broadcasting station. For instructions on connecting an AM/FM antenna, see the stereo installation instructions.

To listen to DAB stations, you must have the appropriate equipment (*DAB Playback*, page 34). For instructions on connecting a DAB adapter and antenna, see the installation instructions provided with your adapter and antenna.

Setting the Tuner Region

- 1 From the media screen, select **MENU > Installation > Tuner Region**.
- 2 Select an option.

Changing the Radio Station

- 1 From the media screen, select an applicable source, such as **FM**.
- 2 Select  or  to tune to a station.

Changing the Tuning Mode

You can change how you select a station for some media types, such as FM or AM radio.

NOTE: Not all tuning modes are available for all media sources.

- 1 From the media screen, select **MENU > Tuning Mode**.
- 2 Select an option.
- 3 If necessary, select **SELECT**.

Presets

You can save your favorite AM stations and FM stations as presets for easy access.

You can save your favorite DAB stations if you are connected to an optional DAB antenna.

Saving a Station as a Preset

- 1 From an applicable media screen, tune to the station to save as a preset.

- 2 Select **Presets > Add Current Channel**.

Removing a Preset

- 1 From an applicable media screen, select **Presets**.
- 2 Select a preset from the list.
- 3 Select **Remove Current Channel**.

DAB Playback

When you connect a compatible Digital Audio Broadcasting (DAB) module and antenna, such as the FUSION® MS-DAB100A to a compatible stereo, you can tune in to and play DAB stations

To use the DAB source, you must be in a region in which DAB is available, and select the tuner region (*Setting the DAB Tuner Region*, page 34).

Setting the DAB Tuner Region

You must select the region you are in to receive DAB stations properly.

- 1 From the media screen, select **MENU > Installation > Tuner Region**.
- 2 Select the region you are in.

Scanning for DAB Stations



Before you can scan for DAB stations, you must connect a compatible DAB module and antenna (not included) to the stereo. Because DAB signals are broadcast in select countries only, you must also set the tuner region to a location where DAB signals are broadcast.

- 1 Select the **DAB** source.
- 2 Select **Scan** to scan for available DAB stations.

When scanning is complete, the first available station in the first ensemble found begins playing.

NOTE: After the first scan is complete, you can select **Scan** again to re-scan for DAB stations. When the re-scan is complete, the system starts playing the first station in the ensemble you were listening to when you started the re-scan.

Changing DAB Stations

- 1 Select the **DAB** source.
- 2 If necessary, select **Scan** to scan for local DAB stations.
- 3 Select  or  to change the station.

When you reach the end of the current ensemble, the stereo automatically changes to the first available station in the next ensemble.

TIP: You can hold  or  to change the ensemble.

Selecting a DAB Station from a List

- 1 From the DAB media screen, select **Browse > Stations**.
- 2 Select a station from the list.

Selecting a DAB Station from a Category

- 1 From the DAB media screen, select **Browse > Categories**.
- 2 Select a category from the list.
- 3 Select a station from the list.

DAB Presets

You can save your favorite DAB stations as presets for easy access.

You can save up to 15 DAB-station presets.

Saving a DAB Station as a Preset

- 1 From the DAB media screen, select the station to save as a preset.
- 2 Select **Browse > Presets > Save Current**.

Selecting a DAB Preset from a List

- 1 From the DAB media screen, select **Browse > Presets > View Presets**.
- 2 Select a preset from the list.

Removing DAB Presets

- 1 From the DAB media screen, select **Browse > Presets**.
- 2 Select an option:
 - To remove one preset, select **Remove Preset**, and select the preset.
 - To remove all presets, select **Remove All Presets**.

SiriusXM® Satellite Radio

When you have a FUSION-Link™ capable stereo and SiriusXM Connect Tuner installed and connected to the chartplotter, you may have access to SiriusXM satellite radio, depending on your subscription.

Locating a SiriusXM Radio ID

Before you can activate your SiriusXM subscription, you must have the radio ID of your SiriusXM Connect Tuner.

You can locate the SiriusXM Radio ID on the back of the SiriusXM Connect Tuner, on the back of its packaging, or by tuning your chartplotter to channel 0.

- 1 Select **Media > Source > SiriusXM**.
- 2 Tune to channel 0.
The SiriusXM radio ID does not include the letters I, O, S, or F.

Activating a SiriusXM Subscription

- 1 With the SiriusXM source selected, tune to channel 1.
You should be able to hear the preview channel. If not, check the SiriusXM Connect Tuner and antenna installation and connections, and try again.
- 2 Tune to channel 0 to locate the Radio ID.
- 3 Contact SiriusXM listener care by phone at (866) 635-2349 or go to siriusxm.com/activatenow to subscribe in the United States. Contact SiriusXM by phone at (877) 438-9677 or go to siriusxm.ca/activatexm to subscribe in Canada.
- 4 Provide the Radio ID.
The activation process usually takes 10 to 15 minutes, but can take up to an hour. For the SiriusXM Connect Tuner to receive the activation message, it must be turned on and receiving the SiriusXM signal.
- 5 If the service is not activated within the hour, go to <http://care.siriusxm.com/refresh> or contact SiriusXM Listener Care by phone at 1-866-635-2349.

Customizing the Channel Guide

SiriusXM radio channels are grouped in categories. You can select the categories of channels that appear in the channel guide.

Select an option:

- If the media device is a FUSION-Link capable stereo, select **Media > Browse > Channel**.
- If the media device is a GXM™ antenna, select **Media > MENU > Category**.

Saving a SiriusXM Channel to the Presets List

You can save your favorite channels to the presets list.

- 1 Select **Media**.
- 2 Select the channel to save as a preset.
- 3 Select an option:
 - If the media device is a FUSION-Link capable stereo, select **Browse > Presets**.

- If the media device is a GXM antenna, select **MENU > Presets > Add Current Channel**.

Unlocking SiriusXM Parental Controls

- 1 From the media screen, select **Browse > Parental > Unlock**.
- 2 Enter your passcode.
The default passcode is 0000.

Setting Parental Controls on SiriusXM Radio Channels



Before you can set parental controls, the parental controls must be unlocked.

The parental control feature allows you to limit access to any SiriusXM channels, including those with mature content. When enabled, the parental control feature requires you to enter a passcode to tune to the locked channels.

Select **Browse > Parental > Lock/Unlock**.

A list of channels appears. A checkmark indicates a locked channel.

NOTE: When you view the channels after setting parental controls, the display changes:

-  indicates a locked channel.
-  indicates an unlocked channel.

Changing a Parental Passcode on a SiriusXM Radio

Before you can change the passcode, the parental controls must be unlocked.

- 1 From the media screen, select **Browse > Parental > Change PIN**.
- 2 Enter your passcode and select **Done**.
- 3 Enter a new passcode.
- 4 Confirm the new passcode.

Restoring Default Parental Control Settings Values

This process deletes all the settings information you have entered. When you restore the parental control settings to their default values, the passcode value is reset to 0000.

- 1 From the media menu, select **Installation > Factory Defaults**.
- 2 Select **Yes**.

Clearing All Locked Channels on a SiriusXM Radio

Before you can clear all locked channels, the parental controls must be unlocked.

- 1 From the media screen, select **Browse > Parental > Clear All Locked**.
- 2 Enter your passcode.

Setting the Device Name

- 1 From the media screen, select **MENU > Installation > Set Device Name**.
- 2 Enter a device name.
- 3 Select **SELECT** or **Done**.

Updating the Media Player Software

You can update the software on compatible connected stereos and accessories.

- 1 Go to fusionentertainment.com/marine, and download the software update onto a USB flash drive.
Software updates and instructions are available on your device product page.
- 2 Insert the USB flash drive into the USB port of the stereo.
- 3 On the chartplotter media screen, select **MENU > Installation > Update Software**.
- 4 Select the item to update.

Device Configuration

Turning On the Chartplotter Automatically

You can set the chartplotter to turn on automatically when the power is applied. Otherwise, you must turn on the chartplotter by pressing \odot .

Select **Settings > System > Auto Power**.

NOTE: When Auto Power is On, and the chartplotter is turned off using \odot , and power is removed and reapplied within less than two minutes, you may need to press \odot to restart the chartplotter.

System Settings

Select **Settings > System**.

Display: Adjusts the backlight brightness and color scheme.

Beeper: Turns on and off the tone that sounds for alarms and selections.

GPS: Provides information about the GPS satellite settings and fix.

Auto Power: Turns on the device automatically when power is applied (*Turning On the Chartplotter Automatically*, page 36).

Language: Sets the on-screen text language.

Speed Sources: Sets the source of the speed data used to calculate true wind speed or fuel economy. Water speed is the speed reading from a water-speed sensor, and GPS speed is calculated from your GPS position.

System Information: Provides information about the device and the software version.

Simulator: Turns on the simulator and allows you to set the speed and simulated location.

Display Settings

Not all options are available on all models.

Select **Settings > System > Display**.

Backlight: Sets the backlight level.

Color Mode: Sets the device to display day or night colors.

Screenshot Capture: Allows the device to save images of the screen.

Background: Sets the device to display a background image or color.

GPS Settings

Select **Settings > System > GPS**.

Skyview: Shows the relative position of GPS satellites in the sky.

GLONASS: Turns on or off GLONASS data (Russia satellite system). When the system is used in situations with poor sky visibility, GLONASS data can be used in combination with GPS to provide more accurate position information.

WAAS/EGNOS: Turns on or off WAAS data (in North America) or EGNOS data (in Europe), which can provide more-accurate GPS position information. When using WAAS or EGNOS data, the device may take longer to acquire satellites.

Galileo: Turns on or off Galileo data (European Union satellite system). When the system is used in situations with poor sky visibility, Galileo data can be used in combination with GPS to provide more accurate position information.

Speed Filter: Averages the speed of your vessel over a short period of time for smoother speed values.

Source: Allows you to select the preferred source for GPS data.

Viewing the Event Log

The event log shows a list of system events.

Select **Settings > System > System Information > Event Log**.

Viewing System Software Information

You can view the software version, the basemap version, all supplemental map information (if applicable), the software version for an optional Garmin radar (if applicable), and the unit ID number. You may need this information to update the system software or to purchase additional map data information.

You can view the software version, the basemap version, all supplemental map information (if applicable), and the unit ID number. You may need this information to update the system software or to purchase additional map data information.

Select **Settings > System > System Information > Software Information**.

Viewing E-label Regulatory and Compliance Information

The label for this device is provided electronically. The e-label may provide regulatory information, such as identification numbers provided by the FCC or regional compliance markings, as well as applicable product and licensing information. Not available on all models.

- 1 Select **Settings**.
- 2 Select **System**.
- 3 Select **Regulatory Information**.

My Vessel Settings

NOTE: Some settings and options require additional charts or hardware.

Select **Settings > My Vessel**.

Keel Offset: Offsets the surface reading for the depth of a keel, making it possible to measure depth from the bottom of the keel instead of from the transducer location (*Setting the Keel Offset*, page 18).

Calibrate Water Speed: Calibrates the speed-sensing transducer or sensor (*Calibrating a Water Speed Device*, page 37).

Vessel Type: Enables some chartplotter features based on the boat type.

Fuel Capacity: Sets the combined fuel capacity of all the fuel tanks on your vessel (*Setting the Fuel Capacity of the Vessel*, page 32).

Fill Up All Tanks: Sets the tank levels to full (*Synchronizing the Fuel Data with the Actual Vessel Fuel*, page 32).

Add Fuel to Boat: Allows you to enter the quantity of fuel you added to your tank, when you did not entirely fill up the tank (*Synchronizing the Fuel Data with the Actual Vessel Fuel*, page 32).

Set Total Fuel Onboard: Sets the combined amount of fuel in all the fuel tanks on your vessel (*Synchronizing the Fuel Data with the Actual Vessel Fuel*, page 32).

Set Gauge Limits: Sets the upper and lower limits of various gauges (*Customizing Engine Gauge and Fuel Gauge Limits*, page 37).

Hull ID: Allows you to enter the Hull Identification Number (HIN). The HIN might be permanently affixed to the upper starboard side of the transom or outboard side.

Setting the Keel Offset

You can enter a keel offset to compensate the water depth reading for the transducer installation location. This allows you to view the depth of the water below the keel or the true depth of the water, depending on your needs.

If you want to know the water depth below the keel or the lowest point of your boat and the transducer is installed at the water

line or anywhere above the end of the keel, measure the distance from the transducer location to the keel of the boat. If you want to know the true water depth and the transducer is installed below the water line, measure the distance from the bottom of the transducer up to the water line.

NOTE: This option is only available when you have valid depth data.

1 Measure the distance:

- If the transducer is installed at the water line ① or anywhere above the end of the keel, measure the distance from the transducer location to the keel of the boat. Enter this value as a positive number.
- If the transducer is installed at the bottom of the keel ② and you want to know the true depth of the water, measure the distance from the transducer to the water line. Enter this value in as a negative number.

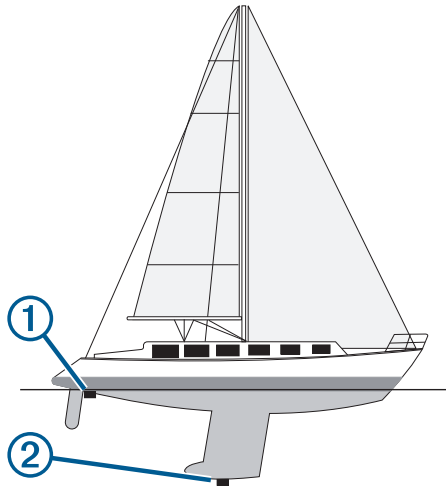

2 Select **Settings > My Vessel > Keel Offset**.

3 Select **+** if the transducer is installed at the water line, or select **-** if the transducer is installed at the bottom of the keel.

Setting the Water Temperature Offset

Before you can set the water temperature offset, you must have a NMEA 0183 water-temperature sensor or a temperature-capable transducer to measure water temperature.

The temperature offset compensates for the temperature reading from a temperature sensor.

- 1** Measure the water temperature using the temperature sensor or temperature-capable transducer that is connected to the chartplotter.
- 2** Measure the water temperature using a different temperature sensor or a thermometer that is known to be accurate.
- 3** Subtract the water temperature measured in step 1 from the water temperature measured in step 2.

This is the temperature offset. Enter this value in step 5 as a positive number if the sensor connected to the chartplotter measures the water temperature as being colder than it actually is. Enter this value in step 5 as a negative number if the sensor connected to the chartplotter measures the water temperature as being warmer than it actually is.

- 4** Select **Settings > My Vessel > Temp. Offset**.
- 5** Enter the temperature offset calculated in step 3.

Calibrating a Water Speed Device

If you have a speed-sensing transducer connected to the chartplotter, you can calibrate that speed-sensing device to improve the accuracy of water-speed data displayed by the chartplotter.

- 1** Select **Settings > My Vessel > Calibrate Water Speed**.
- 2** Follow the on-screen instructions.
If the boat is not moving fast enough or the speed sensor is not registering a speed, a message appears.
- 3** Select **OK**, and safely increase the boat speed.
- 4** If the message appears again, stop the boat, and ensure the speed-sensor wheel is not stuck.
- 5** If the wheel turns freely, check the cable connections.
- 6** If you continue to get the message, contact Garmin product support.

Setting the Fuel Capacity of the Vessel

- 1** Select **Settings > My Vessel > Fuel Capacity**.
- 2** Enter the combined total capacity of the fuel tanks.

Synchronizing the Fuel Data with the Actual Vessel Fuel

You can synchronize the fuel levels in the chartplotter with the actual fuel in the vessel when you add fuel to your vessel.

- 1** Select **Gauges > Engine > MENU**.
- 2** Select an option:
 - After you have filled up all the fuel tanks on the vessel, select **Fill Up All Tanks**. The fuel level is reset to maximum capacity.
 - After you have added less than a full tank of fuel, select **Add Fuel to Boat**, and enter the amount added.
 - To specify the total fuel in the vessel tanks, select **Set Total Fuel Onboard**, and enter the total amount of fuel in the tanks.

Customizing Engine Gauge and Fuel Gauge Limits

You can configure the upper and lower limits and the range of desired standard operation of a gauge.

NOTE: Not all options are available for all gauges.

- 1** From an applicable gauges screen, select **MENU > Gauge Setup > Set Gauge Limits**.
- 2** Select a gauge to customize.
- 3** Select **Gauge Limits > Custom**.
- 4** Select an option:
 - To set the minimum value of the standard operating range, select **Rated Min..**
 - To set the maximum value of the standard operating range, select **Rated Max..**
 - To set the lower limit of the gauge lower than the rated minimum, select **Scale Min..**
 - To set the upper limit of the gauge higher than the rated maximum, select **Scale Max..**
- 5** Select the limit value.
- 6** Repeat steps 4 and 5 to set additional gauge limits.

Communications Settings

NOTE: Some settings and options require additional charts or hardware.

Select **Settings > Communications**.

Serial Port: Sets the input/output format for the serial port to use when connecting the chartplotter to external NMEA devices, computers, or other Garmin devices.

NMEA 0183 Setup: Sets the NMEA 0183 sentences the chartplotter transmits, how many digits to the right of the decimal point are transmitted in a NMEA output, and how waypoints are identified (*NMEA 0183 Settings, page 38*).

NMEA 2000 Setup: Allows you to view and label the devices on the NMEA 2000 network (*NMEA 2000 Settings, page 38*).

Marine Network: Allows you to view the devices with which you are sharing maps, sonar, or radar. Not available on all chartplotter models.

NOTE: You can only view networked data on a model that supports that data. For example, you cannot view networked radar on model that does not support radar.

Wi-Fi Network: Allows you set up the Wi-Fi network (*Setting Up the Wi-Fi Wireless Network*, page 38).

NMEA 0183

The chartplotters support the NMEA 0183 standard, which is used to connect various NMEA 0183 devices, such as VHF radios, NMEA instruments, autopilots, wind sensors, and heading sensors.

To connect the chartplotter to optional NMEA 0183 devices, see the chartplotter installation instructions.

The approved NMEA 0183 sentences for the chartplotter are GPAPB, GPBOD, GPBWC, GPGGA, GPGLL, GPGSA, GPGSV, GPRMB, GPRMC, GPRTE, GPVTG, GPWPL, GPXTE, and Garmin proprietary sentences PGRME, PGRMM, and PGRMZ.

This chartplotter also includes support for the WPL sentence, DSC, and sonar NMEA 0183 input with support for the DPT (depth) or DBT, MTW (water temperature), and VHW (water temperature, speed, and heading) sentences.

NMEA 0183 Settings

Select **Settings > Communications > NMEA 0183 Setup**.

Sounder: Enables NMEA 0183 output sentences for the sounder (if applicable).

Route: Enables NMEA 0183 output sentences for routes.

System: Enables NMEA 0183 output sentences for system information.

Garmin: Enables NMEA 0183 output sentences for Garmin proprietary sentences.

Posn Precision: Adjusts the number of digits to the right of the decimal point for transmission of NMEA output.

Waypoint IDs: Sets the device to transmit waypoint names or numbers via NMEA 0183 while navigating. Using numbers may resolve compatibility issues with older NMEA 0183 autopilots.

Diagnostics: Displays NMEA 0183 diagnostic information.

Defaults: Restores the NMEA 0183 settings to the original factory defaults.

NMEA 2000 Settings

Select **Settings > Communications > NMEA 2000 Setup**.

Device List: Displays the devices connected to the network.

Label Devices: Changes the labels for available connected devices.

Naming Devices and Sensors on the Network

You can name devices and sensors connected to the Garmin Marine Network and the NMEA 2000 network.

- 1 Select **Settings > Communications**.
- 2 Select **Marine Network** or **NMEA 2000 Setup > Device List**.
- 3 Select a device from the list on the left.
- 4 Select **Change Name**.
- 5 Enter the name, and select **Done**.

Wi-Fi Network

Setting Up the Wi-Fi Wireless Network

The chartplotters can create a Wi-Fi network to which you can connect wireless devices. The first time you access the wireless network settings, you are prompted to set up the network.

- 1 Select **Settings > Communications > Wireless Devices > Wi-Fi Network > Wi-Fi > On > OK**.

- 2 If necessary, enter a name for this wireless network.

- 3 Enter a password.

You will need this password to access the wireless network from a wireless device. The password is case-sensitive.

Connecting a Wireless Device to the Chartplotter

Before you can connect a wireless device to the chartplotter wireless network, you must configure the chartplotter wireless network (*Setting Up the Wi-Fi Wireless Network*, page 38).

You can connect multiple wireless devices to the chartplotter to share data.

- 1 From the wireless device, turn on the Wi-Fi technology and search for wireless networks.
- 2 Select the name of your chartplotter wireless network (*Setting Up the Wi-Fi Wireless Network*, page 38).
- 3 Enter the chartplotter password.

Changing the Wireless Channel

You can change the wireless channel if you have trouble finding or connecting to a device, or if you experience interference.

- 1 Select **Settings > Communications > Wi-Fi Network > Advanced > Channel**.
- 2 Enter a new channel.

You do not need to change the wireless channel of devices connected to this network.

Setting Alarms

Navigation Alarms

Select **Settings > Alarms > Navigation**.

Arrival: Sets an alarm to sound when you are within a specified distance or time from a turn or a destination.

Anchor Drag: Sets an alarm to sound when you exceed a specified drift distance while anchored.

Off Course: Sets an alarm to sound when you are off course by a specified distance.

System Alarms

Alarm Clock: Sets an alarm clock.

Device Voltage: Sets an alarm to sound when the battery reaches a specified low voltage.

GPS Accuracy: Sets an alarm to sound when the GPS location accuracy falls outside the user-defined value.

Setting the Fuel Alarm

Before you can set a fuel level alarm, a compatible fuel flow sensor must be connected to the chartplotter.

You can set an alarm to sound when the total amount of remaining onboard fuel reaches the level you specify.

- 1 Select **Settings > Alarms > Fuel > Set Total Fuel Onboard > On**.
- 2 Enter the remaining amount of fuel that triggers the alarm, and select **Done**.

Units Settings

Select **Settings > Units**.

System Units: Sets the unit format for the device.

Variance: Sets the magnetic declination, the angle between magnetic north and true north, for your present location.

North Reference: Sets the direction references used in calculating heading information. True sets geographic north as the north reference. Grid sets grid north as the north reference (000°). Magnetic sets the magnetic north as the north reference.

Position Format: Sets the position format in which a given location reading appears. Do not change this setting unless

you are using a map or chart that specifies a different position format.

Map Datum: Sets the coordinate system on which the map is structured. Do not change this setting unless you are using a map or chart that specifies a different map datum.

Pressure Reference Time: Sets the reference time used to calculate the barometer trend. The trend is indicated in the barometer field.

Time Format: Sets a 12-hour, 24-hour, or UTC time format.

Time Zone: Sets the time zone, or allows automatic selection based on GPS location.

Navigation Settings

NOTE: Some settings and options require additional charts or hardware.

Select **Settings > Navigation**.

Route Labels: Sets the type of labels shown with route turns on the map.

Auto Guidance: Sets the parameters the chartplotter uses when calculating an Auto Guidance path, when you are using some premium maps.

Turn Transition Activ.: Sets the turn transition to be calculated based on time or distance.

Turn Transition Time: Sets how many minutes before the turn that you transition to it as the next leg, when Time is selected for the Turn Transition Activ. setting. You can raise this value to help improve the accuracy of the autopilot when navigating a route or an Auto Guidance path with many frequent turns or at higher speeds. For straighter routes or slower speeds, lowering this value can improve autopilot accuracy.

Turn Transition Dist.: Sets how far before the turn that you transition to it as the next leg, when Distance is selected for the Turn Transition Activ. setting. You can raise this value to help improve the accuracy of the autopilot when navigating a route or an Auto Guidance path with many frequent turns or at higher speeds. For straighter routes or slower speeds, lowering this value can improve autopilot accuracy.

Route Start: Selects a starting point for route navigation.

Other Vessel Settings

When your compatible chartplotter is connected to an AIS device or VHF radio, you can set up how other vessels are displayed on the chartplotter.

Select **Settings > Other Vessels**.

AIS: Enables and disables AIS signal reception.

DSC: Enables and disables digital selective calling (DSC).

AIS Alarm: Sets the collision alarm (*Setting the Safe-Zone Collision Alarm, page 8* and *Enabling AIS Transmission Test Alerts, page 8*).

Restoring the Original Chartplotter Factory Settings

NOTE: This affects all devices on the network.

1 Select **Settings > System > System Information > Reset**.

2 Select an option:

- To reset the device settings to the factory default values, select **Reset Default Settings**. This restores the default configuration settings, but does not remove saved user data, maps, or software updates.
- To clear saved data, such as waypoints and routes, select **Delete User Data**. This does not affect maps or software updates.
- To clear saved data and reset device settings to the factory default values, disconnect the chartplotter from the

Garmin Marine Network, and select **Delete Data and Reset Settings**. This does not affect maps or software updates.

Sharing and Managing User Data

You can share user data between compatible devices. User data includes waypoints, saved tracks, routes, and boundaries.

- You can share and manage user data using a memory card. You must have a memory card installed in the device. This device supports up to a 32 GB memory card, formatted to FAT32.
- You can share data if two compatible devices are connected using the blue and brown wires on the power cable or using the User Data Sharing Cable (*Connecting to a Garmin Device to Share User Data, page 39*).

Connecting to a Garmin Device to Share User Data

NOTE: This feature is not available on ECHOMAP Plus 70/90 devices. The blue and brown wires on those devices can connect to NMEA 0183 devices only.

You can connect the ECHOMAP Plus 40/60 device to a compatible Garmin device to share user data, such as waypoints. If the devices are mounted near each other, you can connect the blue and brown wires. If the devices are mounted too far apart for the wires to reach, you can connect the devices using a User Data Sharing Cable (010-12234-06).

1 Make sure both devices are connected to the same ground.

2 Complete an action:

- If the devices are mounted near each other, connect the blue wire from the first device to the brown wire of the second, and connect the brown wire from the first device to the blue wire of the second.
- If the devices are not mounted near each other, obtain a User Data Sharing Cable (010-12234-06), and connect the devices following the instructions included with the cable (*User Data Sharing Cable Wiring Diagram, page 39*).

3 On both devices, select **Nav Info > Manage Data > User Data Sharing**.

User data is shared between the connected devices. If you select Clear User Data, data is removed from both connected devices.

User Data Sharing Cable Wiring Diagram

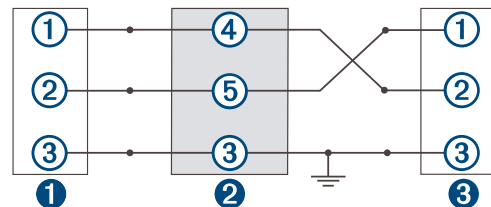

①	First device
②	User data cable
③	Second device

Item	Wire Function	Wire Color
①	Data	Blue
②	Data	Brown
③	Ground	Black

Item	Wire Function	Wire Color
④	Data	Green
⑤	Data	White

Selecting a File Type for Third-Party Waypoints and Routes

You can import and export waypoints and routes from third-party devices.

- 1 Insert a memory card into the card slot.
- 2 Select **Nav Info > Manage Data > Data Transfer > File Type**.
- 3 Select **GPX**.

To transfer data with Garmin devices again, select the ADM file type.

Copying User Data from a Memory Card

You can transfer user data from a memory card to transfer from other devices. User data includes waypoints, routes, Auto Guidance paths, tracks, and boundaries.

NOTE: Only boundary files with an .adm extension are supported.

- 1 Insert a memory card into a card slot.
- 2 Select **Nav Info > Manage Data > Data Transfer**.
- 3 If necessary, select the memory card to copy data to.
- 4 Select an option:
 - To transfer data from the memory card to the chartplotter and combine it with existing user data, select **Merge from Card**.
 - To transfer data from the memory card to the chartplotter and overwrite existing user data, select **Replace from Card**.
- 5 Select the file name.

Copying User Data to a Memory Card

You can save user data to a memory card to transfer to other devices. User data includes waypoints, routes, Auto Guidance paths, tracks, and boundaries.

- 1 Insert a memory card into the card slot.
- 2 Select **Nav Info > Manage Data > Data Transfer > Save to Card**.
- 3 If necessary, select the memory card to copy the data to.
- 4 Select an option:
 - To create a new file, select **Add New File**, and enter a name.
 - To add the information to an existing file, select the file from the list, and select **Save to Card**.

Backing Up Data to a Computer

- 1 Insert a memory card into the card slot.
- 2 Select **Nav Info > Manage Data > Data Transfer > Save to Card**.
- 3 Select a file name from the list, or select **Add New File**.
- 4 Select **Save to Card**.
- 5 Remove the memory card, and insert it into a card reader attached to a computer.
- 6 Open the Garmin\UserData folder on the memory card.
- 7 Copy the backup file on the card and paste it to any location on the computer.

Restoring Backup Data to a Chartplotter

- 1 Insert a memory card into a card reader that is attached to the computer.
- 2 Copy a backup file from the computer to the memory card, into a folder named Garmin\UserData.
- 3 Insert a memory card into the card slot.
- 4 Select **Nav Info > Manage Data > Data Transfer > Replace from Card**.

Saving System Information to a Memory Card

You can save system information to a memory card as a troubleshooting tool. A product support representative may ask you to use this information to retrieve data about the network.

- 1 Insert a memory card into the card slot.
- 2 Select **Settings > System > System Information > Garmin Devices > Save to Card**.
- 3 If necessary, select the memory card to save system information to.
- 4 Remove the memory card.

Clearing Saved Data

You can remove saved user data from the device memory. User data includes waypoints, routes, Auto Guidance paths, tracks, and boundaries.

- 1 Select **Nav Info > Manage Data > Clear User Data**.
- 2 Select an option.

NOTICE

If you select All, all the data you have saved will be removed, except Garmin Quickdraw contours data.

If you are connected to another device and User Data Sharing is enabled, data is removed from all connected devices.

Appendix

Registering Your Device Using the Garmin Express App

NOTE: You should use the ActiveCaptain app and a mobile device to register the device (*Getting Started with the ActiveCaptain App*, page 3).

Help us better support you by completing our online registration today. Keep the original sales receipt, or a photocopy, in a safe place.

- 1 Install the Garmin Express app on your computer (*Installing the Garmin Express App on a Computer*, page 41).
- 2 Insert a memory card into the card slot (*Inserting Memory Cards*, page 2).
- 3 Wait a few moments.

The chartplotter opens the card management page and creates a file named GarminDevice.xml in the Garmin folder on the memory card.
- 4 Remove the memory card from your device.
- 5 Open the Garmin Express app on your computer.
- 6 Insert the memory card into your computer.
- 7 If necessary, select **Get Started**.
- 8 If necessary, while the application searches, select **Sign In** next to **Have marine charts or devices?** near the bottom of the screen.
- 9 Create or sign in to your Garmin account.
- 10 Follow the on-screen instructions to set up your vessel.

11 Select **+Add**.

The Garmin Express application searches the memory card for the device information.

12 Select **Add Device** to register the device.

When registration is complete, the Garmin Express application searches for additional charts and chart updates for your device.

When you add devices to the chartplotter network, repeat these steps to register the new devices using the Garmin Express app.

Software Update

NOTE: If your device has Wi-Fi technology, you should use the ActiveCaptain app to update the device software (*Updating Software with the ActiveCaptain App, page 4*).

You may need to update the device software when you install the device or add an accessory to the device.

This device supports up to a 32 GB memory card, formatted to FAT32.

Before you update the software, you can check to the software version installed on your device (*Viewing System Software Information, page 36*). Then, you can go to garmin.com/support/software/marine.html, select See All Devices in this Bundle, and compare the installed software version to the software version listed for your product.

If the software on your device is older than the one listed on the website, follow the steps to load the software on a memory card (*Loading the New Software on a Memory Card Using Garmin Express, page 41*), and then update the device software (*Updating the Device Software Using a Memory Card, page 41*).

Installing the Garmin Express App on a Computer

You can install the Garmin Express app on a Windows® or Mac® computer.

- 1 Go to garmin.com/express.
- 2 Select **Download for Windows** or **Download for Mac**.
- 3 Follow the on-screen instructions.

Loading the New Software on a Memory Card Using Garmin Express

You can copy the software update to a memory card using a computer with the Garmin Express app.

This device supports up to a 32 GB microSD memory card, formatted to FAT32 with speed class 4 or higher. Use of an 8 GB or higher memory card with speed class 10 is recommended.

Downloading the software update may take from a few minutes up to a few hours.

You should use a blank memory card for software updates. The update process erases the content on the card and reformats the card.

- 1 Insert a memory card into the card slot on the computer.
- 2 Install the Garmin Express app (*Installing the Garmin Express App on a Computer, page 41*).
- 3 Select your vessel and device.
- 4 Select **Software Updates > Continue**.
- 5 Read and agree to the terms.
- 6 Select the drive for the memory card.
- 7 Review the reformat warning, and select **Continue**.
- 8 Wait while the software update is copied to the memory card.

NOTE: Copying the update file onto the card may take from a few minutes up to a few hours.

- 9 Close the Garmin Express app.
- 10 Eject the memory card from the computer.

After loading the update onto the memory card, install the software on the chartplotter (*Updating the Device Software Using a Memory Card, page 41*).

Updating the Device Software Using a Memory Card

To update the software using a memory card, you must obtain a software-update memory card or load the latest software onto a memory card using the Garmin Express app (*Loading the New Software on a Memory Card Using Garmin Express, page 41*).

- 1 Turn on the chartplotter.
- 2 After the home screen appears, insert the memory card into the card slot.
NOTE: In order for the software update instructions to appear, the device must be fully booted before the card is inserted.
- 3 Select **Update Software > Yes**.
- 4 Wait several minutes while the software update process completes.
- 5 When prompted, leave the memory card in place, and restart the chartplotter.
- 6 Remove the memory card.

NOTE: If the memory card is removed before the device restarts fully, the software update is not complete.

Cleaning the Screen

NOTICE

Cleaners containing ammonia will harm the anti-reflective coating.

The device is coated with a special anti-reflective coating which is very sensitive to waxes and abrasive cleaners.

- 1 Apply an eyeglass lens cleaner specified as safe for anti-reflective coatings to the cloth.
- 2 Gently wipe the screen with a soft, clean, lint-free cloth.

Screenshots

You can capture a screenshot of any screen shown on your chartplotter as a .png file. You can transfer the screenshot to your computer. You can also view the screenshot in the image viewer.

Capturing Screenshots

- 1 Insert a memory card into the card slot.
- 2 Select **Settings > System > Display > Screenshot Capture > On**.
- 3 Go to a screen you want to capture.
- 4 Hold **HOME** for at least six seconds.

Copying Screenshots to a Computer

- 1 Remove the memory card from the chartplotter, and insert it into a card reader that is attached to a computer.
- 2 From Windows Explorer, open the Garmin\scrn folder on the memory card.
- 3 Copy a .bmp file from the card and paste it to any location on the computer.

Troubleshooting

My device will not acquire GPS signals

If the device is not acquiring satellite signals, there could be a few causes. If the device has moved a large distance since the last time it has acquired satellites or has been turned off for longer than a few weeks or months, the device may not be able to acquire the satellites correctly.

- Ensure the device is using the latest software. If not, update the device software (*Updating the Device Software Using a Memory Card*, page 41).
- Make sure the device has a clear view of the sky so the antenna can receive the GPS signal. If it is mounted inside of a cabin, it should be close to a window so it can receive the GPS signal.

My device will not turn on or keeps turning off

Devices erratically turning off or not turning on could indicate an issue with the power supplied to the device. Check these items to attempt to troubleshoot the cause of the power issue.

- Make sure the power source is generating power.
You can check this several ways. For example, you can check whether other devices powered by the source are functioning.
- Check the fuse in the power cable.
The fuse should be located in a holder that is part of the red wire of the power cable. Check that the proper size fuse is installed. Refer to the label on the cable or the installation instructions for the exact fuse size needed. Check the fuse to make sure there is still a connection inside of the fuse. You can test the fuse using a multimeter. If the fuse is good, the multimeter reads 0 ohm.
- Check to make sure the device is receiving at least 12 V.
To check the voltage, measure the female power and ground sockets of the power cable for DC voltage. If the voltage is less than 12 V, the device will not turn on.
- If the device is receiving enough power but does not turn on, contact Garmin product support.

Changing the Fuse in the Power Cable

- 1 Open the fuse housing ①.

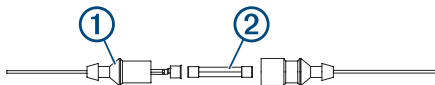

- 2 Twist and pull the fuse to remove it ②.
- 3 Insert a new 3 A fast-blow fuse.
- 4 Close the fuse housing.

My sonar does not work

- Push the transducer cable all the way into the back of the device.
Even if the cable seems to be connected, you should push firmly so that it is fully seated.
- Press , and ensure sonar is enabled.
- Select the correct transducer type (*Selecting the Transducer Type*, page 22).

My device is not creating waypoints in the correct location

You can manually enter a waypoint location to transfer and share data from one device to the next. If you have manually entered a waypoint using coordinates, and the location of the point does not appear where the point should be, the map datum and position format of the device may not match the map datum and position format originally used to mark the waypoint.

Position format is the way in which the GPS receiver's position appears on the screen. This is commonly displayed as latitude/longitude in degrees and minutes, with options for degrees, minutes and second, degrees only, or one of several grid formats.

Map datum is a math model which depicts a part of the surface of the earth. Latitude and longitude lines on a paper map are referenced to a specific map datum.

- 1 Find out which map datum and position format was used when the original waypoint was created.
If the original waypoint was taken from a map, there should be a legend on the map that lists the map datum and position format used to create that map. Most often this is found near the map key.
- 2 Select **Settings > Units**.
- 3 Select the correct map datum and position format settings.
- 4 Create the waypoint again.

My device does not display the correct time

Time is set by GPS position and time zone setting.

- 1 Select **Settings > Units > Time Zone**.
- 2 Ensure the device has a GPS fix.

Specifications

All Models

Specification	Measurement
Material	Polycarbonate plastic
Water rating	IEC 60529 IPX7 The device withstands incidental exposure to water of up to 1 m for up to 30 min. For more information, go to www.garmin.com/waterrating .
Temperature range	From -15° to 55°C (from 5° to 131°F)
Input voltage	From 9 to 18 Vdc
Fuse	3 A, 125 V fast-acting
Compass-safe distance	65 cm (25.6 in.)
NMEA 2000 LEN @ 9 Vdc	1
NMEA 2000 draw	75 mA max.
Memory card	1 microSD card slot; 32 GB max. card size
Max. waypoints	5,000
Max. routes	100
Max. active track points	50,000 points, 50 saved tracks

NOTE: NMEA 2000 is not available in all models.

4-Inch Models

Specification	Measurement
Dimensions on mount (W x H x D)	10.2 x 16.5 x 0.4 cm (4.0 x 6.5 x 3.1 in.)
Display size (W x H)	5.4 x 9.5 cm (2.1 x 3.7 in.), 10.5 cm (4.3 in.) diagonal
Display resolution	WQVGA, 480 x 272 pixels
Weight	0.7 kg (1.6 lbs.)
Compass-safe distance	25 cm (9.8 in.)
Input voltage	From 9 to 18 Vdc
Max. power draw	5 W
Typical current draw (RMS)	0.5 A
Max. current draw (RMS)	2 A

6-Inch Models

Specification	Measurement
Dimensions on cradle and bail mount with swivel base (W x H x D)	21.8 x 13.0 x 6.2 cm (8.6 x 5.1 x 2.6 in.)
Display size (W x H)	13.7 x 7.7 cm (5.4 x 3.1 in.) 15.2 cm (6.2 in.) diagonal
Display resolution	WVGA, 400 x 800 pixels
Weight	0.75 kg (1.6 lb.)
Compass-safe distance	65 cm (25.6 in.)
Clearance to nearest obstruction	8.0 cm (3.14 in.)
Max. power draw	12 W

Specification	Measurement
Typical current draw at 12 Vdc (RMS)	0.7 A
Max. current draw at 12 Vdc (RMS)	1.25 A
Wireless frequency	2.4 GHz @ 17.2 dBm nominal

7-Inch Models

Specification	Measurement
Dimensions on cradle and bail mount (W x H x D)	25.9 x 15.4 x 6.3 cm (10.2 x 6 x 2.5 in.)
Display size (W x H)	15.5 x 8.7 cm (6.1 x 3.4 in.) 17.8 cm (7 in.) diagonal
Display resolution	WVGA, 400 x 800 pixels
Weight	0.77 kg (1.7 lb.)
Clearance to nearest obstruction	11.5 cm (4.5 in.)
Max. power draw	15 W, 9 W with a GT-52 transducer
Typical current draw at 12 Vdc (RMS)	0.8 A
Max. current draw at 12 Vdc (RMS)	1.25 A
Wireless frequency	2.4 GHz @ 18.5 dBm nominal

9-Inch Models

Specification	Measurement
Dimensions on cradle and bail mount (W x H x D)	30.3 x 17.8 x 6.5 cm (11.9 x 7 x 2.6 in.)
Display size (W x H)	19.9 x 11.3 cm (7.8 x 4.8 in.) 22.9 cm (9 in.) diagonal
Display resolution	WVGA, 800 x 400 pixels
Weight	1 kg (2.3 lb.)
Compass-safe distance	65 cm (25.6 in.)
Clearance to nearest obstruction	11.5 cm (4.5 in.)
Max. power draw	18 W
Typical current draw at 12 Vdc (RMS)	1 A
Max. current draw at 12 Vdc (RMS)	1.5 A
Wireless frequency	2.4 GHz @ 18.5 dBm nominal

Sonar Models Specifications

Specification	Measurement
Sonar frequencies ¹	Traditional: 50, 77, 83, or 200 kHz CHIRP Garmin ClearVü: 260, 455, or 800 kHz CHIRP SideVü: 260, 455, or 800 kHz
Sonar transmit power (RMS) ²	500 W
Sonar depth ³	701 m (2,300 ft.) at 77 kHz

NMEA 0183 Information

Transmit

Sentence	Description
GPAPB	APB: Heading or track controller (autopilot) sentence "B"
GPBOD	BOD: Bearing (origin to destination)
GPBWC	BWC: Bearing and distance to waypoint
GPGGA	GGA: Global positioning system fix data
GPGLL	GLL: Geographic position (latitude and longitude)
GPGSA	GSA: GNSS DOP and active satellites

¹ Dependent upon the transducer.

² Dependent upon the transducer rating and depth.

³ Dependent upon the transducer, water salinity, bottom type, and other water conditions.

Sentence	Description
GPGSV	GSV: GNSS satellites in view
GPRMB	RMB: Recommended minimum navigation information
GPRMC	RMC: Recommended minimum specific GNSS data
GP RTE	RTE: Routes
GPVTG	VTG: Course over ground and ground speed
GPWPL	WPL: Waypoint location
GPXTE	XTE: Cross track error
PGRME	E: Estimated error
PGRMM	M: Map datum
PGRMZ	Z: Altitude
SDDBT	DBT: Depth below transducer
SDDPT	DPT: Depth
SDMTW	MTW: Water temperature
SDVHW	VHW: Water speed and heading

Receive

Sentence	Description
DPT	Depth
DBT	Depth below transducer
MTW	Water temperature
VHW	Water speed and heading
WPL	Waypoint location
DSC	Digital selective calling information
DSE	Expanded digital selective calling
HDG	Heading, deviation, and variation
HDM	Heading, magnetic
MWD	Wind direction and speed
MDA	Meteorological composite
MWV	Wind speed and angle
VDM	AIS VHF data-link message

You can purchase complete information about National Marine Electronics Association (NMEA) format and sentences from: NMEA, Seven Riggs Avenue, Severna Park, MD 21146 USA (www.nmea.org)

NMEA 2000 PGN Information

Transmit and Receive

PGN	Description
059392	ISO acknowledgment
059904	ISO request
060928	ISO address claim
126208	NMEA: Command, request, and acknowledge group function
126996	Product information
127250	Vessel heading
128259	Speed: Water referenced
128267	Water depth
129539	GNSS DOPs
129799	Radio frequency, mode, and power
130306	Wind data
130312	Temperature

Transmit

PGN	Description
126464	Transmit and receive PGN list group function
127258	Magnetic Variance
129025	Position: Rapid update
129026	COG and SOG: Rapid update
129029	GNSS position data

PGN	Description
129283	Cross track error
129284	Navigation data
129285	Navigation route and waypoint info
129540	GNSS satellites in view

Receive

PGN	Description
127245	Rudder
127250	Vessel heading
127488	Engine parameters: Rapid update
127489	Engine parameters: Dynamic
127493	Transmission parameters: Dynamic
127498	Engine parameters: Static
127505	Fluid level
129038	AIS class A position report
129039	AIS class B position report
129040	AIS class B extended position report
129794	AIS class A static and voyage related data
129798	AIS SAR aircraft position report
128000	Nautical leeway angle
129802	AIS safety-related broadcast message
129808	DSC call information
130310	Environmental parameters
130311	Environmental parameters (obsolete)
130313	Humidity
130314	Actual pressure
130576	Small craft status

This data applies only to NMEA 2000-compatible products.

Index

A

- ActiveCaptain **3**
 - quickdraw **11**
 - smart notifications **4**
 - updating charts **4**
 - updating software **4**
- aerial photos **7**
- AIS **7, 9, 10**
 - alarm **8**
 - ATONs **8**
 - distress signal device **8**
 - SART **8**
 - targeting **7, 8**
 - threats **8**
 - turning on **39**
- alarms **17, 38**
 - anchor drag **38**
 - arrival **38**
 - collision **8**
 - deep water **25**
 - engine **32**
 - fuel **32, 38**
 - gauges **32**
 - navigation **38**
 - off course **38**
 - shallow water **25**
 - sonar **25**
 - water temperature **25**
- AM **34**
- anchor drag alarm **38**
- animated currents, tides **6**
- antenna, GPS **2**
- arrival alarm **38**
- Auto Guidance **12, 15, 39**
 - paths **15**
 - shoreline distance **16**
- autopilot **27, 28**
 - circles pattern **28**
 - engaging **28**
 - pattern steering **28**
 - reducing rudder activity **28**
 - steering increment **28**
 - steering patterns **28**
 - u-turn pattern **28**
 - Williamson turn pattern **28**
 - zigzag pattern **28**

B

- background **3**
- backlight **3**
- boundaries
 - copying **40**
 - showing **10**
- boundary line **17**
- boundary lines **17**

C

- celestial information **33**
- chart
 - layers **9, 10**
 - settings **9**
- charts **4, 7, 10, 11**
 - appearance **9, 10**
 - details **5**
 - fishing **5**
 - layers **9, 10**
 - measuring distance **5**
 - navigation **5, 7**
 - panning **5**
 - quickdraw **10, 11**
 - settings **9**
 - symbols **5**
 - updating **4**
- circuits **32**
- clock **38**
 - alarm **38**
- collision alarm **8**

- color mode **3**
- combinations **2, 3**
- compass **31**
 - rose **9**
- courses **12**
- current stations **33**
 - indicators **7**

D

- DAB **34, 35**
- data
 - backup **40**
 - clearing **40**
 - copying **40**
 - management **39**
- deleting
 - all user data **18**
 - user data **40**
- depth shading **10**
- destinations
 - navigation chart **13**
 - selecting **13**
- device
 - cleaning **41**
 - keys **1, 2, 5**
 - registration **40**
- digital selective calling **30, 31**
 - channels **31**
 - contacts **30**
 - individual routine call **31**
 - turning on **30, 39**
- digital switching **32, 33**
- display settings **36**
- distress call **30**
- distress signal device **8**
- DSC. See digital selective calling

E

- EGNOS **36**
- engine gauges **31, 32, 37**
 - configuring **32**
 - status alarms **32**
- EPIRB **8**
- event log **36**

F

- factory settings **39**
 - sonar **25**
- Fish Eye 3D
 - sonar cone **10**
 - suspended targets **10**
 - tracks **10**
- fishing chart **5**
 - panning **5**
- FM **34**
- Force trolling motor **29, 30**
- fuel capacity **32, 36, 37**
- fuel gauges **31, 32, 37**
 - status alarm **32, 38**
 - synchronizing with actual fuel **32, 37**

G

- Garmin ClearVü **20**
- Garmin Express **40, 41**
- Garmin Marine Network **37, 38**
- Garmin product support. See product support
- gauges
 - engine **31, 32**
 - fuel **31, 32, 37**
 - limits **37**
 - status alarms **32**
 - trip **31**
 - wind **32**
- GLONASS **36**
- Go To **12, 13**
- GPS **41**
 - EGNOS **36**
 - GLONASS **36**
 - signals **2**
 - source **2**
 - WAAS **36**

- GPS accuracy **38**
- gybing. See tacking and gybing

H

- heading
 - heading hold **19**
 - holding **28**
 - line **6**
- help. See product support
- home screen, customizing **2, 3**

J

- jibing. See tacking and gybing

K

- keel offset **18, 36**
- keys **1, 2**
 - power **1, 2**

L

- language **36**

M

- man overboard **13, 28**
- maps. See charts
- marine services **13**
- mark location **13**
- MARPA, navigation chart **10**
- measuring distance **23**
 - charts **5**
- media player **33–35**
 - alphabetical search **33**
 - DAB **34**
 - device name **35**
 - FUSION-Link **33**
 - muting **34**
 - preset **34**
 - radio **35**
 - repeating **33**
 - shuffling **33**
 - SiriusXM Satellite Radio **35**
 - source **33**
 - tuner region **34**
 - tuning mode **34**
 - VHF **34**
 - zones **34**
- memory card **40**
 - installing **2**
 - slot **1**
- MOB, device **8**
- music player **33, 35**. See media player

N

- navaids **6**
- naviads **8**
- navigation alarms **38**
- navigation chart **5, 7, 13**
 - ATONs **8**
 - marine service points **13**
 - MARPA **10**
 - panning **5**
 - setup **39**
 - vessel trails **10, 31**
- NMEA 0183 **30, 37, 38, 43**
- NMEA 2000 **38, 43**
- notifications **4**

O

- off course alarm **38**
- other vessels
 - AIS **10**
 - trails **10**
- overlay bar **29**

P

- Panoptix **27**
- photos, aerial **7**
- position, tracking **30**
- position report **31**
- power key **1, 2, 36**
- powerboat **3, 18**
- preferred data source **28**

- premium charts **6, 7**
 - aerial photos **7**
 - Fish Eye 3D **10**
 - tide and current indicators **6**
- presets **34**
 - DAB **35**
- product registration **40**
- product support **2**

Q

- quickdraw **11**

R

- radio **34**
 - AM **34**
 - FM **34**
 - SiriusXM **35**
- range rings **9**
- registering the device **40**
- remote control **28**
- reset **39**
- resetting, settings **35**
- restore **39**
- Route To **12**
- routes **12, 14, 17**
 - copying **40**
 - creating **14**
 - deleting **15**
 - editing **14**
 - navigating **14**
 - navigating parallel to **15**
 - sharing **39**
 - viewing list of **14**
 - waypoints **40**

S

- safe zone collision alarm **8**
- sailboat **3, 18**
- sailing **9, 18**
 - race timer **18**
 - starting line **18**
- sailing gauges **32**
- SART **8**
- satellite imagery **7**
- satellite signals, acquiring **2**
- screen, brightness **3**
- screenshots **41**
 - capturing **41**
- settings **12, 36, 38, 39**
 - system information **36**
- sharing data **39**
- shoreline distance **16**
- shortcuts **2, 30**
- SideVü **20**
- SiriusXM, Satellite Radio **35**
- SiriusXM Satellite Radio **35**
- smart notifications **4**
- software
 - updates **35, 41**
 - updating **4, 41**
- sonar **19, 20, 23**
 - a-scope **22, 25, 26**
 - alarms **25**
 - appearance **25**
 - bottom lock **24**
 - color gain **23**
 - color rejection **25**
 - cone **10**
 - depth **24**
 - depth line **24**
 - depth scale **24**
 - flasher **22**
 - frequencies **25, 26**
 - FrontVü **22**
 - gain **23**
 - Garmin ClearVü **20**
 - interference **25**
 - measuring distances **23**
 - noise **23, 25**
 - overlay numbers **24**

- Panoptix **21, 22, 26, 27**
 - recording **24**
 - scroll speed **24**
 - sharing **23**
 - SideVü **20**
 - source **23**
 - surface noise **25**
 - suspended targets **25**
 - views **20**
 - waypoint **23**
 - whiteline **25**
 - zoom **24**

- support. See product support
- suspended targets **10**
- symbols **7**
- system information **36, 40**

T

- tacking and gybing **19**
 - heading hold **19**
 - wind hold **19**
- tide stations **6, 33**
 - indicators **7**
- tracks **16, 17**
 - clearing **17**
 - copying **40**
 - deleting **17**
 - editing **16**
 - list **16**
 - navigating **16, 17**
 - recording **17**
 - saving **16**
 - saving as route **16**
 - showing **10, 16**
- transducer **19, 22, 25, 27**
- trip gauges **31**
- trolling motor **29**
 - bow offset **30**
 - compass **30**
- troubleshooting **41, 42**

U

- unit ID **36**
- units of measure **38**
- updates, software **41**
- updating
 - charts **4**
 - software **4**
- user data, deleting **18, 40**

V

- vessel trails **10, 31**
- VHF radio **30**
 - calling an AIS target **31**
 - distress calls **30**
 - DSC channel **31**
 - individual routine call **31**
- voltage **38**

W

- WAAS **36**
- water
 - speed **37**
 - temperature offset **37**
- waypoints **13, 42**
 - copying **40**
 - creating **5, 13**
 - deleting **14**
 - editing **13**
 - man overboard **13**
 - navigating to **14**
 - projecting **13**
 - sharing **39**
 - showing **10**
 - sonar **23**
 - tracked vessel **31**
 - viewing list of **13**
- Wi-Fi **3**
- Wi-Fi technology **37, 38**
- wind, rose **9**
- wind gauges **32**

- wind hold **19**
 - adjusting **19**
- wireless devices **38**
 - connecting a wireless device **38**
 - connecting to a wireless device **3**
 - network configuration **38**

Z

- zoom
 - chart **5**
 - sonar **24**

