

GARMIN[®]

Edge[®] 510

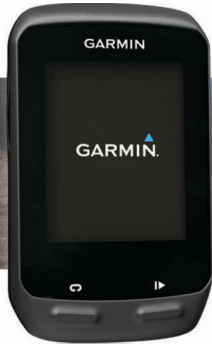

Owner's Manual

© 2013 Garmin Ltd. or its subsidiaries

All rights reserved. Under the copyright laws, this manual may not be copied, in whole or in part, without the written consent of Garmin. Garmin reserves the right to change or improve its products and to make changes in the content of this manual without obligation to notify any person or organization of such changes or improvements. Go to www.garmin.com for current updates and supplemental information concerning the use of this product.

Garmin®, the Garmin logo, ANT+®, Auto Lap®, Auto Pause®, Edge®, and Virtual Partner® are trademarks of Garmin Ltd. or its subsidiaries, registered in the USA and other countries. BaseCamp™, Garmin Connect™, Garmin Index™, GSC™, Varia™, and Vector™ are trademarks of Garmin Ltd. or its subsidiaries. These trademarks may not be used without the express permission of Garmin.

Android™ is a trademark of Google Inc. Apple® and Mac® are trademarks of Apple, Inc., registered in the U.S. and other countries. The Bluetooth® word mark and logos are owned by the Bluetooth SIG, Inc. and any use of such marks by Garmin is under license. New Leaf® is a registered trademark of the Angeion Corporation. Di2™ is a trademark of Shimano, Inc. Shimano® is a registered trademark of Shimano, Inc. STRAVA and Strava™ are trademarks of Strava, Inc. Training Stress Score™ (TSS), Intensity Factor™ (IF), and Normalized Power™ (NP) are trademarks of Peaksware, LLC. Windows® is a registered trademark of Microsoft Corporation in the United States and other countries. Other trademarks and trade names are those of their respective owners.

This product is ANT+® certified. Visit www.thisisant.com/directory for a list of compatible products and apps.

Table of Contents

Introduction	1	Situational Awareness.....	8
Getting Started.....	1	Pairing Your ANT+ Sensors.....	9
Charging the Device.....	1	Pairing a Heart Rate Monitor.....	9
About the Battery.....	1	Using the Weight Scale.....	9
Installing the Standard Mount.....	1	Garmin Index™ Smart Scale Data.....	9
Installing the Out-Front Mount.....	1	History	9
Releasing the Edge.....	2	Viewing Your Ride.....	9
Turning On the Device.....	2	Viewing Data Totals.....	9
Keys.....	2	Sending Your Ride to Garmin Connect.....	9
Acquiring Satellite Signals.....	2	Garmin Connect.....	9
Training	3	Bluetooth® Connected Features.....	9
Going for a Ride.....	3	Sending a Ride to Your Smartphone.....	10
Alerts.....	3	Deleting History.....	10
Setting Range Alerts.....	3	Data Recording.....	10
Setting a Recurring Alert.....	3	Data Management.....	10
Workouts.....	3	Connecting the Device to Your Computer.....	10
Following a Workout From the Web.....	3	Transferring Files to Your Device.....	10
Creating a Workout.....	3	Deleting Files.....	10
Repeating Workout Steps.....	3	Disconnecting the USB Cable.....	10
Starting a Workout.....	4	Customizing Your Device	11
Stopping a Workout.....	4	Profiles.....	11
Editing a Workout.....	4	Updating Your Bike Profile.....	11
Deleting a Workout.....	4	Updating Your Activity Profile.....	11
About the Training Calendar.....	4	Setting Up Your User Profile.....	11
Using Garmin Connect Training Plans.....	4	About Lifetime Athletes.....	11
Using Virtual Partner®.....	4	Bluetooth Settings.....	11
Courses.....	4	About Training Settings.....	11
Creating a Course on Your Device.....	4	Customizing the Data Pages.....	11
Following a Course From the Web.....	4	Using Auto Pause.....	11
Tips for Training with Courses.....	5	Marking Laps by Position.....	12
Displaying a Course on the Map.....	5	Marking Laps by Distance.....	12
Changing the Course Speed.....	5	Using Auto Scroll.....	12
Stopping a Course.....	5	Changing the Start Notice.....	12
Deleting a Course.....	5	System Settings.....	12
Segments.....	5	GPS Settings.....	12
Strava™ Segments.....	5	Display Settings.....	12
Downloading a Segment from the Web.....	5	Data Recording Settings.....	13
Enabling Segments.....	5	Changing the Units of Measure.....	13
Racing a Segment.....	5	Changing the Configuration Settings.....	13
Viewing Segment Details.....	5	Changing the Device Language.....	13
Segment Options.....	6	Setting the Device Tones.....	13
Deleting a Segment.....	6	Time Zones.....	13
Personal Records.....	6	Device Information	13
Restoring Your Personal Records.....	6	Specifications.....	13
Training Zones.....	6	Edge Specifications.....	13
Setting Your Speed Zones.....	6	Heart Rate Monitor Specifications.....	13
ANT+ Sensors	6	Speed Sensor and Cadence Sensor Specifications.....	13
Putting On the Heart Rate Monitor.....	6	GSC 10 Specifications.....	13
Setting Your Heart Rate Zones.....	6	Device Care.....	13
About Heart Rate Zones.....	6	Cleaning the Device.....	13
Fitness Goals.....	7	Caring for the Heart Rate Monitor.....	13
Tips for Erratic Heart Rate Data.....	7	User Replaceable Batteries.....	14
Installing the Speed Sensor.....	7	Replacing the Heart Rate Monitor Battery.....	14
Installing the Cadence Sensor.....	7	Replacing the Speed Sensor or Cadence Sensor Battery.....	14
About the Speed and Cadence Sensors.....	7	Replacing the GSC 10 Battery.....	14
Installing the GSC™ 10.....	7	Troubleshooting	14
About the GSC 10.....	8	Resetting the Device.....	14
Data Averaging for Cadence or Power.....	8	Clearing User Data.....	14
Training with Power Meters.....	8	Maximizing Battery Life.....	15
Setting Your Power Zones.....	8	Decreasing the Backlight.....	15
Calibrating Your Power Meter.....	8	Adjusting the Backlight Timeout.....	15
Pedal-Based Power.....	8	Using the Auto Power Down Feature.....	15
Using Shimano® Di2™ Shifters.....	8	Calibrating the Touchscreen.....	15
		Locking the Touchscreen.....	15
		Unlocking the Touchscreen.....	15

Getting More Information	15
Temperature Readings	15
Viewing Device Information	15
Updating the Software	15
Appendix	15
Registering Your Device	15
Data Fields	15
Heart Rate Zone Calculations	17
Wheel Size and Circumference	17
Software License Agreement	18
Index	19

Introduction

⚠ WARNING

See the *Important Safety and Product Information* guide in the product box for product warnings and other important information.

Always consult your physician before you begin or modify any exercise program.

Getting Started

When using your device the first time, you should complete these tasks to set up the device and learn about the basic features.

- 1 Install your device using the standard mount (*Installing the Standard Mount*, page 1) or the out-front mount (*Installing the Out-Front Mount*, page 1).
- 2 Turn on the device (*Turning On the Device*, page 2).
- 3 Locate satellites (*Acquiring Satellite Signals*, page 2).
- 4 Go for a ride (*Going for a Ride*, page 3).
- 5 Charge the device (*Charging the Device*, page 1).
- 6 Register the device (*Registering Your Device*, page 15).
- 7 Upload your ride to Garmin Connect™ (*Sending Your Ride to Garmin Connect*, page 9).

Charging the Device

NOTICE

To prevent corrosion, thoroughly dry the USB port, the weather cap, and the surrounding area before charging or connecting to a computer.

The device is powered by a built-in lithium-ion battery that you can charge using a standard wall outlet or a USB port on your computer.

NOTE: The device will not charge when outside the temperature range of 32° to 113°F (0° to 45°C).

- 1 Pull up the weather cap ① from the mini-USB port ②.



- 2 Plug the small end of the USB cable into the mini-USB port.
- 3 Plug the USB end of the cable into the AC adapter or a computer USB port.
- 4 Plug the AC adapter into a standard wall outlet.
When you connect the device to a power source, the device turns on.
- 5 Charge the device completely.

A fully charged battery can run for up to 15 hours before it must be recharged.

About the Battery

⚠ WARNING

This device contains a lithium-ion battery. See the *Important Safety and Product Information* guide in the product box for product warnings and other important information.

Installing the Standard Mount

For the best GPS reception, position the bike mount so the front of the device is oriented toward the sky. You can install the bike mount on the stem or the handlebars.

- 1 Select a secure location to mount the device where it does not interfere with the safe operation of your bike.
- 2 Place the rubber disk ① on the back of the bike mount.
The rubber tabs align with the back of the bike mount so it stays in place.

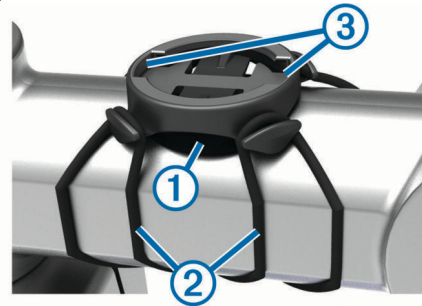

- 3 Place the bike mount on the bike stem.
- 4 Attach the bike mount securely using the two bands ②.
- 5 Align the tabs on the back of the device with the bike mount notches ③.
- 6 Press down slightly and turn the device clockwise until it locks into place.



Installing the Out-Front Mount

- 1 Select a secure location to mount the Edge device where it does not interfere with the safe operation of your bike.
- 2 Use the hex key ① to remove the screw ① from the handlebar connector ②.



- 3 If necessary, remove the two screws on the back side of the mount ③, rotate the connector ④, and replace the screws to change the orientation of the mount.
- 4 Place the rubber pad around the handlebar:
 - If the handlebar diameter is 25.4 mm, use the thicker pad.
 - If the handlebar diameter is 31.8 mm, use the thinner pad.
- 5 Place the handlebar connector around the rubber pad.
- 6 Replace and tighten the screw.
NOTE: Garmin® recommends a torque specification of 7 lbf-in. (0.8 N-m). You should check the tightness of the screw periodically.
- 7 Align the tabs on the back of the Edge device with the bike mount notches ⑤.

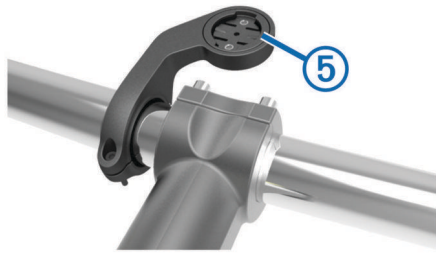

8 Press down slightly and turn the Edge device clockwise until it locks into place.

Releasing the Edge

- 1 Turn the Edge clockwise to unlock the device.
- 2 Lift the Edge off the mount.

Turning On the Device

The first time you turn on the device, you are prompted to configure system settings and profiles.



- 1 Hold .
- 2 Follow the on-screen instructions.

If your device includes ANT+® sensors (such as a heart rate monitor, speed sensor, or cadence sensor), you can activate them during configuration.

For more information about ANT+ sensors, see [ANT+ Sensors](#), page 6.

Keys





① 	Select to turn the backlight on and off. Hold to turn the device on and off.
② 	Select to mark a new lap.
③ 	Select to start and stop the timer.









Home Screen Overview

The home screen gives you quick access to all the features of the Edge.

 >	Select to change your bike profile.
RIDE	Select to go for a ride.
Road >	Select to change your activity profile.

	Select to manage your history, courses, and workouts.
	Select to view the setup menu.

Using the Touchscreen

- When the timer is running, tap the screen to view the timer overlay.
The timer overlay allows you to use the settings and search features during a ride.
- Select  to save your changes and close the page.
- Select  to close the page and return to the previous page.
- Select  to return to the previous page.
- Select  to return to the home screen.
- Select  and  to scroll.
- Select  to view the connections page.
- Select  to delete an item.

Viewing the Connections Page

The connections page displays the status of the satellite signals, ANT+ sensors, and your smartphone.

From the home screen, select the status bar at the top of the page.

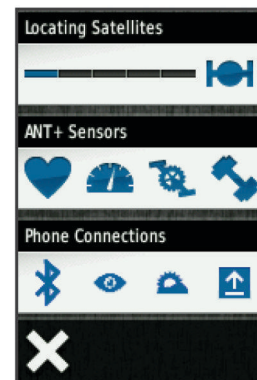

The connections page appears. A flashing icon means the device is searching. You can select any icon to change the settings.

Using the Backlight

- At any time, select anywhere on the screen to turn on the backlight.
- Select  to adjust the backlight brightness and timeout.

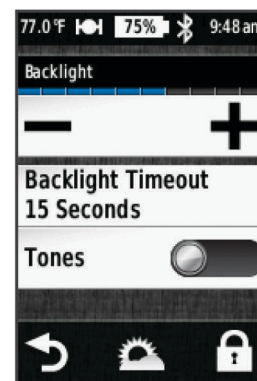

Acquiring Satellite Signals

Before you can use the GPS tracking and navigation features, you must acquire satellite signals.

The device may need a clear view of the sky to acquire satellite signals. The time and date are set automatically based on the GPS position.

- 1 Go outdoors to an open area.
The front of the device should be oriented toward the sky.
- 2 From the home screen, select **RIDE**.
- 3 Wait while the device locates satellites.
It may take 30–60 seconds to locate satellite signals.
TIP: Do not begin moving until the timer page appears (*Going for a Ride, page 3*).

Training

Going for a Ride

Before you can record speed and distance, you must locate satellite signals (*Acquiring Satellite Signals, page 2*) or pair your device with an optional ANT+ sensor.

NOTE: History is recorded only while the timer is running.

- 1 From the home screen, select **RIDE**.
- 2 Wait while the device locates satellites.
- 3 Select **▶** to start the timer.

Time 01:08:43	
Speed 18.2 <small>m</small>	
Distance 20.23 <small>m</small>	
Cadence 83 <small>r</small> <small>p</small> <small>m</small>	Heart Rate 163 <small>b</small> <small>p</small> <small>m</small>

- 4 Swipe the screen for additional data pages.
- 5 If necessary, tap the screen to view the timer overlay.
- 6 Select **▶** to stop the timer.
- 7 Select **Save**.

Alerts

You can use alerts to train toward specific time, distance, calorie, heart rate, cadence, and power goals. Alert settings are saved with your activity profile.

Setting Range Alerts

If you have an optional heart rate monitor, cadence sensor, or power meter, you can set up range alerts. A range alert notifies you when the device measurement is above or below a specified range of values. For example, you can set the device to alert you when your cadence is below 40 RPM and over 90 RPM. You can also use a training zone (*Training Zones, page 6*) for the range alert.

- 1 Select **⌘** > **Activity Profiles**.
- 2 Select a profile.
- 3 Select **Alerts**.
- 4 Select **Heart Rate**, **Cadence**, or **Power**.
- 5 If necessary, turn on the alert.
- 6 Enter the minimum and maximum values, or select zones.
- 7 If necessary, select **✓**.

Each time you exceed or drop below the specified range, a message appears. The device also beeps if audible tones are turned on (*Setting the Device Tones, page 13*).

Setting a Recurring Alert

A recurring alert notifies you every time the device records a specified value or interval. For example, you can set the device to alert you every 30 minutes.

- 1 From the home screen, select **⌘** > **Activity Profiles**.
- 2 Select an activity profile.
- 3 Select **Alerts**.
- 4 Select **Time**, **Distance**, or **Calorie**.
- 5 Turn on the alert.
- 6 Enter a value.
- 7 Select **✓**.

Each time you reach the alert value, a message appears. The device also beeps if audible tones are turned on (*Setting the Device Tones, page 13*).

Workouts

You can create custom workouts that include goals for each workout step and for varied distances, times, and calories. You can create workouts using Garmin Connect, and transfer them to your device. You can also create and save a workout directly on your device.

You can schedule workouts using Garmin Connect. You can plan workouts in advance and store them on your device.

Following a Workout From the Web

Before you can download a workout from Garmin Connect, you must have a Garmin Connect account (*Garmin Connect, page 9*).

- 1 Connect the device to your computer using the USB cable.
- 2 Go to www.garminconnect.com/workouts.
- 3 Create a new workout.
- 4 Select **Send to Device**.
- 5 Disconnect the device, and turn it on.
- 6 Select **■** > **Workouts**.
- 7 Select the workout.
- 8 Select **Do Workout**.

Creating a Workout

- 1 From the home screen, select **■** > **Workouts** > **+**.
A new workout appears. The first step is open by default, and it can be used as a warmup step.
- 2 Select **Name**, and enter a workout name.
- 3 Select **Add New Step**.
- 4 Select a step, and select **Edit Step**.
- 5 Select **Duration** to specify how the step is measured.
For example, select Distance to end the step after a specific distance.
If you select Open, you can select **↻** at anytime to end the step.
- 6 If necessary, enter a value in the field below **Duration**.
- 7 Select **Target** to choose your goal during the step.
For example, select Heart Rate to maintain a consistent heart rate during the step.
- 8 If necessary, select a target zone or enter a custom range.
For example, you can select a heart rate zone. Each time you exceed or drop below the specified heart rate, the device beeps and displays a message.
- 9 If necessary, select **✓** in the **Rest Lap** field.
During a rest lap, the timer continues to run and data is recorded.
- 10 Select **✓** to save the step.
- 11 Select **↻** to save the workout.

Repeating Workout Steps

Before you can repeat a workout step, you must create a workout with at least one step.

- 1 Select **Add New Step**.
- 2 Select **Duration**.
- 3 Select an option:
 - Select **Repeat** to repeat a step one or more times. For example, you can repeat a 5-mile step ten times.
 - Select **Repeat Until** to repeat a step for a specific duration. For example, you can repeat a 5-mile step for 60 minutes or until your heart rate reaches 160 bpm.
- 4 Select **Back to Step**, and select a step to repeat.
- 5 Select ✓ to save the step.

Starting a Workout

- 1 From the home screen, select ■ > **Workouts**.
- 2 Select a workout.
- 3 Select **Do Workout**.

After you begin a workout, the device displays each step of the workout, the target (if any), and current workout data. An audible alarm sounds when you are about to finish a workout step. A message appears, counting down the time or distance until a new step begins.

Stopping a Workout

- At any time, select ↺ to end a workout step.
- At any time, select ▶ to stop the timer.
- At any time, select 🏠 > ■ > **Workouts** > **Stop Workout** to end the workout.

Editing a Workout

- 1 From the home screen, select ■ > **Workouts**.
- 2 Select a workout.
- 3 Select ✎.
- 4 Select a step, and select **Edit Step**.
- 5 Change the step attributes, and select ✓.
- 6 Select ↵ to save the workout.

Deleting a Workout

- 1 From the home screen, select ■ > **Workouts**.
- 2 Select a workout.
- 3 Select ✎ > 🗑 > ✓.

About the Training Calendar

The training calendar on your device is an extension of the training calendar or schedule you set up in Garmin Connect. After you have added a few workouts to the Garmin Connect calendar, you can send them to your device. All scheduled workouts sent to the device appear in the training calendar list by date. When you select a day in the training calendar, you can view or do the workout. The scheduled workout stays on your device whether you complete it or skip it. When you send scheduled workouts from Garmin Connect, they overwrite the existing training calendar.

Using Garmin Connect Training Plans

Before you can download and use a training plan from Garmin Connect, you must have a Garmin Connect account ([Garmin Connect](#), page 9).

You can browse Garmin Connect to find a training plan, schedule workouts and courses, and download the plan to your device.

- 1 Connect the device to your computer.
- 2 Go to www.garminconnect.com.
- 3 Select and schedule a training plan.
- 4 Review the training plan in your calendar.
- 5 Select ☐, and follow the on-screen instructions.

Using Virtual Partner®

Your Virtual Partner is a training tool designed to help you meet your goals.

- 1 Go for a ride.
- 2 Scroll to the Virtual Partner page to see who is leading.



- 3 If necessary, use + and - to adjust the speed of the Virtual Partner during your ride.

Courses

Following a previously recorded activity: You can follow a saved course simply because it is a good route. For example, you can save and follow a bike friendly commute to work.

Racing against a previously recorded activity: You can also follow a saved course, trying to match or exceed previously set performance goals. For example, if the original course was completed in 30 minutes, you can race against a Virtual Partner trying to complete the course in under 30 minutes.

Following an existing ride from Garmin Connect: You can send a course from Garmin Connect to your device. Once it is saved to your device, you can follow the course or race against the course.

Creating a Course on Your Device

Before you can create a course, you must have an activity with GPS data saved to your device.

- 1 Select ■ > **Courses** > ≡ > **Create New**.
- 2 Select an activity on which to base your course.
- 3 Enter a name for the course, and select ✓.
The course appears in the list.
- 4 Select the course, and review the course details.
- 5 If necessary, select **Settings** to edit the course details.
For example, you can change the name of the course or turn on Virtual Partner.
- 6 Select ↵ > **RIDE**.

Following a Course From the Web

Before you can download a course from Garmin Connect, you must have a Garmin Connect account ([Garmin Connect](#), page 9).

- 1 Connect the device to your computer using the USB cable.

- 2 Go to www.garminconnect.com.
- 3 Create a new course, or select an existing course.
- 4 Select **Send to Device**.
- 5 Disconnect the device, and turn it on.
- 6 Select **■** > **Courses**.
- 7 Select the course.
- 8 Select **RIDE**.

Tips for Training with Courses

- If you include a warmup, select **▶** to begin the course, and warm up as normal.
- Stay away from your course path as you warm up. When you are ready to begin, head toward your course. When you are on any part of the course path, a message appears.
NOTE: As soon as you select **▶**, your Virtual Partner starts the course and does not wait for you to warm up.
- Scroll to the map to view the course map.
If you stray from the course, the device displays a message.

Displaying a Course on the Map

For each course saved to your device, you can customize how it appears on the map. For example, you can set your commute course to always display on the map in yellow. You can have an alternate course display in green. This allows you to see the courses while you are riding, but not follow or navigate a particular course.

- 1 From the home screen, select **■** > **Courses**.
- 2 Select the course.
- 3 Select **Settings** > **Map Display**.
- 4 Select **Always Display** > **On** to have the course appear on the map.
- 5 Select **Color**, and select a color.

The next time you ride near the course, it appears on the map.

Changing the Course Speed

- 1 From the home screen, select **■** > **Courses**.
- 2 Select a course.
- 3 Select **RIDE**.
- 4 Scroll to the Virtual Partner page.
- 5 Use **+** or **-** to adjust the percentage of time to complete the course.

For example, to improve your course time by 20%, enter a course speed of 120%. You will race against the Virtual Partner to finish a 30-minute course in 24 minutes.

Stopping a Course

- 1 Tap the screen to view the timer overlay.
- 2 Select **Q** > **Courses** > **Stop Course**.

Deleting a Course

- 1 From the home screen, select **■** > **Courses**.
- 2 Select a course.
- 3 Select **✕** > **✓**.

Segments

You can send segments from your Garmin Connect account to your device. After a segment is saved to your device, you can race a segment, trying to match or exceed your personal record or other cyclists who have ridden the segment.

NOTE: When you download a course from your Garmin Connect account, all segments in the course are downloaded automatically.

Strava™ Segments

You can download Strava segments to your Edge device. Follow Strava segments to compare your performance with your past rides, friends, and pros who have ridden the same segment.

To sign up for a Strava membership, go to the segments widget in your Garmin Connect account. For more information, go to www.strava.com.

The information in this manual applies to both Garmin Connect segments and Strava segments.

Downloading a Segment from the Web

Before you can download a segment from Garmin Connect, you must have a Garmin Connect account (*Garmin Connect*, page 9).

- 1 Connect the device to your computer using the USB cable.
NOTE: If you are using Strava segments, your favorite segments are transferred automatically to your device when it is connected to Garmin Connect Mobile or your computer.
- 2 Go to www.garminconnect.com.
- 3 Create a new segment, or select an existing segment.
- 4 Select **Send to Device**.
- 5 Disconnect the device, and turn it on.
- 6 Select **■** > **Segments**.
The segment appears in the list.

Enabling Segments

You can enable Virtual Partner racing and prompts that alert you to approaching segments.

- 1 Select **■** > **Segments**.
- 2 Select a segment.
- 3 Select **Enable**.

NOTE: Prompts alerting you to approaching segments appear only for enabled segments.

Racing a Segment

Segments are virtual race courses. You can race a segment, and compare your performance to past activities, other riders' performance, connections in your Garmin Connect account, or other members of the cycling community. You can upload your activity data to your Garmin Connect account to view your segment position.

NOTE: If your Garmin Connect account and Strava account are linked, your activity is automatically sent to your Strava account so you can review the segment position.

- 1 Select **▶** to start the timer, and go for a ride.
When your path crosses an enabled segment, you can race the segment.
- 2 Start racing the segment.
- 3 Scroll to the Virtual Partner screen to view your progress.
- 4 If necessary, select **◀** or **▶** to change your goal during your race.
You can race against the group leader, challenger, or other riders (if applicable).

A message appears when the segment is complete.

Viewing Segment Details

- 1 Select **■** > **Segments**.
- 2 Select a segment.
- 3 Select an option:
 - Select **Map** to view the segment on the map.
 - Select **Elevation** to view an elevation plot of the segment.
 - Select **Leaderboard** to view the ride times and average speeds for the segment leader, group leader or

challenger, your personal best time and average speed, and other riders (if applicable).

TIP: You can select a leaderboard entry to change your segment race goal.

Segment Options

Select **■** > **Segments** > **☰**.

Search: Allows you to search for saved segments by name.

Enable All: Enables all segments currently loaded on the device.

Disable All: Disables all segments currently loaded on the device.

Edit Multiple: Allows you to enable or disable multiple segments loaded on the device.

Deleting a Segment

1 Select **■** > **Segments**.

2 Select a segment.

3 Select **✕** > **✓**.

Personal Records

When you complete a ride, the device displays any new personal records you achieved during that ride. Personal records include your fastest time over a standard distance, longest ride, and most ascent gained during a ride.

Restoring Your Personal Records

You can revert a personal record back to the previous saved record.

1 From the home screen, select **■** > **Personal Records**.

2 Select **↶**.

3 Select a record, and select **✓**.

NOTE: This does not delete any saved activities.

Training Zones

- Heart rate zones ([Setting Your Heart Rate Zones, page 6](#))
- Power zones ([Setting Your Power Zones, page 8](#))
- Speed zones ([Setting Your Speed Zones, page 6](#))

Setting Your Speed Zones

Your device contains several different speed zones, ranging from very slow to your maximum speed. The values for the zones are default values and may not match your personal abilities. You can customize your zones on the device or using Garmin Connect.

1 From the home screen, **✕** > **Training Zones** > **Speed**.

2 Select a zone.

You can enter a custom name for the zone.

3 Enter the minimum and maximum speed values.

4 Repeat steps 2–3 for each zone.

ANT+ Sensors

Your device can be used with wireless ANT+ sensors. For more information about compatibility and purchasing optional sensors, go to <http://buy.garmin.com>.

Putting On the Heart Rate Monitor

NOTE: If you do not have a heart rate monitor, you can skip this task.

You should wear the heart rate monitor directly on your skin, just below your sternum. It should be snug enough to stay in place during your activity.

1 Snap the heart rate monitor module **①** onto the strap.



The Garmin logos on the module and the strap should be right-side up.

2 Wet the electrodes **②** and the contact patches **③** on the back of the strap to create a strong connection between your chest and the transmitter.



3 Wrap the strap around your chest, and connect the strap hook **④** to the loop **⑤**.

NOTE: The care tag should not fold over.

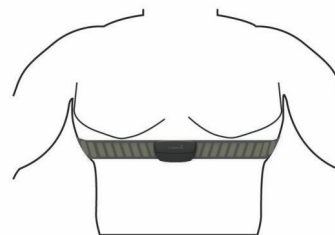

The Garmin logos should be right-side up.

4 Bring the device within 3 m (10 ft.) of the heart rate monitor. After you put on the heart rate monitor, it is active and sending data.

TIP: If the heart rate data is erratic or does not appear, see the troubleshooting tips ([Tips for Erratic Heart Rate Data, page 7](#)).

Setting Your Heart Rate Zones

The device uses your user profile information from the initial setup to determine your heart rate zones. You can manually adjust the heart rate zones according to your fitness goals ([Fitness Goals, page 7](#)). For the most accurate calorie data during your activity, set your maximum heart rate, minimum heart rate, resting heart rate, and heart rate zones.

1 From the home screen, select **✕** > **Training Zones** > **Heart Rate**.

2 Enter your maximum, minimum, and resting heart rate values.

The zone values update automatically, but you can also edit each value manually.

3 Select **Based On:**.

4 Select an option:

- Select **BPM** to view and edit the zones in beats per minute.
- Select **% Max.** to view and edit the zones as a percentage of your maximum heart rate.
- Select **% HRR** to view and edit the zones as a percentage of your resting heart rate.

About Heart Rate Zones

Many athletes use heart rate zones to measure and increase their cardiovascular strength and improve their level of fitness. A heart rate zone is a set range of heartbeats per minute. The five commonly accepted heart rate zones are numbered from 1 to 5 according to increasing intensity. Generally, heart rate zones are calculated based on percentages of your maximum heart rate.

Fitness Goals

Knowing your heart rate zones can help you measure and improve your fitness by understanding and applying these principles.

- Your heart rate is a good measure of exercise intensity.
- Training in certain heart rate zones can help you improve cardiovascular capacity and strength.
- Knowing your heart rate zones can prevent you from overtraining and can decrease your risk of injury.

If you know your maximum heart rate, you can use the table (*Heart Rate Zone Calculations, page 17*) to determine the best heart rate zone for your fitness objectives.

If you do not know your maximum heart rate, use one of the calculators available on the Internet. Some gyms and health centers can provide a test that measures maximum heart rate. The default maximum heart rate is 220 minus your age.

Tips for Erratic Heart Rate Data

If the heart rate data is erratic or does not appear, you can try these tips.

- Reapply water to the electrodes and contact patches (if applicable).
- Tighten the strap on your chest.
- Warm up for 5 to 10 minutes.
- Follow the care instructions (*Caring for the Heart Rate Monitor, page 13*).
- Wear a cotton shirt or thoroughly wet both sides of the strap. Synthetic fabrics that rub or flap against the heart rate monitor can create static electricity that interferes with heart rate signals.
- Move away from sources that can interfere with your heart rate monitor.

Sources of interference may include strong electromagnetic fields, some 2.4 GHz wireless sensors, high-voltage power lines, electric motors, ovens, microwave ovens, 2.4 GHz cordless phones, and wireless LAN access points.

Installing the Speed Sensor

NOTE: If you do not have this sensor, you can skip this task.

TIP: Garmin recommends you secure your bike on a stand while installing the sensor.

- 1 Place and hold the speed sensor on top of the wheel hub.
- 2 Pull the strap ① around the wheel hub, and attach it to the hook ② on the sensor.

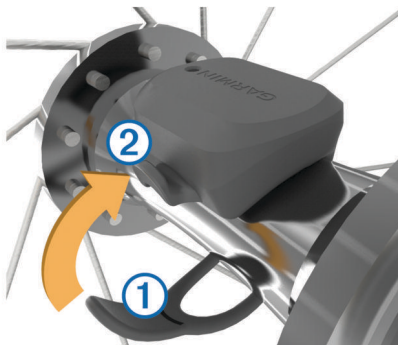

The sensor may be tilted when installed on an asymmetrical hub. This does not affect operation.

- 3 Rotate the wheel to check for clearance.

The sensor should not contact other parts of your bike.

NOTE: The LED flashes green for five seconds to indicate activity after two revolutions.

Installing the Cadence Sensor

NOTE: If you do not have this sensor, you can skip this task.

TIP: Garmin recommends you secure your bike on a stand while installing the sensor.

- 1 Select the band size that fits your crank arm ① securely. The band you select should be the smallest one that stretches across the crank arm.
- 2 On the non-drive side, place and hold the flat side of the cadence sensor on the inside of the crank arm.
- 3 Pull the bands ② around the crank arm, and attach them to the hooks ③ on the sensor.

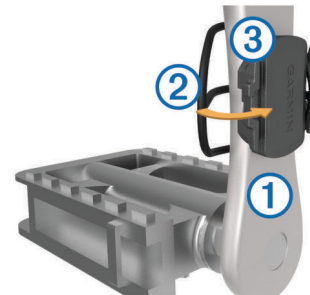

- 4 Rotate the crank arm to check for clearance. The sensor and bands should not contact any part of your bike or shoe.

NOTE: The LED flashes green for five seconds to indicate activity after two revolutions.

- 5 Take a 15 minute test ride and inspect the sensor and bands to ensure there is no evidence of damage.

About the Speed and Cadence Sensors

Cadence data from the cadence sensor is always recorded. If no speed and cadence sensors are paired with the device, GPS data is used to calculate the speed and distance.

Cadence is your rate of pedaling or “spinning” measured by the number of revolutions of the crank arm per minute (rpm).

Installing the GSC™ 10

NOTE: If you do not have a GSC 10, you can skip this task.

Both magnets must be aligned with their respective indication lines for the Edge to receive data.

- 1 Place the GSC 10 on the rear chain stay (on the side opposite the drive train).
- 2 If necessary, place the flat rubber pad ① or the triangle-shaped rubber pad between the GSC 10 and the chain stay for stability.

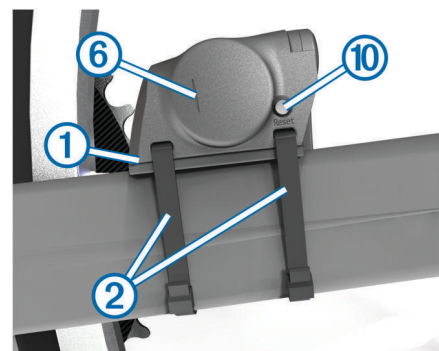

- 3 Loosely attach the GSC 10 using two cable ties ②.

- 4 Attach the pedal magnet ③ to the crank arm using the adhesive mount and a cable tie ④.

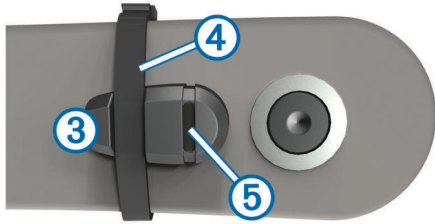

The pedal magnet must be within 5 mm of the GSC 10. The indication line ⑤ on the pedal magnet must line up with the indication line ⑥ on the GSC 10.

- Unscrew the spoke magnet ⑦ from the plastic piece.

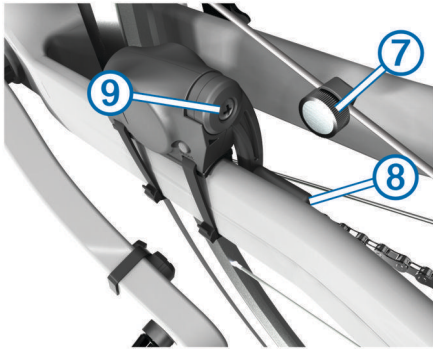

- Place the spoke in the groove of the plastic piece, and tighten it slightly.

The spoke magnet can face away from the GSC 10 if there is not enough room between the sensor arm and the spoke. The spoke magnet must line up with the indication line ⑧ on the sensor arm.

- Loosen the screw ⑨ on the sensor arm.
- Move the sensor arm to within 5 mm of the spoke magnet. You can also tilt the GSC 10 closer to either magnet to improve alignment.

- Select **Reset** ⑩ on the GSC 10. The LED turns red, then green.

- Pedal to test the sensor alignment.

The red LED blinks each time the pedal magnet passes the sensor. The green LED blinks each time the spoke magnet passes the sensor arm.

NOTE: The LED blinks for the first 60 passes after a reset. Select Reset again if you require additional passes.

- When everything is aligned and working correctly, tighten the cable ties, the sensor arm, and the spoke magnet.

Garmin recommends that the torque is 1.9 to 2.4 lbf-in. (0.21 to 0.27 N-m) to ensure a water tight seal on the GSC 10 sensor arm.

About the GSC 10

Cadence data from the GSC 10 is always recorded. If there is no GSC 10 paired, GPS data is used to calculate the speed and distance.

Cadence is your rate of pedaling or “spinning” measured by the number of revolutions of the crank arm per minute (rpm). There are two sensors on the GSC 10: one for cadence and one for speed.

Data Averaging for Cadence or Power

The non-zero data-averaging setting is available if you are training with an optional cadence sensor or power meter. The default setting is to exclude zero values that occur when you are not pedaling.

To change this setting, see [Data Recording Settings](#), page 13.

Training with Power Meters

- Go to www.garmin.com/intosports for a list of ANT+ sensors that are compatible with your device (such as Vector™).
- For more information, see the owner's manual for your power meter.
- Adjust your power zones to match your goals and abilities ([Setting Your Power Zones](#), page 8).
- Use range alerts to be notified when you reach a specified power zone ([Setting Range Alerts](#), page 3).
- Customize the power data fields ([Customizing the Data Pages](#), page 11).

Setting Your Power Zones

The values for the zones are default values and may not match your personal abilities. You can manually adjust your zones on the device or using Garmin Connect. If you know your functional threshold power (FTP) value, you can enter it and allow the software to calculate your power zones automatically.

- From the home screen, select **⌘ > Training Zones > Power**.
- Enter your FTP value.
- Select **Based On:**.
- Select an option:
 - Select **Watts** to view and edit the zones in watts.
 - Select **% FTP** to view and edit the zones as a percentage of your functional threshold power.

Calibrating Your Power Meter

Before you can calibrate your power meter, it must be properly installed, paired with your GPS device, and actively recording data.

For calibration instructions specific to your power meter, refer to the manufacturer's instructions.

- From the home screen, select **⌘**.
- Select **Bike Profiles**.
- Select a profile.
- Select **⌘ > Calibrate**.
- Keep your power meter active by pedaling until the message appears.
- Follow the on-screen instructions.

Pedal-Based Power

Vector measures pedal-based power.

Vector measures the force you apply a few hundred times every second. Vector also measures your cadence or rotational pedaling speed. By measuring the force, the direction of force, the rotation of the crank arm, and time, Vector can determine power (watts). Because Vector independently measures left and right leg power, it reports your left-right power balance.

NOTE: The Vector S system does not provide left-right power balance.

Using Shimano® Di2™ Shifters

Before you can use Di2 electronic shifters, you must pair them with your device ([Pairing Your ANT+ Sensors](#), page 9). You can customize the optional Di2 data fields ([Customizing the Data Pages](#), page 11). The Edge 510 device displays current adjustment values when the sensor is in adjustment mode.

Situational Awareness

Your Edge device can be used with Varia™ smart bike lights and rearview radar to improve situational awareness. See the owner's manual for your Varia device for more information.

NOTE: You may need to update the Edge software before pairing Varia devices ([Updating the Software](#), page 15).

Pairing Your ANT+ Sensors

Before you can pair, you must put on the heart rate monitor or install the sensor.

Pairing is the connecting of ANT+ wireless sensors, for example, connecting a heart rate monitor with your Garmin device.

- 1 Bring the device within range (3 m) of the sensor.

NOTE: Stay 10 m away from other ANT+ sensors while pairing.

- 2 From the home screen, select **✖** > **Bike Profiles**
- 3 Select a profile.
- 4 Select a sensor.
- 5 Enable the sensor, and select **Search**.

When the sensor is paired with your device, the sensor status is Connected. You can customize a data field to display sensor data.

Pairing a Heart Rate Monitor

Before you can pair, you must put on the heart rate monitor.

- 1 Bring the device within range (3 m) of the heart rate monitor.

NOTE: Stay 10 m away from other ANT+ sensors while pairing.

- 2 Select **✖** > **Heart Rate** > **Enable** > **Search**.

When the heart rate monitor is paired with your device, the sensor status is Connected.

Using the Weight Scale

If you have an ANT+ compatible weight scale, the device can read the data from the weight scale.

- 1 From the home screen, select **✖** > **Weight Scale**.

A message appears when the weight scale is found.

- 2 Stand on the scale when indicated.

NOTE: If using a body composition scale, remove shoes and socks to ensure that all body composition parameters are read and recorded.

- 3 Step off the scale when indicated.

TIP: If an error occurs, step off the scale. Step on when indicated.

Garmin Index™ Smart Scale Data

If you have a Garmin Index device, the most recent scale data is stored in your Garmin Connect account. The next time you connect the Edge 510 device to your Garmin Connect account, the weight data is updated in your Edge 510 user profile.

History

History includes time, distance, calories, speed, lap data, elevation, and optional ANT+ sensor information.

NOTE: History is not recorded while the timer is stopped or paused.

When the device memory is full, a message appears. The device does not automatically delete or overwrite your history. Upload your history to Garmin Connect periodically to keep track of all your ride data.

Viewing Your Ride

- 1 From the home screen, select **■** > **Rides**.
- 2 Select **Last Ride** or **All Rides**.
- 3 Select an option.

Viewing Data Totals

You can view the accumulated data you have saved to the Edge, including the number of rides, time, distance, and calories.

From the home screen, select **■** > **Totals**.

Sending Your Ride to Garmin Connect

NOTICE

To prevent corrosion, thoroughly dry the USB port, the weather cap, and the surrounding area before charging or connecting to a computer.

- 1 Pull up the weather cap ① from the mini-USB port ②.



- 2 Plug the small end of the USB cable into the mini-USB port.
- 3 Plug the large end of the USB cable into a computer USB port.
- 4 Go to www.garminconnect.com/start.
- 5 Follow the on-screen instructions.

Garmin Connect

You can connect with your friends on Garmin Connect. Garmin Connect gives you the tools to track, analyze, share, and encourage each other. Record the events of your active lifestyle including runs, walks, rides, swims, hikes, triathlons, and more. To sign up for a free account, go to www.garminconnect.com/start.

Store your activities: After you complete and save an activity with your device, you can upload that activity to Garmin Connect and keep it as long as you want.

Analyze your data: You can view more detailed information about your activity, including time, distance, elevation, heart rate, calories burned, cadence, an overhead map view, pace and speed charts, and customizable reports.

NOTE: Some data requires an optional accessory such as a heart rate monitor.

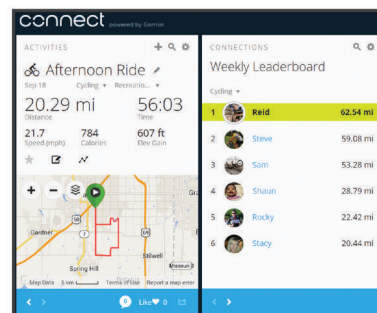

Plan your training: You can choose a fitness goal and load one of the day-by-day training plans.

Share your activities: You can connect with friends to follow each other's activities or post links to your activities on your favorite social networking sites.

Bluetooth® Connected Features

The Edge device has Bluetooth connected features for your compatible smartphone or fitness device. Some features require you to install Garmin Connect mobile on your smartphone. Go to www.garmin.com/intosports/apps for more information.

NOTE: Your device must be connected to your Bluetooth enabled smartphone to take advantage of some features.

LiveTrack: Allows friends and family to follow your races and training activities in real time. You can invite followers using email or social media, allowing them to view your live data on a Garmin Connect tracking page.

Activity uploads to Garmin Connect: Automatically sends your activity to Garmin Connect as soon as you finish recording the activity.

Course and workout downloads from Garmin Connect: Allows you to search for activities on Garmin Connect using your smartphone and send them to your device.

Social media interactions: Allows you to post an update to your favorite social media website when you upload an activity to Garmin Connect.

Weather updates: Sends real-time weather conditions and alerts to your device.

Pairing an Edge with Your Smartphone



You can pair the Edge with an Apple® or Android™ smartphone with the Garmin Connect Mobile application installed to use connected features.

- 1 Place the smartphone and the Edge within 33 ft. (10 m) of each other.
- 2 On the Edge, select  > **Bluetooth** > **Enable** > **Pair Smartphone**.
- 3 On the smartphone, enable Bluetooth.
A list of nearby Bluetooth devices appears.
- 4 Select the Edge from the list.
- 5 Confirm that the same passkey appears on both the Edge and the smartphone.



You can now enable connected features using Garmin Connect Mobile.

Sending a Ride to Your Smartphone

Before you can send a ride to your smartphone, you must install and open the Garmin Connect Mobile application on your smartphone and pair your device with your smartphone ([Bluetooth Settings, page 11](#)).

- 1 From the home screen, select  > **Rides**.
- 2 Select a ride.
- 3 Select .

Deleting History

- 1 From the home screen, select  > **Delete**.
- 2 Select an option:
 - Select **All Rides** to delete all saved activities from the history.
 - Select **Old Rides** to delete activities recorded more than one month ago.
 - Select **All Totals** to reset all distance and time totals.
NOTE: This does not delete any saved activities.
 - Select **All Courses** to delete all courses you have saved or transferred to the device.
 - Select **All Workouts** to delete all workouts you have saved or transferred to the device.
 - Select **All Personal Records** to delete all personal records saved to the device.
NOTE: This does not delete any saved activities.
- 3 Select .

Data Recording

The device uses smart recording. It records key points where you change direction, speed, or heart rate.

When a power meter is paired, the device records points every second. Recording points every second provides an extremely detailed track, and uses more of the available memory.

For information about data averaging for cadence and power, see [Data Averaging for Cadence or Power, page 8](#).

Data Management

NOTE: The device is not compatible with Windows® 95, 98, Me, Windows NT®, and Mac® OS 10.3 and earlier.

Connecting the Device to Your Computer

NOTICE

To prevent corrosion, thoroughly dry the USB port, the weather cap, and the surrounding area before charging or connecting to a computer.

- 1 Pull up the weather cap from the mini-USB port.
- 2 Plug the small end of the USB cable into the mini-USB port.
- 3 Plug the large end of the USB cable into a computer USB port.

Your device appears as a removable drive in My Computer on Windows computers and as a mounted volume on Mac computers.

Transferring Files to Your Device

- 1 Connect the device to your computer ([Connecting the Device to Your Computer, page 10](#)).

Your device and memory card (optional) appear as removable drives in My Computer on Windows computers and as mounted volumes on Mac computers.

NOTE: Some computers with multiple network drives cannot display device drives. See your operating system help file to learn how to map the drive.

- 2 On your computer, open the file browser.
- 3 Select a file.
- 4 Select **Edit** > **Copy**.
- 5 Open the **Garmin** or memory card drive or volume.
- 6 Select **Edit** > **Paste**.

The file appears in the list of files in the device memory or on the memory card.

Deleting Files

NOTICE

If you do not know the purpose of a file, do not delete it. Your device memory contains important system files that should not be deleted.

- 1 Open the **Garmin** drive or volume.
- 2 If necessary, open a folder or volume.
- 3 Select a file.
- 4 Press the **Delete** key on your keyboard.

Disconnecting the USB Cable

If your device is connected to your computer as a removable drive or volume, you must safely disconnect your device from your computer to avoid data loss. If your device is connected to your Windows computer as a portable device, it is not necessary to safely disconnect.

- 1 Complete an action:
 - For Windows computers, select the **Safely Remove Hardware** icon in the system tray, and select your device.
 - For Mac computers, drag the volume icon to the trash.
- 2 Disconnect the cable from your computer.

Customizing Your Device

Profiles

The Edge has several ways for you to customize the device, including profiles. Profiles are a collection of settings that optimize your device based on how you are using it. For example, you can create different settings and views for training and mountain biking.

When you are using a profile and you change settings such as data fields or units of measurement, the changes are saved automatically as part of the profile.



Bike Profiles: You can create a bike profile for each bike you own. The bike profile includes optional ANT+ sensors, bike weight, wheel size, odometer value, and crank length.

Activity Profiles: You can create activity profiles for each type of biking. For example, you can create a separate activity profile for training, for racing, and for mountain biking. The activity profile includes customized data pages, alerts, training zones (such as heart rate and speed), training settings (such as Auto Pause® and Auto Lap®), and navigation settings.

User Profile: You can update your gender, age, weight, height, and lifetime athlete settings. The device uses this information to calculate accurate ride data.

Updating Your Bike Profile



You can customize 10 bike profiles. The device uses the bike weight, odometer value, wheel size, and crank length to calculate accurate ride data.

- 1 From the home screen, select  > **Bike Profiles**.
- 2 Select an option:
 - Select a profile.
 - Select  to add a new profile.
- 3 Select the name of the bike.
- 4 If necessary, edit the name, image, and other settings for the profile.
- 5 If you are using a speed sensor, cadence sensor, or power sensor, select an option:
 - Select **Wheel Size > Automatic** to calculate your wheel size using GPS distance.
 - Select **Wheel Size > Custom** to enter your wheel size. For a table of wheel sizes and circumferences, see [Wheel Size and Circumference, page 17](#).
 - Select **Crank Length > Automatic** to calculate your crank length using GPS distance.
 - Select **Crank Length > Custom** to enter your crank length.

All your changes are saved to the active profile.

Updating Your Activity Profile

You can customize five activity profiles. You can customize your settings and data fields for a particular activity or trip.

- 1 From the home screen, select  > **Activity Profiles**.
- 2 Select an option:
 - Select a profile.
 - Select  to add a new profile.
- 3 If necessary, edit the name and background image for the profile.
- 4 Select an option:
 - Select **Training Pages** to customize the data pages and data fields ([Customizing the Data Pages, page 11](#)).
 - Select **Alerts** to customize your training alerts ([Alerts, page 3](#)).

- Select **Auto Pause** to change when the timer automatically pauses ([Using Auto Pause, page 11](#)).
- Select **Auto Lap** to set how laps are triggered ([Marking Laps by Position, page 12](#)).
- Select **Auto Scroll** to customize the display of the training data pages when the timer is running ([Using Auto Scroll, page 12](#)).

All changes you make are saved to the active profile.

Setting Up Your User Profile

You can update your gender, age, weight, height, and lifetime athlete settings. The device uses this information to calculate accurate ride data.

- 1 From the home screen, select  > **User Profile**.
- 2 Select an option.

About Lifetime Athletes

A lifetime athlete is an individual who has trained intensely for many years (with the exception of minor injuries) and has a resting heart rate of 60 beats per minute (bpm) or less.

Bluetooth Settings

Select  > **Bluetooth**.

Enable: Enables Bluetooth wireless technology.

NOTE: Other Bluetooth settings appear only when Bluetooth is enabled.

Friendly Name: Allows you to enter a friendly name that identifies your devices with Bluetooth wireless technology.



Pair Smartphone: Connects your device with a compatible Bluetooth-enabled smartphone.

About Training Settings

The following options and settings allow you to customize your device based on your training needs. These settings are saved to an activity profile. For example, you can set time alerts for your racing profile and you can set an Auto Lap position trigger for your mountain biking profile.

Customizing the Data Pages

You can customize data pages for each activity profile ([Profiles, page 11](#)).

- 1 From the home screen, select  > **Activity Profiles**.
- 2 Select a profile.
- 3 Select **Training Pages**.
- 4 Select a data page.
- 5 If necessary, enable the data page.
- 6 Select the number of data fields you want to see on the page.
- 7 Select .
- 8 Select a data field to change it.
- 9 Select .

Using Auto Pause

You can use the Auto Pause feature to pause the timer automatically when you stop moving or when your speed drops below a specified value. This feature is helpful if your ride includes stop lights or other places where you need to slow down or stop.

NOTE: History is not recorded while the timer is stopped or paused.

- 1 From the home screen, select  > **Activity Profiles**.
- 2 Select a profile.
- 3 Select **Auto Pause > Auto Pause Mode**.

- 4 Select an option:
 - Select **When Stopped** to pause the timer automatically when you stop moving.
 - Select **Custom Speed** to pause the timer automatically when your speed drops below a specified value.
- 5 If necessary, customize optional time data fields (*Customizing the Data Pages*, page 11).

The Time - Elapsed data field displays the entire time including paused time.

Marking Laps by Position

You can use Auto Lap to automatically mark the lap at a specific position. This feature is helpful for comparing your performance over different parts of a ride (for example, a long climb or training sprints). During courses, use the By Position option to trigger laps at all of the lap positions saved in the course.

- 1 From the home screen, select **⌘ > Activity Profiles**.
- 2 Select a profile.
- 3 Select **Auto Lap > Auto Lap Trigger > By Position > Lap At**.
- 4 Select an option:
 - Select **Lap Press Only** to trigger the lap counter each time you select **⏪** and each time you pass any of those locations again.
 - Select **Start and Lap** to trigger the lap counter at the GPS location where you select **▶** and at any location during the ride where you select **⏪**.
 - Select **Mark and Lap** to trigger the lap counter at a specific GPS location marked before the ride and at any location during the ride where you select **⏪**.
- 5 If necessary, customize the lap data fields (*Customizing the Data Pages*, page 11).

Marking Laps by Distance

You can use Auto Lap to automatically mark the lap at a specific distance. This feature is helpful for comparing your performance over different parts of a ride (for example, every 10 miles or 40 kilometers).

- 1 From the home screen, select **⌘ > Activity Profiles**.
- 2 Select a profile.
- 3 Select **Auto Lap > Auto Lap Trigger > By Distance > Lap At**.
- 4 Enter a value.
- 5 If necessary, customize the lap data fields (*Customizing the Data Pages*, page 11).

Using Auto Scroll

You can use the auto scroll feature to automatically cycle through all of the training data pages while the timer is running.

- 1 From the home screen, select **⌘ > Activity Profiles**.
- 2 Select a profile.
- 3 Select **Auto Scroll > Auto Scroll Speed**.
- 4 Select a display speed.

Changing the Start Notice

This feature automatically detects when your device has acquired satellites and is moving. It is a reminder to start the timer so you can record your ride data.

- 1 From the home screen, select **⌘ > Activity Profiles**.
- 2 Select a profile.
- 3 Select **Start Notice > Start Notice Mode**.
- 4 Select an option:
 - Select **Once**.

- Select **Repeat > Repeat Delay** to change the amount of time to delay the reminder.

System Settings

Select **⌘ > System**.

- GPS Settings (*GPS Settings*, page 12)
- Display Settings (*Display Settings*, page 12)
- Data Recording Settings (*Data Recording Settings*, page 13)
- Unit Settings (*Changing the Units of Measure*, page 13)
- Configuration Settings (*Changing the Configuration Settings*, page 13)
- Language Settings (*Changing the Device Language*, page 13)
- Tone Settings (*Setting the Device Tones*, page 13)

GPS Settings

Training Indoors

You can turn GPS off when you are training indoors or to save battery life.

From the home screen, select **⌘ > System > GPS > GPS Mode > Off**.

When GPS is off, speed and distance are not available unless you have an optional sensor that sends speed and distance data to the device (such as the GSC 10). The next time you turn on the device, it will search for satellite signals again.

Setting Your Elevation

If you have accurate elevation data for your present location, you can manually calibrate the altimeter on your device.

- 1 From the home screen, select **⌘ > System > GPS > Set Elevation**.
- 2 Enter the elevation, and select **✓**.

Viewing Satellites

The satellite page shows your current GPS satellite information. For more information about GPS, go to www.garmin.com/aboutGPS.

From the home screen, select **⌘ > System > GPS > View Satellites**.

GPS accuracy appears at the bottom of the page. The green bars represent the strength of each satellite signal received (the number of the satellite appears below each bar).

Changing the Satellite Settings

By default, the Edge connects to GPS and GLONASS satellites for increased performance in challenging environments and faster position acquisition. You can set the device to use only GPS satellites to increase battery life.

- 1 From the home screen, select **⌘ > System > GPS > GPS Mode**.
- 2 Select an option:
 - For increased performance, select **GPS+GLONASS**.
 - For increased battery life, select **GPS Only**.

Display Settings

Select **⌘ > System > Display**.

Backlight Timeout: Adjusts the length of time before the backlight turns off (*Using the Backlight*, page 2).

Color Mode: Sets the device to display day or night colors. You can select Auto to allow the device to automatically set day or night colors based on the time of day.

Screen Capture: Allows you to save the image on the device screen.

Calibrate Screen: Aligns the screen to properly respond to touches (*Calibrating the Touchscreen*, page 15).

Data Recording Settings

Select **☰** > **System** > **Data Recording**.

Recording Interval: Controls how the device records activity data. Smart records key points where you change direction, speed, or heart rate. 1 Sec. records points every second. It creates a very detailed record of your activity and increases the size of the activity.

Data Averaging: Controls whether the device includes zero values for cadence and power data that occur when you are not pedaling.

Changing the Units of Measure

You can customize units of measure for distance and speed, elevation, temperature, weight, position format, and time format.

- 1 Select **☰** > **System** > **Units**.
- 2 Select a measurement type.
- 3 Select a unit of measure for the setting.

Changing the Configuration Settings

You can modify all of the settings you configured in the initial setup.

- 1 Select **☰** > **System** > **Device Reset** > **Initial Setup**.
- 2 Follow the on-screen instructions.

Changing the Device Language

From the home screen, select **☰** > **System** > **Language**.

Setting the Device Tones

From the home screen, select **☰** > **System** > **Tones**.

Time Zones

Each time you turn on the device and acquire satellites, the device automatically detects your time zone and the current time of day.

Device Information

Specifications

Edge Specifications

Battery type	Rechargeable, built-in lithium-ion battery
Battery life	20 hours, GPS only 15 hours, GPS and GLONASS 6 hours, GPS and GLONASS with 100% backlight
Water resistance	IPX7
Operating temperature range	From -4° to 158°F (from -20° to 70°C)
Charging temperature range	From 32° to 113°F (from 0° to 45°C)
Bands (O-rings) for the standard mount	Two sizes: <ul style="list-style-type: none">• AS568-125 Inner diameter: 1.3 in. Outer diameter: 1.5 in. Cross section: 0.1 in.• AS568-131 Inner diameter: 1.7 in. Outer diameter: 1.9 in. Cross section: 0.1 in. NOTE: Use Ethylene Propylene Diene Monomer (EPDM) replacement bands only. Go to http://buy.garmin.com , or contact your Garmin dealer.

About IPX7

NOTICE

The device is water resistant to IEC Standard 60529 IPX7. It can withstand immersion in 1 meter of water for 30 minutes.

Prolonged submersion can cause damage to the device. After submersion, be certain to wipe dry and air dry the device before using or charging.

Heart Rate Monitor Specifications

Battery type	User-replaceable CR2032, 3 V
Battery life	Up to 4.5 yr. at 1 hr./day
Water resistance	3 ATM ¹ NOTE: This product does not transmit heart rate data while swimming.
Operating temperature range	From -5° to 50°C (from 23° to 122°F)
Wireless frequency/protocol	2.4 GHz ANT+ wireless communications protocol

Speed Sensor and Cadence Sensor Specifications

Battery type	User-replaceable CR2032, 3 V
Battery life	Approximately 12 months (1 hour per day)
Operating temperature range	From -20° to 60°C (from -4° to 140°F)
Wireless frequency/protocol	2.4 GHz ANT+ wireless communications protocol
Water rating	1 ATM ²

GSC 10 Specifications

Battery type	User-replaceable CR2032, 3 volts
Battery life	Approximately 1.4 years (1 hour per day)
Water resistance	IPX7
Operating temperature range	From 5° to 158°F (from -15° to 70°C)
Radio frequency/protocol	2.4 GHz ANT+ wireless communications protocol

Device Care

NOTICE

Do not store the device where prolonged exposure to extreme temperatures can occur, because it can cause permanent damage.

Never use a hard or sharp object to operate the touchscreen, or damage may result.

Avoid chemical cleaners, solvents, and insect repellents that can damage plastic components and finishes.

Secure the weather cap tightly to prevent damage to the USB port.

Cleaning the Device

- 1 Wipe the device using a cloth dampened with a mild detergent solution.
- 2 Wipe it dry.

Caring for the Heart Rate Monitor

NOTICE

You must unsnap and remove the module before washing the strap.

A build up of sweat and salt on the strap can decrease the ability of the heart rate monitor to report accurate data.

- Go to www.garmin.com/HRMcare for detailed washing instructions.
- Rinse the strap after every use.

¹ The device withstands pressure equivalent to a depth of 30 m. For more information, go to www.garmin.com/waterrating.

² The device withstands pressure equivalent to a depth of 10 m. For more information, go to www.garmin.com/waterrating.

- Machine wash the strap after every seven uses.
- Do not put the strap in a dryer.
- When drying the strap, hang it up or lay it flat.
- To prolong the life of your heart rate monitor, unsnap the module when not in use.

User Replaceable Batteries

WARNING

Do not use a sharp object to remove batteries.

Keep the battery away from children.

Never put batteries in mouth. If swallowed, contact your physician or local poison control center.

Replaceable cell batteries may contain perchlorate material. Special handling may apply. See www.dtsc.ca.gov/hazardouswaste/perchlorate.

CAUTION

Contact your local waste disposal department to properly recycle the batteries.

Replacing the Heart Rate Monitor Battery

- 1 Use a small Phillips screwdriver to remove the four screws on the back of the module.
- 2 Remove the cover and battery.



- 3 Wait 30 seconds.
- 4 Insert the new battery with the positive side facing up.
NOTE: Do not damage or lose the O-ring gasket.
- 5 Replace the back cover and the four screws.
NOTE: Do not overtighten.



After you replace the heart rate monitor battery, you may need to pair it with the device again.

Replacing the Speed Sensor or Cadence Sensor Battery

The LED flashes red to indicate a low battery level after two revolutions.

- 1 Locate the circular battery cover  on the back of the sensor.



- 2 Twist the cover counter-clockwise until the marker points to unlocked and the cover is loose enough to remove.
- 3 Remove the cover and the battery .
TIP: You can use a piece of tape  or a magnet to remove the battery from the cover.



- 4 Wait 30 seconds.
- 5 Insert the new battery into the cover, observing polarity.
NOTE: Do not damage or lose the O-ring gasket.
- 6 Twist the cover clockwise until the marker points to locked.
NOTE: The LED flashes red and green for a few seconds after battery replacement. When the LED flashes green and then stops flashing, the device is active and ready to send data.

Replacing the GSC 10 Battery

- 1 Locate the circular battery cover  on the side of the GSC 10.



- 2 Use a coin to twist the cover counter-clockwise until it is loose enough to remove (the arrow points to unlocked).
- 3 Remove the cover and the battery .
- 4 Wait 30 seconds.
- 5 Insert the new battery with the positive side facing up.
NOTE: Do not damage or lose the O-ring gasket.
- 6 Use a coin to twist the cover clockwise back into place (the arrow points to locked).

After you replace the GSC 10 battery, you must pair the GSC 10 with the device again.

Troubleshooting

Resetting the Device

If the device stops responding, you may need to reset it. This does not erase any of your data or settings.

Hold  for 10 seconds.

The device resets and turns on.

Clearing User Data

You can restore all of the device settings to the factory default values.

NOTE: This deletes all user-entered information, but it does not delete your history.

- 1 Turn off the device.
- 2 Place your finger on the top left corner of the touchscreen.
- 3 While holding your finger on the touchscreen, turn on the device.
- 4 Select ✓.

Maximizing Battery Life

- Decrease the backlight (*Decreasing the Backlight*, page 15).
- Shorten the backlight timeout (*Adjusting the Backlight Timeout*, page 15).
- Select the **Smart** recording interval (*Data Recording Settings*, page 13).
- Turn on the **Auto Power Down** feature (*Using the Auto Power Down Feature*, page 15).
- Turn off the Bluetooth wireless feature (*Bluetooth Settings*, page 11).
- Select the **GPS Only** setting (*Changing the Satellite Settings*, page 12).

Decreasing the Backlight

- 1 Select ⏻ to open the status page.
- 2 Use – and + to adjust the brightness.

Adjusting the Backlight Timeout

You can decrease the backlight timeout to maximize the battery life.

- 1 Select ⏻ > **Backlight Timeout**.
- 2 Select an option.

Using the Auto Power Down Feature

This feature automatically turns off the device after 15 minutes of inactivity.

- 1 Select ✖ > **System** > **Auto Power Down**.
- 2 Select **On**.

Calibrating the Touchscreen

- 1 From the home screen, select ✖ > **System** > **Display** > **Calibrate Screen**.
- 2 Follow the on-screen instructions.

Locking the Touchscreen

You can lock the screen to prevent inadvertent screen touches.

- 1 Select ⏻.
- 2 Select 🔒.

Unlocking the Touchscreen

- 1 Select ⏻.
- 2 Select 🔒.

Getting More Information

You can find more information about this product on the Garmin website.

- Go to www.garmin.com/intosports.
- Go to www.garmin.com/learningcenter.
- Go to <http://buy.garmin.com>, or contact your Garmin dealer for information about optional accessories and replacement parts.

Temperature Readings

The device may display temperature readings that are higher than the actual air temperature if the device is placed in direct sunlight, held in your hand, or is charging with an external

battery pack. Also, the device will take some time to adjust to significant changes in temperature.

Viewing Device Information

You can view the unit ID, software version, and license agreement.

From the home screen, select ✖ > **System** > **About**.

Updating the Software

NOTE: Updating the software does not erase any of your data or settings.

- 1 Connect your device to a computer using the USB cable.
- 2 Go to garmin.com/express.
- 3 Follow the on-screen instructions.

Appendix

Registering Your Device

Help us better support you by completing our online registration today.

- Go to garmin.com/express.
- Keep the original sales receipt, or a photocopy, in a safe place.

Data Fields

Some data fields require ANT+ accessories to display data.

Balance: The current left/right power balance.

Balance - 10s Avg.: The 10-second moving average of the left/right power balance.

Balance - 30s Avg.: The 30-second moving average of the left/right power balance.

Balance - 3s Avg.: The three-second moving average of the left/right power balance.

Balance - Avg.: The average left/right power balance for the current activity.

Balance - Lap: The average left/right power balance for the current lap.

Battery Level: The remaining battery power.

Battery Status: The remaining battery power of a bike light accessory.

Cadence: Cycling. The number of revolutions of the crank arm. Your device must be connected to a cadence accessory for this data to appear.

Cadence - Avg.: Cycling. The average cadence for the current activity.

Cadence - Lap: Cycling. The average cadence for the current lap.

Calories: The amount of total calories burned.

Calories - Fat: The amount of fat calories burned. Requires a New Leaf[®] assessment.

Calories to Go: During a workout, the remaining calories when you are using a calorie target.

Course Pt. Dist.: The remaining distance to the next point on the course.

Di2 Battery Level: The remaining battery power of a Di2 sensor.

Dist. - Lap: The distance traveled for the current lap.

Dist. - Last Lap: The distance traveled for the last completed lap.

Dist. to Dest.: The remaining distance to the final destination. You must be navigating for this data to appear.

- Dist. to Go:** During a workout or course, the remaining distance when you are using a distance target.
- Dist. to Next:** The remaining distance to the next waypoint on the route. You must be navigating for this data to appear.
- Distance:** The distance traveled for the current track or activity.
- Distance Ahead:** The distance ahead or behind the Virtual Partner.
- Elevation:** The altitude of your current location above or below sea level.
- ETA at Destination:** The estimated time of day when you will reach the final destination (adjusted to the local time of the destination). You must be navigating for this data to appear.
- ETA at Next:** The estimated time of day when you will reach the next waypoint on the route (adjusted to the local time of the waypoint). You must be navigating for this data to appear.
- Front Gear:** The front bike gear from a gear position sensor.
- Gear Ratio:** The number of teeth on the front and rear bike gears, as detected by a gear position sensor.
- Gears:** The front and rear bike gears from a gear position sensor.
- GPS Accuracy:** The margin of error for your exact location. For example, your GPS location is accurate to within +/- 3.65 m (12 ft.).
- GPS Signal Strength:** The strength of the GPS satellite signal.
- Grade:** The calculation of rise (elevation) over run (distance). For example, if for every 3 m (10 ft.) you climb you travel 60 m (200 ft.), the grade is 5%.
- Heading:** The direction you are moving.
- Heart Rate:** Your heart rate in beats per minute (bpm). Your device must be connected to a compatible heart rate monitor.
- HR - %HRR:** The percentage of heart rate reserve (maximum heart rate minus resting heart rate).
- HR - %Max.:** The percentage of maximum heart rate.
- HR - Avg.:** The average heart rate for the current activity.
- HR - Avg. %HRR:** The average percentage of heart rate reserve (maximum heart rate minus resting heart rate) for the current activity.
- HR - Avg. %Max.:** The average percentage of maximum heart rate for the current activity.
- HR Graph:** A line graph showing your current heart rate zone (1 to 5).
- HR - Lap:** The average heart rate for the current lap.
- HR - Lap %HRR:** The average percentage of heart rate reserve (maximum heart rate minus resting heart rate) for the current lap.
- HR - Lap %Max.:** The average percentage of maximum heart rate for the current lap.
- HR - Last Lap:** The average heart rate for the last completed lap.
- HR to Go:** During a workout, the amount you are above or below the heart rate target.
- HR Zone:** The current range of your heart rate (1 to 5). The default zones are based on your user profile and maximum heart rate (220 minus your age).
- Laps:** The number of laps completed for the current activity.
- Lights Connected:** The number of connected lights.
- Location at Dest.:** The last point on the route or course.
- Location at Next:** The next point on the route or course.
- Odometer:** A running tally of distance traveled for all trips. This total does not clear when resetting the trip data.
- PCO:** The platform center offset. Platform center offset is the location on the pedal platform where force is applied.
- PCO - Avg.:** The average platform center offset for the current activity.
- PCO - Lap:** The average platform center offset for the current lap.
- Pedal Smoothness:** The measurement of how evenly a rider is applying force to the pedals throughout each pedal stroke.
- Power:** The current power output in watts. Your device must be connected to a compatible power meter.
- Power - %FTP:** The current power output as a percentage of functional threshold power.
- Power - 10s Avg.:** The 10-second moving average of power output.
- Power - 30s Avg.:** The 30-second moving average of power output.
- Power - 3s Avg.:** The 3-second moving average of power output.
- Power - Avg.:** The average power output for the current activity.
- Power - IF:** The Intensity Factor™ for the current activity.
- Power - kJ:** The accumulated work performed (power output) in kilojoules.
- Power - Lap:** The average power output for the current lap.
- Power - Lap Max.:** The top power output for the current lap.
- Power - Last Lap:** The average power output for the last completed lap.
- Power - Max.:** The top power output for the current activity.
- Power - NP:** The Normalized Power™ for the current activity.
- Power - NP Lap:** The average Normalized Power for the current lap.
- Power - NP Last Lap:** The average Normalized Power for the last completed lap.
- Power Phase - L.:** The current power phase angle for the left leg. Power phase is the pedal stroke region where positive power is produced.
- Power Phase - L. Avg.:** The average power phase angle for the left leg for the current activity.
- Power Phase - L. Lap:** The average power phase angle for the left leg for the current lap.
- Power Phase - L. Peak:** The current power phase peak angle for the left leg. Power phase peak is the angle range over which the rider produces the peak portion of the driving force.
- Power Phase - L Pk. Avg.:** The average power phase peak angle for the left leg for the current activity.
- Power Phase - L Pk. Lap:** The average power phase peak angle for the left leg for the current lap.
- Power Phase - R.:** The current power phase angle for the right leg. Power phase is the pedal stroke region where positive power is produced.
- Power Phase - R. Avg.:** The average power phase angle for the right leg for the current activity.
- Power Phase - R. Lap:** The average power phase angle for the right leg for the current lap.
- Power Phase - R. Peak:** The current power phase peak angle for the right leg. Power phase peak is the angle range over which the rider produces the peak portion of the driving force.
- Power Phase - R Pk. Avg.:** The average power phase peak angle for the right leg for the current activity.
- Power Phase - R Pk. Lap:** The average power phase peak angle for the right leg for the current lap.
- Power - TSS:** The Training Stress Score™ for the current activity.
- Power - watts/kg:** The amount of power output in watts per kilogram.

Power Zone: The current range of power output (1 to 7) based on your FTP or custom settings.

Rear Gear: The rear bike gear from a gear position sensor.

Reps to Go: During a workout, the remaining repetitions.

Speed: The current rate of travel.

Speed - Avg.: The average speed for the current activity.

Speed - Lap: The average speed for the current lap.

Speed - Last Lap: The average speed for the last completed lap.

Speed - Max.: The top speed for the current activity.

Speed Zone: The current range of your speed (1 to 10). Zones can be set in Garmin Connect.

Sunrise: The time of sunrise based on your GPS position.

Sunset: The time of sunset based on your GPS position.

Temperature: The temperature of the air. Your body temperature affects the temperature sensor.

Time: The stopwatch time for the current activity.

Time Ahead: The time ahead or behind the Virtual Partner.

Time - Avg. Lap: The average lap time for the current activity.

Time - Elapsed: The total time recorded. For example, if you start the timer and run for 10 minutes, then stop the timer for 5 minutes, then start the timer and run for 20 minutes, your elapsed time is 35 minutes.

Time - Lap: The stopwatch time for the current lap.

Time - Last Lap: The stopwatch time for the last completed lap.

Time of Day: The time of day based on your current location and time settings (format, time zone, daylight saving time).

Time Seated: The time spent seated while pedaling for the current activity.

Time Seated Lap: The time spent seated while pedaling for the current lap.

Time Standing: The time spent standing while pedaling for the current activity.

Time Standing Lap: The time spent standing while pedaling for the current lap.

Time to Dest.: The estimated time remaining before you reach the destination. You must be navigating for this data to appear.

Time to Go: During a workout, the remaining time when you are using a time target.

Time to Next: The estimated time remaining before you reach the next waypoint in the route. You must be navigating for this data to appear.

Torque Effectiveness: The measurement of how efficiently a rider is pedaling.

Total Ascent: The total elevation distance ascended since the last reset.

Total Descent: The total elevation distance descended since the last reset.

Vertical Speed: The rate of ascent or descent over time.

VS - 30s Avg.: The 30-second moving average of vertical speed.

Heart Rate Zone Calculations

Zone	% of Maximum Heart Rate	Perceived Exertion	Benefits
1	50–60%	Relaxed, easy pace, rhythmic breathing	Beginning-level aerobic training, reduces stress
2	60–70%	Comfortable pace, slightly deeper breathing, conversation possible	Basic cardiovascular training, good recovery pace
3	70–80%	Moderate pace, more difficult to hold conversation	Improved aerobic capacity, optimal cardiovascular training
4	80–90%	Fast pace and a bit uncomfortable, breathing forceful	Improved anaerobic capacity and threshold, improved speed
5	90–100%	Sprinting pace, unsustainable for long period of time, labored breathing	Anaerobic and muscular endurance, increased power

Wheel Size and Circumference

The wheel size is marked on both sides of the tire. This is not a comprehensive list. You can also use one of the calculators available on the Internet.

To modify your bike profile, see [Updating Your Bike Profile](#), page 11.

Wheel Size	L (mm)
12 × 1.75	935
14 × 1.5	1020
14 × 1.75	1055
16 × 1.5	1185
16 × 1.75	1195
18 × 1.5	1340
18 × 1.75	1350
20 × 1.75	1515
20 × 1-3/8	1615
22 × 1-3/8	1770
22 × 1-1/2	1785
24 × 1	1753
24 × 3/4 Tubular	1785
24 × 1-1/8	1795
24 × 1-1/4	1905
24 × 1.75	1890
24 × 2.00	1925
24 × 2.125	1965
26 × 7/8	1920
26 × 1(59)	1913
26 × 1(65)	1952
26 × 1.25	1953
26 × 1-1/8	1970
26 × 1-3/8	2068
26 × 1-1/2	2100
26 × 1.40	2005
26 × 1.50	2010
26 × 1.75	2023
26 × 1.95	2050
26 × 2.00	2055
26 × 2.10	2068
26 × 2.125	2070
26 × 2.35	2083

Wheel Size	L (mm)
26 × 3.00	2170
27 × 1	2145
27 × 1-1/8	2155
27 × 1-1/4	2161
27 × 1-3/8	2169
650 × 35A	2090
650 × 38A	2125
650 × 38B	2105
700 × 18C	2070
700 × 19C	2080
700 × 20C	2086
700 × 23C	2096
700 × 25C	2105
700 × 28C	2136
700 × 30C	2170
700 × 32C	2155
700C Tubular	2130
700 × 35C	2168
700 × 38C	2180
700 × 40C	2200

Software License Agreement

BY USING THE DEVICE, YOU AGREE TO BE BOUND BY THE TERMS AND CONDITIONS OF THE FOLLOWING SOFTWARE LICENSE AGREEMENT. PLEASE READ THIS AGREEMENT CAREFULLY.

Garmin Ltd. and its subsidiaries (“Garmin”) grant you a limited license to use the software embedded in this device (the “Software”) in binary executable form in the normal operation of the product. Title, ownership rights, and intellectual property rights in and to the Software remain in Garmin and/or its third-party providers.

You acknowledge that the Software is the property of Garmin and/or its third-party providers and is protected under the United States of America copyright laws and international copyright treaties. You further acknowledge that the structure, organization, and code of the Software, for which source code is not provided, are valuable trade secrets of Garmin and/or its third-party providers and that the Software in source code form remains a valuable trade secret of Garmin and/or its third-party providers. You agree not to decompile, disassemble, modify, reverse assemble, reverse engineer, or reduce to human readable form the Software or any part thereof or create any derivative works based on the Software. You agree not to export or re-export the Software to any country in violation of the export control laws of the United States of America or the export control laws of any other applicable country.

Index

A

accessories **6, 8, 15**
alerts **3**
altimeter, calibrating **12**
ANT+ sensors **2, 6, 8**
 pairing **9**
applications **9**
 smartphone **10**
Auto Lap **12**
Auto Pause **11**
auto scroll **12**

B

backlight **2, 12, 15**
bands **13**
battery
 charging **1**
 maximizing **15**
 replacing **14**
 type **1**
Bluetooth technology **9–11**
brightness **15**

C

cadence **7, 8**
 alerts **3**
calendar **4**
calibrating
 power meter **8**
 touchscreen **15**
calorie, alerts **3**
charging the device **1**
cleaning the device **13**
computer, connecting **10**
courses **4, 5**
 deleting **5**
 editing **4, 5**
 loading **4**
customizing the device **11**

D

data
 storing **9**
 transferring **9, 10**
data averaging **8**
data fields **11, 15**
data recording **10, 13**
deleting
 all user data **10, 14**
 history **10**
device
 care **13**
 registration **15**
 resetting **14**
display settings **12**
distance, alerts **3**

E

elevation **12**

F

files, transferring **10**

G

Garmin Connect **3–5, 9**
Garmin Index **9**
GLONASS **12**
GPS
 satellite page **12**
 signal **2**
 stopping **12**
GSC 10 **7, 8, 13, 14**

H

heart rate
 alerts **3**
 monitor **6, 7, 13, 14**
 zones **6, 7, 17**
heart rate monitor, pairing **9**

history **3, 9**
 deleting **10**
 sending to computer **9**

I

icons **2**
initial setup **13**
installing **1, 7**

K

keys **2**

L

language **13**
laps **2**
lifetime athlete **11**
locking, screen **15**

M

maps **5**
mounting the device **1**

O

O-rings **13**
on-screen buttons **2**

P

pairing **2**
 heart rate monitor **9**
 smartphone **10**
pairing ANT+ sensors **9**
pedals **8**
personal records **6, 10**
 restoring **6**
power **8**
 zones **8**
power (force)
 alerts **3**
 meters **8**
power meter **8**
power save **15**
product registration **15**
profiles **11**
 bike **11**
 user **11**

R

registering the device **15**
replacing the battery **14**
resetting the device **14**
restoring, settings **14**

S

satellite page **12**
satellite signals **2**
saving activities **3**
screen. **12** See *also* backlight
 brightness **15**
 locking **15**
segments **5, 6**
 deleting **6**
settings **2, 11–13**
 device **13**
smart recording **10**
smartphone **2, 9, 11**
 applications **10**
 pairing **10**
software
 updating **15**
 version **15**
software license agreement **15, 18**
specifications **13**
speed, zones **6**
speed and cadence sensors **7, 14**
start notice message **12**
storing data **9, 10**
system settings **12**

T

temperature **15**
time, alerts **3**
time settings **13**

time zones **13**
timer **2, 3, 9**
tones **13**
touchscreen, calibrating **15**
training, plans **4**
training pages, viewing **3**
troubleshooting **7, 14, 15**

U

unit ID **15**
units of measure **13**
updating software **15**
USB, disconnecting **10**
user data, deleting **10**
user profile **2, 11**

V

Virtual Partner **4, 5**

W

water resistance **13**
weight scale **9**
wheel sizes **17**
workouts **3, 4**
 creating **3**
 deleting **4**
 editing **4**
 loading **3**

Z

zones
 power **8**
 speed **6**
 time **13**

