

GARMIN

G500

Pilot's
Guide



© 2012 Garmin Ltd. or its subsidiaries. All rights reserved.

This manual reflects the operation of System Software version 6.11, or later. Some differences in operation may be observed when comparing the information in this manual to later software versions.

Garmin International, Inc., 1200 East 151st Street, Olathe, KS 66062, U.S.A.
Tel: 913/397.8200 Fax: 913/397.8282

Garmin AT, Inc., 2345 Turner Road SE, Salem, OR 97302, U.S.A.
Tel: 503/391.3411 Fax 503/364.2138

Garmin (Europe) Ltd., Liberty House, Bulls Copse Road, Hounslow Business Park, Southampton, SO40 9RB, U.K.
Tel. +44 (0) 870 850 1243 Fax +44 (0) 238 052 4004

Garmin Corporation, No. 68, Zhangshu 2nd Road, Xizhi Dist., New Taipei City 221, Taiwan (R.O.C.)
Tel: 886/02.2642.9199 Fax: 886/02.2642.9099

Garmin Singapore Pte. Ltd., 46 East Coast Road, #05-06 Eastgate, Singapore 428766
Tel : (65) 63480378 Fax : (65) 63480278

At Garmin, we value your opinion. For comments about this guide, please e-mail:
Techpubs.Salem@Garmin.com

www.garmin.com

Except as expressly provided herein, no part of this manual may be reproduced, copied, transmitted, disseminated, downloaded or stored in any storage medium, for any purpose without the express written permission of Garmin. Garmin hereby grants permission to download a single copy of this manual and of any revision to this manual onto a hard drive or other electronic storage medium to be viewed for personal use, provided that such electronic or printed copy of this manual or revision must contain the complete text of this copyright notice and provided further that any unauthorized commercial distribution of this manual or any revision hereto is strictly prohibited.

Garmin®, FliteCharts®, and SafeTaxi® are registered trademarks of Garmin Ltd. or its subsidiaries. Garmin SVT™ is a trademark of Garmin Ltd. or its subsidiaries. These trademarks may not be used without the express permission of Garmin.

NavData® is a registered trademark of Jeppesen, Inc.; SkyWatch® is a registered trademark of L-3 Avionics Systems; Sirius and XM are trademarks of Sirius XM Radio Inc.; Iridium® is a registered trademark of Iridium Communications Inc.; United States radar data provided by NOAA; Canadian radar data provided by Environment Canada; European radar data collected and provided by Météo France.

August 2012

Printed in the U.S.A.

AVIATION LIMITED WARRANTY

All Garmin avionics products are warranted to be free from defects in materials or workmanship for: two years from the date of purchase for new Remote-Mount and Panel-Mount products; one year from the date of purchase for new portable products and any purchased newly-overhauled products; six months for newly-overhauled products exchanged through a Garmin Authorized Service Center; and 90 days for factory repaired or newly-overhauled products exchanged at Garmin in lieu of repair. Within the applicable period, Garmin will, at its sole option, repair or replace any components that fail in normal use. Such repairs or replacement will be made at no charge to the customer for parts or labor, provided that the customer shall be responsible for any transportation cost. This warranty does not apply to: (i) cosmetic damage, such as scratches, nicks and dents; (ii) consumable parts, such as batteries, unless product damage has occurred due to a defect in materials or workmanship; (iii) damage caused by accident, abuse, misuse, water, flood, fire, or other acts of nature or external causes; (iv) damage caused by service performed by anyone who is not an authorized service provider of Garmin; or (v) damage to a product that has been modified or altered without the written permission of Garmin. In addition, Garmin reserves the right to refuse warranty claims against products or services that are obtained and/or used in contravention of the laws of any country.

THE WARRANTIES AND REMEDIES CONTAINED HEREIN ARE EXCLUSIVE AND IN LIEU OF ALL OTHER WARRANTIES, WHETHER EXPRESS, IMPLIED OR STATUTORY, INCLUDING ANY LIABILITY ARISING UNDER ANY WARRANTY OF MERCHANTABILITY OR FITNESS FOR A PARTICULAR PURPOSE, STATUTORY OR OTHERWISE. THIS WARRANTY GIVES YOU SPECIFIC LEGAL RIGHTS, WHICH MAY VARY FROM STATE TO STATE.

IN NO EVENT SHALL GARMIN BE LIABLE FOR ANY INCIDENTAL, SPECIAL, INDIRECT OR CONSEQUENTIAL DAMAGES, WHETHER RESULTING FROM THE USE, MISUSE OR INABILITY TO USE THE PRODUCT OR FROM DEFECTS IN THE PRODUCT. SOME STATES DO NOT ALLOW THE EXCLUSION OF INCIDENTAL OR CONSEQUENTIAL DAMAGES, SO THE ABOVE LIMITATIONS MAY NOT APPLY TO YOU.

Garmin retains the exclusive right to repair or replace (with a new or newly-overhauled replacement product) the product or software or offer a full refund of the purchase price at its sole discretion. SUCH REMEDY SHALL BE YOUR SOLE AND EXCLUSIVE REMEDY FOR ANY BREACH OF WARRANTY.

Online Auction Purchases: Products purchased through online auctions are not eligible for warranty coverage. Online auction confirmations are not accepted for warranty verification. To obtain warranty service, an original or copy of the sales receipt from the original retailer is required. Garmin will not replace missing components from any package purchased through an online auction.

International Purchases: A separate warranty may be provided by international distributors for devices purchased outside the United States depending on the country. If applicable, this warranty is provided by the local in-country distributor and this distributor provides local service for your device. Distributor warranties are only valid in the area of intended distribution. Devices purchased in the United States or Canada must be returned to the Garmin service center in the United Kingdom, the United States, Canada, or Taiwan for service.

To obtain warranty service, contact your local Garmin Authorized Service Center. For assistance in locating a Service Center near you, visit the Garmin web site at <http://www.garmin.com> or contact Garmin Customer Service at 866-739-5687.



WARNING: *Navigation and terrain separation must NOT be predicated upon the use of the terrain function. The G500 Terrain Proximity feature is NOT intended to be used as a primary reference for terrain avoidance and does not relieve the pilot from the responsibility of being aware of surroundings during flight. The Terrain Proximity feature is only to be used as an aid for terrain avoidance and is not certified for use in applications requiring a certified terrain awareness system. Terrain data is obtained from third party sources. Garmin is not able to independently verify the accuracy of the terrain data.*



WARNING: *The displayed minimum safe altitudes (MSAs) are only advisory in nature and should not be relied upon as the sole source of obstacle and terrain avoidance information. Always refer to current aeronautical charts for appropriate minimum clearance altitudes.*



WARNING: *The Garmin G500 has a very high degree of functional integrity. However, the pilot must recognize that providing monitoring and/or self-test capability for all conceivable system failures is not practical. Although unlikely, it may be possible for erroneous operation to occur without a fault indication shown by the G500. It is thus the responsibility of the pilot to detect such an occurrence by means of cross-checking with all redundant or correlated information available in the cockpit.*



WARNING: *The altitude calculated by GPS receivers is geometric height above Mean Sea Level and could vary significantly from the altitude displayed by pressure altimeters, such as the output from the GDC 74A Air Data Computer, or other altimeters in aircraft. GPS altitude should never be used for vertical navigation. Always use pressure altitude displayed by the G500 PFD or other pressure altimeters in aircraft.*



WARNING: *Do not use outdated database information. Databases used in the G500 system must be updated regularly in order to ensure that the information remains current. Pilots using an outdated database do so entirely at their own risk.*



WARNING: *Do not use basemap (land and water data) information for primary navigation. Basemap data is intended only to supplement other approved navigation data sources and should be considered as an aid to enhance situational awareness.*



WARNING: Traffic information shown on the G500 Multi Function Display is provided as an aid in visually acquiring traffic. Pilots must maneuver the aircraft based only upon ATC guidance or positive visual acquisition of conflicting traffic.



WARNING: Do not use data link weather information for maneuvering in, near, or around areas of hazardous weather. Information contained within data link weather products may not accurately depict current weather conditions.



WARNING: Do not use the indicated data link weather product age to determine the age of the weather information shown by the data link weather product. Due to time delays inherent in gathering and processing weather data for data link transmission, the weather information shown by the data link weather product may be significantly older than the indicated weather product age.



WARNING: For safety reasons, G500 operational procedures must be learned on the ground.



WARNING: To reduce the risk of unsafe operation, carefully review and understand all aspects of the G500 Pilot's Guide. Thoroughly practice basic operation prior to actual use. During flight operations, carefully compare indications from the G500 to all available navigation sources, including the information from other NAVAIDs, visual sightings, charts, etc. For safety purposes, always resolve any discrepancies before continuing navigation.



WARNING: Exceeding 200 deg/second in pitch or roll may invalidate AHRS attitude provided to the G500. Exceeding 450 KIAS may invalidate ADC information provided to the G500.



WARNING: Because of anomalies in the earth's magnetic field, operating the G500 within the following areas could result in loss of reliable attitude and heading indications. North of 70° North latitude and south of 70° South latitude. An area north of 65° North latitude and between longitude 75° West and 120° West. An area north of 70° North latitude and between longitude 70° West and 128° West. An area north of 70° North latitude and between longitude 85° East and 114° West. An area south of 55° South latitude between longitude 120° East and 165° East.



WARNING: Do not use Terrain-SVT information for primary terrain avoidance. Terrain-SVT is intended only to enhance situational awareness.



CAUTION: The United States government operates the Global Positioning System and is solely responsible for its accuracy and maintenance. The GPS system is subject to changes which could affect the accuracy and performance of all GPS equipment. Portions of the Garmin G500 utilize GPS as a precision electronic NAVigation AID (NAVAID). Therefore, as with all NAVAIDS, information presented by the G500 can be misused or misinterpreted and, therefore, become unsafe.



CAUTION: The Garmin G500 does not contain any user-serviceable parts. Repairs should only be made by an authorized Garmin service center. Unauthorized repairs or modifications could void both the warranty and the pilot's authority to operate this device under FAA/FCC regulations.



CAUTION: The G500 PFD and MFD displays use a lens coated with a special anti-reflective coating that is very sensitive to skin oils, waxes, and abrasive cleaners. CLEANERS CONTAINING AMMONIA WILL HARM THE ANTI-REFLECTIVE COATING. It is very important to clean the lens using a clean, lint-free cloth and an eyeglass lens cleaner that is specified as safe for anti-reflective coatings.



CAUTION: When interfaced with a GSR56 Iridium transceiver only one SD card may be present in the GDU620 and it must be in the lower slot.



NOTE: Do not rely solely upon data link services to provide Temporary Flight Restriction (TFR) information. Always confirm TFR information through official sources such as Flight Service Stations or Air Traffic Control.



NOTE: Interference from GPS repeaters operating inside nearby hangars can cause an intermittent loss of attitude and heading displays while the aircraft is on the ground. Moving the aircraft more than 100 feet away from the source of the interference should alleviate the condition.



NOTE: All visual depictions contained within this document, including screen images of the G500 bezel and displays, are subject to change and may not reflect the most current GDU 620 system. Depictions of equipment may differ slightly from the actual equipment.



NOTE: This device complies with part 15 of the FCC Rules. Operation is subject to the following two conditions: (1) this device may not cause harmful interference, and (2) this device must accept any interference received, including interference that may cause undesired operation.



NOTE: Terrain data is not displayed when the aircraft latitude is greater than 75° North or 60° South.



NOTE: This product, its packaging, and its components contain chemicals known to the State of California to cause cancer, birth defects, or reproductive harm. This notice is being provided in accordance with California's Proposition 65. If you have any questions or would like additional information, please refer to our web site at www.garmin.com/prop65.



NOTE: Terrain-SVT is standard when the Garmin Synthetic Vision Technology™ (SVT) option is installed.



NOTE: Do not use SafeTaxi or Chartview functions as the basis for ground maneuvering. SafeTaxi and Chartview functions have not been qualified to be used as an airport moving map display (AMMD). SafeTaxi and Chartview are intended to improve pilot situational awareness during ground operations should only be used by the flight crew to orient themselves on the airport surface.

Record of Revisions

Part Number	Revision	Date	Description
190-01102-02	A	6/1/09	Production release
	B	6/17/09	Formatting changes
	C	11/19/10	Updates for SW Versions 4.00 and 5.00
	D	08/05/11	Updates for SW Version 6.00
	E	10/19/12	Updates for SW Version 6.11

AOPA Airport Directory

AOPA MEMBERSHIP PUBLICATIONS, INC. AND ITS RELATED ORGANIZATIONS (HEREINAFTER COLLECTIVELY "AOPA") EXPRESSLY DISCLAIM ALL WARRANTIES, WITH RESPECT TO THE AOPA INFORMATION INCLUDED IN THIS DATA, EXPRESS OR IMPLIED, INCLUDING, BUT NOT LIMITED TO, THE IMPLIED WARRANTIES OF MERCHANTABILITY AND FITNESS FOR A PARTICULAR PURPOSE. THE INFORMATION IS PROVIDED "AS IS" AND AOPA DOES NOT WARRANT OR MAKE ANY REPRESENTATIONS REGARDING ITS ACCURACY, RELIABILITY, OR OTHERWISE. UNDER NO CIRCUMSTANCES INCLUDING NEGLIGENCE, SHALL AOPA BE LIABLE FOR ANY INCIDENTAL, SPECIAL OR CONSEQUENTIAL DAMAGES THAT RESULT FROM THE USE OR INABILITY TO USE THE SOFTWARE OR RELATED DOCUMENTATION, EVEN IF AOPA OR AN AOPA AUTHORIZED REPRESENTATIVE HAS BEEN ADVISED OF THE POSSIBILITY OF SUCH DAMAGES. USER AGREES NOT TO SUE AOPA AND, TO THE MAXIMUM EXTENT ALLOWED BY LAW, TO RELEASE AND HOLD HARMLESS AOPA FROM ANY CAUSES OF ACTION, CLAIMS OR LOSSES RELATED TO ANY ACTUAL OR ALLEGED INACCURACIES IN THE INFORMATION. SOME JURISDICTIONS DO NOT ALLOW THE LIMITATION OR EXCLUSION OF IMPLIED WARRANTIES OR LIABILITY FOR INCIDENTAL OR CONSEQUENTIAL DAMAGES SO THE ABOVE LIMITATIONS OR EXCLUSIONS MAY NOT APPLY TO YOU.

Foreword

Sec 1
System

Sec 2
PFD

Sec 3
MFD

Sec 4
Hazard
Avoidance

Sec 5
Additional
Features

Sec 6
Annun.
& Alerts

Sec 7
Symbols

Sec 8
Glossary

Appendix A

Appendix B
Index

Contents

		Foreward
1	System Overview	1-1
1.1	System Description	1-1
1.1.1	Line Replaceable Units (LRU)	1-2
1.1.2	GDU 620	1-3
1.1.3	GDC 74A	1-4
1.1.4	GRS 77	1-4
1.1.5	GMU 44.....	1-5
1.1.6	GTX 330/330D (Optional).....	1-5
1.1.7	GTP 59	1-5
1.1.8	GSR 56	1-5
1.1.9	GDL 69/69A (Optional).....	1-6
1.1.10	GAD 43(e) (Optional).....	1-6
1.1.11	Weather Radar	1-7
1.1.12	Garmin Navigator Interface.....	1-7
1.1.13	Attitude Heading Reference System (AHRS).....	1-7
1.1.14	Secure Digital Cards	1-10
1.2	System Power Up	1-11
1.3	International Geomagnetic Reference Field	1-13
1.4	System Operation.....	1-14
1.4.1	Pilot Controls	1-14
1.4.1.1	PFD Knob.....	1-14
1.4.1.2	PFD Bezel Keys.....	1-15
1.4.1.3	MFD Knobs	1-17
1.4.1.4	MFD Bezel Keys.....	1-17
1.4.2	Using the Soft Key Controls	1-18
1.4.3	Using the Page Menus.....	1-19
1.4.4	System Settings	1-20
1.4.5	Display Backlighting	1-23
2	Primary Flight Display (PFD)	2-1
2.1	PFD Soft Keys.....	2-2
2.2	Airspeed Indicator.....	2-5
2.2.1	Markings.....	2-7
2.2.2	Reference Speeds	2-8
2.3	Attitude Indicator.....	2-9

Sec 1 System
 Sec 2 PFD
 Sec 3 MFD
 Sec 4 Hazard Avoidance
 Sec 5 Additional Features
 Sec 6 Annun. & Alerts
 Sec 7 Symbols
 Sec 8 Glossary
 Appendix A
 Appendix B Index

2.3.1	Extreme Attitude	2-11
2.4	Altimeter	2-13
2.4.1	Setting the Altitude Bug and Alerter	2-13
2.4.2	Altitude Alerting	2-14
2.4.3	Changing Barometric Setting	2-15
2.4.4	Minimum Descent Altitude/Decision Height Alerting	2-15
2.5	Vertical Speed (V/S) Indicator	2-18
2.6	Horizontal Situational Indicator	2-19
2.6.1	Setting the Heading Bug	2-20
2.6.2	Turn Rate Indicator	2-21
2.7	Course Deviation Indicator	2-21
2.7.1	Changing CDI Sources	2-22
2.7.2	Changing CDI Course	2-23
2.7.3	Vertical Deviation Indicator (VDI)	2-24
2.7.4	Auto-Slewing	2-25
2.8	Supplemental Flight Data	2-27
2.8.1	Bearing Pointers	2-27
2.8.2	Temperature Display	2-29
2.8.3	Wind Vectors	2-29
2.8.4	DME Indication	2-29
2.8.5	Marker Beacon Annunciations	2-30
2.8.6	Miscompare Annunciations	2-30
2.9	Radar Altimeter	2-32
2.10	Fast/Slow Indication	2-33
2.11	PFD Display Units	2-34
3	Multi-Function Display (MFD)	3-1
3.1	Functional Display Map	3-2
3.2	MFD Soft Key Map	3-3
3.3	Navigation Map Pages	3-4
3.3.1	Default Navigation Map Page	3-5
3.3.2	Editing Information	3-5
3.3.3	Selecting Page Options	3-5
3.3.4	Changing the Navigation Map Range	3-5
3.3.5	Decluttering Map Pages	3-6
3.3.6	Panning	3-8
3.3.7	Selecting Items on the Map	3-9
3.3.8	Measuring Distances	3-10

3.3.9	Customizing Navigation Map Pages.....	3-11	
3.3.10	Map Setup.....	3-11	
3.3.10.1	Map Feature Options.....	3-13	Forward
3.3.10.2	Weather Feature Options (Optional).....	3-27	
3.3.10.3	Traffic Feature Options (Optional).....	3-30	
3.3.10.4	Aviation Feature Options.....	3-31	System Sec 1
3.3.11	Split Screen (Optional).....	3-42	
3.4	Aux Mode Pages.....	3-43	
3.4.1	System Settings.....	3-43	
3.4.1.1	Display Brightness.....	3-44	PFD Sec 2
3.4.1.2	Airspeed Reference Marks.....	3-45	
3.4.1.3	PFD Options - Wind Vector.....	3-46	MFD Sec 3
3.4.1.4	PFD Options - Nav Status.....	3-47	
3.4.1.5	Synchronization (Dual Installations Only).....	3-48	
3.4.1.6	Date and Time.....	3-50	
3.4.1.7	MFD Display Units.....	3-51	Avoidance Hazard Sec 4
3.4.1.8	System Display Units.....	3-52	
3.4.2	Sirius XM Satellite Radio XM Information (Optional).....	3-53	
3.4.3	Sirius XM Satellite Radio XM Entertainment Radio (Optional).....	3-54	Additional Sec 5
3.4.4	System Status.....	3-55	Features
3.4.5	External Video (optional).....	3-56	
3.4.5.1	Select Video Source.....	3-56	
3.4.5.2	Zoom.....	3-57	Annun. & Alerts Sec 6
3.4.5.3	Panning.....	3-57	
3.4.5.4	Setup.....	3-57	
3.4.5.5	Restore Defaults.....	3-59	Symbols Sec 7
3.4.6	Position Reporting (optional).....	3-60	
3.4.6.1	Status.....	3-60	
3.4.6.2	Report Type.....	3-60	Glossary Sec 8
3.4.7	Iridium Phone Operation (Optional).....	3-63	
3.4.7.1	Status.....	3-63	
3.4.7.2	Managing the Phone Book.....	3-65	Appendix A
3.4.7.3	Phone Volume.....	3-68	
3.4.7.4	Making a Phone Call.....	3-69	
3.4.7.5	Answering a Phone Call.....	3-70	Appendix B
3.5	Flight Plan Pages.....	3-71	Index
3.5.1	Active Flight Plan Page.....	3-71	
3.5.1.1	Active Flight Plan Detail.....	3-72	

3.5.1.2	Active Flight Plan Options.....	3-72
3.5.1.3	Setting the Altitude Minimums Alerter.....	3-73
3.5.2	Waypoint Information Page	3-74
3.5.2.1	Selecting a Waypoint	3-75
3.5.2.2	Waypoint Information Detail	3-76
3.5.2.3	Airport Directory.....	3-79
3.5.2.4	Waypoint Weather Information (Optional)	3-80
3.5.3	Charts Page (Optional)	3-81
3.5.3.1	Viewing Charts.....	3-82
3.5.3.2	Selecting a New Chart by Airport	3-83
3.5.3.3	Selecting a New Chart by FPL, NRST, or RECENT.....	3-84
3.5.3.4	Change Day/Night View.....	3-84
4	Hazard Avoidance	4-1
4.1	Terrain Configurations.....	4-1
4.2	Terrain Scale	4-3
4.3	Terrain Proximity	4-3
4.3.1	Displaying Terrain Proximity	4-4
4.3.1.1	Terrain Proximity Page Display on the Terrain Page	4-4
4.3.1.2	Terrain Proximity Page Display on a Navigation Map Page	4-5
4.3.1.3	Terrain Proximity Page 120° Arc or 360° Rings.....	4-5
4.3.1.4	Terrain Proximity Page Aviation Data.....	4-6
4.3.2	Terrain Proximity Limitations	4-8
4.3.3	System Status.....	4-8
4.4	External TAWS	4-9
4.5	Garmin Terrain-SVT™ (Optional).....	4-10
4.5.1.1	Garmin Terrain-SVT™ Page 120° Arc or 360° Rings.....	4-11
4.5.1.2	Garmin Terrain-SVT™ Page Aviation Data.....	4-12
4.5.1.3	Inhibiting/Enabling Garmin Terrain-SVT™ Alerting	4-12
4.5.1.4	Synthetic Vision Alerts and Annunciations.....	4-13
4.6	TAS Traffic (Optional).....	4-15
4.6.1	Displaying and Operating Traffic (TAS Systems).....	4-15
4.6.1.1	Switching from Standby Mode to Operating Modes.....	4-16
4.6.1.2	Range Ring	4-17
4.6.2	Altitude Display.....	4-17
4.6.3	TAS Symbology.....	4-18
4.6.4	Traffic System Status.....	4-19
4.6.5	Traffic Pop-Up.....	4-21

4.7	TIS Traffic (Optional).....	4-22	
4.7.1	Traffic Map Page.....	4-22	
4.7.2	TIS Symbology.....	4-24	Forward
4.7.3	TIS Limitations.....	4-25	
4.7.4	TIS Alerts.....	4-27	
4.7.5	Traffic Pop-Up.....	4-28	System
4.7.6	TIS System Status	4-28	Sec 1
4.8	XM WX Satellite Weather (Optional).....	4-31	
4.8.1	Using XM Satellite Weather Products	4-31	
4.8.2	Customizing the XM WX Satellite Weather Map.....	4-31	PFD
4.8.3	XM WX Weather Symbols and Product Age	4-33	
4.8.4	Weather Legends	4-36	
4.8.5	NEXRAD	4-37	MFD
4.8.5.1	Reflectivity	4-38	
4.8.5.2	NEXRAD Limitations	4-39	
4.8.6	Weather Page Map Orientation.....	4-40	Avoidance
4.8.7	NEXRAD Data Viewing Range.....	4-40	Hazard
4.8.8	NEXRAD Legend.....	4-41	
4.8.9	Echo Tops.....	4-42	
4.8.10	Cloud Tops	4-44	Additional
4.8.11	XM WX Satellite Lightning	4-46	Features
4.8.12	Cell Movement.....	4-47	
4.8.13	SIGMETs and AIRMETs	4-49	Annun.
4.8.14	METARs	4-51	& Alerts
4.8.15	Surface Analysis and City Forecast.....	4-53	
4.8.16	Freezing Level.....	4-56	
4.8.17	Winds Aloft	4-58	Symbols
4.8.18	County Warnings.....	4-61	
4.9	Weather Radar (Optional)	4-63	Glossary
4.9.1	Garmin GWX 68 Radar Description	4-63	Sec 8
4.9.1.1	Principles of Pulsed Airborne Weather Radar	4-63	
4.9.1.2	Antenna Beam Illumination	4-64	
4.9.1.3	Radar Signal Attenuation	4-65	Appendix A
4.9.2	Radar Signal Reflectivity	4-66	
4.9.2.1	Precipitation.....	4-66	
4.9.2.2	Ground Returns.....	4-67	
4.9.2.3	Angle of Incidence.....	4-67	Appendix B
4.9.3	Operating Distance.....	4-68	Index

Forward

System
Sec 1

PFD
Sec 2

MFD
Sec 3

Avoidance
Hazard
Sec 4

Additional
Features
Sec 5

Annun.
& Alerts
Sec 6

Symbols
Sec 7

Glossary
Sec 8

Appendix A

Appendix B
Index

4.9.4	Basic Antenna Tilt Setup	4-69
4.9.5	Weather Mapping and Interpretation	4-70
4.9.5.1	Weather display Interpretation.....	4-70
4.9.5.2	Thunderstorms	4-71
4.9.5.3	Tornadoes	4-73
4.9.5.4	Hail.....	4-73
4.9.6	Radar Operation in Weather Mode.....	4-74
4.9.6.1	Displaying Weather on the Weather Radar Page	4-75
4.9.6.2	Vertically Scanning a Storm Cell.....	4-76
4.9.6.3	Adjusting the Antenna Tilt Angle.....	4-77
4.9.6.4	Adjusting Gain	4-78
4.8.6.5	Sector Scan (GWX Radars Only)	4-80
4.9.6.6	Antenna Stabilization	4-81
4.9.6.7	Weather Attenuated Color Highlight (WATCH™)	4-81
4.9.6.8	Weather Alert (GWX Radars Only).....	4-82
4.9.7	Ground Mapping and Interpretation	4-83
4.10	GFDS Weather (Optional)	4-85
4.10.1	Using GFDS Satellite Weather Products	4-86
4.10.2	Register With GFDS	4-86
4.10.2.1	Register With GFDS	4-86
4.10.2.2	Deactivate Unit Registration With GFDS	4-87
4.10.3	Customizing the GFDS Weather Map	4-88
4.10.4	Weather Page Map Orientation.....	4-90
4.10.5	GFDS Data Request	4-91
4.10.5.1	GFDS Data Request Coverage.....	4-92
4.10.5.2	GFDS Data Request Auto Request.....	4-94
4.10.5.3	GFDS Data Request Manual Request.....	4-94
4.10.5.4	GFDS Data Request Status Window	4-95
4.10.6	Precipitation (PRECIP) Data Viewing Range	4-96
4.10.7	PRECIP Legend.....	4-97
4.10.8	GFDS Infrared Satellite (IR SAT) Data Viewing Range	4-98
4.10.9	Data Link Lightning (DL LTNG) Data Viewing Range.....	4-100
4.10.10	SIGMETs and AIRMETs (SIG/AIR).....	4-102
4.10.11	METARs	4-105
4.10.12	Winds Aloft	4-107
5	Additional Features (Optional)	5-1
5.1	Viewing Charts	5-2

5.1.1	Chart Panning	5-3	
5.1.2	Choosing a Chart for the Current Airport.....	5-4	
5.1.3	Selecting a Chart by Identifier	5-6	Forward
5.1.4	Selecting a New Chart by FPL, NRST, or RECENT.....	5-7	
5.1.5	Charts Menu Selections	5-8	
5.1.5.1	Setting the Altitude Minimums Alerter.....	5-8	System Sec 1
5.1.5.2	Viewing Chart NOTAMs	5-9	
5.1.5.3	Day/Night View	5-9	
5.2	ChartView (Optional)	5-10	PFD Sec 2
5.2.1	Cycle Number and Revision	5-11	
5.2.2	Viewing Chart Details in ChartView	5-13	
5.3	FliteCharts®	5-16	MFD Sec 3
5.3.1	Cycle Number and Revision	5-16	
5.4	SafeTaxi®	5-18	
5.4.1	Using SafeTaxi®	5-19	Hazard Avoidance Sec 4
5.4.1.1	Decluttering	5-19	
5.4.1.2	Hot Spot Information.....	5-19	
5.4.2	SafeTaxi® Cycle Number and Revision	5-20	
5.5	Sirius XM Satellite Radio Entertainment.....	5-22	Additional Features Sec 5
5.5.1	Activating Sirius XM Satellite Radio Services.....	5-22	
5.5.2	Sirius XM Satellite Radio Information	5-24	
5.5.3	Sirius XM Satellite Radio Entertainment Radio.....	5-25	Annun. & Alerts Sec 6
5.5.3.1	Channel Categories	5-26	
5.5.3.2	Selecting a Sirius XM Satellite Radio Channel.....	5-27	
5.5.3.3	Sirius XM Satellite Radio Volume.....	5-28	
5.5.3.4	Sirius XM Satellite Radio Channel Presets	5-29	Symbols Sec 7
5.5.4	GDL 69/69A Data Link Receiver Troubleshooting.....	5-30	
5.6	Autopilot Operation	5-31	Glossary Sec 8
5.6.1	GAD 43 Attitude.....	5-31	
5.6.2	Heading	5-32	
5.6.3	Altitude Capture (Optional Upgrade).....	5-32	
5.6.4	Autopilot Navigation	5-33	Appendix A
5.6.4.1	Autopilot Operation with GPSS Enabled Autopilots.....	5-33	
5.6.3.2	Autopilot Operation with the GDU 620 Emulating GPSS.....	5-34	
5.6.4	Flight Director Display.....	5-34	Appendix B
5.6.5	Vertical Speed Control	5-35	Index
5.6.6	Autopilot Mode Annunciations	5-36	

5.7	Garmin Synthetic Vision Technology (SVT™) (Optional).....	5-37
5.7.1	Garmin SVT™ Operation.....	5-39
5.7.2	Activating and Deactivating Garmin SVT™	5-40
5.7.3	Garmin SVT™ Features	5-41
5.7.3.1	Flight Path Marker (FPM)	5-41
5.7.3.2	Zero-Pitch Line	5-41
5.7.3.3	Horizon Heading	5-42
5.7.3.4	Airport Signs	5-42
5.7.3.5	Runway Depiction	5-43
5.7.3.6	Traffic.....	5-44
5.7.3.7	Obstacles	5-45
5.7.3.8	Field of View	5-46
5.7.3.9	Unusual Attitudes.....	5-48
6	Annunciations and Alerts.....	6-1
6.1	Alerts	6-1
6.2	System Status	6-10
7	Symbols.....	7-1
7.1	Map Page Symbols.....	7-1
7.2	SafeTaxi™ Symbols	7-2
7.3	Traffic Symbols.....	7-2
7.4	Terrain Obstacle Symbols.....	7-3
7.5	Basemap Symbols	7-4
7.6	Map Tool Bar Symbols.....	7-4
7.7	XM Weather Tool Bar Symbols.....	7-5
7.8	Miscellaneous Symbols.....	7-6
8	Glossary.....	8-1
	Appendix A.....	A-1
	SD Card Use and Databases	A-1
	Jeppesen Databases.....	A-2
	Updating the Jeppesen Aviation Database	A-2
	Garmin Databases.....	A-4
	Updating Garmin databases	A-5
	Index.....	B-1

1 SYSTEM OVERVIEW

1.1 System Description

This section provides an overview of the G500 Avionics Display System. The G500 system is an integrated display system that presents primary flight instrumentation, navigation, and a moving map to the pilot through large-format displays.

In normal operating mode, the Primary Flight Display (PFD) presents graphical flight instrumentation (attitude, heading, airspeed, altitude, vertical speed), replacing the traditional flight instrument cluster. The Multi-Function Display (MFD) normally displays a full-color moving map with navigation information, as well as supplemental data.

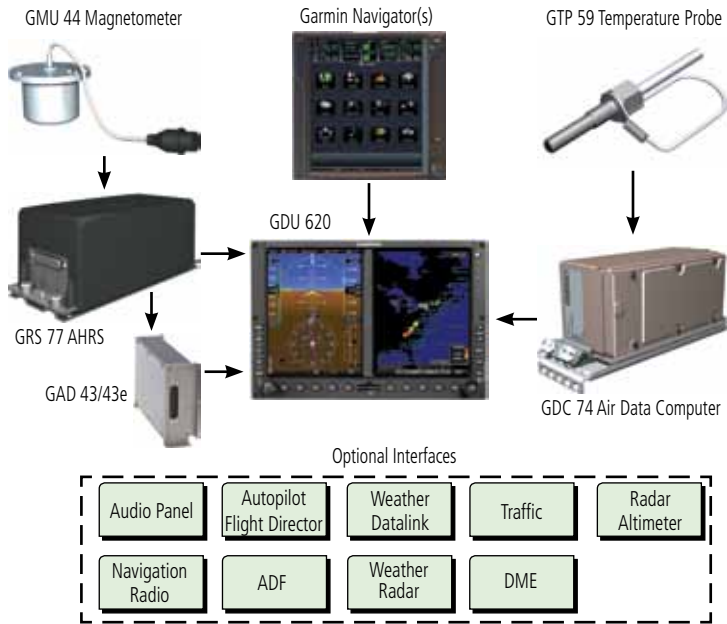

Figure 1-1 G500 System (LRU Configuration)

The system consists of the following Line Replaceable Units (LRUs):

- **GDU 620** Primary Flight Display (PFD) and Multi Function Display (MFD)
- **GDC 74A/74B** Air Data Computer (ADC)
- **GRS 77** Attitude and Heading Reference System (AHRS)
- **Temperature Probe** (such as the GTP 59)

- **GMU 44** Magnetometer
- At least one of the following: **GNS 480**, **CNX80**, **GNS 400W series**, **GNS 500W series**, **GTN 600 series**, **GTN 700 series**, or a compatible GPS Navigator
- **GAD 43/43e** Adapter (Optional)

Interfaces to various other aircraft systems and equipment are supported, including:

- **GDL 69/69A** Satellite Data Link Receiver
- **GSR 56** Satellite Data Link Receiver
- **SL30 NavCom**
- **Autopilot/Flight Director**
- **ADF**
- **Garmin GTS or GTX** traffic awareness systems, or selected 3rd party devices
- **Audio Panel**
- **Garmin GWX** radar systems or selected 3rd party radars
- **Radar Altimeter**
- **Video Sources**

1.1.1 Line Replaceable Units (LRU)

This guide covers the operation of the GDU 620 display as integrated in the G500 system. The G500 Avionics Display System is an avionics suite designed to replace the traditional flight instrument cluster. The system combines primary flight instrumentation, navigational information, and a moving map all displayed on dual color screens. The G500 system is composed of sub-units or Line Replaceable Units (LRUs). LRUs have a modular design and can be installed directly behind the instrument panel or in a separate avionics bay if desired. This design greatly eases troubleshooting and maintenance of the G500 system. A failure or problem can be isolated to a particular LRU, which can be replaced quickly and easily. Each LRU has a particular function, or set of functions, that contributes to the system's operation.

1.1.2 GDU 620

The GDU 620 has dual VGA (640 x 480 pixels) 6.5 inch LCD displays. The left side of the GDU is a PFD and the right side is the MFD. In some models or installations, the PFD and MFD and their controls are switched to the other side. The MFD shows a moving map, flight plan, weather, and other supplemental data. The PFD shows primary flight information, in place of traditional pitot-static and gyroscopic systems and also provides an HSI for navigation.



Figure 1-2 GDU 620 PFD and MFD



Figure 1-3 GDU 620 PFD and MFD with PFD on Right

1.1.3 GDC 74A

The GDC 74A Air Data Computer (ADC) compiles information from the pitot/static system and an Outside Air Temperature (OAT) sensor. The GDC 74A provides pressure altitude, airspeed, vertical speed, and OAT information to the G500 system. The GDC 74A communicates with the GDU 620 and GRS 77 using an ARINC 429 digital interface.



Figure 1-4 GDC 74A Air Data Computer

1.1.4 GRS 77

The GRS 77 is an Attitude and Heading Reference System (AHRS) unit that provides aircraft attitude information to the G500 display. The unit contains advanced tilt sensors, accelerometers, and rate sensors. In addition, the GRS 77 interfaces with both the GDC 74A Air Data Computer and the GMU 44 magnetometer. The GRS 77 also utilizes GPS data forwarded from the GDU 620. Actual attitude and heading information is sent to the GDU 620 using an ARINC 429 digital interface.



Figure 1-5 GRS 77 AHRS

The IGRF (International Geomagnetic Reference Field) model is contained in the GRS 77 and is only updated once every five years. The IGRF model is part of the Navigation Database. At system power-up, the IGRF models in the GRS 77 and in the Navigation Database are compared, and if the IGRF model in the GRS 77 is out of date, the user is prompted to update the IGRF model in the GRS 77. The prompt will appear after the G500 splash screen is acknowledged on the MFD.

1.1.5 GMU 44

The GMU 44 magnetometer senses the earth's magnetic field. Data is sent to the GRS 77 AHRS for processing to determine aircraft magnetic heading. This unit receives power directly from the GRS 77 and communicates with the GRS 77 using a RS-485 digital interface.



Figure 1-6 GMU 44 Magnetometer

1.1.6 GTX 330/330D (Optional)



Figure 1-7 GTX 330/330D Mode S Transponder

The GTX 330/330D is a solid-state transponder that provides Modes A, C, and S functions. The transponder provides traffic information to the display through an ARINC 429 digital interface.



NOTE: GTX 33/33D can also be used to display traffic information on the GDU 620.

1.1.7 GTP 59

The GTP 59 temperature probe provides Outside Air Temperature (OAT) data to the GDC 74A.



Figure 1-8 GTP 59 Temperature Probe

1.1.8 GSR 56

The GSR 56 is an Iridium® satellite transceiver that supports voice telephone calls, aircraft position reporting, and world wide weather products.

1.1.9 GDL 69/69A (Optional)

The GDL 69/69A is a Sirius XM Satellite Radio Data Link Receiver that receives broadcast weather data. The GDL 69A is the same as the GDL 69 with the addition of an Sirius XM Satellite Radio audio entertainment receiver. Weather data and control of audio channel and volume is displayed on the MFD, via a High-Speed Data Bus (HSDB) Ethernet connection. The GDL 69A is also interfaced to an audio panel for distribution of the audio signal. A subscription to the Sirius XM Satellite Radio service is required to enable the GDL 69/69A capability.

Subscription information is available at: <http://www.garmin.com/xm/>.



Figure 1-9 GDL 69/69A XM Satellite Radio Data Link Receiver

1.1.10 GAD 43(e) (Optional)

The GAD 43 is an adapter that converts AHRS digital pitch, roll, heading and yaw rate data into analog signals used by autopilot systems. The GAD 43 is installed remotely between the AHRS and an existing autopilot. The analog signals from the GAD 43 mimic those of spinning-mass gyros that provide data to the autopilot and allow the gyro to be replaced by the AHRS and GAD 43 combination.

The GAD 43e performs the same functions as the GAD 43, but adds support for additional interfaces to various aircraft systems. The GAD 43e supports interfaces to various autopilots (for altitude preselect and vertical speed control), analog NAV radios, DME, analog radar altimeters, marker beacons, and ADF receivers.

Foreword
Sec 1 System

Sec 2 PFD

Sec 3 MFD

Sec 4 Hazard Avoidance

Sec 5 Additional Features

Sec 6 Annun. & Alerts

Sec 7 Symbols

Sec 8 Glossary

Appendix A

Appendix B Index



Figure 1-10 GAD 43 AHRS Adapter

1.1.11 Weather Radar

The Garmin GWX system, or selected 3rd party radar, provides airborne weather and ground mapped radar data to the MFD.

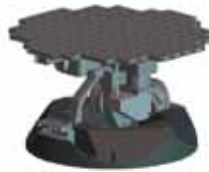

Figure 1-11 GWX 68 Weather Radar

1.1.12 Garmin Navigator Interface

The G500 system requires connection to at least one external Garmin WAAS GPS navigator, such as the 400W/500W series or GNS 480.

1.1.13 Attitude Heading Reference System (AHRS)



NOTE: Aggressive maneuvering while AHRS is not operating in normal mode may degrade AHRS accuracy.

Attitude and heading information is displayed on the PFD when the AHRS receives appropriate combinations of information from the external sensor inputs.

AHRS Inputs			AHRS Mode	AHRS Outputs	
GPS	Magnetometer	Air Data		Attitude	Heading
Available	Available	—	Normal	Available	Available
Available	Unavailable	Available	No Mag	Available	GPS Track
Available	Unavailable	Unavailable	No Air/ No Mag	Available	GPS Track
Unavailable	Available	Available	No GPS	Available	Available
Unavailable	Available	Unavailable	Fail	Unavailable	Unavailable
Unavailable	Unavailable	—	Fail	Unavailable	Unavailable

Table 1-1 AHRS Operation

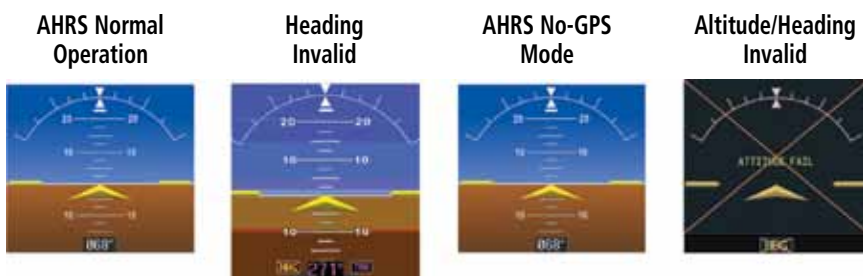

Figure 1-12 AHRS Operation

Loss of GPS, magnetometer, or air data inputs is communicated to the pilot by message advisory alerts (refer to Section 6 for specific AHRS alert information). Any failure of the internal AHRS inertial sensors results in loss of attitude and heading information (indicated by red “X” flags over the corresponding flight instruments).

A maximum of two GPS inputs are provided to the AHRS. If GPS information from one of the inputs fails, the AHRS uses the remaining GPS input and an alert message is issued to inform the pilot. If both GPS inputs fail, the AHRS will continue to provide attitude and heading information to the PFD as long as magnetometer and airspeed data are available and valid.

If the magnetometer input fails, the AHRS continues to output valid attitude information and GPS Track information is used; however, the heading display on the PFD is flagged as invalid with a red “X,” “TRK” in magenta is annunciated to the right of the Track value, and the Track value color is changed from white to magenta.



NOTE: In this case the magnetic standby compass and GPS ground track can be used to keep the aircraft on the desired heading.

Note that SVT is turned off in “track-based reversionary mode” and must be manually re-enabled when heading is restored. Also, map orientations change from HDG UP to TRACK UP and must be manually changed back after heading is restored.

When heading fails the heading bug is not removed and the GDU continues driving the autopilot heading error output using track in place of heading.



Figure 1-13 Track Mode shown as Active when Heading Info has failed

Failure of the air data input has no effect on the AHRS output while AHRS is receiving valid GPS information. Invalid or unavailable airspeed data in addition to complete GPS failure results in loss of all attitude and heading information.



NOTE: Fastest AHRS alignment is achieved with the aircraft stationary and with all AHRS inputs valid (3-D GPS position, magnetometer, and air data). During initial power up on the ground, no GPS position and/or magnetic anomalies are common. If the aircraft is taxied prior to AHRS alignment, alignment may be delayed until after a valid 3-D GPS position is available.



NOTE: During in-flight alignment of the AHRS, minimize aircraft maneuvering. The AHRS will align with shallow banking and pitch angles (less than 20 degrees of roll or 5 degrees of pitch). AHRS alignment may not be possible during more aggressive maneuvers.

1.1.14 Secure Digital Cards

The G500 System uses Secure Digital (SD) cards to load and store various types of data. For basic flight operations, SD cards are required for Terrain, Obstacle, FliteChart, SafeTaxi, and ChartView database storage as well as Jeppesen aviation and ChartView database updates. The Aviation Database update card is generally inserted in the upper SD card slot for database updates and then removed. Other database cards are normally located in the lower SD card slot. ChartView is an optional feature that requires enablement by a Garmin dealer.



NOTE: Ensure the GDU 620 is powered off before inserting or removing an SD card.



NOTE: Refer to Appendix A for instructions on updating the aviation database.

Inserting an SD Card

- 1) Insert the SD card in the SD card slot (the front of the card should be flush with the face of the display bezel).
- 2) To eject the card, gently press on the SD card to release the spring latch.

1.2 System Power Up

Foreword

Sec 1
System

Sec 2
PFD

Sec 3
MFD

Sec 4
Hazard
Avoidance

Sec 5
Additional
Features

Sec 6
Annun.
& Alerts

Sec 7
Symbols

Sec 8
Glossary

Appendix A

Appendix B
Index



NOTE: See the Aircraft Flight Manual (AFM) for specific procedures concerning avionics power application and emergency power supply operation.



NOTE: Refer to Section 6 for system-specific annunciations and alerts.

The G500 System is integrated with the aircraft electrical system and receives power directly from electrical busses. The GDU 620 and supporting sub-systems include both power-on and continuous built-in test features that exercise the processor, memory, external inputs, and outputs to ensure safe operation.

During system initialization, test annunciations are displayed. All system annunciations should disappear typically within the first 30 seconds after power-up. Upon power-up, bezel key backlights also become momentarily illuminated on the GDU 620 display bezel.

On the PFD, the AHRS begins to initialize and “AHRS ALIGN: Keep Wings Level” is displayed. The AHRS should display valid attitude and heading fields typically within the first minute after power-up. The AHRS can align itself both while taxiing and during level flight.



NOTE: Fastest AHRS alignment is achieved with the aircraft stationary and with all AHRS inputs valid (3-D GPS position, magnetometer, and air data). During initial power up on the ground, no GPS position and/or magnetic anomalies are common. If the aircraft is taxied prior to AHRS alignment, alignment may be delayed until after a valid 3-D GPS position is available.



NOTE: During in-flight alignment of the AHRS, minimize aircraft maneuvering. The AHRS will align with shallow banking and pitch angles (less than 20 degrees of roll or 5 degrees of pitch). AHRS alignment may not be possible during more aggressive maneuvers.

When the MFD powers up, the splash screen displays the following information:

- Software version and part number
- Basemap database version
- Terrain database version
- Airport Terrain database version
- Obstacle database expiration date
- Aviation database expiration date
- Airport Directory database expiration date
- Chart database status

Databases are displayed in white if they are determined to be current. Databases are displayed in yellow if they have expired, are not yet effective, or if the current date/time is not yet available from the GPS.



Figure 1-14 System Startup Pages

Pressing the **ENT** key (or right-most soft key) acknowledges this information and displays the Navigation Map Page. When the interfaced GPS unit has acquired a sufficient number of satellites to determine a position, the aircraft's current position is shown on the Navigation Map Page.

1.3 International Geomagnetic Reference Field

The IGRF (International Geomagnetic Reference Field) model is contained in the GRS 77 and is only updated once every five years. The IGRF model is part of the Navigation Database. At system power-up, the IGRF models in the GRS 77 and in the Navigation Database are compared, and if the IGRF model in the GRS 77 is out of date, the user is prompted to update the IGRF model in the GRS 77. The following prompt will appear after the G500 splash screen is acknowledged on the MFD.

GRS MV DB UPDATE AVAILABLE. UPDATE FROM yyyy TO yyyy
(e.g. 2005 to 2010)

Follow the on-screen instructions.

- 1) When the Update message appears, to start the update process press the **ENT** key with "OK" highlighted. To update at another time, turn the **Large** knob to highlight "Cancel" and then press **ENT**.



Figure 1-15 GRS MV DB Update

- 2) After the update is complete, press the **ENT** key to continue normal operation.

Foreword

Sec 1
System

Sec 2
PFD

Sec 3
MFD

Sec 4
Hazard
Avoidance

Sec 5
Additional
Features

Sec 6
Annun.
& Alerts

Sec 7
Symbols

Sec 8
Glossary

Appendix A

Appendix B
Index

1.4 System Operation

Foreword



NOTE: Refer to Section 6 for detailed descriptions of all alerts and annunciations.

Sec 1
System

1.4.1 Pilot Controls

The GDU 620 controls have been designed to simplify operation of the system and minimize workload and the time required to access functionality. Controls are located on the PFD and MFD bezels and are comprised of a PFD knob, MFD dual concentric knobs, bezel keys, and soft keys.

Sec 2
PFD

1.4.1.1 PFD Knob

Pressing the **PFD** knob performs the default action for the selected mode. Refer to the PFD Bezel Keys section for details.

Sec 3
MFD

Sec 4
Hazard
Avoidance



Sec 5
Additional
Features

Figure 1-16 Selection Modes Adjusted with the PFD Knob

Sec 6
Annun.
& Alerts



NOTE: After 10 seconds of inactivity in another mode, the **PFD** knob selected mode will revert to Heading mode.

Sec 7
Symbols

1. Press the desired PFD mode selection key (**HDG**, **CRS**, **ALT**, **V/S**, or **BARO**). A window will be displayed near the upper left corner of the HSI showing the current value for that mode.
2. Turn the **PFD** knob to select the desired value.

Sec 8
Glossary

Appendix A

Appendix B
Index

1.4.1.2 PFD Bezel Keys



NOTE: See Section 5.6 for autopilot functions using the PFD Bezel Keys.

Heading (HDG)

Selects Heading Select mode. Pressing the **PFD** knob in Heading mode will center the Heading Bug on the current Heading. This is the default mode for the **PFD** knob. Set the heading on the HSI by turning the **PFD** knob after pressing the **HDG** key.

Course (CRS)

Selects Course Select mode. Pressing the **PFD** knob in Course mode will center the CDI for a VOR or OBS mode course.

Altimeter (ALT)

Selects Altitude Select mode. Pressing the **PFD** knob in Altitude Select mode will enter the current altitude in the Altitude Select window. Set the Altitude Bug by turning the **PFD** knob after pressing the **ALT** key.

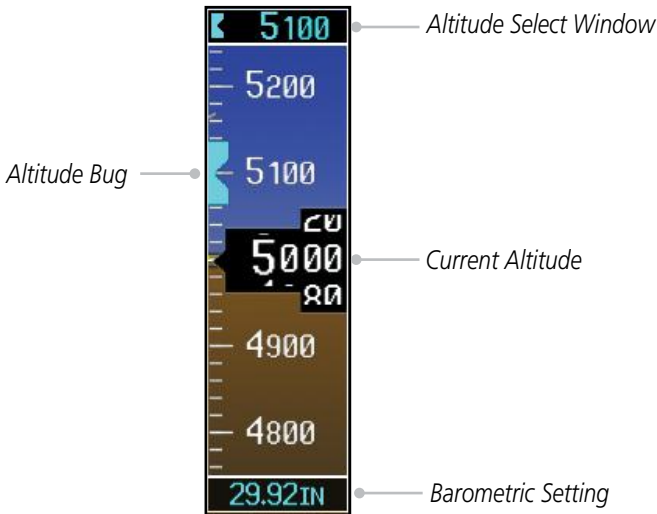

Figure 1-17 Pressing PFD Knob Sets Altitude Select to Current Altitude

Vertical Speed (V/S)

Selects Vertical Speed (V/S) mode. Pressing the **PFD** knob in V/S mode will synchronize the bug to the current vertical speed.

Foreword

Sec 1 System

Sec 2 PFD

Sec 3 MFD

Sec 4 Hazard Avoidance

Sec 5 Additional Features

Sec 6 Annun. & Alerts

Sec 7 Symbols

Sec 8 Glossary

Appendix A

Appendix B Index

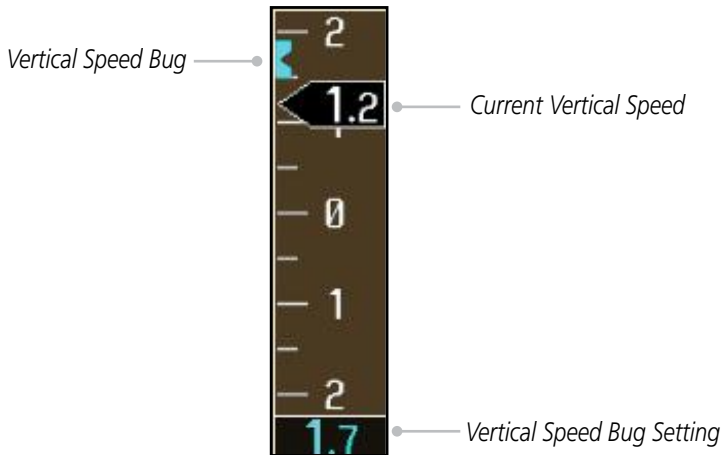

Figure 1-18 Pressing V/S Knob Sets Vertical Speed Bug to Current Vertical Speed

For aircraft with vertical speed operating limitations, red bands showing Vertical Speed Maximum and Minimum ranges will be shown on the left side of the Vertical Speed tape. When the Vertical Speed Indicator is in one of the red ranges, the background color of the Vertical Speed Indicator will turn red.

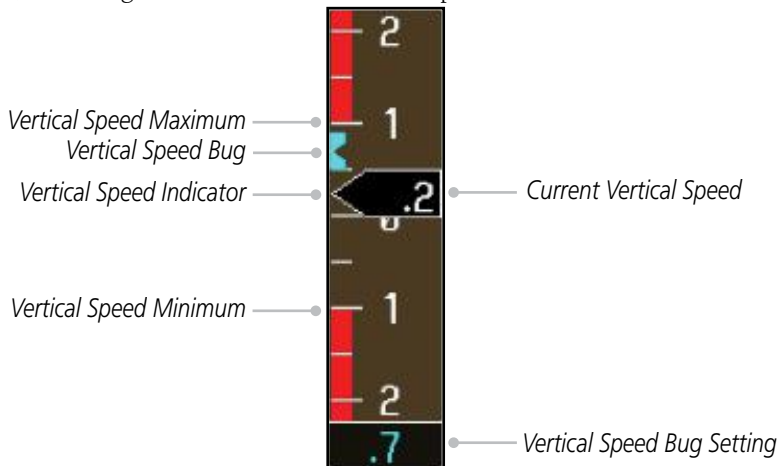

Figure 1-19 Vertical Speed Warning Indication

Installations with GAD 43e Altitude Preselect will have a V/S popup similar to the ALT popup. For certain configurations, the selected vertical speed may be controlled by the altitude preselector and the V/S popup will show AUTO.

Barometer (BARO)

Selects Barometric Setting Select mode. Pressing the **PFD** knob in Baro mode toggles between standard pressure (29.92 in/1013 mb) and the previously selected value.

Foreword

1.4.1.3 MFD Knobs

The MFD knobs are for navigating and selecting information on the MFD pages. More details are provided in the MFD section.

Sec 1
System

Small (Inner) MFD Knob

Selects a specific page within a page group. Pressing the small **MFD** knob turns the selection cursor ON and OFF. When the cursor is ON, data may be entered in the applicable window by turning the small and large **MFD** knobs. In this case, the large **MFD** knob moves the cursor on the page and the small **MFD** knob selects individual characters or values for the highlighted cursor location.

Sec 2
PFD

Sec 3
MFD

Sec 4
Hazard
Avoidance

Large (Outer) MFD Knob

Selects the MFD page group. When the cursor is ON, the large **MFD** knob moves the cursor to highlight available fields.

Sec 5
Additional
Features

1.4.1.4 MFD Bezel Keys

Range (RNG)

Pressing the Range arrow keys changes the range on the Map pages. The Up arrow zooms out. The Down arrow zooms in. The keys also aid in scrolling up and down text pages.

Sec 6
Annun.
& Alerts

Sec 7
Symbols

Menu

Displays a context-sensitive list of options. This list allows the user to access additional features or make setting changes that relate to particular pages.

Sec 8
Glossary

Enter (ENT)

Validates or confirms a menu selection or data entry.

Appendix A

Clear (CLR)

Erases information, cancels entries, or removes page menus. Pressing and holding the **CLR** key displays the Navigation Map 1 page.

Appendix B
Index

1.4.2 Using the Soft Key Controls

The soft keys are located along the bottoms of the displays. The soft key labels shown depend on the soft key level or page being displayed. The bezel keys below the soft keys can be used to select the appropriate soft key.

MFD functions indicated by the soft key labels vary depending on the page selected and are located at the bottom of the MFD display. Press the soft key located directly below the soft key label. To select the function indicated on the soft key label, press the soft key directly below the label.

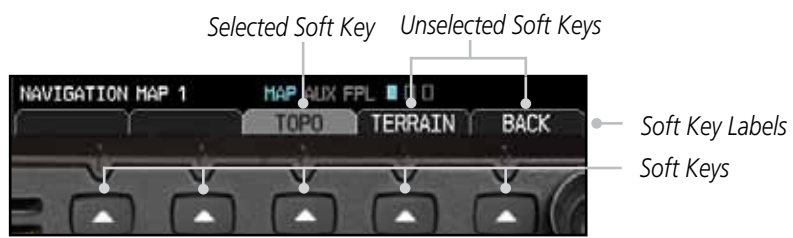

Figure 1-20 MFD Soft Key Layout

1.4.3 Using the Page Menus

The GDU 620 has a dedicated **MENU** key that when pressed displays a context-sensitive list of options for functions in the MFD. This options list allows the user to access additional features or make settings changes which specifically relate to the currently displayed window/page. There is no all-encompassing menu. Some menus provide access to additional submenus that are used to view, edit, select, and review options. Menu display “No Options” when there are no options for the window/page selected. Soft key presses do not display menus or submenus.

Navigating within a Menu

- 1) Press the **MENU** key to display the menu.
- 2) Turn the small or large **MFD** knob to scroll through a list of available options (a scroll bar always appears to the right of the window/box when the option list is longer than the window/box).
- 3) Press the **ENT** key to select the desired option.
- 4) Press the **CLR** key or **MFD** knob to remove the menu and cancel the operation.



Figure 1-21 Page Menu Examples

1.4.4 System Settings

Foreword

G500 system settings are managed from the Aux Mode System Setup Page. The following settings can be changed:

- Display Brightness (Mode and Level)
- Airspeed References (Glide-REF, V_R , V_X - $V1$, and V_Y - $V2$)
- PFD Options (Wind Vector and Nav Status)
- Dual Unit Synchronization (CDI and Baro) - Dual installations only
- Date/Time (Date, Time, Time Format, and Time Offset)
- MFD Display Units (Distance/Speed and Altitude/Vertical Speed)
- System Display Units (Navigation Angle Reference, Pressure Units, and Temperature Units)

Sec 1
System

Sec 2
PFD

Sec 3
MFD

Sec 4
Hazard
Avoidance

Sec 5
Additional
Features

Sec 6
Annun.
& Alerts

Sec 7
Symbols

Sec 8
Glossary

Appendix A

Appendix B
Index



Figure 1-22 System Setup Page

System Settings Values

- 1) From the first AUX page, press the small **MFD** knob and turn the large **MFD** knob to highlight the desired value.
- 2) Turn the small **MFD** knob to select "ON" or "OFF."
- 3) Press **ENTER** to save the setting.

More detail on changing settings is in the Section 3 - MFD Aux pages System Settings section.

Category	Settings	Affected Quantities	Exceptions
Display Brightness	Level Mode	Brightness levels on the PFD and MFD	
Airspeeds	Glide (or REF) V_R V_X (OR V1) V_Y (OR V2)	Reference markers on PFD airspeed tape	
Synchronization	CDI - On/Off BARO - On/Off	Crossfill Nav information to GDU 620	
PFD Options (Wind Vector) (NAV Status)	Off, Style 1 - Style 4 Style 1 - 2	PFD wind vector display format. Location of GPS navigation data.	 Nav Status option not available in all installations.
Date/Time	Date Time Time Format Time Offset		

Category	Settings	Affected Quantities	Exceptions
Distance and Speed	Imperial (SM, MPH) Metric (KM, KPH) Nautical (NM, KT)	Bearing distances (information windows) Distance (information window) Flight plan distances Map ranges DIS field (Navigation Status Box) All distances on MFD All speeds on MFD	Airspeed Indicator True Airspeed Wind speed vector Map range (Traffic Page, Terrain Proximity Page)
Altitude and Vertical Speed	Feet Meters	All elevations on MFD	Altimeter Vertical Speed Indicator
Navigation Angle	Magnetic (North) True (North)	Heading Course Bearing Track Desired Track	
Barometric Setting	Inches (in) Hectopascals (hpa)	Barometric pressure on PFD	
Temperature	Celsius Fahrenheit	All temperatures on PFD	

Table 1-2 Display Units Settings (System Setup Page)

More detail on changing settings is in the Section 3 - MFD Aux pages System Settings section.

Foreword
Sec 1 System
Sec 2 PFD
Sec 3 MFD
Sec 4 Hazard Avoidance
Sec 5 Additional Features
Sec 6 Annun. & Alerts
Sec 7 Symbols
Sec 8 Glossary
Appendix A
Appendix B Index

1.4.5 Display Backlighting

The backlighting of the PFD and MFD displays and bezel keys can be adjusted automatically or manually. The default setting (automatic backlighting adjustment) uses the photocell located at the top right corner of the bezel to automatically adjust for ambient lighting conditions. Photocell calibration curves are configured by the installer to optimize display appearance through a broad range of cockpit lighting conditions. Manual backlighting adjustment can be accomplished using the existing instrument panel dimmer bus or the following procedures.

Backlighting Adjustment

- 1) From the first AUX page, press the small **MFD** knob to highlight the "DISPLAY BRIGHTNESS" "MODE" box.
- 2) Turn the small **MFD** knob to select the desired brightness Level and then press **ENTER**.

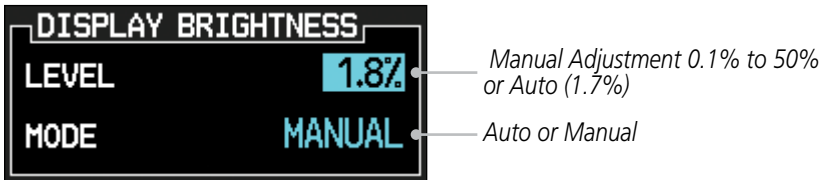

Figure 1-23 Display Brightness Adjustment

- 3) Turn the large **MFD** knob to highlight the MODE field. Turn the small **MFD** knob to select "AUTO" or "MANUAL."
- 4) Press **ENT**.

Foreword

Sec 1
System

Sec 2
PFD

Sec 3
MFD

Sec 4
Hazard
Avoidance

Sec 5
Additional
Features

Sec 6
Annun.
& Alerts

Sec 7
Symbols

Sec 8
Glossary

Appendix A

Appendix B
Index

This page intentionally left blank

2 PRIMARY FLIGHT DISPLAY (PFD)

Functions on the PFD are accessed by using the bezel keys on the side of the PFD and the soft keys below the PFD.



Figure 2-1 PFD Description (Ground Pointer Mode)

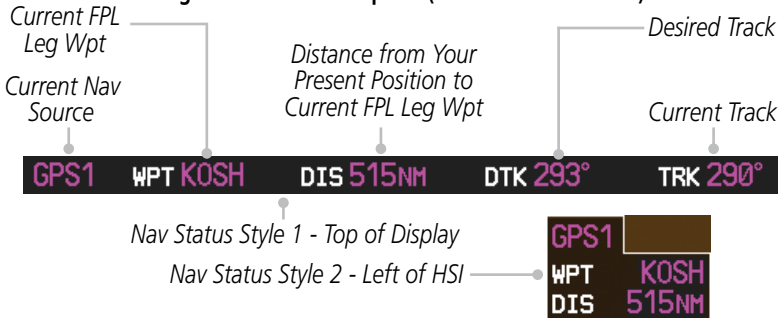

Figure 2-2 PFD Nav Status Bar Description



NOTE: When navigating to a waypoint very far away, the DTK, CRS, and TRK values displayed on the GDU 620 may differ from those displayed on the navigator, however the CDI is correct and is the primary means of navigation. This is because the GDU 620 applies magnetic variation corrections for the current aircraft location, but some navigators apply magnetic variation correction for the waypoint location.

Foreword

Sec 1 System

Sec 2 PFD

Sec 3 MFD

Sec 4 Hazard Avoidance

Sec 5 Additional Features

Sec 6 Annun. & Alerts

Sec 7 Symbols

Sec 8 Glossary

Appendix A

Appendix B Index

2.1 PFD Soft Keys

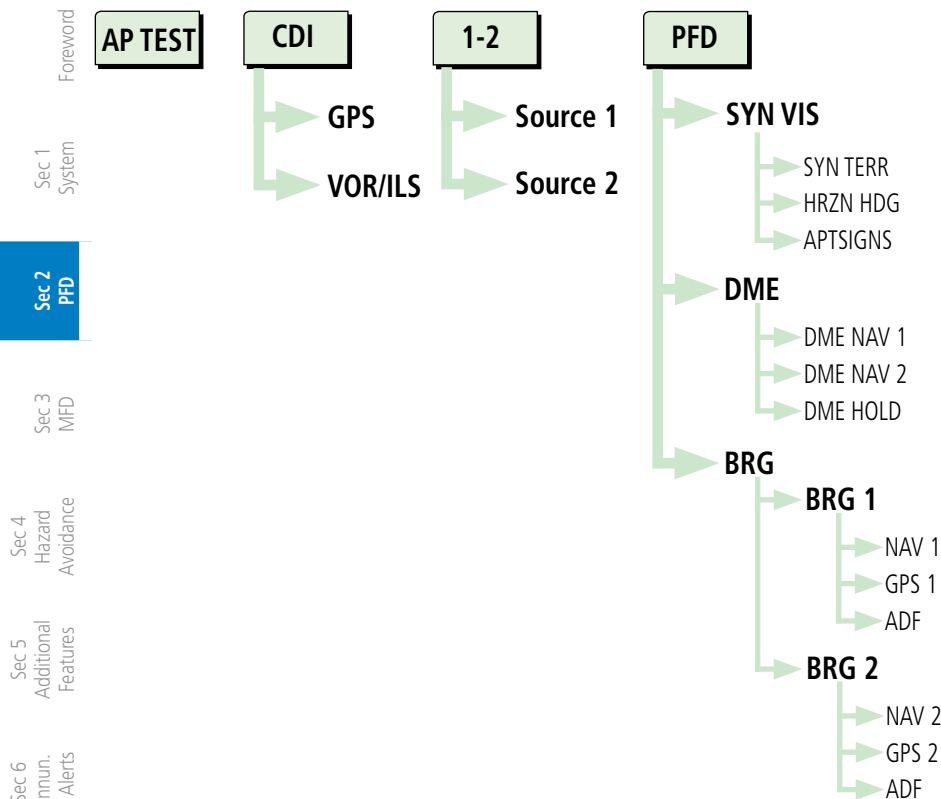

Figure 2-3 PFD Soft Key Diagram

The soft keys are located along the bottom of the displays below the soft key labels. The soft key labels shown depend on the soft key level or page being displayed. The soft keys can be used to select the appropriate soft key function.

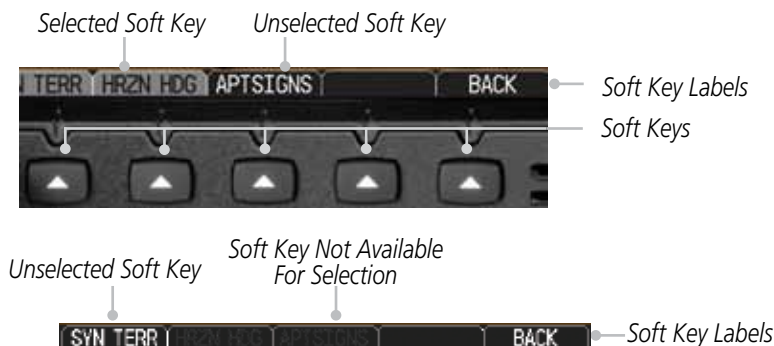

Figure 2-4 PFD Soft Key Layout

When a soft key is selected, its color changes to black text on gray background and remains this way until it is turned off, at which time it reverts to white text on black background. When a soft key function is disabled, the soft key label is subdued (dimmed). Soft keys revert to the previous level after 45 seconds of inactivity.



NOTE: *If a soft key is pressed and held for longer than 1 second, it is ignored.*

AP Test

The **AP TEST** soft key is available if the GAD 43 is used to provide attitude information to an autopilot. The AP TEST soft key disengages the autopilot as part of the GAD 43 test.



NOTE: *"AP TEST" is not available for all installations.*

CDI

The **CDI** soft key toggles between the selection of GPS or VOR/LOC as the active navigation source. In a single GDU 620 system, the GDU CDI soft key will change the source in the connected navigator and making a source change in the navigator will be reflected in the GDU 620. In a dual GDU 620 system, the CDI keys in the navigator will be disabled.

1-2

The **1-2** soft key toggles between the available receivers for selected navigation source (i.e. GPS1 and GPS2 or VOR/LOC1 and VOR/LOC2). This soft key will only be present if the system is configured for a second GPS or VOR/LOC.

PFD

Pressing the **PFD** soft key displays the **SYN VIS**, **DME**, **BRG**, and **BACK** soft keys. The **DME** and **SYN VIS** soft keys will only be present if the system is configured for these features.

BRG1

The **BRG1** soft key cycles through the available bearing 1 indicator modes (NAVI, GPS1, ADF, or None).

BRG2

The **BRG2** soft key cycles through the available bearing 2 indicator modes (NAV2, GPS2, ADF, or None). This soft key will only be present if the system is configured for a second GPS or VOR/LOC.

DME

The **DME NAV** soft keys select the DME submenu. For some installations, the **DME NAV** soft keys simply toggle the DME display on/off as the submenu options will not exist. The availability of the DME controls vary based on the installation.

The **DME NAV** soft keys select NAV 1 or 2 as the DME tuning source. If this soft key is pressed again when already selected, the DME display is removed from the PFD. Not all installations will have both NAV1 and NAV2 soft keys.



Figure 2-5 DME Soft Keys

DME HOLD

DME HOLD activates/deactivates the DME tuning hold function. DME HOLD may be selected for either DME NAV 1 or DME NAV 2. The Hold function is automatically canceled when switching between NAV1 and NAV2 tuning sources. Not all installations will have the **DME HOLD** soft key.

SYN VIS

The **SYN VIS** soft key is available if Synthetic Vision Technology™ is installed. It enables Synthetic Vision and displays the associated soft keys.

SYN TERR

The **SYN TERR** soft key is available if Synthetic Vision Technology™ is installed and enables synthetic terrain depiction.

HRZN HDG

The **HRZN HDG** soft key is available if Synthetic Vision Technology™ is installed. Pressing this key enables horizon heading marks and digits.

APTSIGNS

The **APTSIGNS** soft key is available if Synthetic Vision Technology™ is installed and enables airport sign posts.

BACK

The **BACK** soft key returns to the previous soft key menu.

2.2 Airspeed Indicator

The Airspeed Indicator displays airspeed on a rolling number gauge using a moving tape. The numeric labels and major tick marks on the moving tape are marked at intervals of 10 units, while minor tick marks on the moving tape are indicated at intervals of five units. Speed indication starts at 20 knots, regardless of the displayed units.



NOTE: *Airspeed units (KTS, MPH, KPH) are configured to match the approved units for the installation.*

The Airspeed Indicator provides Indicated Airspeed, True Airspeed, and Ground Speed. The Airspeed Trend Indicator shows what the airspeed will be in six seconds, if the current acceleration is maintained. The actual airspeed is displayed inside the black pointer.

The Airspeed Trend Vector is a vertical, pink/magenta line, extending up or down on the airspeed scale, shown to the right of the color-coded speed range strip. The end of the trend vector corresponds to the predicted airspeed in six seconds if the current acceleration is maintained. If the trend vector crosses into the overspeed range, the text of the actual airspeed readout changes to yellow. The trend vector is absent if the speed remains constant or if any data needed to calculate airspeed is not available due to a system failure.

Foreword
 Sec 1 System
Sec 2 PFD
 Sec 3 MFD
 Sec 4 Hazard Avoidance
 Sec 5 Additional Features
 Sec 6 Annun. & Alerts
 Sec 7 Symbols
 Sec 8 Glossary
 Appendix A
 Appendix B Index

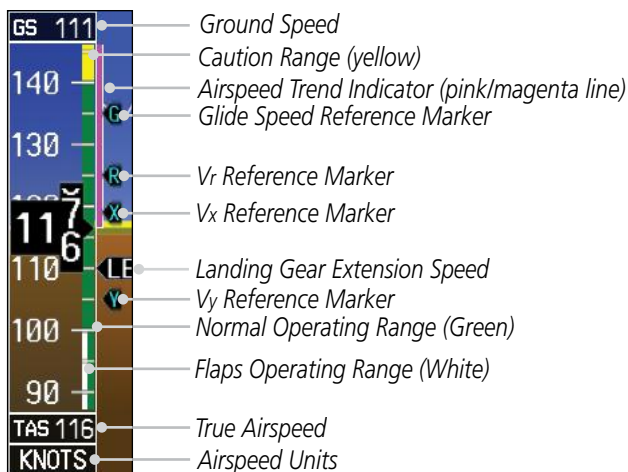

Figure 2-6 Airspeed Tape

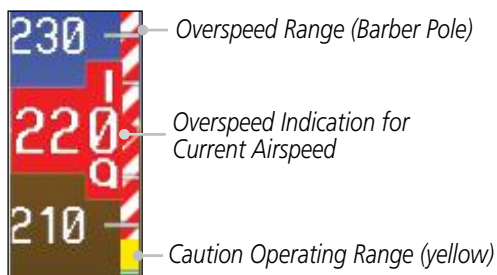

Figure 2-7 Overspeed Indication

2.2.1 Markings

A color-coded (white, green, yellow, and red/white “barber pole”) speed range strip is located on the moving tape. The colors are configured to match the approved markings for the installation. See the AFM/POH.

Foreword

Sec 1
System

Sec 2
PFD

Sec 3
MFD

Sec 4
Hazard
Avoidance

Sec 5
Additional
Features

Sec 6
Annun.
& Alerts

Sec 7
Symbols

Sec 8
Glossary

Appendix A

Appendix B
Index



NOTE: *The actual colors and patterns of the airspeed tape may vary by installation. See your AFM/POH for more details.*

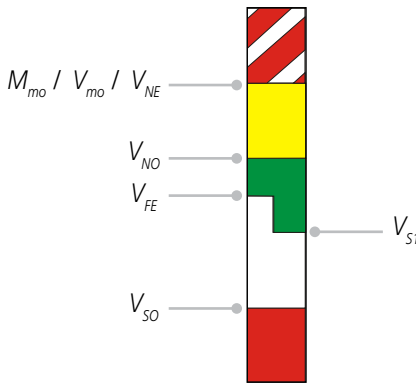

Figure 2-8 Typical Airspeed Tape Markings

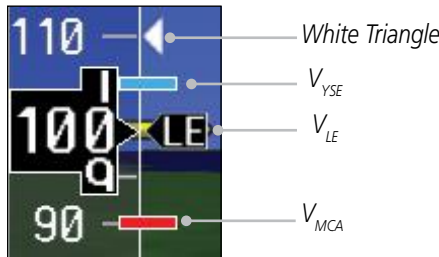

Figure 2-9 Additional Reference Markings

2.2.2 Reference Speeds

V-speeds (Glide, V_r , V_x , and V_y) default values are set during the installation process, but can be changed and turned on/off from the System Setup page on the first page of the Aux page group. When active (on), the V-speeds are displayed at their respective locations to the right of the airspeed scale.

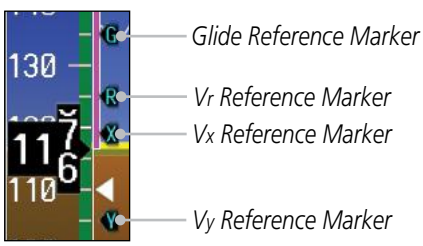

Figure 2-10 Reference Speeds

The labels for the reference markers may vary as configured during installation.

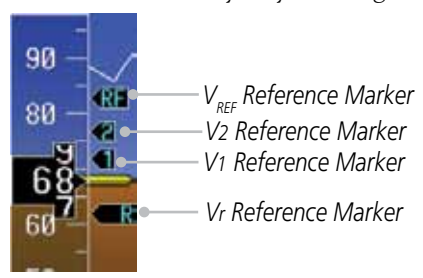

Figure 2-11 Alternate Reference Speeds

Foreword

Sec 1 System

Sec 2 PFD

Sec 3 MFD

Sec 4 Hazard Avoidance

Sec 5 Additional Features

Sec 6 Annun. & Alerts

Sec 7 Symbols

Sec 8 Glossary

Appendix A

Appendix B Index

2.3 Attitude Indicator

Attitude information is displayed over a virtual blue sky and brown ground with a white horizon line. The Attitude Indicator displays pitch, roll, and slip/skid information.

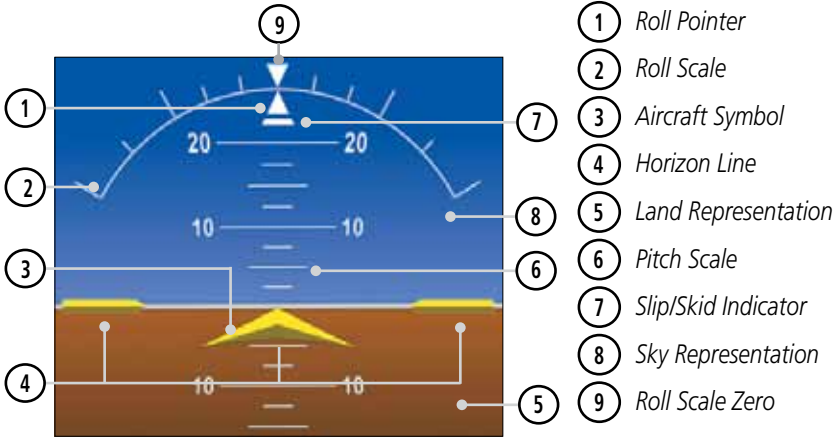

Figure 2-12 Attitude Indicator

The horizon line is part of the pitch scale. Above and below the horizon line, major pitch marks and numeric labels are shown for every 10°, up to 80°. Minor pitch marks are shown for intervening 5° increments, up to 25° below and 45° above the horizon line. Between 20° below to 20° above the horizon line, minor pitch marks occur every 2.5°.

Angle of bank is indicated by the position of the pointer on the roll scale. Major tick marks are 30° and 60° and minor tick marks are 10°, 20°, and 45° are shown to the left and right of the zero.

The Slip/Skid Indicator is the bar beneath the roll pointer. The indicator moves with the roll pointer and moves laterally away from the pointer to indicate lateral acceleration. Slip/skid is indicated by the location of the bar relative to the pointer. One bar displacement (as shown below) is equal to one ball displacement on a traditional Slip/Skid Indicator.

Foreword
 Sec 1 System
 Sec 2 PFD
 Sec 3 MFD
 Sec 4 Hazard Avoidance
 Sec 5 Additional Features
 Sec 6 Annun. & Alerts
 Sec 7 Symbols
 Sec 8 Glossary
 Appendix A
 Appendix B Index

Foreword
 Sec 1 System
 Sec 2 PFD
 Sec 3 MFD
 Sec 4 Hazard Avoidance
 Sec 5 Additional Features
 Sec 6 Annun. & Alerts
 Sec 7 Symbols
 Sec 8 Glossary
 Appendix A
 Appendix B Index

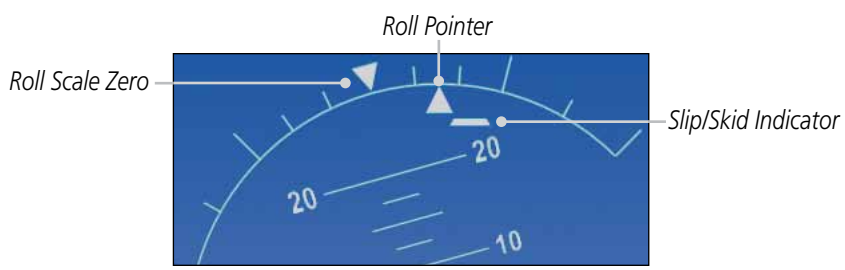

Figure 2-13 Slip/Skid Indication

The standby mechanical Attitude Indicator in your aircraft is either a Ground Pointer or a Roll Pointer configuration. The GDU 620 Attitude Indicator has been configured in either a Ground Pointer or a Roll Pointer configuration to match the configuration of your aircraft's standby Attitude Indicator. Ground/Sky Pointer mode is configured during installation and can not be changed by the pilot.

In an aircraft with an Attitude Indicator that has a Ground Pointer, the pointer above the Roll Scale shifts with the roll or bank angle of the aircraft to keep the Roll Scale Zero Pointer pointing towards the ground.

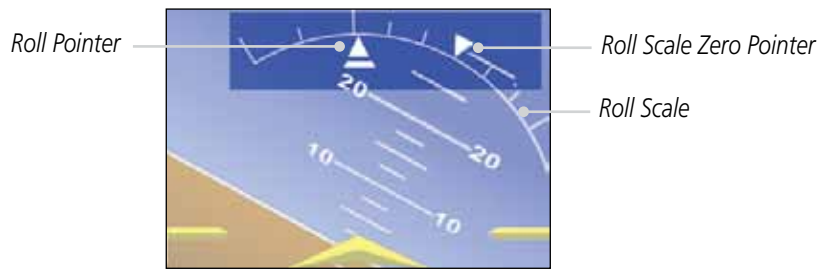
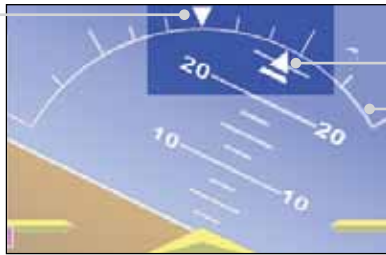

Figure 2-14 Attitude Indicator with a Ground Pointer configuration in a left turn

In an aircraft with an Attitude Indicator that has a Sky Pointer, the pointer below the roll scale shifts with the roll or bank angle of the aircraft to keep the Roll Pointer pointing towards the sky.

Roll Scale Zero Pointer



Roll Pointer
Roll Scale

Figure 2-15 Attitude Indicator with a Sky Pointer configuration in a left turn

2.3.1 Extreme Attitude

Extreme attitude is defined as a roll greater than 65° left or right, 30° pitch up, or 20° pitch down. Red chevrons are displayed at greater than 50° pitch up and 30° pitch down. The PFD will “decluster” when the aircraft enters an extreme attitude. Only the primary functions will be displayed in these situations.

The following information is removed from the PFD (and corresponding soft keys are disabled) when the aircraft is in an unusual attitude:

- PFD Knob Mode Annunciations
- Ground Speed, True Airspeed, and Airspeed Units
- Selected Altitude, Barometer Settings, and Selected Vertical Speed
- Vertical Course Deviation Indicator
- Traffic and Terrain Annunciations
- Flight Director Command Bars
- Radar Altimeter digital readout
- Marker beacon annunciation
- Fast/Slow indicator
- DME field



Figure 2-16 Extreme Pitch Indication

Foreword

Sec 1
System

Sec 2
PFD

Sec 3
MFD

Sec 4
Hazard
Avoidance

Sec 5
Additional
Features

Sec 6
Annun.
& Alerts

Sec 7
Symbols

Sec 8
Glossary

Appendix A

Appendix B
Index



Figure 2-17 Extreme Pitch Indication Nose Down

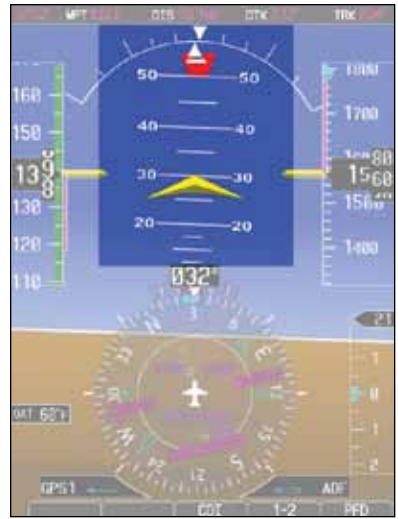

Figure 2-18 Extreme Pitch Indication Nose Up



Figure 2-19 Extreme Roll Indication with Display Declutter

2.4 Altimeter

The altimeter displays the current altitude, altitude trend, altitude bug setting, altitude bug, and the current BARO setting.

The Altitude Trend Vector is a vertical, magenta line, extending up or down on the left side of the Altitude scale. The end of the trend vector corresponds to the predicted altitude in six seconds if the current vertical speed is maintained.

The Altitude Bug is displayed at the selected Altitude Bug setting. A portion of the Altitude Bug will be displayed at the top or the bottom of the altitude tape if the selected Altitude Bug is off of the tape.

When an optional Radar Altimeter is installed, the altitude received from the radar altitude will be displayed on the PFD. See the Radar Altimeter section for more details.

2.4.1 Setting the Altitude Bug and Alerter

- 1) Press the **ALT** key to activate Altitude mode.
 - 2) Turn the **PFD** knob to move the Altitude Bug to a desired altitude.
- OR
- 3) Press the center of the **PFD** knob to set the selected altitude to the current altitude.

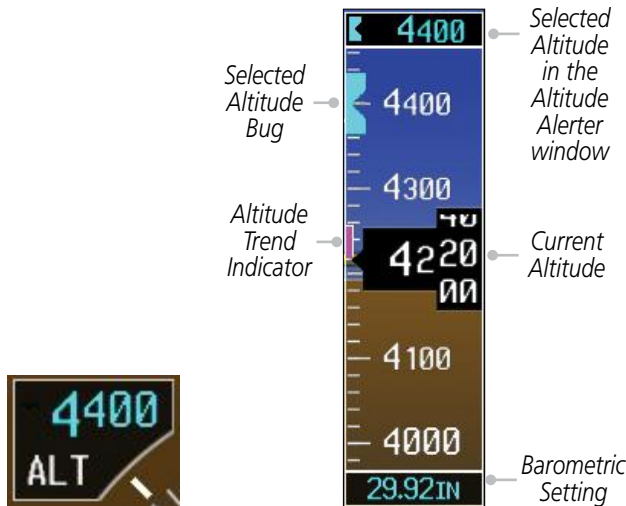

Figure 2-20 Altimeter

2.4.2 Altitude Alerting

The Altitude Alerting function provides the pilot with visual and aural alerts (if interfaced to an audio panel) when approaching the Selected Altitude. Whenever the Selected Altitude is changed, the Altitude Alerter is reset.



NOTE: *The Altitude Alerter function may be disabled in some installations. When the Altitude Alerter is disabled, pressing the ALT key will result in an "ALT KEY INOP" message.*

The following occur when approaching the Selected Altitude:

- Upon passing through 1000 feet of the Selected Altitude, the Selected Altitude (shown above the Altimeter) changes to black text on a light blue background, and flashes for five seconds. An audio alert may be generated, if configured.
- When the aircraft passes within 200 feet of the Selected Altitude, the Selected Altitude changes to light blue text on a black background and flashes for five seconds and an aural tone may be generated, if configured.
- After reaching the Selected Altitude, if the pilot flies outside the deviation band (beyond ± 200 feet of the Selected Altitude), the Selected Altitude changes to yellow text on a black background, flashes for five seconds, and an aural tone is generated.



Figure 2-21 Altitude Alerting Visual Annunciations



NOTE: *The aural tone when approaching the selected altitude may be configured at installation for either 200 feet or 1000 feet. The tone when deviating from the selected altitude always occurs at 200 feet.*

2.4.3 Changing Barometric Setting

The Barometric Setting affects the altitude values shown on the PFD. Barometric pressure units may be displayed as either inches (in) or hectopascals (hpa). See *System Display Units* in Section 3 for more detail.

- 1) Press the **BARO** key to activate Baro mode.
- 2) Turn the **PFD** knob to increase or decrease the altimeter setting. OR



Figure 2-22 Barometric Setting

- 3) Press the **PFD** knob while in Baro mode to toggle between Standard Pressure (29.92 in) and the currently selected barometric setting.

2.4.4 Minimum Descent Altitude/Decision Height Alerting

For altitude awareness, a Minimum Descent Altitude (MDA) or Decision Height (DH) alert can be displayed on the PFD. The values are set in the Active Flight Plan page or from the Charts page menu. When active, the minimum descent altitude setting is displayed in the minimums window at the bottom left of the Altitude Tape when you are within 2500 feet of the selected minimum altitude.



NOTE: *The Altitude Minimums Alerting Bug appears parked at the bottom of the altitude tape as soon as a value is set in the minimums alerter. The bug will unpark and start to move up the tape as soon as the altitude is within the range of the tape. The bug is reset when power is cycled.*

The following visual annunciations occur when approaching the MDA/DH:

- When the aircraft altitude descends to within 2500 feet of the selected altitude setting, the Minimums box appears with the altitude value in cyan text.
- When the aircraft is within 100 feet of the selected altitude setting, the bug and text turn white.
- Once the aircraft reaches the selected altitude minimums setting, the bug and the altitude text turn yellow and the aural alert “Minimums, minimums,” is heard one time. The text remains in yellow until the aircraft altitude is more than 50 feet above the set altitude minimum value.

Foreword
 Sec 1 System
 Sec 2 PFD
 Sec 3 MFD
 Sec 4 Hazard Avoidance
 Sec 5 Additional Features
 Sec 6 Annun. & Alerts
 Sec 7 Symbols
 Sec 8 Glossary
 Appendix A
 Appendix B Index

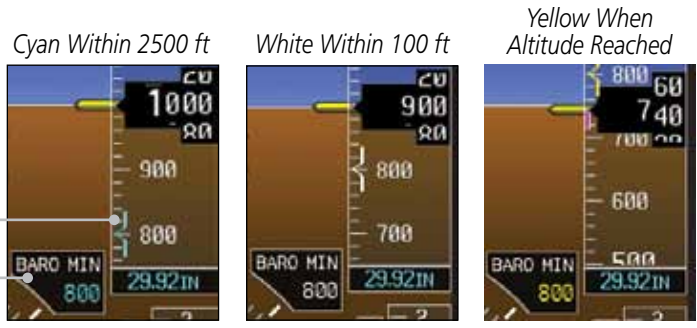

Figure 2-23 Barometric MDA/DH Alerting Visual Annunciations

Alerting is inhibited while the aircraft is on the ground and until the aircraft reaches 150 feet above the selected Minimum Altitude. Normally the altitude alerter only allows selection of altitudes in 100 foot increments. When a value other than 100 feet is set for Baro Mins, it becomes a selectable value in the altitude alerter.

In dual installations, the minimums alerting altitude value may be set from either GDU 620 and will be synchronized on both units.

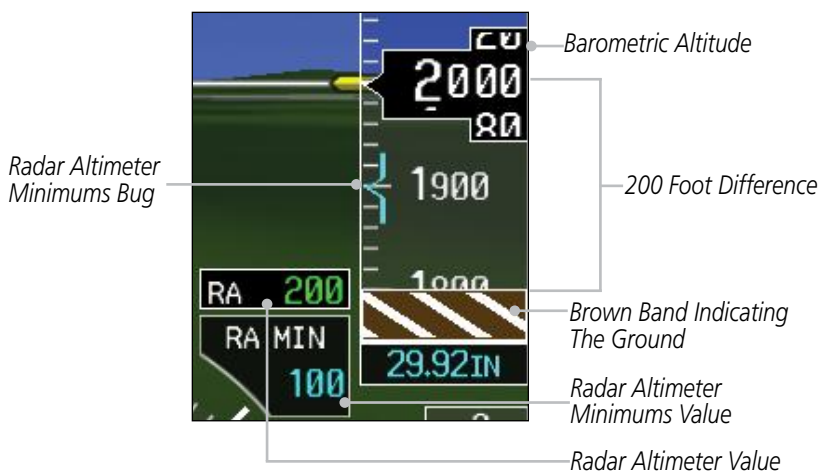

Figure 2-24 Minimums Values with a Radar Altimeter

Setting the Altitude Minimums Bug is performed on either the FPL - Active Flight Plan page or the FPL - Charts page.

For details for setting the Altitude Minimums Bug on the Active Flight Plan page, refer to Section 3 - MFD - Flight Plan Pages.

For details for setting the Altitude Minimums Bug on the Charts page, refer to Section 5 - Additional Features - Charts Menu Selections.



NOTE: *If you highlight the minimums Altitude field and hit the CLR key, it will turn the minimums alerting functionality off.*

2.5 Vertical Speed (V/S) Indicator

Vertical speed data is presented on the bottom right of the PFD. A Vertical Speed bug and a bug setting are also available.

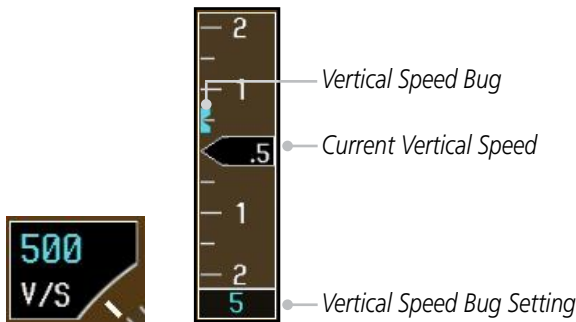

Figure 2-25 Vertical Speed (V/S) Tape and Window

The Vertical Speed Indicator displays the aircraft vertical speed using a non-moving tape. The tape can be scaled at ± 2000 , ± 3000 , or ± 4000 fpm as set by the installer. Major gradations are every 1000 fpm and minor gradations every 500 fpm. The current vertical speed is displayed in the pointer along the tape. Digits appear in the pointer when the climb or descent rate is greater than 100 fpm. If the rate of ascent/descent exceeds the vertical speed displayed on the tape, the pointer appears at the corresponding edge of the tape and the rate appears inside the pointer. The Vertical Speed Indicator range determines the airspeed tape range.

VSI (set by installer)	Airspeed Tape Range
± 2000 fpm	60 kts
± 3000 fpm	70 kts
± 4000 fpm	80 kts

Table 2-1 Vertical Speed Settings

Setting the Vertical Speed Indicator Bug

- 1) Press the **V/S** key to activate Vertical Speed mode.
- 2) Turn the **PFD** knob to change the Vertical Speed Bug.
- 3) Press the center of the **PFD** knob to set the Vertical Speed value to the current vertical speed.

2.6 Horizontal Situational Indicator

The Horizontal Situation Indicator (HSI) displays a rotating compass card in a heading-up orientation. Letters indicate the cardinal points and numeric labels occur every 30°. Major tick marks are at 10° intervals and minor tick marks at 5° intervals. A digital reading of the current heading appears on top of the HSI, and the current ground track is represented on the HSI by a magenta diamond. The HSI also presents turn rate, course deviation, bearing, and navigation source information. The “MSG” annunciation will be shown in the HSI when an unacknowledged message is present on the selected navigator. When the message is acknowledged, the “MSG” annunciation will clear.

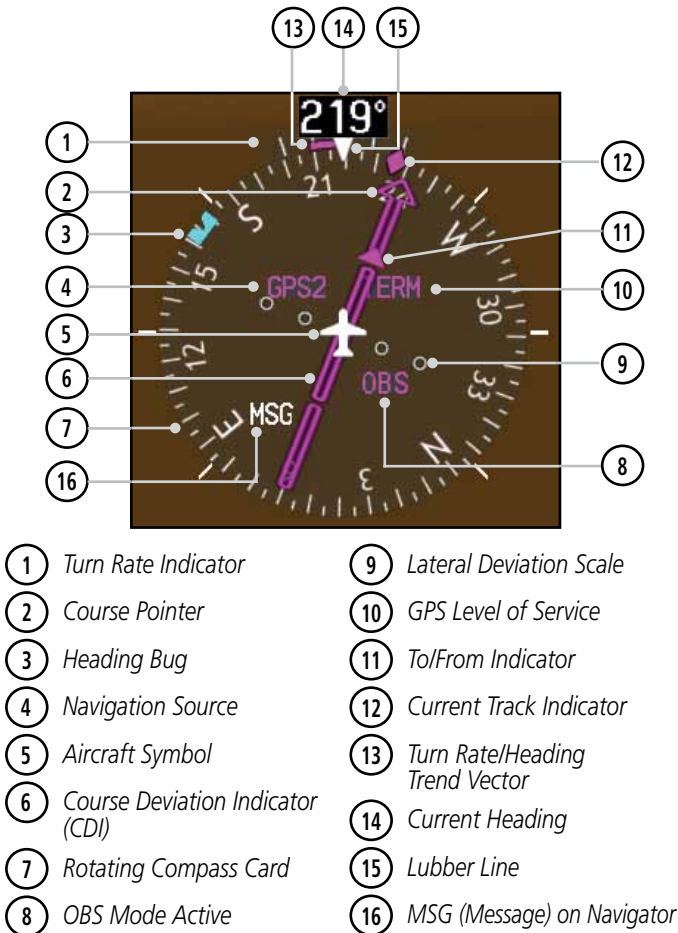

Figure 2-26 Horizontal Situation Indicator (HSI)

The 360° HSI contains a Course Deviation Indicator (CDI), with a Course Pointer, To/From Indicator, and a sliding deviation bar and scale. The course pointer is a single line arrow (GPS1, VOR1, and LOC1) or a double line arrow (GPS2, VOR2, and LOC2) which points in the direction of the set course. “LOC” will automatically be displayed if a localizer frequency is tuned. The To/From arrow rotates with the course pointer and is displayed when the active NAVAID is received.

2.6.1 Setting the Heading Bug

The Selected Heading is shown to the upper left of the HSI for 10 seconds after being adjusted. The light blue bug on the compass rose corresponds to the Selected Heading.



NOTE: The current heading will have a "T" to the right of the heading value when the Nav Angle is set to True in the System Setup page of the Aux page group.



Figure 2-27 Heading Bug Setting

- 1) Press the **HDG** key to activate HDG mode.
 - 2) Turn the **PFD** knob to change the Heading Bug.
- OR
- 3) Press the **PFD** knob in HDG mode to set the Heading Bug to the current heading.

2.6.2 Turn Rate Indicator

The Turn Rate Indicator is located directly above the rotating compass card. Tick marks to the left and right of the lubber line denote half-standard and standard turn rates. A magenta Turn Rate Trend Vector shows the current turn rate. The end of the trend vector gives the heading predicted in six seconds, based on the present turn rate. A standard-rate turn is shown on the indicator by the trend vector stopping at the standard turn rate tick mark, corresponding to a predicted heading of 18° from the current heading. At rates greater than four deg/sec, an arrowhead appears at the end of the magenta trend vector and the prediction is no longer valid.



Figure 2-28 Turn Rate Indicator and Trend Vector

2.7 Course Deviation Indicator

The Course Deviation Indicator (CDI) moves left or right from the course pointer along a lateral deviation scale to display aircraft position relative to the course. If the course deviation data is not valid, the CDI is not displayed.

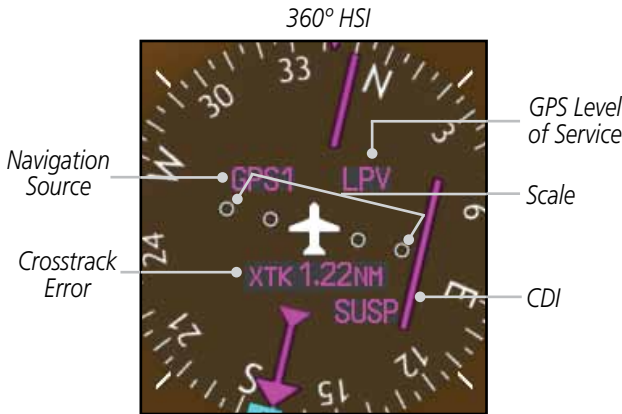

Figure 2-29 Course Deviation Indicator

Foreword

Sec 1
System

Sec 2
PFD

Sec 3
MFD

Sec 4
Hazard
Avoidance

Sec 5
Additional
Features

Sec 6
Annun.
& Alerts

Sec 7
Symbols

Sec 8
Glossary

Appendix A

Appendix B
Index



NOTE: The ILS Localizer and Glideslope deviation indicators will indicate full-scale deflection for the GNS 480 navigator at the second dot. The GNS 400W/500W series navigators will indicate full-scale deflection at the edge of the display.

2.7.1 Changing CDI Sources

The CDI can display two sources of navigation: GPS or NAV (VOR, and LOC). Color indicates the current navigation source: magenta (for GPS) or green (for VOR and LOC). The full-scale limits for the CDI are defined by a GPS-derived distance when coupled to GPS. When coupled to a VOR or localizer (LOC), the CDI has the same angular limits as a mechanical CDI. If the CDI exceeds the maximum deviation on the scale (two dots) while coupled to GPS, the crosstrack error (XTK) is displayed below the white aircraft symbol.

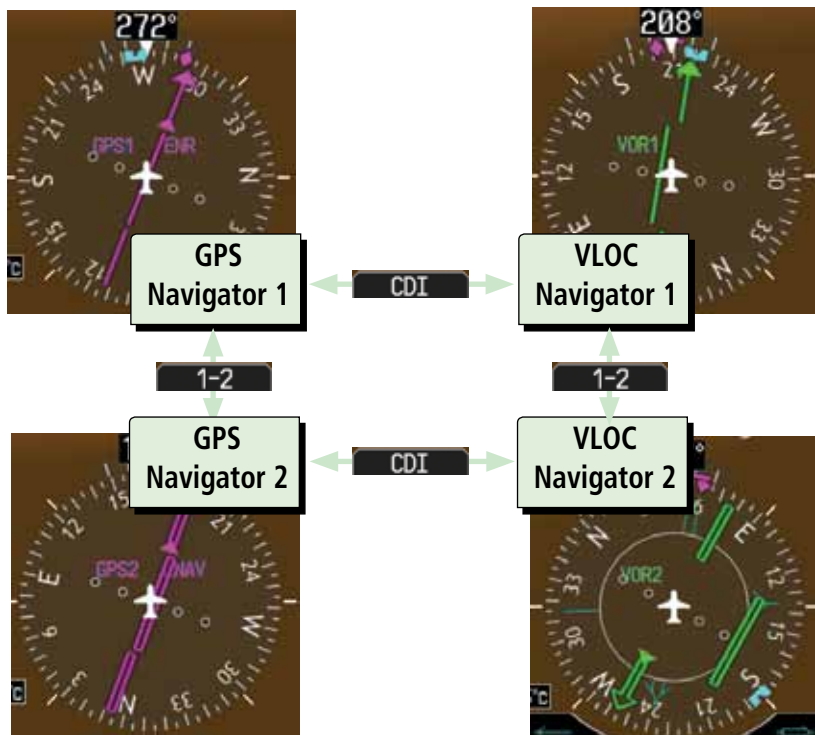

Figure 2-30 CDI Navigation Sources

- 1) Press the **CDI** soft key to toggle between GPS and VOR/LOC source type.
- 2) Press **1-2** soft key to toggle between the 1 and 2 navigators of the GPS or VOR/LOC sources.
- 3) Verify the navigation source by the indication on the HSI and in the upper left corner of the PFD.



NOTE: The selected navigator is the active navigator for all PFD and MFD operations, except for the supplemental bearing pointers.

2.7.2 Changing CDI Course

The Selected Course is shown to the upper left of the HSI for 10 seconds after being adjusted.



Figure 2-31 Course Setting

- 1) Press the **CRS** key to activate Course mode.
- 2) Turn the **PFD** knob to change the Course values.
OR
- 3) Press the **PFD** knob to set a Course that will center the CDI to the VOR station or waypoint if in GPS OBS mode.

2.7.3 Vertical Deviation Indicator (VDI)

The Vertical Deviation (Glideslope) Indicator (VDI) appears to the left of the VSI whenever an ILS frequency is tuned in the active NAV field. A green diamond acts as the VDI Indicator, like a glideslope needle on a conventional indicator. If a localizer frequency is tuned and there is no glideslope signal, “NO GS” is annunciated. The glideslope on an ILS approach is only shown if the current heading is within 90° of the selected course. This prevents the glideslope from being displayed during localizer backcourse approaches.

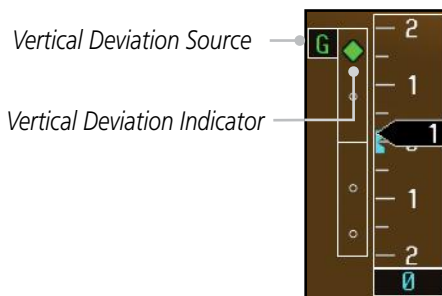

Figure 2-32 Vertical Deviation Indicator (ILS Source)

The vertical deviation is similar to the glideslope for GPS approaches supporting WAAS vertical guidance (LNAV+V, L/VNAV, LPV). When an approach of this type is loaded into the flight plan and GPS is the selected navigation source, the Vertical Deviation Indicator appears as a magenta diamond. If the approach type downgrades to LNAV past the final approach fix (FAF), or the approach only supports LNAV service, “NO GP” is annunciated.

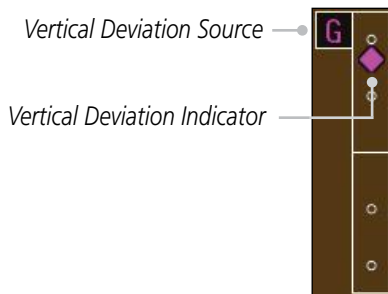

Figure 2-33 Vertical Deviation Indicator (GPS Source)

2.7.4 Auto-Slewing

The G500 system is designed to interface with GNS navigator units and also manage up to four different CDI course pointers (GPS1, NAV1, GPS2, NAV2) independently. The G500 will automatically slew the NAV course pointer to the correct final approach course when a ILS, LOC, LOC BC, LDA or SDF approach is active in the GNS navigator and the appropriate frequency is in the active window in the navigator. The G500 will Auto-Slew the HSI course pointer for an ILS, LOC, LOC BC, LDA, or SDF approach when the steps below are completed in the following order:

- 1) The desired approach is selected and activated in the navigator (this can be verified by the approach waypoints appearing on the GDU620 MFD Nav Map Page or FPL Page).
- 2) The appropriate frequency is the active frequency in the navigator.
- 3) The CDI selection on the GDU 620 is changed to NAV course pointer for the active navigator.



NOTE: *If the NAV course pointer is displayed for the active navigator when the approach is activated and the localizer frequency is tuned, the pilot will need to switch to another CDI source and then back to NAV for the course pointer to Auto-Slew.*

*For example, if NAV1 is currently selected, the pilot must:
press the CDI soft key twice: NAV1>GPS1>NAV1
OR
press the 1-2 soft key twice: NAV1>NAV2>NAV1*



NOTE: *For LOC BC approaches, the course pointer will slew 180 degrees from the inbound course.*

Example of activating Auto-Slewing in the G500:

Foreword

Sec 1
System

Sec 2
PFD

Sec 3
MFD

Sec 4
Hazard
Avoidance

Sec 5
Additional
Features

Sec 6
Annun.
& Alerts

Sec 7
Symbols

Sec 8
Glossary

Appendix A

Appendix B
Index

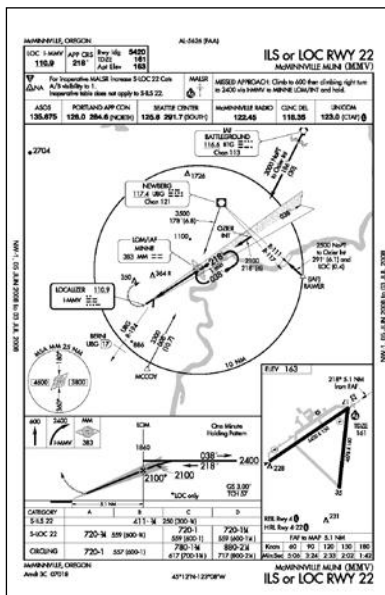

Figure 2-34 Auto-Slewing HSI with ILS Loaded and Shown with the Corresponding Approach Plate

- 1) The aircraft is flying vectors to final on an active ILS approach, with the appropriate approach in the GNS navigator.
- 2) The appropriate ILS frequency must be activate in the navigator.
- 3) Verify that the waypoints for the approach are displayed on the Nav Map Page or the FPL Page of the MFD.
- 4) Upon approaching the final course, select LOC on the HSI.



NOTE: If auto CDI switching is active on the GNS unit, the GNS will force the GNS/GDU 620 to NAV when the aircraft is close to the LOC course.

- 5) The CDI and course pointer will change from magenta to green and the pointer will move, or slew, to the final approach course (or 180° from the final approach course for LOC BC approaches).

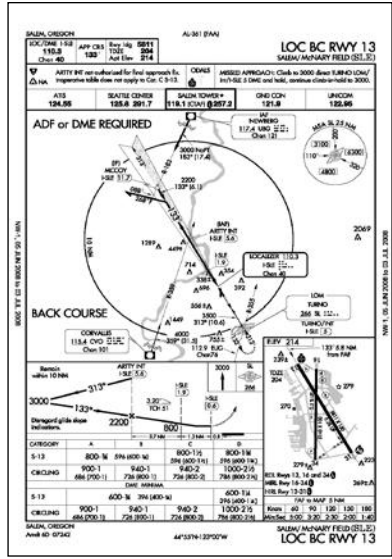

Figure 2-35 Auto-Slewing HSI with Localizer Backcourse Loaded and Shown with the Corresponding Approach Plate

2.8 Supplemental Flight Data

2.8.1 Bearing Pointers

Two Bearing Pointers can be displayed on the HSI for NAV and GPS sources. The pointers are light blue and are single- (BRG1) or double-lined (BRG2); an icon is shown in the respective information window to indicate the pointer type. The system must be configured for a second navigation source to show the BRG2 selection.

When a Bearing Pointer is displayed, its associated information window is also displayed.

The Bearing Information windows are displayed to the lower sides of the HSI and show:

- Bearing source (GPS, NAV, or ADF)
- Pointer icon (BRG1 = single line, BRG2 = double line)

The Bearing Pointer is removed from the HSI if:

- The NAV radio is not receiving the tuned VOR station
- The NAV radio is tuned to a Localizer frequency

- GPS is the bearing source and an active waypoint is not selected
- ADF is selected and a signal is not received (if you have an ADF that supports a valid flag then the bearing pointer will be removed. If your ADF system does not include a valid flag then the bearing pointer will still be displayed, regardless of ADF signal validity.)

Foreword
Sec 1 System

Sec 2 PFD

Sec 3 MFD

Sec 4 Hazard Avoidance

Sec 5 Additional Features

Sec 6 Annun. & Alerts

Sec 7 Symbols

Sec 8 Glossary

Appendix A

Appendix B Index

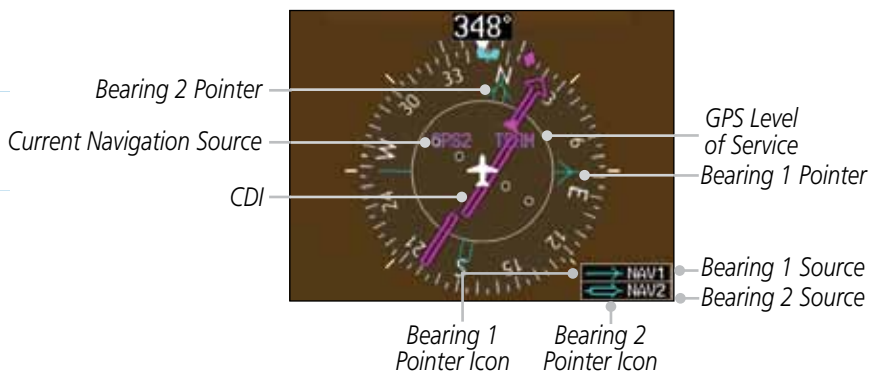

Figure 2-36 HSI with Bearing Information

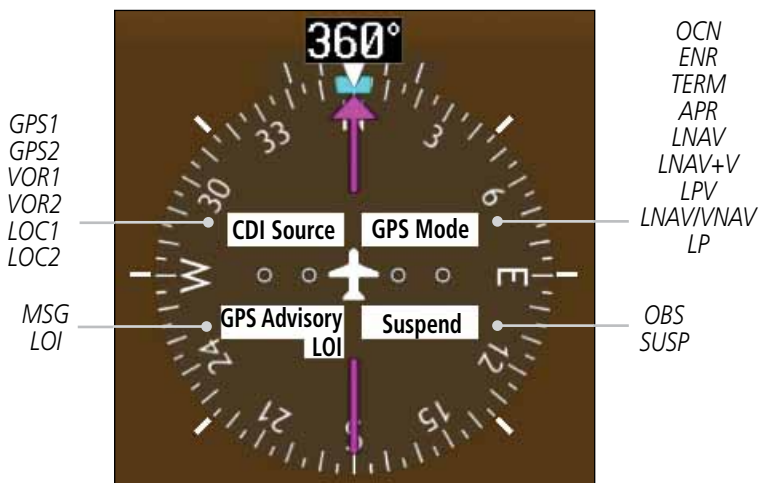

Figure 2-37 PFD HSI Annunciations

- 1) Press the **PFD** soft key to display the navigation source keys.
- 2) Press the **BRG 1** or **BRG 2** soft keys to toggle between the available Nav receivers of the selected source (such as: GPS, NAV, or ADF).

NOTE: The Bearing Line for navigation source 1 (BRG1) will be a single line. The Bearing Line for navigation source 2 (BRG2) will be a double line.

2.8.2 Temperature Display

The Outside Air Temperature (OAT) is displayed to the left of the HSI. The OAT can be displayed in °F or °C, which is configured in the Aux System Setup Page. The temperature is derived from the Temperature Probe on the aircraft. The displayed temperature is the Static Air Temperature reported by the Air Data Computer. This temperature value is corrected for ram air heating effects.



Figure 2-38 HSI Outside Air Temperature

2.8.3 Wind Vectors

When selected, wind vector information is displayed in a window on the PFD to the left of the HSI. The Wind Vector style is configured in the Aux Mode System Setup page. While on the ground, the Wind Vector window will indicate “No Wind Data.”



Figure 2-39 Wind Vector with No Wind Data

Four styles are available as shown below.



Figure 2-40 Wind Vector Style

2.8.4 DME Indication

When selected, DME information is displayed in a window in the lower left corner of the PFD. The distance to the station and the Nav source used are shown.



Figure 2-41 DME Indication



NOTE: The capability of providing DME information requires installation of the GAD 43e.

2.8.5 Marker Beacon Annunciations

A visual annunciation of marker beacons will be shown on the display when the aircraft flies over a marker beacon. The marker beacon annunciation will appear to the left of the altitude tape below the terrain annunciator on the PFD.



Figure 2-42 Marker Beacon Location

Current Beacon	Icon (Standard)	Icon (Blink)	Blink Interval
Inner Marker			250 ms
Middle Marker			333 ms
Outer Marker			750 ms

Table 2-2 Marker Beacons

2.8.6 Miscompare Annunciations

Miscompare annunciations are capable of being displayed on the PFD if the AHRS/Air Data Monitor is enabled during the installation configuration.

Messages will appear in the MFD Alerts window if data is not available for the monitor.

A miscompare condition is triggered if the difference between the data reported by GDU 1 and GDU 2 exceeds the threshold described in the following table for at least one second:

Parameter	Range of Trigger	Threshold
Altitude	ALL	200 ft
Indicated Airspeed	Both IAS < 35 kts	Inhibited
Indicated Airspeed	Either IAS >= 35 kts	10 kts
Indicated Airspeed	Either IAS >= 80 kts	7 kts
Pitch	ALL	5 degrees
Roll	ALL	6 degrees

Table 2-3 Mismatch Conditions

A “MISCOMP” annunciation is displayed on the airspeed tape if a mismatch condition exists for indicated airspeed. A “MISCOMP” annunciation is displayed on the altitude tape if a mismatch condition exists for altitude. A “PITCH MISCOMP” annunciation is displayed over the pitch ladder if a mismatch condition exists for pitch and not roll. A “ROLL MISCOMP” annunciation is displayed over the pitch ladder if a mismatch condition exists for roll and not pitch. An “ATTITUDE MISCOMP” annunciation is displayed over the pitch ladder if a mismatch condition exists for both pitch and roll.

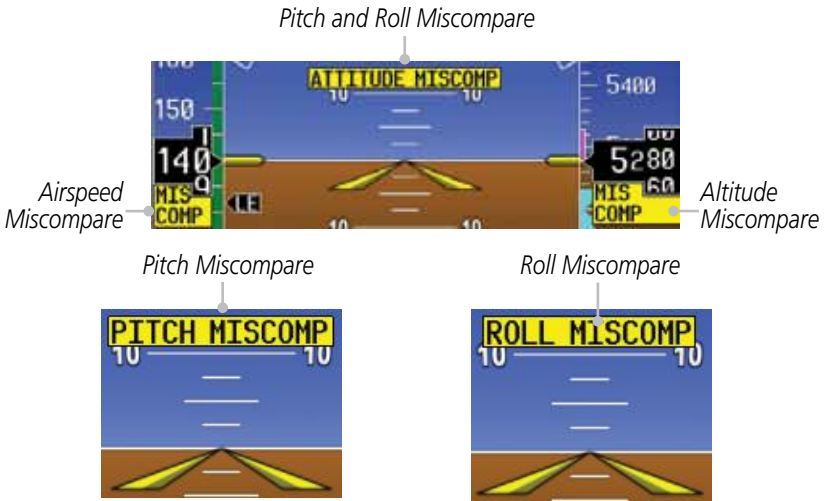

Figure 2-43 Mismatch Annunciations

Foreword

Sec 1
System

Sec 2
PFD

Sec 3
MFD

Sec 4
Hazard Avoidance

Sec 5
Additional Features

Sec 6
Annun. & Alerts

Sec 7
Symbols

Sec 8
Glossary

Appendix A

Appendix B
Index

2.9 Radar Altimeter

When an optional Radar Altimeter is installed, the altitude received from the radar altitude will be displayed on the PFD.



NOTE: See the Radar Altimeter documentation for details on the radar altimeter performance and limitations.

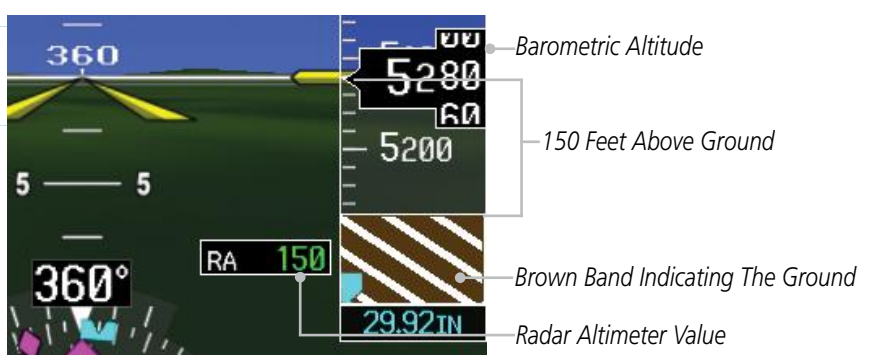

Figure 2-44 Radar Altimeter Display - 150 foot RA Altitude

When the radar altitude is 0, the brown band will be level with the altitude tape pointer. As the radar altitude increases above 0, the brown band will move down the tape in an amount equal to the current radar altitude.

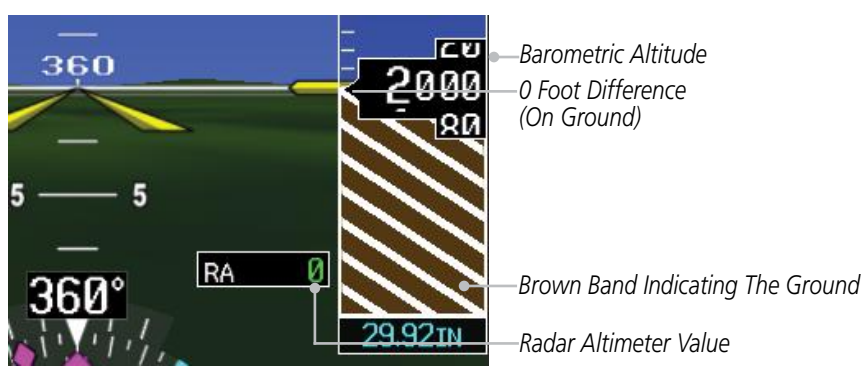

Figure 2-45 Radar Altimeter Display - 0 foot RA Altitude

The Radar Altimeter self-test process will be annunciated on the PFD above the Radar Altimeter altitude value. The self-test is a wiring test to indicate communication between the GDU and the Radar Altimeter. The self-test will be cancelled after 15 seconds, the Test key is pressed again, or you leave the System Setup page.



NOTE: *Not all Radar Altimeters have the TEST function.*

- 1) Turn the large **MFD** knob to Aux mode and then turn the small **MFD** knob to the System Setup page.
- 2) Press the **RA TEST** key. "RA TEST" will be annunciated above the Radar Altimeter value. The Radar Altimeter value will show a certain number to indicate that communication is taking place between the Radar Altimeter and the GDU. See your Radar Altimeter documentation for the appropriate value.



Figure 2-46 Radar Altimeter Test Annunciation

- 3) Press the **RA TEST** key again to stop the self-test.
- 4) If the unit fails the self-test, the RA value will not match the expected value. The "RA FAIL" annunciation will appear on the PFD when the GDU is not receiving any Radar Altimeter data. "RA FAIL" is not related to the self-test.



Figure 2-47 Radar Altimeter Failure Annunciation

2.10 Fast/Slow Indication

The Fast/Slow indication as provided from an external system is shown on the left side of the PFD along the horizon line. See your AFM for details on operation.

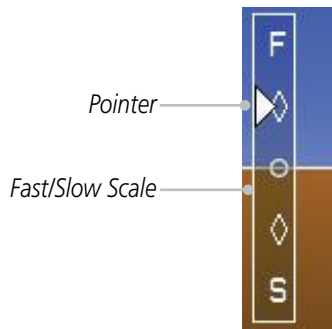

Figure 2-48 Fast/Slow Scale and Pointer

2.11 PFD Display Units

The PFD display units may be set to standard or metric units by the installer. The MFD display units may still be selected by the user in the System Setup page of Aux mode.

Foreword

Sec 1
System

**Sec 2
PFD**

Sec 3
MFD

Sec 4
Hazard
Avoidance

Sec 5
Additional
Features

Sec 6
Annun.
& Alerts

Sec 7
Symbols

Sec 8
Glossary

Appendix A

Appendix B
Index

3 MULTI-FUNCTION DISPLAY (MFD)

The MFD displays a color moving map with navigation information. Moving map information is shown on the two Navigation Map pages and the optional Weather (WX) pages (requires a datalink and subscription or the GWX 68 Weather Radar). The Navigation Map displays aviation data (e.g., airports, VORs, airways, airspaces), geographic data (e.g., cities, lake, highways, borders), topographic data (map shading indicating elevation), and hazard data (e.g., traffic, terrain, weather). The map options set for Navigation Map page 1 are used as the default settings for the optional Weather (WX) pages. The amount of displayed data can be reduced by pressing the **DCLTR** soft key. The Navigation Map can be oriented four different ways: North Up (NORTH UP), Track Up (TRACK UP), Desired Track Up (DTK UP), or Heading Up (HDG UP).

Foreword

System Sec 1

PFD Sec 2

MFD Sec 3

Avoidance Sec 4

Hazard

Additional Features Sec 5

Annun. & Alerts Sec 6

Symbols Sec 7

Glossary Sec 8

Appendix A

Appendix B Index

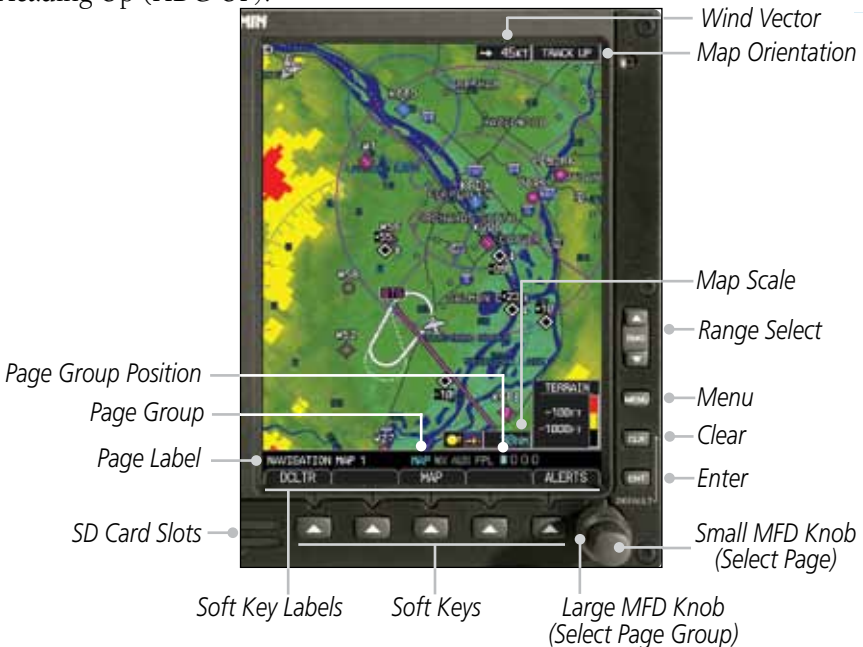

Figure 3-1 MFD Description

The nose of the aircraft icon is placed on the Navigation Map at the location corresponding to the calculated present position. The aircraft position and the flight plan legs are based on information received from the currently selected GPS navigator. The leg of the active flight plan currently being flown is shown as a magenta line on the navigation map. The other legs are shown in white.

There are 28 different map ranges available, from 500 feet to 2000 NM. The current range is indicated in the lower right corner of the map and represents the top-to-bottom distance covered by the map. To change the map range on any map, press the **RNG** keys on the right side of the bezel.

3.1 Functional Display Map

Turn large MFD knob to change page groups

Turn small MFD knob to select pages within a group

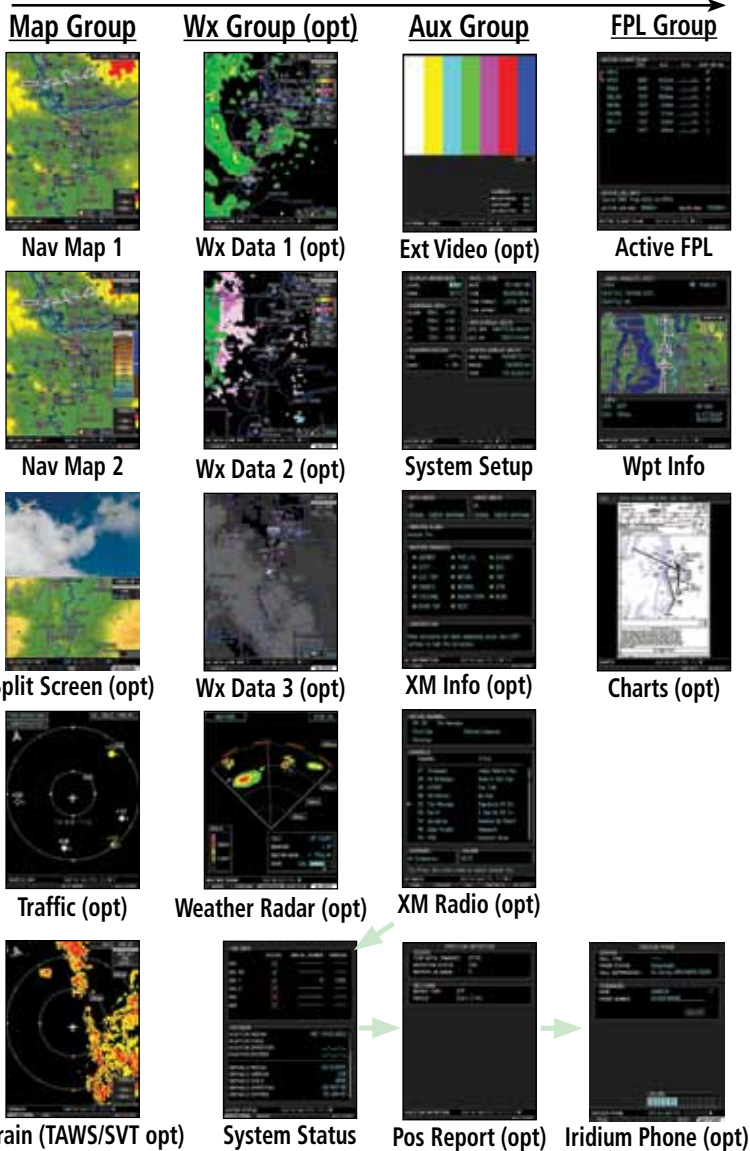
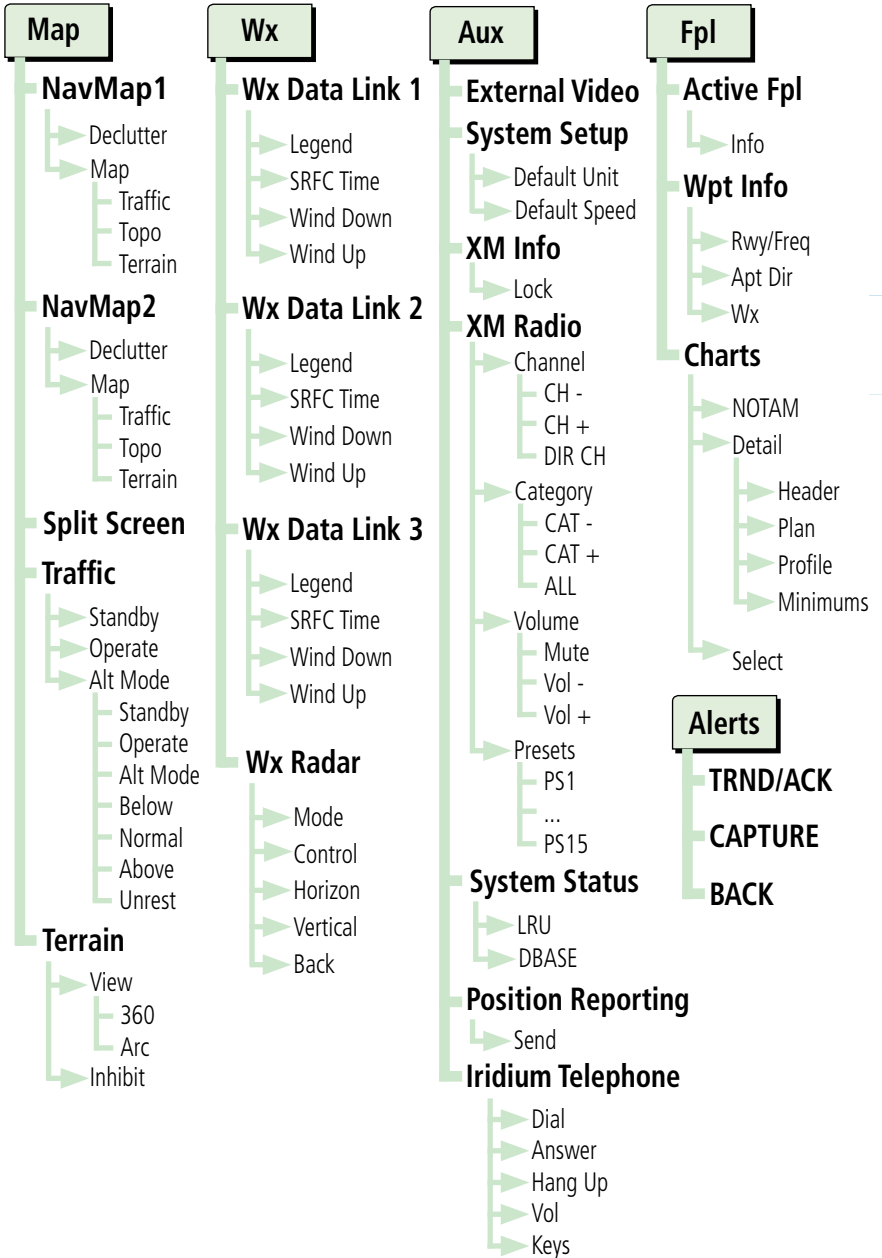

Figure 3-2 MFD Page Groups

Foreword
 Sec 1 System
 Sec 2 PFD
 Sec 3 **MFD**
 Sec 4 Hazard Avoidance
 Sec 5 Additional Features
 Sec 6 Annun. & Alerts
 Sec 7 Symbols
 Sec 8 Glossary
 Appendix A
 Appendix B Index

3.2 MFD Soft Key Map

The soft keys available depend on the page displayed and the features available. The soft key “Alerts” is present on the far right position in all MFD displays.



Foreword

System Sec 1

PFD Sec 2

MFD Sec 3

Avoidance Sec 4

Hazard Sec 4

Additional Features Sec 5

Annun. & Alerts Sec 6

Symbols Sec 7

Glossary Sec 8

Appendix A

Appendix B Index

Figure 3-3 MFD Soft Keys

3.3 Navigation Map Pages

Map displays are used extensively in the GDU 620 to provide situational awareness in flight. The two Navigation map pages can display the following information:

- Airports, NAVAIDs, airspace, airways, land data (highways, cities, lakes, rivers, borders, etc.) with names
- Map Pointer information (distance and bearing to pointer, location of pointer, name, and other pertinent information)
- Map range
- Wind direction and speed
- Map orientation
- Icons for enabled map features
- Aircraft icon (representing present position)
- Nav range ring
- Flight plan legs
- Track vector
- Topography scale
- Topography data
- XM NEXRAD Weather
- XM Lightning
- XM Storm Cells

Symbols used on the MFD are detailed in Section 7.

Wind Vector and Speed Map Orientation

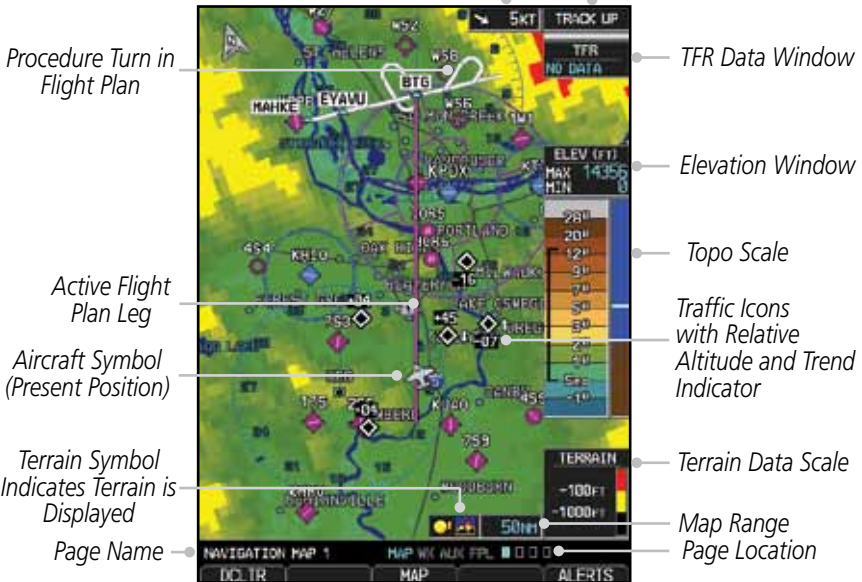

Figure 3-4 MFD Map Description

3.3.1 Default Navigation Map Page

While on any page of the MFD, you may easily return to the first Navigation Map page of the Map group by pressing and holding the **CLR** key to return to the first page (Home Page) of the Map group.

3.3.2 Editing Information

- 1) Press the small **MFD** knob to activate editing.
- 2) Turn the large **MFD** knob to select desired item.
- 3) Turn the small **MFD** knob to change the highlighted value.
- 4) Press **ENT** to accept the displayed value.
- 5) Press the small **MFD** knob to cancel selection or to end editing.

Foreword

Sec 1
System

Sec 2
PFD

Sec 3
MFD

Sec 4
Hazard
Avoidance

Sec 5
Additional
Features

Sec 6
Annun.
& Alerts

Sec 7
Symbols

Sec 8
Glossary

Appendix A

Appendix B
Index



NOTE: Page Group and Page are shown at the bottom of the MFD.



Figure 3-5 Page Group and Page Locator

3.3.3 Selecting Page Options

- 1) Change the fields or the setup of a page by pressing the **MENU** key and make the necessary adjustments with the **MFD** knobs.
- 2) Press **ENT** to accept the displayed value. Press the small **MFD** knob to cancel selection or to end editing.

3.3.4 Changing the Navigation Map Range

The Range (RNG) keys on the right side of the bezel are used to change the map display range. Pressing the **▲ RNG** key will zoom out (increasing the displayed map range) and pressing the **▼ RNG** key will zoom in (decreasing the displayed map range). The Map Range is shown in the lower right corner of the MFD and represents the top-to-bottom distance covered by the map. The map ranges available are from 500 feet to 2000 NM. When the map range is decreased to a point that exceeds the capability of the GDU 620 to accurately represent the map, a magnifying glass icon is shown to the left of the map range.



Figure 3-6 Map Range

3.3.5 Decluttering Map Pages

The Map Declutter feature allows the pilot to progressively step through four levels of decluttering to remove map information. The declutter level is displayed in the **DCLTR** soft key.



Figure 3-7 Map Declutter Soft Key

- 1) There are four levels of decluttering. DCLTR (0) shows the most detail. DCLTR-3 removes the most detail.
- 2) While viewing one of the Navigation Map pages, press the **DCLTR** soft key. Each successive press of the **DCLTR** soft key will toggle through the declutter levels. Features marked with a "•" are shown at the indicated Declutter Level.



NOTE: Traffic is automatically decluttered from Nav Map pages when the map scale is above 150 NM.

Feature	0	1	2	3	Feature	0	1	2	3	
Airways	•				Class D Airspace	•	•			Foreword
River/Lake Names	•				Tower	•	•			System
Land/Country Text	•				TRSA	•	•			
Large City	•				ADIZ	•	•			Sec 1
Medium City	•				Alert Areas	•	•			PFD
Small City	•				Caution Areas	•	•			
Small Town	•				Danger Areas	•	•			Sec 2
Freeways	•				Warning Areas	•	•			MFD
Highways	•				Large Airports	•	•	•		
Roads	•				Medium Airports	•	•	•		
Railroads	•				Prohibited Areas	•	•	•		Sec 3
Political Boundaries	•				MOAs	•	•	•		
Lat/Lon Grids	•	•			Runway Labels	•	•	•		Hazard
VORs	•	•			Lightning Strike Data	•	•	•		Avoidance
NDBs	•	•			NEXRAD Data	•	•	•		Sec 4
Intersections	•	•			Traffic Symbols	•	•	•		
Class B Airspace	•	•			Traffic Labels	•	•	•		Additional
Class C Airspace	•	•			Water Detail	•	•	•	•	Sec 5
					Active FPL Legs	•	•	•	•	Annun. & Alerts

Table 3-1 Features Shown at Each Decluttering Level

Sec 7
Symbols

Sec 8
Glossary

Appendix A

Appendix B
Index

3.3.6 Panning

The Panning Map Page function allows you to move the map beyond its current limits without adjusting the map scale and to examine information at the pointer location. When you select the panning function — by pressing the small **MFD** knob — a target pointer flashes on the map display. A window also appears at the top of the map display showing the latitude/longitude position of the pointer, the ETE from your present position to the pointer, elevation at the pointer, and bearing and distance to the pointer from your present position.

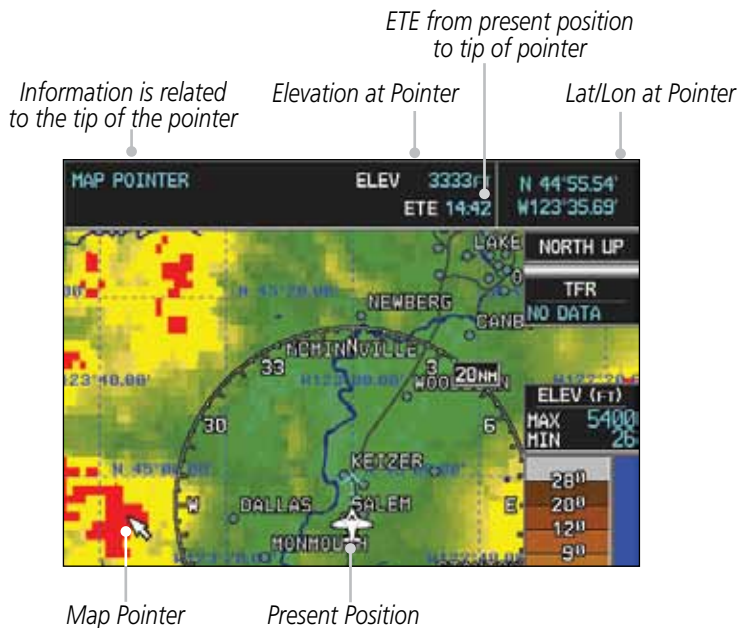

Figure 3-8 Navigation Map Pointer Location Information

- 1) While viewing a Map or Chart page, press the small **MFD** knob. A flashing pointer will appear in the tip of the ownship symbol. The measured information is referenced to the tip of the arrow.



Figure 3-9 Navigation Map Initial Pointer Location

- 2) Turn the large **MFD** knob to move the cursor horizontally. Turn the small **MFD** knob to move the cursor vertically.
- 3) Press the small **MFD** knob again to cancel panning. The display will return to the previous map view.

3.3.7 Selecting Items on the Map

When the target pointer is placed on an object, the name of that object is highlighted (even if the name wasn't originally displayed on the map). This feature applies to airports, NAVAIDs, user-created waypoints, roads, lakes, rivers — just about everything displayed on the map except route lines. When an airport, NAVAID, or user waypoint is selected on the map display, you can review information about the item.

- 1) While viewing the Navigation Map pages of the Map page group, press the small **MFD** knob to activate panning.
- 2) Move the cursor with the small and large **MFD** knobs to highlight a feature.
- 2) Press **ENT** to display information about the highlighted feature.
- 3) Press the **INFO** soft key (if available) to view more information about the highlighted feature.
- 4) Press the **WX** soft key (if available) to view TAF and METAR information.
- 5) Press the small **MFD** knob again to return to panning.

Foreword

Sec 1
System

Sec 2
PFD

Sec 3
MFD

Sec 4
Hazard
Avoidance

Sec 5
Additional
Features

Sec 6
Annun.
& Alerts

Sec 7
Symbols

Sec 8
Glossary

Appendix A

Appendix B
Index

3.3.8 Measuring Distances

The “Measure Bearing/Distance” function provides a quick and easy method to determine the bearing and distance between any two points on the Navigation Map.

- 1) While viewing one of the Navigation Map pages of the Map page group, press **MENU**.
- 2) Turn the large or small **MFD** knobs to highlight “Measure Bearing/Distance” and then press **ENT**.



Figure 3-10 Navigation Map Measure Distance Function

- 3) Your present position will be marked as the starting reference point. To choose a different starting reference point, turn the large or small **MFD** knobs to desired point and press **ENT**.



Figure 3-11 Measure Distance Starting Reference Point

- 4) Turn the large or small **MFD** knobs to move the cursor to a reference point. The distance and bearing is displayed at the top of the display.

Distance and Bearing Between Start and End Points

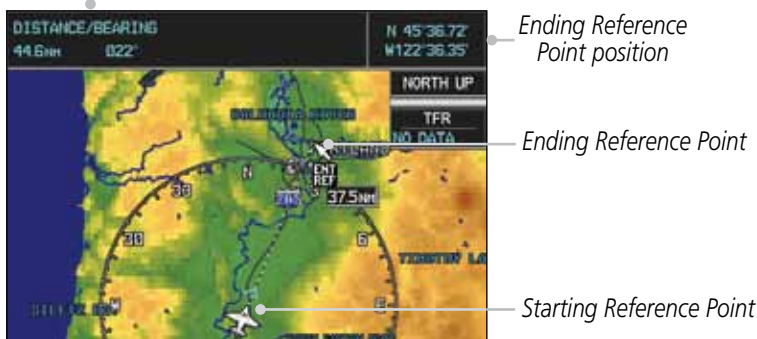

Figure 3-12 Bearing/Distance Measurement

Foreword
 Sec 1 System
 Sec 2 PFD
 Sec 3 MFD
 Sec 4 Hazard Avoidance
 Sec 5 Additional Features
 Sec 6 Annun. & Alerts
 Sec 7 Symbols
 Sec 8 Glossary
 Appendix A
 Appendix B Index

5) Press the small **MFD** knob to stop measuring.

3.3.9 Customizing Navigation Map Pages

The Navigation Map pages are customized by selecting options from the Page Menu. The Page Menu options include choices for Map Setup and Measure Bearing/Distance. The Map Setup choice covers selections for Map, Weather, Traffic, and Aviation depending on the installed equipment of a given aircraft.

3.3.10 Map Setup

The Map Setup selection from the Page Menu allows you to customize the displayed items.

- 1) While viewing one of the Navigation Map pages of the Map page group, press the **MENU** key to display the Navigation Map Page Menu.



Figure 3-13 Navigation Map Page Menu

- 2) With the cursor flashing on the "Map Setup" option. Press the **ENT** key to display the Map Setup Menu.
- 3) Use the large and small **MFD** knobs to select the Group (Map, Weather, Traffic, or Aviation) and press **ENT** to allow editing of the selected group. The groups shown depend on the features available for equipment installed in your aircraft.



Figure 3-14 Navigation Map Page Menu Map Group Selection

- 4) Press the small **MFD** knob to return to the Navigation Map Page.

Map Group		Weather Group (optional)		Traffic Group (optional)		Aviation Group	
Menu Item	Adjustment	Menu Item	Adjustment	Menu Item	Adjustment	Menu Item	Adjustment
Orientation	Direction	NEXRAD Viewing Range	Off/Range	Traffic	Off/Modes	Safe Taxi Viewing Range	Off/Range
North Up At	Off/Range	NEXRAD Cell Mov	Off/Range			Rwy Extension Range	Off/Range
Auto Zoom	On/Off	NEXRAD Legend	On/Off			INT/NDB Viewing Range *	Off/Range
Land Data	On/Off	XM Ltng	Off/Range			VOR Viewing Range*	Off/Range
Track Vector Length	Off/Time					Class B/ TMA *	Off/Range
Wind Vector	On/Off					Class C/ TCA *	Off/Range
Nav Range Ring	On/Off					Class D *	Off/Range
Topo Data	On/Off					Restricted*	Off/Range
Topo Scale	On/Off					MOA (Military)*	Off/Range
Terrain Data	On/Off					Other/ ADIZ *	Off/Range
Terrain Scale	On/Off					TFR *	Off/Range
Obstacle Viewing Range	Off/Range					Airways	Off/Modes
Lat/Lon Viewing Range	Off/Range						
Field of View**	On/Off						

* - shown if the Aviation database is current. ** - shown if Synthetic Vision is available.

Table 3-2 Navigation Map Page Menu Selections

3.3.10.1 Map Feature Options

Choose the options to determine the values for display on each Navigation Map. The options you save will be retained until changed. The options may be selecting by using the following procedure:

- 1) While viewing one of the Navigation Map pages of the Map page group, press the **MENU** key. With "Map Setup" highlighted, press **ENT**.



Figure 3-15 Navigation Map Page Menu

With the Map Group active, turn the large **MFD** knob to highlight the desired option.



Figure 3-16 Navigation Map Page Menu Map Group Selection

- 2) Turn the small **MFD** knob to change the highlighted value.
- 3) Press **ENT** to accept the displayed value. The next option will be highlighted.
- 4) Press the small **MFD** knob to cancel selection or to end editing and return to the Navigation Map page or turn the large **MFD** knob to the next option.

Map Orientation

The Orientation option sets the orientation of the Navigation Map.



Figure 3-17 Navigation Map Orientation

Foreword

System Sec 1

PFD Sec 2

MFD Sec 3

Avoidance Hazard Sec 4

Additional Features Sec 5

Annun. & Alerts Sec 6

Symbols Sec 7

Glossary Sec 8

Appendix A

Appendix B Index

North Up At

The North Up At option allows you to select the map range where at and above the selected value the Map Orientation will automatically change to North Up. For example, with the 500 NM value selected in the figure below, when the map range of the MFD is 500 NM or more, the map orientation will automatically become North Up.

- 1) While viewing the Navigation Map 1 or 2 of the Map page group, press the **MENU** key. With "Map Setup" highlighted, press **ENT**. With the Map Group active, turn the large **MFD** knob to highlight the "North Up At" option.
- 2) Turn the small **MFD** knob to change the highlighted value.



Figure 3-18 Navigation Map "North Up At" Orientation Range Selection

- 3) Press **ENT** to accept the displayed value. The next option will be highlighted.
- 4) Press the small **MFD** knob to cancel selection or to end editing and return to the Navigation Map page or turn the large **MFD** knob to the next option.

Auto Zoom

With a valid flight plan, the Auto Zoom feature will automatically change the Navigation Map range depending on the distance to the next waypoint in the flight plan. If enabled, it will also automatically zoom to the SafeTaxi zoom range when the aircraft is on the ground. Auto Zoom can be overridden at any time by manually zooming with the **RNG** keys or enabling OBS mode. Auto Zoom is re-enabled once one of the following conditions is met:

- 1) A waypoint is sequenced,
 - 2) the aircraft transitions from “on ground” to “in air,”
 - 3) a point is reached where the Auto Zoom range matches the manual override range (known as auto-sync),
 - 4) Auto Zoom is toggled off and back on in the Navigation Map Setup page,
- OR
- 5) OBS mode is turned off.

Activating Auto Zoom

- 1) While viewing the Navigation Map 1 or 2 pages of the Map page group, press the **MENU** key. With “Map Setup” highlighted, press **ENT**. With the Map Group active, turn the large **MFD** knob to highlight the “Auto Zoom” option.
- 2) Turn the small **MFD** knob to select On or Off.



Figure 3-19 Navigation Map Auto Zoom

- 3) Press **ENT** to accept the displayed value. The next option will be highlighted.
- 4) Press the small **MFD** knob to cancel selection or to end editing and return to the Navigation Map page or turn the large **MFD** knob to the next option.

Foreword

System Sec 1

PFD Sec 2

MFD Sec 3

Hazard Avoidance Sec 4

Additional Features Sec 5

Annun. & Alerts Sec 6

Symbols Sec 7

Glossary Sec 8

Appendix A

Appendix B Index

Land Data

The Land Data option selects whether detailed land features, such as rivers, roads, cities, are displayed. Topo features, traffic, terrain, and obstacles will still be displayed, even with Land Data turned off.



Figure 3-20 Navigation Map Land Data

Track Vector Length

When turned on, the Track Vector Length option will show a dashed line and arrow extending from the aircraft icon illustrating the current Track and the distance the aircraft will travel in the selected time.

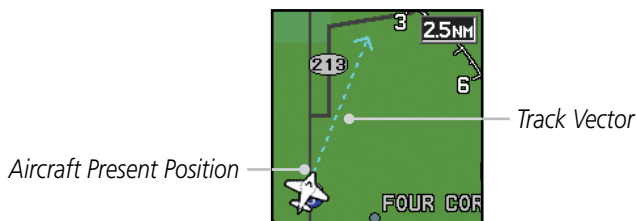

Figure 3-21 Navigation Map Track Vector

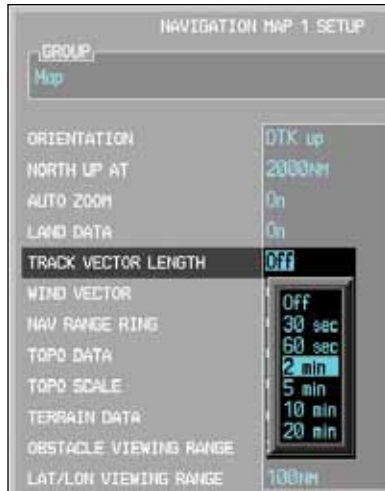

Figure 3-22 Navigation Map Track Vector Length Selection

Wind Vector

The Wind Vector option when turned on will show a box in the top right corner of the MFD indicating the wind direction and speed.



Figure 3-23 Navigation Map Wind Vector Display



Figure 3-24 Navigation Map Wind Vector Selection

Nav Range Ring

When turned on, the Nav Range Ring option will show a ring with a compass rose around your present position on the Navigation Map. The relative size shown on the map will remain the same (25% of the map range).

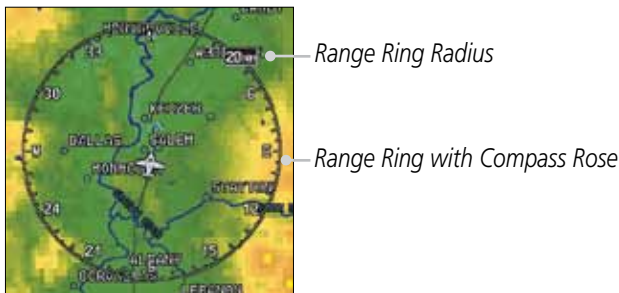

Figure 3-25 Navigation Map Range Ring



Figure 3-26 Navigation Map Range Ring Selection

Foreword

Sec 1
System

Sec 2
PFD

**Sec 3
MFD**

Sec 4
Hazard
Avoidance

Sec 5
Additional
Features

Sec 6
Annun.
& Alerts

Sec 7
Symbols

Sec 8
Glossary

Appendix A

Appendix B
Index

Topo Data

The Topo Data option selects whether the colored topographical features are displayed. Traffic, Land Data, Terrain, and Obstacles will still be displayed even with Topo Data turned off.

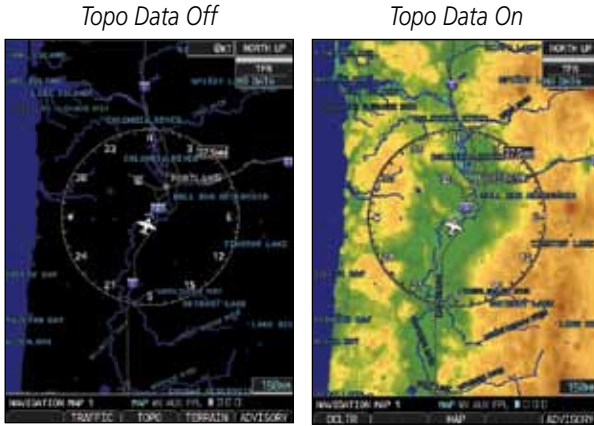

Figure 3-27 Navigation Map Topo Data

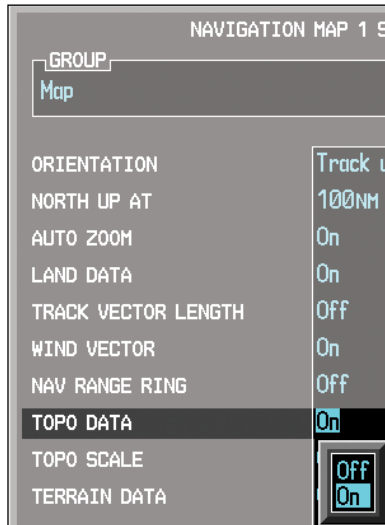

Figure 3-28 Navigation Map Topo Data Selection

Topo Scale

The Topo Scale option selects whether the elevation scale for topographical features on the Navigation Map is displayed. The scale will be located on the right side of the display.

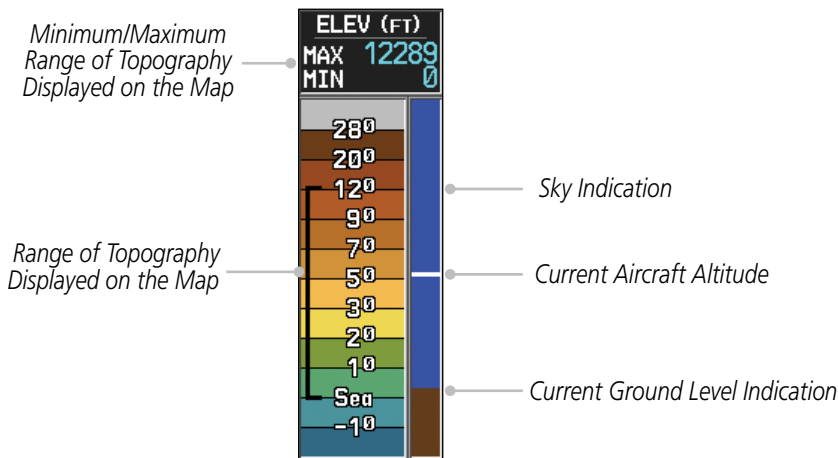

Figure 3-29 Navigation Map Topo Scale

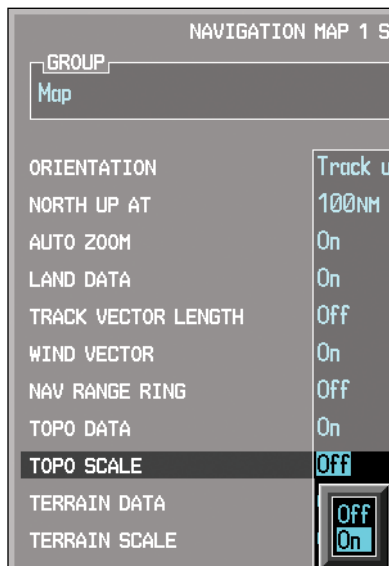



Figure 3-30 Navigation Map Topo Scale Selection

Terrain Data

The Terrain Data option selects whether Terrain Data is shown on the Navigation Map. The Terrain Data Icon  will be shown when Terrain has been selected.

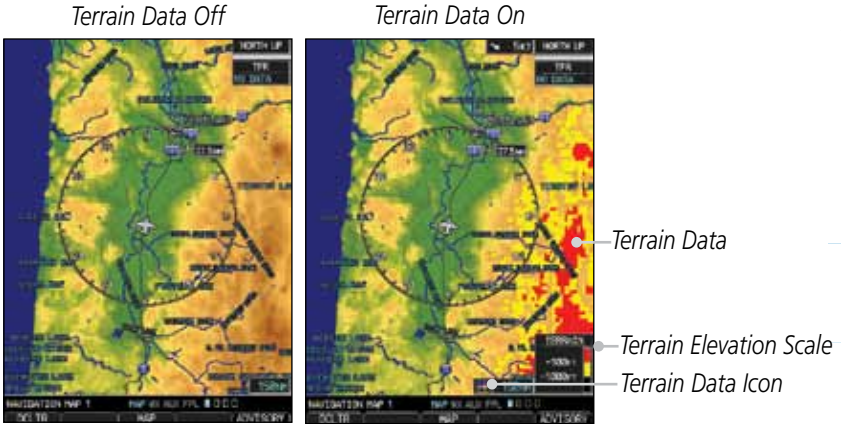

Figure 3-31 Navigation Map Terrain Data



Figure 3-32 Navigation Map Terrain Data Selection

Terrain Scale

The Terrain Scale option selects whether the Terrain Scale is shown on the Navigation Map. The Terrain scale will be located on the right side of the display.



Figure 3-33 Navigation Map Terrain Scale Selection

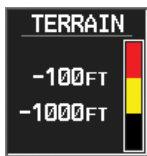

Figure 3-34 Navigation Map Terrain Scale

Foreword

Sec 1
System

Sec 2
PFD

**Sec 3
MFD**

Sec 4
Hazard
Avoidance

Sec 5
Additional
Features

Sec 6
Annun.
& Alerts

Sec 7
Symbols

Sec 8
Glossary

Appendix A

Appendix B
Index

Obstacle Data Viewing Range

The Obstacle Data Viewing Range option selects whether the Obstacle Data is shown on the Navigation Map. Obstacles will be shown at and below the selected map range. Map ranges above this value will not show the Obstacle Data. In the range selection example below where 30 NM is selected, obstacles will be shown at map ranges of 30 NM and lower.





Unlighted Obstacle (Height is less than 1000 ft AGL)	Lighted Obstacle (Height is less than 1000 ft AGL)	Unlighted Obstacle (Height is greater than 1000 ft AGL)	Lighted Obstacle (Height is greater than 1000 ft AGL)
			

Figure 3-35 Navigation Map Obstacle Icons

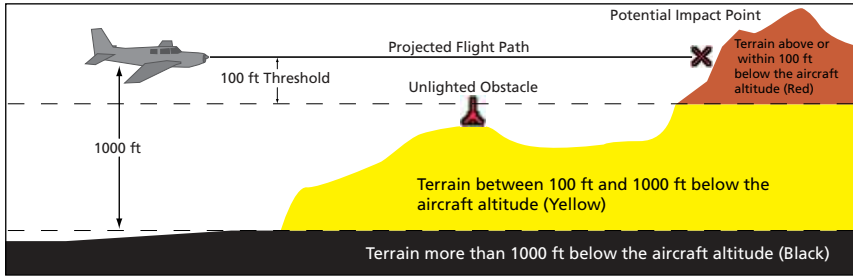

Figure 3-36 TERRAIN Altitude/Color Correlation

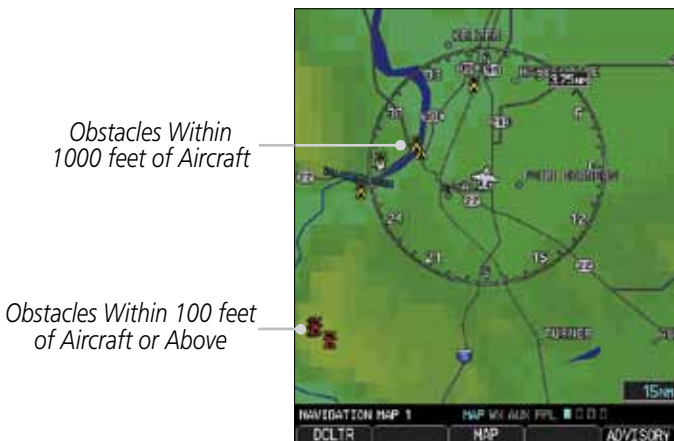

Figure 3-37 Navigation Map Obstacle Data

Foreword

System Sec 1

PFD Sec 2

Sec 3 MFD

Avoidance Hazard Sec 4

Additional Features Sec 5

Annun. & Alerts Sec 6

Symbols Sec 7

Glossary Sec 8

Appendix A

Appendix B Index

Foreword

Sec 1 System

Sec 2 PFD

Sec 3 MFD

Sec 4 Hazard Avoidance

Sec 5 Additional Features

Sec 6 Annun. & Alerts

Sec 7 Symbols

Sec 8 Glossary

Appendix A

Appendix B Index



Figure 3-38 Navigation Map Obstacle Data Selection

Lat/Lon Viewing Range

The Lat/Lon Viewing Range option selects whether Lat/Lon line is shown on the MFD. Lat/Lon lines will be shown at and below the selected map range. Map ranges above the selected value will not show the Lat/Lon lines. When Off is selected, Lat/Lon lines will not be shown. In the figure below where 200 NM is selected, Lat/Lon lines will be shown at map ranges of 200 NM and lower.



Figure 3-39 Navigation Map Lat/Lon Selection

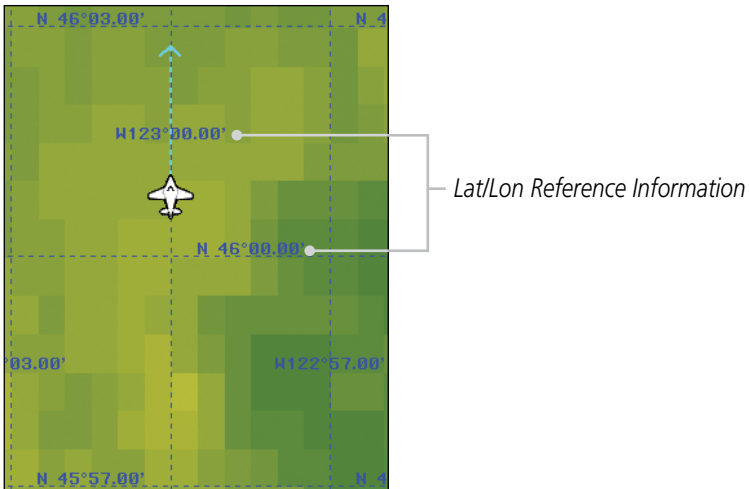

Figure 3-40 Navigation Map Lat/Lon Information

Field of View

The PFD Field of View used for the Garmin Synthetic Vision Technology (SVT™) option (when enabled) can be represented on the MFD Navigation Map Page lateral image. Two dashed lines forming a V-shape in front of the aircraft symbol on the MFD, represent the forward viewing area shown on the PFD.



Figure 3-41 Navigation Map Field of View Selection

Foreword
 Sec 1 System
 Sec 2 PFD
Sec 3 MFD
 Sec 4 Hazard Avoidance
 Sec 5 Additional Features
 Sec 6 Annun. & Alerts
 Sec 7 Symbols
 Sec 8 Glossary
 Appendix A
 Appendix B Index



Field of View Borders

Figure 3-42 Navigation Map Field of View on the MFD

3.3.10.2 Weather Feature Options (Optional)

The Weather group selection from the Map Setup Page Menu allows you to customize the NEXRAD Viewing Range, NEXRAD Cell Movement, and Lightning Viewing range. Weather is an optional feature that requires a GDL 69/69A and an XM WX Satellite Weather subscription, or other weather product (such as GFDS).



Figure 3-43 Navigation Map Page Menu



Figure 3-44 Navigation Map Page Menu Weather Group Selection

Foreword

Sec 1
System

Sec 2
PFD

Sec 3
MFD

Sec 4
Hazard
Avoidance

Sec 5
Additional
Features

Sec 6
Annun.
& Alerts

Sec 7
Symbols

Sec 8
Glossary

Appendix A

Appendix B
Index

NEXRAD Viewing Range

The NEXRAD Viewing Range option selects whether the NEXRAD weather products is shown on the MFD. NEXRAD weather products will be shown at and below the selected map range. When Off is selected, NEXRAD weather will not be shown. Map ranges above the selected value will not show the NEXRAD weather products. In the example below where 200 NM is selected, the NEXRAD weather products will be shown at map ranges of 200 NM and lower.



Figure 3-45 NEXRAD Viewing Range Selection

NEXRAD Cell Movement

The NEXRAD Cell Movement option selects whether NEXRAD Cell Movement is shown on the Navigation Map. NEXRAD Cell Movement will be shown at and below the selected map range. When Off is selected, NEXRAD Cell Movement will not be shown. In the example below where 150 NM is selected, the NEXRAD Cell Movement will be shown at map ranges of 150 NM and lower.



Figure 3-46 NEXRAD Cell Movement Selection

Foreword
 Sec 1 System
 Sec 2 PFD
 Sec 3 MFD
 Sec 4 Hazard Avoidance
 Sec 5 Additional Features
 Sec 6 Annun. & Alerts
 Sec 7 Symbols
 Sec 8 Glossary
 Appendix A
 Appendix B Index

NEXRAD Legend

The NEXRAD Legend selection provides the option of displaying an abbreviated version of the NEXRAD legend in the top right region of the MFD.

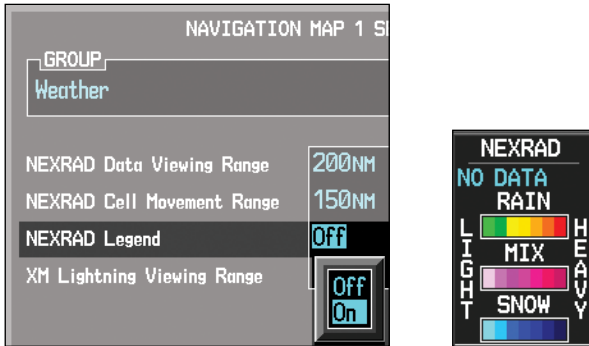

Figure 3-47 NEXRAD Legend Selection

Lightning Viewing Range

The Lightning Viewing Range option selects whether the Lightning weather products is shown on the Navigation Map. Lightning weather products will be shown at and below the selected map range. When Off is selected, Lightning weather will not be shown. In the figure below where 200 NM is selected, Lightning symbols will be shown at map ranges of 200 NM and lower.



Figure 3-48 Lightning Viewing Range Selection

3.3.10.3 Traffic Feature Options (Optional)

The Traffic group selection from the Map Setup Page Menu allows you to customize the display of traffic on the Navigation Map. The Traffic function requires the installation of a compatible traffic device. TIS and TAS cannot be displayed at the same time. If the aircraft has a TAS unit installed, the GDU 620 will be configured for TAS. If no TAS unit is installed and a GTX Mode-S transponder is installed then the GDU 620 will be configured for TIS. A pilot can tell which data is being displayed by the label in the top left corner (TAS OPERATING vs TIS OPERATING). TIS data comes from a GTX transponder. Coverage is limited to specific areas as shown in the Airmen’s Information Manual (AIM). TAS data comes from a TAS unit such as a Garmin GTS 800 or 820, Skywatch 497, KTA 810, or other unit. Coverage follows the aircraft. In the Navigation Map page setup you can select the maximum range at which traffic symbols are shown. Once outside of the selected range, traffic will be decluttered. The Traffic soft key will still be available.



NOTE: Traffic is automatically decluttered from Nav Map 1 and 2 when the map scale is above 150 NM.

Traffic Selection	Display Result
Off	No traffic displayed
All Traffic	All types of traffic displayed
TA/PA	Traffic Alerts and Proximity Alerts displayed
TA Only	Traffic Alerts Only displayed

Table 3-3 Navigation Map Traffic Display Options



Figure 3-49 Navigation Map Page Menu Traffic Group Selection

- 1) While viewing the Navigation Map Setup page and the Traffic Group active, turn the large **MFD** knob to highlight the "Traffic" options.



Figure 3-50 Navigation Map Page Menu Traffic Options

- 2) Turn the small **MFD** knob to change the highlighted value.
- 3) Press **ENT** to accept the displayed value.
- 4) Press the small **MFD** knob to cancel selection or to end editing and return to the Navigation Map page or turn the large **MFD** knob to the next option.

3.3.10.4 Aviation Feature Options

The Aviation group selection from the Map Setup Page Menu allows you to customize the display of SafeTaxi information, Runway Extensions, Intersection/NDB locations, VOR locations, and TFR icons on the Navigation Map.



Figure 3-51 Navigation Map Page Menu Aviation Group Selection

SafeTaxi™ Viewing Range

The SafeTaxi™ viewing range option selects whether SafeTaxi information is shown on the Navigation Map. SafeTaxi will be shown at and below the selected map range. When Off is selected, SafeTaxi information will not be shown. In the example below where 3 NM is selected, the SafeTaxi information will be shown at map ranges of 3 NM and lower.



Figure 3-52 Navigation Map Safe Taxi Viewing Range Selection

Runway Extension Range

The Runway Extension Range option selects the whether Runway Extensions is shown for the destination airport runway. Runway Extensions will be shown at and below the selected map range. When Off is selected, Runway Extensions will not be shown.



Figure 3-53 Navigation Map Runway Extension Selection

INT/NDB Viewing Range

The INT/NDB viewing range option selects whether Intersection and NDB information is shown on the Navigation Map. Intersection and NDB information will be shown at and below the selected map range. When Off is selected, the information will not be shown. In the example below where 15 NM is selected, INT/NDBs will be shown at map ranges of 15 NM and lower.



Figure 3-54 Navigation Map INT/NDB Viewing Range Selection

VOR Viewing Range

The VOR viewing range option selects whether VOR information is shown on the Navigation Map. VOR information will be shown at and below the selected map range. When Off is selected, the information will not be shown. In the example below where 150 NM is selected, VOR information will be shown at map ranges of 150 NM and lower.

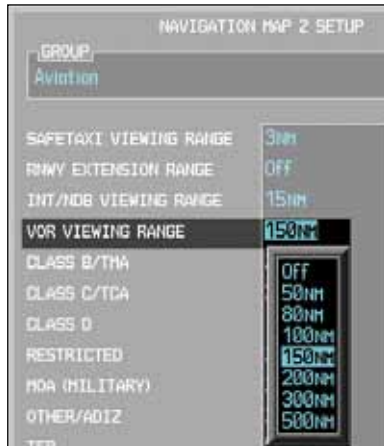

Figure 3-55 Navigation Map VOR Viewing Range Selection

Class B/TMA Airspace Viewing Range

The Class B/TMA airspace viewing range option selects whether Class B/TMA airspace information is shown on the Navigation Map. Class B/TMA airspace information will be shown at and below the selected map range. When Off is selected, the information will not be shown. In the example below where 200 NM is selected, Class B/TMA airspace information will be shown at map ranges of 200 NM and lower.



Figure 3-56 Navigation Map Class B/TMA Viewing Range Selection

Sec 1 System Foreword

Sec 2 PFD

Sec 3 MFD

Sec 4 Hazard Avoidance

Sec 5 Additional Features

Sec 6 Annun. & Alerts

Sec 7 Symbols

Sec 8 Glossary

Appendix A

Appendix B Index

Class C/TCA Airspace Viewing Range

The Class C/TCA airspace viewing range option selects whether Class C/TCA airspace information is shown on the Navigation Map. Class C/TCA airspace information will be shown at and below the selected map range. When Off is selected, the information will not be shown. In the example below where 200 NM is selected, Class C/TCA airspace information will be shown at map ranges of 200 NM and lower.



Figure 3-57 Navigation Map Class C/TCA Viewing Range Selection

Foreword

Sec 1
System

Sec 2
PFD

**Sec 3
MFD**

Sec 4
Hazard
Avoidance

Sec 5
Additional
Features

Sec 6
Annun.
& Alerts

Sec 7
Symbols

Sec 8
Glossary

Appendix A

Appendix B
Index

Class D Airspace Viewing Range

The Class D airspace viewing range option selects whether Class D airspace information is shown on the Navigation Map. Class D airspace information will be shown at and below the selected map range. When Off is selected, the information will not be shown. In the example below where 150 NM is selected, Class D airspace information will be shown at map ranges of 150 NM and lower.



Figure 3-58 Navigation Map Class D Viewing Range Selection

Sec 1 System Foreword

Sec 2 PFD

Sec 3 MFD

Sec 4 Hazard Avoidance

Sec 5 Additional Features

Sec 6 Annun. & Alerts

Sec 7 Symbols

Sec 8 Glossary

Appendix A

Appendix B Index

Restricted Airspace Viewing Range

The Restricted airspace viewing range option selects whether the map range is shown on the Navigation Map. Restricted airspace information will be shown at and below the selected map range. When Off is selected, the information will not be shown. In the example below where 200 NM is selected, Restricted airspace information will be shown at map ranges of 200 NM and lower.



Figure 3-59 Navigation Map Restricted Airspace Viewing Range Selection

Foreword

Sec 1
System

Sec 2
PFD

**Sec 3
MFD**

Sec 4
Hazard
Avoidance

Sec 5
Additional
Features

Sec 6
Annun.
& Alerts

Sec 7
Symbols

Sec 8
Glossary

Appendix A

Appendix B
Index

MOA (Military) Viewing Range

The MOA (Military) viewing range option selects whether MOA (Military) information is shown on the Navigation Map. MOA airspace information will be shown at and below the selected map range. When Off is selected, the information will not be shown. In the example below where 200 NM is selected, MOA airspace information will be shown at map ranges of 200 NM and lower.



Figure 3-60 Navigation Map MOA (Military) Viewing Range Selection

Sec 1 System Foreword

Sec 2 PFD

Sec 3 MFD

Sec 4 Hazard Avoidance

Sec 5 Additional Features

Sec 6 Annun. & Alerts

Sec 7 Symbols

Sec 8 Glossary

Appendix A

Appendix B Index

Other/ADIZ Airspace Viewing Range

The Other/ADIZ airspace viewing range option selects whether Other/ADIZ airspace information is shown on the Navigation Map. Other/ADIZ airspace information will be shown at and below the selected map range. When Off is selected, the information will not be shown. In the example below where 200 NM is selected, Other/ADIZ airspace information will be shown at map ranges of 200 NM and lower.



Figure 3-61 Navigation Map Other/ADIZ Viewing Range Selection

Foreword

Sec 1
System

Sec 2
PFD

**Sec 3
MFD**

Sec 4
Hazard
Avoidance

Sec 5
Additional
Features

Sec 6
Annun.
& Alerts

Sec 7
Symbols

Sec 8
Glossary

Appendix A

Appendix B
Index

TFR Viewing Range (Optional)

The Temporary Flight Restriction (TFR) viewing range option selects whether TFR information is shown on the Navigation Map. TFR information will be shown at and below the selected map range. When Off is selected, the information will not be shown. In the example below where 500 NM is selected, TFR information will be shown at map ranges of 500 NM and lower. This optional feature requires an active data link receiver.



Figure 3-62 Navigation Map TFR Viewing Range Selection

Sec 1 System Foreword

Sec 2 PFD

Sec 3 MFD

Sec 4 Hazard Avoidance

Sec 5 Additional Features

Sec 6 Annun. & Alerts

Sec 7 Symbols

Sec 8 Glossary

Appendix A

Appendix B Index

Airways

The Airways option allows you to select the airways that are shown on the Navigation Map. All, Low only, and Hi only Airways may be selected. When Off is selected, airways will not be shown.



Figure 3-63 Airways Selection

Foreword

Sec 1
System

Sec 2
PFD

**Sec 3
MFD**

Sec 4
Hazard
Avoidance

Sec 5
Additional
Features

Sec 6
Annun.
& Alerts

Sec 7
Symbols

Sec 8
Glossary

Appendix A

Appendix B
Index

3.3.11 Split Screen (Optional)

External Video is an optional function that displays video provided by an externally mounted video source on the aircraft.

- 1) While viewing the Map function, turn the small **MFD** knob to the third Navigation Map page.

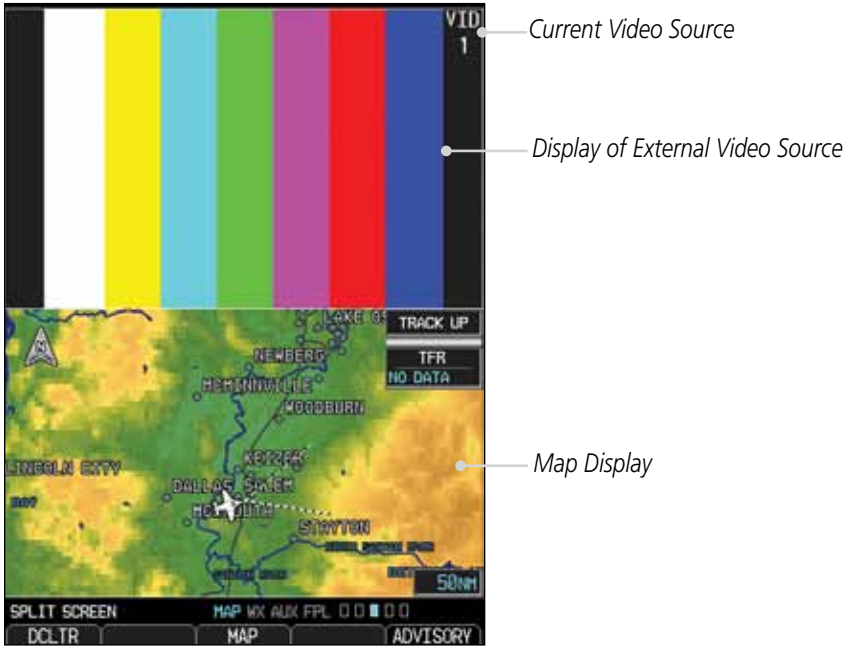

Figure 3-64 External Video

- 2) The External Video page will show the external video on the top half of the MFD and a Navigation Map will be shown on the lower half.
- 3) To select the other external video source, press the **MENU** key.



Figure 3-65 Aux Mode System Setup Page Menu

- 4) Turn the large or small **MFD** knobs to highlight the Video selection and then press **ENT**.

3.4 Aux Mode Pages

The Aux mode provides pages for System Setup, XM Information (if installed), and system Status.

3.4.1 System Settings

G500 system settings are managed from the Aux Mode System Setup Page. The following settings can be changed:

- Display Brightness (Mode and Level)
- Airspeeds (Glide-REF, V_R , V_X - V_1 , and V_Y - V_2)
- PFD Options (Wind Vector and Nav Status Styles)
- Dual Unit Synchronization (CDI and Baro)
- Date/Time (Date, Time, Time Format, and Time Offset)
- MFD Display Units (Distance/Speed and Altitude/Vertical Speed)
- System Display Units (Navigation Angle Reference, Pressure Units, and Temperature Units)



Figure 3-66 Aux Mode System Setup Page

The default values set by the installer during installation are restored by using

Foreword

Sec 1 System

Sec 2 PFD

Sec 3 MFD

Sec 4 Hazard Avoidance

Sec 5 Additional Features

Sec 6 Annun. & Alerts

Sec 7 Symbols

Sec 8 Glossary

Appendix A

Appendix B Index

the Page Menu options or soft keys. The “Restore Unit Defaults” menu selection and the **DFLT UNIT** soft key restores the default MFD Display and System Display Units settings. The “Restore Airspeed Defaults” menu selection or **DFLT SPD** soft key restores the default PFD Airspeeds settings.

The **RA TEST** soft key activates the Radar Altimeter test mode. See the Radio Altimeter section in Section 2 for details.



NOTE: *Not all Radar Altimeters have the TEST function.*

- 1) While viewing the Aux mode System Setup page, press the **MENU** key.



Figure 3-67 Aux Mode System Setup Page Menu

- 2) Turn the large or small **MFD** knobs to highlight the desired selection and then press **ENT**.

3.4.1.1 Display Brightness

Display brightness mode may be set to manual or automatic. The automatic mode will set the display brightness based on the ambient light. The manual mode allows the setting of display brightness between 0 and 100%.

- 1) Turn the large **MFD** knob to reach the AUX page group. Press the small **MFD** knob to activate the cursor.
- 2) The Level will be highlighted. Turn the small **MFD** knob to select the Display Brightness Level and then press **ENT**.



Figure 3-68 Aux Mode Display Brightness Level Selection

- 3) If the Level was changed, Manual will be selected. Press the cursor to save the settings. If you press **ENT** the Mode setting will be highlighted.
- 4) With the Mode value highlighted, turn the small **MFD** knob to select Auto or Manual and then press **ENT**.



Figure 3-69 Aux Mode Display Brightness Mode Selection

3.4.1.2 Airspeed Reference Marks

The Best Glide (or REF), Vr, Vx (or V1), and Vy (or V2) airspeed reference marks for the PFD are adjusted with this function. A marker will appear on the PFD Airspeed tape at the selected speed when the value is “On.” Default reference airspeeds are set during installation. When power is cycled, the values you set will be reset.



NOTE: When power is cycled, the Airspeed Reference values are reset. During preflight, the Airspeed Reference values should be checked and set appropriately for the current aircraft configuration and performance.

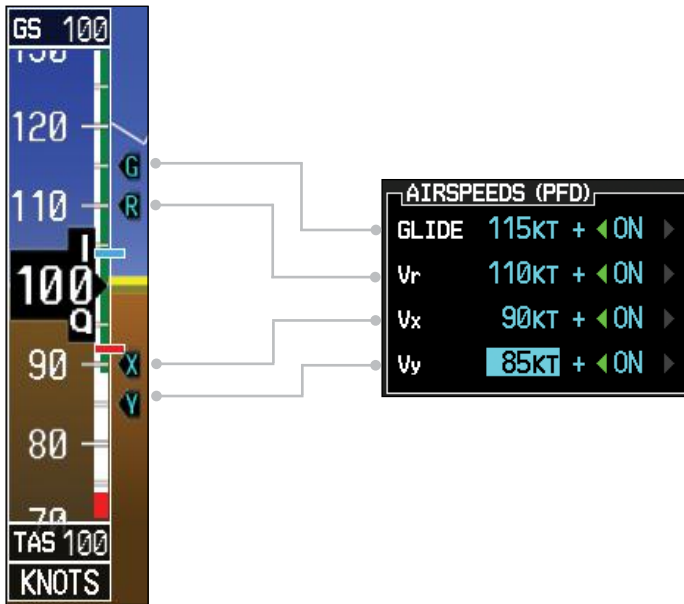

Figure 3-70 Airspeed References shown on PFD when activated

- 1) While viewing the System Setup page of the AUX page group, press the small **MFD** knob to activate the cursor. Turn the large **MFD** knob to highlight the desired Airspeeds value.
- 2) Turn the small **MFD** knob to select the value and press **ENT**.
- 3) The On/Off setting will now be highlighted. Turn the small **MFD** knob to select On or Off and press **ENT**. The next value will be highlighted.

3.4.1.3 PFD Options - Wind Vector

When selected, wind vector information is displayed on the PFD to the left of the HSI. Four styles are available.

- 1) While viewing the System Setup page of the AUX page group, press the small **MFD** knob to activate the cursor. Turn the large **MFD** knob to highlight the desired Wind Vector value.
- 2) Turn the small **MFD** knob to select the style and press **ENT**.

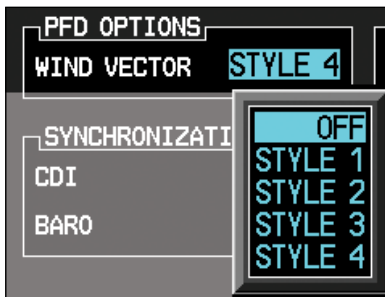

Figure 3-71 Wind Vector Style

- 3) When a Wind Vector style is selected, a Wind Vector box with the chosen style will be displayed to the left of the HSI on the PFD. When OFF is selected, the Wind Vector box will not be displayed.

3.4.1.4 PFD Options - Nav Status

When selected, Nav Status information is displayed on the PFD either on the top of the display (Style 1) or to the left of the HSI (Style 2).

- 1) While viewing the System Setup page of the AUX page group, press the small **MFD** knob to activate the cursor. Turn the large **MFD** knob to highlight the desired Nav Status value.
- 2) Turn the small **MFD** knob to select the style and press **ENT**.

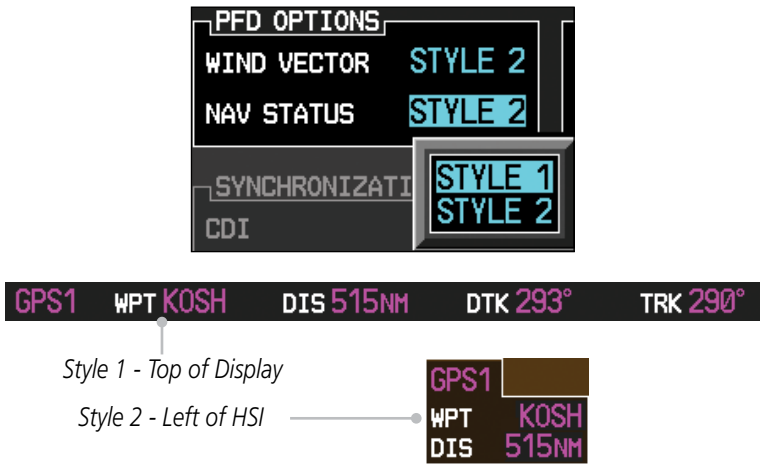

Figure 3-72 Nav Status Style

- 3) After the Nav Status style is selected, the chosen style will be displayed on the PFD.



NOTE: Nav Status option is not available for all installations.

3.4.1.5 Synchronization (Dual Installations Only)

Dual GDU 620 units when connected in the aircraft may be set up to communicate and share information by “Crossfilling” or synchronizing information between the two units.

When Barometric Correction is synchronized, any changes to the Barometric Setting on either GDU will change it on both GDUs.

Crossfill synchronization for CDI and Baro Corrections are selected in Aux mode.

- 1) While viewing the first page of the AUX page group, press the small **MFD** knob and turn the large **MFD** knob to highlight “CDI” or “BARO” in the “Synchronization” box in both units.



Figure 3-73 Dual Unit Synchronization

- 2) Turn the small **MFD** knob to select “ON” or “OFF.”
- 3) Press **ENT**.

Dual GDU 620 units when connected in the aircraft may be set up to communicate and share information by “Crossfilling” or synchronizing information between the two units.

The following information is always synchronized between both GDU 620 units:

- Selected Altitude
- Selected Heading
- Selected Course
- Selected Vertical Speed
- Airspeed Bug Values
- Airspeed Color Band Values
- System Pressure Units
- System Temperature Units

The following information can be synchronized between GDU 620s, or changed independently, depending on the Crossfill Synchronization Settings:

- Barometric Correction (default ON)
- Selected CDI (default OFF)

When Barometric Correction is synchronized, any changes to the Barometric Setting on either GDU will change it on both GDUs.

When the CDI is synchronized, any changes to the selected CDI on either GDU will change it on both GDUs. Either pilot can change the OBS course on either GNS. If the pilot selects GPS1 on the CDI and GNS1 is in OBS mode, any course changes will move the OBS on GNS1, GDU1, and GDU2 (if the copilot has GPS1 displayed on the CDI). Similarly, if the pilot selects GPS2 on the CDI and GNS2 is in OBS mode, any course changes will move the OBS on GNS2, GDU1, and GDU2 (if the copilot has GPS2 displayed on the CDI).

AHRS 1 and ADC 1 will only be displayed on GDU1. AHRS2 and ADC2 will only be displayed on GDU2.

The **CDI** soft key toggles between selection of GPS or VOR/LOC as the active navigation source. In a single GDU 620 system, the GDU **CDI** soft key will change the source in the connected navigator and making a source change in the navigator will be reflected in the GDU 620. In a dual GDU 620 system, the **CDI** keys in the navigator are disabled.

3.4.1.6 Date and Time

The Date and Time options allow you to select the time to change UTC time to local time with a time offset.

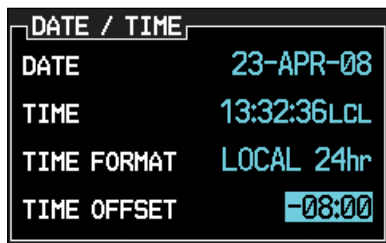

Figure 3-74 Time Format and Offset

Time Zone	Local Standard Time Offset	Local Daylight Savings Time Offset
Atlantic	-4 hours	-3 hours
Eastern	-5 hours	-4 hours
Central	-6 hours	-5 hours
Mountain	-7 hours	-6 hours
Pacific	-8 hours	-7 hours
Alaskan	-9 hours	-8 hours
Hawaiian	-10 hours	-9 hours

Table 3-4 U.S. Time Zone Offsets

- 1) While viewing the System Setup page of the AUX page group, press the small **MFD** knob to activate the cursor. Turn the large **MFD** knob to highlight "Time Format."
- 2) Turn the small **MFD** knob to select Local 12hr, Local 24hr, or UTC and then press **ENT**. When Local 12 or 24 hr mode is selected, the Time Offset value will then be highlighted.
- 3) Turn the small **MFD** knob to select the desired offset and then press **ENT**.

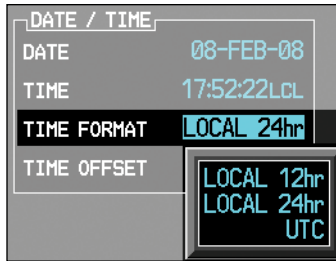

Figure 3-75 Date and Time Values

- 4) A Time Offset may be entered by using the large and small **MFD** knobs to change the values. Press **ENT** after completing any changes.
- 5) Press the small **MFD** knob to exit adjustments.

3.4.1.7 MFD Display Units

The MFD Display Units options allow you to select the units of measurement conventions displayed on the MFD. Distance and Speed selections are Imperial, Metric, or Nautical. Altitude and Vertical speed selections are Feet or Meters.

- 1) While viewing the System Setup page of the AUX page group, press the small **MFD** knob to activate the cursor. Turn the large **MFD** knob to highlight the Distance and Speed (DIS, SPD) units of measurement.

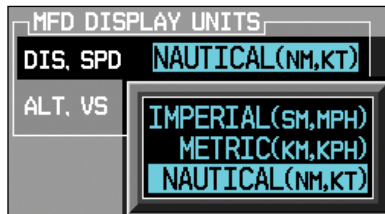

Figure 3-76 Distance and Speed MFD Display Units

- 2) Turn the small **MFD** knob to select Imperial, Metric, or Nautical and then press **ENT**. The Altitude and Vertical Speed units selection will now be highlighted.
- 3) Turn the small **MFD** knob to select Feet or Meters and then press **ENT**.

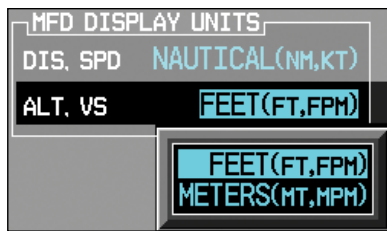

Figure 3-77 Altitude and Vertical Speed MFD Display Units

3.4.1.8 System Display Units

The System Display Units options allows the selection of units to display values for Navigation Angle (Magnetic or True), Barometric Setting (inches or Hectopascals), and Temperature (Fahrenheit or Celsius). Pressing the **DFLT UNIT** soft key will restore the Default Unit settings.

- 1) While viewing the System Setup page of the AUX page group, press the small **MFD** knob to activate the cursor. Turn the large **MFD** knob to highlight the System Display Units selection titled "Nav Angle."



CAUTION: The Nav Angle display units (Magnetic or True) must be set to the same type in both the GDU 620 and GNS navigators.

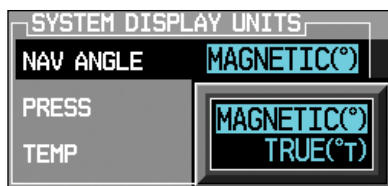

Figure 3-78 Nav Angle System Display Units

- 2) Turn the small **MFD** knob to select Magnetic or True and then press **ENT**. The Barometric Pressure Setting value will now be highlighted. When True is selected, a "T" will appear to the right of the heading value on the PFD.

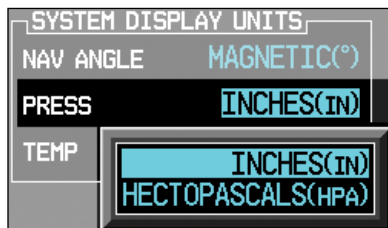

Figure 3-79 Barometric Setting System Display Units

Foreword
 Sec 1 System
 Sec 2 PFD
 Sec 3 MFD
 Sec 4 Hazard Avoidance
 Sec 5 Additional Features
 Sec 6 Annun. & Alerts
 Sec 7 Symbols
 Sec 8 Glossary
 Appendix A
 Appendix B Index

- Turn the small **MFD** knob to select the Barometric Setting units and then press **ENT**. The Temperature value will now be highlighted.

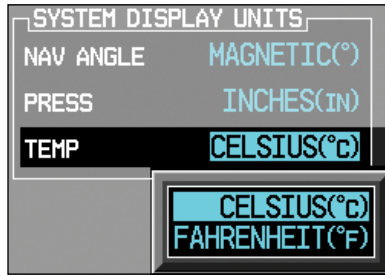

Figure 3-80 Temperature System Display Units

- Turn the small **MFD** knob to select the Temperature units and then press **ENT**.

3.4.2 Sirius XM Satellite Radio XM Information (Optional)

The Aux mode XM Information page displays information about the Sirius XM Satellite radios, service, and products when the GDL 69/69A is installed and the Sirius XM Satellite Radio service is activated.



Figure 3-81 XM Information

3.4.3 Sirius XM Satellite Radio XM Entertainment Radio (Optional)

Audio entertainment is available through the Sirius XM Satellite Radio Service when activated in the optional installation of the GDL 69A. The GDU 620 serves as the display and control head for your remotely mounted GDL 69A. Sirius XM Satellite Radio allows you to enjoy a variety of radio programming over long distances without having to constantly search for new stations. Based on signal from satellites, coverage far exceeds land-based transmissions. When enabled, the Sirius XM Satellite Radio audio entertainment is accessible in Aux Mode.

The information on the Sirius XM Satellite Radio display is composed of four areas: the Active Channel, Available Channels, Category of the highlighted Channel, and the Volume setting. The Active Channel window shows the Channel Name and Number, Artist, Song Title, and Category.

- 1) Turn the large **MFD** knob to the AUX page group.
- 2) Turn the small **MFD** knob to the XM Radio page.



Figure 3-82 XM Entertainment Radio

A description of Sirius XM Satellite Radio audio entertainment is provided in Section 5 - Additional Features.

3.4.4 System Status

The System Status Page displays the statuses, serial numbers, and software version numbers for all detected system LRUs. Pertinent information on all system databases is also displayed. Active LRUs are indicated by green check marks; failed LRUs by red “X’s.” Failed LRUs should be noted and a service center or Garmin-authorized dealer informed.

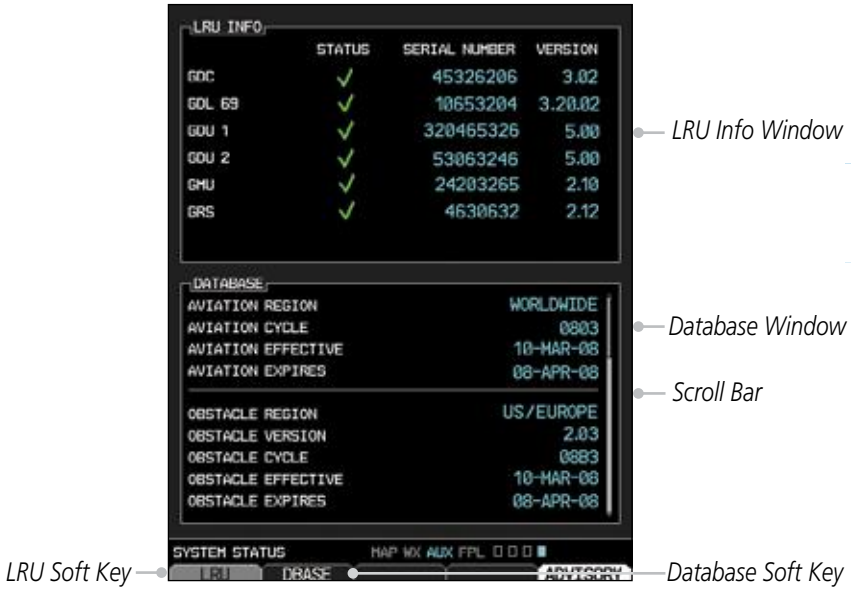

Figure 3-83 LRU and Database Information

- 1) Turn the large **MFD** knob to the AUX page group.
- 2) Turn the small **MFD** knob to the System Status page.
- 3) Press the **LRU** soft key to highlight the first item in the LRU Info window.
- 4) Turn the small **MFD** knob to scroll through the items in the LRU Info window in case more items are available than are displayed. If more items are available than can be displayed in the window, a scroll bar will show on the right side of the window.
- 5) Press the **DBASE** soft key to highlight the first item in the Database window.
- 6) Turn the small or large **MFD** knobs to scroll through the items in the Database window in case more items are available than are displayed. If more items are available than can be displayed in the window, a scroll bar will show on the right side of the window.

Foreword
 Sec 1 System
 Sec 2 PFD
 Sec 3 MFD
 Sec 4 Hazard Avoidance
 Sec 5 Additional Features
 Sec 6 Annun. & Alerts
 Sec 7 Symbols
 Sec 8 Glossary
 Appendix A
 Appendix B Index

3.4.5 External Video (optional)

External Video is an optional function that displays video provided by an externally mounted video source on the aircraft.

- 1) Turn the large **MFD** knob to the Aux page group.
- 2) The External Video page is the first page in the Aux page group.

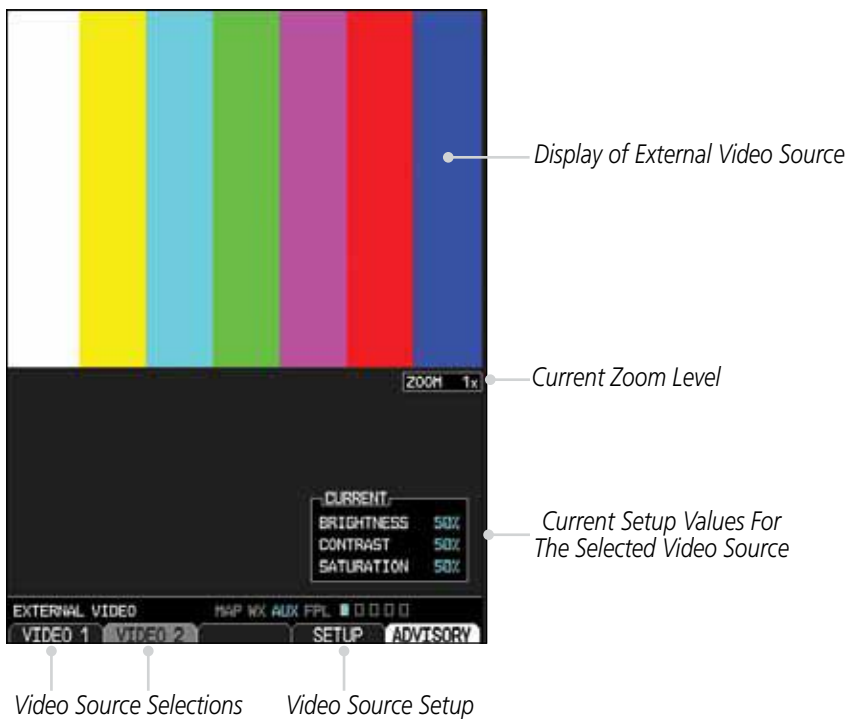

Figure 3-84 External Video

3.4.5.1 Select Video Source

If more than one video source is available, the **Video 1** and **Video 2** soft keys will be available at the bottom of the display.

- 1) Touch the **Video 1** soft key to select Video 1 source for viewing and setup.
- 2) Touch the **Video 2** soft key to select Video 2 source for viewing and setup.

3.4.5.2 Zoom

- 1) While viewing the External Video function, press the **Up Rng Arrow** key to increase the zoom up to 10x magnification. Zoom level is made through digital magnification.
- 2) Press the **Down Rng Arrow** key to decrease the zoom level down to a minimum of 1x.

Foreword
System
Sec 1

3.4.5.3 Panning

- 1) While viewing the External Video function, press the small **MFD** knob to activate panning.
- 2) Turn the small **MFD** knob clockwise to pan up (the map will move down).
- 3) Turn the small **MFD** knob counterclockwise to pan down (the map will move up).
- 4) Turn the large **MFD** knob clockwise to pan to the right (the map will move left).
- 5) Turn the large **MFD** knob counterclockwise to pan to the left (the map will move right).
- 6) Press the small **MFD** knob to exit panning.

Sec 2
PFD
Sec 3
MFD

Sec 4
Hazard
Avoidance
Sec 5
Additional
Features

3.4.5.4 Setup

The display of each video source is set up individually.

- 1) While viewing the External Video page, press the soft key for the desired Video source (**Video 1** or **Video 2**).
- 2) Press the **Setup** soft key.
- 3) The Current value for Brightness will be selected. Use the following directions for each value.

Sec 6
Annun.
& Alerts
Sec 7
Symbols
Sec 8
Glossary

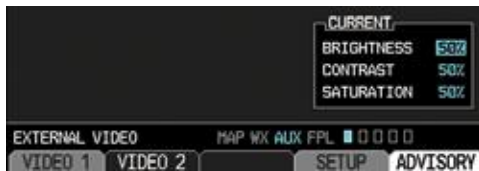

Figure 3-85 External Video Setup

- 4) After selecting the desired settings, press the small **MFD** knob or the **Setup** soft key to exit editing.

Appendix A
Appendix B
Index

Brightness Adjustment

- 1) While viewing the External Video page and the desired Video source, press the **Setup** soft key.
- 2) The Current value for Brightness will be selected. Turn the small **MFD** knob to adjust the Brightness value.



Figure 3-86 External Video Brightness Adjustment

- 3) After selecting the desired setting, turn the large **MFD** knob to highlight the next value or press the small **MFD** knob to exit editing.

Contrast Adjustment

- 1) While viewing the External Video page and the desired Video source, press the **Setup** soft key.
- 2) The Current value for Brightness will be selected. Turn the large **MFD** knob to highlight the Contrast value. Turn the small **MFD** knob to adjust the Contrast value.



Figure 3-87 External Video Contrast Adjustment

- 3) After selecting the desired setting, turn the large **MFD** knob to highlight the next value or press the small **MFD** knob to exit editing.

Saturation Adjustment

- 1) While viewing the External Video page and the desired Video source, press the **Setup** soft key.
- 2) The Current value for Brightness will be selected. Turn the large **MFD** knob to highlight the Saturation value. Turn the small **MFD** knob to adjust the Saturation value.



Figure 3-88 External Video Saturation Adjustment

- 3) After selecting the desired setting, press the small **MFD** knob to exit editing.

3.4.5.5 Restore Defaults

The Restore Defaults selection will return the Brightness, Contrast, and Saturation values to their original settings.

- 1) While viewing the External Video page, press the **MENU** key.



Figure 3-89 Restore Video Defaults Menu Selection

- 2) "Restore Defaults" will be highlighted. Press the **ENT** key.

3.4.6 Position Reporting (optional)

Position Reporting is a system which collects system variables and transmits them over the Iridium® satellite at a given interval through the GSR 56.

3.4.6.1 Status

The Status window shows the time until the next data transmission and the status of the reporting system.



NOTE: The GSR 56 does not report its serial number until 90 seconds after power up of the GDU. As a result, for that period, the product info for the GSR 56 will show "Waiting."

Time Until Transmit

The Time Until Transmit field is a countdown timer that shows the time until the next data transmission. This field is blank when the aircraft is on the ground.



Countdown Time Until Transmit

Figure 3-90 Position Reporting Time Until Transmit

Position Reporting Status

Position Reporting will be enabled when the aircraft is in the air.

Status	Description
Idle	The reporting system is not using the GSR 56 for reporting at this time.
Initializing	The GSR 56 and its driver are currently initializing.
Transferring	A position report is currently being transmitted.
Unavailable	The GSR 56 is currently not usable by the reporting system.

Table 3-5 Position Reporting Status

3.4.6.2 Report Type Standard

When the Standard reporting type is used, the Position Reporting Period may be set to Off or Automatic. The Automatic Position Reporting Period can be set to intervals of 2 to 60 minutes.

- 1) Turn the large **MFD** knob to reach the Aux page group. Turn the small **MFD** knob to reach the Position Reporting page.
- 2) Press the small **MFD** knob to select the Report Type.
- 3) Turn the small **MFD** knob to highlight Standard and then press the **ENT** key.



Figure 3-91 Select Standard Reporting

- 4) The Position Reporting Period type will now be selected. Turn the small **MFD** knob to highlight "Off" or "Automatic" and then press the **ENT** key. The Position Reporting Period interval will now be selected.
- 5) Turn the small **MFD** knob to select the reporting frequency.



Figure 3-92 Select Standard Reporting Period Frequency

- 6) Press the small **MFD** knob to exit editing.
- 7) With the Standard Reporting Type, the reporting period may be manually overridden by pressing the **SEND** soft key to send data.



Figure 3-93 Press SEND to Override the Reporting Period

Automatic Flight Following (AFF)

The G500 system, when combined with a GSR 56 Iridium datalink, can send position reports that contain data as required by the U.S. Government Automated Flight Following system. The GSR 56 account will allow configuration to forward data to the Automated Flight Following system.

- 1) While viewing the Position Reporting function, press the small **MFD** knob to select the Report Type.
- 2) Turn the small **MFD** knob to highlight "AFF" and then press the **ENT**.



Figure 3-94 Select Automatic Flight Following (AFF) Reporting Type

- 3) Turn the small **MFD** knob to select "OFF" or the default "Every 2 Min" value.



Figure 3-95 Select AFF Reporting Period Frequency

3.4.7 Iridium Phone Operation (Optional)

Optional satellite telephone operation is available through the Iridium® satellite system that is interfaced through the Garmin GSR 56.

Foreword

Sec 1
System



CAUTION: When interfaced with a GSR56 Iridium transceiver only one SD card may be present in the GDU620 and it must be in the lower slot.

3.4.7.1 Status

The Status section shows the Call Time, Phone Status, and Call Suppression selected. The Call Time value shows the length of the call time for the current call using the Iridium phone. Phone Status shows the current operating status of the Iridium phone.

Sec 2
PFD

Sec 3
MFD

Status	Description
Idle	The Iridium phone is not using the GSR 56 for communicating at this time.
Initializing	The GSR 56 and its driver are currently initializing.
Connected	The GSR 56 is connected to the called number.
Connecting Call	The GSR 56 is in the process of connecting to the called number.
Changing Volume	The volume level on the GSR 56 is changing.
Busy	The phone is in use by another service and the call may not be made.
Dialing	The GSR 56 is dialing the called number.
Incoming Call	A call is being made to the GSR 56.
Hanging Up	The GSR 56 is disconnecting from the current call.
Unavailable	The GSR 56 is currently not usable by the Iridium phone system.

Sec 4
Hazard
Avoidance

Sec 5
Additional
Features

Sec 6
Annun.
& Alerts

Sec 7
Symbols

Sec 8
Glossary

Appendix A

Appendix B
Index

Table 3-6 Iridium Phone Status

Call Suppression controls calling when use of the Iridium phone system is allowed.

- 1) Turn the large **MFD** knob to reach the Aux page group. Turn the small **MFD** knob to reach the Iridium Phone page.
- 2) Press the small **MFD** knob to select the Call Suppression type.

Status	Description
Off	Call Suppression is turned off. Calls may be transmitted and received through the Iridium phone.
On	Call Suppression is turned on. The incoming call pop-up will not be shown. The call may still be answered on the phone page. Outgoing calls are not affected.
On During APR/MAPR/TERM	Call Suppression is turned on during Approach, Missed Approach, and Terminal operations. The incoming call pop-up will not be shown. The call may still be answered on the phone page. Outgoing calls are not affected.

Table 3-7 Call Suppression

- 3) Turn the small **MFD** knob to highlight the desired selection.



Figure 3-96 Select Call Suppression

- 4) Press the **ENT** key. Press the small **MFD** knob again to cancel the selection cursor.

3.4.7.2 Managing the Phone Book

The Phone Book is stored on the SD card in the bottom slot. The Phone Book will only be available for use when the SD card is in the bottom slot. The Phone Book may hold up to 128 entries. A phone number may be entered and dialed without saving it to the Phone Book. Note that it is necessary to dial a "1," the area code, and then the number.

Creating Phone Number Names

- 1) Turn the large **MFD** knob to reach the Aux page group. Turn the small **MFD** knob to reach the Iridium Phone page.
- 2) Press the small **MFD** knob to activate the cursor and then turn the large **MFD** knob to highlight the Name item in the Phone Book. The Name field will blink.
- 3) If items already exist in the catalog, turn the large **MFD** knob to select the Phone Book Catalog icon. Then, turn the small **MFD** knob to display the contents of the Phone Book Catalog and highlight the New Entry selection and press **ENT**.



"New Entry" Selected for Phone Book Catalog Entry

Figure 3-97 "New Entry" Selected for Phone Book Catalog Entry

- 4) Turn the small **MFD** knob to select the first character of the name and then turn the large **MFD** knob to select the next character. When the name is complete, press the **ENT** key.



Figure 3-98 Phone Book Name Entry

Creating Phone Numbers with the Rotary Knobs

- 1) Turn the large **MFD** knob to the Phone Number field. Turn the small **MFD** knob to select the first character of the number and then turn the large **MFD** knob to select the next character. When the number is complete, press the **ENT** key.

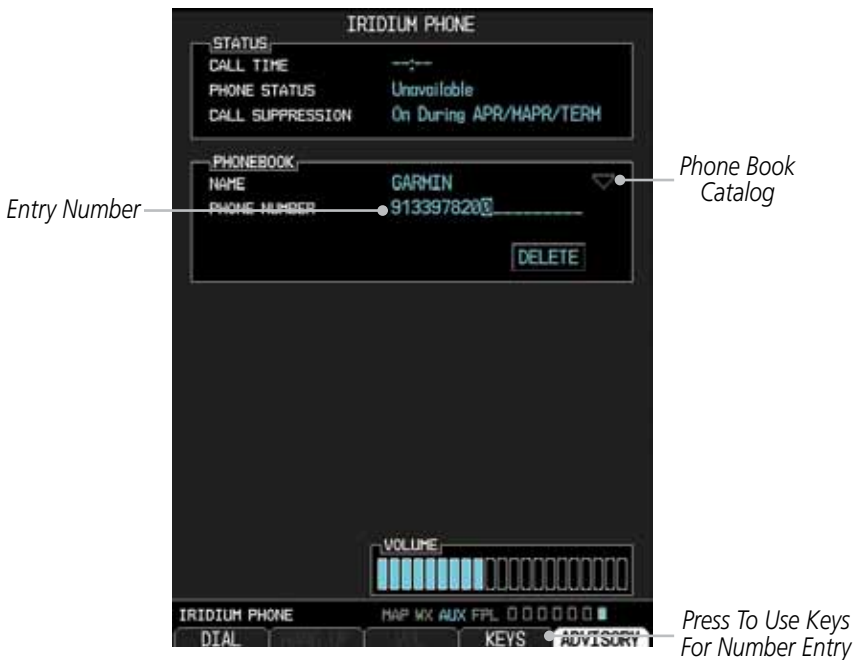

Figure 3-99 Phone Book Number Entry

- 2) Press the small **MFD** knob again to cancel the selection cursor.

Foreword

Sec 1
System

Sec 2
PFD

**Sec 3
MFD**

Sec 4
Hazard
Avoidance

Sec 5
Additional
Features

Sec 6
Annun.
& Alerts

Sec 7
Symbols

Sec 8
Glossary

Appendix A

Appendix B
Index

Creating Phone Numbers with Soft Keys

- 1) Numbers may also be entered using the soft keys at the bottom of the display. Press the **KEYS** key at the bottom of the display.



Figure 3-100 Phone Book Number Entry Using Hot Keys

- 2) Press the key for the group of desired numbers.

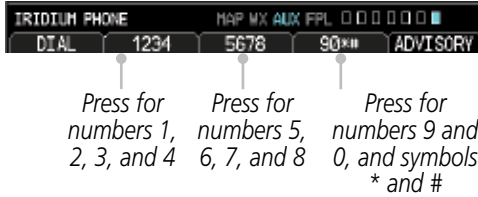

Figure 3-101 Selecting Numeric Groups for Phone Book Number Entry

- 3) Press the key for the desired number. Repeat as necessary and then press **ENT** when the number is complete.



Figure 3-102 Selecting Individual Numbers for Phone Book Number Entry

Selecting a Phone Book Catalog Entry

- 1) Press the small **MFD** knob to activate the cursor and then turn the large **MFD** knob to select the Phone Book Catalog icon.

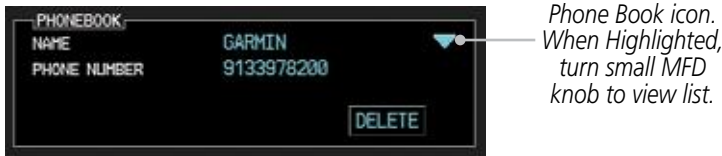

Figure 3-103 Selecting the Phone Book Catalog

- 2) Turn the small **MFD** knob to display the contents of the Phone Book Catalog and highlight the desired entry.

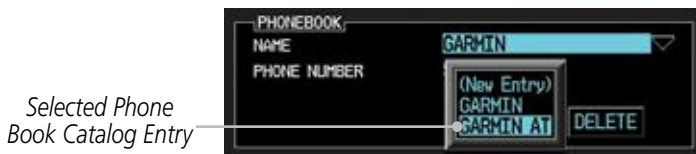

Figure 3-104 Selected Phone Book Catalog Entry

- 3) Press the **ENT** key. Press the small **MFD** knob again to cancel the selection cursor.

Deleting a Phone Book Catalog Entry

- 1) Press the small **MFD** knob to activate the cursor and then turn the large **MFD** knob to select the Phone Book Catalog icon.
- 2) Turn the small **MFD** knob to display the contents of the Phone Book Catalog and highlight the desired entry. Press **ENT** to select the catalog entry.
- 3) Turn the large **MFD** knob to highlight the **DELETE** key. Press **ENT** to delete the catalog entry. Press the small **MFD** knob again to cancel the selection cursor.

Editing a Phone Book Catalog Entry

- 1) Press the small **MFD** knob to activate the cursor and then turn the large **MFD** knob to select the Phone Book Catalog icon.
- 2) Turn the small **MFD** knob to display the contents of the Phone Book Catalog and highlight the desired entry. Press **ENT** to select the catalog entry.
- 3) Use the large **MFD** and small **MFD** knobs to make changes to the name or number. Press **ENT** to save the changes. Press the small **MFD** knob again to cancel the selection cursor.

3.4.7.3 Phone Volume

Use the Phone Volume controls to adjust the loudness of the phone calls you hear. Volume controls will only be available when the Idle, Connected, or Changing Volume states are displayed.

Adjusting the Phone Volume with the Rotary Knobs

- 1) While viewing the Iridium Phone page, press the small **MFD** knob and then turn the large **MFD** knob to select the Volume control. The volume bar graph will blink when selected.
- 2) Turn the small **MFD** knob to set the desired volume level.
- 3) Press the **ENT** key. Press the small **MFD** knob again to cancel the selection cursor.

Adjusting the Phone Volume with the Soft Keys

- 1) While viewing the Iridium Phone page, press the **VOL** key at the bottom of the display.



Figure 3-105 Select Soft Keys for Phone Volume Adjustment

- 2) Press the **+** or **-** keys as necessary to adjust the phone volume.

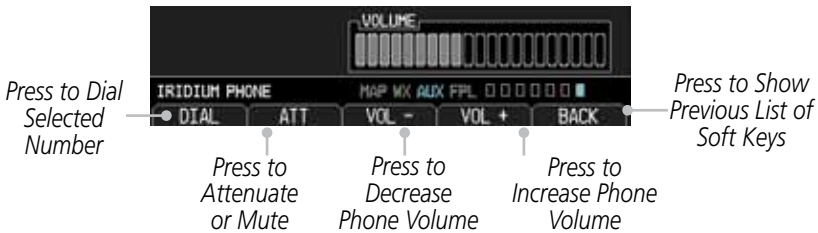

Figure 3-106 Using Soft Keys for Phone Volume Adjustment

- 3) Pressing the **ATT** soft key will attenuate the volume. Press the **ATT** soft key again to return to the previous volume.

3.4.7.4 Making a Phone Call

- 1) While viewing the Iridium Phone page, enter a phone number or select one from the Phone Book catalog.
- 2) Press the **DIAL** key.
- 3) After completing the call, press the **HANG UP** key.

3.4.7.5 Answering a Phone Call

An incoming phone call will generate a pop-up announcing the call. When a call is accepted, the pop-up will show that the call is connected and the cumulative call time will be shown.

- 1) When an incoming call is available, press the **ENT** key or the **ANSWER** soft key to answer the call. Or, press the **CLR** key or the **HANG UP** soft key to not answer the call and hang up.

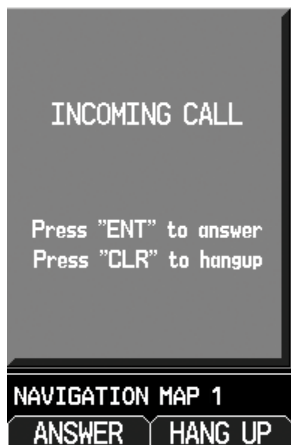

Figure 3-107 Incoming Call Pop-Up

- 2) After a called is accepted and connected, the connection time will be shown on the pop-up. Press the **ATT** soft key to attenuate the call volume; pressing it again will return to normal volume. Press the **HANG UP** soft key to end the call. Press the **VOL -** or **VOL +** keys to adjust the call volume.

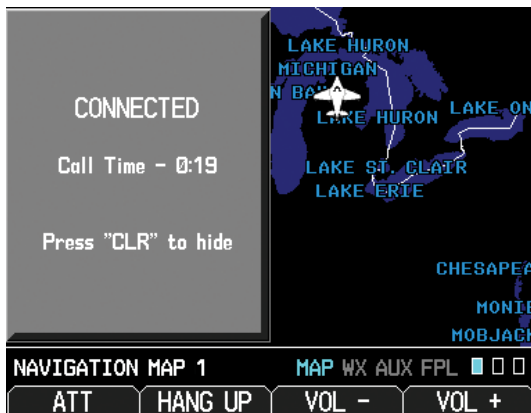

Figure 3-108 Connected Call Pop-Up

3.5 Flight Plan Pages

Use the Flight Plan page group to view details about your flight plan route. The Flight Plan Function shows the Current Flight Plan that is active in the navigation source displayed on the CDI.

3.5.1 Active Flight Plan Page

The Active Flight Plan box shows all of the legs of your flight plan with the current leg indicated in magenta. Listed are each leg with the Desired Track (DTK), Distance (DIS), and Estimated Time of Arrival (ETA) for the legs. METARs are shown for waypoints in the flight plan. In the Minimums window, the source and selected value are shown. See section 2.4.4 on Minimum Descent Altitude (MDA) or Decision Height (DH) in the PFD section and section 3.5.1.3 for more detail. In the Active Leg Info box in the lower part of the display, the Course with beginning and ending waypoints, Active Leg En Route Safe Altitude (ESA), and Route ESA are shown. METAR information is in the METAR section of Section 4 (Hazard Avoidance).

Foreword

Sec 1
System

Sec 2
PFD

Sec 3
MFD

Sec 4
Hazard Avoidance

Sec 5
Additional Features

Sec 6
Annun. & Alerts

Sec 7
Symbols

Sec 8
Glossary

Appendix A

Appendix B
Index

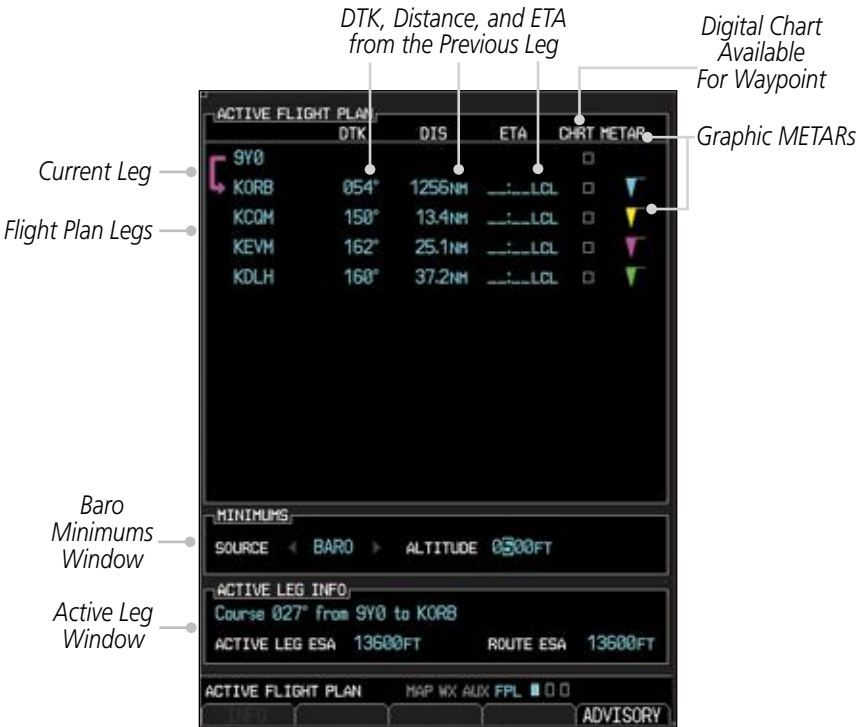

Figure 3-109 Flight Page 1 (Active Flight Plan)

3.5.1.1 Active Flight Plan Detail

The active flight plan is shown on the first page of the Flight Plan page group. Further information may be available for each waypoint as shown by the **INFO** or **WX** soft keys. The **WX** soft key will only appear if a data link receiver is installed and there is a Weather subscription.

- 1) Press the **MFD** knob and then use the large and small **MFD** knobs to highlight waypoints in the flight plan.
- 2) Press the **INFO** soft key, if available, to view information about the highlighted waypoint.
- 3) Press the **WX** soft key, if available, to view XM weather information about the highlighted waypoint.
- 4) Press the small **MFD** knob to return to the Active Flight Plan page.

3.5.1.2 Active Flight Plan Options

The Active Flight Plan page provides information for the flight plan currently in use for navigation.

To change data fields on the Active Flight Plan Page:

- 1) While viewing the Active Flight Plan Page of the FPL page group, press **MENU** to display the Active Flight Plan Page Options window.
- 2) Turn the large **MFD** knob to highlight "Change Fields?" and then press **ENT**.



Figure 3-110 Active Flight Plan Page Menu Option Selection

- 3) Turn the large **MFD** knob to highlight the field you wish to change.



Figure 3-111 Active Flight Plan Page Menu Change Fields Option Selection

- 4) Turn the small **MFD** knob to select the desired data item and press **ENT**.
- 5) Press the small **MFD** knob to remove the cursor.

To restore factory default settings for data fields on the Active Flight Plan Page:

- 1) While viewing the Active Flight Plan Page of the FPL page group, press **MENU** to display the Active Flight Plan Page Options window.
- 2) Turn the large **MFD** knob to highlight "Restore Defaults?" and then press **ENT**.



Figure 3-112 Active Flight Plan Page Menu Option Selection to Restore Defaults

3.5.1.3 Setting the Altitude Minimums Alerter

The Altitude Alerting function provides the pilot with visual and aural alerts (if interfaced to an audio panel) when approaching the Selected Altitude. Whenever the Selected Altitude is changed, the Altitude Alerter is reset. The Altitude Alerter is independent of any autopilot installed in the aircraft. See the Altitude Alerting section of the PFD section for more details.

- 1) While viewing the Charts Page of the FPL page group, press the **Menu** key. With the Set Minimums item highlighted, press **ENT**.
- 2) With the Minimums Source highlighted, select the Altitude Minimums Alerter source with small **MFD** knob.



Figure 3-113 Minimums Source Selection

- 3) Turn the large **MFD** knob to highlight the Altitude Minimums value. Turn the large and small **MFD** knobs to change the Altitude Minimums value.



Figure 3-114 Minimums Altitude Selection

4) Press **ENT** to activate the selected value.

In dual installations, the minimums alerting altitude value may be set from either GDU 620 and will be synchronized on both units.



NOTE: If you highlight the Minimums Altitude field on the FPL page and press the CLR key, it will turn the minimums functionality off.

3.5.2 Waypoint Information Page

The Waypoint Information page provides details about a particular waypoint. You can show a waypoint by selecting it by Ident, Facility Name, or by City. The Map window shows the selected waypoint in the center of the map. The Range keys zoom in and out on the map. The Info window at the bottom of the display shows the Bearing and Distance from your present position to the selected waypoint as well as its region and Lat/Lon coordinates. The map window is set up with the same parameters as were selected for Navigation Map Page 1.



Figure 3-115 Flight Plan Waypoint Information Page



NOTE: Waypoint information is shown on the second page of the Flight Plan page group.

3.5.2.1 Selecting a Waypoint

- 1) While viewing the Waypoint Information page of the FPL page group, press the **MFD** knob and use the large and small **MFD** knobs to move the cursor to select the identifier for the waypoint.



Figure 3-116 Waypoint Selection

- 2) Press the **ENT** key to select the waypoint.
- OR
- 1) While viewing the Waypoint Information page of the FPL page group, press the small **MFD** knob.
 - 2) Turn the small **MFD** knob counterclockwise.



Figure 3-117 Waypoint Category Selection

- 3) Turn the small **MFD** knob to show FPL, NRST, or RECENT.
- 4) Turn the large **MFD** knob to highlight the desired airport, and then press **ENT**.

Foreword

Sec 1
System

Sec 2
PFD

Sec 3
MFD

Sec 4
Hazard
Avoidance

Sec 5
Additional
Features

Sec 6
Annun.
& Alerts

Sec 7
Symbols

Sec 8
Glossary

Appendix A

Appendix B
Index

3.5.2.2 Waypoint Information Detail

More detailed information about a selected waypoint is available by pressing the **RWY/FREQ** or **APT DIR** soft keys on the Waypoint Information page. The current destination waypoint is the default item shown. You may select a different Ident, Facility, or Location. In the Runway window, you may view information about the runways available if a highlighted arrow is shown. In the Frequency window, a scroll bar is shown on the right side of the window when more frequencies are available.



Figure 3-118 Flight Plan Waypoint Info Detail

Foreword
 Sec 1 System
 Sec 2 PFD
 Sec 3 MFD
 Sec 4 Hazard Avoidance
 Sec 5 Additional Features
 Sec 6 Annun. & Alerts
 Sec 7 Symbols
 Sec 8 Glossary
 Appendix A
 Appendix B Index

Ident/Facility/City Selection

The current destination Identifier, Facility Type with icon, Facility Name, and City (location) are shown in the top window of the Flight Plan mode Waypoint Information page. The default is the Nearest airport if there is no active flight plan. New Identifiers may also be selected as shown in section 3.5.3.3.



Figure 3-119 Flight Plan Ident/Facility/City Detail

- 1) While viewing the Waypoint Information page of the FPL page group, press the **RWY/FREQ**, **APT DIR**, or **WX** soft keys to view information about the waypoint.
- 2) The current destination Ident, Facility, and City is shown, but may be changed to find information about other choices. Press the small **MFD** knob to activate the cursor. These fields may not be selected if the RWY, APT DIR, or WX pages are selected. If viewing those pages, press the soft key for that page again to return to the Waypoint Information page.
- 3) Use the large **MFD** knob to highlight the field you wish to change and use the small **MFD** knob to change the value.
- 4) Press the **ENT** key to save the selected value or press the small **MFD** knob to cancel editing.

Runway Information Selection

Information is provided for each runway showing the following detail: runway number, runway length, surface type, and the frequency for Pilot-Controlled Lighting (PCL).



Figure 3-120 Waypoint Runway Information

- 1) While viewing the Waypoint Information page of the FPL page group, press the **RWY/FREQ** soft key to view information about the waypoint and press the small **MFD** knob to activate the cursor.
- 2) Use the large **MFD** knob to highlight the Runway and use the small **MFD** knob to display the available runways.
- 3) Press the small **MFD** knob to cancel editing.

Facility Frequency Selection

The Frequency window at the bottom of the Waypoint Information page shows the frequencies available for the selected waypoint. A scroll bar is shown on the right side of the Frequency window if more frequencies are available.

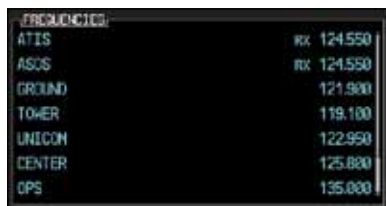

Figure 3-121 Waypoint Frequency Information

- 1) While viewing the Waypoint Information page of the FPL page group, press the **RWY/FREQ** soft key to view information about the waypoint and then press the small **MFD** knob to activate the cursor.
- 2) Turn the small **MFD** knob to scroll through the available frequencies.
- 3) Press the small **MFD** knob to exit.

3.5.2.3 Airport Directory

The Airport Directory lists extensive information about the selected airport and the surrounding area. The **RWY/FREQ** and **APT DIR** soft keys are greyed out and not functional unless the selected waypoint is an airport or heliport.



NOTE: *Airport Directory information comes from a database provided by various 3rd parties. Refer to the Database information in the AUX – SYSTEM STATUS page for details on the installed Airport Directory database.*

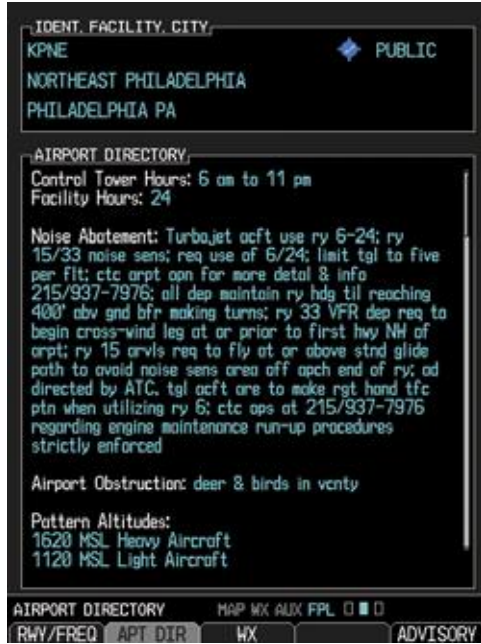

Figure 3-122 Airport Directory Information

- 1) While viewing the Waypoint Information page of the FPL page group, press the **APT DIR** soft key to view more information about the waypoint.
- 2) Press the small **MFD** knob to activate the cursor.
- 3) Use the small or large **MFD** knob to scroll through the information.
- 4) Press the small **MFD** knob to deactivate the cursor. Press the **APT DIR** soft key again to return to the Waypoint Information page.

Foreword
 System Sec 1
 PFD Sec 2
 MFD Sec 3
 Avoidance Sec 4
 Hazard Sec 4
 Additional Features Sec 5
 Annun. & Alerts Sec 6
 Symbols Sec 7
 Glossary Sec 8
 Appendix A
 Appendix B

3.5.2.4 Waypoint Weather Information (Optional)

The Weather information function is available if a data link receiver is installed, a weather subscription is current, and weather information is available for the selected waypoint. METAR and TAF text are displayed on the Waypoint Weather Information Page. Pressing the **WX** soft key will show the weather information page. METAR data is displayed first, then TAF information is displayed.

TAF (Terminal Aerodrome Forecast) is the standard format for 24-hour weather forecasts. A TAF typically forecasts significant weather changes, temporary changes, probable changes, and expected changes in weather conditions.



Figure 3-123 Waypoint Weather Information (Textual METARs and TAFs)

- 1) While viewing the Waypoint Information page of the FPL page group, press the **WX** soft key to view weather information for the waypoint.
- 2) Use the small **MFD** knob or the large **MFD** knob to scroll through the available information.
- 3) Press the small **MFD** knob to return to the main Flight Plan page.

3.5.3 Charts Page (Optional)

Charts, when installed, are available in the Flight Plan page group. ChartView is an optional feature that requires enablement by a Garmin dealer.

- 1) Turn the large **MFD** knob to the Flight Plan page group.
- 2) Turn the small **MFD** knob to the Charts page.



NOTE: There are two options for chart services: FliteCharts or ChartView. FliteCharts displays charts that are FAA-published. ChartView displays charts published by Jeppesen. ChartView charts are geo-referenced, which allows a pink ownship icon to be overlaid on the chart indicating the aircraft location.

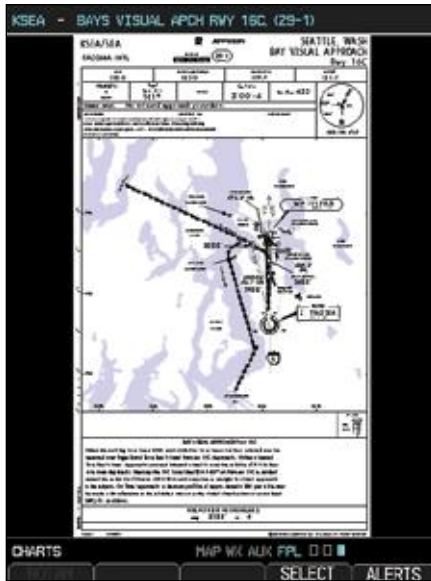

Figure 3-124 Flight Page 3 (Charts)

Foreword

System Sec 1

PFD Sec 2

MFD Sec 3

Hazard Avoidance Sec 4

Additional Features Sec 5

Annun. & Alerts Sec 6

Symbols Sec 7



Glossary Sec 8

Appendix A

Appendix B Index

3.5.3.1 Viewing Charts

The chart for the selected destination airport or approach is automatically loaded. With ChartView only and when available for the selected chart, more detail is available.

- 1) While viewing the Charts page of the FPL page group, press the **RNG** (Range)   keys to zoom in and out.
- 2) After zooming in, you may only see part of the chart. Press the **Small MFD** knob to enter Pan mode and activate scroll bars on the edges of the chart. Turn the large and small **MFD** knobs to move around the chart.

NOTE: When Panning mode is active, scroll bars will be shown on the right side and bottom of the display.

- 3) Press the small **MFD** knob to cancel the scroll bars and exit panning.

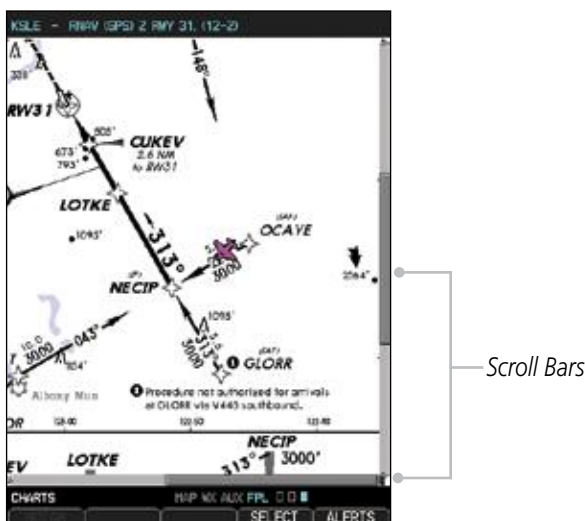

Figure 3-125 Chart Scroll Bars (Charts)

3.5.3.2 Selecting a New Chart by Airport

A chart for a different airport may be chosen by selecting the identifier for the desired airport.

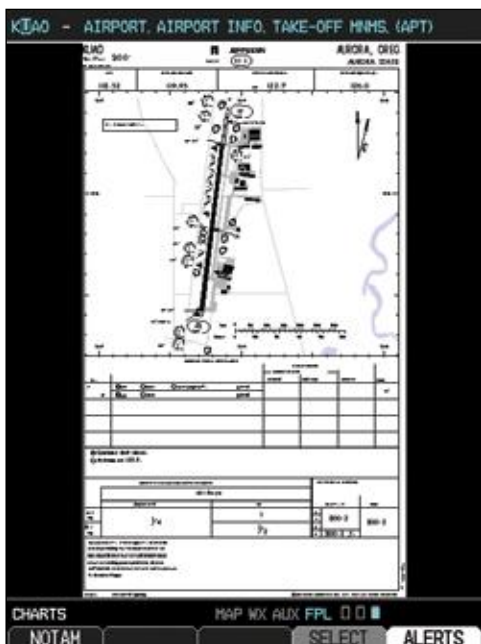

Figure 3-126 Airport Identifier Selection

- 1) While viewing the Charts page of the FPL page group, press the **SELECT** soft key to change the airport.
- 2) Use the large **MFD** knob to move the cursor to highlight a character.
- 3) Use the small **MFD** knob to change the character.
- 4) Press **ENT** to accept the selected airport.
- 5) Use the large and small **MFD** knobs to select the desired chart.
- 6) Press **ENT** to display the desired chart.
- 7) With ChartView only and when available for the selected chart, more detail is available. Press the **Detail** key to view detailed views of the current chart. Press the **Header**, **Plan**, **Profile**, or **Minimums** keys to view detailed sections for the chart for those topics.

3.5.3.3 Selecting a New Chart by FPL, NRST, or RECENT

You may select other charts to display based on your flight plan (FPL), charts of the nearest airport (NRST), or your most recently selected airport (RECENT).



Figure 3-126 Chart Category Selection

- 1) While viewing the Charts page of the FPL page group, press the **SELECT** soft key.
- 2) Turn the small **MFD** knob counterclockwise.
- 3) Turn the small **MFD** knob to show FPL, NRST, or RECENT.
- 4) Turn the large **MFD** knob to highlight the desired airport, and then press **ENT**.

3.5.3.4 Change Day/Night View

The Chart pages can be displayed on a white or black background for day or night viewing. The Day View offers a better presentation in a bright environment. The Night View gives a better presentation for viewing in a dark environment. The “auto” setting allows the user to set a percentage. This percentage is the backlight value where the charts page will automatically switch between day and night mode. If you set the unit to AUTO 10%, then if the backlight is below 10% it will be in night mode, if above 10% it will be in day mode.

- 1) While viewing the Charts page of the FPL page group, turn the small **MFD** knob to reach the Charts page.
- 2) Press **MENU** to display the Options menu.
- 3) Press **ENT** to display the Chart Setup menu. The Color Scheme option will be highlighted.
- 4) Turn the small **MFD** knob to select Day - Auto - Night.
- 5) Press the small **MFD** knob or the **ENT** key to save the selected setting and return to the Charts page.
- 6) If “Auto” is selected, turn the large **MFD** knob to highlight the Display Level Brightness value. Turn the small **MFD** knob to change the value and then the **ENT** key to save the selected value.

Foreword
 Sec 1 System
 Sec 2 PFD
 Sec 3 MFD
 Sec 4 Hazard Avoidance
 Sec 5 Additional Features
 Sec 6 Annun. & Alerts
 Sec 7 Symbols
 Sec 8 Glossary
 Appendix A
 Appendix B Index

4 HAZARD AVOIDANCE

The G500 hazard avoidance features are designed to provide advisory information of potential hazards to flight safety associated with weather, terrain, and air traffic.

This section is divided into the following groups:

Terrain Avoidance

- Terrain Proximity
- Garmin Terrain-SVT™ (Optional)

Traffic Avoidance

- Traffic Advisory System (Optional)
- Traffic Information Service (TIS)
(Optional - GTX 33/330 Transponder required)

Weather

- GDL 69/69A XM® Satellite Weather (Optional)
- Weather Radar (Optional)
- GFDS Weather with the Iridium® satellite system through GSR 56 (Optional)

4.1 Terrain Configurations

The following terrain awareness configurations are available in the G500 system:

- Terrain-SVT - Refers to a subset of Class B TAWS that will meet the terrain alerting requirements outlined in Section 7.b of AC 23-26. Terrain-SVT is a subset of Class B TAWS that provides a Class B TAWS FLTA functionality, including visual alerting and aural alerting. Terrain-SVT is provided with the Synthetic Vision functionality and not marketed separately.



NOTE: *Terrain-SVT is not a fully functional TAWS and does not meet the TAWS TSO-C151b.*

- Terrain-Proximity - Refers to the display of the relative terrain elevations on the moving map. No aural alerts of any type are provided by a Terrain-Proximity configuration.

During power-up of the GDU 620, the terrain/obstacle database versions are displayed along with a disclaimer. At the same time, the Terrain system self-test begins. A failure message is issued if the terrain test fails.

G500 Terrain Configuration	Alert Source			
	PFD Annunciator Text	SVT Terrain/Obstacle Shading	MFD Terrain/Obstacle Alerts	Aural Callouts
Terrain Proximity	-	-	-	-
Terrain Proximity w/ GNS/GTN TAWS	GNS/GTN TAWS	-	-	GNS/GTN TAWS
Terrain Proximity w/3rd-party TAWS	-	-	-	3rd-party TAWS
Terrain-SVT	G500	G500*	G500	G500
Terrain-SVT w/ GNS/GTN TAWS	GNS/GTN TAWS**	G500*	G500	GNS/GTN TAWS**
Terrain-SVT w/3rd-party TAWS	-	G500*	G500	3rd-party TAWS

Table 4-1 G500 Terrain Annunciations

* SVT Terrain/Obstacle shading is only available when SVT is enabled and displayed.

** If the Garmin GPS/TAWS is not available, the G500 Terrain-SVT will generate PFD annunciator text and aural callouts. An advisory message will indicate when reversion to Terrain-SVT alerting has occurred.

GNS/GTN TAWS may be provided by a GNS 500WT-series or GTN-series navigator with TAWS. The GNS/GTN TAWS must be interfaced to the G500 as GPS 1.

In all configurations, any terrain information or alerts displayed on the MFD are generated by the G500. Each of the terrain awareness configurations are detailed in the following sub-sections.

4.2 Terrain Scale

The Terrain Scale option in the Map page group selects whether the Terrain Scale is shown on the Navigation Map. The Terrain scale will be located on the right side of the display.



Figure 4-1 Terrain Scale

Color	Description
Red	Terrain is more than 100 ft above the aircraft.
Yellow	Terrain is between 1000 ft below and 100 ft above the aircraft.
Black	Terrain is more than 1000 ft below the aircraft.

Table 4-2 Terrain Scale Color Codes

4.3 Terrain Proximity

Garmin Terrain is a non-TSO-C151b-certified terrain awareness system provided as a standard feature of GDU 620 to increase situational awareness and help reduce controlled flight into terrain (CFIT). Terrain may be displayed on the Map page group Navigation Map and Terrain pages.

Terrain Proximity uses information provided from the GPS receiver to provide a horizontal position and altitude. GPS altitude is derived from satellite measurements. GPS altitude is converted to a Mean Sea Level (MSL)-based altitude (GPS-MSL altitude) and is used to determine Terrain alerts. GPS-MSL altitude accuracy is affected by factors such as satellite geometry, but it is not subject to variations in pressure and temperature that normally affect pressure altitude devices. GPS-MSL altitude does not require local altimeter settings to determine MSL altitude. Therefore, GPS altitude provides a highly accurate and reliable MSL altitude source to calculate terrain and obstacle alerts.

Terrain Proximity utilizes terrain and obstacle databases that are referenced to mean sea level (MSL). Using the GPS position and GPS-MSL altitude, Terrain Proximity displays a 2-D picture of the surrounding terrain and obstacles relative

to the position and altitude of the aircraft. In this manner, TERRAIN Proximity provides awareness of surrounding terrain conditions.

Terrain requires the following to operate properly:

- The system must have a valid 3-D GPS position solution.
- The system must have a valid terrain/obstacle/airport terrain database.

4.3.1 Displaying Terrain Proximity

The Terrain Proximity page is in the Map page group. Terrain is also selectable on the Navigation Map pages.

4.3.1.1 Terrain Proximity Page Display on the Terrain Page

- 1) Turn the Large **MFD** knob to the MAP page group.
- 2) Turn the small **MFD** knob to the Terrain page.
- 3) Press the **VIEW** soft key to show the 360 and ARC soft keys.

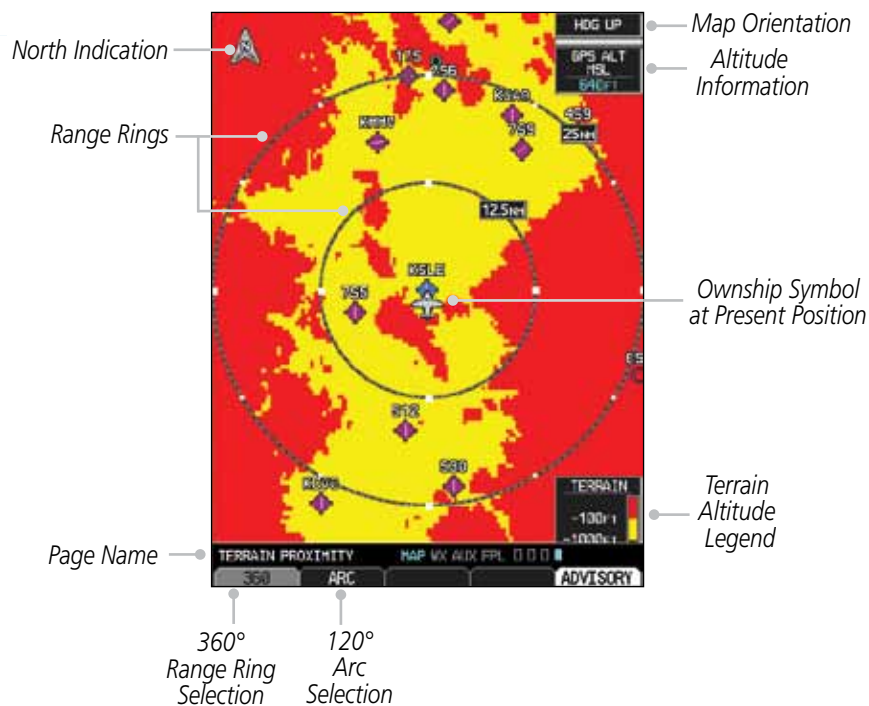

Figure 4-2 Terrain Page with Aviation Data Displayed and 360° View

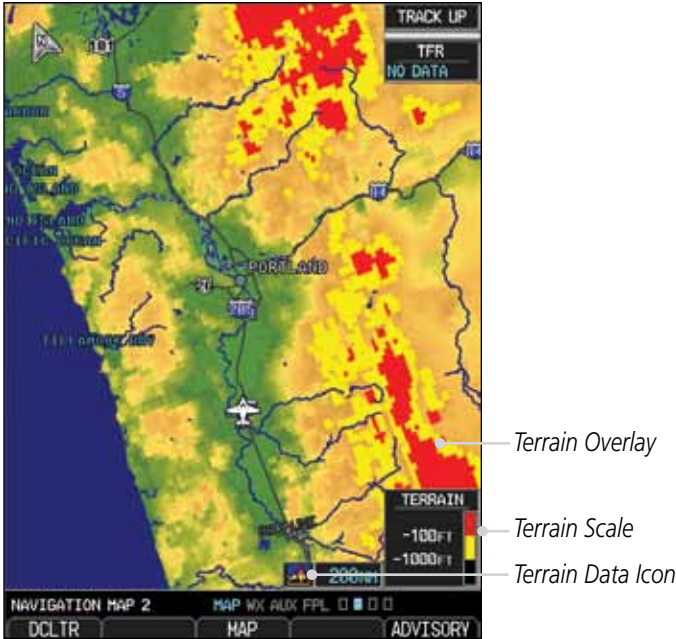

Figure 4-3 Terrain on Navigation Map Page

4.3.1.2 Terrain Proximity Page Display on a Navigation Map Page

- 1) Turn the large **MFD** knob to the MAP page group.
- 2) On Navigation Map page 1 or 2, press the **MAP** soft key to show the **TERRAIN** soft key.
- 3) Press the **TERRAIN** soft key to overlay terrain on the Navigation Map.

4.3.1.3 Terrain Proximity Page 120° Arc or 360° Rings

Select the 120° Arc or 360° rings overlay for the Terrain page with either the 360/Arc soft keys or from the Page Menu.

- 1) Press the **VIEW** soft key to show the 360 and ARC soft keys.
 - 2) Press the **360** or **Arc** soft key.
- OR
- Press **MENU** and the with the View Arc or View 360° selection highlighted press **ENT**.



Figure 4-4 Terrain Page Menu Viewing Selections

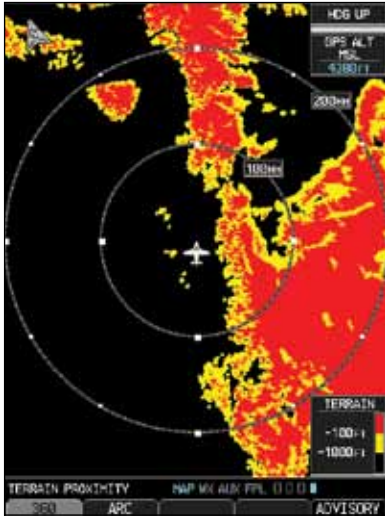

Figure 4-5 Terrain Page with 360° Rings

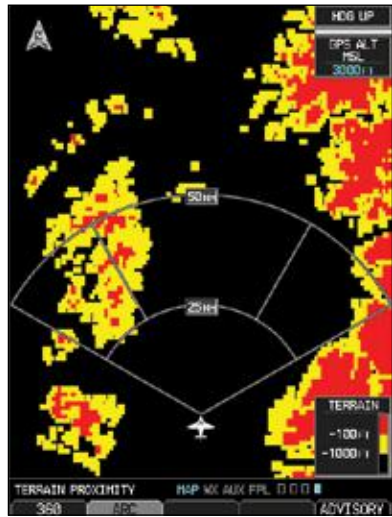

Figure 4-6 Terrain Page with 120° Arc

4.3.1.4 Terrain Proximity Page Aviation Data

The Page Menu selections allow you to hide or show aviation data overlay on the Terrain page.

- 1) While viewing the Terrain page of the MAP page group, press **MENU** for Map selections to hide or show aviation data overlay on the Terrain page.



Figure 4-7 Show/Hide Aviation Data on the Terrain Page

2) Press **ENT** to save the highlighted value.

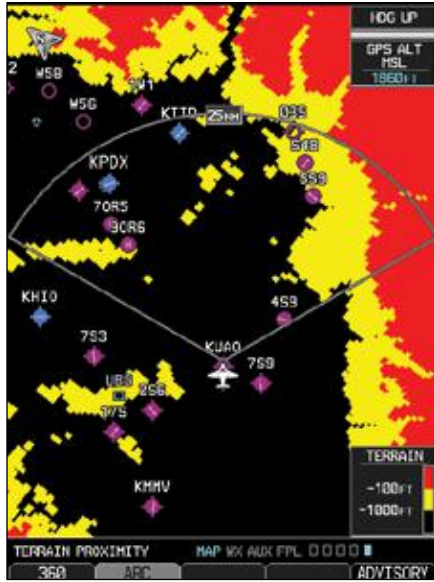

Figure 4-8 Terrain Page with Aviation Data Displayed and 120° Arc View

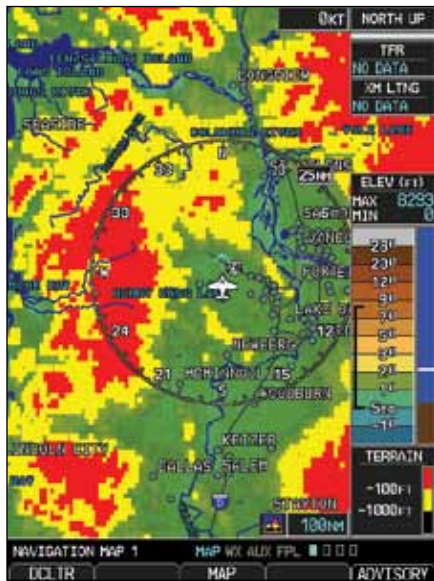

Figure 4-9 Navigation Map Page with Terrain Data Displayed

4.3.2 Terrain Proximity Limitations

Terrain Proximity displays terrain and obstructions relative to the altitude of the aircraft. The displayed terrain is advisory in nature only. Individual obstructions may be shown if available in the database. However, all obstructions may not be available in the database and data may be inaccurate. Never use this information for navigation or to maneuver to avoid obstacles.

Terrain information is based on terrain elevation information in a database that may contain inaccuracies. Terrain information should be used as an aid to situational awareness. Never use it for navigation or to maneuver to avoid terrain.

Terrain uses terrain and obstacle information supplied by government sources. The displayed information should never be understood as being all-inclusive.

WARNING: *The data contained in the Terrain databases comes from government agencies. Garmin accurately processes and cross-validates the data but cannot guarantee the accuracy and completeness of the data.*

4.3.3 System Status

The Terrain system continually monitors several system-critical items, such as database validity, hardware status, and GPS status. Should the system detect a failure, a failure message will be displayed.



Sec 1 System Foreword

Sec 2 PFD

Sec 3 MFD

Sec 4 Hazard Avoidance

Sec 5 Additional Features

Sec 6 Annun. & Alerts

Sec 7 Symbols

Sec 8 Glossary

Appendix A

Appendix B Index

4.4 External TAWS

If a GNS 500WT-series or GTN-series with TAWS unit is interfaced as GPS 1, text alerts generated by the external TAWS unit will be displayed on the PFD. Refer to the GNS 500WT-series or GTN-series Pilot's Guides and/or Addendums for more information regarding these TAWS alerts. Text alerts received from the GNS/GTN TAWS unit will be displayed to the left and aligned with the top of the Altitude Tape on the PFD. A new annunciation will flash for approximately five seconds.

- TAWS annunciations can only be received from the #1 GPS unit.
- If the Garmin GPS/TAWS is not available and Terrain-SVT is enabled, the G500 Terrain-SVT will generate PFD text alerts and aural callouts. An advisory message will indicate when reversion to Terrain-SVT alerting has occurred.



Figure 4-10 TAWS Annunciations from a GNS/GTN TAWS

Foreword

Sec 1 System

Sec 2 PFD

Sec 3 MFD

Sec 4 Hazard Avoidance

Sec 5 Additional Features

Sec 6 Annu. & Alerts

Sec 7 Symbols

Sec 8 Glossary

Appendix A

Appendix B Index

4.5 Garmin Terrain-SVT™ (Optional)

Garmin Terrain-SVT™ refers to a subset of Class B TAWS that meets the terrain alerting requirements outlined in Section 7.b of AC 23-26. Terrain-SVT is a subset of Class B TAWS that provides a Class B TAWS FLTA functionality with visual alerting and aural alerting. Terrain-SVT is provided with Garmin Synthetic Vision Technology (SVT™) functionality and not marketed separately.

Terrain-SVT alerting consists of the following alert types:

- Forward Looking Terrain Avoidance (FLTA) Alerting which consists of:
- Required Terrain Clearance (RTC) / Required Obstacle Clearance (ROC) Alerting
- Imminent Terrain Impact (ITI) / Imminent Obstacle Impact (IOI) Alerting

Terrain-SVT is available in G500 GDU 620 SW version 3.00, and later.

Foreword

Sec 1
SystemSec 2
PFDSec 3
MFDSec 4
Hazard
AvoidanceSec 5
Additional
FeaturesSec 6
Annun.
& AlertsSec 7
SymbolsSec 8
Glossary

Appendix A

Appendix B
Index

4.5.1.1 Garmin Terrain-SVT™ Page 120° Arc or 360° Rings

Select the 120° Arc or 360° rings overlay for the Terrain page with either the 360/Arc soft keys or from the Page Menu.

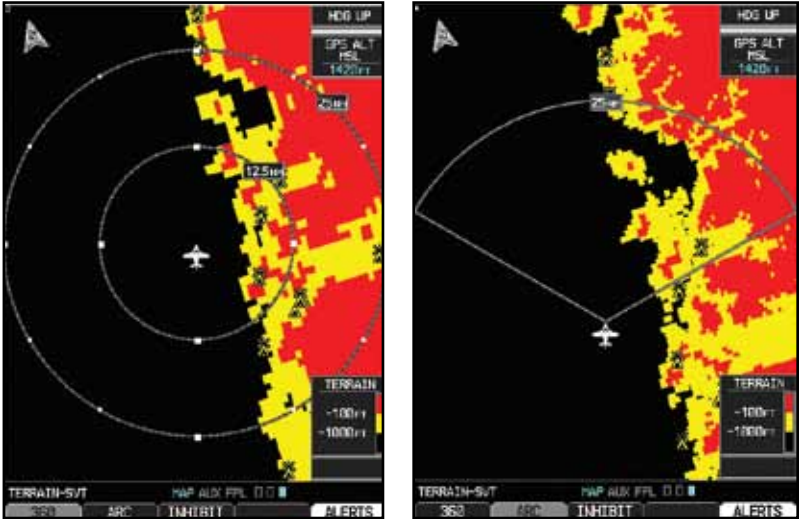

Figure 4-11 Terrain-SVT 360 and Arc Views

1. Press **VIEW** and then the **360** or **Arc** soft key.
OR
2. Press **MENU** and then with the "View Arc" or "View 360°" selection highlighted press **ENT**.



Figure 4-12 Terrain-SVT Page Menu Viewing Selections

Foreword

Sec 1
System

Sec 2
PFD

Sec 3
MFD

Sec 4
Hazard
Avoidance

Sec 5
Additional
Features

Sec 6
Annun.
& Alerts

Sec 7
Symbols

Sec 8
Glossary

Appendix A

Appendix B
Index

4.5.1.2 Garmin Terrain-SVT™ Page Aviation Data

Select the display of Aviation data on the Garmin Terrain-SVT page. The Page Menu selections allow you to hide or show aviation data overlay on the Terrain or the Map Setup options for the Navigation Map pages.

- 1) While viewing the Terrain page of the MAP page group, press **MENU** for Map selections to hide or show aviation data overlay on the Terrain or the Map Setup options for the Navigation Map pages.



Figure 4-13 Show/Hide Aviation Data on the Terrain-SVT Page

- 2) Press **ENT** to save the highlighted value.

4.5.1.3 Inhibiting/Enabling Garmin Terrain-SVT™ Alerting

Terrain-SVT has an inhibit mode that deactivates the FLTA aural and visual alerts. Pilots should use discretion when inhibiting Terrain-SVT and always remember to enable the system when appropriate.

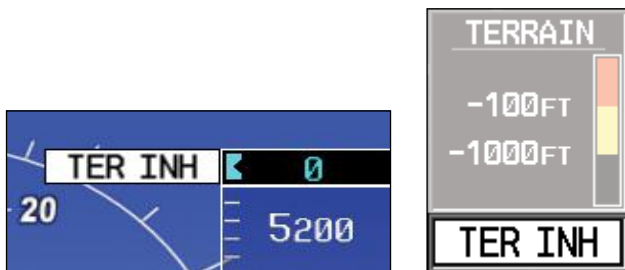

Figure 4-14 Terrain-SVT Alerting Disabled (Alerts Inhibited) Annunciation (PFD & MFD)

- 1) In MAP page group, turn the small **MFD** knob to reach the Terrain SVT Page.
- 2) Press the **INHIBIT** soft key to inhibit or enable Terrain SVT (choice dependent on current state).
OR
- 1) Press the **MENU** key.
- 2) Use the large or small **MFD** knob to highlight "Inhibit Terrain" or "Enable Terrain" (choice dependent on current state) and press the **ENT** key.

4.5.1.4 Synthetic Vision Alerts and Annunciations

Terrain-SVT alerts typically employ a CAUTION or a WARNING alert severity level, or both. When an alert is issued, visual annunciations are displayed and aural alerts are simultaneously issued.

When an alert is issued, annunciations appear on the PFD and MFD (Terrain-SVT page only). The Terrain Alert Annunciation is shown to the upper left of the Altimeter on the PFD and below the Terrain Legend on the MFD. If the Terrain-SVT page is not displayed at the time, a pop-up alert appears on the MFD. To acknowledge the pop-up alert:

Press the **CLR** key (returns to the currently viewed page)

OR

Press the **ENT** key (accesses the Terrain-SVT Page)

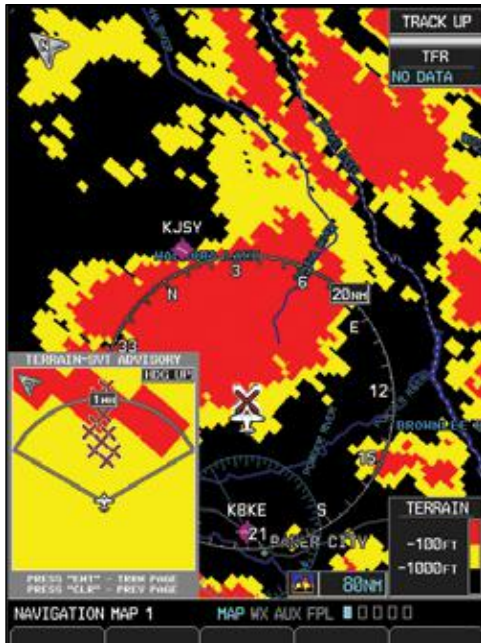

Figure 4-15 Terrain-SVT Advisory Pop-Up on the MFD

Alert Type	PFD/MFD Alert Annunciation	Aural Message
GPS signal re-established	None	"Terrain System Available"
Terrain System Test Successful	None	"Terrain System test OK"
Terrain System Test in Progress	TER TEST	None
Terrain Alerting is disabled	TER INH	None
No GPS position Excessively degraded GPS signal	TER N/A	"Terrain System Not Available"
Terrain SVT System Test Fail	TER FAIL	"Terrain System Failure"

Table 4-3 Terrain-SVT System Test Status Annunciations

Alert Type	PFD/MFD Alert Annunciation	Aural Message
FLTA Terrain Caution (RTC-C, ITI-C)	TERRAIN	"Caution, Terrain, Terrain"
FLTA Terrain Warning (RTC-W, ITI-W)	TERRAIN	"Warning, Terrain, Terrain"
FLTA Obstacle Caution (ROC-C, IOI-C)	OBSTACLE	"Caution, Obstacle, Obstacle"
FLTA Obstacle Warning (ROC-W, IOI-W)	OBSTACLE	"Warning, Obstacle, Obstacle"

Table 4-4 Terrain-SVT Alerts Summary

4.6 TAS Traffic (Optional)

TAS refers to an active Traffic Advisory System that may be optionally displayed on the PFD and/or MFD. The TAS is installed separately from the G500 system. There are variations in performance and control among the various G500-compatible TAS systems. Refer to the appropriate TAS documentation for detailed information on the operation of the TAS system. This section describes the display and control functions available on the G500 system.



NOTE: *TIS and TAS are mutually exclusive.*



NOTE: *Aircraft without an operating transponder are invisible to both Traffic Advisory Systems (TAS) and TIS. Aircraft without altitude reporting capability are shown without altitude separation data or climb descent indication.*



NOTE: *Traffic is also displayed in the SVT feature on the PFD.*

4.6.1 Displaying and Operating Traffic (TAS Systems)

The Traffic Map Page shows surrounding TAS traffic data in relation to the aircraft's current position and altitude without basemap clutter. Aircraft orientation is always heading up unless no valid heading is received. The traffic mode and altitude display mode are annunciated in the upper left corner.

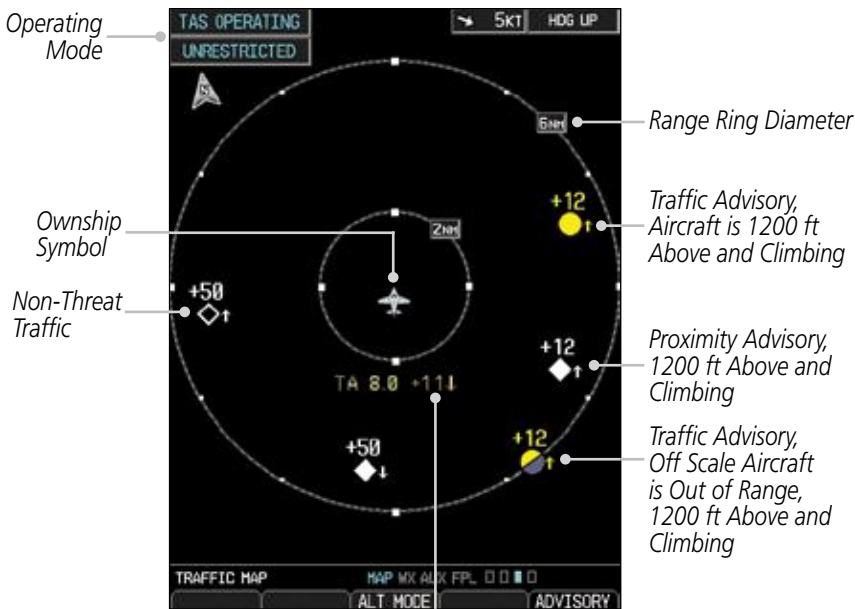

Non-Bearing Traffic (System is Unable to Determine Bearing), Aircraft Distance is 8.0 NM, 1100 ft Above and Descending

Figure 4-16 Traffic Map Page - TAS

4.6.1.1 Switching from Standby Mode to Operating Modes

The unit must be in operating mode for traffic to be displayed. The ability to switch from standby to operating mode on the ground is especially useful for scanning the airspace around the airport before takeoff.

- 1) While viewing the Traffic Page of the MAP page group, select the **OPERATE** soft key or press the **MENU** key and turn the small **MFD** knob to select Operating Mode.
- 2) To switch to Standby Mode from the Traffic Page, select the **STANDBY** soft key.



NOTE: Not all TAS systems can be controlled from the G500. The Operate/Standby soft keys may not be displayed. An alert will be generated when Standby is selected and the aircraft is in the air.

4.6.1.2 Range Ring

Pressing the **RNG** keys will zoom in and out in preset steps depending on the installed equipment.

4.6.2 Altitude Display

Changing the altitude display mode

- 1) Press the **ALT MODE** soft key to change the altitude volume.
- 2) Select the desired altitude volume by pressing the **BELOW**, **NORMAL**, **ABOVE**, or **UNREST** (unrestricted) soft keys. The selection is displayed in the Altitude mode field.

Altitude Mode	Displayed Traffic Range
Below	-9700 ft to 2700 ft
Normal	-2700 ft to 2700 ft
Above	-2700 ft to 9700 ft
Unrestricted	All Traffic Shown

Table 4-5 Displayed Traffic Range



NOTE: *Traffic Advisories (TAs) are always displayed, regardless of altitude mode.*

Foreword

System Sec 1

PFD Sec 2

MFD Sec 3

Sec 4
Hazard
Avoidance

Additional Features Sec 5

Annun. & Alerts Sec 6

Symbols Sec 7

Glossary Sec 8

Appendix A

Appendix B
Index

4.6.3 TAS Symbology

Traffic Advisory System (TAS) is designed to help in detection and avoidance of other aircraft. TAS uses an on-board interrogator-processor to detect traffic. Only aircraft with operating transponders will be detected. Traffic is displayed according to TCAS symbology using four different symbols.





TAS Symbol	Description
	Non-Threat Traffic (intruder is beyond 5 NM and greater than 1200 ft vertical separation)
	Proximity Advisory (PA) (intruder is within 5 NM and less than 1200 ft vertical separation)
	Traffic Advisory (TA) (closing rate, distance, and vertical separation meet TA criteria)
	Traffic Advisory Off Scale

Table 4-6 Traffic Symbol Description

A Non-Threat Advisory, shown as an open white diamond, indicates that an intruding aircraft is at greater than ± 1200 feet relative altitude or the distance is beyond five NM.

A Proximity Advisory indicates that the intruding aircraft is within ± 1200 feet and is within five NM range, but is still not considered a threat.

A Traffic Advisory (TA) alerts the crew to a potentially hazardous intruding aircraft. Closing rate, distance, and vertical separation meet TA criteria. A Traffic Advisory that is beyond the selected display range is indicated by a half TA symbol at the edge of the screen at the relative bearing of the intruder.

4.6.4 Traffic System Status



NOTE: Refer to the equipment documentation for information on the self-test and operating modes.

The traffic mode is indicated in the upper left corner of the Traffic Map Page.

Mode	Traffic Mode Annunciation (Traffic Map Page)	Traffic Display Enabled Icon (Other Maps)
TAS Self-test Initiated	TEST	
TAS Operating	OPERATING	
TAS Standby	STANDBY (also shown in white in center of page)	
TAS Failed*	FAIL	

Table 4-7 TAS Modes

If the unit fails, an annunciation as to the cause of the failure is shown in the center of the Traffic Map Page.

Traffic Map Page Annunciation	Description
NO DATA	Data is not being received from the TAS unit
DATA FAILED	Data is being received from the TAS unit, but the unit is self-reporting a failure
FAILED	Incorrect data format received from the TAS unit

Table 4-8 TAS Failure Annunciations

The annunciations to indicate the status of traffic information appear in a banner at the lower left corner of maps on which traffic can be displayed.

Traffic Status Banner Annunciation	Description
TA OFF SCALE*	A Traffic Advisory is outside the selected display range. Annunciation is removed when traffic comes within the selected display range.
TA X.X ± XX ↑**	System cannot determine bearing of Traffic Advisory. Annunciation indicates distance in NM, altitude separation in hundreds of feet, and altitude trend arrow (climbing/descending).
TRFC FAIL	TAS unit has failed (unit is self-reporting a failure or sending incorrectly formatted data).
NO TRFC DATA	Data is not being received from the TAS unit.

*Shown as symbol on Traffic Map Page

**Shown in center of Traffic Map Page

Table 4-9 TAS Traffic Status Annunciations

Foreword

Sec 1
System

Sec 2
PFD

Sec 3
MFD

Sec 4
Hazard
Avoidance

Sec 5
Additional
Features

Sec 6
Annun.
& Alerts

Sec 7
Symbols

Sec 8
Glossary

Appendix A

Appendix B
Index

4.6.5 Traffic Pop-Up

When the GDU 620 MFD is displaying any page (other than the NAV Traffic page) and a traffic alert becomes active, the Traffic Warning pop-up will be displayed.



NOTE: *The traffic pop-up will not appear when your aircraft is on the ground.*

Press **ENT** to go directly to the Traffic page.

OR

Press **CLR** to return to the previously viewed page.



Figure 4-17 Traffic Pop-Up

Foreword

Sec 1
System

Sec 2
PFD

Sec 3
MFD

Sec 4
Hazard
Avoidance

Sec 5
Additional
Features

Sec 6
Annun.
& Alerts

Sec 7
Symbols

Sec 8
Glossary

Appendix A

Appendix B
Index

4.7 TIS Traffic (Optional)

Foreword



WARNING: *The Traffic Information Service (TIS) is intended for advisory use only. TIS is intended to help the pilot locate traffic visually. It is the responsibility of the pilot to see and maneuver to avoid traffic.*

Sec 1
System



NOTE: *TIS is available only when the aircraft is within the service volume of a TIS-capable terminal radar site. Aircraft without an operating transponder are invisible to both Traffic Advisory Systems (TAS) and TIS. Aircraft without altitude reporting capability are shown without altitude separation data or climb descent indication.*

Sec 2
PFD

Sec 3
MFD



NOTE: *TIS and TAS are mutually exclusive.*



NOTE: *Traffic is also displayed in the SVT feature on the PFD.*

Sec 4
Hazard
Avoidance

The type of traffic systems that is installed is determined by the traffic page display in the upper left corner of the MFD.

Sec 5
Additional
Features

If Traffic Information Service (TIS) is configured, TIS will be displayed in the upper left corner of the MFD.

Sec 6
Annun.
& Alerts

Traffic Information Service (TIS) is designed to help in detection and avoidance of other aircraft. TIS uses the Mode S transponder for the traffic data link. TIS receives traffic information from ground stations, and is updated every five seconds. The GDU 620 displays up to eight traffic targets within a 7.5 NM radius, from 3000 feet below to 3500 feet above the requesting aircraft. Traffic is displayed according to TCAS symbology using three different symbols.

Sec 7
Symbols

Sec 8
Glossary

4.7.1 Traffic Map Page

The Traffic Map Page is configured to show surrounding TIS traffic data in relation to the aircraft's current position and altitude, without clutter from the basemap. Aircraft orientation on this map is always heading up unless there is no valid heading.

Appendix A

Appendix B
Index

The traffic mode is annunciated in the upper left corner of the Traffic Map Page. When the aircraft is on the ground, TIS automatically enters Standby Mode. Once the aircraft is airborne, TIS switches from Standby to Operating Mode and the GDU 620 begins to display traffic information.

Displaying traffic on the Traffic Map Page

- 1) Turn the large **MFD** knob to select the Map Page Group.
- 2) Turn the small **MFD** knob to select the Traffic Map Page.
- 3) Confirm TIS is in Operating Mode:
Select the **OPERATE** soft key to begin displaying traffic.

OR

- 1) Press the **MENU** key.
- 2) Select Operate Mode (shown if TIS is in Standby Mode) and then press the **ENT** key.

Operating Mode



Traffic Advisory, Aircraft is 1200 feet above, climbing, and moving away

Proximity Advisory, Aircraft is 5000 feet below, descending and moving away

Figure 4-18 Traffic Map Page - TIS

4.7.2 TIS Symbology





TIS Symbol	Description
	Non-Threat Traffic (intruder is beyond 5 NM and greater than 1200 ft vertical separation)
	Proximity Advisory (PA) (intruder is within 5 NM and less than 1200 ft vertical separation)
	Traffic Advisory (TA) (closing rate, distance, and vertical separation meet TA criteria)
	Traffic Advisory Off Scale

Table 4-10 TIS Traffic Symbols

A Non-threat Advisory, shown as an open white diamond, indicates that an intruding aircraft is at greater than ± 1200 feet relative altitude or the distance is beyond five NM.

A Traffic Advisory (TA) alerts the crew to a potentially hazardous intruding aircraft. Closing rate, distance, and vertical separation meet TA criteria. A Traffic Advisory that is beyond the selected display range is indicated by a half TA symbol at the edge of the screen at the relative bearing of the intruder.

TIS also provides a vector line showing the direction in which the traffic is moving, to the nearest 45° . Traffic information for which TIS is unable to determine the bearing (non-bearing traffic) is displayed in the center of the Traffic Map Page or in a banner at the lower left corner of maps other than the Traffic Map Page on which traffic can be displayed.

The altitude difference between the requesting aircraft and other intruder aircraft is displayed above/below the traffic symbol in hundreds of feet. If the other aircraft is above the requesting aircraft, the altitude separation appears above the traffic symbol; if below, the altitude separation appears below. Altitude trend is displayed as an up/down arrow (for speeds greater than 500 fpm in either direction) to the right of the target symbol. Traffic symbols for aircraft without altitude reporting capability appear without altitude separation or climb/descent information.

Foreword
 Sec 1 System
 Sec 2 PFD
 Sec 3 MFD
 Sec 4 Hazard Avoidance
 Sec 5 Additional Features
 Sec 6 Annun. & Alerts
 Sec 7 Symbols
 Sec 8 Glossary
 Appendix A
 Appendix B Index

4.7.3 TIS Limitations



NOTE: *This section on TIS Limitations is not comprehensive. Garmin recommends the user review the TIS Limitations section of the Aeronautical Information Manual, Section 1-3-5.*

TIS is NOT intended to be used as a collision avoidance system and does not relieve the pilot of responsibility to “see and avoid” other aircraft. TIS should not be used for avoidance maneuvers during IMC or other times when there is no visual contact with the intruder aircraft. TIS is intended only to assist in visual acquisition of other aircraft in VMC. No recommended avoidance maneuvers are provided for, nor authorized, as a direct result of a TIS intruder display or TIS advisory.

While TIS is a useful aid to visual traffic avoidance, it has some system limitations that must be fully understood to ensure proper use. Many of these limitations are inherent in secondary radar surveillance. In other words, the information provided by TIS will be no better than that provided to ATC. TIS will only display aircraft with operating transponders installed.

TIS relies on surveillance of the Mode S radar, which is a “secondary surveillance” radar similar to the ATCRBS. TIS operation may be intermittent during turns or other maneuvering. TIS is dependent on two-way, “line-of-sight” communication between the aircraft and the Mode S radar. Whenever the structure of the client aircraft comes between the transponder antenna (usually located on the underside of the aircraft) and the ground-based radar antenna, the signal may be temporarily interrupted. Other limitations and anomalies associated with TIS are described in the AIM, Section 1-3-5.

Foreword
Sec 1 System
Sec 2 PFD
Sec 3 MFD
Sec 4 Hazard Avoidance
Sec 5 Additional Features
Sec 6 Annun. & Alerts
Sec 7 Symbols
Sec 8 Glossary
Appendix A
Appendix B Index



Garmin is not responsible for Mode S geographical coverage. Operation of the ground stations is the responsibility of the FAA. Refer to the Aeronautical Information Manual for a Terminal Mode S Radar Site Map covering the U.S.



NOTE: TIS will be unavailable at low altitudes in many areas of the U.S., particularly in mountainous regions. Also, when flying near the “floor” of radar coverage in a particular area, intruders below the client aircraft may not be detected by TIS.

TIS information is collected one radar scan prior to the scan during which the uplink occurs. Therefore, the surveillance information is approximately five seconds old. In order to present the intruders in a “real time” position, the TIS ground station uses a “predictive algorithm” in its tracking software. This algorithm uses track history data to extrapolate intruders to their expected positions consistent with the time of display in the cockpit. Occasionally, aircraft maneuvering will cause this algorithm to induce errors in the display. These errors primarily affect relative bearing information and traffic target track vector (it will lag); intruder distance and altitude will remain relatively accurate and may be used to assist in “see and avoid.” Some of the more common examples of these errors follow:

- When client or intruder aircraft maneuvers excessively or abruptly, the tracking algorithm may report incorrect horizontal position until the maneuvering aircraft stabilizes.
- When a rapidly closing intruder is on a course that crosses the client aircraft course at a shallow angle (either overtaking or head on) and either aircraft abruptly changes course within 0.25 NM, TIS may display the intruder on the opposite side of the client than it actually is.

These are relatively rare occurrences and will be corrected in a few radar scans once the course has stabilized.

Sec 1 System Foreword

Sec 2 PFD

Sec 3 MFD

Sec 4 Hazard Avoidance

Sec 5 Additional Features

Sec 6 Annun. & Alerts

Sec 7 Symbols

Sec 8 Glossary

Appendix A

Appendix B Index

4.7.4 TIS Alerts

When the number of Traffic Advisories (TAs) on the Traffic Map Page increases from one scan to the next, the following occur:

- A single “Traffic” voice alert is generated.
- A TRAFFIC Annunciation appears to the top left of the Attitude Indicator on the PFD, flashing for 5 seconds and remaining displayed until no TAs are detected in the area.

To reduce the number of nuisance alerts due to proximate aircraft, the “Traffic” voice alert is generated only when the number of TAs increases. For example, when the first TA is displayed, a voice and visual annunciation are generated. As long as a single TA remains on the display, no additional voice alerts are generated. If a second TA appears on the display or if the number of TAs initially decreases and then subsequently increases, another voice alert is generated.

A “Traffic Not Available” (TNA) voice alert is generated when the TIS service becomes unavailable or is out of range.

Traffic may not be displayed in the radar coverage area due to the following:

- Radar site TIS Mode S sensor is not operational or is out of service.
- Traffic or requesting aircraft is beyond the maximum range of the TIS-capable Mode S radar site.
- Traffic or requesting aircraft is above the radar site in the cone of silence and out of range of an adjacent site.
- Traffic or requesting aircraft is below radar coverage. In flat terrain, the coverage extends from about 3000 feet upward at 55 miles. Terrain and obstacles around the radar site can further decrease radar coverage in all directions.
- Traffic does not have an operating transponder.

4.7.5 Traffic Pop-Up

When the GDU 620 MFD is displaying any page (other than the NAV Traffic page) and a traffic alert becomes active, the Traffic Warning pop-up will be displayed.



NOTE: The traffic pop-up will not appear when your aircraft is on the ground.

Press **ENT** to go directly to the Traffic page.

OR

Press **CLR** to return to the previously viewed page.



Figure 4-19 Traffic Pop-Up

4.7.6 TIS System Status

The GDU 620 performs an automatic test of TIS during power-up. If TIS passes the test, TIS enters Standby Mode on the ground or Operating Mode in the air. If TIS fails the power up test, an annunciation is shown in the center of the Traffic Map Page.



NOTE: An alert will be generated when Standby is selected and the aircraft is in the air.

Traffic Map Page Annunciation	Description
NO DATA*	Data is not being received from the transponder
DATA FAILED*	Data is being received from the transponder, but a failure is detected in the data stream
FAILED*	The transponder has failed
UNAVAILABLE	TIS is unavailable or out of range

* Contact a service center or Garmin dealer for corrective action

Table 4-11 TIS Failure Annunciations

The traffic mode is annunciated in the upper left corner of the Traffic Map Page. When the aircraft is on the ground, TIS automatically enters Standby Mode. If traffic is selected for display on another map while Standby Mode is selected, the traffic display enabled icon is crossed out (also the case when TIS has failed). Once the aircraft is airborne, TIS switches to Operating Mode and traffic information is displayed. The mode can be changed manually using soft keys or the page menu.



Mode	Traffic Mode Annunciation (Traffic Map Page)	Traffic Display Enabled Icon (Other Maps)
TIS Operating	OPERATING	
TIS Standby	STANDBY (Also shown in white in center of page)	
TIS Failed*	FAIL	

Table 4-12 TIS Modes

Switching Between TIS Operating Modes

- 1) Turn the large **MFD** knob to the MAP page group and then turn the small **MFD** knob to the Traffic Map Page.
- 2) Select the **STANDBY** or **OPERATE** soft key to switch between modes. The mode is displayed in the upper left corner of the Traffic Map Page.

OR

- 1) Press the **MENU** key.
- 2) Select Operate mode or Standby mode whether airborne or on the ground.
- 3) Press the **ENT** key.

The annunciations indicate the status of traffic information appear in a banner at the lower left corner of maps on which traffic can be displayed.

Traffic Status Banner Annunciation	Description
TA OFF SCALE*	A Traffic Advisory is outside the selected display range Annunciation is removed when traffic comes within the selected display range
TA X.X ± XX ↓**	System cannot determine bearing of Traffic Advisory Annunciation indicates distance in NM, altitude separation in hundreds of feet, and altitude trend arrow (climbing/ descending)
AGE MM:SS	Appears if traffic data is not refreshed within 6 seconds If after another 6 seconds data is not received, traffic is removed from the display The quality of displayed traffic information is reduced as the age increases
TRFC COAST	The displayed data is not current (6 to 12 seconds since last message) The quality of displayed traffic information is reduced when this message is displayed
TRFC RMVD	Traffic is removed because it is too old for coasting (12 to 60 seconds since last message) Traffic may exist within the selected display range, but it is not displayed
TRFC FAIL	Traffic data has failed
NO TRFC DATA	Traffic has not been detected
TRFC UNAVAIL	The traffic service is unavailable or out of range

*Shown as symbol on Traffic Map Page

**Shown in center of Traffic Map Page

Table 4-13 TIS Traffic Status Annunciations

4.8 XM WX Satellite Weather (Optional)

The primary map for viewing XM WX Satellite Weather data are the Weather Data Link Pages in the Map Page Group. These are the only GDU 620 map displays capable of all available XM WX Satellite Weather products. The XM WX Satellite Weather pages may be oriented to either Track Up or North Up.

4.8.1 Using XM Satellite Weather Products

When a weather product is active on the Weather Data Link Page or the Navigation Map Page, the age of the data is displayed on the screen. The age of the product is based on the time difference between when the data was assembled on the ground and the current GPS time. Weather products are refreshed at specific intervals (defined in the Refresh Rate column).

If a weather product is not received within the 30, 60, 90, or 120 minute Expiration Time intervals, the data is considered expired and is removed from the display. This ensures that the displayed data is consistent with what is currently being broadcast by XM WX Satellite Radio services. If more than half of the expiration time has elapsed from the time the data is received, the color of the product age displayed changes to yellow.

4.8.2 Customizing the XM WX Satellite Weather Map

Each Wx Data Link Map page may be customized individually. The Wx Data Link Map pages are customized by selecting options from the Page Menu. The Page Menu options include choices for Weather Setup and displaying the Weather Legends. The Weather Setup choice covers selections for adjusting the viewing ranges of the weather products.

- 1) While viewing a WX Data Link Map page of the WX page group, press the **MENU** key to display the Page Menu Options. The cursor flashes on the "Weather Setup" option. Press **ENT**.



Figure 4-20 Weather Page Menu Options

- 2) With the Data Link Setup Menu displayed, turn the Large **MFD** knob to select the desired item and press **ENT**.



Figure 4-21 Weather Data Link Setup Menu Options

- 3) Turn the small **MFD** knob to select the desired weather feature option.

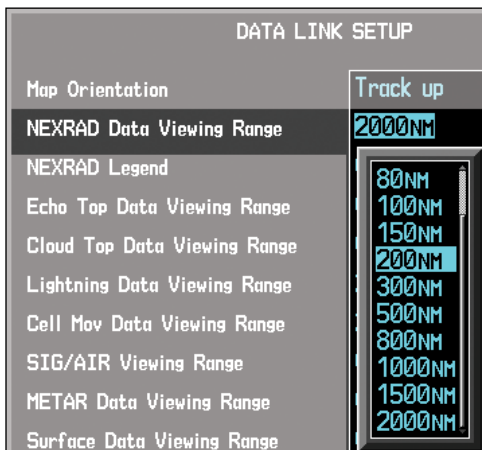

Figure 4-22 Weather Data Link Setup Menu Option Selection

- 4) Press **ENT** to save a selection.
- 5) Turn the large **MFD** knob to the next desired option or press the small **MFD** knob to cancel and return to the XM WX Satellite Weather Data Link Map Page.

WX Page Menu - Weather Setup	
Menu Item	Adjustment
Map Orientation	North Up, Track Up
NEXRAD Data Viewing Range	Off, 50 NM to 2000 NM
NEXRAD Legend	On/Off
Echo Top Data Viewing Range	Off, 50 NM to 2000 NM
Cloud Top Data Viewing Range	Off, 50 NM to 2000 NM
Lightning Data Viewing Range	Off, 50 NM to 2000 NM
Cell Mov Data Viewing Range	Off, 50 NM to 2000 NM
SIG/Air Viewing Range	Off, 50 NM to 2000 NM
METAR Data Viewing Range	Off, 50 NM to 2000 NM
Surface Data Viewing Range	Off, 50 NM to 2000 NM
Surface Data Time	Current, 12 Hr, 24 Hr, 36 Hr, and 48 Hr
Frz Lvl Data Viewing Range	Off, 50 NM to 2000 NM
Wnd Aloft Data Viewing Range	Off, 50 NM to 2000 NM
Wnd Aloft Altitude	Surface, 3000 feet to 42000 feet
County Data Viewing Range	Off, 50 NM to 2000 NM
Cyclone Data Viewing Range	Off, 50 NM to 2000 NM

Table 4-14 Weather Page Menu Setup Options

4.8.3 XM WX Weather Symbols and Product Age

The weather product symbols, the expiration time and the broadcast rate are shown in the following table. The broadcast rate represents the interval at which XM WX Satellite Radio broadcasts new signals that may or may not contain new weather data. It does not represent the rate at which weather data is updated or new content is received by the Data Link Receiver. Weather data is updated at intervals that are defined and controlled by XM WX Satellite Radio and its data vendors.



WARNING: Do not use data link weather information for maneuvering in, near, or around areas of hazardous weather. Information contained within data link weather products may not accurately depict current weather conditions.

Foreword

Sec 1
System

Sec 2
PFD

Sec 3
MFD

Sec 4
Hazard
Avoidance

Sec 5
Additional
Features

Sec 6
Annun.
& Alerts

Sec 7
Symbols

Sec 8
Glossary

Appendix A

Appendix B
Index



WARNING: Do not use the indicated data link weather product age to determine the age of the weather information shown by the data link weather product. Due to time delays inherent in gathering and processing weather data for data link transmission, the weather information shown by the data link weather product may be significantly older than the indicated weather product age.













Symbol	Weather Product	Expiration Time (Minutes)	Broadcast Rate (Minutes)
	NEXRAD (NEXRAD and Echo Top are Mutually Exclusive)	30	5
	Echo Top (Cloud Top and Echo Top Mutually Exclusive) (NEXRAD and Echo Top Mutually Exclusive)	30	7.5
	Cloud Top (Cloud Top and Echo Top Mutually Exclusive)	60	15
	XM Lightning	30	5
	Cell Movement	30	1.25
	SIGMETs / AIRMETs	60	12
	METARs	90	12
	City Forecast	90	12
	Surface Analysis	60	12
	Freezing Levels	120	12
	Winds Aloft	90	12
	County Warnings	60	5
	Cyclone Warnings	60	12

Table 4-15 Weather Product Symbols and Data Timing



NOTE: Product age for individual reports of XM AIRMETs, SIGMETs, City Forecasts, County Warnings, Cell Movement and TFRs are not provided by XM Weather Service.

Product age indication for XM Icing Potential and Turbulence is not included on the weather map. The valid time for these products is displayed on the weather map in place of the generation time.

The valid time indication for XM Freezing Level, Winds Aloft and Canada Winds Aloft is not displayed. Instead, the generation time for these is displayed.

Symbol	Description
	Flood
	Severe Thunderstorm
	Tornado
	Sunny
	Part Sun
	Cloudy
	Rainy
	T-Storm
	Snow
	Windy
	Foggy
	Haze
	High/Low Temp

Table 4-16 Weather Symbols

Foreword

Sec 1
System

Sec 2
PFD

Sec 3
MFD

Sec 4
Hazard
Avoidance

Sec 5
Additional
Features

Sec 6
Annun.
& Alerts

Sec 7
Symbols

Sec 8
Glossary

Appendix A

Appendix B
Index

4.8.4 Weather Legends

The **LEGEND** soft key displays a pop-up legend of the currently used weather products. Pressing the **LEGEND** soft key again, the **MFD** knob, the **ENT**, or **CLR** keys will remove the legend.

- 1) A full page legend can be selected by selecting the Weather Legend option in the XM Weather Map Menu or pressing the **LEGEND** soft key on the Weather Map Page. The legend displayed will match the selected weather products. Turn the large or small **MFD** knobs to scroll through the legend, if necessary.

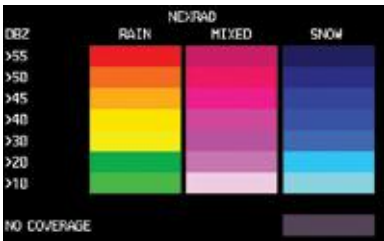
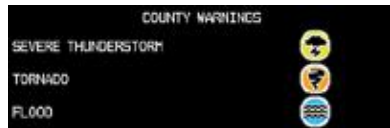
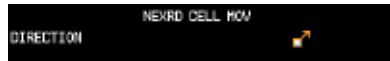
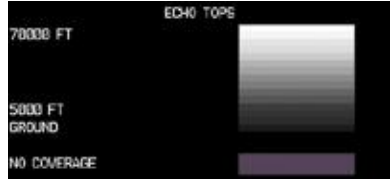
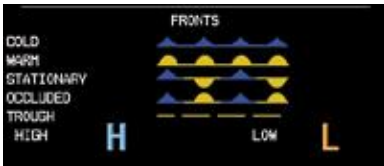

Figure 4-23 Weather Legends

Foreword
 Sec 1 System
 Sec 2 PFD
 Sec 3 MFD
 Sec 4 Hazard Avoidance
 Sec 5 Additional Features
 Sec 6 Annun. & Alerts
 Sec 7 Symbols
 Sec 8 Glossary
 Appendix A
 Appendix B Index

- 2) An abbreviated legend may be displayed on the upper right side of a WX Data Link Map page for the applicable weather products when selected in the Page Menu options for Weather.

Foreword

Sec 1
System

Sec 2
PFD

Sec 3
MFD

Sec 4
Hazard
Avoidance

Sec 5
Additional
Features

Sec 6
Annun.
& Alerts

Sec 7
Symbols

Sec 8
Glossary

Appendix A

Appendix B
Index

4.8.5 NEXRAD

WSR-88D, or NEXRAD (NEXt-generation RADar), is a network of 158 high-resolution Doppler radar systems that are operated by the National Weather Service (NWS). NEXRAD data provides centralized meteorological information for the continental United States and selected overseas locations. The maximum range of a single NEXRAD radar site is 250 NM. The NEXRAD network provides important information about severe weather for air traffic safety.

NEXRAD data is not real-time. The lapsed time between collection, processing, and dissemination of NEXRAD images can be significant and may not reflect the current radar synopsis. Due to the inherent delays and the relative age of the data, it should be used for long-range planning purposes only. Never use NEXRAD data or any radar data to penetrate hazardous weather. Instead, use it in an early-warning capacity of pre-departure and en route evaluation.



Figure 4-24 XM Weather - NEXRAD

Composite data from all the NEXRAD radar sites in the United States is shown. This data is composed of the maximum reflectivity from the individual radar sweeps. The display of the information is color-coded to indicate the weather severity level. All weather product legends can be viewed on the Weather Data

Link Page. For the NEXRAD legend, select the **LEGEND** soft key when NEXRAD is selected for display.

Foreword

Sec 1
System

Sec 2
PFD

Sec 3
MFD

**Sec 4
Hazard
Avoidance**



Figure 4-25 NEXRAD Weather Legend

The display of radar coverage is always active when either NEXRAD or ECHO TOPS is selected. Areas where NEXRAD radar coverage and Echo Tops information is not currently available or is not being collected are indicated in grayish-purple.

Sec 5
Additional
Features

Sec 6
Annun.
& Alerts

4.8.5.1 Reflectivity

Reflectivity is the amount of transmitted power returned to the radar receiver. Colors on the NEXRAD display directly correlate to the level of detected reflectivity. Reflectivity as it relates to hazardous weather can be very complex.

Sec 7
Symbols

The role of radar is essentially to detect moisture in the atmosphere. Simply put, certain types of weather reflect radar better than others. The intensity of a radar reflection is not necessarily an indication of the weather hazard level. For instance, wet hail returns a strong radar reflection, while dry hail does not. Both wet and dry hail can be extremely hazardous.

Sec 8
Glossary

Appendix A

The different NEXRAD echo intensities are measured in decibels (dB) relative to reflectivity (Z). NEXRAD measures the radar reflectivity ratio, or the energy reflected back to the radar receiver (designated by the letter Z). The value of Z increases as the returned signal strength increases.

Appendix B
Index

4.8.5.2 NEXRAD Limitations

NEXRAD radar images may have certain limitations:

- NEXRAD composite reflectivity does not provide sufficient information to determine cloud layers or precipitation characteristics. For example, it is not possible to distinguish between wet snow, wet hail, and rain.
- NEXRAD composite reflectivity is sampled at the minimum antenna elevation angle. An individual NEXRAD site cannot depict high altitude storms at close ranges. It has no information about storms directly over the site.
- When zoomed in to a range of 30 NM, each square block on the display represents an area of four square kilometers. The intensity level reflected by each square represents the highest level of NEXRAD data sampled within the area.

The following may cause abnormalities in displayed NEXRAD radar images:

- Ground clutter
- Strokes and spurious radar data
- Sun strokes (when the radar antenna points directly at the sun)
- Interference from buildings or mountains, which may cause shadows
- Metallic dust from military aircraft, which can cause alterations in radar scans

Foreword

Sec 1
System

Sec 2
PFD

Sec 3
MFD

Sec 4
Hazard
Avoidance

Sec 5
Additional
Features

Sec 6
Annun.
& Alerts

Sec 7
Symbols

Sec 8
Glossary

Appendix A

Appendix B
Index

4.8.6 Weather Page Map Orientation

The Orientation option sets the orientation of the Wx Data Link Map pages.

- 1) While viewing the Wx Data Link Map 1, 2, or 3 of the Wx page group, press the **MENU** key. With "Weather Setup" highlighted, press **ENT**.
- 2) With the "Map Orientation" option active, turn the small **MFD** knob to change the highlighted value.



Figure 4-26 Weather Page Map Orientation

- 3) Press **ENT** to accept the displayed value. The next option will be highlighted.
- 4) Press the small **MFD** knob to cancel selection or to end editing and return to the Navigation Map page or turn the large **MFD** knob to the next option.

4.8.7 NEXRAD Data Viewing Range

The NEXRAD Viewing Range option allows you to select the map range where at and below the selected value NEXRAD weather products will be shown on the selected MFD Wx Data Link Map page (1, 2, or 3). When Off is selected, NEXRAD weather data will not be shown. In the figure below where 300 NM is selected, NEXRAD data will be shown at map ranges of 300 NM and lower.



Figure 4-27 NEXRAD Viewing Range Selection

- 1) While viewing a WX Data Link Map page of the WX page group, press the **MENU** key to display the Page Menu Options. The cursor flashes on the "Weather Setup" option. Press **ENT**.

- 2) The NEXRAD Data Viewing Range value will be highlighted. Turn the small **MFD** knob to highlight the desired value.
- 3) Press **ENT** to accept the displayed value. The next option will be highlighted.
- 4) Press the small **MFD** knob to cancel selection or to end editing and return to the Navigation Map page or turn the large **MFD** knob to the next option.

Foreword

System
Sec 1

4.8.8 NEXRAD Legend

The NEXRAD Legend selection provides the option of displaying an abbreviated version of the NEXRAD legend in the top right region of the MFD. The full legend is available by pressing the **LEGEND** soft key.

Sec 2

MFD
Sec 3



Sec 4
Hazard
Avoidance

Figure 4-28 NEXRAD Legend Selection

Sec 5
Additional
Features

- 1) While viewing a WX Data Link Map page of the WX page group, press the **MENU** key to display the Page Menu Options. The cursor flashes on the "Weather Setup" option. Press **ENT**.
- 2) Turn the large **MFD** knob to highlight the NEXRAD Legend value.
- 3) Turn the small **MFD** knob to highlight Off or On. Press **ENT** to accept the displayed value. The next option will be highlighted.
- 4) Press the small **MFD** knob to cancel selection or to end editing and return to the Navigation Map page or turn the large **MFD** knob to the next option.

Sec 6
Annun.
& Alerts

Sec 7
Symbols

Sec 8
Glossary

Appendix A

Appendix B
Index

4.8.9 Echo Tops



NOTE: Due to similarities in color schemes, the display of Echo Tops is mutually exclusive with Cloud Tops and NEXRAD.

Echo Tops data shows the location, elevation, and direction of the highest radar echo. The highest radar echo does not indicate the top of a storm or clouds; rather it indicates the highest altitude at which precipitation is detected. Information is derived from NEXRAD data.

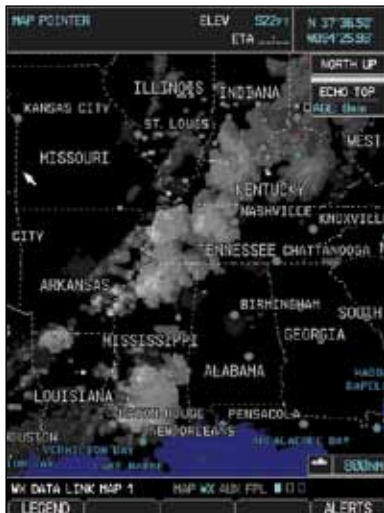

Figure 4-29 XM Weather - Echo Tops

The display of radar coverage is always active when either NEXRAD or ECHO TOPS is selected. Areas where NEXRAD radar coverage and Echo Tops information is not currently available or is not being collected are indicated in grayish-purple. Radar capability exists in these areas, but it is not active or is off-line.

Foreword

Sec 1 System

Sec 2 PFD

Sec 3 MFD

Sec 4 Hazard Avoidance

Sec 5 Additional Features

Sec 6 Annun. & Alerts

Sec 7 Symbols

Sec 8 Glossary

Appendix A

Appendix B Index

Echo Top Data Viewing Range

The Echo Top Data Viewing Range option allows you to select the map range where at and below that value Echo Top weather products will be shown on the selected MFD Wx Data Link Map page (1, 2, or 3). When Off is selected, Echo Tops will not be shown. In the figure below where 200 NM is selected, Echo Top data will be shown at map ranges of 200 NM and lower.



Figure 4-30 Echo Top Viewing Range Selection

- 1) While viewing a WX Data Link Map page of the WX page group, press the **MENU** key to display the Page Menu Options. The cursor flashes on the "Weather Setup" option. Press **ENT**.
- 2) Turn the large **MFD** knob to highlight the Echo Top Data Viewing Range value.
- 3) Turn the small **MFD** knob to highlight the desired value. Press **ENT** to accept the displayed value. The next option will be highlighted.
- 4) Press the small **MFD** knob to cancel selection or to end editing and return to the Navigation Map page or turn the large **MFD** knob to the next option.

Cloud Top Data Viewing Range

The Cloud Top Data Viewing Range option allows you to select the map range where at and below that value Cloud Top weather products will be shown on the selected MFD Wx Data Link Map page (1, 2, or 3). When Off is selected, Cloud Tops will not be shown. In the figure below where 150 NM is selected, Cloud Top data will be shown at map ranges of 150 NM and lower.



Figure 4-32 Cloud Top Viewing Range Selection

4.8.11 XM WX Satellite Lightning

Lightning data shows the approximate location of cloud-to-ground lightning strikes. A strike icon represents a strike that has occurred within a two-kilometer region. The exact location of the lightning strike is not displayed.



Figure 4-33 XM Weather - Lightning



Figure 4-34
Lightning Viewing Range Selection

Lightning Data Viewing Range

The Lightning Data Viewing Range option allows you to select the map range where at and below that value Lightning weather products will be shown on the selected MFD Wx Data Link Map page (1, 2, or 3). When Off is selected, Lightning will not be shown. In the figure above where 300 NM is selected, NEXRAD data will be shown at map ranges of 300 NM and lower.

4.8.12 Cell Movement

Cell Movement data shows the location and movement of storm cells as identified by a ground-based system. Cells are represented by yellow squares, with direction of movement indicated with short, orange arrows.



Figure 4-35 XM Weather - Cell Movement

On most applicable maps, Cell Movement data is selected for display along with NEXRAD. On the Weather Data Link Page, Cell Movement data can be selected independently.

Foreword

Sec 1
System

Sec 2
PFD

Sec 3
MFD

Sec 4
Hazard
Avoidance

Sec 5
Additional
Features

Sec 6
Annun.
& Alerts

Sec 7
Symbols

Sec 8
Glossary

Appendix A

Appendix B
Index

Cell Movement Data Viewing Range

The Cell Movement Data Viewing Range option allows you to select the map range and below where Cell Movement weather products will appear on the selected MFD Wx Data Link Map page (1, 2, or 3). When Off is selected, Cell Movement will not be shown. In the figure below where 300 NM is selected, Cell Movement data will be shown at map ranges of 300 NM and lower.



Figure 4-36 Cell Movement Viewing Range Selection

Foreword

Sec 1 System

Sec 2 PFD

Sec 3 MFD

Sec 4 Hazard Avoidance

Sec 5 Additional Features

Sec 6 Annun. & Alerts

Sec 7 Symbols

Sec 8 Glossary

Appendix A

Appendix B Index

4.8.13 SIGMETs and AIRMETS

SIGMETs (SIGNificant METeorological Information) and AIRMETS (AIRMen's METeorological Information) are broadcast for potentially hazardous weather considered of importance to aircraft. A Convective SIGMET is issued for hazardous convective weather. A localized SIGMET is a significant weather condition occurring at a localized geographical position.

When enabled, SIGMET/AIRMETS advise the pilot of potentially hazardous weather to all aircraft. SIGMET/AIRMET data covers icing, turbulence, dust, and volcanic ash as issued by the National Weather Service. The update rate is every 12 minutes.



Figure 4-37 XM Weather - AIRMETS

When enabled, the following AIRMETS are available for display:

- Icing
- Turbulence
- IFR conditions
- Mountain obscuration
- Surface winds

Foreword

System Sec 1

PFD Sec 2

MFD Sec 3

Sec 4
Hazard Avoidance

Sec 5
Additional Features

Sec 6
Annun. & Alerts

Sec 7
Symbols

Sec 8
Glossary

Appendix A

Appendix B
Index

SIGMET/AIRMET Viewing Range

The SIGMET/AIRMET Viewing Range option allows you to select the map range where at and below that value SIGMET/AIRMET products will be shown on the selected MFD Wx Data Link Map page (1, 2, or 3). When Off is selected, SIGMET/AIRMET will not be shown. In the figure below where 300 NM is selected, SIGMET/AIRMET data will be shown at map ranges of 300 NM and lower.



Figure 4-38 SIGMET/AIRMET Viewing Range Selection

Foreword

Sec 1
System

Sec 2
PFD

Sec 3
MFD

**Sec 4
Hazard
Avoidance**

Sec 5
Additional
Features

Sec 6
Annun.
& Alerts

Sec 7
Symbols

Sec 8
Glossary

Appendix A

Appendix B
Index

METAR Viewing Range

The METAR Viewing Range option allows you to select the map range where at and below that value METAR weather products will be shown on the selected MFD Wx Data Link Map page (1, 2, or 3). When Off is selected, METARs will not be shown. In the figure below where 150 NM is selected, METAR data will be shown at map ranges of 150 NM and lower.



Figure 4-40 METAR Viewing Range Selection

Foreword
 Sec 1 System
 Sec 2 PFD
 Sec 3 MFD
Sec 4 Hazard Avoidance
 Sec 5 Additional Features
 Sec 6 Annun. & Alerts
 Sec 7 Symbols
 Sec 8 Glossary
 Appendix A
 Appendix B Index

4.8.15 Surface Analysis and City Forecast



NOTE: Surface Analysis and City Forecast data are displayed only within the installed Aviation Database service area.

Surface Analysis and City Forecast information is available for current and forecast weather conditions. Forecasts are available for intervals of 12, 24, 36, and 48 hours by pressing the **SRFC TIME** soft key or in the Page Menu Weather Setup options.

When enabled, the Surface Analysis forecast shows frontal lines indicating weather fronts and the direction they are moving. High and Low pressure centers are noted with a large H or L. The Forecast Time menu item will step through the intervals manually.



Figure 4-41 XM Weather - Surface Analysis and City Forecast

A Cold Front is a front where cold air replaces warm air. A blue line with blue triangles that point in the direction of the cold air flow.



Figure 4-42 XM Weather - Cold Front

A Warm Front is where warm air replaces cold air. An orange line with orange half moons that point in the direction of the warm air flow.



Figure 4-43 XM Weather - Warm Front

A Stationary Front is a front with very little horizontal movement. The line alternates with orange and blue sections which point in opposite directions to symbolize little movement.



Figure 4-44 XM Weather - Stationary Front

An Occluded Front is where a cold front has overtaken and merged with a warm front. The line alternates with the blue triangle and orange half moon symbols on the same side of the line pointing in the direction the front is moving.



Figure 4-45 XM Weather - Occluded Front

Surface Data Viewing Range

The Surface Data Viewing Range option allows you to select the map range where at and below that value Surface Data weather products will be shown on the selected MFD Wx Data Link Map page (1, 2, or 3). When Off is selected, Surface Data will not be shown. In the figure below where 150 NM is selected, Surface data will be shown at map ranges of 150 NM and lower.



Figure 4-46 Surface data Viewing Range Selection

Surface Data Time

The Surface Data Time option allows you to select the forecast time when the Surface and City Forecast weather products will appear on the selected MFD Wx Data Link Map page (1, 2, or 3). Forecasts are available for intervals of current, 12, 24, 36, and 48 hours. You may also select an interval by pressing the **SRFC TIME** soft key on the Wx Data Link Map page.



Figure 4-47 Surface Data Time Selection

4.8.16 Freezing Level

Freezing Level data shows the color-coded contour lines for the altitude and location at which the Freezing Level is found. When no data is displayed for a given altitude, the data for that altitude has not been received, or is out of date and has been removed from the display. New data appears at the next update.



Figure 4-48 XM Weather - Freezing Levels

Foreword

Sec 1
System

Sec 2
PFD

Sec 3
MFD

Sec 4
Hazard
Avoidance

Sec 5
Additional
Features

Sec 6
Annun.
& Alerts

Sec 7
Symbols

Sec 8
Glossary

Appendix A

Appendix B
Index

Freezing Level Viewing Range

The Freezing Level Viewing Range option allows you to select the map range where at and below that value Freezing Level weather products will be shown on the selected MFD Wx Data Link Map page (1, 2, or 3). When Off is selected, Freezing Level Data will not be shown. In the figure below where 200 NM is selected, Freezing Level data will be shown at map ranges of 200 NM and lower.



Figure 4-49 Freezing Level Viewing Range Selection

4.8.17 Winds Aloft

Winds Aloft data shows the forecast wind speed and direction at the surface and at selected altitudes. Altitudes can be selected in 3000 foot increments from the surface up to 42,000 feet MSL. Pressing the **WIND DOWN** or **WIND UP** soft keys steps down or up in 3,000 foot increments.



Figure 4-50 XM Weather - Winds Aloft



Figure 4-51 XM Weather - Winds Aloft Legend

Foreword

Sec 1 System

Sec 2 PFD

Sec 3 MFD

Sec 4 Hazard Avoidance

Sec 5 Additional Features

Sec 6 Annun. & Alerts

Sec 7 Symbols

Sec 8 Glossary

Appendix A

Appendix B Index

Winds Aloft Data Viewing Range

The Winds Aloft Data Viewing Range option allows you to select the map range where at and below that value Winds Aloft weather products will appear on the selected MFD Wx Data Link Map page (1, 2, or 3). When Off is selected, Winds Aloft will not be shown. In the figure below where 150 NM is selected, Winds Aloft data will be shown at map ranges of 150 NM and lower.



Figure 4-52 Winds Aloft Data Viewing Range Selection

Winds Aloft Altitude

The Winds Aloft Altitude option allows you to select the altitude where at and below that value Winds Aloft weather products will be shown on the selected MFD Wx Data Link Map page (1, 2, or 3). Altitude can be selected in 3000 foot increments from the surface up to 42,000 feet MSL.

Pressing the **WIND DOWN** or **WIND UP** soft keys steps down or up in the 3,000 foot increments. In the figure below where 6000 feet is selected, Winds Aloft data will be shown at 6000 feet and lower.



Figure 4-53 Winds Aloft Altitude Selection

Foreword

Sec 1 System

Sec 2 PFD

Sec 3 MFD

Sec 4 Hazard Avoidance

Sec 5 Additional Features

Sec 6 Annun. & Alerts

Sec 7 Symbols

Sec 8 Glossary

Appendix A

Appendix B Index

4.8.18 County Warnings

County data provides specific public awareness and protection weather warnings from the National Weather Service (NWS). This can include information on fires, tornadoes, severe thunderstorms, flood conditions, and other natural disasters.

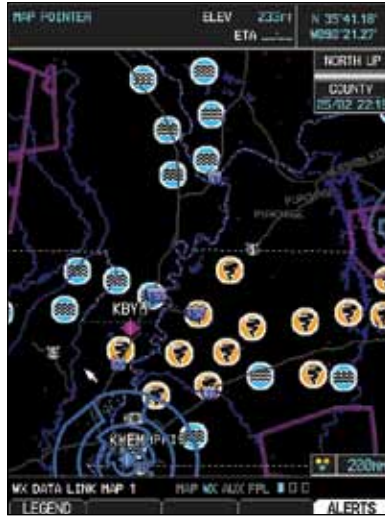

Figure 4-54 XM Weather - County Warnings

Foreword

Sec 1
System

Sec 2
PFD

Sec 3
MFD

**Sec 4
Hazard
Avoidance**

Sec 5
Additional
Features

Sec 6
Annun.
& Alerts

Sec 7
Symbols

Sec 8
Glossary

Appendix A

Appendix B
Index

County Data Viewing Range

The County Data Viewing Range option allows you to select the map range where at and below that value County weather products will be shown on the selected MFD Wx Data Link Map pages (1, 2, or 3). When Off is selected, County Data will not be shown. In the figure below where 100 NM is selected, County data will be shown at map ranges of 100 NM and lower.



Figure 4-55 County Data Viewing Range Selection

Foreword

Sec 1 System

Sec 2 PFD

Sec 3 MFD

Sec 4 Hazard Avoidance

Sec 5 Additional Features

Sec 6 Annun. & Alerts

Sec 7 Symbols

Sec 8 Glossary

Appendix A

Appendix B Index

4.9 Weather Radar (Optional)

The G500 can display weather radar from a Garmin GWX system or from selected 3rd-party radars. Only one weather radar system may be interfaced to the system. For detailed information on the operation of 3rd-party radars, refer to their specific documentation.

4.9.1 Garmin GWX 68 Radar Description

The Garmin GWX 68 Airborne Color Weather Radar is a four color digital pulsed radar with 6.5 kilowatts of power. It combines excellent range and adjustable scanning profiles with a high-definition target display. The pulse width is four microseconds on all ranges except the 2.5 NM range. The GWX 68 uses a one microsecond pulse width at this range to reduce the smearing of targets on the display. This allows better target definition at close range.

To focus radar scanning on specific areas, Sector Scanning offers pilot-adjustable horizontal scan angles of 20°, 40°, 60°, or 90°. A vertical scanning function helps to analyze storm tops, gradients, and cell buildup activity at various altitudes.

Other features include:

- Extended Sensitivity Time Control (STC) logic that automatically correlates distance of the return echo with intensity, so cells do not suddenly appear to get larger as they get closer.
- WATCH™ (Weather Attenuated Color Highlight) which helps identify possible “shadowing” effects of short-range cell activity – identifying areas where radar return signals are weakened, or attenuated, by intense precipitation (or large areas of lesser precipitation) and may not fully reflect the “storm behind the storm.”
- Weather Alert that looks ahead for intense cell activity in the 80-320 NM range, even if these ranges are not being monitored.

4.9.1.1 Principles of Pulsed Airborne Weather Radar

The term RADAR is an acronym for RAdio Detecting and Ranging. Pulsed radar locates targets by transmitting a microwave pulse beam that, upon encountering a target, is then reflected back to the radar receiver as a return “echo.” The microwave pulses are focused and radiated by the antenna, with the most intense energy in the center of the beam and decreasing intensity near

the edge. The same antenna is used for both transmitting and receiving. The returned signal is then processed and displayed on the G500 MFD.

Radar detection is a two-way process that requires 12.36 micro-seconds for the transmitted microwave pulses to travel out and back for each nautical mile of target range. It takes 123.6 micro-seconds for a transmitted pulse to make the round trip if a target is 10 NM away.

The GWX 68 weather radar should be used to avoid severe weather, not for penetrating severe weather. The decision to fly into an area of radar targets depends on target intensity, spacing between the targets, aircraft capabilities and pilot experience. Pulse type weather radar detects only precipitation, not clouds or turbulence. The display may indicate clear areas between intense returns, but this does not necessarily mean it is safe to fly between them. Only Doppler radar can detect turbulence.

Airborne weather radar has other capabilities beyond weather detection. It also has the ability to detect and provide distance to objects on the ground, such as, cities, mountains, coastlines, rivers, lakes, and oceans.

4.9.1.2 Antenna Beam Illumination

It is important to understand the concept of the antenna beam illumination. The radar beam is much like the beam of a spotlight. The farther the beam travels, the wider it gets. The radar is only capable of “seeing” what is inside the boundaries of the beam.

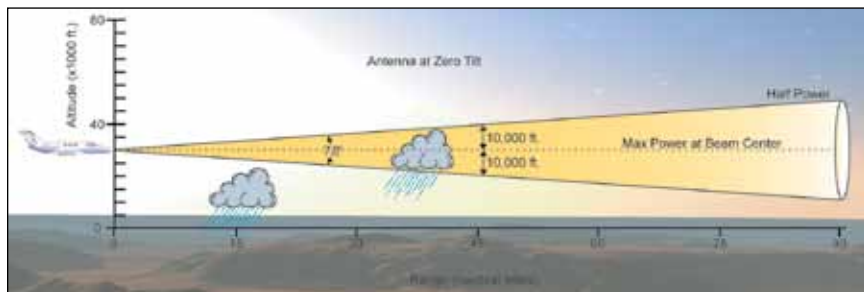

Figure 4-56 Radar Beam from 12 inch Antenna

The vertical dimensions of the radar beam are shown in the figure above and the same holds true for the horizontal dimensions. In other words, the beam will be as wide as it is tall. Note that it is possible not to see areas of precipitation on the radar display because of the antenna tilt setting. With the antenna tilt set to zero in this illustration, the beam overshoots the precipita-

tion at 15 NM. The curvature of the earth can also be a factor, especially at range settings of 150 NM or more.

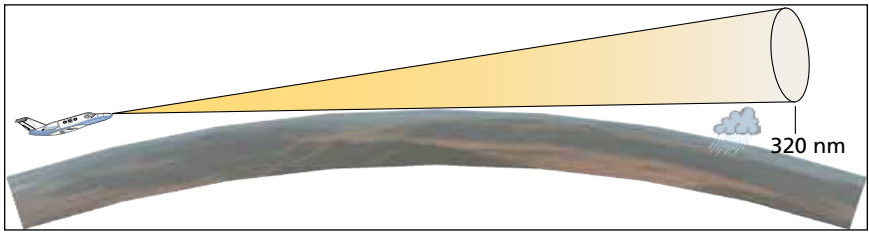

Figure 4-57 Radar Beam in Relation to the Curvature of the Earth

4.9.1.3 Radar Signal Attenuation

The phenomena of weather attenuation needs to be kept in mind whenever operating the weather radar. When the radar signal is transmitted, it is progressively absorbed and scattered, making the signal weaker. This weakening, or attenuation, is caused by two primary sources, distance and precipitation.

Attenuation because of distance is due to the fact that the amount of radar energy at a distance from the antenna is inversely proportional to the square of the distance. The reflected radar energy from a target 40 miles away that fills the radar beam will be one fourth the energy reflected from an equivalent target 20 miles away. This would appear to the operator that the storm is gaining intensity as the aircraft gets closer. Internal circuitry within the GWX 68 system compensates for much of this distance attenuation.

Attenuation due to precipitation is not as predictable as distance attenuation. It is also more intense. As the radar signal passes through moisture, a portion of the radar energy is reflected back to the antenna. However, much of the energy is absorbed. If precipitation is very heavy, or covers a large area, the signal may not reach completely through the area of precipitation. The weather radar system cannot distinguish between an attenuated signal and area of no precipitation. If the signal has been fully attenuated, the radar will display a “radar shadow.” This appears as an end to the precipitation when, in fact, the heavy rain may extend much further. A cell containing heavy precipitation may block another cell located behind the first, preventing it from being displayed on the radar. Never fly into these shadowed areas and never assume that all of the heavy precipitation is being displayed unless another cell or a ground target can be seen beyond the heavy cell. The WATCH™ feature of the GWX 68 Weather Radar system can help in identifying these shadowed areas. Areas in question

Foreword

Sec 1
System

Sec 2
PFD

Sec 3
MFD

Sec 4
Hazard
Avoidance

Sec 5
Additional
Features

Sec 6
Annun.
& Alerts

Sec 7
Symbols

Sec 8
Glossary

Appendix A

Appendix B
Index

will appear as “shadowed” or gray area on the radar display. Proper use of the antenna tilt control can also help detect radar shadows.

Attenuation can also be due to poor maintenance or degradation of the radome. Even the smallest amount of wear and tear, pitting, and pinholes on the radome surface can cause damage and system inefficiency.

4.9.2 Radar Signal Reflectivity

4.9.2.1 Precipitation

Precipitation or objects more dense than water, such as earth or solid structures, will be detected by the weather radar. The weather radar will not detect clouds, thunderstorms or turbulence directly. It detects precipitation associated with clouds, thunderstorms, and turbulence. The best radar signal reflectors are raindrops, wet snow or wet hail. The larger the raindrop the better it reflects. The size of the precipitation droplet is the most important factor in radar reflectivity. Because large drops in a small concentrated area are characteristic of a severe thunderstorm, the radar displays the storm as a strong return. Ice, dry snow, and dry hail have low reflective levels and often will not be displayed by the radar. A cloud that contains only small raindrops, such as fog or drizzle, will not reflect enough radar energy to produce a measurable target return.



Figure 4-58 Precipitation Type and Reflectivity

Sec 1 System Foreword
 Sec 2 PFD
 Sec 3 MFD
 Sec 4 Hazard Avoidance
 Sec 5 Additional Features
 Sec 6 Annun. & Alerts
 Sec 7 Symbols
 Sec 8 Glossary
 Appendix A
 Appendix B Index

4.9.2.2 Ground Returns

The intensity of ground target returns depends upon the angle at which the radar beam strikes the ground target (Angle of Incidence) and the reflective properties of that target. The gain can be adjusted so shorelines, rivers, lakes, and cities are well defined. Increasing gain too much causes the display to fill in between targets, thus obscuring some landmarks.

Cities normally provide a strong return signal. While large buildings and structures provide good returns, small buildings can be shadowed from the radar beam by the taller buildings. As the aircraft approaches, and shorter ranges are selected, details become more noticeable as the highly reflective regular lines and edges of the city become more defined.

Bodies of water such as lakes, rivers, and oceans are not good reflectors, and normally do not provide good returns. The energy is reflected in a forward scatter angle with inadequate energy being returned. They can appear as dark areas on the display. However, rough or choppy water is a better reflector and will provide stronger returns from the downwind sides of the waves.

Mountains also provide strong return signals to the antenna, but also block the areas behind. However, over mountainous terrain, the radar beam can be reflected back and forth in the mountain passes or off canyon walls using up all or most of the radar energy. **In this case, no return signal is received from this area causing the display to show a dark spot which could indicate a pass where no pass exists.**

4.9.2.3 Angle of Incidence

The angle at which the radar beam strikes the target is called the Angle of Incidence. Incident angle (“A”) is illustrated below. This directly affects the detectable range, the area of illumination, and the intensity of the displayed target returns. A large incident angle gives the radar system a smaller detectable range and lower display intensity due to minimized reflection of the radar energy.

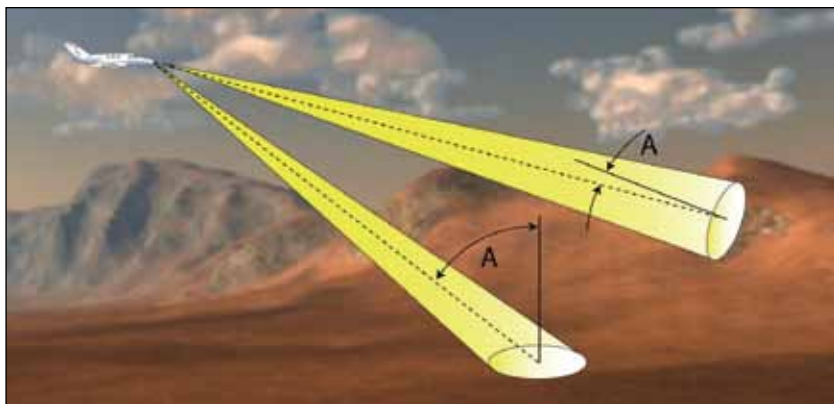

Figure 4-59 Angle of Incidence

A smaller incident angle gives the radar a larger detectable range of operation and the target display will show a higher intensity. Since more radar energy is reflected back to the antenna with a low incident angle, the resulting detectable range is increased for mountainous terrain.

4.9.3 Operating Distance

The following information establishes a minimum safe distance from the antenna for personnel near an operating airborne weather radar. The minimum safe distance is based upon the FCC's exposure limit at 9.3 to 9.5 GHz for general population/uncontrolled environments which is 1 mW/cm². See Advisory Circular 20-68B for more information on safe distance determination.

4.9.3.1 Maximum Permissible Exposure Level (MPEL) (GWX 68)

The zone in which the radiation level exceeds the US Government standard of 1 mW/cm², is the semicircular area of at least 11 feet from the 12 inch antenna as indicated in the illustration below. All personnel must remain outside of this zone. With a scanning or rotating beam, the averaged power density at the MPEL boundary is significantly reduced.

4.9.3.2 Maximum Permissible Exposure Level (MPEL) (Other Radars)

See the appropriate documentation for MPEL.

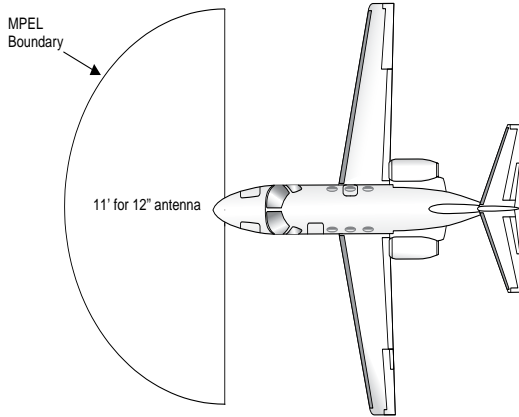

Figure 4-60 MPEL Boundary

4.9.4 Basic Antenna Tilt Setup

The following discussion is a simple method for setting up the weather radar antenna tilt for most situations. It is not to be considered an all encompassing setup that will work in all situations, but this method does provide good overall parameters for the monitoring of threats. Ultimately, it is desired to have the antenna tilted so that the bottom of the radar beam is four degrees below parallel with the ground. The following discussion explains one way of achieving this.

With the aircraft flying level, adjust the antenna tilt so ground returns are displayed at a distance that equals the aircraft's current altitude (AGL) divided by 1,000. For example, if the aircraft is at 14,000 feet, adjust the tilt so the front edge of ground returns are displayed at 14 NM. Note this antenna tilt angle setting. Now, raise the antenna tilt 6° above this setting. The bottom of the radar beam is now angled down 4° from parallel with the ground.

Practical Application Using the Basic Tilt Setup

At this point, when flying at altitudes between 2,000 and 30,000 feet AGL, any displayed target return should be scrutinized. If the displayed target advances on the screen to 5 NM of the aircraft, avoid it. This may be either weather or ground returns that are 2,000 feet or less below the aircraft. Raising the antenna tilt 4° can help separate ground returns from weather returns in relatively flat terrain. This will place the bottom of the radar beam level with the ground. Return the antenna tilt to the previous setting after a few sweeps.

If the aircraft is above 29,000 feet, be cautious of any target return that gets to 30 NM or closer. This is likely a thunderstorm that has a top high enough that the aircraft cannot fly over it safely.

If the aircraft altitude is 15,000 feet or lower, set the displayed range to 60 NM. Closely monitor anything that enters the display.

Also, after setting up the antenna tilt angle as described previously, ground returns can be monitored for possible threats. The relationship between antenna tilt angle, altitude, and distance is one degree of tilt equals 100 feet of altitude for every one nautical mile.

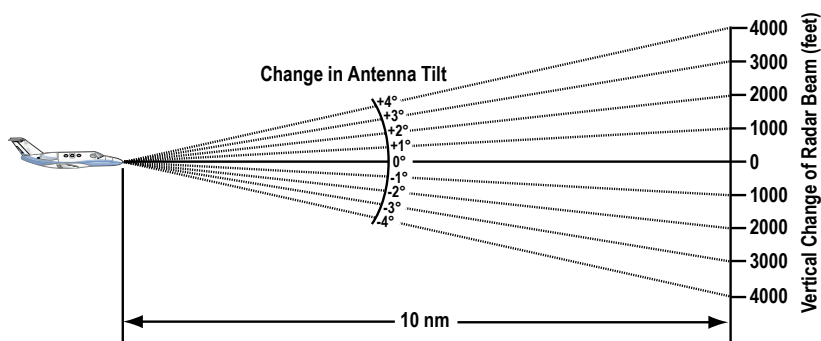

Figure 4-61 Vertical Change in Radar Beam per Nautical Mile

Therefore, with the antenna tilt set so that the bottom of the beam is four degrees below parallel with the ground, a target return at 10 NM is approximately 4,000 feet below the aircraft; at 20 NM, 8,000 feet; at 50 NM, 20,000 feet. In other words, at this tilt setting, a ground return (such as a mountain peak) being displayed at 10 NM would have a maximum distance below the aircraft of 4,000 feet. If that ground target return moves to 5 NM, maximum distance below the aircraft will be 2,000 feet.

This setup will provide a good starting point for practical use of the GWX 68. There are many other factors to consider in order to become proficient at using weather radar in all situations.

4.9.5 Weather Mapping and Interpretation

4.9.5.1 Weather display Interpretation

When evaluating various target returns on the weather radar display, the colors denote approximate rainfall intensity and rates as shown in the table below.

Foreword
Sec 1 System
Sec 2 PFD
Sec 3 MFD
Sec 4 Hazard Avoidance
Sec 5 Additional Features
Sec 6 Annun. & Alerts
Sec 7 Symbols
Sec 8 Glossary
Appendix A
Appendix B Index

Weather Mode Color	GWX 68 Radars		3rd Party Radars
	Approximate Intensity	Approximate Rainfall Rate (in/hr)	Radar Return Level (see radar documentation for details)
BLACK	< 23 dBZ	< .01	0
GREEN	23 dBZ to < 32 dBZ	.01 - 0.1	1
YELLOW	32 dBZ to < 41 dBZ	0.1 - 0.5	2
RED	41 dBZ to < 50 dBZ	0.5 - 2	3
MAGENTA	50 dBZ and greater	> 2	4

Table 4-17 Precipitation Intensity Levels

4.9.5.2 Thunderstorms

Updrafts and downdrafts in thunderstorms carry water through the cloud. The more severe the drafts, the greater the number and size of the precipitation droplets. With this in mind, the following interpretations can be made from what is displayed on the weather radar. Avoid these areas by an extra wide margin.

- In areas where the displayed target intensity is red or magenta (indicating large amounts of precipitation), the turbulence is considered severe.
- Areas that show steep color gradients (intense color changes) over thin bands or short distances suggest irregular rainfall rate and strong turbulence.
- Areas that show red or magenta are associated with hail or turbulence, as well as heavy precipitation. Vertical scanning and antenna tilt management may be necessary to identify areas of maximum intensity.

Along squall lines (multiple cells or clusters of cells in a line), individual cells may be in different stages of development. Areas between closely spaced, intense targets may contain developing clouds not having enough moisture to produce a return. However, these areas could have strong updrafts or downdrafts. Targets showing wide areas of green are generally precipitation without severe turbulence.

Irregularities in the target return may also indicate turbulence, appearing as “hooks,” “fingers,” or “scalloped” edges. These irregularities may be present in green areas with no yellow, red, or magenta areas and should be treated as highly dangerous areas. Avoid these areas as if they were red or magenta areas.

Foreword

System Sec 1

PFD Sec 2

MFD Sec 3

Hazard Avoidance Sec 4

Additional Features Sec 5

Annun. & Alerts Sec 6

Symbols Sec 7

Glossary Sec 8

Appendix A

Appendix B Index

Foreword
 Sec 1 System
 Sec 2 PFD
 Sec 3 MFD
 Sec 4 Hazard Avoidance
 Sec 5 Additional Features
 Sec 6 Annun. & Alerts
 Sec 7 Symbols
 Sec 8 Glossary
 Appendix A
 Appendix B Index

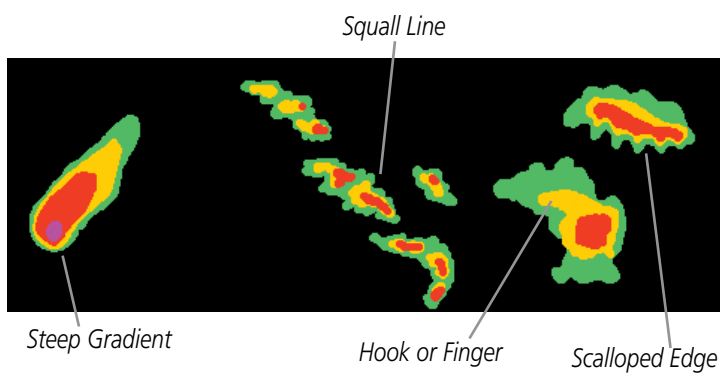

Figure 4-62 Cell Irregularities

Thunderstorm development is rapid. A course may become blocked within a short time. When displaying shorter ranges, periodically select a longer range to see if problems are developing further out. That can help prevent getting trapped in a “blind alley” or an area that is closed at one end by convective weather.

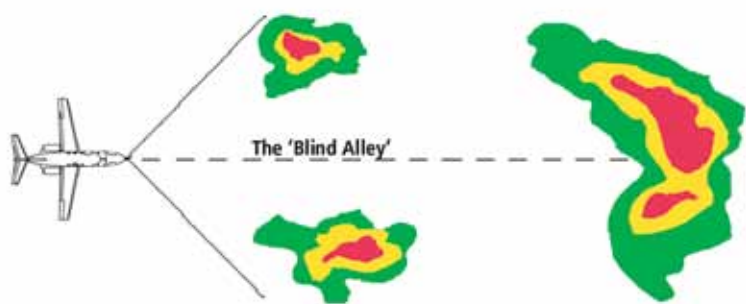

Figure 4-63 The “Blind Alley” Overhead View

In areas of multiple heavy cells, use the Vertical Scan feature along with antenna tilt management to examine the areas. Remember to avoid shadowed areas behind targets.

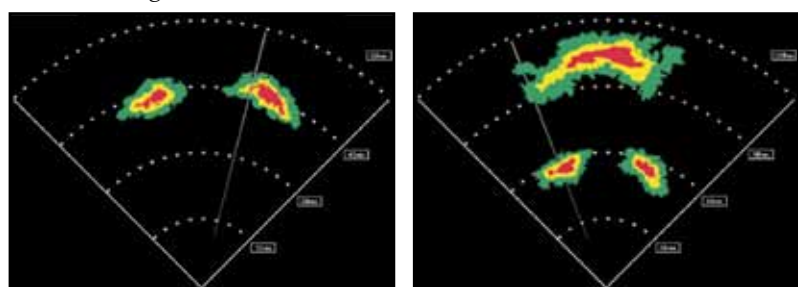

Figure 4-64 The “Blind Alley” Horizontal Scan

4.9.5.3 Tornadoes

There is no conclusive radar target return characteristics which will identify a tornado, however, tornadoes may be present if the following characteristics are observed:

- A narrow, finger-like portion, as shown on the previous page, extends and, in a short time, curls into a hook and closes on itself.
- A “hook” which may be in the general shape of the numeral “6,” especially if bright and projecting from the southwest quadrant (northeast quadrant in the southern hemisphere) of a major thunderstorm.
- V-shaped notches.
- Doughnut shapes.

These shapes do not always indicate tornadoes, nor are tornado returns limited to these characteristics. Confirmed radar observations of tornadoes most often have not shown shapes different from those of a normal thunderstorm display.

4.9.5.4 Hail

Hail results from updrafts carrying water high enough to freeze. Therefore, the higher the top of a thunderstorm, the greater the probability that it contains hail. Vertically scanning the target return can give the radar top of a thunderstorm that contains hail. Radar top is the top of a storm cell *as detected by radar*. It is not the actual top, or true top of the storm. The actual top of a storm cell is seen with the eyes in clear air and may be much higher than the radar top. The actual top does not indicate the top of the hazardous area.

Hail can fall below the minimum reflectivity threshold for radar detection. It can have a film of water on its surface, making its reflective characteristics similar to a very large water droplet. Because of this film of water, and because hail stones usually are larger than water droplets, thunderstorms with large amounts of wet hail return stronger signals than those with rain. Some hail shafts are extremely narrow (100 yards or less) and make poor radar targets. In the upper regions of a cell where ice particles are “dry” (no liquid coating), target returns are less intense.

Hail shafts are associated with the same radar target return characteristics as tornados. U-shaped cloud edges 3 to 7 miles across can also indicate hail.

Foreword

Sec 1
System

Sec 2
PFD

Sec 3
MFD

Sec 4
Hazard
Avoidance

Sec 5
Additional
Features

Sec 6
Annun.
& Alerts

Sec 7
Symbols

Sec 8
Glossary

Appendix A

Appendix B
Index

These target returns appear quite suddenly along any edge of the cell outline. They also change in intensity and shape in a matter of seconds, making vigilant monitoring essential.

4.9.6 Radar Operation in Weather Mode



WARNING: Begin transmitting only when it is safe to do so. When transmitting while the aircraft is on the ground, no personnel or objects should be within 11 feet of the antenna.



CAUTION: In Standby mode, the antenna is parked at the center line. It is always a good idea to put the radar in Standby mode before taxiing the aircraft to prevent the antenna from bouncing on the bottom stop and possibly causing damage to the radar assembly.

When the weather radar system is in the Weather or Ground Map mode, the system automatically switches to Standby mode on landing.



Figure 4-65 Horizontal Scan Display

4.9.6.1 Displaying Weather on the Weather Radar Page



NOTE: Distances on the Weather Radar page are always shown in NM.

- 1) While viewing the Weather Radar page of the Wx page group, press the **MODE** soft key.
- 2) While on the ground, press the **STANDBY** soft key. A warm-up period is initiated (countdown is displayed on the screen - GWX radars only). After the warm-up is complete, the radar enters the Standby Mode.
- 3) When the aircraft is airborne, press the **WEATHER** soft key.
OR
- 4) While on the ground, select the **WEATHER** soft key. A confirmation window is displayed.

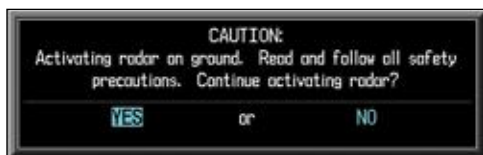

Figure 4-66 Caution for Radar Activation Confirmation

- 5) Turn the large **MFD** Knob to highlight **YES** and press the **ENT** key to continue radar activation.
OR
- 6) If the aircraft is airborne, select the **WEATHER** soft key. A warm-up period is initiated (countdown is displayed on the screen - GWX radars only). After the warm-up is complete, the radar begins transmitting.
- 7) Press the **RNG** keys to select the desired range.

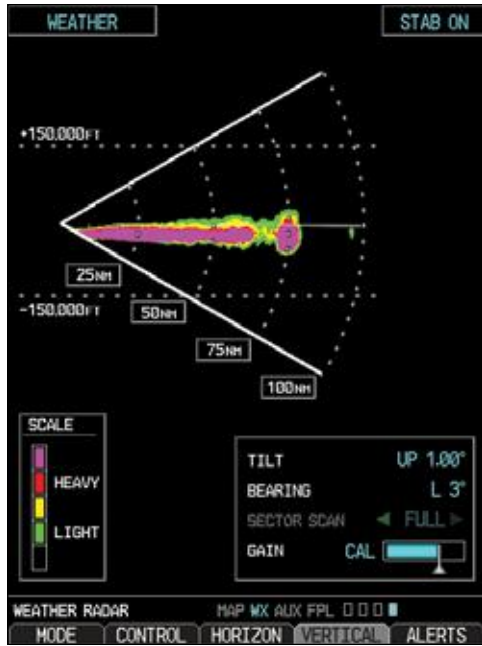

Figure 4-67 Vertical Scan Display

4.9.6.2 Vertically Scanning a Storm Cell (Not available with all radars)

When vertically scanning with stabilization ON, the actual physical area that the radar is sweeping may not match the GDU vertical scan display. This occurs whenever the aircraft pitch is not at 0 degrees. To compensate for this, the GDU vertical display will “erase” the portion of the vertical display that is no longer being scanned. It will appear that the vertical sweep “wraps around” when reaching the end of the GDU vertical display. The radar is simply “erasing” the portion of the vertical display that is not currently being scanned.



NOTE: Vertical scanning of a storm cell should be done with the aircraft wings level to avoid constant adjustment of the Bearing Line.

Sec 4 Hazard Avoidance
 Sec 1 System
 Sec 2 PFD
 Sec 3 MFD
 Sec 5 Additional Features
 Sec 6 Annun. & Alerts
 Sec 7 Symbols
 Sec 8 Glossary
 Appendix A
 Appendix B Index

- 1) While in the Horizontal Scan view, press the **CONTROL** and then the **BRG** soft keys. This displays the Bearing Line.

OR

Press **MENU** and turn the large or small **MFD** knobs to highlight the “Show Bearing Line” menu item and press the **ENT** key. This displays the Bearing Line.

- 2) Press the **MFD** knob to activate the Bearing Line Adjustment in the Control window. Turn the Large **MFD** knob to highlight the Bearing value.
- 3) Turn the small **MFD** knob to place the Bearing Line on the desired storm cell or other area to be vertically scanned.

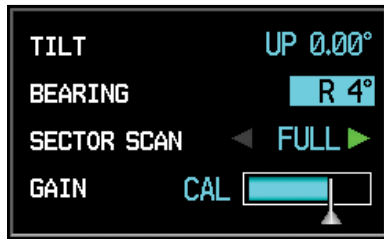

Figure 4-68 Bearing Line Adjustment

- 4) Press the **VERTICAL** soft key. A vertical “slice” of the selected area will now be displayed.
- 5) With the Bearing value still highlighted, the small **MFD** Knob may be used to move the scanned “slice” a few degrees right or left.
- 6) Press the **RNG** keys to adjust the range.
- 7) Press the **MFD** Knob to remove the cursor.
- 8) To select a new area to be vertically scanned, select the **HORIZON** soft key to return to the Horizontal Scan view and repeat the previous steps.

4.9.6.3 Adjusting the Antenna Tilt Angle

In order to make an accurate interpretation of a storm cell, the radar beam should be pointed at the wet part of the weather cell to record the proper rainfall intensity (color level). The ideal aiming point is just below the freezing level of the storm. The best way to find this point is to use the Vertical Scan feature. The antenna tilt angle can be centered on the strongest return area in the vertical scan to get a more accurate view of the coverage and intensity of the target in the horizontal scan.

Adjusting Antenna Tilt on the Horizontal Scan Display

- 1) Press the **MFD** knob.
- 2) With the Tilt value highlighted in the Control window, turn the small **MFD** knob to adjust the Tilt.

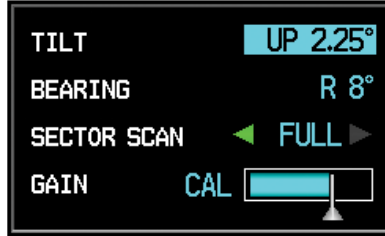

Figure 4-69 Adjusting Tilt

Adjusting Antenna Tilt on the Vertical Scan Display (Not available with all radars)

- 1) While in the Vertical Scan view, press the **CONTROL** and then the **TILT** soft keys. This displays the Tilt Line.

OR

Press **MENU** and turn the large or small **MFD** knobs to highlight the "Show Tilt Line" menu item and press the **ENT** key. This displays the Tilt Line.

- 2) Press the **MFD** knob to activate the Tilt Adjustment in the Control window. Turn the Large **MFD** knob to highlight the Tilt value.
- 3) Turn the small **MFD** knob to place the adjust the Tilt value.

4.9.6.4 Adjusting Gain

The gain is used to adjust the sensitivity of the radar receiver. It can be used to adjust the characteristics of the returns.

Gain adjustment is shown in the Gain bar graph. The white reference line on the right side of the bar graph indicates the calibration reference point.



WARNING: Changing the gain in weather mode will cause precipitation intensity to be displayed as a color not representative of the true intensity. Remember to return the gain setting to : "Calibrated" for viewing the actual intensity of precipitation.



NOTE: Gain can be adjusted in Weather mode on the GWX radars only.

- 1) While viewing the Weather Radar page of the Wx page group, press the **MENU** key.
 - 2) Turn the large **MFD** knob to highlight “Manual Gain” and press **ENT**. This will highlight the Gain value in the Control window.
 - 3) Turn the small **MFD** knob to adjust the Gain.
- OR
- 1) Press the **MFD** knob and turn the large **MFD** knob to highlight the Gain value in the Control window.

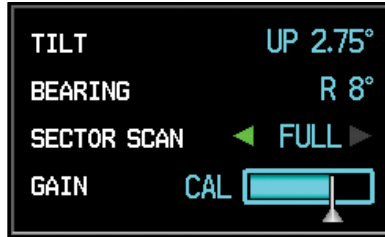

Figure 4-70 Highlight Gain Cal Value

- 2) Turn the small **MFD** knob to adjust the Gain Cal value. Press the **MFD** knob again to accept the value and end editing.

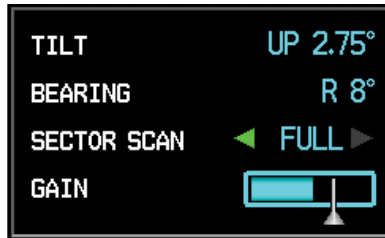

Figure 4-71 Adjust Gain Cal Value

Restore Calibrated Gain

- 1) While viewing the Weather Radar page of the Wx page group, press the **MENU** key.
- 2) Turn the large **MFD** knob to highlight “Restore Calibrated Gain” and press **ENT**.



Figure 4-72 Restore Calibrated Gain

OR

- 1) While viewing the Weather Radar page of the Wx page group, press the **CONTROL** soft key.
- 2) Press the **GAIN CAL** soft key to restore the calibrated gain value. Press the **MFD** knob again to accept the value and end editing.

4.8.6.5 Sector Scan (GWX Radars Only)

Adjusting the Sector Scan reduces the scan angle from Full in increments of $\pm 20^\circ$, $\pm 40^\circ$, and $\pm 60^\circ$ in horizontal scanning. Sector scanning is not available for vertical scanning.

- 1) While viewing the Weather Radar page of the Wx page group, press the **CONTROL** soft key.
- 2) Press the **BRG** soft key to display the Bearing Line.
- 3) Turn the small **MFD** knob to place the Bearing Line in the desired position. The location of the Bearing Line will become the center point of the Sector Scan.
- 4) Turn the large **MFD** knob to place the cursor in the SECTOR SCAN field.

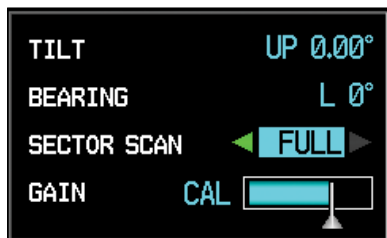

Figure 4-73 Sector Scan - Full

- 5) Turn the small **MFD** knob to select FULL, 60° , 40° , or 20° scan.

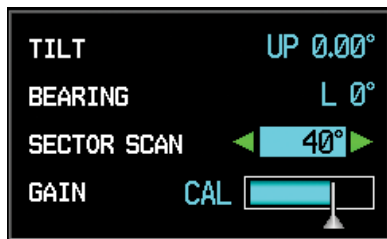

Figure 4-74 Sector Scan - 40°

- 6) If desired, readjust the Bearing Line as discussed previously to change the center of the Sector Scan.
- 7) Remove Sector Scanning by returning the SECTOR SCAN value to FULL.

4.9.6.6 Antenna Stabilization

- 1) While viewing the Weather Radar page of the Wx page group, press the **CONTROL** soft key.
- 2) To activate or deactivate the antenna stabilization, press the **STAB ON** soft key to activate antenna stabilization or press the **STAB OFF** soft key to deactivate. The current stabilization condition is shown in the upper right of the weather radar display.

4.9.6.7 Weather Attenuated Color Highlight (WATCH™) (GWX Radars Only)

While in horizontal scan mode, this feature can be used as a tool to determine areas of possible inaccuracies in displayed intensity due to weakening of the radar energy. This weakening is known as “attenuation.” The radar energy weakens as it passes through areas of intense precipitation, large areas of lesser precipitation, and distance. Issues with the radome will also attenuate the radar energy. All these factors have an effect on the return intensity. The more energy that dissipates, the lesser the displayed intensity of the return. Accuracy of the displayed intensity of returns located in the shaded areas are suspect. Make maneuvering decisions with this information in mind. Proper antenna tilt management should still be employed to determine the extent of attenuation in a shaded area.

- 1) While viewing the Weather Radar page of the Wx page group, press the **CONTROL** soft key.
- 2) To activate or deactivate the WATCH™ feature, press the **WATCH** soft key.

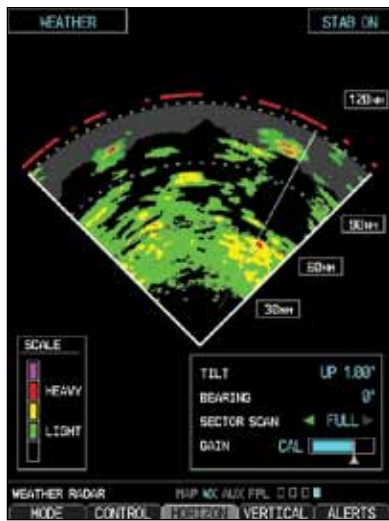
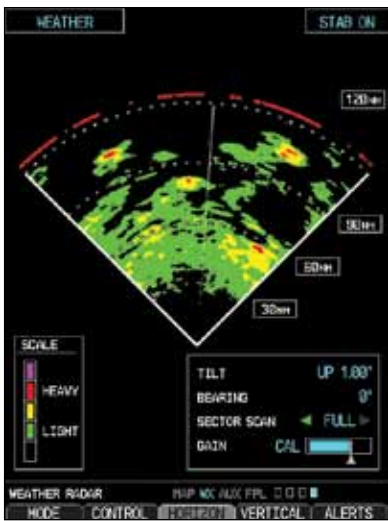

Figure 4-75 Horizontal Scan without WATCHM™ Figure 4-76 Horizontal Scan with WATCHM™

4.9.6.8 Weather Alert (GWX Radars Only)

The Weather Alert feature indicates the presence of heavy radar returns beyond the currently displayed range. Weather Alert targets appear as red bands along the outer range ring at the approximate azimuth of the detected returns.

If the antenna tilt is adjusted too low, a weather alert can be generated by ground returns.

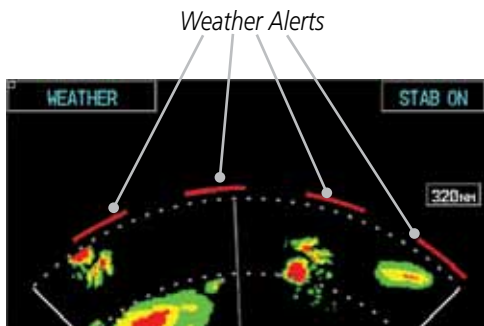

Figure 4-77 Weather Alert Display

If a Weather Alert is detected within $\pm 10^\circ$ of the aircraft heading, an text alert will be displayed on the MFD in the Alerts Window. These text Weather Alerts can be deactivated without deactivating the red bands on the radar display.

Foreword
 Sec 1 System
 Sec 2 PFD
 Sec 3 MFD
 Sec 4 Hazard Avoidance
 Sec 5 Additional Features
 Sec 6 Annun. & Alerts
 Sec 7 Symbols
 Sec 8 Glossary
 Appendix A
 Appendix B Index

- 1) While viewing the Weather Radar page of the Wx page group, press the **MENU** key.
- 2) To activate or deactivate Weather Alerts, turn the large or small **MFD** knob to highlight either "Enable Weather Alert" or "Inhibit Weather Alert."

4.9.7 Ground Mapping and Interpretation

A secondary use of the weather radar system is for the presentation of terrain. This can be a useful tool for verifying aircraft position. A "picture" of the ground is represented much like a topographical map that can be used as a supplement to the navigation map on the MFD.

Ground Map mode uses a different gain range than Weather mode. Different colors are also used to represent the intensity levels. The displayed intensity of ground target returns are defined in the following table. Use of the **GAIN** and **TILT** controls will help improve contrast so that specific ground targets can be recognized more easily. As previously discussed, the type and orientation of the target in relation to the aircraft affects the intensity displayed.

When the weather radar system is in either the Weather or Ground Map mode, the system automatically switches to Standby mode.

Ground Map Mode Color	GWX Radars Intensity	3rd Party Radars Level
BLACK	0 dB	0
LIGHT BLUE	> 0 dB to < 9 dB	1
YELLOW	9 dB to < 18 dB	2
MAGENTA	18 dB to < 27 dB	3 and above
BLUE	27 dB and greater	Not Used

Table 4-18 Ground Target Return Intensity Levels

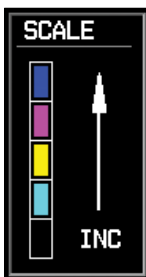

Figure 4-78 GWX Radar Ground Mode Scale

3rd Party Radar Ground Mode Scale

- 1) Press the **MODE** soft key.
- 2) Press the **GROUND** soft key to place the radar in Ground Map mode. A pop-up regarding caution in operating radar on the ground will appear. Turn the large **MFD** knob to highlight "YES" and then press **ENT**.



Figure 4-79 Ground Radar Operation Caution

- 3) Press the **BACK** soft key.
- 4) Press the **MFD** knob to activate the cursor.
- 5) Turn the large **MFD** knob to place the cursor in the TILT field.
- 6) Adjust the antenna tilt angle by turning the small **MFD** knob to display ground returns at the desired distance.
- 7) Press the **MFD** knob to remove the cursor.

Foreword

Sec 1 System

Sec 2 PFD

Sec 3 MFD

Sec 4 Hazard Avoidance

Sec 5 Additional Features

Sec 6 Annun. & Alerts

Sec 7 Symbols

Sec 8 Glossary

Appendix A

Appendix B Index

4.10 GFDS Weather (Optional)

GFDS Weather is an optional feature available with the Iridium® satellite system that is interfaced through the optional Garmin GSR 56. The primary maps for viewing Garmin Flight Data System (GFDS) Weather data are the Weather Data Link Pages in the Map Page Group. These are the only GDU 620 map displays capable of all available GFDS weather products. The Wx Weather pages may be oriented to either Track Up or North Up. Both GFDS and XM Weather may be installed and selected individually. GFDS Weather coverage is available throughout most of Europe, Canada and the U.S. Additional radar coverage areas are being added continuously.

More detail on GFDS weather products and coverage can be found at:

<http://fly.garmin.com/fly-garmin/gfds-weather/>



NOTE: A system can be configured for both XM and GFDS, but both cannot be displayed at the same time.



WARNING: Do not use data link weather information for maneuvering in, near, or around areas of hazardous weather. Information contained within data link weather products may not accurately depict current weather conditions.



WARNING: Do not use the indicated data link weather product age to determine the age of the weather information shown by the data link weather product. Due to time delays inherent in gathering and processing weather data for data link transmission, the weather information shown by the data link weather product may be significantly older than the indicated weather product age.

- While viewing a WX Data Link Map page of the WX page group, press the **MENU** key to display the Page Menu Options. Turn the large **MFD** knob to highlight the "Display GFDS Weather" option. Press **ENT**. This setting will affect the display of data link weather on the map pages as well as the Wx pages.



Figure 4-80 Select GFDS Weather

- 2) Select XM Weather by repeating the process and selecting the XM Weather option.



Figure 4-81 Select XM Weather

4.10.1 Using GFDS Satellite Weather Products

When a weather product is active on the Weather Data Link Page or the Navigation Map Page, the age of the data is displayed on the screen. The age of the product is based on the time difference between when the data was assembled on the ground and the current GPS time. Weather products are refreshed at selectable intervals.

If for any reason, a weather product is not refreshed within the 30, 60, 90, or 120 minute Expiration Time intervals, the data is considered expired and is removed from the display. This ensures that the displayed data is consistent with what is currently being broadcast by GFDS Satellite Radio services. If more than half of the expiration time has elapsed from the time the data is received, the color of the product age displayed changes to yellow.

4.10.2 Register With GFDS

4.10.2.1 Register With GFDS

It is necessary to register the GDU with GFDS to utilize the weather products.

- 1) Call Garmin Customer Service to create a GFDS account. Provide the GDU System ID and airframe info (model, tail number, etc).
- 2) Customer Service will issue an access code to enter on the GFDS Registration page.
- 3) While viewing a WX Data Link Map page of the WX page group, press the **MENU** key to display the Page Menu Options.
- 4) Turn the large **MFD** knob to highlight "Register With GFDS." Press **ENT**.

Foreword
 Sec 1 System
 Sec 2 PFD
 Sec 3 MFD
 Sec 4 Hazard Avoidance
 Sec 5 Additional Features
 Sec 6 Annun. & Alerts
 Sec 7 Symbols
 Sec 8 Glossary
 Appendix A
 Appendix B Index



Figure 4-82 Select GFDS Registration

- Turn the small **MFD** knob to select values and the large **MFD** knob to move to the next position. Highlight **REGISTER** and press **ENT** to complete the process. The GDU will contact the GFDS servers using the GSR 56 transceiver. If the access code and system ID are correct, it will download and display the airframe info.



Figure 4-83 GFDS Registration Page (Default and Completed)

4.10.2.2 Deactivate Unit Registration With GFDS

Registration of the GDU unit with GFDS can be deactivated so that the unit can no longer make requests to GFDS. This does not cancel the subscription.

- While viewing a WX Data Link Map page of the WX page group, press the **MENU** key to display the Page Menu Options.
- Turn the large **MFD** knob to highlight "Register With GFDS." Press **ENT**.
- With the Access Code field highlighted, press **CLR** to remove the access code.

Foreword

Sec 1
System

Sec 2
PFD

Sec 3
MFD

Sec 4
Hazard
Avoidance

Sec 5
Additional
Features

Sec 6
Annun.
& Alerts

Sec 7
Symbols

Sec 8
Glossary

Appendix A

Appendix B
Index

- 4) Any weather requests will now fail and the system will no longer be linked to the GFDS account.

4.10.3 Customizing the GFDS Weather Map

Each Wx Data Link Map page may be customized individually. The Wx Data Link Map pages are customized by selecting options from the Page Menu. The Page Menu options include choices for Weather Setup and displaying the Weather Legends. The Weather Setup choice covers selections for adjusting the viewing ranges of the weather products.

- 1) While viewing a WX Data Link Map page of the WX page group, press the **MENU** key to display the Page Menu Options. Turn the large **MFD** knob to highlight the "Weather Setup" option. Press **ENT**.



Figure 4-84 Weather Page Menu Options

- 2) With the Data Link Setup Menu displayed, turn the Large **MFD** knob to select the desired item.



Figure 4-85 Weather Data Link Setup Menu Options

- 3) Turn the small **MFD** knob to select the desired weather feature option.

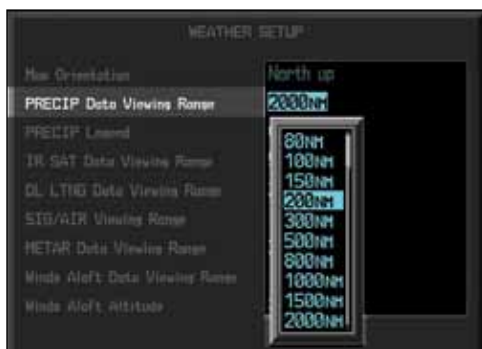

Figure 4-86 Weather Data Link Setup Menu Option Selection

- 4) Press **ENT** to save a selection.
- 5) Turn the large **MFD** knob to the next desired option or press the small **MFD** knob to cancel and return to the GFDS Weather Data Link Map Page.

WX Page Menu - Weather Setup	
Menu Item	Adjustment
Map Orientation	North Up, Track Up
PRECIP Data Viewing Range	Off, 50 NM to 2000 NM
PRECIP Legend	On/Off
IR SAT Data Viewing Range	Off, 50 NM to 2000 NM
Lightning Data Viewing Range	Off, 50 NM to 2000 NM
SIG/Air Viewing Range	Off, 50 NM to 2000 NM
METAR Data Viewing Range	Off, 50 NM to 2000 NM
Wnd Aloft Data Viewing Range	Off, 50 NM to 2000 NM
Wnd Aloft Altitude	Surface, 3000 feet to 42000 feet

Table 4-19 GFDS Weather Page Menu Setup Options

4.10.4 Weather Page Map Orientation

The Orientation option sets the orientation of the Wx Data Link Map pages.

- 1) While viewing the Wx Data Link Map 1, 2, or 3 of the Wx page group, press the **MENU** key. With "Weather Setup" highlighted, press **ENT**.
- 2) With the "Map Orientation" option active, turn the small **MFD** knob to change the highlighted value.



Figure 4-87 Weather Page Map Orientation

- 3) Press **ENT** to accept the displayed value. The next option will be highlighted.
- 4) Press the small **MFD** knob to cancel selection or to end editing and return to the WX page or turn the large **MFD** knob to the next option.

4.10.5 GFDS Data Request

It is necessary to request the downloading of weather products. Requests can be sent manually or set to automatically update at a selected rate.

- 1) While viewing a WX Data Link Map page of the WX page group, press the **MENU** key to display the Page Menu Options.
- 2) Turn the large **MFD** knob to highlight "GFDS Data Request." Press **ENT**.



Figure 4-88 Select GFDS Data Request

- 3) Turn the small **MFD** knob to select values and the large **MFD** knob to move to the next position.



Figure 4-89 GFDS Data Request Page

4.10.5.1 GFDS Data Request Coverage

Present Position GFDS Data Request

- 1) While viewing a WX Data Link Map page of the WX page group, press the **MENU** key to display the Page Menu Options.
- 2) Turn the large **MFD** knob to highlight "GFDS Data Request." Press **ENT**.
- 3) Turn the large **MFD** knob to highlight "Present Position." Press **ENT**.
- 4) The Present Position box will be checked and weather information will be requested around your present position.
- 5) To deselect Present Position reporting, turn the large **MFD** knob to highlight "Present Position." Press **ENT**.

Destination GFDS Data Request

- 1) Turn the large **MFD** knob to highlight "Destination." Press **ENT**.
- 2) The Destination box will be checked and weather information will be requested around your flight plan destination.
- 3) To deselect Destination reporting, turn the large **MFD** knob to highlight "Destination." Press **ENT**.

Flight Plan GFDS Data Request

- 1) Turn the large **MFD** knob to highlight "Flight Plan." Press **ENT**.
- 2) The range list will now be highlighted. Turn the small **MFD** knob to highlight the desired range and press **ENT**.

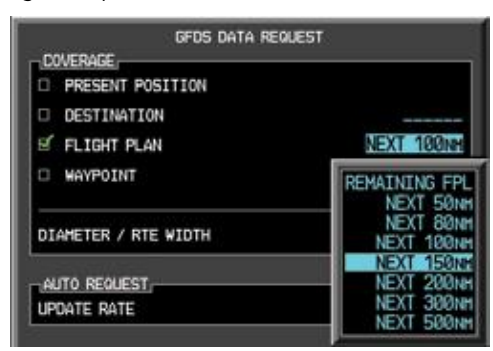

Figure 4-90 Flight Plan GFDS Data Request

- 3) The Flight Plan box will be checked and weather information will be requested along your flight plan forward of your present position for the range selected.

- To deselect Flight Plan reporting, turn the large **MFD** knob to highlight "Flight Plan." Press **ENT**.

Waypoint GFDS Data Request

- Turn the large **MFD** knob to highlight "Waypoint." Press **ENT**.
- The Waypoint Selection field will now be highlighted. Turn the small **MFD** knob to select the first character. Turn the large **MFD** knob to highlight the next character. When finished selecting the waypoint name, press **ENT**.



Figure 4-91 Waypoint GFDS Data Request

- The Waypoint box will be checked and weather information will be requested around the selected waypoint for the range selected (next operation).

4.10.5.2 GFDS Data Request Auto Request

- 1) Turn the large **MFD** knob to highlight "Auto Request - Update Rate."
- 2) Turn the small **MFD** knob to select "Off" or an Update Rate. When finished selecting the Update Rate, press **ENT**. The Update Rate will default to "OFF" at each power cycle.



Figure 4-92 GFDS Data Request Auto Update Rate

4.10.5.3 GFDS Data Request Manual Request

The GFDS weather data may be updated at any time regardless of the automatic update timing by selecting a Manual Request. When multiple requests are made, some products are merged with the old data (SIGMETs/AIRMETs, TAFs, TFRs, and METARs), but the old data of other products is discarded.

- 1) Turn the large **MFD** knob to highlight "Manual Request - Send Req."
- 2) Press **ENT**.

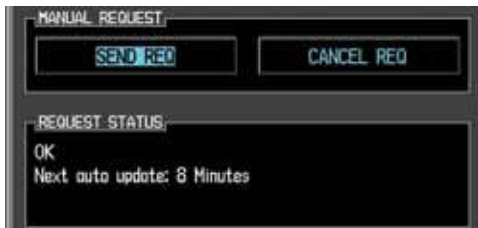

Figure 4-93 Manual GFDS Data Request

- 3) The update request will occur immediately. The action will be noted in the Request Status window. The Auto Request time will be reset to the selected value.

4.10.5.4 GFDS Data Request Status Window

The Request Status window will show a response such as "OK" when manual requests are made. The time for the next auto update will be shown.

Diameter/Route Width GFDS Data Request

- 1) After selecting a coverage option in the previous section, the Diameter/Route Width field will now be highlighted.



Figure 4-94 Waypoint GFDS Data Request Range

- 2) Turn the small **MFD** knob to select the desired Diameter/Route Width and then press **ENT**.

Foreword

System Sec 1

PFD Sec 2

MFD Sec 3

Sec 4
Hazard
Avoidance

Additional
Features Sec 5

Annun.
& Alerts Sec 6

Symbols Sec 7

Glossary Sec 8

Appendix A

Appendix B
Index

4.10.6 Precipitation (PRECIP) Data Viewing Range

The PRECIP Viewing Range option allows you to select the map range where at and below the selected value PRECIP weather products will be shown on the selected MFD Wx Data Link Map page (1, 2, or 3). When Off is selected, PRECIP weather data will not be shown. In the figure below where 500 NM is selected, PRECIP data will be shown at map ranges of 500 NM and lower. TFRs and METARs are the only weather products shown below 10 NM.

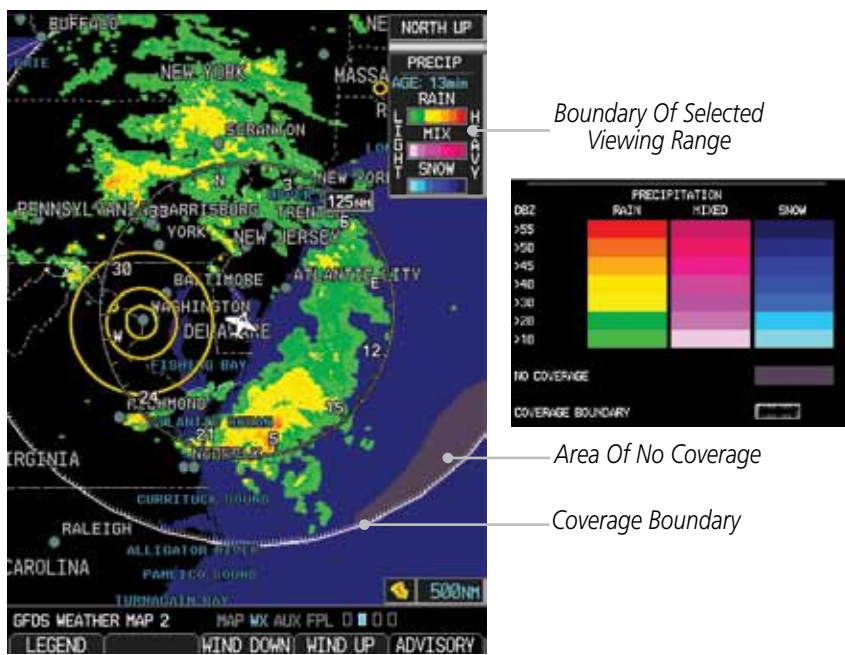

Figure 4-95 GFDS PRECIP Weather Map Display and Legend

- 1) While viewing a WX Data Link Map page of the WX page group, press the **MENU** key to display the Page Menu Options. Turn the large **MFD** knob to highlight the Weather Setup option and press **ENT**.
- 2) Turn the large **MFD** knob to highlight PRECIP Data Viewing Range. Turn the small **MFD** knob to highlight the desired value.
- 3) Press **ENT** to accept the displayed value. The next option will be highlighted.

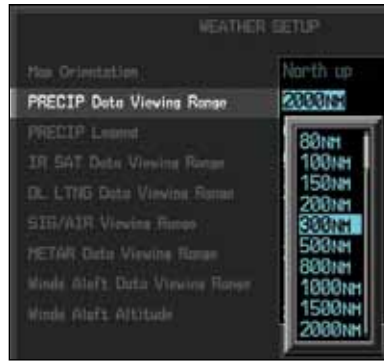

Figure 4-96 GFDS PRECIP Viewing Range Selection

- 4) Press the small **MFD** knob to cancel selection or to end editing and return to the WX page or turn the large **MFD** knob to the next option.

4.10.7 PRECIP Legend

The PRECIP Legend selection provides the option of displaying an abbreviated version of the PRECIP legend in the top right region of the MFD. The full legend is available by pressing the **LEGEND** soft key.



Figure 4-97 GFDS PRECIP Legend Selection

- 1) While viewing a WX Data Link Map page of the WX page group, press the **MENU** key to display the Page Menu Options. Turn the large **MFD** knob to highlight the Weather Setup option and press **ENT**.
- 2) Turn the large **MFD** knob to highlight PRECIP Legend.
- 3) Turn the small **MFD** knob to highlight Off or On. Press **ENT** to accept the displayed value. The next option will be highlighted.
- 4) Press the small **MFD** knob to cancel selection or to end editing and return to the WX page or turn the large **MFD** knob to the next option.

4.10.8 GFDS Infrared Satellite (IR SAT) Data Viewing Range

IR SAT data is available over North America and Europe and depicts cloud top temperatures from satellite imagery. Brighter cloud top colors indicate cooler temperatures occurring at higher altitudes. Information is updated every half hour.



Figure 4-98 GFDS Infrared Satellite Data Map Display and Legend

Foreword

Sec 1
System

Sec 2
PFD

Sec 3
MFD

**Sec 4
Hazard
Avoidance**

Sec 5
Additional
Features

Sec 6
Annun.
& Alerts

Sec 7
Symbols

Sec 8
Glossary

Appendix A

Appendix B
Index

IR SAT Data Viewing Range

The IR SAT Data Viewing Range option allows you to select the map range where at and below that value IR SAT weather products will be shown on the selected MFD Wx Data Link Map page (1, 2, or 3). When Off is selected, IR SAT will not be shown. In the figure below where 200 NM is selected, IR SAT data will be shown at map ranges of 200 NM and lower.



Figure 4-99 GFDS IR SAT Viewing Range Selection

- 1) While viewing a WX Data Link Map page of the WX page group, press the **MENU** key to display the Page Menu Options. Turn the large **MFD** knob to highlight the Weather Setup option and press **ENT**.
- 2) Turn the large **MFD** knob to highlight IR SAT Data Viewing Range. Turn the small **MFD** knob to highlight the desired value.
- 3) Turn the small **MFD** knob to highlight the desired value. Press **ENT** to accept the displayed value. The next option will be highlighted.
- 4) Press the small **MFD** knob to cancel selection or to end editing and return to the WX page or turn the large **MFD** knob to the next option.

Foreword

Sec 1
System

Sec 2
PFD

Sec 3
MFD

Sec 4
Hazard
Avoidance

Sec 5
Additional
Features

Sec 6
Annun.
& Alerts

Sec 7
Symbols

Sec 8
Glossary

Appendix A

Appendix B
Index

4.10.9 Data Link Lightning (DL LTNG) Data Viewing Range

Lightning data shows the approximate location of cloud-to-ground lightning strikes. A strike icon represents a strike that has occurred within a two-kilometer region. The exact location of the lightning strike is not displayed. Only cloud to ground strikes are reported in the US and extreme southern Canada (cloud to cloud strikes are not reported).



Figure 4-100 GFDSD Data Link Lightning and Legend

Foreword

Sec 1 System

Sec 2 PFD

Sec 3 MFD

Sec 4 Hazard Avoidance

Sec 5 Additional Features

Sec 6 Annun. & Alerts

Sec 7 Symbols

Sec 8 Glossary

Appendix A

Appendix B Index

Data Link Lightning Data Viewing Range

The Lightning Data Viewing Range option allows you to select the map range where at and below that value Lightning weather products will be shown on the selected MFD Wx Data Link Map page (1, 2, or 3). When Off is selected, Lightning will not be shown. In the figure above where 300 NM is selected, GFDS data will be shown at map ranges of 300 NM and lower.

- 1) While viewing a WX Data Link Map page of the WX page group, press the **MENU** key to display the Page Menu Options. Turn the large **MFD** knob to highlight the Weather Setup option and press **ENT**.
- 2) Turn the large **MFD** knob to highlight DL LTNG Data Viewing Range.
- 3) Turn the small **MFD** knob to highlight the desired value. Press **ENT** to accept the displayed value. The next option will be highlighted.



Figure 4-101 GFDS Lightning Viewing Range Selection

- 4) Press the small **MFD** knob to cancel selection or to end editing and return to the WX page or turn the large **MFD** knob to the next option.

4.10.10 SIGMETs and AIRMETs (SIG/AIR)

SIGMETs (SIGNificant METeorological Information) and AIRMETs (AIRMen's METeorological Information) are broadcast for potentially hazardous weather considered of importance to aircraft. A Convective SIGMET is issued for hazardous convective weather. A localized SIGMET is a significant weather condition occurring at a localized geographical position.

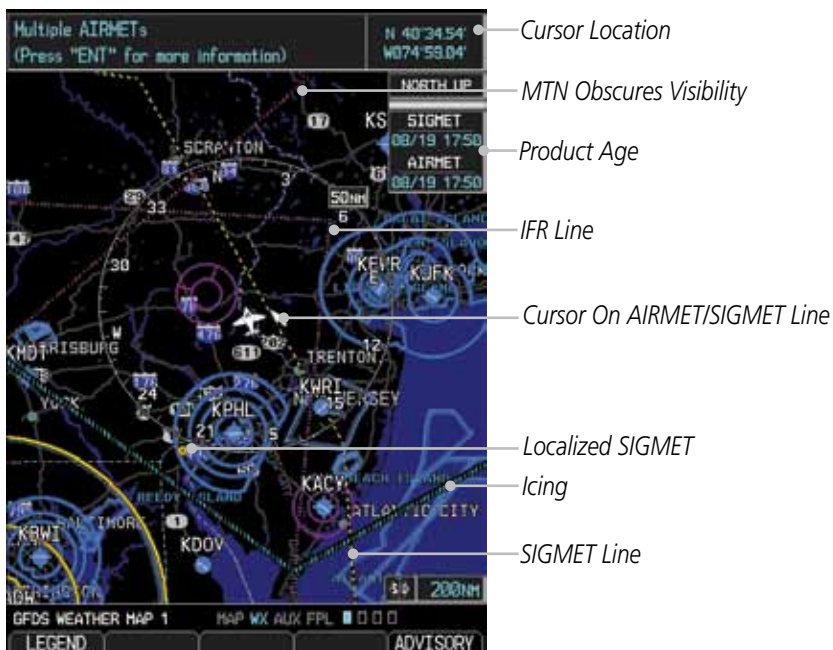

Figure 4-102 GFDS Weather Page - AIRMETs/SIGMETs

When enabled, SIGMET/AIRMETs advise the pilot of potentially hazardous weather to all aircraft. SIGMET/AIRMET data covers icing, turbulence, dust, and volcanic ash as issued by the National Weather Service. The update rate is every 12 minutes in the U.S. Elsewhere, updates are made as they are issued.

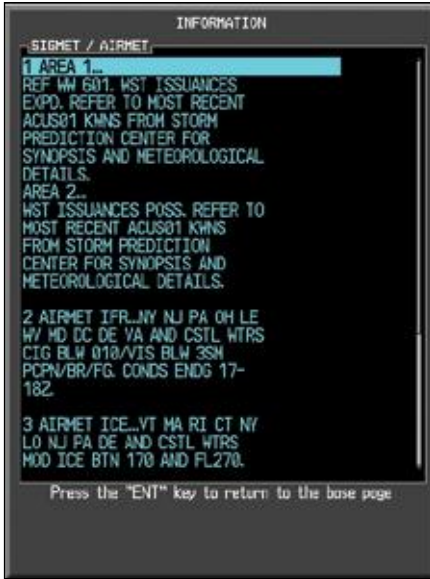

Figure 4-103 GFDS Weather - AIRMETS/SIGMETs Detail and Legend

When enabled, the following AIRMETS are available for display:

- Icing
- Turbulence
- IFR conditions
- Mountain obscuration
- Surface winds

SIGMET/AIRMET Viewing Range

The SIGMET/AIRMET Viewing Range option allows you to select the map range where at and below that value SIGMET/AIRMET products will be shown on the selected MFD Wx Data Link Map page (1, 2, or 3). When Off is selected, SIGMET/AIRMET will not be shown. In the figure below where 300 NM is selected, SIGMET/AIRMET data will be shown at map ranges of 300 NM and lower.



Figure 4-104 GFDS SIG/AIR Viewing Range Selection

- 1) While viewing a WX Data Link Map page of the WX page group, press the **MENU** key to display the Page Menu Options. Turn the large **MFD** knob to highlight the Weather Setup option and press **ENT**.
- 2) Turn the large **MFD** knob to highlight SIG/AIR Viewing Range.
- 3) Turn the small **MFD** knob to highlight the desired value. Press **ENT** to accept the displayed value. The next option will be highlighted.
- 4) Press the small **MFD** knob to cancel selection or to end editing and return to the WX page or turn the large **MFD** knob to the next option.

Foreword
 Sec 1 System
 Sec 2 PFD
 Sec 3 MFD
Sec 4 Hazard Avoidance
 Sec 5 Additional Features
 Sec 6 Annun. & Alerts
 Sec 7 Symbols
 Sec 8 Glossary
 Appendix A
 Appendix B Index

4.10.11 METARs



NOTE: Atmospheric pressure reported for METARs is given in hectopascals (hPa), except in the United States, where it is reported in inches of mercury (in Hg). Temperatures are reported in Celsius.



NOTE: METAR information is only displayed within the installed aviation database service area.

METAR (METEorological Aerodrome Report), known as an Aviation Routine Weather Report, is the standard format for current weather observations. METARs are generally updated hourly, but some sites are more frequent. Special updates are done as conditions warrant. METARs typically contain information about the temperature, dew point, wind, precipitation, cloud cover, cloud heights, visibility, and barometric pressure. They can also contain information on precipitation amounts, lightning, and other critical data. METARs are shown as colored flags at airports that provide them.



- Cursor Location
- Product Age
- Selected METAR (VFR)
- MVFR METAR

Figure 4-105 GFDs Weather - Graphic METARs and Legend

Foreword

Sec 1
System

Sec 2
PFD

Sec 3
MFD

Sec 4
Hazard
Avoidance

Sec 5
Additional
Features

Sec 6
Annun.
& Alerts

Sec 7
Symbols

Sec 8
Glossary

Appendix A

Appendix B
Index

METAR Viewing Range

The METAR Viewing Range option allows you to select the map range where at and below that value METAR weather products will be shown on the selected MFD Wx Data Link Map page (1, 2, or 3). When Off is selected, METARs will not be shown. In the figure below where 150 NM is selected, METAR data will be shown at map ranges of 150 NM and lower.



Figure 4-106 METAR Viewing Range Selection

- 1) While viewing a WX Data Link Map page of the WX page group, press the **MENU** key to display the Page Menu Options. Turn the large **MFD** knob to highlight the Weather Setup option and press **ENT**.
- 2) Turn the large **MFD** knob to highlight METAR Data Viewing Range.
- 3) Turn the small **MFD** knob to highlight the desired value. Press **ENT** to accept the displayed value. The next option will be highlighted.
- 4) Press the small **MFD** knob to cancel selection or to end editing and return to the WX page or turn the large **MFD** knob to the next option.

4.10.12 Winds Aloft

Winds Aloft data shows the forecast wind speed and direction at the surface and at selected altitudes. Altitudes can be selected in 3000 foot increments from the surface up to 42,000 feet MSL. Pressing the **WIND DOWN** or **WIND UP** soft keys steps down or up in 3,000 foot increments.

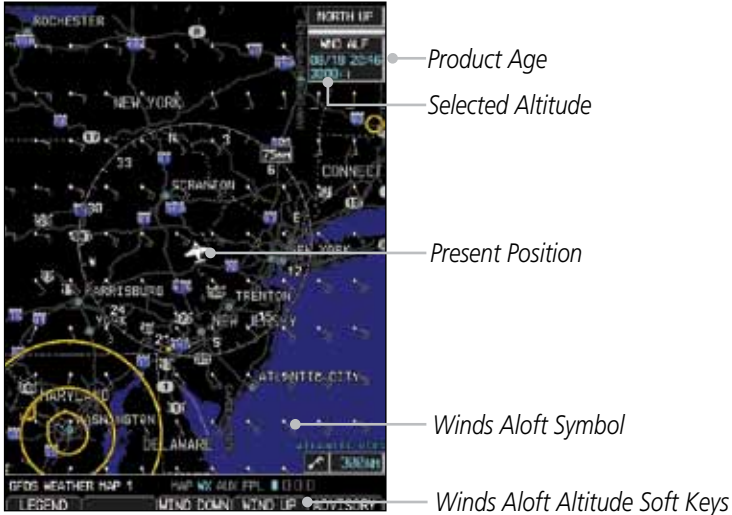

Figure 4-107 GFDS Weather - Winds Aloft



Figure 4-108 GFDS Weather - Winds Aloft Legend

Foreword

System Sec 1

PFD Sec 2

MFD Sec 3

Avoidance Sec 4

Additional Features Sec 5

Annun. & Alerts Sec 6

Symbols Sec 7

Glossary Sec 8

Appendix A

Appendix B Index

Winds Aloft Data Viewing Range

The Winds Aloft Data Viewing Range option allows you to select the map range where at and below that value Winds Aloft weather products will appear on the selected MFD Wx Data Link Map page (1, 2, or 3). When Off is selected, Winds Aloft will not be shown. In the figure below where 150 NM is selected, Winds Aloft data will be shown at map ranges of 150 NM and lower.



Figure 4-109 Winds Aloft Data Viewing Range Selection

- 1) While viewing a WX Data Link Map page of the WX page group, press the **MENU** key to display the Page Menu Options. Turn the large **MFD** knob to highlight the Weather Setup option and press **ENT**.
- 2) Turn the large **MFD** knob to highlight Winds Aloft Data Viewing Range.
- 3) Turn the small **MFD** knob to highlight the desired value. Press **ENT** to accept the displayed value. The next option will be highlighted.
- 4) Press the small **MFD** knob to cancel selection or to end editing and return to the WX page or turn the large **MFD** knob to the next option.

Winds Aloft Altitude

The Winds Aloft Altitude option allows you to select the altitude where Winds Aloft weather products will be shown on the selected MFD Wx Data Link Map page (1, 2, or 3). Altitude can be selected in 3000 foot increments from the surface up to 42,000 feet MSL.

Pressing the **WIND DOWN** or **WIND UP** soft keys steps down or up in the 3,000 foot increments. In the figure below where 6000 feet is selected, Winds Aloft data will be shown for winds reported at an altitude of 6000 feet.

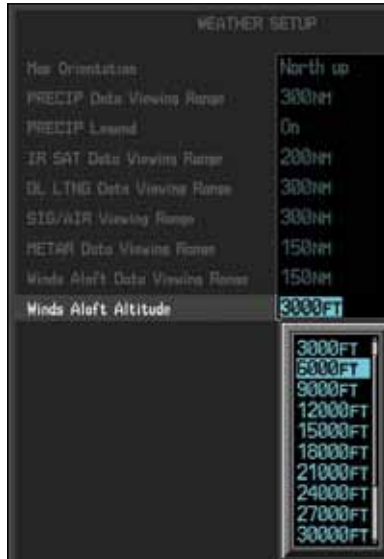

Figure 4-110 Winds Aloft Altitude Selection

- 1) While viewing a WX Data Link Map page of the WX page group, press the **MENU** key to display the Page Menu Options. Turn the large **MFD** knob to display the Weather Setup option and press **ENT**.
- 2) Turn the large **MFD** knob to highlight Winds Aloft Altitude Viewing Range.
- 3) Turn the small **MFD** knob to highlight the desired value. Press **ENT** to accept the displayed value. The next option will be highlighted.
- 4) Press the small **MFD** knob to cancel selection or to end editing and return to the WX page or turn the large **MFD** knob to the next option.

Foreword

Sec 1
System

Sec 2
PFD

Sec 3
MFD

**Sec 4
Hazard
Avoidance**

Sec 5
Additional
Features

Sec 6
Annun.
& Alerts

Sec 7
Symbols

Sec 8
Glossary

Appendix A

Appendix B
Index

This page intentionally left blank

5 ADDITIONAL FEATURES (OPTIONAL)

Foreword

System Sec 1

Sec 2 PFD

Sec 3 MFD

Sec 4 Hazard Avoidance

Sec 5 Additional Features

Sec 6 Annun. & Alerts

Sec 7 Symbols

Sec 8 Glossary

Appendix A

Appendix B Index



NOTE: The availability of SafeTaxi, ChartView, or FliteCharts in electronic form may not preclude the requirement to carry paper charts aboard the aircraft. See the AFMS for more information.



NOTE: ChartView is an optional feature that requires enablement by a Garmin dealer.

Additional features of the GDU 620 include the following:

- ChartView and FliteCharts® electronic charts
- SafeTaxi® diagrams
- Sirius XM Satellite Radio entertainment
- XM WX Satellite Weather (covered in Section 4.7)
- Traffic (covered in Sections 4.5 and 4.6)
- Garmin Synthetic Vision Technology (SVT™)

The optional ChartView and FliteCharts provide on-board electronic terminal procedures charts. Electronic charts offer the convenience of rapid access to essential information. Either ChartView or FliteCharts may be configured in the system, but not both.

SafeTaxi diagrams provide detailed taxiway, runway, and ramp information at more than 700 airports in the United States. By decreasing the range on an airport that has a SafeTaxi diagram available, a close up view of the airport layout can be seen.

The optional Sirius XM Satellite Radio entertainment audio feature of the GDL 69A Data Link Receiver handles more than 170 channels of music, news, and sports. Sirius XM Satellite Radio offers more entertainment choices and longer range coverage than commercial broadcast stations.

XM WX Satellite Weather is an optional service that provides the ability to display graphic weather data overlaid on the MFD Nav Map and Weather Data Link pages.

The Traffic Map Page shows surrounding TAS or TIS traffic data in relation to the aircraft's current position and altitude. The Traffic option is designed to assist in detection and avoidance of other aircraft.

The optional Garmin Synthetic Vision Technology (SVT™) is a visual enhancement to the G500. SVT is displayed as a forward-looking display of the topography immediately in front of the aircraft. SVT information is shown on the primary flight display (PFD).

5.1 Viewing Charts

When the Chart function is available, charts will be shown on the third page of the Flight Plan page group. The chart page will default to the nearest airport if no flight plan or destination airport is present. While you are on the ground, the displayed charts will default to the current airport location regardless of flight plan.



NOTE: The chart for the destination airport or loaded approach will automatically be selected.



Figure 5-1 ChartView Chart Page



Figure 5-2 FliteChart Chart Page

- 1) Turn the large **MFD** knob to the Flight Plan (FPL) page group.
- 2) Turn the small **MFD** knob to the Charts page.

5.1.1 Chart Panning

More detail on the displayed chart can be viewed by zooming in with the Range keys and moving the chart around with pan mode.





NOTE: Panning mode is indicated by the presence of scroll bars.



Vertical Scroll Bar

Horizontal Scroll Bar

Figure 5-3 Zooming and Scrolling Around a Chart

- 1) While viewing the Charts page of the FPL page group, press the **RNG** (Range)   keys to zoom in and out.
- 2) After zooming in, you may only see part of the chart. Press the small **MFD** knob to enter Pan mode and activate scroll bars on the edges of the chart. Turn the large and small **MFD** knobs to move around the chart.
- 3) Press the small **MFD** knob to cancel the scroll bars and exit panning.

5.1.2 Choosing a Chart for the Current Airport



NOTE: The chart for the destination airport or loaded approach will automatically be selected.

- 1) While viewing the Charts page of the FPL page group, press the **SELECT** soft key to activate chart selection.
- 2) Turn the large **MFD** knob to highlight the field to the right of the airport identifier.
- 3) Turn the small **MFD** knob to highlight the desired chart.



Figure 5-4 Activate Chart Selection for the Current Airport (ChartView shown)

Foreword
 Sec 1 System
 Sec 2 PFD
 Sec 3 MFD
 Sec 4 Hazard Avoidance
 Sec 5 Additional Features
 Sec 6 Annun. & Alerts
 Sec 7 Symbols
 Sec 8 Glossary
 Appendix A
 Appendix B Index

4) Press **ENT** to accept and view the selected chart.

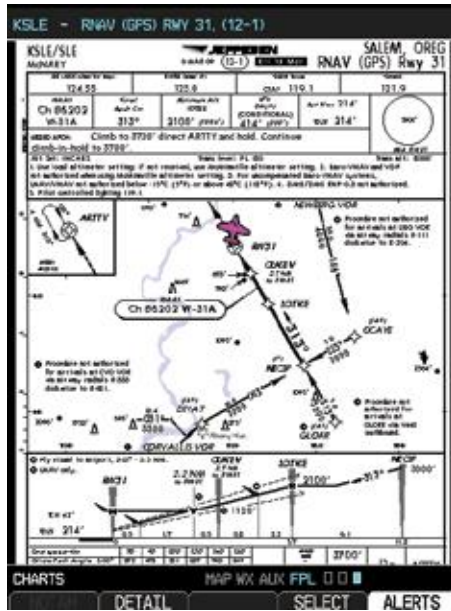

Figure 5-5 Selected Chart for the Current Airport (ChartView shown)

5) Press the **Select** key to choose another chart. Press the **Back** key to return to the view of the full chart.

Foreword

Sec 1
System

Sec 2
PFD

Sec 3
MFD

Sec 4
Hazard
Avoidance

Sec 5
Additional
Features

Sec 6
Annun.
& Alerts

Sec 7
Symbols

Sec 8
Glossary

Appendix A

Appendix B
Index

5.1.3 Selecting a Chart by Identifier

A chart for a different airport may be chosen by selecting the identifier for the desired airport.

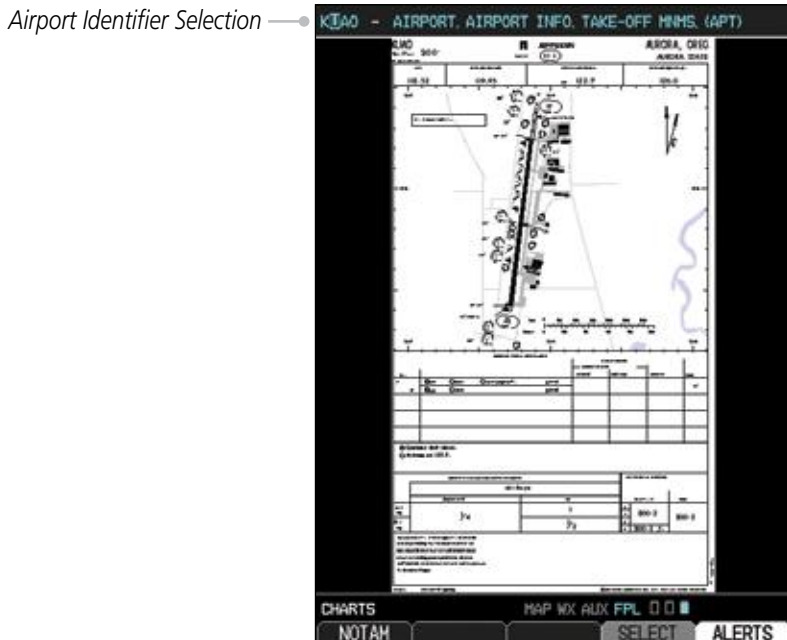

Figure 5-6 Airport Identifier Selection

- 1) While viewing the Charts page of the FPL page group, press the **SELECT** soft key to change the airport.
- 2) Use the large **MFD** knob to move the cursor to highlight a character.
- 3) Use the small **MFD** knob to change the character.
- 4) Press **ENT** to accept the selected airport.

5.1.4 Selecting a New Chart by FPL, NRST, or RECENT

You may select other charts to display based on your flight plan (FPL), charts of the nearest airport (NRST), or your most recently selected airports (RECENT).



Figure 5-7 Chart Category Selection

- 1) While viewing the Charts page of the FPL page group, press the **SELECT** soft key.
- 2) Turn the small **MFD** knob counterclockwise.
- 3) Turn the small **MFD** knob counterclockwise to show FPL, NRST, or RECENT.
- 4) Turn the large **MFD** knob to select the desired identifier and then press **ENT**.

5.1.5 Charts Menu Selections

- 1) In the FPL page group, turn the small **MFD** knob to reach the Charts page.
- 2) Press **MENU** to display the Options menu.



Figure 5-8 Chart Menu Selections

- 3) Turn the large **MFD** knob to select the desired item and then press **ENT**.

5.1.5.1 Setting the Altitude Minimums Alerter

- 1) While viewing the Charts Page of the FPL page group, press the **Menu** key. With the Set Minimums item highlighted, press **ENT**.
- 2) With the Minimums Source highlighted, select the Altitude Minimums Alerter source with small **MFD** knob.



Figure 5-9 Barometric Minimums Source Selection

- 3) Turn the large **MFD** knob to highlight the Altitude Minimums value. Turn the large and small **MFD** knobs to change the Altitude Minimums value and then press **ENT** to activate the selected value.



Figure 5-10 Barometric Minimums Altitude Selection

Alerting is inhibited while the aircraft is on the ground and until the aircraft reaches 150 feet above the MDA. The Minimum altitude will be available in the Altitude Alerter.

In dual installations, the minimums alerting altitude value may be set from either GDU 620 and will be synchronized on both units.



NOTE: If you highlight the Minimums Altitude field on the FPL page and press the CLR key, it will turn the minimums functionality off.

5.1.5.2 Viewing Chart NOTAMs

If an active NOTAM (Notice to Airmen) exists for the selected chart, the **NOTAM** soft key will be available. Press the **NOTAM** soft key to view the NOTAM or select View NOTAMs from the Chart Options Menu.



Figure 5-11 Chart NOTAM

5.1.5.3 Day/Night View

The Chart pages can be displayed on a white or black background for day or night viewing. The Day View offers a better presentation in a bright environment. The Night View gives a better presentation for viewing in a dark environment. When the CHART SETUP Box is selected the GDU 620 soft keys are blank.

- 1) In the FPL page group, turn the small **MFD** knob to reach the Charts page.
- 2) Press **MENU** to display the Options menu.
- 3) Press **ENT** to go to Chart Setup. The Color Scheme option will be highlighted.
- 4) Turn the small **MFD** knob to select Day - Auto - Night.

- 5) Press the small **MFD** knob or the **ENT** key to save the selected value and return to the Charts page.



NOTE: *Once an adjustment is made to the percentage field in Auto mode, the chart must be redrawn (zoomed in or out, or another chart selected) before the switch from Day to Night is seen.*

5.2 ChartView (Optional)

ChartView resembles the paper version of Jeppesen terminal procedures charts. The charts are displayed in full color with high-resolution. The MFD depiction shows the aircraft position on the moving map in the plan view of approach charts and on airport diagrams.

The ChartView database subscription is available from Jeppesen, Inc. ChartView is an optional feature that requires enablement by a Garmin dealer.

Available data includes:

- Arrivals (STAR)
- Departure Procedures (DP)
- Approaches
- Airport Diagrams
- Chart NOTAMs

Foreword

Sec 1 System

Sec 2 PFD

Sec 3 MFD

Sec 4 Hazard Avoidance

Sec 5 Additional Features

Sec 6 Annun. & Alerts

Sec 7 Symbols







Sec 8 Glossary

Appendix A

Appendix B Index

5.2.1 Cycle Number and Revision

The ChartView database is revised every 14 days. Charts are still viewable during a period that extends from the cycle expiration date to the disables date. ChartView is disabled 70 days after the expiration date and is no longer available for viewing upon reaching the disable date. When turning on the GDU 620, the Power-up Page indicates any of nine different possible criteria for ChartView availability. See the table below for the various ChartView Power-up Page displays and the definition of each.

Power-up Page Display	Definition
	Blank Line. GDU 620 system is not configured for ChartView. Contact a Garmin-authorized service center for configuration.
	System is configured for ChartView but no chart database is installed. Contact Jeppesen for a ChartView database.
	Normal operation. ChartView database is valid and within current cycle.
	ChartView database is within 1 week after expiration date. A new cycle is available for update.
	ChartView database is beyond 1 week after expiration date, but still within the 70 day viewing period.
	ChartView database has timed out. Database is beyond 70 days after expiration date. ChartView database is no longer available for viewing.



Power-up Page Display		Definition
Foreword	 Verify chart database cycle.	System time is not available. GPS satellite data is unknown or the GPS navigator has not yet locked onto satellites. Check database cycle number for effectivity.
Sec 1 System	 Verifying Chart data	System is verifying chart database when new cycle is installed for the first time.
Sec 2 PFD	 Chart Data is Corrupt!	After verifying, chart database is found to be corrupt. ChartView will not be available.
Sec 3 MFD		

Table 5-1 Power-up Page Annunciations and Definitions

The ChartView time critical information can also be found on the AUX - System Status page. The database CYCLE number, EXPIRES, and DISABLES dates of the ChartView database appear in either blue or yellow text. When the ChartView EXPIRES date is reached, ChartView becomes inoperative 70 days later. This is shown as the DISABLES date. When the DISABLES date is reached, charts are no longer available for viewing.

Select the **DBASE** soft key for scrolling through the database information. Scroll through the database with the **MFD** knob or **ENT** key.

The ChartView database is provided directly from Jeppesen. ChartView is an optional feature that requires enablement by a Garmin dealer. Refer to Jeppesen Databases in Appendix A for instructions on revising the ChartView database.

Foreword

Sec 1
System

Sec 2
PFD

Sec 3
MFD

Sec 4
Hazard
Avoidance

Sec 5
Additional
Features

Sec 6
Annun.
& Alerts

Sec 7
Symbols

Sec 8
Glossary

Appendix A

Appendix B
Index

5.2.2 Viewing Chart Details in ChartView



NOTE: The chart for the destination airport or loaded approach will automatically be selected.



NOTE: Chart details are only available for instrument approach procedure charts. Chart details are not available for airport diagrams or SID/STAR charts.

- 1) While viewing the Charts page of the FPL page group, press the **SELECT** soft key to activate chart selection.
- 2) Turn the large **MFD** knob to highlight the field to the right of the airport identifier.
- 3) Turn the small **MFD** knob to highlight the desired chart.



Figure 5-12 Activate Chart Selection for the Current Airport (ChartView shown)

Foreword

Sec 1
System

Sec 2
PFD

Sec 3
MFD

Sec 4
Hazard
Avoidance

Sec 5
Additional
Features

Sec 6
Annun.
& Alerts

Sec 7
Symbols

Sec 8
Glossary

Appendix A

Appendix B
Index

4) Press **ENT** to accept and view the selected chart.

Foreword
 Sec 1 System
 Sec 2 PFD
 Sec 3 MFD
 Sec 4 Hazard Avoidance

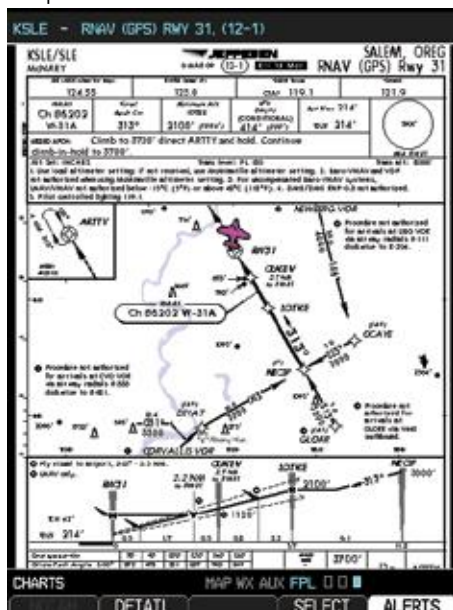

Figure 5-13 Selected Chart for the Current Airport (ChartView shown)

5) Press the **Detail** key to view detailed views of the current chart. The **Detail** key is only available with ChartView.

Sec 5 Additional Features
 Sec 6 Annun. & Alerts
 Sec 7 Symbols
 Sec 8 Glossary
 Appendix A
 Appendix B Index



Figure 5-14 Detail of the Selected Chart (Header Shown)

- 6) Press the **Header**, **Plan**, **Profile**, or **Minimums** keys to view detailed sections for the chart for those topics. A aircraft icon will show in the lower right corner of the display if your aircraft is in the chart area. The icon will have an “x” through it if the aircraft is not in the chart area or the GPS fix is lost.



- 7) Press the **Back** key to return to the view of the full chart.

5.3 FliteCharts®

FliteCharts® resemble the paper version of FAA-published terminal procedures charts. The charts are displayed with high-resolution and in color for applicable charts.

FliteCharts database subscription is available from Garmin. Available data includes:

- Arrivals (STAR)
- Departure Procedures (DP)
- Approaches
- Airport Diagrams

5.3.1 Cycle Number and Revision

FliteCharts data is revised every 28 days. Charts are still viewable during a period that extends from the cycle expiration date to the disables date. FliteCharts is disabled 180 days after the expiration date and are no longer available for viewing upon reaching the disables date. When turning on the GDU 620, the Power-up page indicates any of five different possible criteria for chart availability. These indications are whether the databases are not configured, not available, current, out of date, or disabled. See the table below for the various FliteCharts Power-up page displays and the definition of each.

- Foreword
- Sec 1 System
- Sec 2 PFD
- Sec 3 MFD
- Sec 4 Hazard Avoidance
- Sec 5 Additional Features
- Sec 6 Annun. & Alerts
- Sec 7 Symbols
- Sec 8 Glossary
- Appendix A
- Appendix B Index





Power-up Page Display	Definition
	Blank Line. G500 system is not configured for FliteCharts. Contact a Garmin-authorized service center for configuration.
	System is configured for FliteCharts but no chart database is installed. Refer to Updating Garmin Databases in Appendix A for the FliteCharts database.
	Normal operation. FliteCharts database is valid and within current cycle.
	FliteCharts database is beyond the expiration date, but still within the 180 day viewing period.
	FliteCharts database has timed out. Database is beyond 180 days after expiration date. FliteCharts database is no longer available for viewing.

Table 5-2 FliteCharts Power-up Page Annunciations and Definitions

Foreword

Sec 1
System

Sec 2
PFD

Sec 3
MFD

Sec 4
Hazard
Avoidance

Sec 5
Additional
Features

Sec 6
Annun.
& Alerts

Sec 7
Symbols

Sec 8
Glossary

Appendix A

Appendix B
Index

5.4 SafeTaxi®

SafeTaxi® is an enhanced feature that gives greater map detail when zooming in on airports at close range. The airport display on the map reveals runways with numbers, taxiways with identifying letters/numbers, airport Hot Spots, and airport landmarks including ramps, buildings, control towers, and other prominent features. Resolution is greater at lower map ranges. When the aircraft location is within the screen boundary, including within SafeTaxi ranges, an aircraft symbol is shown on any of the navigation map views for enhanced position awareness.

Designated Hot Spots are recognized at airports with many intersecting taxiways and runways, and/or complex ramp areas. Airport Hot Spots are outlined to caution pilots of areas on an airport surface where positional awareness confusion or runway incursions happen most often. Hot Spots are defined with a magenta circle or outline around the region of possible confusion.

Foreword
 Sec 1 System
 Sec 2 PFD
 Sec 3 MFD
 Sec 4 Hazard Avoidance
 Sec 5 Additional Features
 Sec 6 Annun. & Alerts
 Sec 7 Symbols
 Sec 8 Glossary
 Appendix A
 Appendix B Index

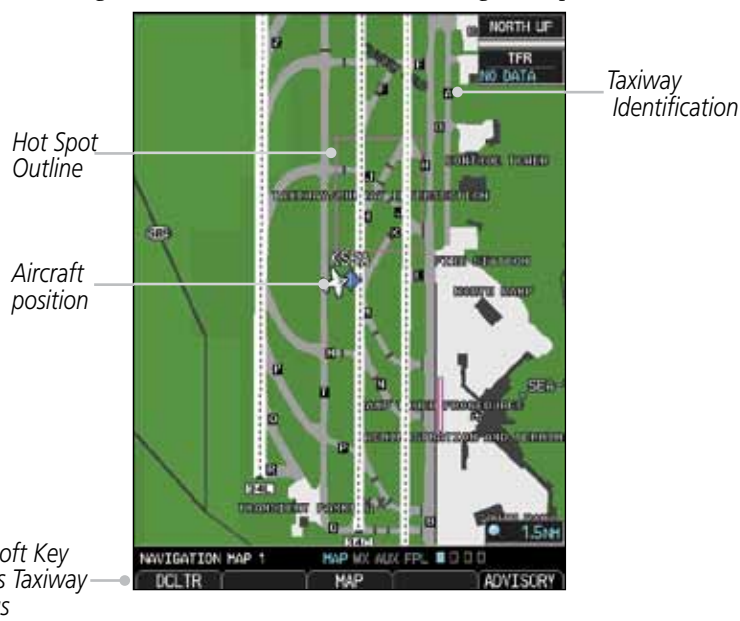

Figure 5-15 SafeTaxi Depiction on the Navigation Map Page

NOTE: Do not use SafeTaxi or Chartview functions as the basis for ground maneuvering. SafeTaxi and Chartview functions do not comply with the requirements of AC 20-159 and are not qualified to be used as an airport moving map display (AMMD). SafeTaxi and Chartview are to be used by the flight crew to orient themselves on the airport surface to improve pilot situational awareness during ground operations.

5.4.1 Using SafeTaxi®

Any map page that displays the navigation view can also show the SafeTaxi® airport layout within the maximum configured range. The following is a list of pages where the SafeTaxi feature can be seen:

- Navigation Map Page
- Weather Datalink Page
- Airport Information Page
- Intersection Information Page
- NDB Information Page
- VOR Information Page
- User Waypoint Information Page

During ground operations the aircraft's position is displayed in reference to taxiways, runways, and airport features. When panning over the airport, features such as runway holding lines and taxiways are shown.

5.4.1.1 Decluttering

The **DCLTR** soft key (declutter) label advances to DCLTR-1, DCLTR -2, and DCLTR-3 each time the soft key is selected for easy recognition of decluttering level. Selecting the **DCLTR** soft key removes the taxiway markings and airport feature labels. Selecting the **DCLTR-1** soft key removes VOR station ID, the VOR symbol, and intersection names if within the airport plan view. Selecting the **DCLTR-2** soft key removes the airport runway layout, unless the airport in view is part of an active route structure. Pressing the **DCLTR-3** soft key cycles back to the original map detail. With Auto-Zoom enabled, the map will automatically zoom to 1 NM and DCLTR-0 upon landing so SafeTaxi can be viewed. Refer to Map Declutter Levels in the Navigation Map Section.

5.4.1.2 Hot Spot Information

Hot Spots can contain more information about the area that can be displayed when selected.

1. While viewing the Hot Spot area on the Navigation Map page, press the small **MFD** knob to activate the cursor.
2. Turn the **MFD** knobs to move the cursor on the Hot Spot border or into the Hot Spot area and then press the **ENT** key.

Foreword

Sec 1
SystemSec 2
PFDSec 3
MFDSec 4
Hazard
AvoidanceSec 5
Additional
FeaturesSec 6
Annun.
& AlertsSec 7
SymbolsSec 8
Glossary

Appendix A

Appendix B
Index

Foreword
 Sec 1 System
 Sec 2 PFD
 Sec 3 MFD
 Sec 4 Hazard Avoidance
 Sec 5 Additional Features
 Sec 6 Annun. & Alerts
 Sec 7 Symbols
 Sec 8 Glossary
 Appendix A
 Appendix B Index

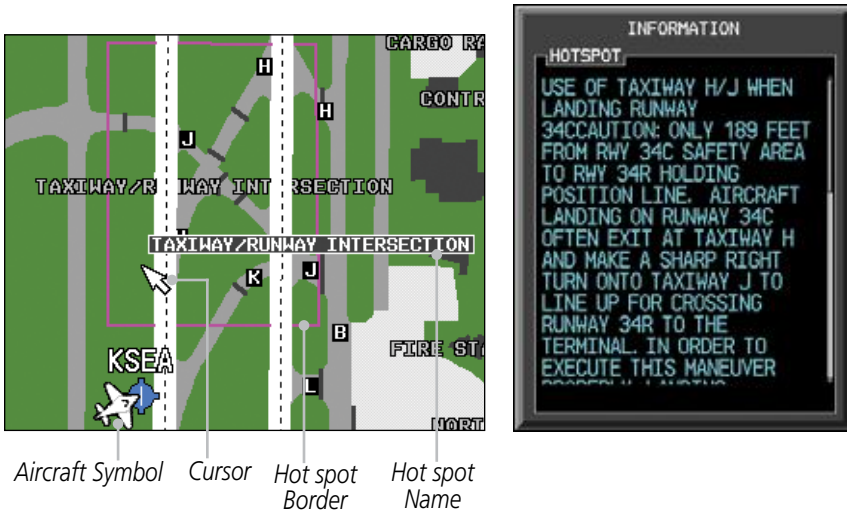

Figure 5-16 SafeTaxi Hot Spot Information

- An information window will be shown on the MFD. After viewing, press the small **MFD** knob, **CLR**, or **ENT** keys to remove the information window. Press the small **MFD** knob again to cancel the cursor.

5.4.2 SafeTaxi® Cycle Number and Revision

The SafeTaxi database is revised every 56 days. SafeTaxi is always available for use after the expiration date. When turning on the GDU 620, the Power-up Page indicates whether the databases are current, out of date, or not available. The Power-up Page shows the SafeTaxi database is current when the “SafeTaxi Expires” date is shown in white. When the SafeTaxi cycle has expired, the “SafeTaxi Expires” date appears in yellow. The message “SafeTaxi: N/A” appears in white if no SafeTaxi data is available on the database card.



SafeTaxi Database is Current



SafeTaxi Database has Expired



SafeTaxi Database Not Available

Figure 5-17 Power-up Page, SafeTaxi Database

The SafeTaxi Region, Version, Cycle, Effective date and Expires date of the database cycle can also be found on the AUX - System Status page. SafeTaxi information appears in white and yellow text. The EFFECTIVE date appears in white when data is current and in yellow when the current date is before the effective date. The EXPIRES date appears in white when data is current and in yellow when expired. SafeTaxi REGION NOT AVAILABLE appears in white if SafeTaxi data is not available on the database card. Expired SafeTaxi data is never disabled.

Foreword

Sec 1
System

Sec 2
PFD

Sec 3
MFD

Sec 4
Hazard
Avoidance

Sec 5
Additional
Features

Sec 6
Annun.
& Alerts

Sec 7
Symbols

Sec 8
Glossary

Appendix A

Appendix B
Index

5.5 Sirius XM Satellite Radio Entertainment



NOTE: Refer to the Hazard Avoidance Section for information about XM WX Satellite Weather products.

The optional Sirius XM Satellite Radio entertainment feature of the GDL 69A Data Link Receiver is available for the pilot's and passengers' enjoyment. The GDL 69A can receive Sirius XM Satellite Radio entertainment services at any altitude throughout the Continental U.S. Entertainment audio is not available on the GDL 69 Data Link Receiver.

Sirius XM Satellite Radio offers a variety of radio programming over long distances without having to constantly search for new stations. Based on signals from satellites, coverage far exceeds land-based transmissions. Sirius XM Satellite Radio services are subscription-based. For more information on specific service packages, visit <http://www.garmin.com/xm/>.

5.5.1 Activating Sirius XM Satellite Radio Services

The service is activated by providing Sirius XM Satellite Radio with either one or two coded IDs, depending on the equipment. Either the Audio Radio ID or the Data Radio ID, or both, must be provided to Sirius XM Satellite Radio to activate the entertainment subscription. The Sirius XM Satellite Radio Activation Instructions are included with the unit (also available at www.garmin.com, P/N 190-00355-04).

Sirius XM Satellite Radio and XM WX Satellite Weather subscriptions are sold separately. It is not required to activate both the entertainment and weather service subscriptions with the GDL 69A. Either or both services can be activated. Sirius XM Satellite Radio uses one or both of the coded IDs to send an activation signal that, when received by the GDL 69A, allows it to play entertainment programming.

These IDs are located:

- On the label on the back of the Data Link Receiver
- On the XM Information Page on the MFD

Contact the installer if the Data Radio ID and the Audio Radio ID cannot be located.



NOTE: The **LOCK** soft key on the XM Information Page (Auxiliary Page Group) is used to save GDL 69A activation data when the Sirius XM Satellite Radio services are initially set up. It is not used during normal Sirius XM Satellite Radio operation, but there should be no adverse effects if inadvertently selected during flight. Refer to the GDL 69/69A Sirius XM Satellite Radio Activation Instructions (190-00355-04, Rev G, or later) for further information.

If XM WX Satellite weather services have not been activated, all the weather product boxes are cleared on the XM Information Page and a yellow Activation Required message is displayed in the center of the Weather Data Link Page (Map Page Group). The Service Class refers to the groupings of weather products available for subscription.

Foreword

Sec 1
System

Sec 2
PFD

Sec 3
MFD

Sec 4
Hazard
Avoidance

Sec 5
Additional
Features

Sec 6
Annun.
& Alerts

Sec 7
Symbols

Sec 8
Glossary

Appendix A

Appendix B
Index

5.5.2 Sirius XM Satellite Radio Information

The Aux mode XM Information page displays information about the Sirius XM Satellite radios, service class, and products when the GDL 69/69A is installed and the Sirius XM Satellite Radio service is activated. The Data and Audio radios have separate Identification Numbers. The Service Class determines the features that are available. The Weather Products window shows the products with a subscription. The boxes for products not in your subscription will be hollow.



Figure 5-18 Sirius XM Satellite Radio Information

- 1) In the AUX page group, turn the small **MFD** knob to display Sirius XM Satellite Radio Information.
- 2) The **LOCK** soft key is used to “lock” your XM subscription activation. This is only used for the initial subscription or to make a change.

NOTE: Refer to the *GDL 69/69A Sirius XM Satellite Radio Activation Instructions (190-00355-04, Rev G, or later)* for further information.



5.5.3 Sirius XM Satellite Radio Entertainment Radio

Audio entertainment is available through the Sirius XM Satellite Radio Service when activated in the optional installation of the GDL 69A. The GDU 620 serves as the display and control head for your remotely mounted GDL 69A. Sirius XM Satellite Radio allows you to enjoy a variety of radio programming over long distances without having to constantly search for new stations. Based on signal from satellites, coverage far exceeds land-based transmissions. When enabled, the Sirius XM Satellite Radio audio entertainment is accessible in Aux page group.

The information on the Sirius XM Satellite Radio display is composed of four areas: the Active Channel, Available Channels, Category of the highlighted channel, and the Volume setting. The Active Channel window shows the Channel Name and Number, Artist, Song Title, and Category.

- 1) Turn the large **MFD** knob to Aux Mode.
- 2) Turn the small **MFD** knob to the XM Radio page.



Figure 5-19 Sirius XM Satellite Radio

Foreword
 Sec 1 System
 Sec 2 PFD
 Sec 3 MFD
 Sec 4 Hazard Avoidance
 Sec 5 Additional Features
 Sec 6 Annun. & Alerts
 Sec 7 Symbols
 Sec 8 Glossary
 Appendix A
 Appendix B Index

5.5.3.1 Channel Categories

The Category window displays the currently selected category of audio. Categories of channels, such as Jazz, Rock, or News, can be selected to list the available channels for a type of music or other contents.

- 1) While viewing the XM Radio page of the AUX page group, press the **CATGRY** soft key to activate Category selection.
- 2) Turn the small **MFD** knob to select the desired category. When the MFD knob is turned to select a category, the soft keys will not be shown.



Figure 5-20 XM Category List

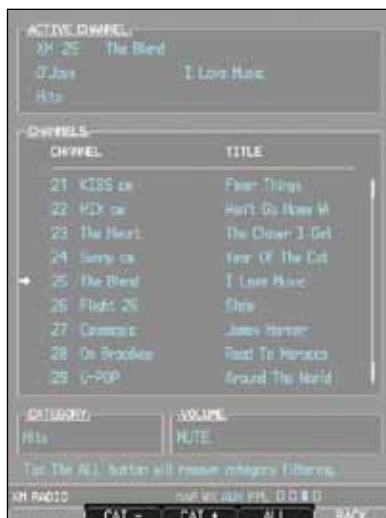

Figure 5-21 XM Category Soft Keys

- 3) Press **ENT** to display the list of channels for the highlighted category in the Channels window.
 - 4) Press the small **MFD** knob to cancel selection or to end editing.
- OR
- 1) Press **CATGRY** and then the **CAT +** or **CAT -** soft keys to increment up or down one category at a time.
 - 2) Press **ALL** to show the channels for all categories. Use the large and small **MFD** knobs to select desired channel.
 - 3) Press **ENT** to save the selection or press the small **MFD** knob to cancel selection.

5.5.3.2 Selecting a Sirius XM Satellite Radio Channel

The Channel feature is used to navigate through the channels in the selected category.

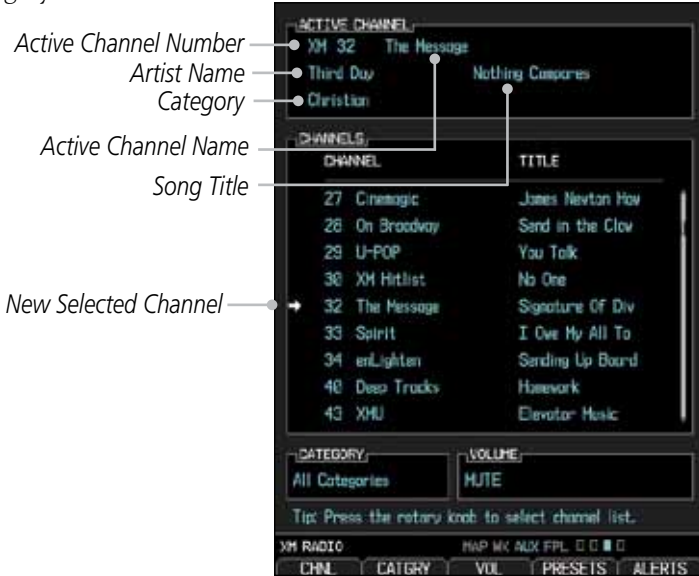

Figure 5-22 XM Channel Selection

- 1) While viewing the XM Radio page of the AUX page group, press the small **MFD** knob and then turn the small **MFD** knob to select the desired channel.
- 2) Press **ENT** to make the highlighted channel the Active Channel.



NOTE: A delay of several seconds may occur when selecting a channel. The listed title may end before the radio begins playing the current Active Channel material.

- 3) Press the small **MFD** knob to cancel selection or to end editing.
OR
- 4) Press **CHNL** and then the **CH +** or **CH -** soft keys to increment up or down one channel at a time in the active category.
OR
- 5) Press **CHNL** and then the **DIR CH** soft key to directly select a channel in the active category. Use the large and small **MFD** knobs to select desired channel.
- 6) Press **ENT** to save the selection or press the small **MFD** knob to cancel selection.

5.5.3.3 Sirius XM Satellite Radio Volume

The Volume control allows you to set the audio volume level, as well as mute the audio.

Foreword
 Sec 1 System
 Sec 2 PFD
 Sec 3 MFD
 Sec 4 Hazard Avoidance
 Sec 5 Additional Features
 Sec 6 Annun. & Alerts
 Sec 7 Symbols
 Sec 8 Glossary
 Appendix A
 Appendix B Index

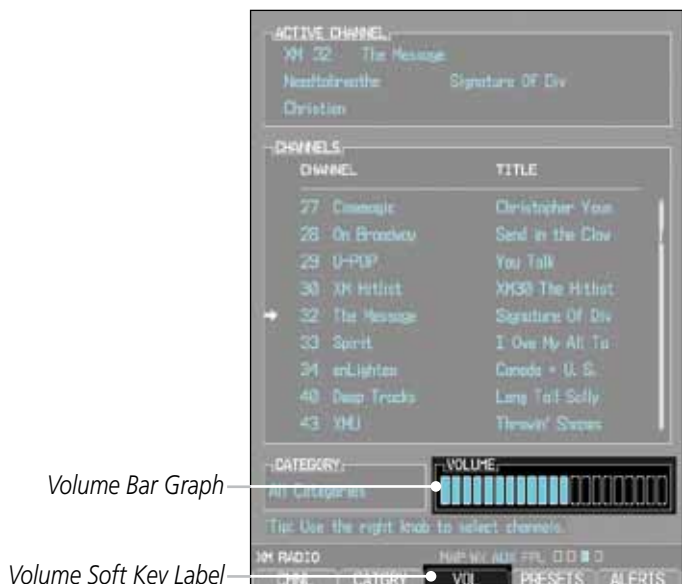

Figure 5-23 XM Radio Volume Setting

1. While viewing the XM Radio page of the AUX page group, press the **VOL** soft key.
2. Press the **VOL +** or **VOL -** soft keys, or turn the small **MFD** knob, to adjust the radio volume.



Figure 5-24 XM Radio Volume Controls

- 3) Press **MUTE** to mute the radio volume.
- 4) Press **MUTE** again or the **VOL +** or **VOL -** soft keys to unmute the radio volume.

5.5.3.4 Sirius XM Satellite Radio Channel Presets

The **PRESET** soft key allows you to store the Active Channel into a selected preset position for easy later recall. A delay of several seconds can occur when setting or recalling a preset.

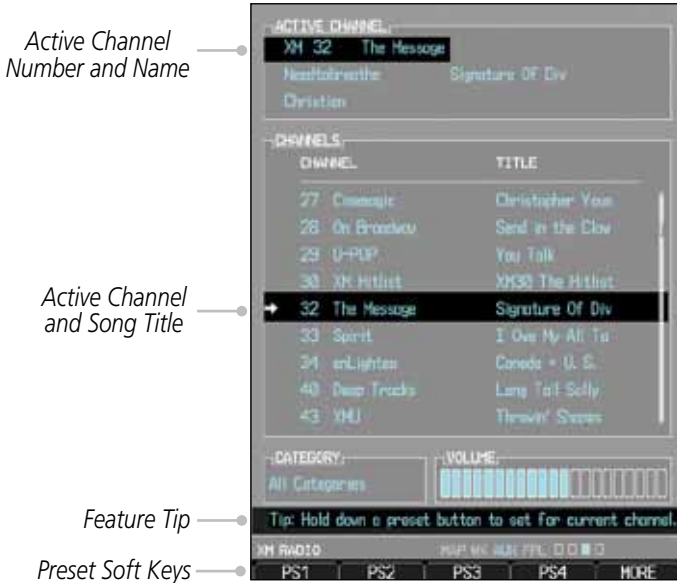

Figure 5-25 XM Radio Presets

Setting a Preset

- 1) While viewing the XM Radio page of the AUX page group, you may set a preset for the Active Channel. Press the **PRESETS** soft key.
- 2) Press and hold a preset soft key, such as **PS1**.
- 3) Press the **MORE** soft key to display the next series of presets.

Recalling a Preset

- 1) While viewing the XM Radio page of the AUX page group, press the **PRESETS** soft key.
- 2) Press the preset soft key for the desired stored channel, such as **PS1**.
- 3) Press the **MORE** soft key to display the next series of presets.

Foreword

System Sec 1

PFD Sec 2

MFD Sec 3

Hazard Avoidance Sec 4

Additional Features Sec 5

Annun. & Alerts Sec 6

Symbols Sec 7

Glossary Sec 8

Appendix A

Appendix B Index

5.5.4 GDL 69/69A Data Link Receiver Troubleshooting

Some quick troubleshooting steps listed below can be performed to find the possible cause of a failure.

- Ensure the owner/operator of the aircraft in which the Data Link Receiver is installed has subscribed to Sirius XM Satellite Radio
- Ensure the Sirius XM Satellite Radio subscription has been activated
- Perform a quick check of the circuit breakers to ensure that power is applied to the Data Link Receiver

For troubleshooting purposes, check the LRU Information Box on the AUX - System Status Page for Data Link Receiver (GDL 69/69A) status, serial number, and software version number. If a failure has been detected in the GDL 69/69A the status will be marked with a red "X."

- 1) Turn the large **MFD** knob to select the AUX Page Group.
- 2) Turn the small **MFD** knob to select the System Status Page (the last page in the AUX Page Group).



Figure 5-26 LRU Status Window

Foreword
 Sec 1 System
 Sec 2 PFD
 Sec 3 MFD
 Sec 4 Hazard Avoidance
 Sec 5 Additional Features
 Sec 6 Annun. & Alerts
 Sec 7 Symbols
 Sec 8 Glossary
 Appendix A
 Appendix B Index

5.6 Autopilot Operation

The G500 is able to interface to certain autopilot systems to provide the functions described in this section. Please refer to your particular Airplane Flight Manual and autopilot documentation for specific information and operating instructions.

5.6.1 GAD 43 Attitude

The GAD 43 Adapter may Optionally provide attitude information from the Garmin GRS 77 Attitude and Heading Reference System to certain autopilots. The GAD 43 has the ability to disconnect the autopilot if an error in the GAD 43 output or GRS 77 is detected. This disconnect mechanism must be tested prior to each flight in the following manner:

- 1) Allow all avionics to complete power up and begin normal operation.
- 2) Engage the autopilot while on the ground.
- 3) Press the **AP TEST** soft key and verify that the autopilot disconnects normally.



CAUTION: Do not use the autopilot if the AP TEST does not disengage the autopilot normally.

Autopilot Disconnect

When the GDU 620 attitude monitors have detected an AHRS malfunction, or the inability to actively monitor the AHRS, a “Check Attitude” annunciation will be displayed on the PFD and the autopilot will automatically disconnect.



NOTE: Only appears with the installation of an optional GAD 43 Adapter.



Figure 5-27 Check Attitude - Autopilot Automatically Disconnected

Foreword

Sec 1
System

Sec 2
PFD

Sec 3
MFD

Sec 4
Hazard
& Alerts
Avoidance

Sec 5
Additional
Features

Sec 6
Annun.
& Alerts

Sec 7
Symbols

Sec 8
Glossary

Appendix A

Appendix B
Index

Fly the aircraft manually and crosscheck the GDU 620 attitude indication with the standby attitude indicator and other sources of attitude information (airspeed, heading, altitude, etc.).

5.6.2 Heading

The GDU 620 heading bug may be used in conjunction with the “Heading” mode of supported autopilots. When the autopilot is in “heading” mode and the heading bug is adjusted in the normal manner, and the autopilot will turn to and maintain the selected heading. Refer to the Airplane Flight Manual and autopilot system documentation for instructions on how to use the autopilot heading mode.



Figure 5-28 Adjusting the Heading Bug

5.6.3 Altitude Capture (Optional Upgrade)

The GDU 620 altitude bug may be used to automatically capture a selected altitude with certain autopilots. Refer to the Airplane Flight Manual and autopilot system documentation for instructions on how to use the altitude preselect feature, if available.

Adjust the altitude bug in the normal manner when using the altitude capture interface. Some autopilot installations support arming and disarming of the selected altitude using the ALT key on the PFD. The PFD knob window will indicate when this function is available. The selected altitude may be alternately armed or disarmed by pressing and holding the ALT key on the PFD bezel.



Figure 5-29 Pressing and Holding the ALT Key to Arm/Disarm the Selected Altitude

Foreword
Sec 1 System
Sec 2 PFD
Sec 3 MFD
Sec 4 Hazard Avoidance
Sec 5 Additional Features
Sec 6 Annun. & Alerts
Sec 7 Symbols
Sec 8 Glossary
Appendix A
Appendix B Index

5.6.4 Autopilot Navigation

The HSI may be used in conjunction with the appropriate navigation modes of supported autopilots. The GDU 620 provides the autopilot with the selected course and lateral/vertical deviations. The GDU 620 acts as a switching source between the installed navigation sources (e.g GPS/VLOC, 1-2). The navigation source that is displayed on the HSI is sent to the autopilot. Refer to the Airplane Flight Manual and autopilot system documentation for instructions on how to use the autopilot navigation functions.

GPS Steering (GPSS) provides roll command signals calculated by the GPS navigator to the autopilot in order to allow the aircraft to anticipate turns, make smooth transitions when passing waypoints, and fly leg types such as Procedure Turns and Holding Patterns. The autopilot must have the ability to interpret the GPSS commands. The G500 can provide GPSS information to autopilots that have built-in support for GPSS commands, as well as to older autopilots that do not have built-in support for GPSS.

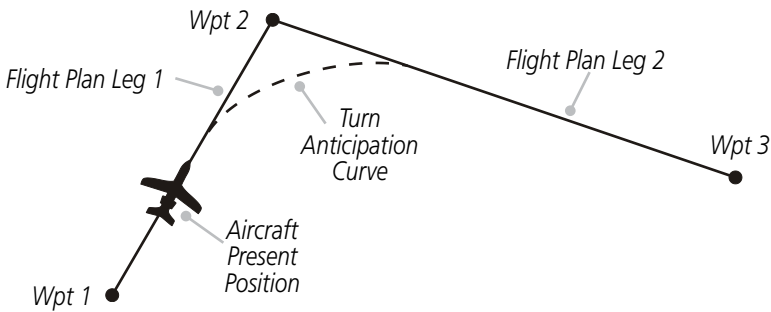

Figure 5-30 GPSS Turn Anticipation

5.6.4.1 Autopilot Operation with GPSS Enabled Autopilots

Some autopilots have built-in support for GPS Steering (GPSS) commands from a GPS navigator. The GDU 620 will send the GPSS commands from the displayed GPS source to the autopilot. For example, if GPS 1 is displayed on the HSI, the GPSS commands from GPS 1 will be sent to the autopilot. Refer to the Airplane Flight Manual and autopilot system documentation for instructions on how to use the autopilot's GPSS function.



NOTE: GPSS commands are not sent to the autopilot when a VLOC source is displayed on the HSI.

Foreword
 Sec 1 System
 Sec 2 PFD
 Sec 3 MFD
 Sec 4 Hazard Avoidance
 Sec 5 Additional Features
 Sec 6 Annun. & Alerts
 Sec 7 Symbols
 Sec 8 Glossary
 Appendix A
 Appendix B Index

5.6.3.2 Autopilot Operation with the GDU 620 Emulating GPSS

In order to provide GPSS functionality for autopilots that do not have built-in GPSS support, the GDU 620 can convert the GPSS commands into a heading signal. When GPSS mode is turned on, the autopilot heading mode will follow the GPSS commands instead of the heading bug. Refer to the Airplane Flight Manual and autopilot system documentation for instructions on how to use the autopilot heading mode.

Depending on the installation, GPSS mode may be toggled on/off with an external switch or by pressing and holding the **HDG** key on the PFD. If the installation uses the **HDG** key on the PFD, the **PFD** knob window will display the GPSS/HDG mode options.



Figure 5-31 GPSS mode control with the HDG key

When GPSS mode is on, the heading bug on the HSI changes to a hollow outline and a crossed-out heading bug appears in the PFD Knob Mode Indicator, indicating that the autopilot is not coupled to the heading bug. The bug is still controllable and may still be used by the pilot for reference. GPSS is annunciated in the lower left portion of the PFD. The GPSS mode annunciation depends on the location of the NAV STATUS information, as shown in the following figure.



Figure 5-32 GPSS Mode Annunciations

5.6.4 Flight Director Display

If autopilot flight director commands are interfaced to the G500, they will be presented as a single cue flight director on the PFD. Control of the flight director is accomplished via the autopilot/flight director controller; there are no pilot controls or adjustments for the flight director on the G500.

The G500 system limits the distance the flight director pitch commands may

deviate from the aircraft attitude icon. In the event that the pitch command provided by the autopilot flight director is greater than the distance allowed by the G500, the command bars will be displayed at the maximum distance allowed by the G500. As the aircraft pitch changes to satisfy the command bars, the bars will continue to be displayed at the maximum distance from the aircraft attitude icon until the aircraft pitch deviation is within the command display limit.

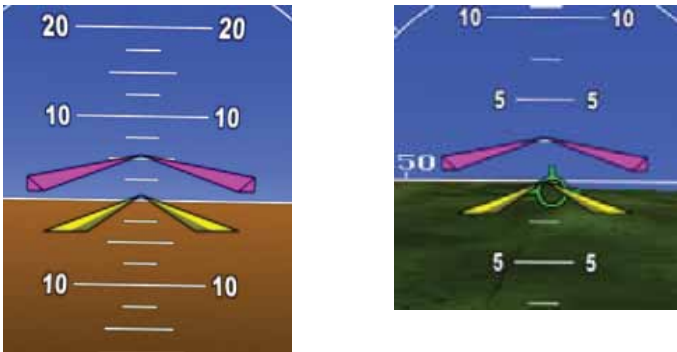

SVT Off **SVT On**
Figure 5-33 Flight Director Bars Showing Aircraft Pitch

5.6.5 Vertical Speed Control

The GDU 620 vertical speed bug may be used to control vertical speed with certain autopilots. Refer to the Airplane Flight Manual and autopilot system documentation for instructions on how to use the vertical speed mode, if available.

Adjust the vertical speed bug in the normal manner when using the vertical speed mode interface. Some autopilot installations support engaging/disengaging the vertical speed mode using the VS key on the PFD. The PFD knob window will indicate when this function is available. The vertical speed mode may be alternately engaged or disengaged by pressing and holding the VS key on the PFD bezel.



Figure 5-34 Pressing and Holding the VS Key to Engage/Disengage VS mode

Foreword
 Sec 1 System
 Sec 2 PFD
 Sec 3 MFD
 Sec 4 Hazard Avoidance
 Sec 5 Additional Features
 Sec 6 Annun. & Alerts
 Sec 7 Symbols
 Sec 8 Glossary
 Appendix A
 Appendix B Index

5.6.6 Autopilot Mode Annunciations

Some autopilots support mode annunciations located at the top of the PFD. Refer to the Airplane Flight Manual and autopilot system documentation for details on the autopilot mode annunciations.

When autopilot annunciations are displayed at the top of the PFD, the Nav Status information will be located to the left of the HSI (NAV STATUS Style 2).

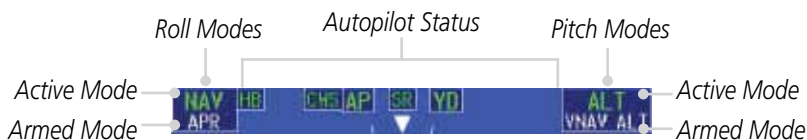

Figure 5-35 Autopilot Annunciations on Top of PFD

Foreword

Sec 1
System

Sec 2
PFD

Sec 3
MFD

Sec 4
Hazard
Avoidance

**Sec 5
Additional
Features**

Sec 6
Annun.
& Alerts

Sec 7
Symbols

Sec 8
Glossary

Appendix A

Appendix B
Index

5.7 Garmin Synthetic Vision Technology (SVT™) (Optional)

The optional Garmin Synthetic Vision Technology (SVT™) is a visual enhancement to the G500. SVT is displayed as a forward-looking display of the topography immediately in front of the aircraft. SVT information is shown on the primary flight display (PFD). The depicted imagery is derived from the aircraft attitude, heading, GPS three-dimensional position, and a database of terrain, obstacles, and other relevant features.



NOTE: *Not all flight directors are supported with SVT enabled. Check your AFMS to determine if your flight director is supported with SVT enabled.*

The following SVT enhancements appear on the PFD:

- Flight Path Marker
- Horizon Heading Marks
- Traffic Display
- Airport Signs
- Runway Display
- Terrain Alerting
- Obstacle Alerting
- Water
- Zero-Pitch Line

Standard Terrain - SVT is integrated within SVT to provide visual and audible alerts to indicate the presence of terrain threats relative to the projected flight path. In addition to the Terrain - SVT alerts, SVT offers a three-dimensional view of terrain and obstacles. Terrain and/or obstacles that pose a threat to the aircraft in flight are shaded yellow or red.

NOTE: SVT will become disabled if the databases necessary to display SVT are unavailable (generating a GDU DB ERR or SVT DISABLED alert) or AHRs or GPS data is unavailable. SVT may be restored once the fail conditions are removed by reactivating SVT as explained in the SVT Operation section.



Figure 5-36 Synthetic Vision Imagery - PFD

Foreword
Sec 1 System

Sec 2 PFD

Sec 3 MFD

Sec 4 Hazard Avoidance

Sec 5 Additional Features

Sec 6 Annun. & Alerts

Sec 7 Symbols

Sec 8 Glossary

Appendix A

Appendix B Index

5.7.1 Garmin SVT™ Operation

Garmin SVT™ is activated from the PFD using the soft keys located along the bottom edge of the display. Pressing the soft keys turn the related function on or off.

SVT functions are displayed on three levels of soft keys. The **PFD** soft key leads into the PFD function soft keys, including synthetic vision. Pressing the **SYN VIS** soft key enables synthetic vision and displays the **SYN TERR**, **HRZN HDG**, and **APTSIGNS** soft keys. The **BACK** soft key returns to the previous level of soft keys.

HRZN and **APTSIGNS** soft keys are dependent upon the state of the **SYN TERR** soft key. When Synthetic Terrain is deactivated, the **SYN TERR** soft key appears illuminated while the remaining SVT soft keys are unavailable for selection and subdued (black with dark-gray characters). If Synthetic Terrain is deactivated, all other SVT features are also deactivated. With Synthetic Terrain activated, all other SVT features may be turned on or off at the pilot's discretion.

- SYN TERR soft key enables synthetic terrain depiction.
- HRZN HDG soft key enable horizon heading marks and digits.
- APTSIGNS soft key enables airport signposts.

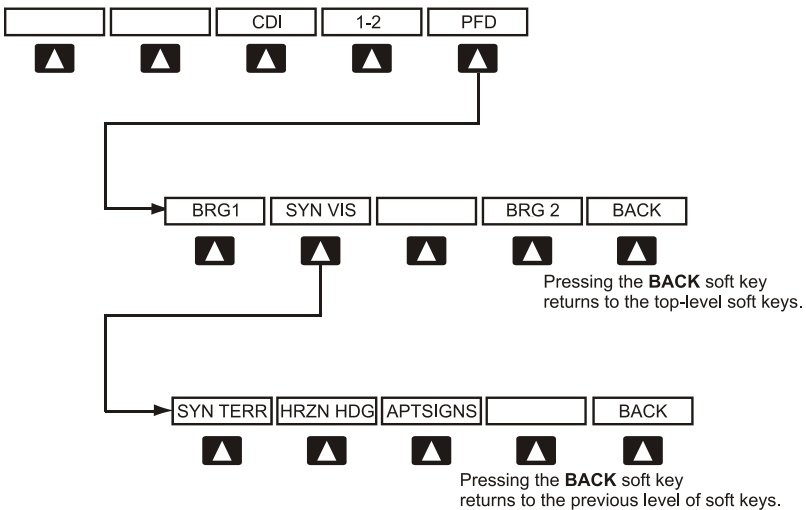

Figure 5-37 SVT Soft Keys

Foreword

Sec 1
System

Sec 2
PFD

Sec 3
MFD

Sec 4
Hazard
Avoidance

Sec 5
Additional
Features

Sec 6
Annun.
& Alerts

Sec 7
Symbols

Sec 8
Glossary

Appendix A

Appendix B
Index

5.7.2 Activating and Deactivating Garmin SVT™

Foreword



NOTE: In some instances, such as temporary loss of GPS signal, the SVT functionality will be disabled.

To enable SVT:

Sec 1
System

- 1) Press the **PFD** soft key.
- 2) Press the **SYN VIS** soft key.
- 3) Press the **SYN TERR** soft key to view the SVT display.

Sec 2
PFD

When SVT is enabled, the pitch ladder will display a different pitch scale.

Sec 3
MFD

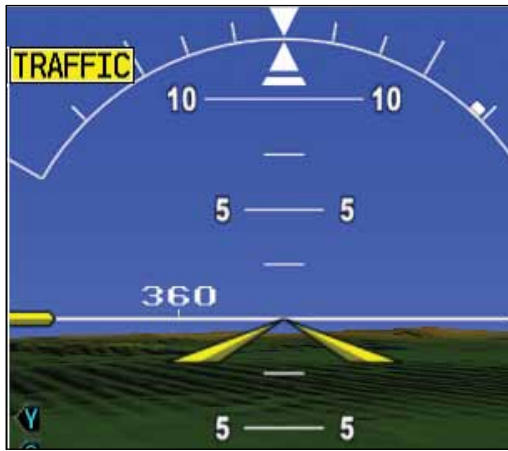

Figure 5-38 Pitch Scale with SVT Enabled

Sec 4
Hazard
Avoidance

Sec 5
Additional
Features

Sec 6
Annun.
& Alerts

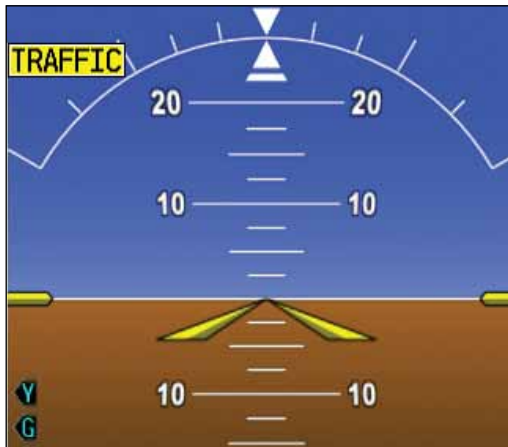

Figure 5-39 Pitch Scale with SVT Disabled

Sec 7
Symbols

Sec 8
Glossary

Appendix A

Appendix B
Index

5.7.3 Garmin SVT™ Features

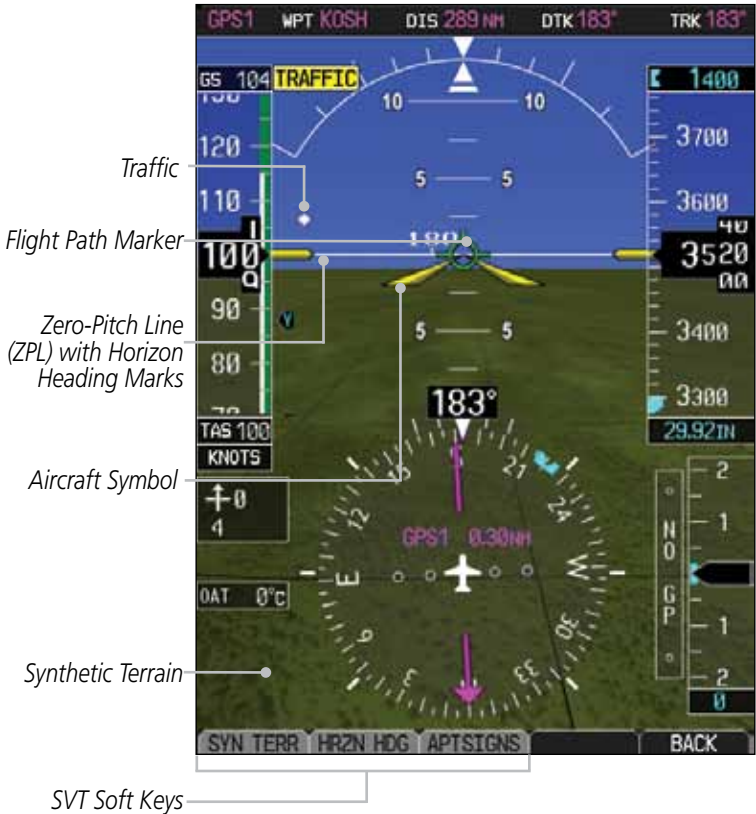

Figure 5-40 SVT on Primary Flight Display

Foreword

Sec 1 System

Sec 2 PFD

Sec 3 MFD

Sec 4 Hazard Avoidance

Sec 5 Additional Features

Sec 6 Annun. & Alerts

Sec 7 Symbols

Sec 8 Glossary

Appendix A

Appendix B Index



NOTE: SVT features are not a substitute for standard course and altitude deviation information using the CDI, VSI, and VDI presentations.

5.7.3.1 Flight Path Marker (FPM)

The Flight Path Marker is also known as a Velocity Vector. It is displayed on the PFD at ground speeds above 30 knots. The FPM depicts approximate projected path of the aircraft accounting for wind speed and direction relative to the three-dimensional display.

5.7.3.2 Zero-Pitch Line

The Zero-Pitch Line is drawn completely across the display and represents the aircraft attitude with respect to the horizon. It is not necessarily aligned with the terrain horizon, particularly when the terrain is sloped or mountainous.

5.7.3.3 Horizon Heading

The Horizon Heading is synchronized with the HSI and shows compass headings in 30-degree increments on the Zero-Pitch Line. Horizon heading tick marks and digits appearing on the zero-pitch line are not visible when they are behind either the airspeed or altitude display. Horizon Heading is activated and deactivated by pressing the **HRZN HDG** soft key.

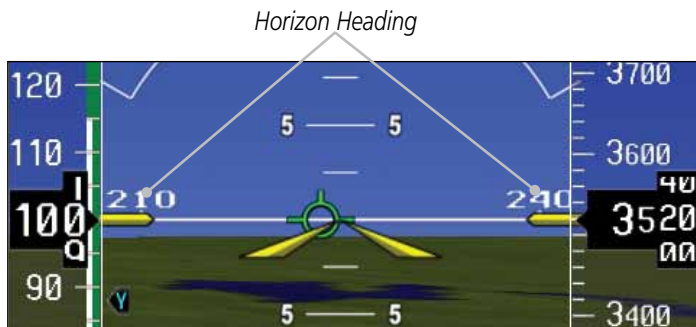

Figure 5-41 Horizon Heading

5.7.3.4 Airport Signs

Airports Signs provide a visual representation of airport location and identification on the synthetic terrain display. When activated, the signs appear on the display when the aircraft is approximately 15 NM from an airport and disappear at approximately 4.5 NM. Airport signs are shown without the identifier until the aircraft is approximately 9 NM from the airport. Airport signs are shown behind the airspeed or altitude display. Airport signs are activated and deactivated by pressing the **APT SIGNS** soft key.

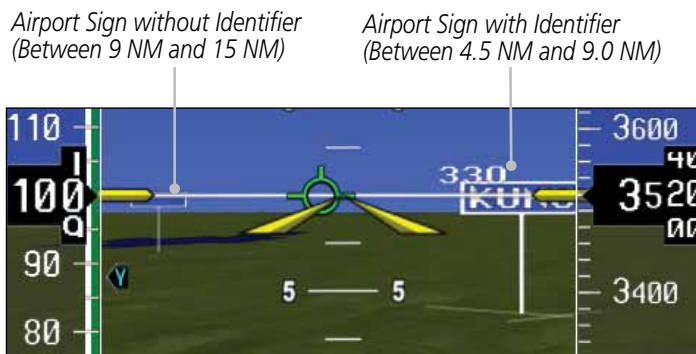

Figure 5-42 Airport Signs

Foreword
 Sec 1 System
 Sec 2 PFD
 Sec 3 MFD
 Sec 4 Hazard Avoidance
 Sec 5 Additional Features
 Sec 6 Annun. & Alerts
 Sec 7 Symbols
 Sec 8 Glossary
 Appendix A
 Appendix B Index

5.7.3.5 Runway Depiction

Runways are shown on the PFD in various ways. Soft surface runways, such as grass runways, are depicted in green. Hard surface runways, such as asphalt, are depicted in gray. Your flight plan will determine how the runway is displayed on the PFD.

Without a loaded flight plan, a runway is shown as dark gray with the boundaries of the runway in light gray.



Figure 5-43 Depiction of Runway with a Loaded Flight plan

A runway that is not in a loaded flight plan is shown as dark gray with no other colors.



Figure 5-44 Depiction of Runway Not in Loaded Flight plan

A runway that is associated with an approach in the loaded flight plan is outlined with a white rectangle, with the actual runway, in that rectangle.



Figure 5-45 Depiction of Runway with Loaded Approach

Foreword

Sec 1
System

Sec 2
PFD

Sec 3
MFD

Sec 4
Hazard
Avoidance

Sec 5
Additional
Features

Sec 6
Annun.
& Alerts

Sec 7
Symbols

Sec 8
Glossary

Appendix A

Appendix B
Index

5.7.3.6 Traffic

Traffic symbols are displayed in their approximate respective location as determined by the related traffic systems, either TIS or TAS. Traffic is displayed in three dimensions, appearing larger as they are getting closer, and smaller when they are further away. Traffic symbol coloring and shaping is the same as that used for traffic displayed in the inset moving map or MFD traffic page.

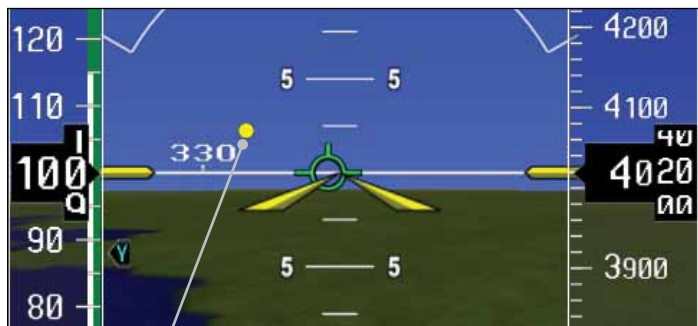

Traffic on PFD



Figure 5-46 Traffic Depiction on PFD and MFD

Foreword

Sec 1 System

Sec 2 PFD

Sec 3 MFD

Sec 4 Hazard Avoidance

Sec 5 Additional Features

Sec 6 Annun. & Alerts

Sec 7 Symbols

Sec 8 Glossary

Appendix A

Appendix B Index

5.7.3.7 Obstacles

Obstacles are represented on the synthetic display by standard two-dimensional tower symbols found on the MFD maps and charts. Obstacle symbols appear in the perspective view with relative height above terrain and distance from the aircraft.



Figure 5-47 Obstacle Depiction on PFD

Unlike the MFD moving map display, obstacles on the synthetic terrain display do not change colors to warn of potential conflict with the aircraft's flight path until the obstacle is associated with an actual FLTA alert. Obstacles greater than 1000 feet below the aircraft's altitude are not shown. Obstacles are shown behind the airspeed and altitude displays.

Foreword

Sec 1 System

Sec 2 PFD

Sec 3 MFD

Sec 4 Hazard Avoidance

Sec 5 Additional Features

Sec 6 Annun. & Alerts

Sec 7 Symbols

Sec 8 Glossary

Appendix A

Appendix B Index

5.7.3.8 Field of View

The PFD Field of View can be represented on the MFD Navigation Map Page lateral image. Two dashed lines forming a V-shape in front of the aircraft symbol on the MFD with an angle of approximately 50° represent the forward horizontal field of view shown on the PFD.

Foreword

Sec 1
System

Sec 2
PFD

Sec 3
MFD

Sec 4
Hazard
Avoidance

Sec 5
Additional
Features

Sec 6
Annun.
& Alerts

Sec 7
Symbols

Sec 8
Glossary

Appendix A

Appendix B
Index



*V-Shaped Lines
Depict PFD Field
of View (angle is
approx. 50°)*



Figure 5-48 MFD and PFD Field of View Comparison

To configure the Field of View:

- 1) While viewing the Navigation Map 1 or 2 of the Map Page Group, press the **MENU** key to display the **PAGE MENU**.

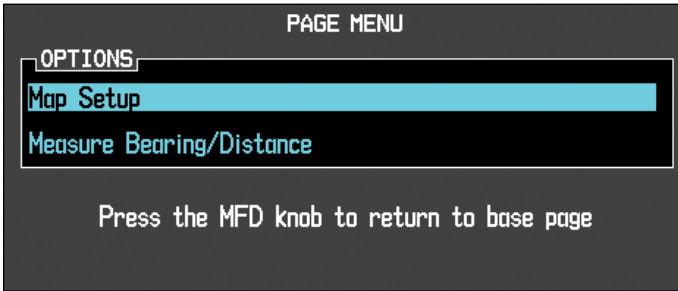

Figure 5-49 Page Menu

- 2) Press the **ENT** key to bring up the setup page.

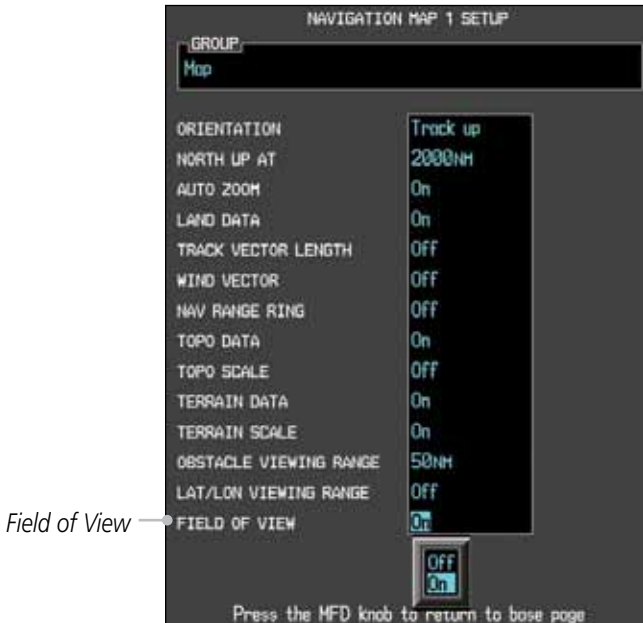

Figure 5-50 Map Setup Items

- 3) Turn the large **MFD** knob to scroll through the options to FIELD OF VIEW.
- 4) Turn the small **MFD** knob to select On or Off. Press the **ENT** key to confirm your selection.
- 5) Press the small **MFD** knob to return to the Navigation Map Page.

Foreword

Sec 1
System

Sec 2
PFD

Sec 3
MFD

Sec 4
Hazard
Avoidance

Sec 5
Additional
Features

Sec 6
Annun.
& Alerts

Sec 7
Symbols

Sec 8
Glossary

Appendix A

Appendix B
Index

5.7.3.9 Unusual Attitudes

Unusual attitudes are displayed with red chevrons overlaid on the display, pointing to the direction to fly to correct the unusual attitude condition. The display shows either a brown or blue band of color at the top or bottom of the screen to represent earth or sky. This is intended to prevent losing sight of the horizon during extreme pitch attitudes.

Two conditions that inhibit SVT and generate alerts on the PFD:

- The position of the aircraft exceeds the range of the terrain database.
- The terrain database is out of date using an older terrain database card.

Blue Band - Sky Representation



Figure 5-51 Unusual Attitude Display - Blue Band

Foreword
 Sec 1 System
 Sec 2 PFD
 Sec 3 MFD
 Sec 4 Hazard Avoidance
 Sec 5 Additional Features
 Sec 6 Annun. & Alerts
 Sec 7 Symbols
 Sec 8 Glossary
 Appendix A
 Appendix B Index



Brown Band - Ground Representation

Figure 5-52 Unusual Attitude Display - Brown Band

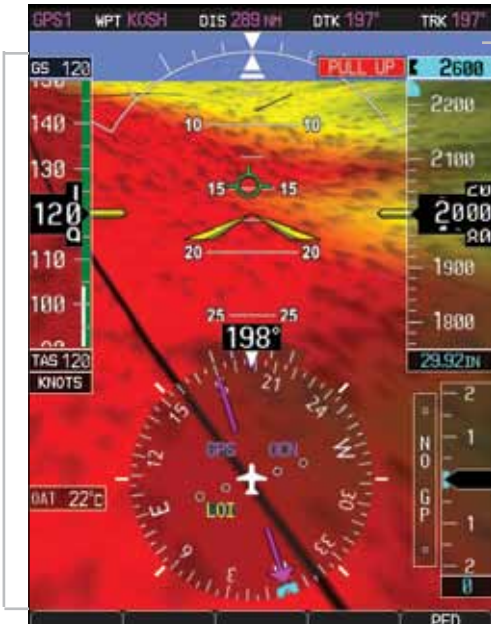

Blue Band - Sky Representation

Terrain Fills Display

Figure 5-53 Blue Sky Bar with Full Display Terrain

- Foreword
- Sec 1 System
- Sec 2 PFD
- Sec 3 MFD
- Sec 4 Hazard Avoidance
- Sec 5 Additional Features
- Sec 6 Annun. & Alerts
- Sec 7 Symbols
- Sec 8 Glossary
- Appendix A
- Appendix B Index

Foreword

Sec 1
System

Sec 2
PFD

Sec 3
MFD

Sec 4
Hazard
Avoidance

**Sec 5
Additional
Features**

Sec 6
Annun.
& Alerts

Sec 7
Symbols

Sec 8
Glossary

Appendix A

Appendix B
Index

This page intentionally left blank

6 ANNUNCIATIONS AND ALERTS

6.1 Alerts

Alerts are displayed on the MFD and are accessible via the **ALERTS MFD** soft key. When a new advisory is present, the **ALERTS** soft key text changes to **ADVISORY** and flashes until the alerts page is viewed.

The MFD ALERTS page may have two additional soft keys (**TRND/ACK** and **CAPTURE**) which are present when interfaced to an optional ADAS+ Engine Trend Monitor (ETM). Pressing the **TRND/ACK** soft key is equivalent to pressing the **ETM Trend** key for one second. Pressing the **CAPTURE** soft key is equivalent to pressing the **ETM Trend** key for five seconds. Refer to the Airplane Flight Manual and ADAS+ ETM documentation for the system description and operating procedures.

Alert Message	Description	Action
ADC1 ALT EC	<ul style="list-style-type: none"> • ADC Altitude Error Correction is unavailable. • The alert is enabled and the GDC is reporting that altitude correction is unavailable. 	<ul style="list-style-type: none"> • Contact your Garmin dealer for service.

Foreword

Sec 1
System

Sec 2
PFD

Sec 3
MFD

Sec 4
Hazard
Avoidance

Sec 5
Additional
Features

**Sec 6
Annun.
& Alerts**

Sec 7
Symbols

Sec 8
Glossary

Appendix A

Appendix B
Index

Alert Message	Description	Action
AHRS1 GPS	<ul style="list-style-type: none"> • AHRS1/2 not receiving any GPS information. • AHRS1/2 operating exclusively in no-GPS reversionary mode. • AHRS1/2 using backup GPS source. • AHRS1/2 not receiving backup GPS information. • Two GPS devices are configured as present and AHRS1 is not receiving GPS data from the backup (2nd) device. 	<ul style="list-style-type: none"> • Verify navigators are on and have a GPS signal and are not in self-test mode. • Check AFMS for limitations. • Contact your Garmin dealer for service.
AHRS1/2 SRVC	<ul style="list-style-type: none"> • AHRS1/2 magnetic-field model needs update. • Appears on ground only. 	<ul style="list-style-type: none"> • AHRS magnetic field model should be upgraded. • Contact your Garmin dealer for service.
AHRS1/2 TAS	<ul style="list-style-type: none"> • AHRS1/2 not receiving true airspeed from ADC. • Displayed heading and attitude data is still valid. • Additional loss of GPS data will cause loss of heading and attitude data. 	<ul style="list-style-type: none"> • Check ADC cable. • Contact your Garmin dealer for service.
ALT KEY INOP	<ul style="list-style-type: none"> • The ALT key is disabled. 	<ul style="list-style-type: none"> • ALT key is not available.

Foreword

Sec 1
SystemSec 2
PFDSec 3
MFDSec 4
Hazard
AvoidanceSec 5
Additional
FeaturesSec 6
Annun.
& AlertsSec 7
SymbolsSec 8
Glossary

Appendix A

Appendix B
Index

Alert Message	Description	Action
AUD NOT AVAIL	<ul style="list-style-type: none"> Audio system not available. 	<ul style="list-style-type: none"> Contact your Garmin dealer for service.
AUD SYS FAIL	<ul style="list-style-type: none"> Audio system failure. 	<ul style="list-style-type: none"> Contact your Garmin dealer for service.
CAL LOST	<ul style="list-style-type: none"> Calibration Data Lost. 	<ul style="list-style-type: none"> Contact your Garmin dealer for service.
CNFG MISMATCH	<ul style="list-style-type: none"> GDU 1-2 airframe configuration settings disagree. 	<ul style="list-style-type: none"> Contact your Garmin dealer for service.
CNFG MODULE	<ul style="list-style-type: none"> GDU configuration module is inoperative. 	<ul style="list-style-type: none"> Contact your Garmin dealer for service.
DATA LOST	<ul style="list-style-type: none"> Pilot stored data was lost. Recheck data and settings. 	<ul style="list-style-type: none"> Reset your settings. G500 pilot configurable items have been returned to default settings.
DIAG MODE	<ul style="list-style-type: none"> System is in Diagnostic Mode. 	
ETM EXCEED	<ul style="list-style-type: none"> Engine Trend Monitor exceedence/advisory. ADAS+ engine trend monitor is reporting an exceedence or advisory condition. 	<ul style="list-style-type: none"> Refer to ADAS+ documentation for appropriate action.
ETM FAULT	<ul style="list-style-type: none"> Engine Trend Monitor needs service. ADAS+ engine trend monitor is reporting a system fault. 	<ul style="list-style-type: none"> Refer to ADAS+ documentation for appropriate action.
ETM FAULT	<ul style="list-style-type: none"> Engine Trend Monitor needs service. ADAS+ Enabled. Fault received. 	<ul style="list-style-type: none"> Refer to ADAS+ documentation for appropriate action.

Foreword

Sec 1
SystemSec 2
PFDSec 3
MFDSec 4
Hazard
AvoidanceSec 5
Additional
FeaturesSec 6
Annu.
& AlertsSec 7
SymbolsSec 8
Glossary

Appendix A

Appendix B
Index

Alert Message	Description	Action
EXTERNAL TAWS FAIL	<ul style="list-style-type: none"> External TAWS device has failed. 	<ul style="list-style-type: none"> Contact your Garmin dealer for service.
FAN 1/2 FAIL	<ul style="list-style-type: none"> Cooling fan 1/2 has failed. Unit may operate at extreme temperatures. Extended operation at high temperatures is not recommended as damage to the GDU may occur. PFD/MFD coloration may be incorrect. Backlight may dim to reduce power and heat. 	<ul style="list-style-type: none"> Contact your Garmin dealer for service.
GAD 43	<ul style="list-style-type: none"> GAD 43 communication lost. 	<ul style="list-style-type: none"> Contact your Garmin dealer for service.
GAD 43	<ul style="list-style-type: none"> Gyro Emulation Type Mismatch Fault. 	<ul style="list-style-type: none"> Contact your Garmin dealer for service.
GAD 43	<ul style="list-style-type: none"> Yaw Rate Scale Factor Mismatch Fault. 	<ul style="list-style-type: none"> Contact your Garmin dealer for service.
GAD 43	<ul style="list-style-type: none"> GDU AHRS Monitor Fault. 	<ul style="list-style-type: none"> Contact your Garmin dealer for service.
GAD 43	<ul style="list-style-type: none"> Pitch Deviation Fault. 	<ul style="list-style-type: none"> Contact your Garmin dealer for service.
GAD 43	<ul style="list-style-type: none"> Roll Deviation Fault. 	<ul style="list-style-type: none"> Contact your Garmin dealer for service.
GAD 43	<ul style="list-style-type: none"> Yaw Rate Deviation Fault. 	<ul style="list-style-type: none"> Contact your Garmin dealer for service.
GAD 43	<ul style="list-style-type: none"> AHRS A429 Attitude Time-out Fault. 	<ul style="list-style-type: none"> Contact your Garmin dealer for service.

Foreword

Sec 1
SystemSec 2
PFDSec 3
MFDSec 4
Hazard
AvoidanceSec 5
Additional
FeaturesSec 6
Annun.
& AlertsSec 7
SymbolsSec 8
Glossary

Appendix A

Appendix B
Index

Alert Message	Description	Action
GAD 43	<ul style="list-style-type: none"> AHRS A429 Attitude Invalid Fault. 	<ul style="list-style-type: none"> Contact your Garmin dealer for service.
GAD 43	<ul style="list-style-type: none"> AHRS Pitch Out of Range Fault. 	<ul style="list-style-type: none"> Contact your Garmin dealer for service.
GAD 43	<ul style="list-style-type: none"> AHRS Attitude Invalid Fault. 	<ul style="list-style-type: none"> Contact your Garmin dealer for service.
GAD 43	<ul style="list-style-type: none"> AHRS A429 Heading Time-out Fault. 	<ul style="list-style-type: none"> Contact your Garmin dealer for service.
GAD 43	<ul style="list-style-type: none"> AHRS A429 Heading Invalid Fault. 	<ul style="list-style-type: none"> Contact your Garmin dealer for service.
GAD 43	<ul style="list-style-type: none"> Power Supply Fault. 	<ul style="list-style-type: none"> Contact your Garmin dealer for service.
GAD 43	<ul style="list-style-type: none"> AC Reference Lost. 	<ul style="list-style-type: none"> Contact your Garmin dealer for service.
GAD 43	<ul style="list-style-type: none"> Application SCI integrity fault. 	<ul style="list-style-type: none"> Contact your Garmin dealer for service.
GAD 43	<ul style="list-style-type: none"> Configuration integrity fault. 	<ul style="list-style-type: none"> Contact your Garmin dealer for service.
GAD 43	<ul style="list-style-type: none"> Calibration integrity fault. 	<ul style="list-style-type: none"> Contact your Garmin dealer for service.
GAD 43	<ul style="list-style-type: none"> Unit fault. 	<ul style="list-style-type: none"> Contact your Garmin dealer for service.
GATE MODE	<ul style="list-style-type: none"> Automated testing is on. 	
GDL69	<ul style="list-style-type: none"> GDL 69 has failed. 	<ul style="list-style-type: none"> Contact your Garmin dealer for service.
GEO LIMITS	<ul style="list-style-type: none"> AHRS1 too far North/South, no magnetic heading provided. Operating in extreme north latitudes has rendered heading data unreliable. 	<ul style="list-style-type: none"> Use alternate means of navigation. Check AFMS for limitations.

Foreword
 Sec 1 System
 Sec 2 PFD
 Sec 3 MFD
 Sec 4 Hazard Avoidance
 Sec 5 Additional Features
 Sec 6 Annu. & Alerts
 Sec 7 Symbols
 Sec 8 Glossary
 Appendix A
 Appendix B Index

Alert Message	Description	Action
GPS1/2 FAIL	<ul style="list-style-type: none"> Communication lost with GPS1/2. 	<ul style="list-style-type: none"> Use an alternate navigation source.
GPS(1/2) PPS FAIL	<ul style="list-style-type: none"> Timing data from GPS 1/2 is lost. 	<ul style="list-style-type: none"> Contact your Garmin dealer for service.
GSR FAIL	<ul style="list-style-type: none"> GSR has failed. 	<ul style="list-style-type: none"> Contact your Garmin dealer for service.
GWX CONFIG	<ul style="list-style-type: none"> GWX config error. Config service required. 	<ul style="list-style-type: none"> Contact your Garmin dealer for service.
GWX SERVICE	<ul style="list-style-type: none"> GWX needs service. 	<ul style="list-style-type: none"> Contact your Garmin dealer for service.
HDG FAULT	<ul style="list-style-type: none"> AHRS1/2 in no-magnetometer reversionary mode. Heading fault state on AHRS. Heading data is unreliable. 	<ul style="list-style-type: none"> Check AFMS for limitations. Use Compass or other course information. Contact your Garmin dealer for service.
HDG LOST	<ul style="list-style-type: none"> HDG features disabled or defaulted to GPS1 TRK. GDU is in the reversionary track-based mode. 	
<LRU> CONFIG	<ul style="list-style-type: none"> Error in the configuration of a specific LRU, where <LRU> denotes a specific LRU, such as GDL69 or GWX. 	<ul style="list-style-type: none"> Config service required. Contact your Garmin dealer for service.

Foreword

Sec 1
SystemSec 2
PFDSec 3
MFDSec 4
Hazard
AvoidanceSec 5
Additional
FeaturesSec 6
Annun.
& AlertsSec 7
SymbolsSec 8
Glossary

Appendix A

Appendix B
Index

Alert Message	Description	Action
<LRU> COOLING	<ul style="list-style-type: none"> <LRU> has poor cooling. Reducing power usage by dimming display. 	<ul style="list-style-type: none"> Specific LRU has poor cooling, where <LRU> denotes the specific LRU and power is being reduced. Contact your Garmin dealer for service.
<LRU> DB ERR	<ul style="list-style-type: none"> <LRU> database error exists, where "<LRU> database" denotes the specific unit database. 	<ul style="list-style-type: none"> Replace or update database.
<LRU> KEYSTK	<ul style="list-style-type: none"> <LRU> <KEY> is stuck. The <LRU> has detected the <KEY> key as stuck, where <LRU> and <KEY> denote a specific LRU and key. 	
<LRU> SERVICE	<ul style="list-style-type: none"> <LRU> needs service. Return unit for repair. 	<ul style="list-style-type: none"> Contact your Garmin dealer for service. Specific LRU should be serviced, where <LRU> denotes the specific LRU.
<LRU> VOLTAGE	<ul style="list-style-type: none"> <LRU> has low voltage. Reducing power usage by dimming display, where <LRU> denotes the specific LRU and power is being reduced. 	<ul style="list-style-type: none"> Contact your Garmin dealer for service.
MANIFEST	<ul style="list-style-type: none"> <LRU> software mismatch, communication halted. 	<ul style="list-style-type: none"> Contact your Garmin dealer for service.

Alert Message	Description	Action
NAV1/2	<ul style="list-style-type: none"> • Communication with NAV1/2 is lost. • No navigation receiver 1/2 data. 	<ul style="list-style-type: none"> • Switch to alternate navigation (GPS or otherwise) if available.
NO RADAR DATA	<ul style="list-style-type: none"> • No data is being sent to the GDU 	<ul style="list-style-type: none"> • Contact your Garmin dealer for service.
PREV EXCEED	<ul style="list-style-type: none"> • Previous Engine Trend Monitor exceedence. • ADAS+ engine trend monitor is reporting a previous exceedence. 	<ul style="list-style-type: none"> • Refer to ADAS+ documentation for appropriate action.
RADAR CONTROLS DISAGREE	<ul style="list-style-type: none"> • Data does not match for 15 seconds, or more 	<ul style="list-style-type: none"> • Contact your Garmin dealer for service.
SIMULATOR	<ul style="list-style-type: none"> • Simulator mode is active. Do not use for navigation. 	<ul style="list-style-type: none"> • Simulator mode is active.
SVT DISABLED	<ul style="list-style-type: none"> • Outside of terrain database coverage area. • Terrain database resolution is too low. 	<ul style="list-style-type: none"> • Repeat steps to reactivate SVT with the appropriate PFD soft keys. • Install 9 arc-second database.
SW MISMATCH	<ul style="list-style-type: none"> • GDU software version mismatch. No GDU crossfill. 	<ul style="list-style-type: none"> • Contact your Garmin dealer for service.
TDB	<ul style="list-style-type: none"> • Airframe does not support Terrain database. 	
TERRAIN DSP	<ul style="list-style-type: none"> • Terrain, airport terrain, or obstacle database error in TAWS B or TERRAIN-SVT only. 	<ul style="list-style-type: none"> • Update database.

Foreword

Sec 1
SystemSec 2
PFDSec 3
MFDSec 4
Hazard
AvoidanceSec 5
Additional
FeaturesSec 6
Annun.
& AlertsSec 7
SymbolsSec 8
Glossary

Appendix A

Appendix B
Index

Alert Message	Description	Action
TRAFFIC FAIL	<ul style="list-style-type: none"> Traffic device has failed. Traffic data will no longer be displayed. 	<ul style="list-style-type: none"> Contact your Garmin dealer for service.
TRK LOST	<ul style="list-style-type: none"> Heading and track from active GPS lost. HSI is using secondary GPS track. 	
TRK TRAFFIC	<ul style="list-style-type: none"> Heading Lost. Traffic is now based on track. 	
TRAFFIC STBY	<ul style="list-style-type: none"> Traffic is in Standby Mode while airborne. 	<ul style="list-style-type: none"> Check traffic system controls on the MFD traffic map page or traffic system.
WX ALERT	<ul style="list-style-type: none"> Possible severe weather ahead. 	<ul style="list-style-type: none"> Check weather radar.
WX RADAR	<ul style="list-style-type: none"> Communication with Weather Radar lost. 	<ul style="list-style-type: none"> Contact your Garmin dealer for service.
WX RDR SERVICE	<ul style="list-style-type: none"> Weather radar needs service. 	<ul style="list-style-type: none"> Contact your Garmin dealer for service.
WXR INPUT FAULT	<ul style="list-style-type: none"> Weather radar is not receiving one or more inputs. 	<ul style="list-style-type: none"> Contact your Garmin dealer for service.

Table 6-1 Alert Messages

Foreword

Sec 1
System

Sec 2
PFD

Sec 3
MFD

Sec 4
Hazard
Avoidance

Sec 5
Additional
Features

Sec 6
Annun.
& Alerts

Sec 7
Symbols

Sec 8
Glossary

Appendix A

Appendix B
Index

6.2 System Status

The System Status page of Aux mode shows the status, serial number, and software version of LRUs and the date of databases. There are no menu pages. In the LRU Status column, a green check means the unit is present and operating properly, while a red “X” indicates an absence or failure.

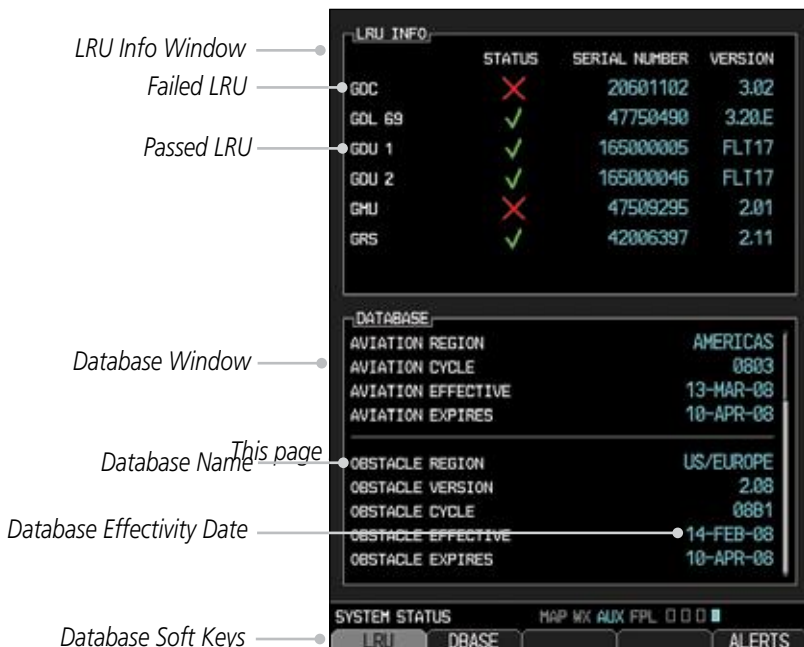

Figure 6-1 System Status

Foreword
 Sec 1 System
 Sec 2 PFD
 Sec 3 MFD
 Sec 4 Hazard Avoidance
 Sec 5 Additional Features
Sec 6 Annun. & Alerts
 Sec 7 Symbols
 Sec 8 Glossary
 Appendix A
 Appendix B Index

7 SYMBOLS

The following tables describe the symbols that are found on the MFD Map displays.

7.1 Map Page Symbols

Symbol	Description
	Unknown Airport
	Non-towered, Non-serviced Airport
	Towered, Non-serviced Airport
	Non-towered, Serviced Airport
	Towered, Serviced Airport
	Soft Surface, Serviced Airport
	Soft Surface, Non-serviced Airport
	Private Airport
	Heliport
	Intersection
	LOM (compass locator at outer marker)
	NDB (Non-directional Radio Beacon)
	VOR
	VOR/DME
	ILS/DME or DME-only
	VORTAC
	TACAN

Table 7-1 Map Page Symbols

Foreword

Sec 1
System

Sec 2
PFD

Sec 3
MFD

Sec 4
Hazard
Avoidance

Sec 5
Additional
Features

Sec 6
Annun.
& Alerts

**Sec 7
Symbols**

Sec 8
Glossary

Appendix A

Appendix B
Index

7.2 SafeTaxi™ Symbols



Symbol	Description
	Helipad
	Airport Beacon
	Under Construction Zones
	Unpaved Parking Areas

Table 7-2 SafeTaxi Symbols

7.3 Traffic Symbols





Symbol	Description (Highest to Lowest Priority)
	Traffic Advisory (TA), In Range
	Traffic Advisory (TA), Out of Range
	Proximate Advisory (PA)
	Other Traffic

Table 7-3 Traffic Symbols

Foreword

Sec 1
System

Sec 2
PFD

Sec 3
MFD

Sec 4
Hazard
Avoidance

Sec 5
Additional
Features

Sec 6
Annun.
& Alerts

Sec 7
Symbols

Sec 8
Glossary

Appendix A

Appendix B
Index

7.4 Terrain Obstacle Symbols





Unlighted Obstacle (Height is less than 1000 ft AGL)	Lighted Obstacle (Height is less than 1000 ft AGL)	Unlighted Obstacle (Height is greater than 1000 ft AGL)	Lighted Obstacle (Height is greater than 1000 ft AGL)
			

Figure 7-1 Obstacle Altitude/Color Correlation

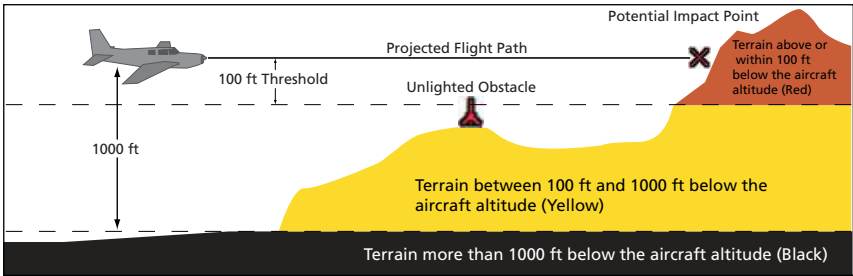

Figure 7-2 TERRAIN Altitude/Color Correlation

Foreword

Sec 1
System

Sec 2
PFD

Sec 3
MFD

Sec 4
Hazard
Avoidance

Sec 5
Additional
Features

Sec 6
Annun.
& Alerts

**Sec 7
Symbols**

Sec 8
Glossary

Appendix A

Appendix B
Index

7.5 Basemap Symbols



Symbol	Description
	Interstate Highway
	State Highway
	US Highway
	National Highway - 2-digit drawn inside
	Small City or Town
	Medium City
	Large City

Table 7-4 Basemap Symbols

7.6 Map Tool Bar Symbols





Symbol	Description
	Terrain Proximity Enabled and Available Indicator
	Terrain Proximity Enabled and Not Available Indicator
	Traffic Enabled and Available Indicator
	Traffic Enabled and Not Available Indicator

Table 7-5 Map Tool Bar Symbols

7.7 XM Weather Tool Bar Symbols













Symbol	Description
	NEXRAD
	Cloud Top (Cloud Top and Echo Top Mutually Exclusive)
	Echo Top (Cloud Top and Echo Top Mutually Exclusive)
	XM Lightning
	Cell Movement
	SIGMETs / AIRMETs
	METARs
	City Forecast
	Surface Analysis
	Freezing Levels
	Winds Aloft
	County Warnings
	Cyclone Warnings

Table 7-6 XM Weather Tool Bar Symbols

Foreword

System
Sec 1

PFD
Sec 2

MFD
Sec 3

Avoidance
Hazard
Sec 4

Additional
Features
Sec 5

Annun.
& Alerts
Sec 6

Symbols
Sec 7

Glossary
Sec 8

Appendix A

Appendix B
Index

7.8 Miscellaneous Symbols

















Symbol	Description
	Default Aircraft (ownership)
	Fixed Wing, Low Wing
	Fixed Wing, High Wing
	Fixed Wing, Jet
	Default Map Cursor
	Measuring Cursor
	MFD Wind Vector (w/ valid GPS solution)
	PFD Wind Vector styles
	Parallel Track Waypoint
	Restricted/Prohibited/Warning/Alert
	TFR (Temporary Flight Restrictions)
	MOA
	Class B Airspace
	Class C Airspace
	Class D Airspace
	User Waypoint

Table 7-7 Miscellaneous Symbols

Foreword
 Sec 1 System
 Sec 2 PFD
 Sec 3 MFD
 Sec 4 Hazard Avoidance
 Sec 5 Additional Features
 Sec 6 Annun. & Alerts
 Sec 7 Symbols
 Sec 8 Glossary
 Appendix A
 Appendix B Index

8 GLOSSARY

ACT, ACTV	active, activate	Foreword
ADC	Air Data Computer	
ADF	Automatic Direction Finder	
ADI	Attitude Direction Indicator	
AFF	Automatic Flight Following	Sec 1 System
AFM	Airplane Flight Manual	
AFMS	Airplane Flight Manual Supplement	
AGL	Above Ground Level	Sec 2 PFD
AHRS	Attitude and Heading Reference System	
AIM	Airman's Information Manual	
AIRMET	Airman's Meteorological Information	Sec 3 MFD
ALT	altitude	
AP	autopilot	
APR	approach	
APT	airport, aerodrome	Sec 4 Hazard Avoidance
ARINC	Aeronautical Radio Incorporated	
ARSPC	airspace	
ARTCC	Air Route Traffic Control Center	
AS	airspeed	Sec 5 Additional Features
ASOS	Automated Surface Observing System	
ATC	Air Traffic Control	
ATCRBS	ATC Radar Beacon System	Sec 6 Annun. & Alerts
ATIS	Automatic Terminal Information Service	
AUX	auxiliary	
AWOS	Automated Weather Observing System	Sec 7 Symbols
BARO	barometric setting	
BC	backcourse	
Bearing	The compass direction from the present position to a destination waypoint	Sec 8 Glossary
BRG	bearing	
C	center runway	
°C	degrees Celsius	Appendix A
CDI	Course Deviation Indicator	
CHNL	channel	
CLD	cloud	
CLR	clear	Appendix B Index
CONFIG	configuration	

	Course	The line between two points to be followed by the aircraft
Foreword	Crosstrack Error	The distance the aircraft is off a desired course in either direction, left or right
	CRS	course
Sec 1	CRSR	cursor
System	CTA	Control Area
	CTRL	control
	CUM	The total of all legs in a flight plan.
Sec 2		
PFD		
	D ALT	density altitude
Sec 3	DB, DBASE	database
MFD	DCLTR, DECLTR	declutter
	deg	degree
	DEP	departure
Sec 4	Desired Track (DTK)	The desired course between the active "from" and "to" waypoints
Hazard Avoidance		
	DEST	destination
Sec 5	DFLT	default
Additional Features	DIS	distance
	Distance	The 'great circle' distance from the present position to a destination waypoint
Sec 6	DME	Distance Measuring Equipment
Annun. & Alerts	DP	Departure Procedure
	DPRT	departure
Sec 7	DSBL	disabled
Symbols	DTK	Desired Track
	EDR	Excessive Descent Rate
Sec 8	ELEV	elevation
Glossary	EMI	Electromagnetic Interference
	ENR	en route
Appendix A	En Route Safe Altitude	The recommended minimum altitude within ten miles left or right of the desired course on an active flight plan or direct-to
Appendix B	ENT	enter
Index	ERR	error
	ESA	En route Safe Altitude
	ETA	Estimated Time of Arrival
	ETE	Estimated Time En Route

°F	degrees Fahrenheit	
FAA	Federal Aviation Administration	Foreword
FCC	Federal Communication Commission	
FCST	forecast	
FD	flight director	
FIS-B	Flight Information Services-Broadcast	Sec 1
FISDL	Flight Information Service Data Link	System
FLTA	Forward Looking Terrain Avoidance	
FPL	flight plan	
FREQ	frequency	Sec 2
FRZ	freezing	PFD
FSS	Flight Service Station	
ft	foot/feet	Sec 3
		MFD
G/S, GS	glideslope	
GDC	Garmin Air Data Computer	Sec 4
GDL	Garmin Satellite Data Link	Hazard
GDU	Garmin Display Unit	Avoidance
GEO	geographic	
GLS	Global Navigation Satellite Landing System	Sec 5
GMA	Garmin Audio Panel System	Additional
GMT	Greenwich Mean Time	Features
GMU	Garmin Magnetometer Unit	
GPS	Global Positioning System	Sec 6
GPSS	GPS Roll Steering	Annun. & Alerts
Ground Speed	The velocity that the aircraft is travelling relative to a ground position	Sec 7
Ground Track	<i>see Track</i>	Symbols
GRS	Garmin Reference System	
GS	Ground Speed	
GTX	Garmin Transponder	Sec 8
		Glossary
HDG	heading	
Heading	The direction an aircraft is pointed, based upon indications from a magnetic compass or a properly set directional gyro	Appendix A
HFOM	Horizontal Figure of Merit	
Hg	mercury	Appendix B
hPa	hectopascal	Index
HPL	Horizontal Protection Level	

		HSDB	High-Speed Data Bus
		HSI	Horizontal Situation Indicator
	Foreword	Hz	Hertz
		IAF	Initial Approach Fix
	Sec 1	ICAO	International Civil Aviation Organization
	System	IFR	Instrument Flight Rules
		IGRF	International Geomagnetic Reference Field
	Sec 2	ILS	Instrument Landing System
	PFD	IMC	Instrument Meteorological Conditions
		IOI	Imminent Obstacle Impact
		INFO	information
	Sec 3	in HG	inches of mercury
	MFD	INT	intersection(s)
		INTEG	integrity (RAIM unavailable)
		ITI	Imminent Terrain Impact
	Sec 4		
	Hazard		
	Avoidance		
		L	left, left runway
	Sec 5	LAT	latitude
	Additional	LCD	Liquid Crystal Display
	Features	LCL	local
		LED	Light Emitting Diode
	Sec 6	Leg	The portion of a flight plan between two waypoints
	Annun.	LIFR	Low Instrument Flight Rules
	& Alerts	LNAV	Lateral Navigation
		LOC	localizer
	Sec 7	LOI	loss of integrity (GPS)
	Symbols	LON	longitude
		LPV	Localizer Performance with Vertical guidance
	Sec 8	LRU	Line Replacement Unit
	Glossary	LT	left
		LTNG	lightning
	Appendix A		
		MAG	Magnetic
		MAG VAR	Magnetic Variation
	Appendix B	MapMX	A proprietary data format used to forward navigation information from the GNS units to the GDU 620
	Index	MAX	maximum
		MAXSPD	maximum speed (overspeed)

MDA	barometric minimum descent altitude	
METAR	Aviation Routine Weather Report	
MFD	Multi Function Display	Foreword
MIN	minimum	
Minimum Safe Altitude	Uses Grid MORAs to determine a safe altitude within ten miles of the aircraft present position	Sec 1
MKR	marker beacon	System
MOA	Military Operations Area	
MOV	movement	
mpm	meters per minute	Sec 2
MSA	Minimum Safe Altitude	PFD
MSG	message	
MSL	Mean Sea Level	
MT	meter	Sec 3
mV	millivolt(s)	MFD
MVFR	Marginal Visual Flight Rules	
NAV	navigation	Sec 4
NAVAID	NAVigation AID	Hazard Avoidance
NCR	Negative Climb Rate	
NDB	Non-Directional Beacon	Sec 5
NEXRAD	Next Generation Radar	Additional Features
OAT	Outside Air Temperature	Sec 6
OBS	Omni Bearing Selector	Annun. & Alerts
PA	Proximity Advisory	Sec 7
PC	personal computer	Symbols
PDA	Premature Descent Alert	
PFD	Primary Flight Display	
P. POS	Present Position	
PTK	parallel track	Sec 8
QTY	quantity	Glossary
		Appendix A
		Appendix B
		Index

	R	right, right runway
	RAIM	Receiver Autonomous Integrity Monitoring
	RAM	random access memory
Foreword	REF	reference
	REQ	required
Sec 1	REV	reverse, revision, revise
System	RMI	Radio Magnetic Indicator
	RNG	range
	RNWX	runway
Sec 2	ROC	Reduced Required Obstacle Clearance
PFD	RT	right
	RTC	Reduced Required Terrain Clearance
Sec 3		
MFD	SBAS	Satellite-Based Augmentation System
	SCIT	Storm Cell Identification and Tracking
Sec 4	SD	Secure Digital
Hazard	SFC	surface
Avoidance	SIAP	Standard Instrument Approach Procedures
	SID	Standard Instrument Departure
Sec 5	SIGMET	Significant Meteorological Information
Additional	SLP/SKD	slip/skid
Features	SMBL	symbol
	SPD	speed
Sec 6	SRVC, SVC	service
Annun.	STAR	Standard Terminal Arrival Route
& Alerts	STATS	statistics
	STBY	standby
Sec 7	STD	standard
Symbols	SUA	Special Use Airspace
	SUSP	suspend
Sec 8	SVT	Synthetic Vision
Glossary	SW	software
	SYS	system
Appendix A	T	true
	TA	Traffic Advisory
Appendix B	TACAN	Tactical Air Navigation System
Index	TAF	Terminal Aerodrome Forecast
	TAS	True Airspeed
	TAS	Traffic Advisory System

TAT	Total Air Temperature	
TAWS	Terrain Awareness and Warning System	
TCA	Terminal Control Area	Foreword
TCAS	Traffic Collision Avoidance System	
TEMP	temperature	
TERM	terminal	Sec 1
TFR	Temporary Flight Restriction	System
T HDG	True Heading	
TIS	Traffic Information System	
TMA	Terminal Maneuvering Area	Sec 2
Topo	topographic	PFD
Track	Direction of aircraft movement relative to a ground position; also 'Ground Track'	
TRK	track	Sec 3
TRSA	Terminal Radar Service Area	MFD
UNAVAIL	unavailable	Sec 4
USR	user	Hazard Avoidance
UTC	Coordinated Universal Time	
UTM/UPS	Universal Transverse Mercator/ Universal Polar Stereographic Grid	Sec 5 Additional Features
V, Vspeed	velocity (airspeed)	
VAR	variation	Sec 6
VFR	Visual Flight Rules	Annun. & Alerts
VHF	Very High Frequency	
VLOC	VOR/Localizer Receiver	
VMC	Visual Meteorological Conditions	Sec 7
VNAV, VNV	vertical navigation	Symbols
VOR	VHF Omni-directional Range	
VORTAC	very high frequency omnidirectional range station and tactical air navigation	Sec 8 Glossary
VS	Vertical speed	
VSI	Vertical Speed Indicator	Appendix A
WAAS	Wide Area Augmentation System	
WGS-84	World Geodetic System - 1984	Appendix B
WPT	waypoint(s)	Index
WX	weather	

Foreword
XPDR
XTK

transponder
cross-track

Sec 1
System

Sec 2
PFD

Sec 3
MFD

Sec 4
Hazard
Avoidance

Sec 5
Additional
Features

Sec 6
Annun.
& Alerts

Sec 7
Symbols

**Sec 8
Glossary**

Appendix A

Appendix B
Index

APPENDIX A

SD Card Use and Databases

The G500 System uses Secure Digital (SD) cards to load and store various types of data. For basic flight operations, SD cards are required for database storage as well as database updates.

Database Name	Function	Where Stored	Update Cycle	Provider	Notes
Aviation	Airport, NAVAID, Waypoint, and Airspace information	Internal GDU 620 memory	28 days (on Thursdays)	fly.garmin.com	Updates installed via SD card and copied into internal memory
IGRF model	AHRS magnetic variation model	Internal GRS 77 memory	5 years	fly.garmin.com	Included with Aviation database
SafeTaxi	Airport surface diagrams	SD card	56 days (on Thursdays)	fly.garmin.com	
Terrain	Topographic map, SVT, Terrain/TAWS	SD card	As required	fly.garmin.com	9 arc-second version required for SVT
Airport Terrain	Topographic map, SVT, Terrain/TAWS	SD card	As required	fly.garmin.com	Not required with 9 arc-second Terrain database
Obstacle	Obstacle information for map, SVT, and TAWS	SD card	56 days (on Thursdays)	fly.garmin.com	
Basemap	Boundary and road information	Internal Memory or SD card	As required	fly.garmin.com	
Airport Directory	Airport facility and FBO information	SD card	56 days	fly.garmin.com	Database may be available in different versions. Update cycle and content may vary.
FliteCharts	FAA-published terminal procedures	SD card	28 days (on Thursdays)	fly.garmin.com	Disables 180 days after expiration date.
ChartView	Jeppesen terminal procedures	SD card	14 days (on Fridays)	Contact Jeppesen	Optional feature that requires Garmin dealer enablement. Disables 70 days after expiration date.

Table A-1 Database List

Jeppesen Databases

The aviation database is updated on a 28 day cycle. Aviation database updates are provided by Garmin and may be downloaded from the Garmin web site “fly.garmin.com” onto a Garmin provided Supplemental data card. Contact Garmin at fly.garmin.com for aviation database updates and update kits. The Aviation database is stored internally and the data card is only used to transfer the database into the unit.

The optional ChartView database is updated on a 14 day cycle. The ChartView database is provided directly from Jeppesen. ChartView is an optional feature that requires enablement by a Garmin dealer. Contact Jeppesen (www.jeppesen.com) for ChartView subscription and update information.

Updating the Jeppesen Aviation Database

- 1) With the G500 System OFF, insert the SD card containing the aviation database update into the upper card slot of the GDU 620 to be updated (label of SD card should face up).
- 2) Turn the G500 System ON.
- 3) Verify the correct update cycle is loaded during power-up. Press the **ENT** key to continue or the **CLR** key to cancel loading.

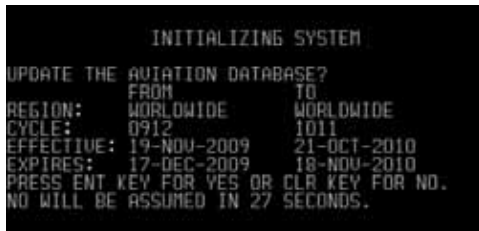

Figure A-1 Database Initialization Display

4) A notice on the display will indicate successful updating of the database.



Figure A-2 Database Loading Completed

5) The following display will show the databases and their current status.

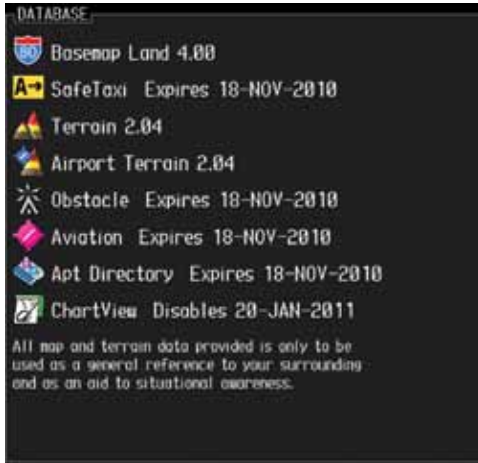

Figure A-3 Database Information on the Splash Screen

- 6) Use the large **MFD** knob to select the AUX page group and then small **MFD** knob to reach the System Status Page.
- 7) Press the **DBASE** soft key to place the cursor in the "DATABASE" window.
- 8) Turn the small **MFD** knob to scroll through the list and check that all databases are current and there are no errors. If a database is highlighted in yellow, it is either expired or the G500 can not determine the date.
- 9) Power down the GDU 620.

Foreword

Sec 1
System

Sec 2
PFD

Sec 3
MFD

Sec 4
Hazard
Avoidance

Sec 5
Additional
Features

Sec 6
Annun.
& Alerts

Sec 7
Symbols

Sec 8
Glossary

Appendix A

Appendix B
Index

Garmin Databases



WARNING: *The data contained in the terrain and obstacle databases comes from government agencies. Garmin accurately processes and cross-validates the data, but cannot guarantee the accuracy and completeness of the data.*

The following GDU 620 databases are stored on Supplemental Data Cards provided by Garmin:

- **Terrain** – The terrain database contains terrain mapping data. It is updated periodically and has no expiration date.
- **Airport terrain** – The airport terrain database contains detailed airport terrain data. It is updated periodically and has no expiration date. This database is not required when a 9 arc-second terrain database is in use.
- **Obstacle** – The obstacle database contains data for obstacles, such as towers, that pose a potential hazard to aircraft. Obstacles 200 feet and higher are included in the obstacle database. It is very important to note that not all obstacles are necessarily charted and therefore may not be contained in the obstacle database. This database is updated on a 56-day cycle. Obstacles will still be shown after the database has expired.
- **SafeTaxi** – The SafeTaxi database contains detailed airport diagrams for selected airports. These diagrams aid in following ground control instructions by accurately displaying the aircraft position on the map in relation to taxiways, ramps, runways, terminals, and services. This database is updated on a 56-day cycle. SafeTaxi will still be shown after it has expired.
- **FliteCharts** – The FliteCharts database contains procedure charts for the United States only. This database is updated on a 28-day cycle. If not updated within 180 days of the expiration date, FliteCharts no longer functions.
- **Airport Directory (optional)** – The airport directory database contains airport facility and FBO information. This database is optional and “N/A” will be displayed in white text on the startup screen if the database is not installed. This database may be available in multiple versions with varying update cycles and/or content.

Since these databases are not stored internally in the GDU 620, a Supplemental Data Card containing identical database versions must be kept in each display unit for dual installations. After subscribing to the desired database product,

the database product will need to be downloaded to a Supplemental Data Card. Insert the Supplemental Data Card into the card slot shown in Figure A-4. The upper slot is typically used for updating the navigation database and is then normally left open. The card may be inserted in either slot. The Supplemental Data Card should not be removed except to update the databases stored on the card.

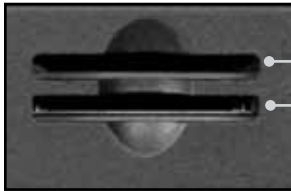

Figure A-4 SD Card Database Location

The Garmin databases can be updated by following the instructions detailed in the “Navigation Databases” section of the Garmin web site (fly.garmin.com). Once the updated files have been downloaded from the web site, a PC equipped with an appropriate SD card reader is used to unpack and program the new databases onto the existing Supplemental Data Cards. The following equipment is required to perform the update:

- Windows-compatible PC computer (Windows 2000, XP, Vista, or Windows 7 recommended)
- SanDisk SD Card Reader, P/Ns SDDR-93 or SDDR-99 or equivalent card reader
- Updated database obtained from the Garmin web site
- Existing Supplemental Database SD Card (P/N 010-00769-xx)

It may be necessary to have the system configured by a Garmin authorized service facility in order to use certain database features.

Updating Garmin databases

- 1) Download the data to the data cards from the appropriate web site.
- 2) Insert Database SD card in an empty card slot of the GDU 620. The SD card containing the ChartView, FliteCharts, SafeTaxi, or any other database (except for the Jeppesen Aviation Database) is typically inserted into the lower slot on the GDU 620.

- 3) Apply power to the G500 System. View the MFD power-up splash screen. Check that the databases are initialized and displayed on the splash screen. When updating the terrain and FliteCharts databases, an “in progress” message may be seen. If this message is present, wait for the system to finish loading before proceeding. Some databases can take up to 15 minutes to update.
- 4) Acknowledge the Power-up Page agreement by pressing the **ENT** key or the right-most soft key. If a database is highlighted in yellow, it is either expired or the G500 can not determine the date.



Figure A-5 Database Information on the Splash Screen

- 5) Use the large **MFD** knob to select the AUX page group and then the small **MFD** knob to reach the System Status Page.
- 6) Press the **DBASE** soft key to place the cursor in the “DATABASE” window.
- 7) Turn the small **MFD** knob to scroll through the list and check that all databases are current and there are no errors.
- 8) Power down the GDU 620.

Foreword
 Sec 1 System
 Sec 2 PFD
 Sec 3 MFD
 Sec 4 Hazard Avoidance
 Sec 5 Additional Features
 Sec 6 Annun. & Alerts
 Sec 7 Symbols
 Sec 8 Glossary
 Appendix A
 Appendix B Index

INDEX

Symbols

1-2 key 2-3

A

Activating XM 5-22
 Active flight plan 2-15, 3-1, 3-71, 3-72, 3-73
 Additional features 5-1
 ADF 1-1, 1-2, 2-2, 2-3, 2-4, 2-28, 8-1
 ADIZ 3-7, 3-12, 3-39
 AFF 3-62
 Age 4-33
 AHRS iii, 1-1, 1-4, 1-7, 1-11, 3-49, 6-2, 6-4, 6-6
 Aircraft symbol 2-9, 2-19, 3-4, 7-6
 Air Data Computer 1-1, 1-4, 2-29
 AIRMETs 4-34, 4-49, 4-102, 7-5
 Airport beacon 7-2
 Airport diagram 5-10, 5-16, A-4
 Airport Directory 3-79, A-4
 Airport signs 2-5, 5-42
 Airspeed Indicator 1-22, 2-5–2-6
 Airspeed reference 1-20, 1-21, 2-8, 3-45
 Airspeed tape 2-6, 2-7, 2-18, 3-45
 Airspeed trend vector 2-5
 Air temperature 1-4, 1-5, 2-1, 2-29
 Airways 3-4, 3-7, 3-12, 3-41
 Alerts 2-14, 2-15, 3-73, 4-3, 4-13, 4-24, 4-27, 6-1
 Altimeter ii, 2-13, 2-15
 Altitude 1-1, 1-4, 1-15, 1-22, 2-11, 2-14, 2-15, 3-23, 3-43, 3-48, 3-51, 3-73, 4-3
 Altitude alerter 2-14, 3-73, 5-8
 Altitude alerting 2-14
 Altitude Bug 1-15, 2-1, 2-13
 Altitude capture 5-32
 Altitude Display Mode 4-15, 4-17
 Altitude minimums 2-15, 3-73, 5-8
 Altitude select 1-15
 Altitude trend vector 2-13

Angle of incidence 4-67
 Annunciations 1-11, 2-14, 2-15, 4-13, 4-19, 4-20, 4-29, 4-30, 5-12, 5-17, 6-1
 Answering a phone call 3-70
 Antenna stabilization 4-81
 Antenna tilt 4-64, 4-66, 4-69, 4-77, 4-81, 4-84
 Approaches 2-24, 2-25, 3-82, 5-2, 5-4, 5-10, 5-13, 5-16, 5-43, 8-1
 Apt Dir 3-79
 AP Test 2-3
 APTSIGNS 2-5
 Arc 4-4, 4-5, 4-7, 4-11
 Arrivals 5-10, 5-16
 Attitude 1-1, 1-4, 1-7, 1-11, 2-9, 2-11, 5-31, 6-4, 8-1
 Attitude and Heading Reference System (AHRS) 1-4, 1-7, 1-11, 6-2
 Attitude Indicator 2-9–2-10
 Aural message 4-14
 Automatic flight following 3-62
 Autopilot 1-1, 2-3, 5-31
 Autopilot disconnect 5-31
 Auto-slewing 2-25
 Auto zoom 3-12, 3-15
 Aux mode 3-43
 AUX - System Status page 5-12
 AUX - System Status Page 5-21
 Aviation map data 3-31

B

Backcourse 2-24, 2-25
 Backlighting 1-23
 Barometric minimum 2-15
 Barometric pressure 1-17, 1-20, 1-22, 2-15, 3-48, 3-52
 Basemap symbols 7-4
 Beacon 7-1, 7-2
 Bearing information 2-27–2-28
 Bearing line 2-28, 4-77, 4-80, 4-81
 Bearing Pointers 2-23, 2-27
 Best glide 2-8, 3-45
 Bezel keys 1-15, 1-17

Foreword

System Sec 1

PF D Sec 2

MFD Sec 3

Hazard Avoidance Sec 4

Additional Features Sec 5

Annun. & Alerts Sec 6

Symbols Sec 7

Glossary Sec 8

Appendix A

Appendix B Index

Blind Alley 4-72
 BRG 1-2 2-3
 Brightness 1-20, 1-21, 1-23, 3-43, 3-44,
 3-84

C

Calibrated gain 4-79
 Call suppression 3-64
 Cautions iv, 3-7, 3-52, 4-14, 4-74, 4-75,
 4-84, 5-31
 CDI 1-15, 1-20, 1-21, 2-2, 2-3, 2-19,
 2-20, 2-21, 2-22, 2-23, 2-25,
 3-43, 3-48, 3-49, 3-71
 CDI source 2-22, 2-25, 2-28
 Cell movement 3-27, 3-28, 4-34, 4-47,
 7-5
 Channel 1-6, 3-3, 3-54, 5-25, 5-26, 5-27,
 5-29
 Chart category 3-75, 3-84, 5-7
 Charts 3-81, 3-84, 5-1, 5-2, 5-8, 5-9,
 5-16, 5-17
 Chart setup 3-84, 5-9
 Chartview 5-1
 ChartView 1-10, 3-81, 5-1, 5-2, 5-10,
 5-12, A-2, A-5

ChartView database 1-10, 5-10, 5-11, A-2
 ChartView subscription 5-12, A-2
 Check attitude 5-31
 City 3-7, 3-74, 3-77, 4-34, 4-67
 City forecast 4-34, 4-53, 4-55, 7-5
 Class B airspace 3-7, 3-34, 7-6
 Class C airspace 3-7, 3-35, 7-6
 Class D airspace 3-7, 3-36, 7-6
 Cloud tops 4-34, 4-44, 4-45, 7-5
 Cloudy 4-35
 Cold front 4-53
 Compass card 2-19, 2-21
 County warnings 4-34, 4-61, 7-5
 Course Deviation Indicator (CDI) 2-19,
 2-20, 2-21–2-22
 Course pointer 2-19, 2-20, 2-21, 2-25
 Course select 1-15, 2-1, 2-23
 Crossfill 1-21, 3-48
 Cross track error 2-22

Current heading 1-15, 2-19, 2-20, 2-21,
 2-24
 Current track indicator 2-19, 2-21
 Cursor 1-17, 3-8, 3-9, 3-10, 3-11, 3-44,
 3-46, 3-47, 3-77, 3-79, 7-6
 Customizing maps 3-11
 Customizing Nav Map pages 3-11
 Cycle number 5-11, 5-16, 5-20
 Cyclone 4-33, 4-34, 7-5

D

Database 1-4, 1-13, 3-12, 3-55, 4-3,
 4-4, 4-8, 4-51, 4-53, 4-105, 5-10,
 5-16, 5-20, 6-7, 6-10, A-1, A-4
 Databases 1-10
 Data fields 3-72, 3-73
 Data link 1-2, 1-6, 4-22, 4-31, 4-33, 4-37,
 4-40, 4-43, 4-45, 4-46, 4-48,
 4-50, 4-52, 4-54, 4-55, 4-57,
 4-59, 4-60, 4-62, 4-85, 4-90,
 4-99, 4-101, 4-104, 4-106, 4-108,
 4-109
 Data Link Receiver troubleshooting 5-30
 Date 1-20, 1-21, 3-43, 3-50, 5-11, 5-16,
 5-20, 6-10, A-4
 Day view 3-84, 5-9
 DCLTR soft key 3-1, 3-6, 5-18, 5-19
 Decision Height (DH) 3-71
 Declutter 2-11, 3-3, 3-6, 3-7, 3-30, 5-19
 Departures 5-10, 5-16
 Display brightness 1-20, 1-21, 1-23, 3-43,
 3-44
 Display map 3-2
 Display units 1-20, 1-22, 2-34, 3-43,
 3-51, 3-52
 Distance 1-20, 1-22, 3-8, 3-10, 3-11,
 3-15, 3-16, 3-51, 3-71, 3-74
 Distance measuring 3-10
 DME 7-1
 DP 5-10, 5-16
 Dual installation 1-20, 2-16, 3-48, 3-74,
 5-8, A-4

E

Echo tops 4-34, 4-38, 4-42, 4-43, 4-44, 7-5
 ETA 3-71
 Expiration time 4-31, 4-33
 Exposure level 4-68
 External TAWS 4-9
 Extreme attitude 2-11
 Extreme Pitch 2-11, 5-48
 Extreme Roll 2-12

F

Facility 3-74, 3-76, 3-77
 Fast/Slow indication 2-33
 Field of view 3-12, 3-26, 5-46, 5-47
 Flight director 5-34
 Flight path marker 5-37, 5-41
 Flight plan 1-22, 2-15, 2-24, 3-1, 3-4, 3-15, 3-71, 5-7
 FliteCharts 3-81, 5-1, 5-2, 5-16, A-4, A-6
 FliteCharts database 5-16, A-6
 Flood 4-35, 4-61
 Fog 4-35, 4-66
 Forward looking terrain avoidance 4-10, 4-12
 Freezing level 4-34, 4-56, 4-57, 4-77, 7-5
 Frequency 2-20, 2-24, 2-25, 2-26, 2-27, 3-76, 3-78

G

GAD 43 1-1, 1-2, 2-3, 5-31, 6-4
 GDC 74A ii, 1-1, 1-4, 1-5
 GDL 69/69A 1-2, 1-6, 3-27, 3-53, 3-54, 4-1, 5-1, 5-22, 5-24, 5-25, 5-30
 GDL 69 troubleshooting 5-30
 GDU 620 1-1, 1-3
 GDU 1040 1-1
 Geo-reference 3-81
 GFDS 4-85
 Glideslope 2-22, 2-24
 Glossary 8-1
 GMU 44 1-1, 1-2, 1-5
 GPS altitude ii, 4-3
 GPS level of service 2-19, 2-21, 2-28

GPSS 5-34
 Ground mapping 4-83, 4-84
 Ground pointer 2-1, 2-10
 Ground Radar 4-84
 Ground return 4-67, 4-69, 4-84
 Ground speed 2-5, 2-6, 2-11, 5-41
 GRS 77 1-1, 1-4, 1-13, 5-31
 GSR 56 1-5, 3-60, 3-63
 GTP 59 1-1
 GTX 33 1-5, 4-1
 GTX 330/330D 1-5
 GWX 68 3-1, 4-63

H

Hail 4-38, 4-39, 4-66, 4-71, 4-73
 Hazard avoidance 4-1
 Haze 4-35
 Heading 1-7, 1-15, 2-19, 2-20, 3-1, 3-48, 4-15, 4-22, 5-32
 Heading bug 1-15, 2-1, 2-19, 2-20
 Heading select 1-15
 Helipad 7-2
 Heliport 7-1
 Home page 3-5
 Horizon heading 2-5, 5-37, 5-39, 5-42
 Horizon line 2-9
 Horizontal scan 4-63, 4-74, 4-77, 4-80, 4-81, 4-82
 Horizontal Situation Indicator (HSI) 1-3, 1-15, 2-1, 2-19–2-34, 5-42
 Hot spots 5-18, 5-19
 Hrzn Hdg 2-5

I

Icing 4-49, 4-102, 4-103
 Identifier 3-74, 3-75, 3-77, 3-83, 5-4, 5-6, 5-7, 5-13, 5-42
 IFR 4-49, 4-103
 IGRF model 1-4, 1-13
 ILS 2-22, 2-24, 2-25, 2-26, 7-1
 Imminent obstacle impact 4-10
 Imminent terrain impact 4-10
 INFO soft key 3-9, 3-72
 Infra-Red 4-98

Foreword

System
 Sec 1

PFD
 Sec 2

MFD
 Sec 3

Avoidance
 Hazard
 Sec 4

Additional
 Features
 Sec 5

Annun.
 & Alerts
 Sec 6

Symbols
 Sec 7

Glossary
 Sec 8

Appendix A

Appendix B
 Index

Inhibit alerting 4-12
 Intersection 3-7, 3-31, 3-33, 5-19, 7-1
 Iridium 1-5, 3-60, 3-63, 4-1, 4-85

J

Jeppesen 1-10, 3-81, 5-10, A-2
 Jeppesen database A-2, A-5

L

Land data 3-4, 3-12, 3-16, 3-19
 Lateral deviation scale 2-19, 2-21
 Lat/Lon 3-7, 3-8, 3-12, 3-25, 3-74
 LDA 2-25
 Legend 3-12, 3-29, 4-4, 4-31, 4-33, 4-36, 4-37, 4-41, 4-44, 4-58, 4-97, 4-107
 Level 1-20, 1-21, 3-6, 3-7, 3-43, 3-44, 3-84, 4-56, 4-71
 Lighting 1-23, 3-78
 Lightning 3-4, 3-7, 3-27, 3-29, 4-33, 4-34, 4-46, 4-51, 4-90, 4-100, 4-105, 7-5
 Limitations v, 4-8, 4-25, 4-39, 5-18
 Localizer 2-20, 2-22, 2-25, 2-27
 Loc BC 2-25
 LPV 2-24, 2-28
 LRU 1-1, 1-2, 3-3, 3-55, 5-30, 6-10
 Lubber line 2-19, 2-21

M

Magnetometer 1-2, 1-5, 1-8
 Making a phone call 3-69
 Map 3-4
 Map orientation 3-1, 3-4, 3-13, 3-14, 3-74, 4-4, 4-33, 4-40, 4-90
 Map panning 3-8
 Map pointer 3-4, 3-8
 Map range 1-22, 3-2, 3-4, 3-5, 3-6, 3-14, 3-18, 5-18
 Map setup 3-11, 4-12, 5-47
 Map symbols 7-1, 7-4
 Map toolbar symbols 7-4
 Marker beacon 2-30
 Markings 2-7, 5-18, 5-19

Mean Sea Level 4-3
 Measuring distance 3-10
 Menu Key 1-17, 1-19, 3-5, 3-11
 Menus 1-17, 1-19
 Message 2-19, 4-14
 METARs 3-9, 3-71, 3-80, 4-33, 4-34, 4-51, 4-52, 4-90, 4-105, 4-106, 7-5
 MFD 1-1, 1-3, 1-14, 1-17, 3-1
 MFD display units 1-20, 3-43, 3-51
 MFD soft keys 3-3
 Military 3-12, 3-38, 4-39
 Minimum Descent Altitude (MDA) 2-15
 Miscellaneous symbols 7-6
 Miscompare 2-30
 MOA 3-7, 3-12, 3-38, 7-6
 Moving map 1-1, 1-3, 1-17, 3-1, 3-4, 3-12
 MPEL 4-68
 MSL 4-3
 Mute 3-3, 5-28

N

National Weather Service 4-37, 4-49, 4-61, 4-102
 Nav angle 1-20, 1-22, 2-20, 3-52
 Navigation database 1-4, 1-13, A-2, A-5
 Navigation map 1-12, 1-17, 3-1, 3-4, 3-11, 3-74, 4-3, 4-12, 4-31, 5-18, 5-19, 5-46
 Navigation source iii, 2-3, 2-19, 2-22–2-24, 2-27, 2-28, 3-49, 3-71
 Nav range ring 3-4, 3-12, 3-18
 Nav Status Bar 2-1
 Nav status style 3-43, 3-47
 NDB 3-7, 3-12, 3-31, 3-33, 5-19, 7-1
 NEXRAD 3-27, 4-34, 4-37, 7-5
 Legend 4-41
 Limitations 4-39
 Viewing range 4-40
 NEXRAD Legend 3-29
 NEXRAD Viewing Range 3-28
 Night view 3-84, 5-9
 Normal display operation 1-1

North up 3-1, 3-12, 3-14, 4-31, 4-33, 4-90
 NOTAM 5-9, 5-10
 Notes v
 NRST 3-84, 5-7

O

OAT 1-4, 1-5, 2-29
 OBS 1-15, 2-19, 2-23, 2-28, 3-15, 3-49, 8-5
 Obstacle data 3-23, 4-3, A-4
 Obstacles 3-16, 3-19, 3-23, 4-3, 4-8, 4-27, 5-45, 7-3, A-4

Obstructions 4-8
 Occluded front 4-54
 Operating distance 4-68
 Other airspace 3-39
 Outside air temperature 1-4, 1-5, 2-1, 2-29
 Overspeed 2-6
 Overview 1-1

P

Page group 1-17, 3-2, 3-5
 Page menus 1-17, 1-19, 3-11, 3-12, 3-27, 3-30, 3-31, 3-44, 3-72, 4-5, 4-11, 4-31, 4-33
 Panning 3-8, 3-82, 5-3, 5-19
 Parallel track 7-6
 Parking area 7-2
 Part Sun 4-35
 PFD 1-3, 1-14
 PFD display units 2-34
 PFD options 1-20, 1-21, 3-43, 3-46, 3-47
 PFD soft keys 2-2
 Phone book 3-65
 Phone call 3-69
 Phone volume 3-68
 Photocell 1-23
 Pilot Controlled Lighting 3-78
 Pitch indication 2-9, 2-11
 Pitch scale 2-9, 5-40
 Position reporting 3-3, 3-60
 Power-up 1-4, 1-12, 1-13, 4-28, 5-11,

5-16, 5-20, A-2, A-6
 Precipitation 4-39, 4-42, 4-51, 4-63, 4-64, 4-65, 4-66, 4-74, 4-81, 4-96, 4-105
 Precipitation intensity levels 4-71, 4-78
 Preset 3-3, 5-29
 Product age 4-31, 4-33
 Proximate advisory 7-2
 Proximity advisory 4-16, 4-18

R

Radar 3-1, 4-25, 4-27, 4-37, 4-39, 4-42, 4-63
 Radar altimeter 2-13, 2-32, 3-44
 Radar gain 4-78
 Rainy 4-35
 Range keys 1-17, 3-5, 3-74, 5-3
 Range ring 3-4, 3-12, 3-18, 4-4, 4-16, 4-17, 4-82
 RECENT 3-84, 5-7
 Record of Revisions vi
 Reference speed 2-8
 Reflectivity 4-37, 4-38, 4-39, 4-66, 4-73
 Register with GFDS 4-86
 Restore defaults 3-44, 3-73
 Restricted airspace 3-37
 Roll pointer 2-9
 Roll Scale 2-9, 2-10
 Roll scale pointer 2-1, 2-10
 Roll Scale Zero 2-9
 Route 3-9, 3-71, 5-19
 Runway depiction 5-43
 Runway extension 3-31, 3-32
 Runway information 3-76, 3-78

S

SafeTaxi 1-10, 3-15, 3-31, 3-32, 5-1, 5-18, 5-19, 5-20, A-4, A-5
 SafeTaxi symbols 7-2
 Satellite 3-63
 Scale 2-5, 2-8, 2-9, 2-10, 2-13, 2-19, 2-20, 2-21, 3-4, 3-6, 3-8, 3-12, 3-20, 3-22, 3-30, 4-3, 4-18, 4-83, 5-40

Foreword

System
 Sec 1

PFD
 Sec 2

MFD
 Sec 3

Hazard
 Avoidance
 Sec 4

Additional
 Features
 Sec 5

Annun.
 & Alerts
 Sec 6

Symbols
 Sec 7

Glossary
 Sec 8

Appendix A

Appendix B
 Index

Scroll bars 3-82, 5-3
 SDF 2-25
 Sector scan 4-63, 4-80
 Secure Digital (SD) card 1-10, 2-1, 3-1, A-1
 Selected Altitude 2-11, 2-13, 2-14, 2-15, 3-48, 3-73, 4-58, 4-107
 Selected Course 2-23, 3-48
 Selected Heading 2-20, 3-48
 Serial numbers 3-55, 5-30, 6-10
 Service Class 5-23, 5-24
 SIGMET 4-34, 4-49, 4-50, 4-102, 4-104, 7-5
 Sky pointer 2-10
 Sky representation 2-9, 5-48, 5-49
 Slewing 2-25
 Slip/Skid Indicator 2-1, 2-9
 Snow 4-35, 4-39, 4-66
 Soft keys 1-14, 1-18, 2-1, 2-2, 2-11, 3-1, 3-3, 3-30, 4-29, 5-26, 5-39, 5-41
 Software version 3-55, 5-30, 6-10
 Speed 1-4, 1-20, 1-22, 2-5, 2-8, 2-11, 2-18, 3-17, 3-43, 3-45, 3-51, 4-24
 Speed range 2-7
 STAB 4-81
 Stabilization 4-74, 4-81
 STAR 5-10, 5-16
 Stationary front 4-54
 Sunny 4-35
 Surface analysis 4-34, 4-53, 7-5
 Surface data 4-33, 4-54
 Surface data time 4-33, 4-55
 Surface winds 4-49, 4-103
 Symbols 4-18, 4-24, 4-33, 4-35, 5-44, 7-1
 Synchronization 1-20, 1-21, 3-43, 3-48, 3-49
 Syn Terr 2-4
 Synthetic Vision v, 2-4, 2-5, 3-12, 3-26, 4-10, 4-13, 5-1, 5-37
 Synthetic Vision alerts 4-13
 Syn Vis 2-4
 System description 1-1
 System display units 1-20, 3-43, 3-52
 System power 1-4, 1-11, 1-13

System settings 1-20, 3-43
 System status 3-2, 3-3, 3-55, 4-8, 4-19, 4-28, 5-12, 6-10

T

TACAN 7-1
 TAF 3-9, 3-80, 4-51, 4-105
 TAS 3-30, 4-15, 4-74, 5-1, 5-44
 TAWS-SVT 4-1, 4-10
 TCA 3-12, 3-35
 Temperature 1-20, 1-22, 2-29, 3-52, 4-35
 Temperature probe 1-1, 1-5, 2-29
 Terrain 1-10, 1-22, 2-11, 3-1, 3-16, 3-19, 4-1, 4-3, 4-10, 4-27, 4-67, 4-83, 7-3
 Terrain alerts 4-3, 4-10, 4-13, 4-14, 5-37
 Terrain data 3-12, 3-21, 4-7, 4-8, A-4
 Terrain obstacle symbols 7-3
 Terrain proximity ii, 1-22, 4-1, 4-3, 7-4
 Terrain scale 3-12, 3-22, 4-5
 Terrain-SVT iv, 4-1, 4-10
 TFR 3-4, 3-12, 3-31, 3-40, 7-6
 Thunderstorms 4-35, 4-61, 4-66, 4-70, 4-71, 4-73
 Time 1-20, 1-21, 3-16, 3-43, 3-50, 4-31, 4-33, 4-34, 4-53, 4-55
 Time zone 3-50
 TIS 3-30, 4-22, 4-24, 4-25, 4-27, 5-1, 5-44
 TMA 3-12, 3-34
 To/From Indicator 2-19, 2-20
 Topo data 3-12, 3-19
 Topo scale 3-4, 3-12, 3-20
 Tornadoes 4-35, 4-61, 4-73
 Track indicator 2-19, 2-21
 Track vector 3-4, 3-12, 3-16, 4-26
 Traffic Advisory 3-30, 4-1, 4-15, 4-18, 4-22, 7-2
 Traffic Pop-Up 4-21, 4-28
 Traffic symbols 4-18, 4-24, 5-44, 7-2
 Transponder 1-5, 3-30, 4-1, 4-15, 4-18, 4-22, 4-25, 4-27, 4-29
 Trend Vector 2-5, 2-13, 2-19, 2-21
 True Airspeed 1-22, 2-6, 2-11

True North 2-20, 3-52
Turbulence 4-49, 4-64, 4-66, 4-71, 4-102
Turn Rate 2-19
Turn Rate Indicator 2-19, 2-21

U

Under construction 7-2
Unusual attitude 2-11, 5-48

V

VDI 2-24, 5-41
Version 1-12, 3-55, 4-10, 5-21, A-4
Vertical deviation 2-24
Vertical scan 4-63, 4-71, 4-72, 4-76, 4-78, 4-80
Vertical speed 1-1, 1-4, 1-16, 1-20, 1-22, 2-1, 2-11, 2-13, 2-18, 3-43, 3-48, 3-51
Vertical Speed Indicator (VSI) 1-22, 2-18
Video 3-56
VNAV 2-24, 2-28
VNV 8-7
Voice alert 4-27
Volume 1-6, 3-54, 5-25, 5-28
VOR 1-15, 2-3, 2-20, 2-22, 2-27, 3-1, 3-7, 3-12, 3-31, 3-33, 3-49, 5-19, 7-1
VORTAC 7-1
Vspeeds 2-8, 3-45

W

WAAS 1-7, 2-24
Warm front 4-53, 4-54
Warnings ii
WATCH 4-63, 4-65, 4-81, 4-82
Waypoint information 3-74, 3-76, 3-80, 5-19
Waypoint selection 3-75
Waypoint weather 3-80
Weather 3-27, 3-80, 4-31, 4-85
Weather legend 4-31, 4-36, 4-38
Weather mapping 4-70
Weather product 3-28, 4-31, 4-33, 4-36, 4-40, 4-96, 5-23, 5-24

Weather radar 3-2, 4-1, 4-63
Weather symbols 4-33, 7-5
Wind 1-20, 1-21, 2-29, 3-4, 3-12, 3-17, 3-43, 3-46, 4-34, 4-35, 4-49, 4-51, 4-58, 4-103, 4-105, 4-107, 7-5, 7-6
Winds aloft 4-34, 4-58, 4-107, 7-5
Winds aloft altitude 4-60, 4-109
Wind speed 3-17
Wind Up or Down soft keys 3-3, 4-58, 4-60, 4-107, 4-109
Wind vector 1-20, 1-21, 2-29, 3-1, 3-4, 3-12, 3-17, 3-43, 3-46, 7-6
WX soft key 3-9, 3-72

X

XM 3-53, 3-54, 4-31, 5-22
XM channel categories 5-26
XM entertainment radio 5-22
XM radio activation 5-22
XM radio channel presets 5-29
XM radio channels 5-27
XM radio volume 5-28
XM Satellite Radio 1-6, 5-22
XM troubleshooting 5-30
XM weather 3-72, 4-31
XM weather/radio 1-6
XM weather toolbar symbols 7-5
XTK 2-22

Z

Zero pitch line 5-41

Foreword

System
Sec 1

PFD
Sec 2

MFD
Sec 3

Avoidance
Hazard
Sec 4

Additional
Features
Sec 5

Annun.
& Alerts
Sec 6

Symbols
Sec 7

Glossary
Sec 8

Appendix A

Appendix B
Index

Foreword

Sec 1
System

Sec 2
PFD

Sec 3
MFD

Sec 4
Hazard
Avoidance

Sec 5
Additional
Features

Sec 6
Annun.
& Alerts

Sec 7
Symbols

Sec 8
Glossary

Appendix A

This page intentionally left blank



© 2012 Garmin Corporation

Garmin International, Inc.
1200 East 151st Street, Olathe, Kansas 66062, U.S.A.
Tel. 913/397.8200 or 800/800.1020
Fax 913/397.8282

Garmin AT, Inc.
2345 Turner Rd., S.E., Salem, Oregon 97302, U.S.A.
Tel. 503/581.8101 or 800/525.6726
Fax. 503/364.2138

Garmin (Europe) Ltd.
Liberty House, Bulls Copse Road, Hounslow Business Park,
Southampton, SO40 9RB, U.K.
Tel. +44 (0) 870 850 1243
Fax +44 (0) 238 052 4004

Garmin Corporation
No. 68, Zhangshu 2nd Road, Xizhi Dist., New Taipei City 221, Taiwan (R.O.C.)
Tel. 886/2.2642.9199
Fax 886/2.2642.9099

Garmin Singapore Pte. Ltd.
46 East Coast Road
#05-06 Eastgate
Singapore 428766
Tel. (65) 63480378
Fax (65) 63480278

www.garmin.com

Part Number 190-01102-02 Rev. E