



StreetPilot® c340™

owner's manual



© Copyright 2005 Garmin Ltd. or its subsidiaries

Garmin International, Inc.
1200 East 151st Street,
Olathe, Kansas 66062, U.S.A.
Tel. 913/397.8200 or 800/800.1020
Fax 913/397.8282

Garmin (Europe) Ltd.
Unit 5, The Quadrangle,
Abbey Park Industrial Estate,
Romsey, SO51 9DL, U.K.
Tel. 44/0870.8501241
Fax 44/0870.8501251

Garmin Corporation
No. 68, Jangshu 2nd Road,
Shijr, Taipei County, Taiwan
Tel. 886/2.2642.9199
Fax 886/2.2642.9099

All rights reserved. Except as expressly provided herein, no part of this manual may be reproduced, copied, transmitted, disseminated, downloaded, or stored in any storage medium, for any purpose without the express prior written consent of Garmin. Garmin hereby grants permission to download a single copy of this manual onto a hard drive or other electronic storage medium to be viewed and to print one copy of this manual or of any revision hereto, provided that such electronic or printed copy of this manual must contain the complete text of this copyright notice and provided further that any unauthorized commercial distribution of this manual or any revision hereto is strictly prohibited.

Information in this document is subject to change without notice. Garmin reserves the right to change or improve its products and to make changes in the content without obligation to notify any person or organization of such changes or improvements. Visit the Garmin Web site (www.garmin.com) for current updates and supplemental information concerning the use and operation of this and other Garmin products.



Garmin[®], StreetPilot[®], and MapSource[®] are registered trademarks and c340[™] is a trademark of Garmin Ltd. or its subsidiaries and may not be used without the express permission of Garmin.

PREFACE

Congratulations on purchasing the Garmin® StreetPilot® c340™. To get the most out of your new navigation system, take the time to go through this owner's manual and learn how to use your unit.

Serial Number

Record the serial number (8-digit number on the back of the unit) in case your c340 needs service or you want to buy more maps.

Serial Number: _____

Contact Garmin

Contact Garmin if you have any questions or if you should encounter any difficulty while using your StreetPilot c340.

In the U.S.A, contact Garmin Product Support by phone at 913/397.8200 or 800/800.1020, Monday–Friday, 8 AM–5 PM Central Time; or by e-mail at sales@garmin.com.

In Europe, contact Garmin (Europe) Ltd. at 44/0870.8501241.

Quick Links

- To find an address, see [page 4](#).
- To understand information on the Map page, see [page 14](#).
- To adjust the backlight brightness, see [page 18](#).
- To clean and store your unit, see [pages 28–29](#).
- To use the practice mode, see [page 21](#).
- To understand safe mode, see [page 21](#).

Preface	i	Setting a Home Location.....	12	Appendix	26
Serial Number.....	i	Going Home.....	12	Mounting the c340 on	
Contact Garmin	i	Changing Your Home Location .	12	Your Dashboard.....	26
Find It and Go!	1	Finding Recently-Found Places	13	Removing the c340 and	
Finding Your Destination	1	Deleting Recently-Found Places	13	the Mount.....	27
Following Your Route.....	2	Viewing the Map and Other		Caring for Your c340	28
Where To?  Where to?	3	Pages	14	Using an SD Card	30
Finding a Place by Spelling the		Viewing the Map Page	14	Purchasing Additional	
Name	3	Trip Information Page.....	15	MapSource® Maps.....	30
Finding an Address	4	Current Route Page.....	16	Using the USB Drivers	
Finding a Place Using the Map	5	Next Turn Page.....	16	and Cable.....	30
Viewing Places on the Map	5	Adding a Detour to a Route..	17	Updating the c340 Software	
Expanding Your Search.....	6	Stopping Your Route	17	and Map Data	31
Adding a Stop to Your Route...	7	Customizing the c340	18	Resetting Your c340	31
My Locations 	8	Adjusting the Brightness.....	18	Custom POIs	
Saving Places You Find	8	Changing the c340's Settings	19	(Point of Interest)	32
Saving Your Current Location .	9	Changing Map Settings.....	20	Traffic Information with an	
Finding Saved Places.....	10	Changing System Settings	21	FM TMC Traffic Receiver ...	33
Editing Saved Places	11	Changing Time	22	Technical Specifications	36
Changing the Name	11	Changing the Traffic Settings...	23	Battery Information	36
Changing the Map Symbol	11	Changing Navigation	24	Software License	
Deleting Saved Places	11	Changing the Language	25	Agreement	37
				Index	38

FIND IT AND GO!

Use the Garmin StreetPilot c340 to find your destination and go to it!

Finding Your Destination

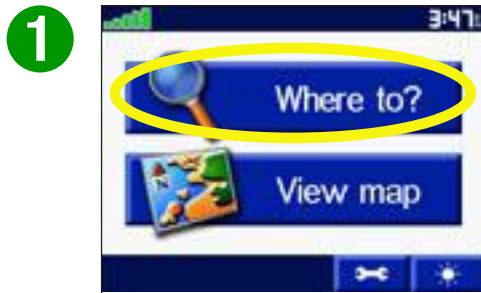

Touch **Where to?**



Select a category.

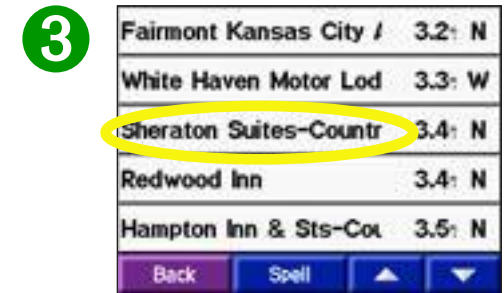

Select a destination.



Touch **Go!**



Enjoy the route!

Following Your Route

Follow the route to your destination using the Map page. As you travel, your c340 guides you to your destination with vocal prompts, turn arrows on the map, and directions at the top of the Map page. If you depart from the original route, your c340 recalculates the route and provides new route instructions.

Read the driving instructions at the top of the page.



Your route is marked with a magenta line.



Follow the arrows as you take turns.



A checkered flag marks your destination.

For more information about using the Map page, see [pages 14–17](#).

WHERE TO?



Finding a Place by Spelling the Name



To enter the name of the place you are looking for, open the Menu page. Touch **Where to?** > **Spell Name**.



Enter a place using the on-screen keyboard. Then touch **Done**.

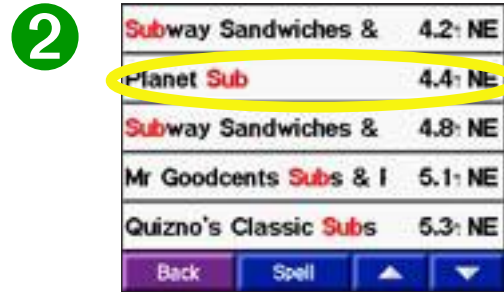

Select the place you want to visit.

Touch **123** to enter numbers. Touch **←** to backspace and delete the last character entered.

If you do not see the place you want to visit in your list of search results or you want to narrow your search results list, touch **Spell** and enter the name or part of the name.

Where To? Menu

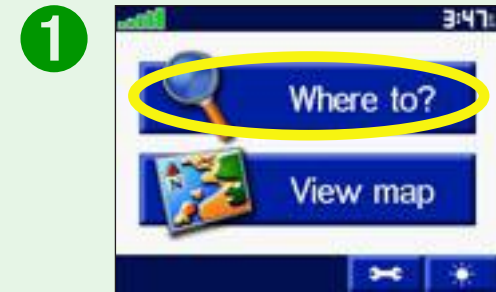

Touch **Where to?**



Touch a category. Touch the arrows to see more categories.

Finding an Address



To find an address, touch **Where to?** from the Menu page. Touch **Address**.



Select a state.



Type the number of the address and touch **Done**.



Type the street name until a list appears or touch **Done**.



Select the street.

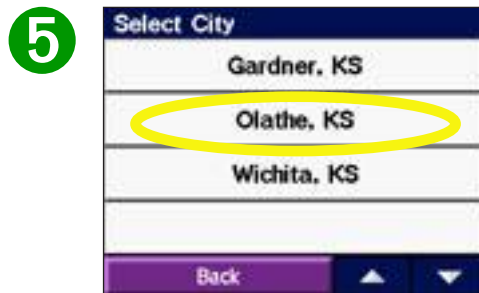

Touch a city, if necessary.



Touch the address, if necessary. Touch **Go!**.

 Finding an intersection is very similar to finding an address; touch **Intersection** and enter the two street names.

Finding a Place Using the Map



Use the Browse Map page to view different parts of the map. Touch **Where to?** > **Browse Map**. Touch any object on the map and touch **Go!**. If the GPS is turned off, touch the **Set Loc.** button to set your location.



Viewing Places on the Map

You can view a place you have found on the Browse Map page.



Touch **Show Map**.



Touch **Back** when you are done.

Browse Map Tips

- Touch the arrows to move the map around.
- Use the **+** and **-** icons to zoom in and out.
- Touch the item you are looking for. An arrow appears pointing at the object you selected.
- Touch **Back** to return to the previous screen.

Expanding Your Search



From the Menu page,
touch **Where To?**
Then touch **Near**.



Select one of the
search options.
Touch **OK**.

Where I Am Now—searches for places near your current location. Your unit automatically uses this option.

A Different City—searches for places near the city you enter. For example, enter “Denver” to search for places near Denver.

My Current Route—searches for places along the route you are currently navigating.

My Destination—searches for places near the end of the route you are currently navigating.

Tip

Your c340 automatically searches for places near your current location.

Adding a Stop to Your Route

You can add a stop (via point) to your route. The c340 gives you directions to the via point and then to your final destination.



Search for your destination. Touch **Go!**.



Search for the extra stop you want to add to your route.



Touch **Go!**.

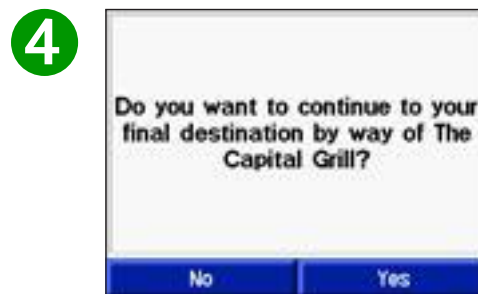

Touch **Yes** to add this stop before your final destination. Touch **No** to replace your original destination with this one.



NOTE: You can add only one via point to your route.

My LOCATIONS

Saving Places You Find



After you have found a place, touch **Save**.



Touch **OK** to close the pop-up window.

Understanding My Locations

You can save all of your favorite places in My Locations. You can also save your home location in My Locations.

Saving Your Current Location

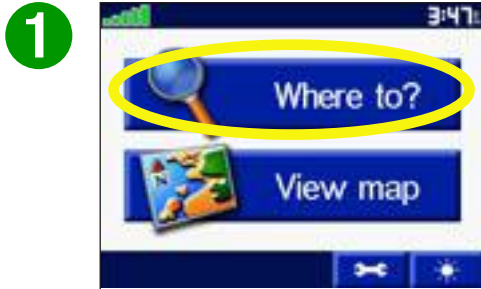

Touch **Where to?**

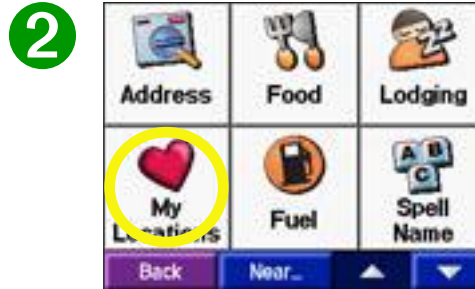

Touch **My Locations.**



Touch **Save.**

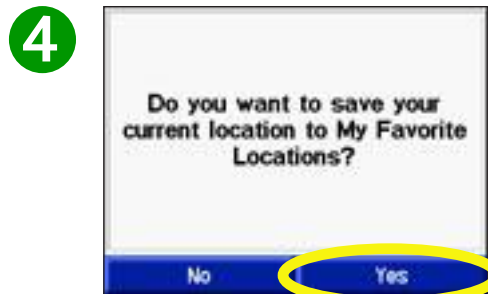

Touch **Yes.**

Finding Saved Places

From the Menu page, touch **Where to?** > **My Locations**.

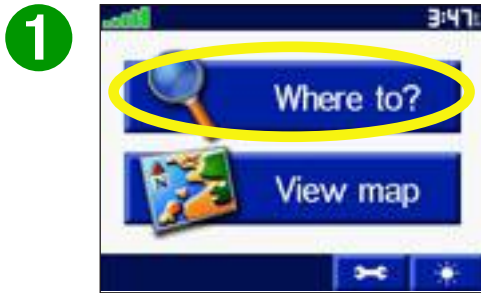

Touch **Where to?**

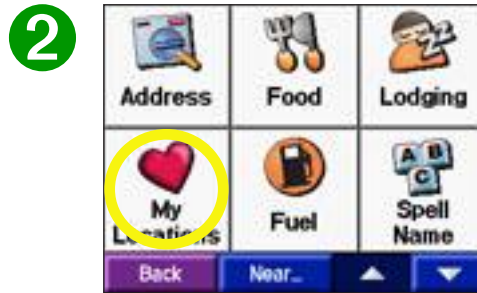

Touch **My Locations**.



Touch **Favorites**.



Select the place you want to visit.

Editing Saved Places

After you save a place, you can change the name of the place and its symbol on the map. From the Menu page, touch **Where to?** > **My Locations**.



Touch **Favorites**.

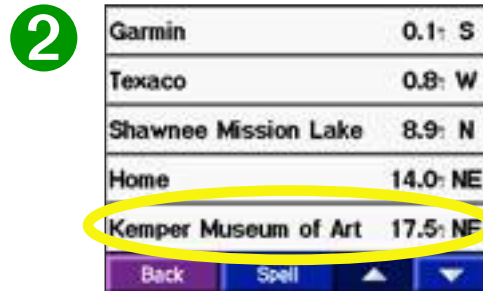

Select the place you want to edit.



Touch **Edit**.



Touch a button to change the name or the map symbol, or to delete the item.

Changing the Name

To change the name of the saved place, touch **Change Name**. Enter the new name using the on-screen keyboard. Touch **Done**.

Changing the Map Symbol

To change the symbol of this place used on the map, touch **Change Map Symbol**. Select a symbol.

Deleting Saved Places

To delete this saved place, touch **Delete**. Then touch **Yes**.

Setting a Home Location

You can set a Home location for the place you return to most often. After you have set your Home, you can easily **Go Home**.



Touch **Where To?** > **My Locations**.



Touch **Set Home**.

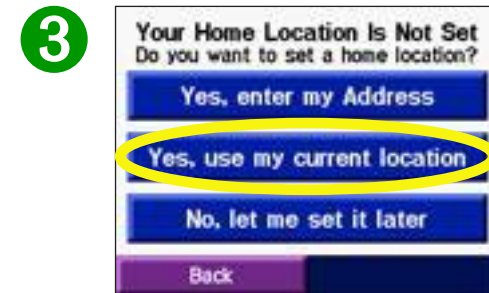

Touch **Yes, use my current location**.

Going Home

Once your Home location is set, you can route to it at any time by touching **My Locations** and then **Go Home**.

Changing Your Home Location

Change your Home location by repeating the steps you took to set it.

Finding Recently-Found Places

Your c340 stores the last 50 of your recent finds in Recent Selections. The most recently viewed places appear at the top of the list. From the Menu page, touch **Where to? > My Locations** to view your recently found items.



Touch **Recent Selections**.



Select an item from the list.

Deleting Recently-Found Places

To remove all places from the Recent Selections list, touch **Clear**. Then touch **Yes**.

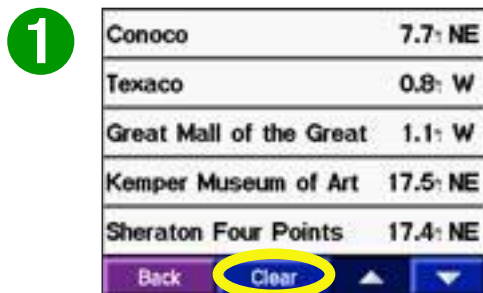

i NOTE: When you touch **Clear**, all items from the list are removed. It does not delete the actual place from your unit's system.

VIEWING THE MAP AND OTHER PAGES

Viewing the Map Page



From the Menu page, touch **View map** to open the Map page. The position icon  shows your current location. Touch buttons on the Map page to see additional information.



Touch  to zoom out.

Touch **Menu** to return to the Menu page.

Touch **Arrival** or **Speed** to open the Trip Information page. See [page 15](#).

Touch the text bar to open the Current Route page. See [page 16](#).

Touch  to zoom in.

Touch **Turn In** to open the Next Turn page. See [page 16](#).

Map Page while Navigating a Route

Trip Information Page

The Trip Information page indicates your current speed and provides helpful statistics about your trip. To view the Trip Information page, touch **Speed** or **Arrival** on the Map page.



Trip Information Page

Resetting Trip Information

If you want accurate trip information, reset the trip information before beginning a trip. If you make frequent stops, leave the c340 turned on so it can accurately measure elapsed time during the trip.

Touch **Reset Trip** to reset the information on the Trip Information page. Touch **Reset Max** to reset the Maximum Speed.

Current Route Page

The Current Route page displays turn-by-turn instructions for your entire route. Touch the green text bar on the top of the Map page to open the Current Route page. This page displays all turns in the route and the distance between turns. Select a turn on the list to view the Next Turn page for that turn. Touch **Show Map** to view the entire route on the Browse Map page.

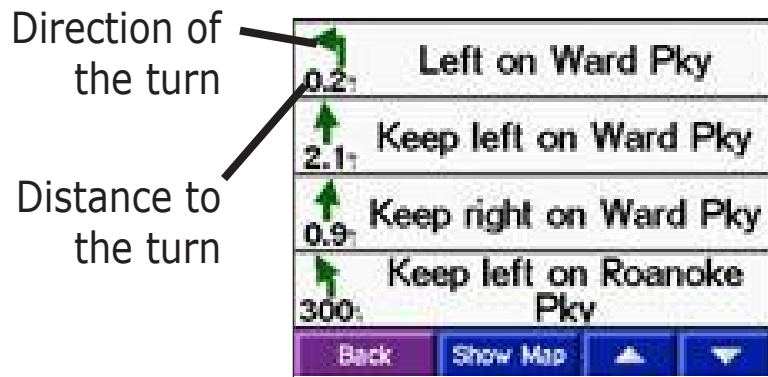

Current Route Page

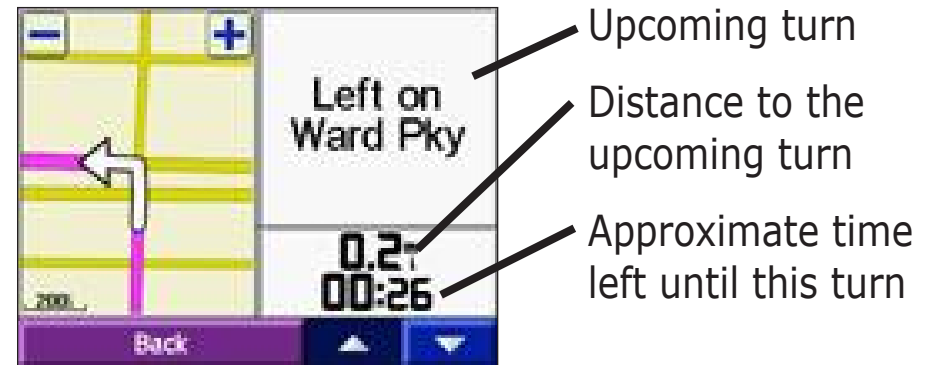

Next Turn Page

Next Turn Page

The Next Turn page shows the turn on the map and the distance and time left before you reach the turn. To view an upcoming turn on the map, touch **Turn In** on the Map page, or select any turn from the Current Route page.

Use the up and down arrows to view other turns in the route. When you are finished viewing the Next Turn page, touch **Back**.

Adding a Detour to a Route

If you need to take a detour from your current route, touch **Detour** from the Menu page. The unit calculates a new route and provides you with new instructions. The c340 attempts to get you back on your original route as soon as possible.

On some routes, the route you are currently taking might be the only reasonable option. In this case, you cannot take a detour.

Stopping Your Route

If you want to stop your current route, return to the Menu page and touch **Stop**.



Touch **Menu** to return to the Menu page.



Touch **Stop** to end navigation. Touch **Detour** and your unit creates a new route if possible.

CUSTOMIZING THE c340

Adjusting the Brightness



Touch  .



Touch the minus and plus signs to adjust the brightness. Touch **OK**.

Changing the c340's Settings

To change c340 settings, touch  from the Menu page. See the following pages for more information.



Touch  to display the Settings page.



Touch the setting you want to change.

Restoring Settings

To restore all settings you have changed, touch **Restore**, as shown below.



To restore settings for an individual category, such as Map, touch the **Restore** button on that particular page.

Changing Map Settings

Map Detail—adjust the amount of detail shown on the map. Displaying more detail causes the map to redraw slowly.

Map View—change the perspective of the Map page.

- **Track Up**—display the map in 2 dimensions (2-D) with your direction of travel at the top.
- **North Up**—display the map in 2-D with North at the top.
- **3 Dimensional**—display the map in 3 dimensions (3-D), Track Up orientation. This is the default map view.

Map Info—list the maps loaded on your c340. Refer to this when you are ready to update your map software.

Restore—restore the original map settings.



Changing System Settings

GPS Mode—set the unit’s GPS receiver. Select **WAAS** to enable the WAAS system. Select **GPS Off** if you want to simulate routes indoors (“practice mode”) with your c340.

Units—change units of measure to kilometers (Metric) or miles (Statute).

Safe Mode—enable or disable the Safe Mode feature to improve driver safety. When your vehicle is moving, Safe Mode disables all unit functions that require significant operator attention and could become a distraction while driving.

Color Mode—select a light background (**Daytime**), a black background (**Nighttime**), or switch between the two automatically (**Auto**).

Proximity Alarms—adjust how you are notified of custom POIs. For more information about custom POIs, see [page 32](#).

About—display your c340’s software version number, unit ID number, and audio version number.

Restore—restore the original system settings.

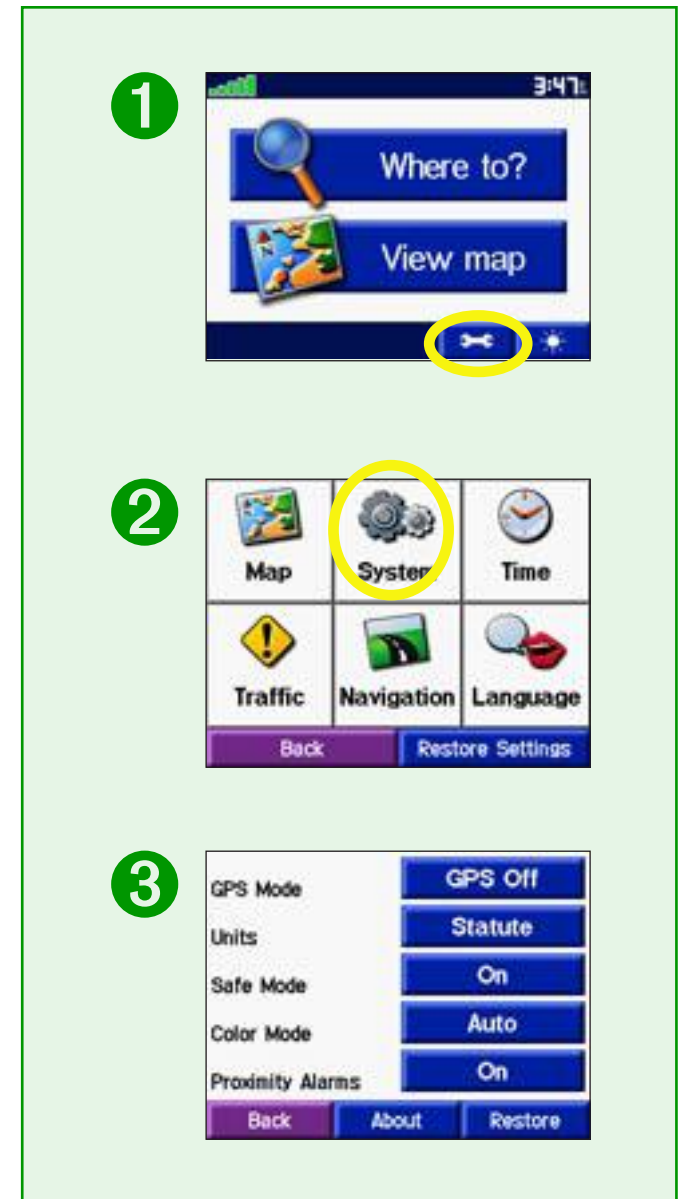

Changing Time

Time Format—choose a 12-hour, 24-hour , or UTC time format.

Time Zone—select a time zone or nearby city from the list.

Daylight Saving—set to **On**, **Off** , or **Auto** if it is available.

Restore Settings—restore the original time settings.



Changing the Traffic Settings

i **NOTE:** You can only access the traffic settings if you are connected to external power and an FM TMC Traffic Receiver, such as a GTM 10.

Your subscriptions and their expiration dates are listed on this page.

Add—add new subscriptions. For more information, see [page 35](#).



Changing Navigation

Route Preference—select a preference for calculating your route. Select **Faster Time** to calculate routes that are faster to drive but can be longer in distance. Select **Shorter Distance** to calculate routes that are shorter in distance but can take more time to drive.

Vehicle—specify your vehicle type to optimize routes.

Avoidances—select **Enabled** to access the road types. Select the road types you want to avoid on your routes. The c340 uses these road types only if alternative routes take you too far out of your way or if no other roads are available. Also use this setting to avoid traffic.



Attention Tone—turn the chime before voice prompts on and off.

Restore Settings—restore the original navigation settings.



Changing the Language

Text Language—change all on-screen text to the selected language. Changing the Text Language does not change the language of map data, such as street names and places, or user-entered data.

Voice Language—change the language for all voice prompts and messages. Your c340 contains two different types of voice languages: text-to-speech and pre-recorded.

Languages noted with a person’s name are text-to-speech (TTS) voices: for example, American English-Jill is a text-to-speech voice. Text-to-speech voices “read” and “speak” the same words that are displayed on the c340. The voices have an extensive vocabulary, and they pronounce the street names as you approach turns.



The pre-recorded voices have a limited vocabulary and do not speak names of locations or streets.

Restore Settings—restore the original language settings.



APPENDIX

Mounting the c340 on Your Dashboard

Use the enclosed mounting disk to mount your unit to the dashboard. California drivers, use the enclosed disk to comply with California regulations: see the *c-series Product Information Sheet* that came in the box for more information.

Important: The permanent mounting adhesive is extremely difficult to remove after it is installed.

To install the mounting disk:

1. Clean and dry the dashboard where you will place the disk.
2. Remove the backing from the permanent mounting adhesive on the bottom of the disk and place the disk on the dashboard.
3. Place the c340 (still mounted to the suction cup mount) on top of the disk. Flip the suction lever to secure the suction cup mount to the disk.

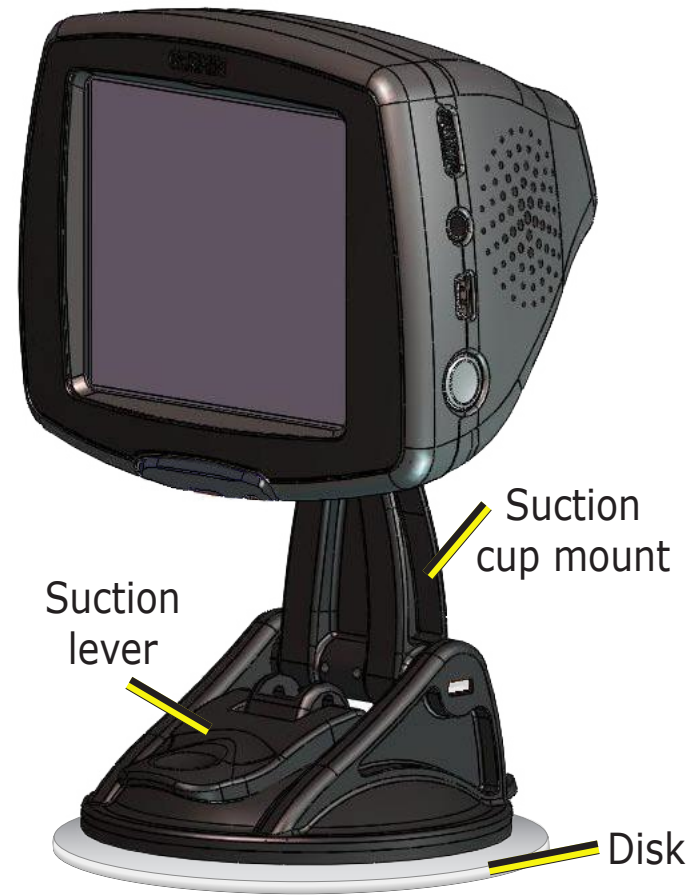

Removing the c340 and the Mount

To remove the unit from the mount, press the indentation on the back of the unit. Then, lift the unit off of the mount.

To remove the suction cup from the windshield, flip the lever toward you and pull the tab on the suction cup toward you.

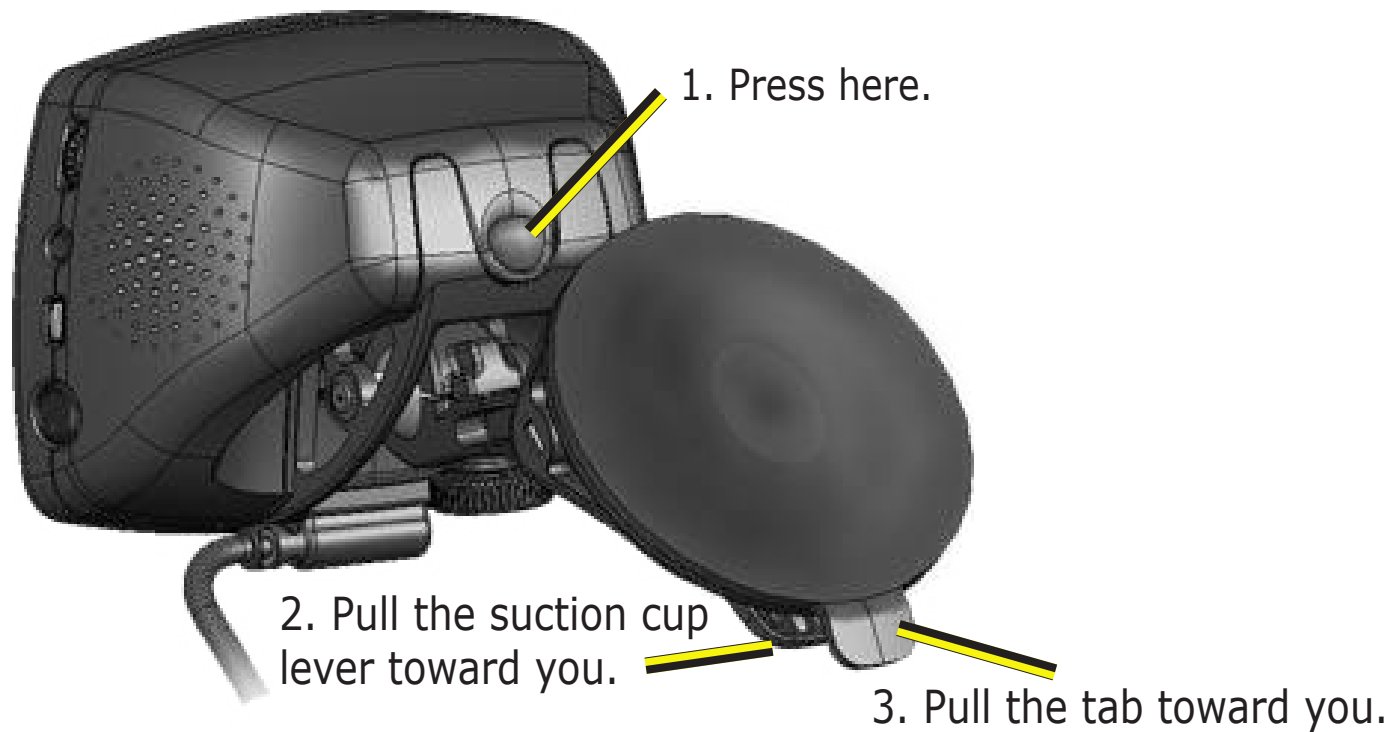

Caring for Your c340

Your c340 contains sensitive electronic components that can be permanently damaged if exposed to excessive shock or vibration. To minimize the risk of damage to your c340, avoid dropping your unit and operating it in high shock/vibration environments.

Cleaning the Unit

The c340 is constructed of high quality materials and does not require user maintenance other than cleaning. Clean the unit's outer casing (except for the touch screen) using a cloth dampened with a mild detergent solution and then wipe dry. Avoid chemical cleaners and solvents that can damage plastic components.

Cleaning the Touch Screen

The touch screen is intended primarily to be operated with a finger. Though a PDA stylus can also be used to operate the touch screen, never attempt this while operating a vehicle. Never use a hard or sharp object to operate the touch screen or damage may result. The touch screen should be cleaned using a soft, clean, lint-free cloth. Water, isopropyl alcohol, or eyeglass cleaner can be used if needed. If these are used, apply the liquid to the cloth and then gently wipe the touch screen.

Calibrating the Touch Screen

If you think the touch screen is not responding properly, you should calibrate (align) the touch screen. Turn the unit off. Press and hold the **Power** button for about one minute until the Calibration screen appears. Follow the on-screen instructions.

Protecting Your c340

Follow the cautions below to protect your c340 from damage:

- Do not store the c340 where prolonged exposure to extreme temperatures can occur (such as in the trunk of a car), as permanent damage may result.
- Do not expose the c340 to water. Contact with water can cause this unit to malfunction.
- Do not leave your c340 in plain sight when you leave your vehicle. Take your unit with you or remove it from view to avoid theft.

Using the c340 Responsibly

Your unit is equipped with a “Safe Mode” feature to improve driver safety. Safe Mode disables certain functions that can distract you while driving. See [page 21](#) for more information.

Using the c340 Indoors

You can set your c340 to indoor use, which stops satellite reception. Use this setting when you are practicing using the unit. To turn off satellite reception, set the unit to **GPS Off**. See [page 21](#).

Using a Remote Antenna

You can use an optional external remote antenna (Garmin GA 27C). This is very helpful when operating the unit in a vehicle with a coated windshield or an in-screen (in the window) heating system, which can block GPS signals. Connect the antenna to the connector located on the back of the c340. To purchase, go to the Garmin Web site at <http://www.garmin.com/products/sp340> and select the **Accessories** link.

Using an SD Card

You can use an SD memory card for additional maps.

Inserting an SD Card

The SD card slot is located on the side of the c340. To insert or remove the card, press it in until it clicks.



Purchasing Additional MapSource® Maps

You can purchase additional MapSource map data from Garmin and download the maps to your SD card. The original maps that came installed on your c340 are protected from overwriting; you cannot accidentally delete them.

Follow the instructions that came with the new map data to properly install the maps to your computer and c340.

In order to enable additional maps, you need your unit ID (see [page 21](#)) and serial number (see [page i](#)).

Using the USB Drivers and Cable

Use the enclosed CD-ROM to install the USB drivers onto your computer. These drivers must be installed before you connect the USB cable to your computer.

Use the Garmin USB cable provided to connect your c340 to your computer. This is necessary when updating your map data, updating the c340 software, or loading additional maps.

Updating the c340 Software and Map Data

Garmin periodically updates its software and map data. If you register your unit, you will receive notification of software and map updates.

Check the Garmin Web site at <http://www.garmin.com/unlock/update.jsp> to see if an update for your map software is available. Also check <http://www.garmin.com/products/sp340/> and select the **Software Updates** link to see if an update to the c340's internal software is available.

See [page 20](#) for instructions on how to find your current MapSource software and version number.

Resetting Your c340

If your unit locks up, press the **Power** button to turn off the unit, then press again to turn the unit back on. If this does not help, reset your c340.

To reset the c340:

1. Place your thumb nail in the groove located under the Garmin logo on the face plate.
2. Gently pull off the face plate.
3. Press the **Reset** button.
4. Turn the unit back on; it will operate normally.

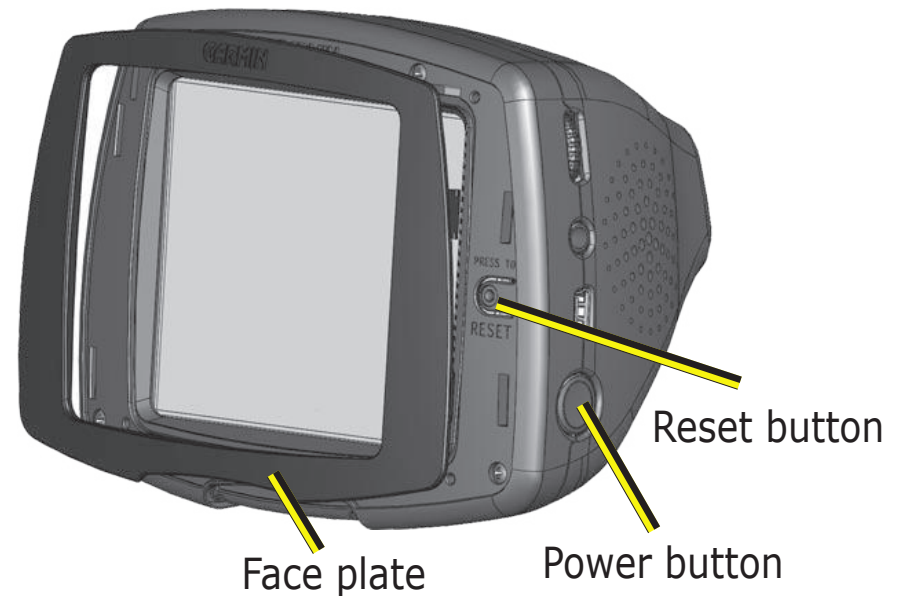

Custom POIs (Points of Interest)

Your c340 will accept custom points of interest (POI) databases, available from various companies on the Internet. Some custom POI databases contain alert information for points such as safety cameras and school zones. Your c340 can notify you when you approach one of these points.

After downloading your POI database, use the Garmin POI Loader to install the POIs into your unit. The POI Loader is available at <http://www.garmin.com/products/sp340>. Select **Updates and Downloads**. Refer to the POI Loader Help File for more information; press F1 to open the Help File.

Custom POIs are stored in **My Locations > Custom POIs**.

Adjusting the Proximity Alarms

To turn on or off the proximity alarms, from the Menu page, touch  > **System > Proximity Alarms**.



CAUTION: *Garmin is not responsible for the consequences of using a custom POI database or the accuracy of the safety camera or other custom POI database.*

Traffic Information with an FM TMC Traffic Receiver

Using a Garmin FM TMC Traffic Receiver, your c340 can receive and use traffic information broadcast over the FM Radio Data System (RDS). When a traffic message is received, your unit displays the event on the map and alters your route to avoid the traffic incident. For more information about the FM TMC Traffic Receiver, visit the Garmin Web site (www.garmin.com). For participating subscription providers, refer to the Garmin Web site at <http://www.garmin.com/fmtraffic>.

Connecting the FM TMC Traffic Receiver to Your c340

Place your c340 in the auto mount and plug in the 12-volt adapter. Plug the Traffic Receiver's mini-USB cable into the mini-USB connector located on the side of the c340.



NOTE: *You can only access the traffic information and settings if the c340 is connected to external power and an FM TMC Traffic Receiver, such as a GTM 10.*

Viewing Traffic Events

1



From the Menu page, touch .

2

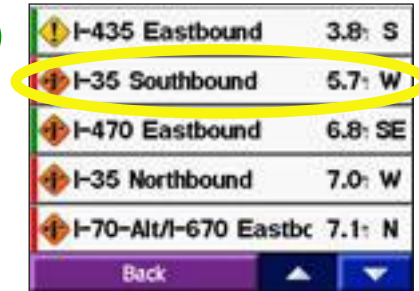

Select an item to view details.

3

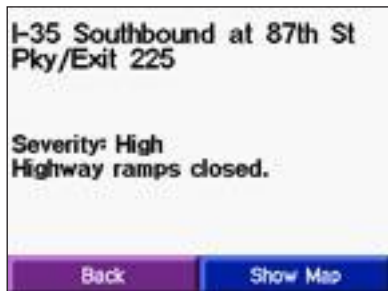

Select an option.

The bars along the left of the traffic events indicate the severity of the incident: green (low), yellow (medium), or red (high).

Traffic Symbols



Road Conditions



Road Construction



Congestion



Accident



Incident



Information

Adding a Subscription

Your FM TMC Traffic Receiver may have a trial subscription or you may be in an area with free service. You can also add subscriptions to expand your service area. You will need your FM TMC Traffic Receiver's Unit ID; see below for directions. Go to <http://www.garmin.com/fmtraffic> to purchase a traffic subscription and obtain a 25-character traffic subscription code.

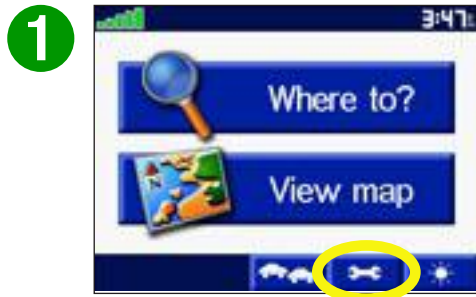

Touch **Traffic**.



Touch **Traffic**.

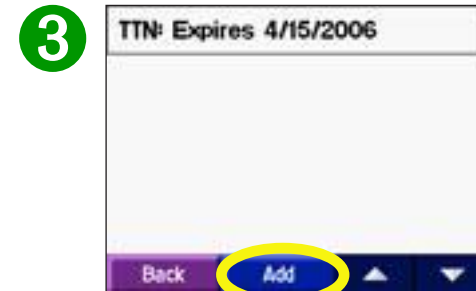

Touch **Add**.

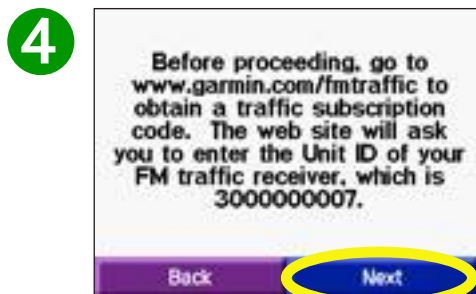

Touch **Next**.



Enter the code and touch **Done**.



Touch **Done**.

Technical Specifications

Size: 4.4" W x 3.2" H x 2.8" D

Weight: 9.45 ounces

Display: QVGA transfective TFT color display, bright white LED backlight, and touch screen

Map Storage: Internal, non-removable memory and an optional removable SD memory card

Temperature: 32°F to 122°F (0°C to 50°C)

Power Supply: AGC/3AG 2 Amp fuse

Charge Time: Approximately three hours to charge

For a complete list of specifications, visit the Garmin Web site at <http://www.garmin.com/products/sp340/spec.html>.

Battery Information

Your unit contains an internal lithium-ion battery. To maximize battery life, limit your c340's prolonged exposure to excessive heat and direct sunlight. Contact your local waste disposal department for information on properly disposing of the unit.

Changing the Fuse

An AGC/3AG 2 Amp, high-breaking capacity, 1500 A-rated fuse is located at the tip of the vehicle adapter. Periodically, you may need to change the fuse. Unscrew the black, round end piece and replace the fuse.

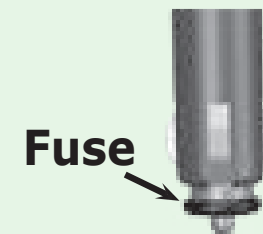

Charging the c340

You can charge the c340 using USB cable (see [page 30](#)) or the car adapter that is connected to the suction mount.

Software License Agreement

BY USING THE c340, YOU AGREE TO BE BOUND BY THE TERMS AND CONDITIONS OF THE FOLLOWING SOFTWARE LICENSE AGREEMENT. PLEASE READ THIS AGREEMENT CAREFULLY.

Garmin grants you a limited license to use the software embedded in this device (the “Software”) in binary executable form in the normal operation of the product. Title, ownership rights, and intellectual property rights in and to the Software remain in Garmin.

You acknowledge that the Software is the property of Garmin and is protected under the United States of America copyright laws and international copyright treaties. You further acknowledge that the structure, organization, and code of the Software are valuable trade secrets of Garmin and that the Software in source code form remains a valuable trade secret of Garmin. You agree not to decompile, disassemble, modify, reverse assemble, reverse engineer, or reduce to human readable form the Software or any part thereof or create any derivative works based on the Software. You agree not to export or re-export the Software to any country in violation of the export control laws of the United States of America.



NOTE: *The Garmin c340 has no user-serviceable parts. Should you ever encounter a problem with your unit, take it to an authorized Garmin dealer for repairs.*



NOTE: *The c340 is fastened shut with screws. Any attempt to open the case to change or modify the unit in any way voids your warranty and may result in permanent damage to the equipment.*

INDEX

Symbols

- 2 Dimensional 20
- 3 Dimensional 20

A

- About button 21
- Adding a Stop to Your Route 7
- Aligning the touch screen 28
- Audio version 21
- Avoid road types 24
- Avoid traffic 24

B

- Backlight brightness 18
- Battery information 36
- Browsing the map 5

C

- Calibrating the touch screen 28
- Caring for your c340 28
- Cleaning 28
- Color mode 21
- Contact Garmin i
- Current location 14
 - saving 9
- Current Route page 16

Customizing the c340 18–25

- language 25
- map 20
- navigation 24
- system 21
- time 22
- traffic 23, 35

Custom POIs (Points of Interest) 32

D

- Daylight Saving 22
- Deleting saved places 11
- Detour, adding 17
- Driving directions 16

E

- Editing saved places (My Locations) 11
- Expanding your search 6

F

- Favorites 10, 11
- Finding places 3–7
 - address 4
 - by name 3
 - intersection 4
 - item on the map 5
 - near other places 6
 - recent selection 13

saved item 10

- FM TMC Traffic Receiver 33–35
- Following your route 2
- Fuse, changing 36

G

- Go Home 12
- GPS
 - issues maintaining a fix 29
 - turn off 21
 - WAAS 21

H

- Home Location 12
 - change home 12
 - go home 12
 - set home 12

I

- Items to avoid 24

K

- Keyboard 3

L

- Language 25
- License agreement 37

M

- Map 5, 14
 - browse 5
 - customize 20
 - zoom 14
- MapSource 30, 31
- Map Info button 20
- Map settings 20
- Map software
 - update 31
 - version 20
- Map symbol 11
- Map view 20
- Metric units 21
- Mounting the c340 26
- Moving the map 5
- My Locations 8
 - Favorites 10, 11
 - Go Home 12
 - Recent Selections 13

N

- Narrow your results list 3
- Navigation Settings 24
- Near button 6
- Next Turn page 16
- North Up 20

O

On-screen keyboard 3

P

Position icon 14

Practice mode 21

Proximity Alarms 32

R

Recently-Found places

delete 13

find 13

Remote Antenna 29

Resetting your c340 31

Reset Max Speed 15

Reset Trip 15

Restore settings 19

S

Safe mode 21, 29

Saved places

change the map symbol 11

change the name 11

delete 11

edit 11

Saving Places

Home location 12

your current location 9

you have found 8

SD Card 30, 36

Serial number i

Software license agreement 37

Software version 21

Spell the name 3

Stop Navigation 17

Store the c340 29

System settings 21

T

Text language 25

Time 22

Time Zone 22

Touch screen

calibrate 28

clean 28

Track Up 20

Traffic 33–35

avoid (route around) 24

events 34

severity 34

subscription 35

symbols 34

Trip Information page 15

Turn-by-turn directions 16

U

Units 21

Unit ID 21

USB 30

Use c340 indoors 21

V

Vehicle type 24

Via point 7

Viewing places on the map 5

Viewing the map 14

Voice Language 25

Z

Zoom 5, 14

For the latest free software updates (excluding map data) throughout the life of your Garmin products, visit the Garmin Web site at www.garmin.com.



© Copyright 2005 Garmin Ltd. or its subsidiaries

Garmin International, Inc.

1200 East 151st Street, Olathe, Kansas 66062, U.S.A.

Garmin (Europe) Ltd.

Unit 5, The Quadrangle, Abbey Park Industrial Estate, Romsey, SO51 9DL, U.K.

Garmin Corporation

No. 68, Jangshu 2nd Road, Shijr, Taipei County, Taiwan

www.garmin.com

Part Number 190-00437-00 Rev. A