



ALWAYS AT YOUR COMMAND

## Models 2022/2024/2042

GARAGE DOOR OPENERS

**Includes: 2-Bulb Light System  
Wall Console**

**Installer:  
Leave this manual  
with homeowner.**

Includes INTELLICODE® Remote Control  
Safe-T-Beam® System must be installed to close door.

For use only with sectional doors.

Homelink® and Car2U® compatible

**For Answers and Assistance:**

1.800.354.3643

or visit [www.geniecompany.com](http://www.geniecompany.com)

**SAVE THIS MANUAL FOR FUTURE REFERENCE**

Homelink® is a registered trademark of  
Johnson Controls Technology Company.

Car2U® is a registered trademark of  
Lear Corporation.

© GMI Holdings, Inc. d/b/a The Genie Company

PN# 37026500123, 5/15/2009

# SAFETY INFORMATION



## OVERVIEW OF POTENTIAL HAZARDS READ THIS SAFETY INFORMATION

Garage doors are large, heavy objects that move with the help of springs under high tension and electric motors. Since moving objects, springs under tension, and electric motors can cause injuries, your safety and the safety of others depend on the owner or user of this system to read, understand and implement the information in this manual. If you have questions or do NOT understand the information presented, contact The Genie Company or an authorized Genie® Dealer.

The safety alert symbol and following signal words **DANGER**, **WARNING**, and **CAUTION** are used throughout this manual to call attention to and identify different levels of hazard and special instructions.







 This is the safety alert symbol. This symbol is placed next to signal words and messages to help you identify important safety information

The word:

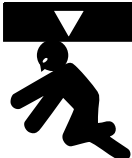
-  **DANGER** indicates an imminently hazardous situation which, if NOT avoided, will result in death or serious injury.
-  **WARNING** indicates a potentially hazardous situation which, if NOT avoided, could result in death or serious injury.
-  **CAUTION** indicates a potentially hazardous situation which, if NOT avoided, may result in injury or property damage.

The word **NOTE** is used to indicate important steps to be followed, important considerations, or location of parts.

## IMPORTANT SAFETY INSTRUCTIONS READ AND FOLLOW ALL INSTRUCTIONS SAVE THESE INSTRUCTIONS

POTENTIAL HAZARD	EFFECT	PREVENTION
 <b>MOVING DOOR</b>	 <b>WARNING:</b> Could result in Death or Serious Injury	Keep people clear of opening while door is moving. <b>Do NOT</b> allow children to play with the door operator. <b>Do NOT</b> operate a door that jams or one that has a broken spring.
 <b>ELECTRICAL SHOCK</b>	 <b>WARNING:</b> Could result in Death or Serious Injury	Turn <b>OFF</b> power before removing operator cover. When replacing cover, make sure wires are not pinched or near moving parts. Operator must be properly grounded.
 <b>HIGH SPRING TENSION</b>	 <b>WARNING:</b> Could result in Death or Serious Injury	Do NOT try to remove, install, repair or adjust springs or anything to which door spring parts are fastened, such as, wood blocks, steel brackets, cables or other like items. Installations, repairs and adjustments must be done by a trained door system technician using proper tools and instructions.

## TABLE OF CONTENTS

SECTION .....	PAGE
SAFETY INFORMATION .....	2
OPENER FEATURES .....	3
SAFETY FEATURES .....	3
PRE-INSTALLATION CHECK LIST .....	4-5
RECOMMENDED TOOLS .....	6
PARTS IDENTIFICATION .....	6-7
KEY ILLUSTRATIONS .....	8
SAFETY INSTALLATION INFORMATION .....	9
<b>INSTALLATION</b>	
1 OPENER ASSEMBLY .....	9-11
2 OPENER INSTALLATION .....	12-14
3 WALL CONTROL INSTALLATION .....	15-16
4 SAFE-T-BEAM® SYSTEM INSTALLATION .....	17-18
5 CONNECTING TO POWER .....	19
<b>ADJUSTMENTS</b>	
6 LIMIT SWITCHES & FORCE ADJUSTMENT .....	20-22
KEYED EMERGENCY RELEASE .....	21
CONTACT REVERSE TEST .....	22
7 PROGRAMMING REMOTE CONTROLS .....	23
8 BATTERY/VISOR CLIP INSTALLATION .....	24
9 LIGHT BULB AND LENS INSTALLATION .....	24
SAFETY INSTRUCTIONS .....	25
<b>MAINTENANCE &amp; TROUBLESHOOTING</b>	
10 ROUTINE MONTHLY MAINTENANCE .....	25
WIRING DIAGRAM .....	26
TROUBLESHOOTING GUIDE - OPENER .....	27
TROUBLESHOOTING GUIDE - POWER HEAD LED .....	28
TRANSMITTER COMPLIANCE STATEMENT .....	29
WARRANTY .....	30

**\*Opener MUST be installed with the included Wall Control.**

**\*\*Safe-T-Beam® Safety Reverse System MUST be installed to close door.**

## OPENER FEATURES

### INTELLICODE® Rolling Code Security System.

An electronic rolling code system that enhances the security of the door opener by continuously changing the access code each time the remote control is used. The door opener responds to each new code only once. An access code copied from a working system and tried again will not control the door opener.

### Lighted Wall Control\*

Operates door opener from inside garage.  
(Refer to section 3)



and Car2U® compatible.

Follow the Homelink® or Car2U® instructions in your car owner's manual.

## SAFETY FEATURES

### Safe-T-Beam® Non-Contact Reversing System\*\*.

Puts an invisible beam across the door opening. The door stops and reverses to the full open position if anything passes through the beam. Red or green LED indicator lights on the power head provide a self diagnostic code if an operational problem exists. (Refer to Section 10.)

### Safe-T-Reverse® Contact Reversing System.

Automatically stops and reverses a closing door within 2 seconds of contact with an object. (Refer to Section 6.)

### Safe-T-Stop® Timed Reversed System.

Automatically opens a closing door if it fails to close completely within 30 seconds.

### ForceGuard™ Control.

Features adjustable open and close force settings. For maximum safety, these must be set to the minimum force required to fully open and close the door. (Refer to Section 6.)

### Relay Monitoring System.

Automatically stops and reverses a closing door if the closing relay malfunctions.

### Watch Dog™ Monitoring System.

Automatically stops and reverses a closing door if the Safe-T-Beam® System\*\* notes an operational problem.

### Automatic Lighting System.

Twin bulb lighting supplies up to 120 watts of light for safer evening exits and entries. Turns ON when door is activated and automatically turns OFF 3 minutes later.

### Manual Emergency Release.

Manually releases door from door opener. Use during a power failure or other emergency to allow manual opening and closing of door. (Refer to Section 6.)

## Things to consider if you are planning to "Do-it-yourself."

This opener is designed for use with **SECTIONAL** doors only.

*In many cases you will be replacing an existing door opener with a new one, however, if this will be the first opener installed there are some pre-installation issues which need to be addressed. They are as follows:*

**The Genie Company recommends that you read and fully understand all information and instructions contained herein before choosing a "Do-it-yourself" installation. Any questions should be directed to The Genie Company or an authorized Genie® Dealer.**

*(The issue numbers below refer to the circled numbers in the illustrations on page 5.)*

- 1** Check your ceiling where the power head of your new unit will be mounted. Plan how you will be mounting the power head. It is possible that ceiling joists may not be in the position needed with respect to the garage door opener. It may be necessary to add an additional bracket and fasteners (not included with your new door opener kit). (Refer to Section 2.)

- 2** Check the wall directly above the garage door. The door opener's header bracket must be securely fastened to this wall. Insure that the structure will provide a strong mounting location. (Refer to Section 2.)

- 3** Check to see if the mounting location for the Safe-T-Beam® System is clear from obstruction and has a wood surface available for attaching the mounting brackets. The brackets may be attached to concrete if necessary but extra tools and special fasteners (not supplied) will be required. (Refer to Section 4 and 5.)

**NOTE: Mounting brackets must be installed within code specifications.**

- 4** Is your sectional garage door made of aluminum, light-weight steel, fiberglass or glass panels? Additional support bracing must be added to these type doors. If this is the case, please contact the door manufacturer or authorized dealer so that they can furnish you with a "bracing kit." (Refer to Section 2.)

### **WARNING**

To reduce the risk of injury to persons or damage to property - Use this opener only with sectional doors.

- 5** You need a properly grounded 110-120 Volt power supply available. The outlet should be no more than 3 feet from the power head once it is mounted. (Refer to Section 5.)

### **WARNING**

**DO NOT USE AN EXTENSION CORD!  
DO NOT USE A PORTABLE GENERATOR! This product is designed to operate on standard house current.  
DO NOT USE ALTERNATE POWER SUPPLIES.**

- 6** To avoid damage to your door and/or opener, make sure you disable and/or remove any door locks, ropes, and/or cables (NOT door lift cables) prior to installing your opener. (Refer to Section 1.)

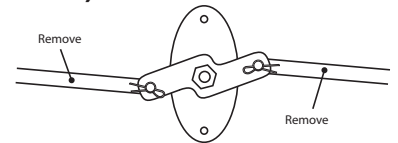

- 7** Insure that your door is properly balanced and moving freely. (Refer to Section 10.)

### **WARNING**

**If your door jams, binds, is improperly balanced or has a broken spring, have it repaired or adjusted by a trained door system technician. Door springs, cables, pulleys, brackets and associated hardware are under extreme tension and can cause serious injury or death.**

- 8** (NOT SHOWN) If your garage does not have a separate entry door, you should consider an emergency release kit (GER-2) for installation on your garage door.



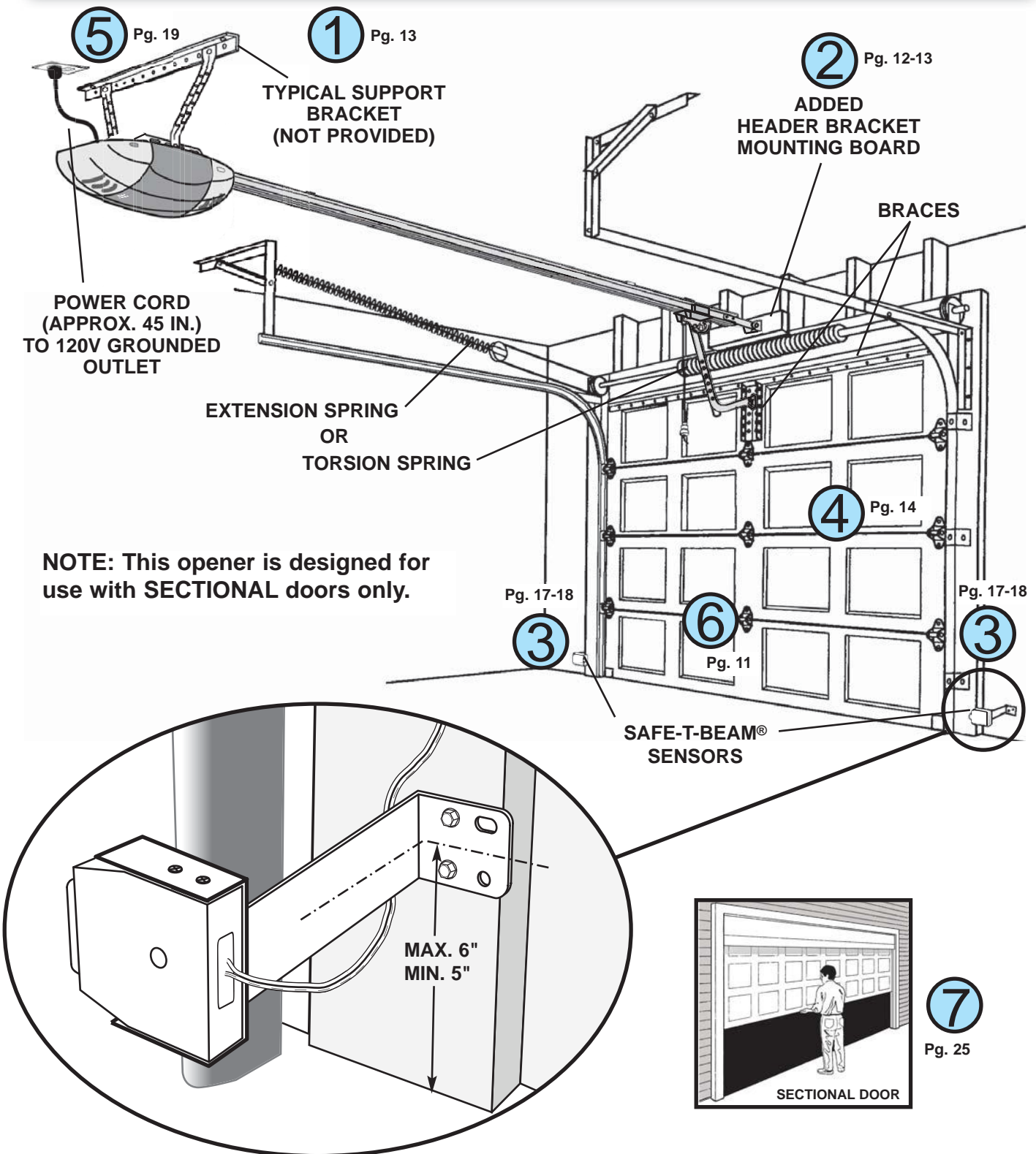

**NOTE:** This opener is designed for use with SECTIONAL doors only.

**⚠ WARNING**  
To reduce the risk of injury to persons or damage to property - Use this opener only with sectional doors.

# RECOMMENDED TOOLS

FOR HELP-1.800.354.3643 OR WWW.GENIECOMPANY.COM

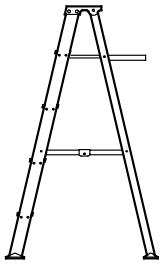

Step ladder

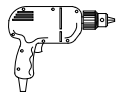

Drill



Safety Glasses



3/16" Drill Bit



Ratchet



Phillips screwdriver



Pencil

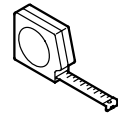

Tape measure



Carpenter's level



Adjustable wrench



Wire strippers



1/4", 7/16", 3/8" and 1/2" Sockets

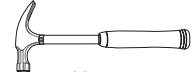

Hammer

# PARTS IDENTIFICATION - Not Shown Full Size .



Safety Brochures

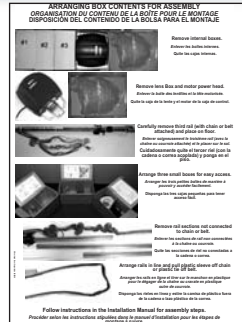

Box Contents Sheet



Entrapment Warning Label

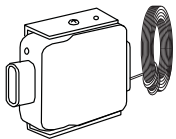

Safe-T-Beam® Source with wire (Red LED)

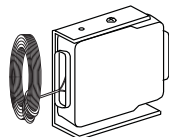

Safe-T-Beam® Sensor with wire (Green LED)



Wire



Header Bracket

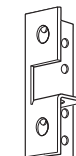

Door Bracket

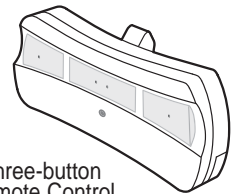

Three-button Remote Control



Insulated Staple



Rail Section Clamp

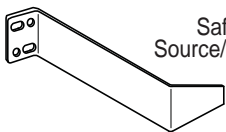

Safe-T-Beam® Source/Sensor Bracket

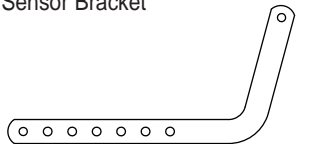

Door Arm



Wall Control

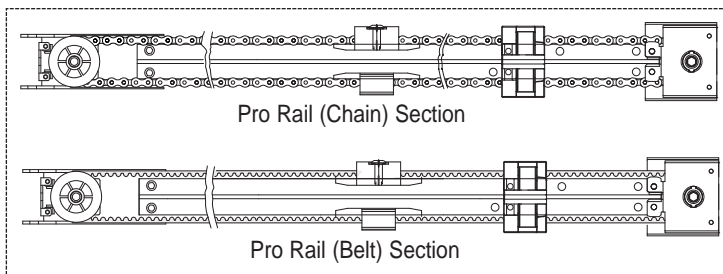

Pro Rail (Chain) Section

Pro Rail (Belt) Section

OR

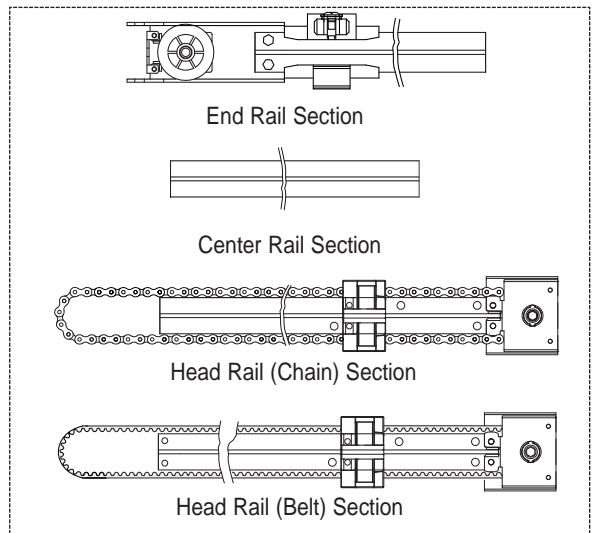

End Rail Section

Center Rail Section

Head Rail (Chain) Section

Head Rail (Belt) Section

**FASTENERS** - Shown Full size (See Parts List below for full description.)

BAG NO.	DESCRIPTION	QUANTITY
0	RAIL SECTION CLAMP	2
	RAIL CLAMP BOLT – 5/16 -18 x 5/8"	8
	HEX FLANGE NUT – 5/16 -18	8
1	BOLT – 5/16 -18 x 1/2"	3
2	CLEVIS PIN, LONG – 5/16" x 3"	1
	COTTER PIN	1
	HEADER BRACKET	1
	LAG SCREW – 5/16" x 2"	2
3	HEX BOLT – 5/16 -18 x 3/4"	5
	HEX FLANGE NUT – 5/16 -18	5
	LAG SCREW – 5/16" x 2"	2
4	SELF DRILLING SCREW – 1/4 -20 x 3/4"	3
	DOOR BRACKET	1
5	HEX BOLT – 5/16 -18 x 3/4"	3
	SELF LOCKING NUT – 5/16 -18	1
	HEX FLANGE NUT – 5/16 -18	2
	CLEVIS PIN – 5/16" x 3/4"	1
	COTTER PIN	1
6	WALL CONTROL ASSEMBLY	1
	PAN HEAD PHILLIPS SCREW – #4-24 x 1"	2
7	13 MM INSULATED STAPLE	30
8	Safe-T-Beam® SOURCE/SENSOR BRACKET	2
	PHILLIPS HEX SCREW – #10-16 x 1- 1/4"	4
	WIRE NUT (GREY)	4
NO NUMBER	REMOTE WITH BATTERY	1
NO BAG	Safe-T-Beam® SOURCE/SENSOR & WIRE SET	1
NO NUMBER	LIGHT COVER - WHITE	2

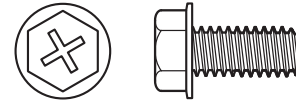

Rail Clamp Bolt - 5/16 -18 x 5/8"



#10-16 x 1-1/4" Phillips Hex Screw



#4-24 x 1" Pan Head Phillips Screw

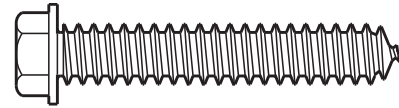

Lag screw - 5/16" x 2"



Wire Nut



Self Locking Nut  
5/16 -18



Self-drilling Screw  
1/4 -20 x 3/4"

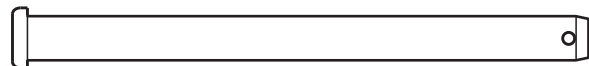

Clevis pin, long 5/16" x 3"

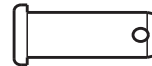

Clevis pin  
5/16" x 3/4"



Cotter pin



Hex Flange Nut  
5/16 -18

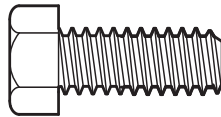

Hex Bolt - 5/16 -18 x 3/4"

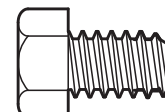

Hex Bolt - 5/16 -18 x 1/2"

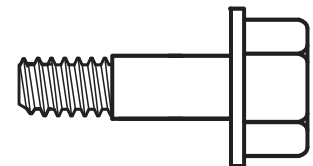

Shoulder Bolt  
5/16 -18 x 1"



Hex Flange Nut  
1/4 -20

**MISSING ANY PARTS?** Please call toll free - 1.800.354.3643  
**DO NOT RETURN TO POINT OF PURCHASE.**  
**IMPORTANT!** - Information needed when calling  
 • Model number - (located on packaging)  
 • Store, city, state, and date of purchase

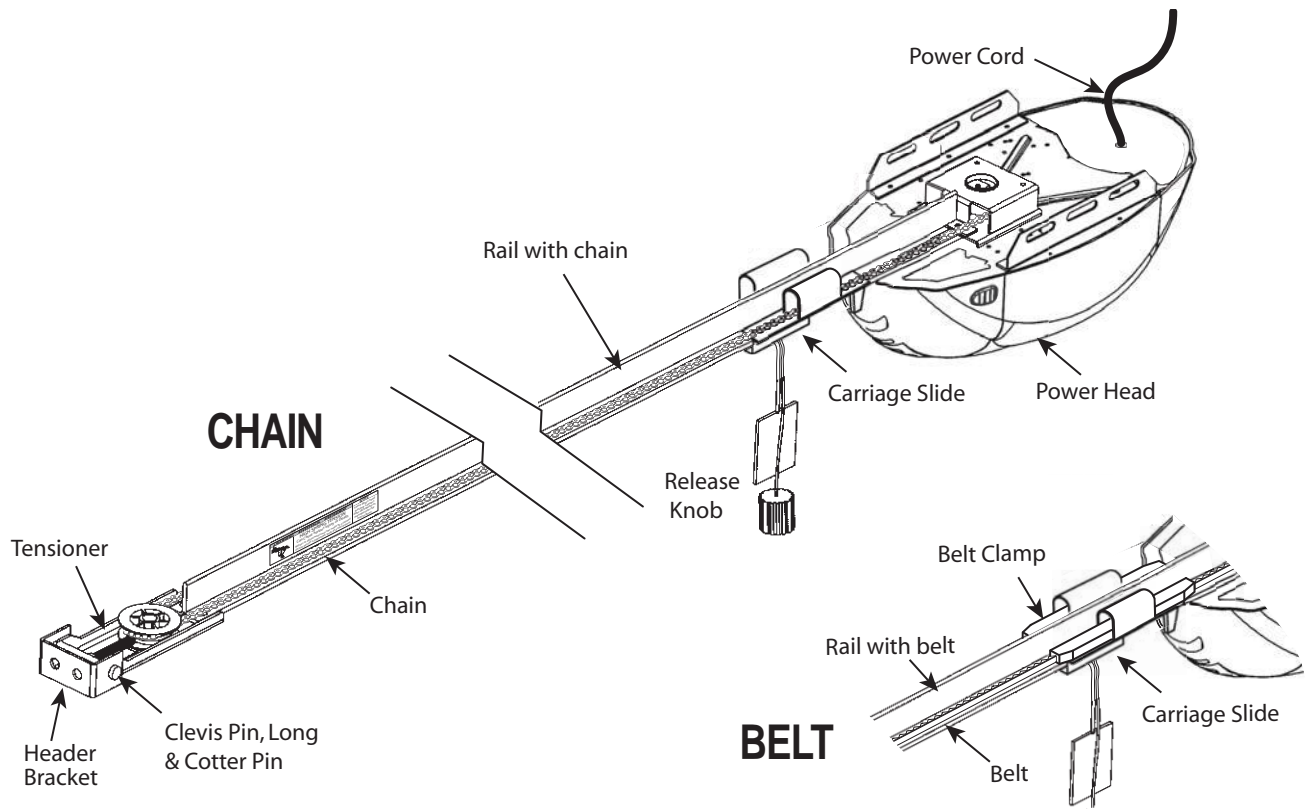

3-PIECE RAIL HARDWARE ASSEMBLED VIEW

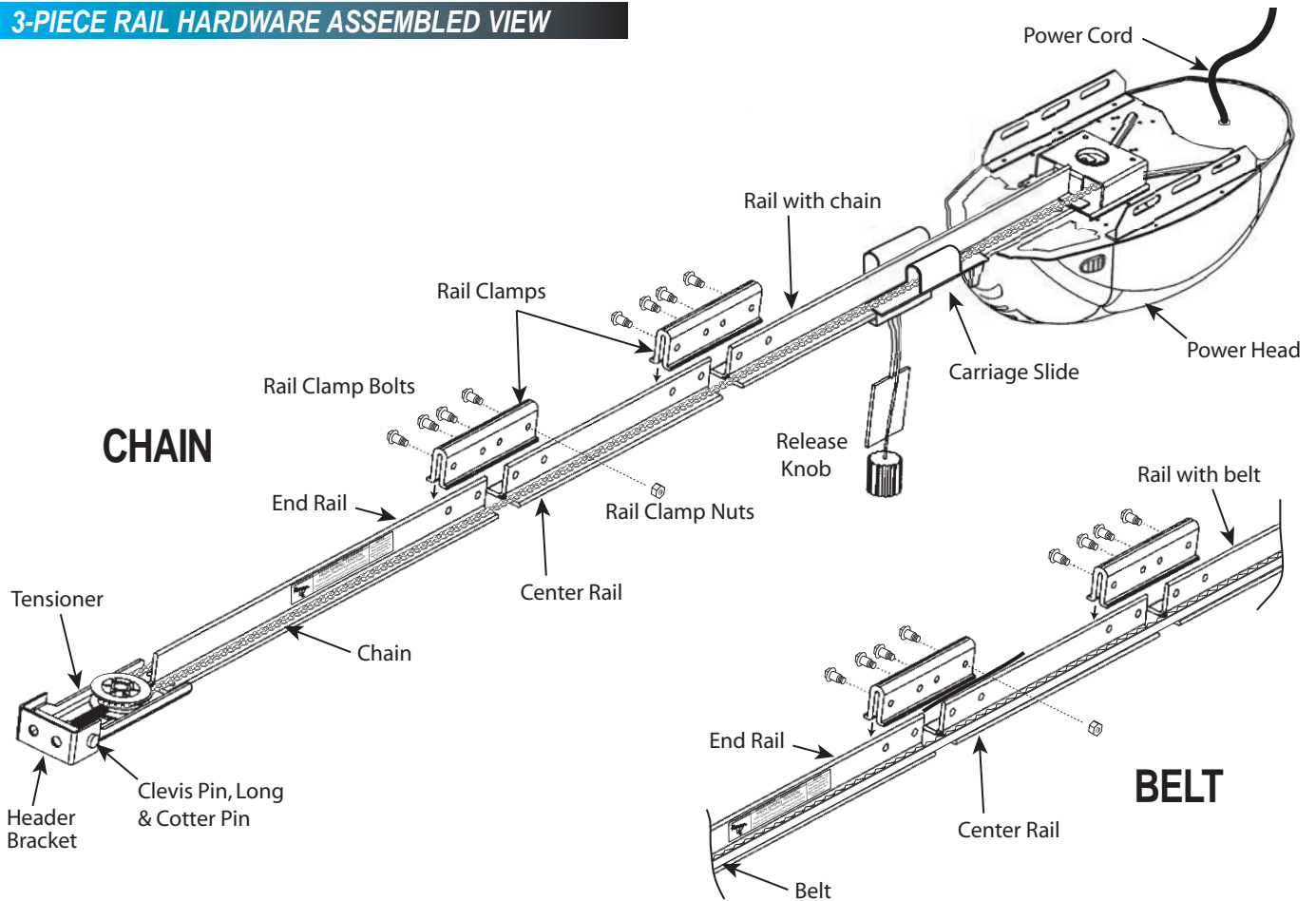



# IMPORTANT INSTALLATION INSTRUCTIONS

## ⚠️ **WARNING:** To reduce the risk of severe injury or death:

1. **READ AND FOLLOW ALL SAFETY, INSTALLATION AND OPERATION INSTRUCTIONS.** (If you have questions or do not understand an instruction, call The Genie Company or an authorized Genie® Dealer.)
2. Install only on a properly balanced **sectional** garage door. An improperly balanced door could cause severe injury. Have a trained door system technician make repairs or adjustments to cables, spring assemblies, and other hardware **before** installing the opener.
3. Remove all ropes and remove or make inoperative all locks connected to the garage door before installing opener.
4. Where possible, install the door opener **7 feet or more above** the floor. For products having an emergency release, mount the emergency release 6 feet above the floor.
5. **Do NOT** connect the opener to source of power until instructed to do so.
6. Locate the Wall Control:
  - Within sight of door,
  - At minimum height of 5 feet so small children are not able to reach it, and
  - Away from all moving parts of the door.
7. Install the **Entrapment WARNING Label** next to the Wall Control in a prominent location. Install the Emergency Release Tag on or next to the emergency release.
8. After installing the opener, the door **must reverse within 2 seconds** when it contacts a 1-1/2 inch high object (or a 2 x 4 board laid flat) on the floor.

**NOTE:** Please follow ALL instructions in their NUMBERED sequence. Use wall control and safety sensors provided with this unit. Do NOT substitute wall control or safety sensors.

## 1 OPENER ASSEMBLY

FOR HELP-1.800.354.3643 OR WWW.GENIECOMPANY.COM

**RAIL ASSEMBLY:** Use a clean, flat surface.

**NOTE:** For 1-piece rail—skip to **POWER HEAD & RAIL ASSEMBLY**.

### ⚠️ **WARNING**

To reduce the risk of injury to persons or damage to property - Use this opener only with sectional doors.

### ⚠️ **CAUTION**

Do NOT run until opener is fully assembled and instructed to do so.

**NOTE:** Three (3) piece rail assemblies are for a 7 foot high sectional door.

Clear a workspace area to unpack and organize box and contents for assembly.

1. There are 4 boxes inside the carton. Each box is numbered 1 - 4. Note that some openers will contain the same parts and be packaged with fewer boxes. **Carefully remove the three internal boxes (Labeled #1, 2, and 3) and place them on the floor for easy access (Fig. 1-1).** These boxes contain assembly parts and the contents are organized by assembly tasks. For quick reference inside the lid of each box there is a label illustrating the components inside.
2. **Remove the motor power head and place it on the floor for later use. Remove box #4 and place it on the floor for later use.**

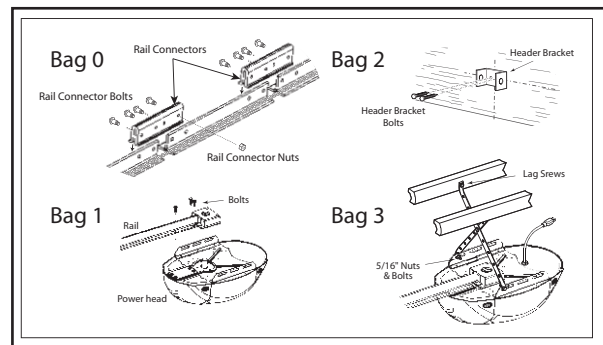

**Box Label Example**

**FIG. 1-1 Internal boxes.**

## Rail Assembly for CHAIN DRIVE OPENER

**NOTE:** For split rail clamps, nuts, and bolts locate Bag 0 from Box 1.

3. Remove the two rail sections that are not connected to the chain and place them on floor (Fig. 1-2, A).
4. Carefully remove the third rail section with chain and plastic sleeve. Place rail section on floor and extend chain straight out (Fig. 1-2, B). Chain and rail should extend approximately 7 feet.
5. Remove wire ties and plastic bag from chain. Leave chain extended straight out on floor. Avoid kinks in the chain by careful handling and keeping chain flat on the floor.
6. Align the three rail sections by pulling the chain straight and wrapping it around the chain tensioner pulley (Fig. 1-3 & 1-4).
7. Attach the two rail clamps to the rail section joints with (4) bolts and nuts. After both rail clamps have been assembled to the rail sections, securely tighten the bolts and nuts.

## CHAIN DRIVE RAILS

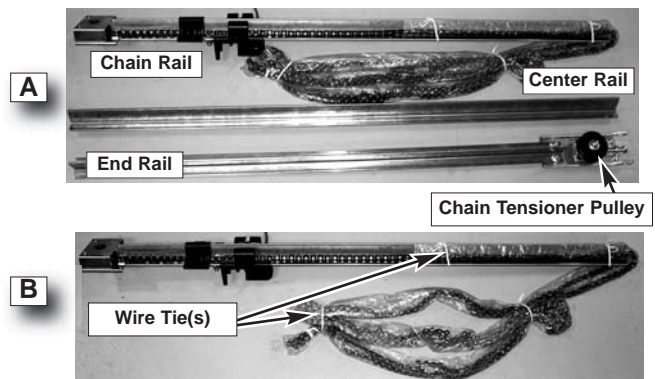

## BELT DRIVE RAILS

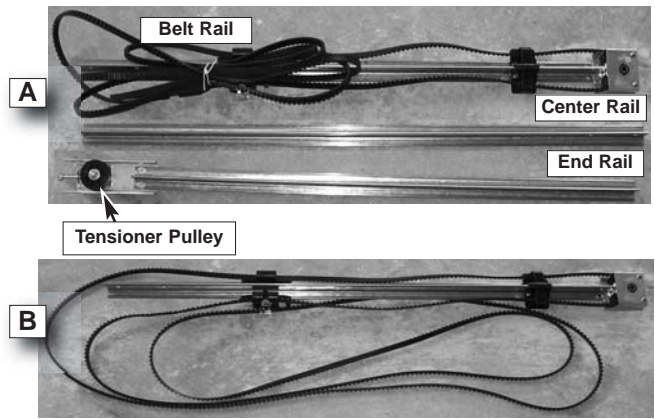

FIG. 1-2 Split Rail sections.

## Rail Assembly for BELT DRIVE OPENER

**NOTE:** For split rail clamps, nuts, and bolts locate Bag 0 from Box 1.

3. Remove the two rail sections that are not connected to the belt and place them on floor (Fig. 1-2, A).
4. Carefully remove the third rail section with belt. Place rail section on floor, remove ties on belt and extend belt straight out (Fig. 1-2, B). Avoid twists and kinks in the belt by careful handling and keeping belt flat on the floor. Belt and rail should extend approximately 7 feet.
5. Align the three rail sections by pulling the belt straight and wrapping it around the tensioner pulley (Fig. 1-3 & 1-4).
6. Attach the two rail clamps to the rail section joints with (4) bolts and nuts. After both rail clamps have been assembled to the rail sections, securely tighten the bolts and nuts.

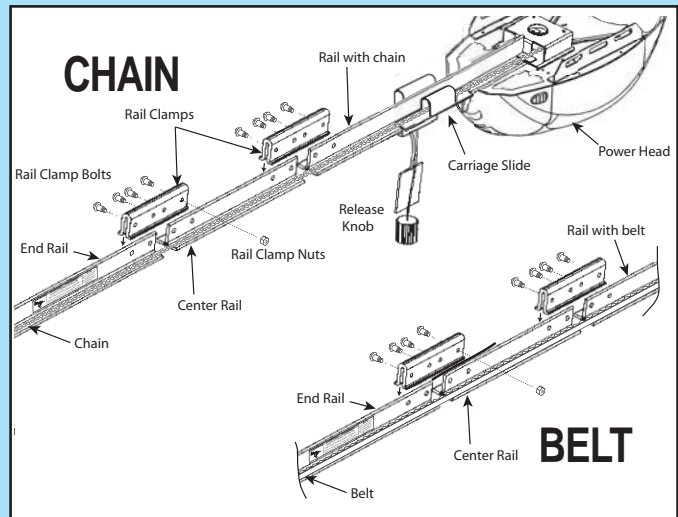

FIG. 1-3 Split Rail assembly.

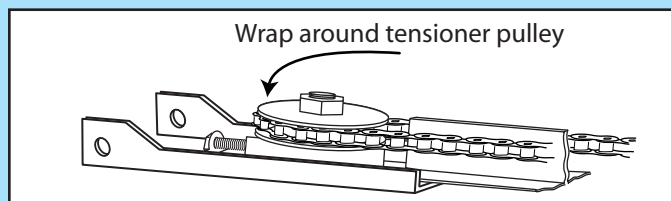

FIG. 1-4 Mount chain/belt to tensioner pulley.

## POWER HEAD & RAIL ASSEMBLY

### Assembly for CHAIN DRIVE OPENER

**NOTE:** Handle carefully! Drive chain can slide out of rail.

**NOTE:** For power head and rail assembly locate Bag 1 from Box 1.

**NOTE:** Copy serial number from power head frame and record it on warranty page.

1. Attach rail assembly to power head by aligning the sprocket onto the motor shaft. Use (3) bolts, 5/16 -18 x 1/2" (Fig. 1-5).
2. Tighten the chain by turning the adjustment nut clockwise. The chain adjustment nut is located in the Chain Pulley Bracket (opposite rail end from the power head) (Fig. 1-6).
3. Tighten chain until chain is approximately 1/8 inch above the base of the rail at midpoint on the rail (Fig. 1-6). Do NOT over tighten chain.

#### **CAUTION**

You should have removed all ropes and/or cables (NOT door lift cables) and disabled the door lock already. If you have not, remove all ropes and/or cables and disable garage door lock **NOW** before continuing with installation (Fig. 1-8).

Set assembled power head and rail aside. Begin with Section 2 INSTALLATION.

### Assembly for BELT DRIVE OPENER

**NOTE:** For power head and rail assembly locate Bag 1 from Box 1.

**NOTE:** Copy serial number from power head frame and record it on warranty page.

1. Attach rail assembly to power head by aligning the sprocket onto the motor shaft. Use (3) bolts, 5/16 -18 x 1/2" (Fig. 1-5).
2. Tighten the belt by turning the adjustment nut clockwise. The belt adjustment nut is located in the Belt Pulley Bracket (opposite rail end from the power head) (Fig. 1-7).
3. Tighten belt until belt is approximately 1/8 inch above the base of the rail at midpoint on the rail (Fig. 1-7). Do NOT over tighten belt.

#### **CAUTION**

You should have removed all ropes and/or cables (NOT door lift cables) and disabled the door lock already. If you have not, remove all ropes and/or cables and disable garage door lock **NOW** before continuing with installation (Fig. 1-8).

Set assembled power head and rail aside. Begin with Section 2 INSTALLATION.

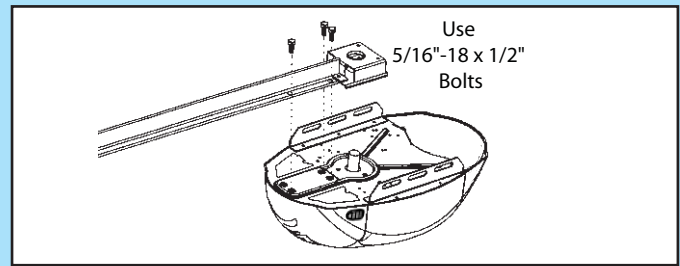

FIG. 1-5 Rail - Power head assembly.

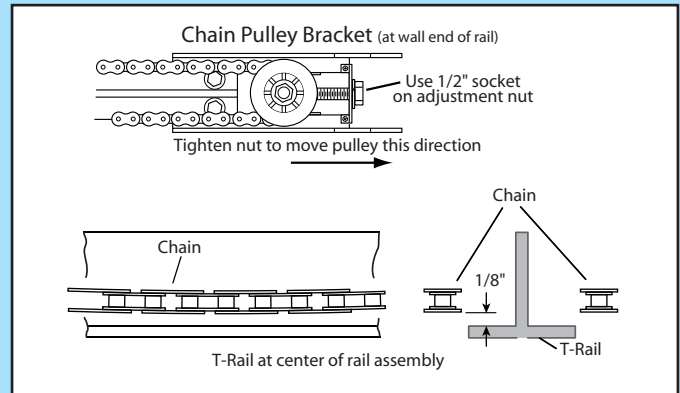

FIG. 1-6 Chain adjustment.

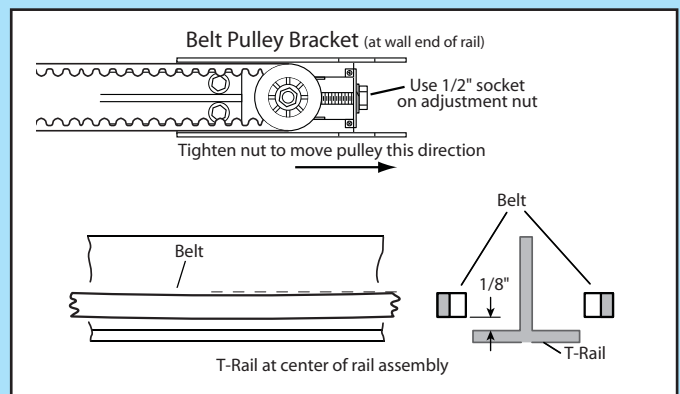

FIG. 1-7 Belt adjustment.

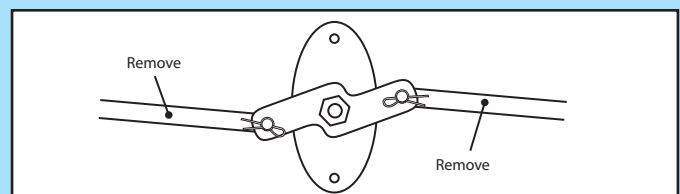

FIG. 1-8 Disable garage door lock.





## MOUNTING THE OPENER:

### 1. Getting started.

- Position assembled rail on wall next to header bracket (**Fig. 2-4**).
  - Place material on floor under power head to protect from scratching. (A box, stool, or similar device may be needed to clear a torsion spring.)

**NOTE:** For header bracket pins locate Bag 2 from Box 1.

### 2. Mounting the assembly.

- Attach rail to header bracket using clevis pin and cotter pin (**Fig. 2-5**).
- Support power head on step-ladder to prevent interference with header mounted (torsion) spring.

**NOTE:** Before final attachment to ceiling, insure that assembly is in proper alignment (**Fig. 2-4**).

**NOTE:** For nuts, bolts, and lag screws locate Bag 3 from Box 1.

- On **finished** ceilings, locate ceiling joists or trusses using a stud finder or similar device. Attach angle iron (not provided) to joists or trusses through finish material using (provided) lag screws (**Fig. 2-6**).
- On **unfinished** ceilings or open ceilings, straps may attach directly to joists or trusses. Depending on the garage construction, extra framing material (not provided) which may be required should be installed using appropriate construction techniques (**Fig. 2-6**).

**NOTE:** Refer to your local building codes for appropriate construction techniques.

- Attach mounting straps (not provided) to ceiling using lag bolts (**Fig. 2-6**).
- Set height of power head to following (**Fig. 2-6**).
  - a) Rail must clear door at door's highest point of travel.
  - b) Rail must be level or at power head end slightly below level.
- Securely tighten power head mounting bolts and nuts.
- Carefully raise and lower door manually. Ensure door does not contact any section of power head or rail.
- Check that rail clamp bolts and nuts are tight.
- **DO NOT PLUG OPENER IN YET!**

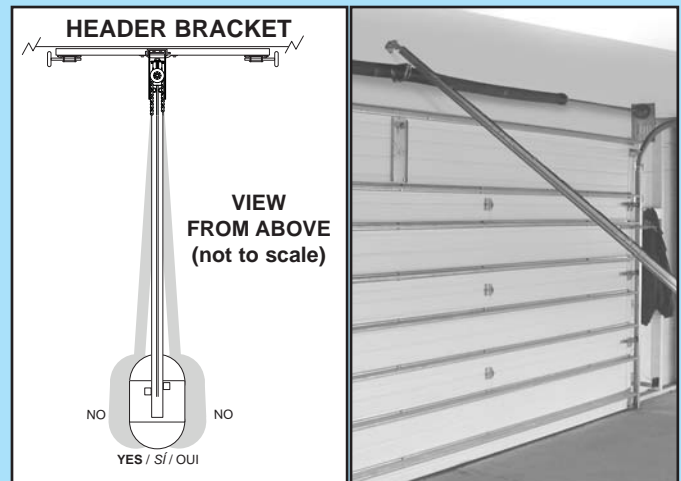

**FIG. 2-4** Position assembly and align.

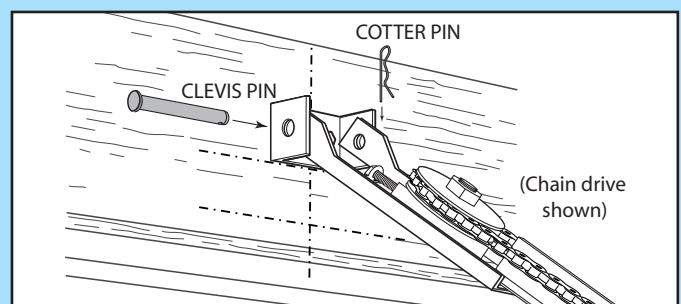

**FIG. 2-5** Rail mounting to header bracket.

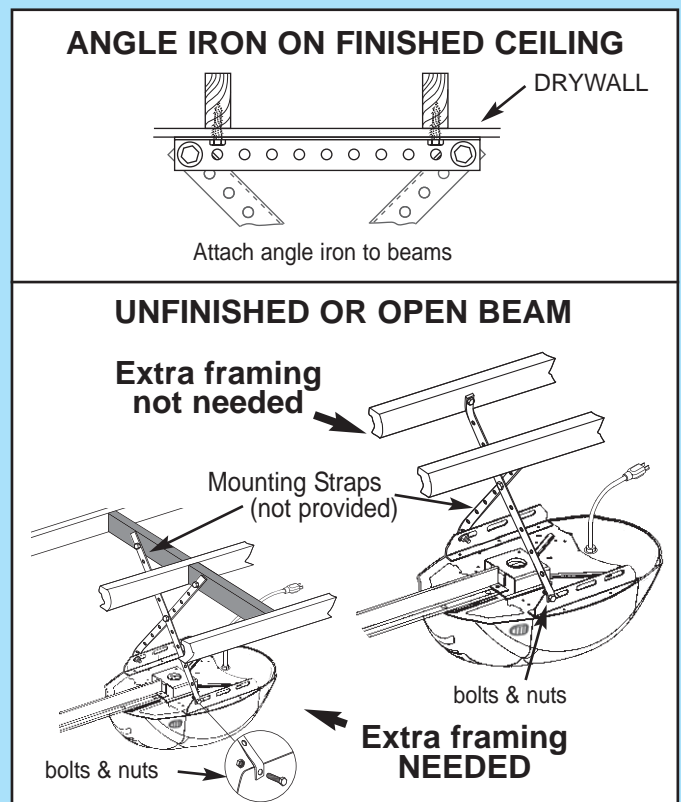

**FIG. 2-6** Mounting the power head.

## DOOR BRACKET:

### CAUTION

Doors made of masonite, lightweight wood, fiberglass, and sheet metal must be properly braced before mounting door opener. Contact door manufacturer or distributor for a bracing kit. The Genie Company is not responsible for damage caused due to improperly braced door.

**NOTE:** For door bracket and bolts locate Bag 4 from Box 2.

#### 1. Finding door bracket mounting location.

- Door bracket is mounted as high on door as possible along vertical centerline and **NO LOWER THAN** top set of rollers (**Fig. 2-7**).

#### 2. Mounting the door bracket.

- Proper bracing should be verified at this point.
  - Align door bracket centered on your vertical centerline (**Fig. 2-8**).
  - Attach using **3 self-drilling screws** for sheet metal or other **light weight material**.
  - Use **lag screws** (not provided) for **solid wooden sectional doors**.

**NOTE:** For solid wood doors, carriage bolts WITHOUT SLOTTED HEADS (not included) may also be used for attaching door bracket.

## INSTALL DOOR ARMS

**NOTE:** For door arm nuts and bolts, clevis and cotter pins locate Bag 5 from Box 2.

#### 1. Attach the arms.

- Fasten short branch of curved door arm to door bracket using bolt and locking nut (**Fig. 2-9**).
- Fasten straight arm to carriage using clevis pin and cotter pin (**Fig. 2-9**).

#### 2. Connecting the arms.

- Slide carriage back and forth to adjust arm length.
  - Position the straight arm **50°** down from the rail.
- With the arms arranged in this position, fasten arms together using bolts and nuts spaced as far apart as possible (**Fig. 2-9**).

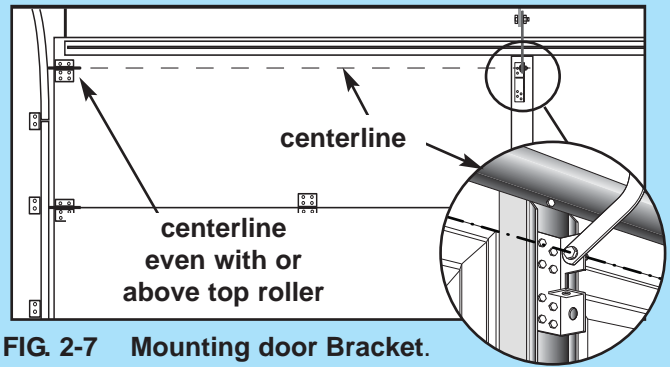

FIG. 2-7 Mounting door Bracket.

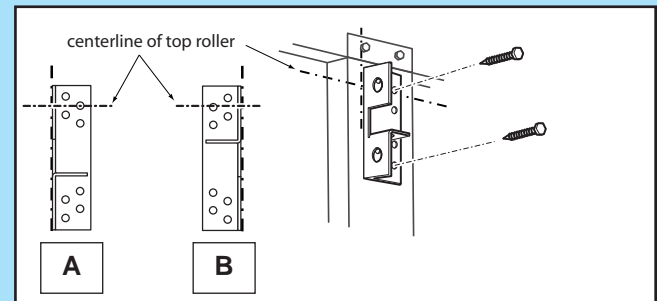

FIG. 2-8 Examples of door bracket positioning.

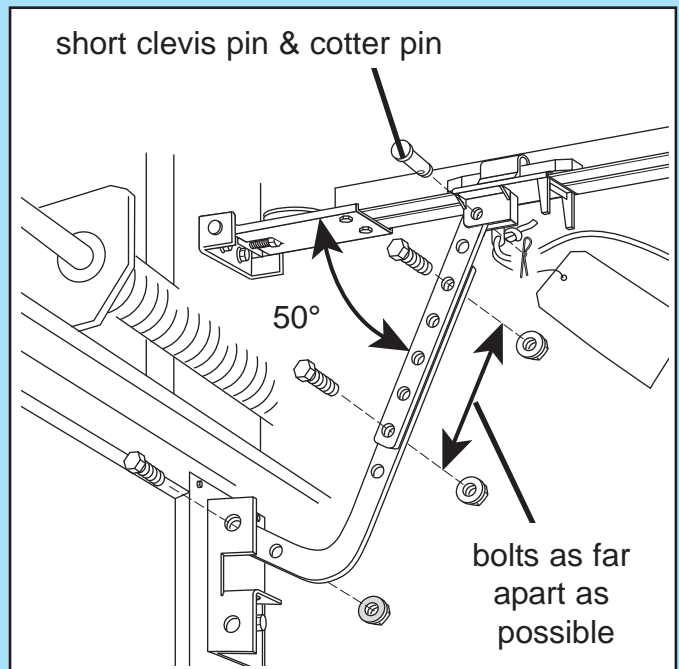

FIG. 2-9 Attaching door arms.

### 3 WALL CONTROL INSTALLATION

FOR HELP-1.800.354.3643 OR WWW.GENIECOMPANY.COM

#### ⚠ WARNING

Verify there is **NO** power to the opener before installing Wall Control wires and Wall Control.

#### ⚠ CAUTION

Staples which are too tight can cut or pinch wires. Cut or pinched wires can cause the Wall Control to stop working. When using the insulated staples, make sure you fasten them only as tightly as needed to hold the wire snugly.

#### ⚠ WARNING

Use of any other wall control can cause the door to operate unexpectedly and the light not to work. Use only the included Wall Control.

**NOTE:** For Wall Control, wire and insulated staples locate Bags 6 and 7 from Box 2.

#### 1. Wall Control location.

- Wall Control location should be in direct sight of door.
- It should be at least five feet (5') above floor to prevent small children from operating door.
- It must be away from any moving parts. (You should NOT be able to reach the garage door while standing at Wall Control.)
- Wall Control board screw connections are polarized, (+) positive and (-) negative.

#### 2a. Wiring (If pre-wired).

- Locate Wall Control pre-wired wire ends (**Fig. 3-1**). (They should be located within the guidelines mentioned above.)
- Split and strip ends of wire (**Fig. 3-2**).
- Fasten wire to Wall Control board screws on back of Wall Control.
  - Striped wire to the + (plus) terminal.
  - White wire to the - (minus) terminal.

#### 2b. Wiring (If NOT pre-wired).

- Pick a convenient location for mounting Wall Control using the guidelines mentioned above (**Fig. 3-1**).
- Run wire from power head to Wall Control (**Fig. 3-1**).
- Split and strip ends of wire (**Fig. 3-2**).
- Fasten wire to Wall Control board screws on back of Wall Control.
  - Striped wire to the + (plus) terminal.
  - White wire to the - (minus) terminal.

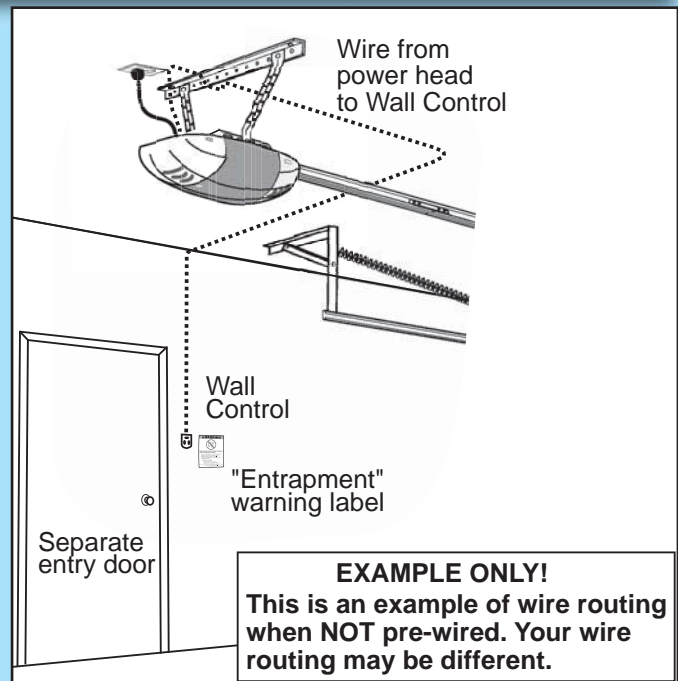

FIG. 3-1 Wall Control wire routing

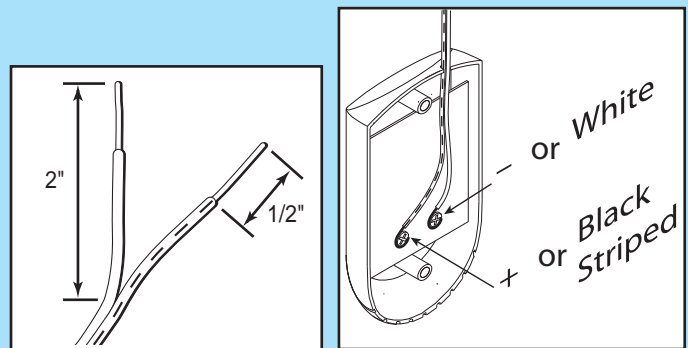
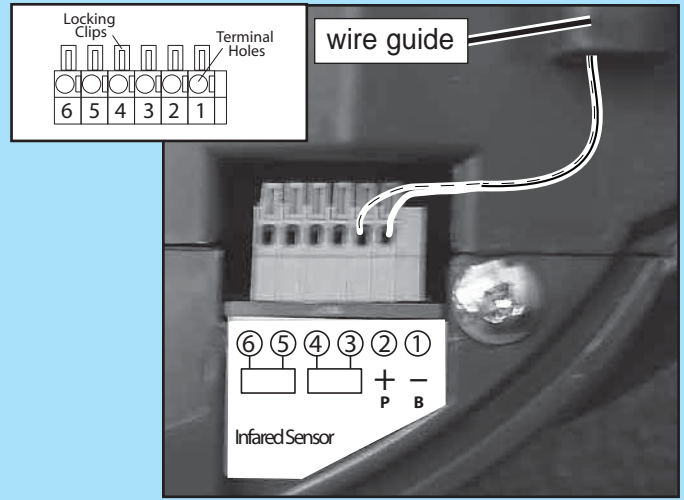

FIG. 3-2 Splitting and stripping.

### 3. Securely fasten wires.

- Securely fasten wires to ceiling and wall using insulated staples provided.
  - Use insulated staples.
  - Staples should be snug only.
- If rear cover is attached to power head, remove it.
- On power head:
  - Route Wall Control wires through wire guide on power head.
  - Split and strip ends of wire (**Fig. 3-2 on previous page**).
  - Insert wire into terminal holes and lightly press in the orange locking clips above each terminal hole. (You can use a pencil or small screwdriver to comfortably press in locking clips.) The white wire into #1 terminal hole and striped wire into the #2 terminal hole.
  - Confirm wire lock by lightly tugging on the wire. The wire should remain in the terminal hole.
- **Do NOT install rear cover yet.**



(Power Head With Rear Cover Removed)

FIG. 3-3 Insert wires.

### 4. Mounting.

- Fasten Wall Control to wall with 2 screws (provided) (**Fig. 3-4**).
- Remove protective backing from "Entrapment" warning label (**Fig. 3-5**). The "Entrapment" label is located in the center of this manual.
  - Stick label on wall near Wall Control.

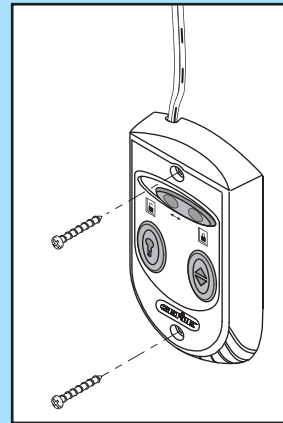

FIG. 3-4 Mounting Wall Control.

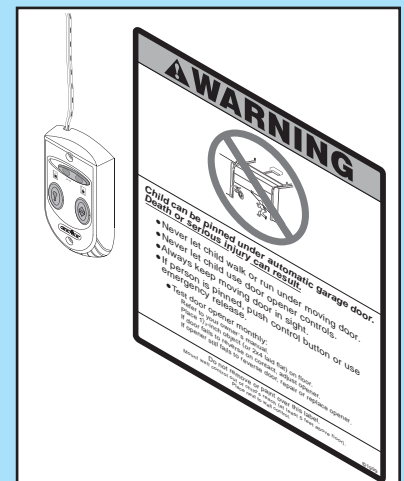
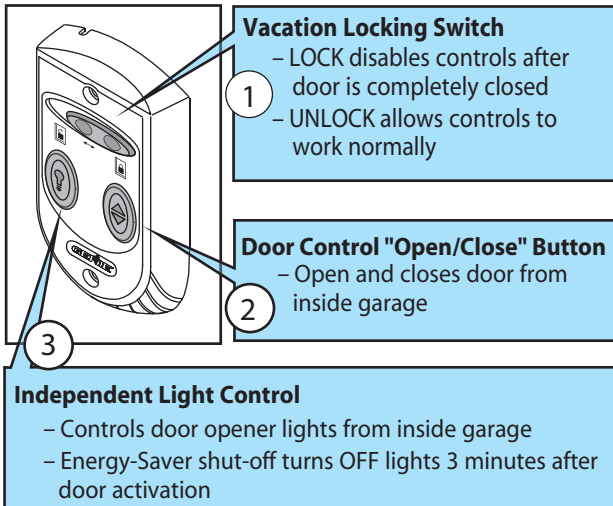

FIG. 3-5 Mounting Entrapment warning label.



## ⚠ WARNING

There should be no electrical power to the opener while installing Safe-T-Beam® wires. If you have plugged in the power cord—**UNPLUG IT NOW!**

**NOTE:** The opener will not close the door automatically unless the Safe-T-Beam® System is installed.

**NOTE:** For Sensors, screws, wire, and insulated staples locate items and Bag 8 from Box 3.

### 1. Mounting brackets.

- Mark both sides of garage door frame or wall no higher than 6" and no lower than 5" above floor (Fig. 4-1).
- Hold bracket against door frame or wall.
  - Check if brackets extend out from wall far enough, so tongue of bracket is beyond door, tracks or any door hardware.
  - If not:
    - a) Mounting bracket extensions are available through an authorized Genie® Dealer.
    - b) Blocks of wood, etc. may be substituted for extensions.
- Center bracket on your mark (Fig. 4-2).
- Fasten each with 2 screws (Fig. 4-2).

**NOTE:** Mounting brackets can be attached to the floor or concrete rim using concrete anchors (not provided) obey manufacturer's instructions.

### 2. Mounting Safe-T-Beam® Source (Red LED) and Sensor (Green LED).

- If garage has only one garage door.
  - Determine which side of garage receives most direct sunlight (Fig. 4-4).
  - Red LED should always be on sunny side whenever possible (Fig. 4-4).
- For multiple doors.
  - Preventing crossed signals is critical.
  - Place source and sensor modules on adjacent doors facing in opposite directions (Fig. 4-4).

**NOTE:** To help prevent interference from sun, Safe-T-Beam® sensor with Green LED may be placed further away from the door opening, though extended no further out from the wall, where it will spend more time in shadow.

- Slide source/sensor onto tongue of bracket until it clicks into place (Fig. 4-3).

### 3a. Wiring (If NOT pre-wired).

- Route wire from Safe-T-Beam® sensors to power head using method shown in (Fig. 4-5a).
- Securely fasten wires to wall and ceiling as you go (Fig. 4-6 on next page).
  - Use insulated staples.
  - Staples should be snug only.

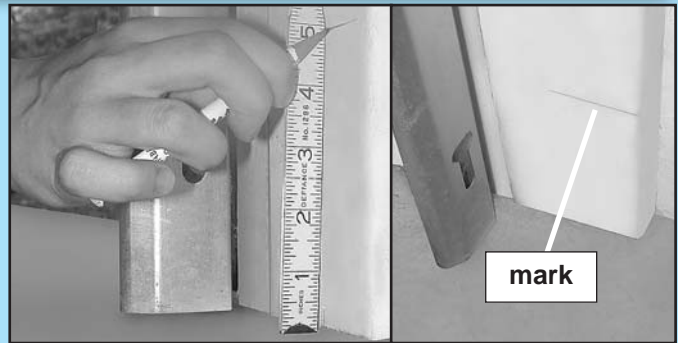

FIG. 4-1 Mark door frame.

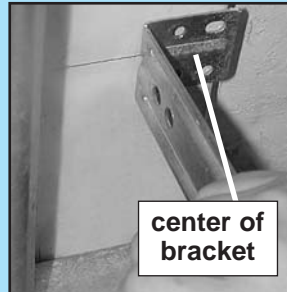

FIG. 4-2 Mounting brackets.

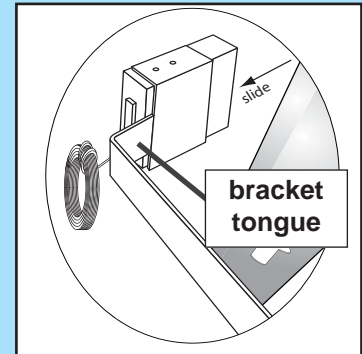

FIG. 4-3 Attach sensors to brackets.

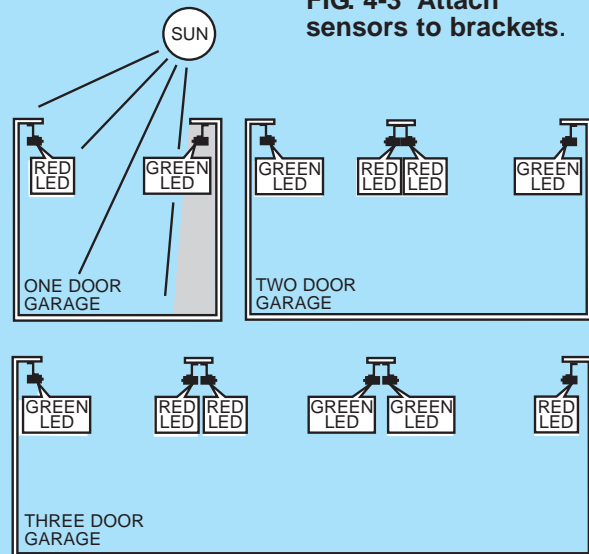

FIG. 4-4 Safe-T-Beam® source and sensor locations.

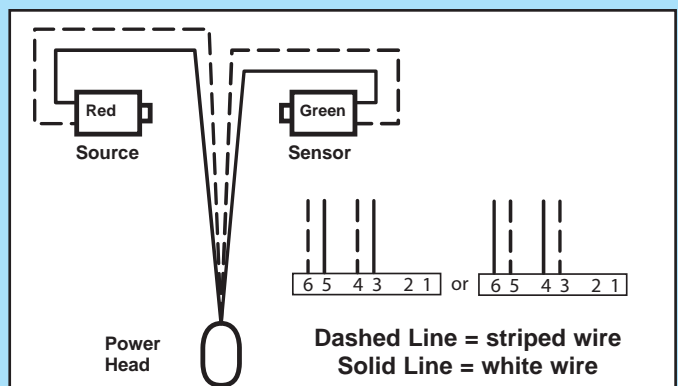

FIG. 4-5a Source and sensor wiring methods.

### 3b. Wiring (pre-wired).

- Route wire from wall to Safe-T-Beam® sensors (Fig. 4-5b).
- Splice pre-wiring to shortened sensor wire, match wire pairs *dash-to-dash (striped-to-striped)* and *plain-to-plain (white-to-white)*.
  - Trim sensor wire to approximately one foot (1 ft) from sensor.
  - Split and strip ends of sensor wires and pre-wired wires (Fig. 4-7).
  - Splice wires together with (provided) wire nuts.
- Route wire from ceiling to power head (Fig. 4-5b).
- Securely fasten wires where they exit wall and ceiling as you go.
  - Use insulated staples.
  - Staples should be snug only.

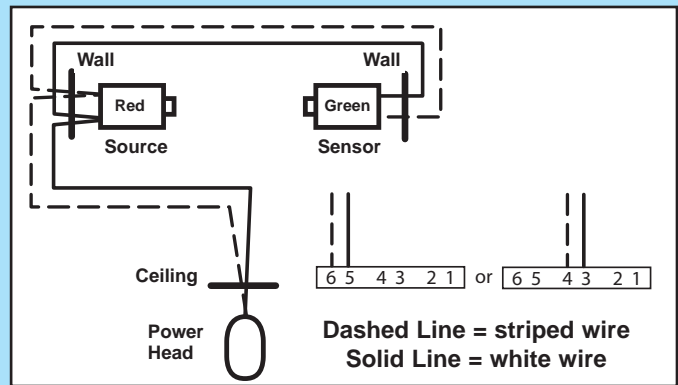

FIG. 4-5b Pre-Wired source and sensor wiring methods.

**CAUTION**

Staples which are too tight can cut or pinch wires. Cut or pinched wires can cause the Safe-T-Beam® System to stop working. When using the insulated staples, make sure you fasten them only as tightly as needed to hold the wire snugly.

### 4. Split and strip ends of sensor wires (Fig. 4-7).

**NOTE: For rear cover locate Box 4.**

### 5. Attach Safe-T-Beam® wire to power head wire terminal.

- Route Safe-T-Beam® wires through wire guide on power head.
  - Insert wire into terminal holes and lightly press in the orange locking clips above each terminal hole. (You can use a pencil or small screwdriver to comfortably reach in and lightly press down locking clips.) Insert white wires to 'even' numbered terminal holes and striped wires into 'odd' terminal holes (Fig. 4-8).

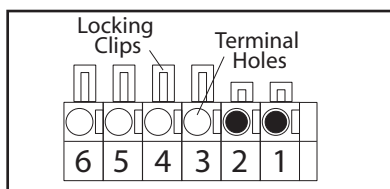

- Confirm wire lock by lightly tugging on the wire. The wire should remain in the terminal hole.
- Do not install the white (lamp) cover at this time.

**NOTE: Safe-T-Beam® alignment check must be performed following connection to electrical power (see page 19). DO NOT PLUG IN YET!**

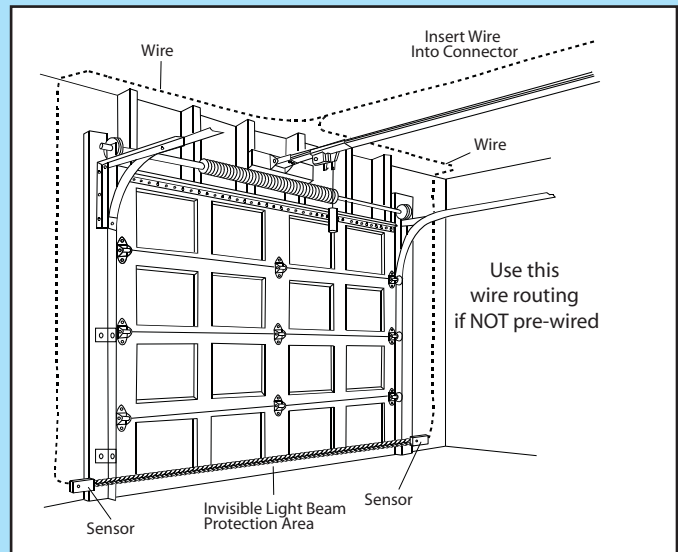

FIG. 4-6 Wire routing.

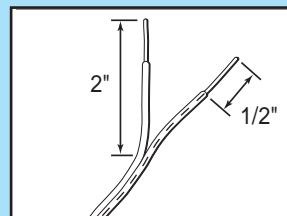

FIG. 4-7 Splitting and stripping.

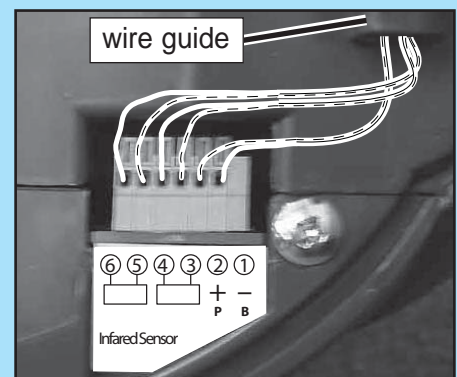

FIG. 4-8 Insert wires.

(Power Head With Rear Cover Removed)

## 5 CONNECTING TO POWER

FOR HELP-1.800.354.3643 OR WWW.GENIECOMPANY.COM

### ⚠ WARNING

- To reduce the risk of electrical shock, this equipment has a grounded type plug that includes a third (*grounding*) pin. This plug will only fit a grounded type outlet. If you do not have a grounded outlet, contact a qualified licensed electrician to install one. DO NOT alter the plug in any way. The door opener must be properly grounded in order to prevent personal injury and damage to the components.
- DO NOT remove motor cover. All work performed on motor must be done by a trained door system technician.

### ⚠ CAUTION

- **Check local building codes** to make sure that you are not required to have your garage door opener permanently wired, with circuit breaker protection. If building codes require door opener to be permanently wired have a qualified licensed electrician connect power with permanent wiring.

#### WITH GROUNDED PLUG:

Plug the opener into a properly grounded electrical outlet (Fig. 5-1).

#### WITH PERMANENT WIRING:

##### Instructions for Electrician.

- Remove power from circuit.
- Remove rear cover and motor cover.
  - Remove four motor cover screws (Fig. 5-2).
- Remove existing power cord and strain relief from the 7/8" dia. hole and discard (Fig. 5-3).
- Connect permanent wiring to power head using 7/8" diameter hole.
  - **White to white/black to black/ground to green.**
  - Use only UL recognized wire nuts.
- Wires inside the power head must be at least 6" in length.
- Replace motor cover and rear cover and re-energize the circuit.

**NOTE:** The Genie Company is not responsible for charges resulting from work performed by an independent electrician.

#### WITH POWER SUPPLIED:

##### Check Safe-T-Beam® alignment (Fig. 5-4).

- Insure that no part of door or its hardware is in path between lenses of **source** and **sensor**.
- Insure that tops of lenses are between 5" - 6" above the floor (Fig. 5-4). The brackets are flexible, and can be adjusted slightly if needed.
- Adjust the Red LED transmitter by aiming the unit directly at the Green LED receiver. Use the adjustment screw located on the top of the transmitter housing to make adjustments.
- The Red LED transmitter will blink if there is a misalignment. When the LED units are aligned the Red LED will remain ON continuously.
- After the alignment is finished tighten the adjustment screws on both sensors.

FIG. 5-1 Connect to power.

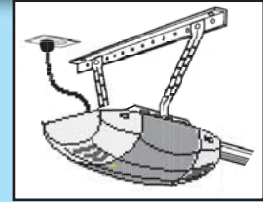

Motor Cover Screws



FIG. 5-2 Remove motor cover. (Electrician ONLY)

FIG. 5-3 Power cord strain relief.



### ⚠ CAUTION

- Do **NOT** use an extension cord.
- Do **NOT** use a portable generator. This product is designed to operate using standard household current.
- Do **NOT** use alternate power supplies.

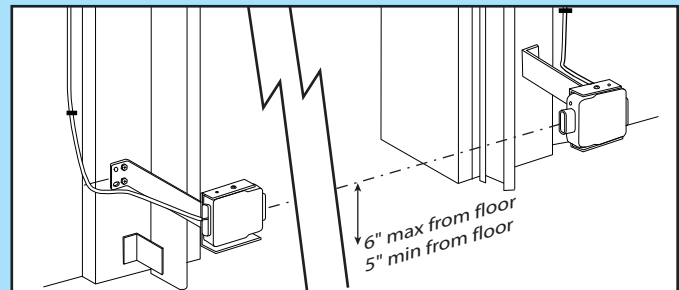

FIG. 5-4 Check Safe-T-Beam® alignment.

#### INFRARED PROTECTION FUNCTION

1. When the garage door is opening, its movement will not be influenced if the Safe-T-Beam® is obstructed.
2. If the Safe-T-Beam® is obstructed **before** the garage door fully closes, the door will not close.
3. When the garage door is closing, if Safe-T-Beam® is cut off by people or obstacle, the garage door will reverse automatically to its fully opened position. (Meanwhile, the opener light will keep blinking until door moves to its fully opened position.)
4. If the Safe-T-Beam® System fails, loses power, or is installed improperly, press and hold the Wall Control "open/close" button until the door reaches its fully closed position. The LED indicator light on the power head will be green and blink twice (Pattern: ☀☀ pause ☀☀ pause) to inform you to eliminate the problem first. If you release the "open/close" button on the Wall Control during the closing movement the door will reverse automatically to its fully opened position.

## ⚠ WARNING

- Severe injury or death can result if the door closing force is set too high.
- Never increase the door closing force above the minimum required to move the door.
- Never adjust force to compensate for a sticking or binding door.
- Perform monthly CONTACT REVERSE TEST as described on page 22 and in **Section 10**.

## SETTING & TESTING OPEN/CLOSE LIMITS

The OPEN (UP) and CLOSE (DOWN) door positions are controlled by making the adjustments on the panel located on the bottom of the power head. The adjustments that can be made are:

- Close Travel Limit,
- Open Travel Limit,
- Adjust Closing Force
- Adjust Opening Force
- Transmitter Programming





### A) ENGAGE CHAIN/BELT CONNECTOR TO CARRIAGE

1. Press and hold the "Close Travel Limit"  button until the chain or belt connector advances and engages to the Carriage Assembly (**Fig. 6-2**).





## ⚠ CAUTION

Failure to verify the engagement of the belt/chain connector will result in damage to rail components.

### B) CLOSE TRAVEL LIMIT

1. Press and hold the "Close Travel Limit"  button until the door is fully closed.
2. You can quickly press and release the "Close Travel Limit"  button to move the door in small increments. You can also use the "Open Travel Limit"  button to move the door slightly in the UP direction.
3. Door is fully closed when the bottom edge of door presses firmly onto the ground.
4. Once the door is in the desired position, press and release the "Close SET Limit"  button. The LED indicator light will blink green once. This stores the closed position in memory.

### C) OPEN TRAVEL LIMIT

1. Press and hold the "Open Travel Limit"  button to move the door to its fully opened position. This starts the opener moving in the UP direction.
2. Hold the "Open Travel Limit"  button until the door is in the fully opened position that you desire, then release this button.
3. You can quickly press and release the "Open Travel Limit"  button to move the door in small increments. You can also use the "Close Travel Limit"  button to move the door slightly in the DOWN direction.
4. Once the door is in the desired position, press and release the "Open SET Limit"  button. The LED indicator light will blink green twice. This stores the opened position in memory.

Limit Controls location on power head.

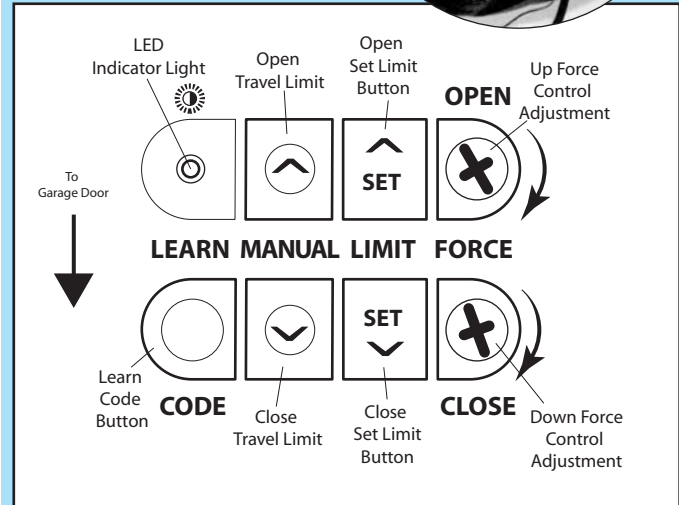
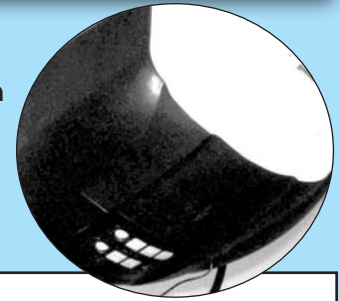

FIG. 6-1 Limit controls.

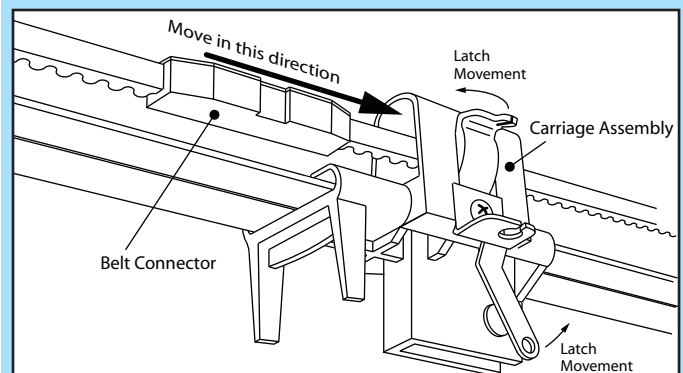
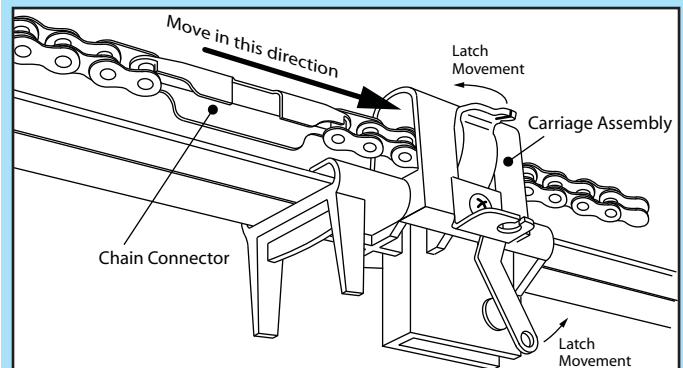

FIG. 6-2 Engage Chain/Belt Connector to Carriage.

## ⚠ CAUTION

Operation of the opener without the Chain or Belt Connector engaged to the Carriage Assembly will result in damage to rail components including the rail pulley.



## CARRIAGE LOCK

The Carriage Lock can be manually engaged or disengaged.

- To disengage Carriage Lock
  - Pull handle downward **opener power head**.
- To engage Carriage Lock
  - Pull handle towards **door**.

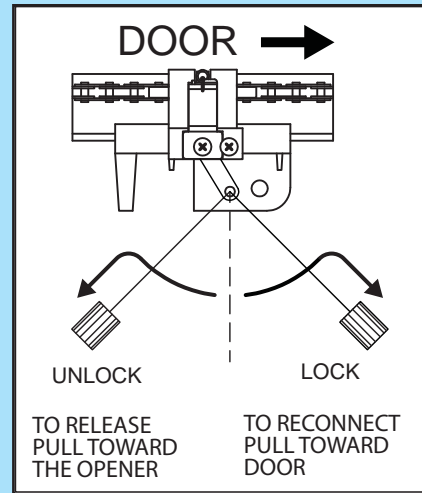





FIG. 6-3 Engage/Disengage Carriage Lock.

## UP/DOWN FORCE

1. By turning the "Close Force Control"  clockwise, the **DOWN** force can be **increased**. By turning the "Close Force Control"  counter-clockwise, the **DOWN** force can be **decreased**. Set the **DOWN** force level at the minimum force required to close door without reversing.
2. Once the desired level is selected, this stores the necessary force level for the **DOWN** direction in memory.
3. By turning the "Open Force Control"  clockwise, the **UP** force can be **increased**. By turning the "Open Force Control"  counter-clockwise, the **UP** force can be **decreased**. Set the **UP** force level at the minimum force required to open door without stopping.
4. Once the desired level is selected, this stores the necessary force level for the **UP** direction in memory.

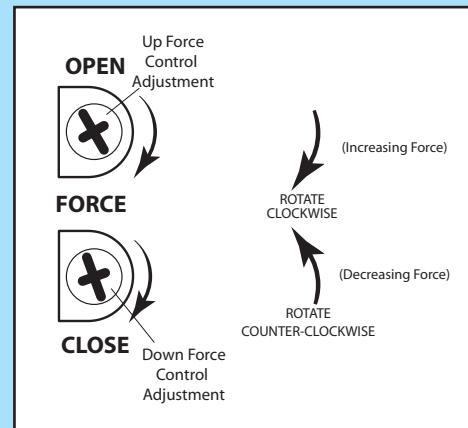

FIG. 6-4 Force Control Adjustment.

## ERASE - OPEN/CLOSE TRAVEL LIMIT

1. Press and hold both of the "SET" buttons (⏏ & ⏏) together until the green indicator light blinks (about 5 seconds).
2. All close and open travel limit settings are erased. Then follow the steps above to reprogram close and open travel limits.

**NOTE:** *The opener will not close the door automatically unless the Safe-T-Beam® System is installed.*

## CONTACT REVERSE TEST

The force adjustments and limit switch settings **MUST BE COMPLETED** before testing.

1. **Testing.**
  - Open garage door using Wall Control.
    - Place a 2" x 4" board (laid flat) under **center of garage door opening (FIG. 6-5)**.
  - Close door using Wall Control.
  - When door contacts board, the door must stop (within 2 seconds) and reverse direction returning to open position.
2. **Adjustment.**
  - If the door does not properly reverse.
    - Check to see if door has "close" limit programmed. It should not have reached its "close" limit before hitting board.
    - If the door **STOPS** but does not reverse, decrease "**CLOSE FORCE**" control  setting slightly (turn it counter-clockwise).
  - Test again. Repeat as necessary until door reverses upon contacting board.



**FIG. 6-5** 2 x 4 under center of door opening.

## 7 PROGRAMMING REMOTE CONTROLS

### ⚠ WARNING

**A moving door can cause serious injury or death.**

1. Keep people clear of opening while door is moving.
2. Do NOT allow children to play with opener, including Wall Control, remote control, or Wireless Keypad.
3. During programming, the door opener could begin to run, so keep people and objects away from the moving door and its parts. To keep the door from moving, close the door and disconnect it from the Opener by pulling the Emergency Release.

**NOTE: For remote control locate Box 3.**

### 1a. Single Button Remote Programming.

**NOTE: This opener can learn up to 7 transmitter buttons.**

- Locate "Learn Code"  button and indicator LED on the power head (**Fig. 7-1**).
- Press and release "Learn Code" button.
  - Indicator LED will blink RED at a rate of twice per second.
- **Within 30 seconds**, push remote control button once.
  - Indicator LED will stop blinking and stay **ON**.
- Press remote control button again.
  - Red LED will go out. Remote is now programmed and ready for use.

### 1b. Multi Button Remote Programming.

**NOTE: Each button on a multi-button remote is designed for use with 1 door. You cannot program 2 buttons to operate the same door, nor can you program 1 button to operate 2 doors. You can program a maximum of 7 different transmitters or wireless devices.**

**NOTE: Pushing two buttons on power head simultaneously will erase programmed memory and limits must be reset.**

- For each button.
  - Program each button separately using the **Single Button Remote Programming steps**.

### 2. Operating.

- Press remote button once.
  - Door will move.
- Press button again.
  - Door will stop.
- Press button again.
  - Door will move in opposite direction.

**NOTE: The door will stop automatically at the fully open or fully closed position.**

### LOST OR STOLEN REMOTE

#### 1. Clear memory.

- Press and hold "Learn Code"  button (on power head) for 10 seconds or until the red blinking indicator LED goes out.
- Program remaining or new remote controls as done previously. *Your door opener will no longer recognize any signal received from the missing remote control, or any other which has not been reprogrammed.*



**NOTE:** To program a **HomeLink®** and **Car2U®** device follow the **HomeLink®** or **Car2U®** instructions in your car owner's manual.

### FCC and IC CERTIFIED

This device complies with FCC Part 15 and RSS 210 of Industry Canada. This equipment has been tested and found to comply with the limits for a Class B digital device, pursuant to Part 15 of the FCC Rules. These limits are designed to provide reasonable protection against harmful interference in a residential installation. This equipment generates, uses and can radiate radio frequency energy and, if not installed and used in accordance with the instructions, may cause harmful interference to radio communications. However, there is no guarantee that interference will not occur in a particular installation. If this equipment does cause harmful interference to radio or television reception, which may be determined by turning the equipment OFF and ON, the user is encouraged to try to correct the interference by one or more of the following measures:

- Re-orient or relocate the receiver antenna.
- Increase the separation between the opener and receiver.
- Connect the opener into an outlet on a circuit different from that to which the receiver is connected.
- Consult your local dealer.

Limit controls location on power head.

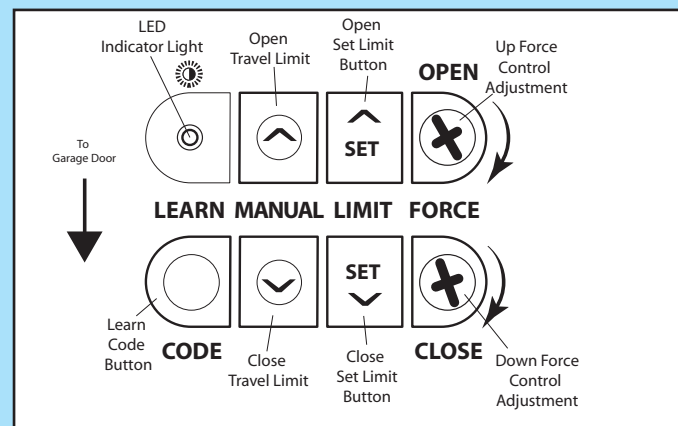
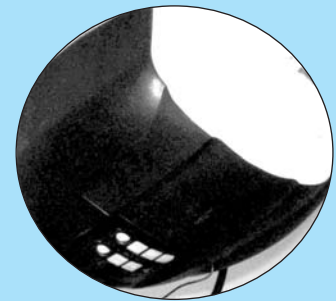

**FIG. 7-1** Learn code button and LED

## 8 REMOTE CONTROL BATTERY REPLACEMENT AND VISOR CLIP INSTALLATION

### 1. Battery replacement.

- To open, gently push straight out on battery cover lock tab as shown. (Fig. 8-1).
- Slide open battery cover.
  - Remove old battery.
- Make sure new battery is facing proper direction (Match battery polarity with symbols inside battery housing) (Fig. 8-2).
  - Recommended replacement battery type: *Alkaline A23*, 12 volt.

**NOTE: Batteries differ in care and maintenance. Follow the manufacturer's directions for battery maintenance, replacement, and use.**

- Slip new battery into place.
  - Slide battery cover until it clicks shut.
- Operate remote to make sure it is working properly. (No re-programming is needed.)

### 2. Visor clip.

(The visor clip may come already installed.) You will have to install the visor clip if you choose to attach your remote to the car visor.

- Slide visor clip into back of remote control.
  - It will snap into place (Fig. 8-3).

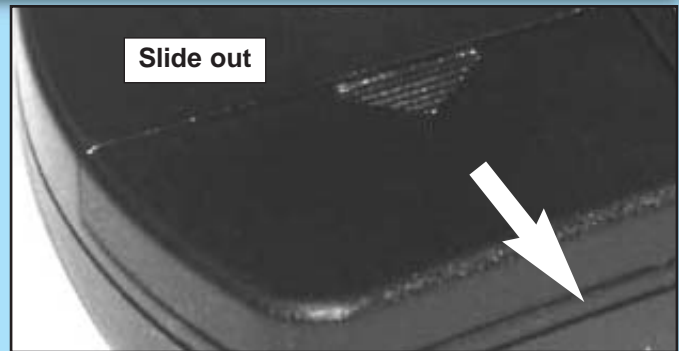

FIG. 8-1 Open battery cover.

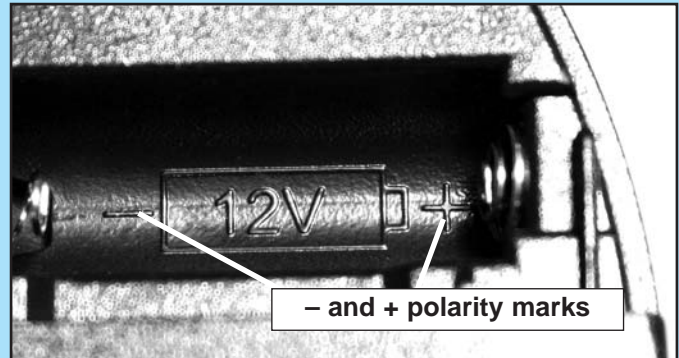

FIG. 8-2 Match battery polarity.



FIG. 8-3 Attach visor clip.

## 9 LIGHT BULB/LENS INSTALLATION

### ⚠ WARNING

For added safety and protection please unplug opener before installing light bulb.

**NOTE: For lens covers locate Box 4.**

### 1. Light bulb.

- Recommendations.
  - Do NOT use a short neck bulb.
  - Light bulbs should be no more than 60 Watts.
  - Use a **heavy duty service** bulb for longer life.
- Screw 1 bulb into each socket.

### 2. Lens.

- Select a white (lamp) cover.
- On the power head end nearest the garage door, line up lamp lens tabs on power head with corresponding slots in lens (Fig. 9-1).
- Slide lens onto power head. Make sure the tabs are fully engaged into lens slots (Fig. 9-2).
- Repeat for rear lens on power head.
- Plug power cord back into electrical outlet.
- Test lamp operation.

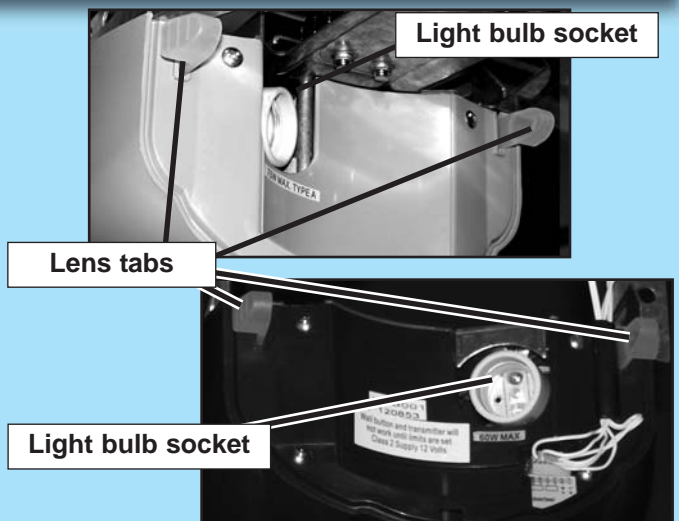

FIG. 9-1 Slide each lens onto motor cover.



FIG. 9-2 Fasten lens.



# IMPORTANT SAFETY INSTRUCTIONS

## ⚠ WARNING:

### To reduce the risk of severe injury or death:

1. READ AND FOLLOW ALL INSTRUCTIONS.
2. Never let children operate or play with the door controls. Keep the remote control away from children.
3. Always keep the moving door in sight and away from people and objects until the door is completely closed. **NO ONE SHOULD CROSS THE PATH OF THE MOVING DOOR.**
4. **NEVER GO UNDER A STOPPED, PARTIALLY OPEN DOOR.**
5. Test opener monthly. The door **MUST** reverse on contact with a 1-1/2" high object (or a 2" x 4" board laid flat) at the center of the doorway on the floor. After adjusting either the force or the limit of travel, retest the door opener. Failure to adjust the opener properly may cause severe injury or death.
6. When possible, use the emergency release only when the door is closed. Use caution when using this release with the door open. Weak or broken springs are capable of increasing the rate of door closure and increasing the risk of severe injury or death.
7. **KEEP DOORS PROPERLY BALANCED.** See your garage door Owner's Manual. An improperly balanced door increases the risk of severe injury or death. Have a trained door system technician make repairs to cables, spring assemblies, and other hardware.
8. **SAVE THESE INSTRUCTIONS.**

If you have any questions, please do not hesitate to contact Genie® customer service at:  
**1.800.354.3643**

## 10 MAINTENANCE

### ⚠ WARNING

- Garage door hardware (springs, cables, brackets, pulleys, etc.) are under extreme pressure and tension.
- **DO NOT** attempt to repair or adjust door springs or any hardware, and **DO NOT OPERATE** garage door **automatically or manually** if door is improperly balanced or springs are broken.
  - **CONTACT A TRAINED DOOR SYSTEM TECHNICIAN.**

### ROUTINE MONTHLY MAINTENANCE

1. **Door balance.**
  - With the door closed, pull emergency release knob (Carriage Lock) towards the opener to release door from carriage assembly.
  - Raise door manually approximately 3'- 4' and release.
    - Door should remain stationary or move **very** slightly.
    - If door moves quickly, **CONTACT A TRAINED DOOR SYSTEM TECHNICIAN.**
  - Close the door.
  - Pull emergency release knob towards door to engage carriage.
    - Operate door using remote.
    - Door will re-attach itself to carriage assembly.

2. **Contact reverse.**

- Place a 2" x 4" board laid flat on floor.
  - In center of garage door opening.
- Close door by using wall control or remote control.
  - Door fails to reverse on contact with board (See section 6 "CONTACT REVERSE.")
  - Opener still fails

**CONTACT THE GENIE COMPANY OR AN AUTHORIZED GENIE® DEALER.**

3. **Safe-T-Beam® System.**

- Red LED blinks.
  - check alignment (See section 5).

### ⚠ WARNING

Use Wall Control supplied with opener. Any other Wall Control can cause the opener to operate unexpectedly.

**Opener circuit wiring diagram. This wiring diagram is for reference only.**

*Diagrama del circuito del abrelatas. Este diagrama es sólo para referencia.*

*Schéma de câblage de l'ouvreur. Ce schéma de câblage est indiqué à titre de référence uniquement.*

**⚠ WARNING**  
**⚠ ADVERTENCIA**  
**⚠ AVERTISSEMENT**

**Opening Cover May Cause Electric Shock.**

***Abrir la tapa puede causar choques eléctricos.***

*L'ouverture du couvercle peut entraîner des chocs électriques.*

**Disconnect power from opener prior to removing cover.**

***Desconnecte la electricidad del abrepuertas antes de quitar la cubierta.***

*Coupez l'alimentation de l'ouvre-porte avant de retirer le couvercle.*

**POWER CORD**

**CORDON DE SECTEUR**

**CABLE ELÉCTRICO**

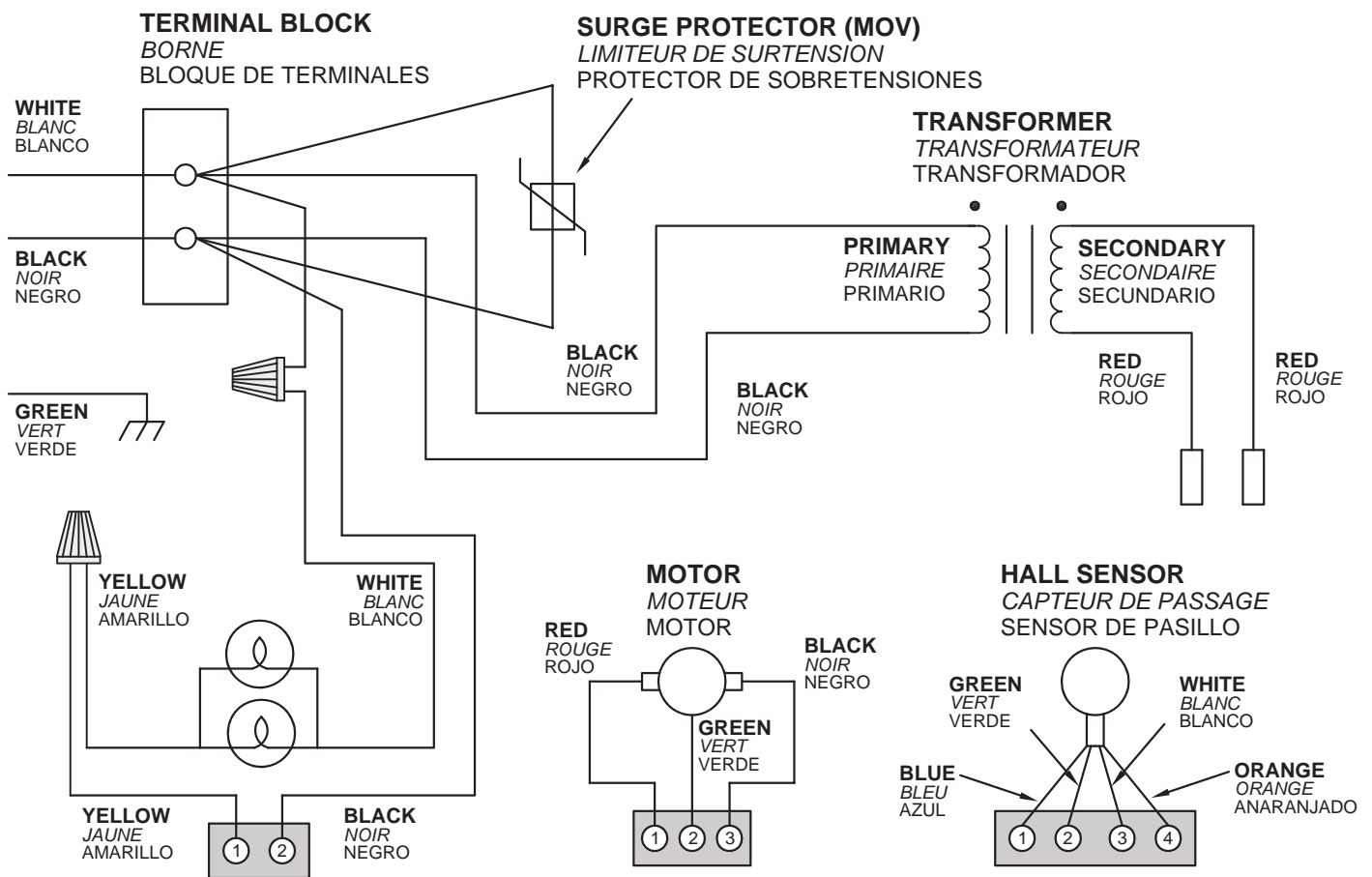

**⚠ WARNING**  
**⚠ ADVERTENCIA**  
**⚠ AVERTISSEMENT**

**ELECTRICAL SHOCK**  
**CHOQUE ELÉCTRICO**  
**CHOC ÉLECTRIQUE**

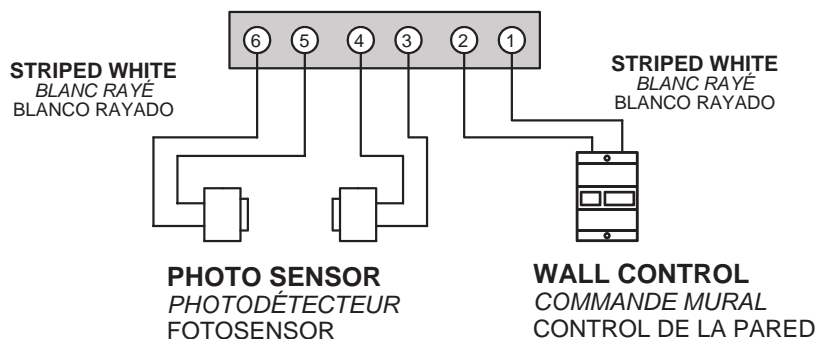

PROBLEM	WHAT TO DO
<b>Opener does NOT run from Wall Control.</b>	<ul style="list-style-type: none"> <li>• Check power source.               <ul style="list-style-type: none"> <li>– Plug a lamp into outlet used for power head. If lamp works, power source is OK.</li> <li>– If not, check fuse or circuit breaker.</li> </ul> </li> <li>• If power is OK.               <ul style="list-style-type: none"> <li>– Check connections at power head terminals and at Wall Control.</li> </ul> </li> <li>• Check for reversed, broken, or cut wires. Staples can cut insulation and short wires. Repair or replace.</li> </ul>
<b>Opener runs, but door does NOT move.</b>	<ul style="list-style-type: none"> <li>• Make sure carriage is engaged to carriage slide.               <ul style="list-style-type: none"> <li>– Place carriage lever in lock position.</li> </ul> </li> <li>• Check to make sure chain/belt is not broken or OFF its track.</li> <li>• Check FORCE ADJUSTMENT (See section 6). Door opener will NOT run more than 30 seconds each way if door does not move.</li> </ul>
<b>Opener works from Wall Control, but NOT from remote control.</b>	<ul style="list-style-type: none"> <li>• Confirm vacation lock switch on wall control is OFF. (See section 3).</li> <li>• Program remote control code into receiver memory (See section 7).</li> <li>• Replace remote control battery (See section 8).</li> </ul>
<b>Remote control has less than 25 feet operating range or no operation.</b>	<ul style="list-style-type: none"> <li>• Relocate remote control inside car and or point remote control at garage door.</li> <li>• Replace battery (See section 8).</li> <li>• Reposition door opener antenna.</li> <li>• Red LED blinks while button is being pushed or LED does not come ON - battery is low, replace battery.</li> </ul>
<b>Door starts down, then STOPS and goes back up.</b>  <b>OR</b>  <b>Safe-T-Beam® System malfunction.</b>	<ul style="list-style-type: none"> <li>• If a NEW installation, check Door Arm position, (See section 2).</li> <li>• Check if Safe-T-Beam® Red LED is flashing.</li> <li>• Check Safe-T-Beam® system for beam obstruction or misalignment of lenses. Realign or replace Sensors. (See section 3)</li> <li>• Check "CLOSE FORCE" adjustment (See section 6).</li> <li>• Check garage door for binding.</li> <li>• If an operational problem exists, and opener will not run closed. The opener can be forced to close as follows (See section 5). Hold the wall control button down until door is completely closed.</li> <li>• Disconnect the Safe-T-Beam® System from the opener and contact an authorized Genie® Dealer or The Genie Company at 1-800-35-GENIE.</li> </ul>
<b>Door starts down, then STOPS before it is closed.</b>  <b>OR</b>  <b>Door will only open.</b>	<ul style="list-style-type: none"> <li>• Check CONTACT REVERSE (See section 6).</li> <li>• Check garage door for binding.</li> <li>• Wires shorted. Staples can cut insulation and short wires. Repair or replace.</li> <li>• Check "CLOSE FORCE" adjustment (See section 6).</li> </ul>
<b>Door starts up, but STOPS before it's completely open.</b>	<ul style="list-style-type: none"> <li>• Be sure door, opener, and springs are in good repair, properly lubricated and balanced (See Maintenance section 10).</li> <li>• Check "OPEN" limit setting (See section 6).</li> <li>• Check "OPEN FORCE" adjustment (See section 6).</li> <li>• <b>▲ WARNING:</b> If you suspect a problem with the garage door hardware or springs, contact an authorized Genie® Dealer or a trained door system technician, or contact The Genie Company at 1-800-35-GENIE.</li> </ul>
<b>Door will only run in close direction.</b>	<ul style="list-style-type: none"> <li>• Check door balance, condition, and door spring.</li> <li>• Check "OPEN FORCE" adjustment (See section 6).</li> <li>• <b>▲ WARNING:</b> If you suspect a problem with the garage door hardware or springs, contact an authorized Genie® Dealer or a trained door system technician, or contact The Genie Company at 1-800-35-GENIE.</li> </ul>
<b>Door opener starts for no reason.</b>	<ul style="list-style-type: none"> <li>• Was a remote control lost or stolen? Erase all remote control codes from receiver memory and reprogram (See section 7).</li> <li>• Button stuck on Wall Control or remote.</li> <li>• Check CLOSE limit switch setting (See section 6).</li> <li>• Wires shorted. Staples can cut insulation and short wires. Repair or replace.</li> </ul>
<b>Noisy operation.</b>	<ul style="list-style-type: none"> <li>• Be sure all fasteners are tight.</li> <li>• Be sure door and opener are in good repair, properly lubricated and balanced (See Maintenance section 10).</li> </ul>

Power head LED		Possible Problem	Solution
Red LED showing	Green LED showing		
OFF	OFF	Normal operation	None required
Continuous ON		<ul style="list-style-type: none"> <li>• Programming incomplete</li> </ul>	<ul style="list-style-type: none"> <li>• Complete programming</li> </ul>
1 BLINK, Pause (Repeat)		<ul style="list-style-type: none"> <li>• Transmitter has not learned</li> </ul>	<ul style="list-style-type: none"> <li>• Push transmitter button to program (See section <b>7</b>)</li> </ul>
	1 BLINK, Pause (Repeat)	<ul style="list-style-type: none"> <li>• Limit Programming incomplete</li> <li>• Safe-T-Beam® sensor obstruction going down</li> <li>• Door obstruction going down</li> <li>• Door obstruction going up</li> </ul>	<ul style="list-style-type: none"> <li>• Set DOWN LIMIT programming</li> <li>• Check for obstruction, remove</li> <li>• Check for obstruction, remove.                             <ul style="list-style-type: none"> <li>– Check door spring (See section <b>10</b>)</li> <li>– Contact The Genie Company at 1-800-35-GENIE</li> </ul> </li> </ul>
	2 BLINKS, Pause (Repeat)	<ul style="list-style-type: none"> <li>• Limit Programming incomplete</li> <li>• Wire to power head or wire connection at power head is bad.</li> <li>• Sensors out of alignment</li> <li>• Continuous obstruction of Safe-T-Beam® sensor</li> </ul>	<ul style="list-style-type: none"> <li>• Set UP LIMIT programming</li> <li>• Check power head wiring, check connections,                             <ul style="list-style-type: none"> <li>– Replace or repair</li> </ul> </li> <li>• Check Source &amp; Sensor alignment</li> <li>• Check for obstruction of Safe-T-Beam® sensor</li> </ul>
	3 BLINKS, Pause (Repeat)	<ul style="list-style-type: none"> <li>• Limits set backwards</li> </ul>	<ul style="list-style-type: none"> <li>• Clear limits and reprogram (See section <b>6</b>)</li> </ul>
	4 BLINKS, Pause (Repeat)	<ul style="list-style-type: none"> <li>• Wall button wire short</li> <li>• Wall button wires reversed in power head connector.</li> </ul>	<ul style="list-style-type: none"> <li>• Check button(s) and wiring. Staples can cut insulation and shorts wires. Replace Wall Control, repair or replace wiring.                             <ul style="list-style-type: none"> <li>– Contact The Genie Company at 1-800-35-GENIE</li> </ul> </li> <li>• Reverse wire placement in power head connector. (See section <b>3</b>)</li> </ul>
	5 BLINKS, Pause (Repeat)	<ul style="list-style-type: none"> <li>• Chain/belt is too tight</li> <li>• Control system failure</li> </ul>	<ul style="list-style-type: none"> <li>• Adjust chain/belt tension (See section <b>1</b>).                             <ul style="list-style-type: none"> <li>– Contact The Genie Company at 1-800-35-GENIE</li> </ul> </li> <li>• Contact Genie® authorized dealer for service</li> </ul>



## TRANSMITTER COMPLIANCE STATEMENT

Transmitters comply with all United States and Canadian legal requirements as of the date of manufacture. No warranty is made that they comply with all legal requirements of any other jurisdiction. If transmitters are to be used in another country, the importer must determine compliance with any local laws and regulations which may differ from United States and Canadian requirements prior to use.

Los transmisores cumplen con todas las reglamentaciones legales de los Estados Unidos y del Canadá, en la fecha de fabricación. Ninguna garantía se da que cumplan con todas las reglamentaciones legales de ninguna otra jurisdicción. Si los transmisores se van a utilizar en otro país, el importador debe determinar si cumplen con las reglamentaciones y leyes locales que puedan ser diferentes a las reglamentaciones de los Estados Unidos y del Canadá, antes de usar los mismos.

Les émetteurs sont conformes à la réglementation américaine et canadienne à compter de leur date de fabrication. Aucune garantie n'est stipulée indiquant qu'ils sont conformes à toutes les prescriptions juridiques d'autres autorités. Si les émetteurs sont utilisés dans d'autres pays, il incombe à l'importateur d'en déterminer leur conformité aux lois et règles locales pouvant différer de celles des États-Unis et du Canada avant toute utilisation desdits émetteurs.

Sendegeräte entsprechen allen gesetzlichen Bestimmungen in den USA und Kanada zum Zeitpunkt der Herstellung. Wir übernehmen keine Gewährleistung für die Einhaltung aller gesetzlichen Bestimmungen in anderen Ländern. Sollen Sendegeräte in anderen Ländern eingesetzt werden, so muss der Importeur vor dem Gebrauch sicherstellen, dass die Sendegeräte auch solchen lokalen Bestimmungen entsprechen, welche von den Bestimmungen der USA und Kanadas abweichen.

截止于制造日期, 传动装置符合美国和加拿大的所有法律要求。不提供传动装置符合任何其他司法地区所有法律要求之担保。如果传动装置需在任何其他国家使用, 进口商必须在使用之前确定装置符合与美国和加拿大要求不同之所有地方法规条例。

トランスミッターは、製造日付けのアメリカ合衆国及びカナダの法的条件に準拠します。しかしながら、トランスミッターがアメリカ合衆国及びカナダ以外の国の法的条件に準拠するか否かは一切保証できません。トランスミッターがアメリカ合衆国及びカナダ以外の国で使用される場合、同製品の使用に先立つ法規制がこれらの国々と異なることがあるため、輸入者は同製品が輸入国の法規制に準拠することを確認しなければなりません。

트랜스미터들은 미국과 캐나다 전역에서 제조 날짜를 명기해야 하는 요구사항에 따라야 합니다. 기타 다른 관할권의 모든 법적인 요구 사항에 따라야 하는 책임은 없습니다. 만일 트랜스미터들이 기타 다른 지역에서 사용될 경우 수입업자는 사용하기에 앞서 미국과 캐나다와의 요구사항과는 다를지도 모르는 그 지역의 법과 조례에 따라야 할지의 여부를 결정해야 합니다.



## MODELS 2022/2024/2042 LIMITED WARRANTY

GMI Holdings, Inc. d/b/a The Genie Company ("Seller") warrants to the original purchaser of the below identified opener, Model 2022/2024/2042 ("Product"), subject to all of the terms and conditions hereof, that the Product and all components thereof will be free from defects in materials and workmanship for the following period(s) of time, measured from the date of purchase:

MOTOR - Seller warrants the motor for a period of TEN (10) YEARS.

PARTS - Seller warrants all other parts and components for a period of ONE (1) YEAR.

Seller's obligation under this warranty is specifically limited to repairing or replacing, at its option, the Product or any part thereof which is determined by Seller to be defective during the applicable warranty period. Any labor charges are excluded and will be the responsibility of the purchaser.

This warranty gives you specific legal rights, and you may also have other rights which vary from state to state. This warranty is made to the original purchaser of the Product only, and is not transferable or assignable. This warranty applies only to Product installed in a residential or other non-commercial application. It does not cover any Product installed in commercial or industrial building applications. This warranty does not apply to any unauthorized or improper installation, alteration or repair of the Product, or to any Product or component which has been damaged or deteriorated due to misuse, neglect, accident, failure to provide necessary maintenance, normal wear and tear, or acts of God or any other cause beyond the reasonable control of Seller, and does not cover batteries, missing or damaged parts from clearance or open box sales, or repairs or maintenance to door components.

ALL EXPRESS AND IMPLIED WARRANTIES FOR THE PRODUCT, INCLUDING BUT NOT LIMITED TO ANY IMPLIED WARRANTIES OF MERCHANTABILITY AND FITNESS FOR A PARTICULAR PURPOSE, ARE LIMITED IN TIME TO THE APPLICABLE WARRANTY PERIOD REFLECTED ABOVE. NO WARRANTIES, WHETHER EXPRESS OR IMPLIED, WILL APPLY AFTER THE LIMITED WARRANTY PERIOD HAS EXPIRED. Some states do not allow limitations on how long an implied warranty lasts, so the above limitation may not apply to you.

IN NO EVENT SHALL GMI HOLDINGS, INC. OR ITS PARENT OR AFFILIATES BE RESPONSIBLE FOR, OR LIABLE TO ANYONE FOR, SPECIAL, INDIRECT, COLLATERAL, PUNITIVE, INCIDENTAL OR CONSEQUENTIAL DAMAGES, even if Seller has been advised of the possibility of such damages. Such excluded damages include, but are not limited to, loss of use, cost of any substitute product, or other similar indirect financial loss. Some states do not allow the exclusion or limitation of incidental or consequential damages, so the above limitation or exclusion may not apply to you.

Claims under this warranty must be made promptly after discovery and within the applicable warranty period. To obtain warranty service, you must contact Genie® customer service and provide proof of the date and location of purchase and identification as the original purchaser. Call Genie® Customer Service toll free at 1-800-354-3643 to speak with a trained representative. Purchaser must allow seller a reasonable opportunity to inspect Product claimed to be defective prior to removal or alteration of its condition. Upon determination by Seller that the Product or any part thereof is defective during the applicable warranty period (which may require purchaser to return the Product to Seller at purchaser's expense), Seller will supply the purchaser with replacement parts or, at its option, a replacement Product. Seller may use new or reconditioned parts, or a new or reconditioned Product of the same or similar design.

There are no established informal dispute resolution procedures of the type described in the Magnuson-Moss Warranty Act.

PURCHASER: \_\_\_\_\_

INSTALLATION ADDRESS: \_\_\_\_\_

DATE PURCHASED: \_\_\_\_\_ SERIAL NUMBER: \_\_\_\_\_

OPENER MODEL: \_\_\_\_\_

REMOTE CONTROL MODEL: \_\_\_\_\_

DEALER NAME: \_\_\_\_\_

DEALER ADDRESS: \_\_\_\_\_