

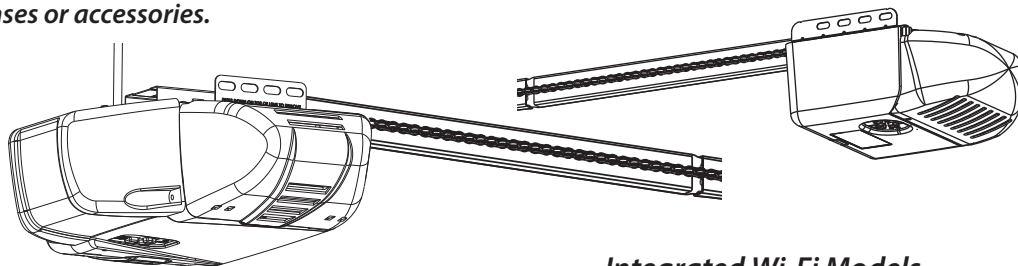

BELT/CHAIN DRIVE GARAGE DOOR OPENERS PROGRAMMING, OPERATION & MAINTENANCE MANUAL

Images are for illustration purposes only, Your model may have different covers, lenses or accessories.



- All Standard Models
- Single Bulb Models
- Dual Bulb Models
- Battery Backup (BBU) Models

- Integrated Wi-Fi Models
- Integrated LED Lighted Models
- Wireless Wall Console Models
- Chain & Belt Tube Rail Models
- Chain & Belt Channel Models

DO NOT use photocells from other manufacturers or openers with this opener.

INSTALLER: LEAVE THIS MANUAL WITH HOMEOWNER

HOMEOWNER: SAVE THIS MANUAL FOR FUTURE REFERENCE

⚠ WARNING

To reduce the risk of injury to persons or damage to property, use this opener only with a sectional residential door.

⚠ AVERTISSEMENT

Por reduire le risque de blessures ou de dommages materials, utilisez cet ouvre-porte uniquement pour une porte a section re sidentielie.



DO NOT return product to store,
visit www.geniecompany.com
or call Customer Service at: 1-800-35-GENIE

SERIAL NUMBER DECAL

iDCM SERIAL NUMBER DECAL

INDEX

1	Safety & General Information	
	Introduction	1
	Safety Notifications.....	2
	Important Installation Instructions.....	3
2	Standard & Safety Features	4
3	Programming Information	
	Introduction to opener programming	5
	Setting the DOWN Limit	6
	Setting the UP Limit	7
	Setting the Force Control	8
	Contact Reverse Test	8
	Contact Reverse Adjustment	8
	Remote Control Programming	9
	Wireless Wall Console Install & Prog*	10
	Keypad Programming*	11
	Homelink & Car2U Programming*	12
	Aladdin Connect® Set up.....	13-14
4	Special Installation Information	
	Force Adjustment Guide.....	15
	Clearing Remote Memory	16
	Tube Rail Adjustments.....	16
	Locating Safe-T-Beam® Pairs.....	17
	Safe-T-Beam Troubleshooting	17
	Permanent Wiring Instructions	17
	Installing Battery Backup (BBU).....	18
5	Maintenance	
	Important Safety Instructions.....	19
	Regular Maintenance Schedule	20
	Door Inspection & Maintenance.....	20
	Remote Battery Replacement.....	21
	Light Bulb Replacement	21
6	Troubleshooting & LED Signals.....	22-23
7	Replacement Parts	24-27
8	DASMA Information	28-29

**Abbreviated versions. See instructions that accompany the accessory or vehicle owners manual for full details and instructions.*

FCC Part 15.21 Statement:
Changes or modifications not expressly approved by the party responsible for compliance could void the user's authority to operate the equipment.

FCC / IC Statement:
This device complies with FCC Part 15 and Industry Canada licence-exempt RSS standard(s). Operation is subject to the following two conditions: (1) this device may not cause harmful interference, and (2) this device must accept any interference received, including interference that may cause undesired operation of the device.

Le présent appareil est conforme aux CNR d'Industrie Canada applicables aux appareils radio exempts de licence. L'exploitation est autorisée aux deux conditions suivantes : (1) l'appareil ne doit pas produire de brouillage, et (2) l'utilisateur de l'appareil doit accepter tout brouillage radioélectrique subi, même si le brouillage est susceptible d'en compromettre le fonctionnement.

SAVE THESE INSTRUCTIONS

READ AND FOLLOW ALL INSTRUCTIONS

1 INTRODUCTION

Thank you for purchasing a Genie® brand garage door opener. Genie® is the leader in garage door opener technology.

Please note that this manual covers several different models of Genie® brand garage door openers. Illustrations contained in this manual may not reflect the exact model purchased. Skip steps or pages that do not apply to your specific model. Programming and installation of the opener and accessories are identical even though they may appear differently.

All external accessories shown in this manual are available for purchase separately from your local Genie® retailer.

Read and understand all SAFETY WARNINGS and CAUTIONS contained in this manual before proceeding.



DO NOT RETURN PRODUCT TO STORE
If you require assistance or have any questions, a knowledgeable Genie Service Technician is just a phone call away at:
1-800-35-GENIE (1-800-354-3643)
Or visit our website at:
www.geniecompany.com

Before setting up your new garage door opener, please note the model plate on the opener and serial number(s) located on the front of this manual. This information will be necessary should you seek technical support via our website, customer support department or local servicing Genie dealer.

Spanish language manuals available at: } **www.geniecompany.com**
Idioma alternativo manuales disponibles en:

SAFETY NOTIFICATIONS & INSTRUCTIONS

OVERVIEW OF POTENTIAL HAZARDS READ THIS SAFETY INFORMATION

Garage doors are large, heavy objects that move with the help of springs under high tension and electric motors. Since moving objects, springs under tension, and electric motors can cause injuries, your safety and the safety of others depend on you reading the information in this manual. If you have questions or do not understand the information presented, call your nearest trained door system technician or visit our website at www.geniecompany.com.

CONVENTIONS USED IN THESE INSTRUCTIONS

The following safety alert symbol and signal words are used throughout this manual to call attention to and identify different levels of hazards and special instructions.

This is the safety alert symbol. This symbol alerts you to potential hazards that can kill or hurt you and others. All safety messages will follow the safety alert symbol and the word "DANGER", "WARNING", or "CAUTION".



- **DANGER** indicates an imminently hazardous situation which, if NOT avoided, will result in death or serious injury.
- **WARNING** indicates a potentially hazardous situation which, if NOT avoided, could result in death or serious injury.
- **CAUTION** indicates a potentially hazardous situation which, if NOT avoided, may result in injury or property damage.
- The word **NOTE** is used to indicate important steps to be followed or important considerations.

Tous les messages concernant la sécurité seront indiqués après un symbole d'alerte de la sécurité et l'une des mentions suivantes "DANGER", "AVERTISSEMENT" ou "MISE EN GARDE".



- **DANGER** signale une situation dangereuse imminente qui, si elle n'est pas évitée, risque d'entraîner des blessures graves, voire mortelles.
- **AVERTISSEMENT** signale une situation potentiellement dangereuse qui, si elle n'est pas évitée, risque d'entraîner la mort ou des blessures graves.
- **MISE EN GARDE** signale une situation potentiellement dangereuse qui, si elle n'est pas évitée, risque d'entraîner des blessures ou des dommages matériels.
- Le terme **REMARQUE** est utilisé pour signaler les étapes importantes à suivre ou d'importants éléments à prendre en considération.

IMPORTANT SAFETY INSTRUCTIONS

POTENTIAL HAZARD	EFFECT	PREVENTION
<p>MOVING DOOR</p>	<p>WARNING Could result in Serious Injury or Death</p>	<p>Do Not operate unless the doorway is in sight and free of obstructions. Keep people clear of opening while door is moving. Do Not allow children to play with the door opener. Do Not change opener control to momentary contact unless an external reversing means is installed. Do Not operate a door that jams or one that has a broken spring.</p>
<p>ELECTRICAL SHOCK</p>	<p>WARNING Could cause Serious Injury or Death</p>	<p>Turn off electrical power before removing opener cover. When replacing the cover, make sure wires are not pinched or near moving parts. Opener must be electrically grounded.</p>
<p>HIGH SPRING TENSION</p>	<p>WARNING Could cause Serious Injury or Death</p>	<p>Do Not try to remove, repair or adjust springs or anything to which door spring parts are fastened such as wood block, steel brackets, cables or any other structure or like item. Repairs and adjustments must be made by a trained service representative using proper tools and instructions.</p>

IMPORTANTES CONSIGNES DE SÉCURITÉ

DANGER POTENTIEL	EFFET	PRÉVENTION
<p>PORTE EN MOUVEMENT</p>	<p>AVERTISSEMENT Pourrait entraîner des blessures graves voire la mort</p>	<p>Utiliser uniquement si la porte est en vue et libre de tout obstacle. Ne laisser personne se tenir dans l'ouverture de la porte pendant qu'elle est en mouvement. Ne pas permettre aux enfants de jouer avec l'opérateur de la porte. Ne pas modifier la commande de l'opérateur à contact momentané ni moins qu'un moyen d'inversion externe soit installé. Ne pas faire fonctionner une porte qui bloque ou dont le ressort est cassé.</p>
<p>CHOC ÉLECTRIQUE</p>	<p>AVERTISSEMENT Pourrait entraîner des blessures graves voire la mort</p>	<p>Couper le courant avant d'enlever le couvercle de l'opérateur. Lorsque le couvercle doit être remplacé, s'assurer que les fils ne sont ni coincés ni près des pièces mobiles. L'opérateur doit être correctement mis à la terre.</p>
<p>TENSION ÉLEVÉE RESSORT</p>	<p>AVERTISSEMENT Pourrait entraîner des blessures graves voire la mort</p>	<p>Ne pas essayer d'enlever, réparer ni ajuster les ressorts ou toute autre pièce à laquelle le ressort de la porte est attaché, y compris blocs de bois, supports en acier, câbles ou autres articles semblables. Les réparations et les réglages doivent être effectués par technicien qualifié qui se sert d'outils appropriés et qui respecte les instructions.</p>

IMPORTANT INSTALLATION INSTRUCTIONS



TO REDUCE THE RISK OF SEVERE INJURY OR DEATH

READ AND FOLLOW ALL SAFETY, INSTALLATION AND OPERATION INSTRUCTIONS. If you have any questions or do not understand an instruction, call The Genie Company.

- **DO NOT** install opener on an improperly balanced door. An improperly balanced door could cause severe injury. Repairs and adjustments to cables, spring assembly and other hardware must be made by a trained service person using proper tools and instructions.
- Remove all ropes, and disable all locks connected to the door before installing opener.
- Where possible, install the door opener 7 feet or more above the floor. For products having an emergency release, mount the emergency release within reach, but at least 6 feet above the floor and avoiding contact with vehicles to avoid accidental release. **DO NOT** use emergency release cord to pull door.
- **DO NOT** connect the opener to the source of power until instructed to do so.
- Locate the wall control button: A) Within sight of door. B) At a minimum height of 5 feet, so small children cannot reach it. C) Away from all moving parts of the door.
- Install the entrapment WARNING label next to the wall button or console, in a prominent location. Install the emergency release handle on the emergency release cord.
- The opener must reverse when the door contacts a 1-1/2 inch high object on the floor at the center of the doorway. This is about the size of a 2" x 4" board laid flat.

IMPORTANTES INSTRUCTIONS D'INSTALLATION



POUR RÉDUIRE LES RISQUES DE BLESSURES GRAVES VOIRE MORTELLES

LIRE ET SUIVRE ATTENTIVEMENT TOUTES LES INSTRUCTIONS D'INSTALLATION ET DE FONCTIONNEMENT AINSI QUE TOUTES LES CONSIGNES DE SÉCURITÉ. Si vous avez des questions ou si vous ne comprenez pas une instruction, veuillez contacter directement The Genie Company.

- **NE PAS** installer l'opérateur sur une porte mal équilibrée. Celle-ci pourrait entraîner de graves blessures. Les réparations et les réglages des câbles, ensembles de ressort ou tout autre article de quincaillerie doivent être effectués par un professionnel qui se sert d'outils appropriés et qui respecte les instructions.
- Enlever toutes les cordes et désactiver toutes les verrous de la porte avant l'installer l'opérateur.
- Dans la mesure du possible, installer l'ouvre-porte à 2,1 m ou plus au-dessus du sol. Pour les produits dotés d'un cordon de déclenchement d'urgence, installer le déclenchement d'urgence mais au moins à 1,8 m au-dessus du sol en évitant tout contact avec les véhicules pour éviter qu'ils ne soient déclenchés accidentellement. **NE PAS** utiliser d'urgence cordon de libération pour ouvrir ou fermer la porte.
- **NE PAS** connecter l'opérateur à la source d'alimentation tant que l'instruction n'est pas donnée.
- Repérer la console murale: A) En vue de la porte. B) À une hauteur minimale de 1,5 m afin que les jeunes enfants ne puissent pas l'atteindre. C) Loin de toutes pièces mobiles de la porte du garage.
- Placer l'étiquette d'AVERTISSEMENT en cas de coinçage à proximité du bouton mural ou de la console de manière à ce qu'elle soit bien en évidence. Installer la poignée du cordon de déclenchement d'urgence.
- L'opérateur doit s'inverser lorsque la porte entre en contact avec un objet d'une hauteur de 3,8 cm placé sur le sol, au centre de l'ouverture de la porte. Ceci équivaut environ à une planche de 5 x 10 cm posée à plat sur le sol.



Opener is equipped with grounded electrical plug for your protection, and **only fits grounded electrical outlets. DO NOT** alter plug in any way! **If you have no grounded outlets, have one installed by a licensed electrician.** Opener must be properly grounded to prevent personal injury and equipment damage. **NEVER USE AN EXTENSION CORD!** Check local building codes for any requirement that you must have a permanent hard-wired connection. Permanent hard-wired connections must be performed by a licensed electrician using proper tools and instructions.



L'opérateur, qui est équipé d'une prise électrique mise à la terre pour votre protection **est compatible uniquement avec des prises électriques mises à la terre. NE PAS** modifier la fiche d'une quelconque manière. Si vous n'avez pas de prises mises à la terre, faites-en installer par un électricien agréé. L'opérateur doit être correctement mis à la terre pour éviter les blessures corporelles et des dommages matériels. **NE JAMAIS UTILISER DE RALLONGE!** Vérifiez les codes locaux des bâtiments pour connexions câblées permanente. Les connexions câblées permanentes doivent être effectuées par un électricien agréé qui se servira d'outils appropriés et respectera les consignes.

2

SAFETY & STANDARD FEATURES



Retail version shown

7



8

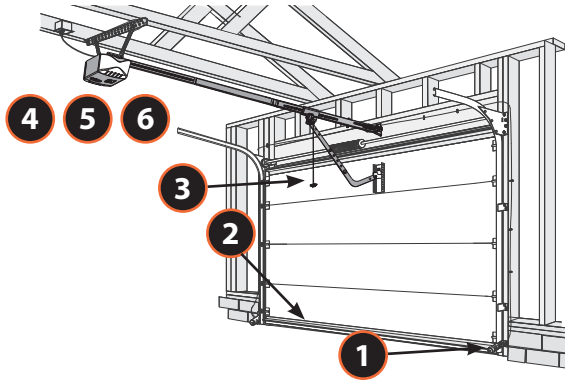

Vehicle
Compatible

1. Safe-T-Beam® (STB) Non-Contact Reversing System:

- Places an infrared beam across the door opening.
- Only affects the DOWN travel of the door.
- Stops an open door from closing or reverses a door while in the down travel.
- Reversing system can be overridden with constant pressure on the wired wall console only.
- The door will stop and reverse to the full open position if beam is obstructed.
- Self-diagnostic LEDs on STBs and powerhead alert to operational issues (See *Locating Safe-T-Beam® Pairs & Troubleshooting* section in this manual for more information).

2. Contact Reversing System:

- Automatically reverses a closing door upon contact with an obstruction (Force Control).

3. Manual Emergency Release pull handle & cord:

- Manually releases door from door opener. Used during a power failure or other emergency to allow manual opening and closing of the door.
- **DO NOT use emergency release cord to pull the door!**

4. Automatic Lighting System:

- Lighting system turns ON when door is activated and automatically turns OFF 4 minutes later.
- Can be activated/deactivated manually from the wall console.

5. Genie Battery Backup (BBU):

- Included or optional with select models. Provides power to opener in the event of a power failure. DO NOT install BBU until opener is fully installed, programmed and tested.

6. Integrated Aladdin Connect® (iDCM):

- Available with select models, allows operation of the garage door opener with a secure mobile device application (app) from anywhere.

7. Wall Console

- **Wired Wall Console** operates door opener from inside garage with an open/close button. Includes a manual light control and override and Sure-lock™ security switch to lock out all remote control operation.
- **Wireless Wall Console** (included with select models) programs to the opener like a remote control. Includes operation button, light control override and operation delay for 10, 20, or 30 seconds.

8. Intellicode® Encryption, Factory Programmed Remote(s) :

- An encryption system that enhances the security of the door opener by continuously changing the access code each time the remote is used.
- Factory programmed remote control(s) are included with this opener.

NOTE: Before programming the opener, check to make sure there are no objects in the garage door opening. DO NOT allow persons to enter the area of the door while programming and operating.

Please note that this manual covers several different models of Genie® brand garage door openers. Illustrations contained in this manual may not reflect the exact model purchased. Skip steps or pages that do not apply to your specific model. Programming and installation of the opener and accessories are identical even though they may appear differently.

The following steps list the order of programming the opener's functional settings and install any accessories that were included with the opener or purchased separately. These steps should be performed in order.

1. Down travel limit
2. Up travel limit
3. Force control
4. Contact reverse test and adjustment
5. Remote control programming
 - Remote control(s) included with this opener are programmed at the factory. The information provided on this page should be used if adding additional remote controls
6. Wireless wall console installation and programming (if equipped)
7. Accessory programming :
 - Install and program wireless wall console (if equipped)
 - Program wireless keypad (if applicable)
 - Program built in vehicle remote (if applicable)
 - Program the integrated Aladdin Connect if equipped
8. Install battery backup (if equipped)

Term Definitions:

Travel Limits Programmable setting to adjust how far door travels up or down.

Force Control refers to how much power is needed to move (open/close) a particular door and does NOT require programming.

Remote & Accessory Programming synchronizes remote devices with the powerhead.

(Remote Controls, Aladdin Connect®, Wireless Keypad, Vehicle Remote Systems)

Programming Button Layout

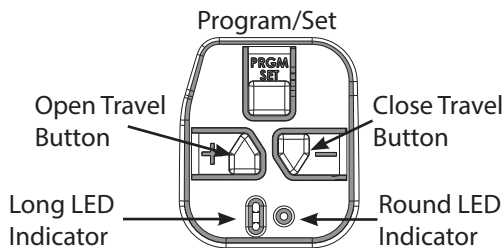

NOTE: Each programming step has a 30 second time limit for completion after the function is initiated. After 30 seconds, both LED's will illuminate RED indicating time has expired and the step must be restarted. Restart the step as many times as necessary to complete the programming.

PROGRAMMING DOWN TRAVEL LIMIT

⚠ WARNING

- Make sure doorway is in full view and clear of obstacles and people to avoid injury or property damage.
- DO NOT operate this unit from the wall control before LIMITS are set. Severe damage to the opener could occur.
- The carriage MUST be engaged to turnbuckle BEFORE setting limits. See installation poster or call Customer Service at 1-800-35-GENIE or visit www.geniecompany.com.
- DO NOT set limits with Battery Backup attached. AC power MUST be connected to the opener while setting limits for proper operation.

⚠ AVERTISSEMENT

- S'assurer que le passage de la porte est visible et dégagé, à savoir sans obstacles ni personne afin d'éviter toute blessure potentielle ou dommage matériel.
- NE PAS utiliser cette unité avec la console murale avant d'avoir réglé les LIMITES. L'ouvre-porte pourrait subir de sérieux dommages.
- La tendeur DOIT être engagée dans le chariot AVANT de régler les limites. Voir le poster d'installation (si fourni) ou appelez le service clientèle au 1-800-35-GENIE ou visitez le site www.geniecompany.com.
- NE PAS fixer de limites en mode batterie de secours. L'alimentation CA DOIT être branchée sur l'ouvre-porte, pendant le réglage des limites, pour assurer un bon fonctionnement.

⚠ NOTE: Carriage should be locked to opener. Door should rest somewhere between full open and closed. Do not start with door fully open or closed.

Programming DOWN Limit:

1. Press and hold the DOWN arrow button.
 - Long LED will light BLUE.
2. Release DOWN arrow button.
 - Long LED will flash BLUE.
3. Press and hold the DOWN arrow button until door is fully closed.
 - Use the UP arrow button if door closes too far. Use both UP and DOWN buttons to adjust close travel as necessary.

Door should rest on the floor until the weather strip is compressed enough to seal along the width of the door. Damaged doors or uneven floors may not seal properly. Repair these conditions to achieve a proper seal. DO NOT compress seal so much that the door will bend or buckle.

4. Press and release the SET/PRGM button
 - Both LEDs will flash BLUE then go out.

The DOWN limit is now programmed.

TO ENGAGE DOOR TO CARRIAGE:
Lift door by hand until carriage engages the bullet on the chain/belt systems.

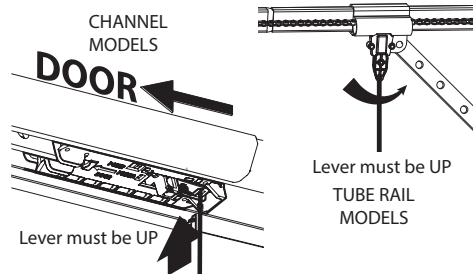

1-2. Enter Programming Mode

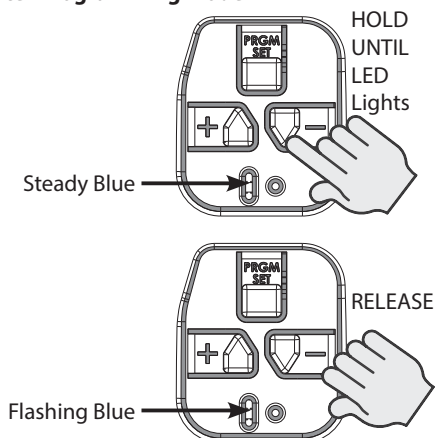

3. Adjust Door Position

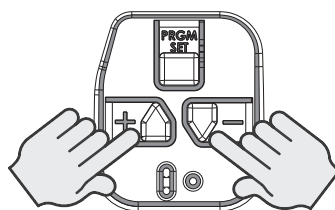

4. Lock Programming

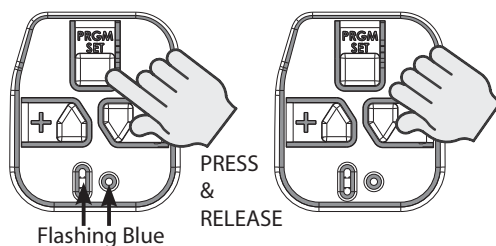

PROGRAMMING UP TRAVEL LIMIT

Programming UP Limit:

1. Press and hold the UP arrow button.
 - Long LED will light BLUE.
2. Release UP arrow button.
 - Round LED will flash BLUE.
3. Press and hold the UP arrow button until door is fully open.
 - Use the DOWN arrow button if door opens too far. Use both UP and DOWN buttons to adjust open travel as necessary.

Door should fully open so that door seal is even with door header. Do Not adjust so much that the door will bend or buckle or stretch door spring cables backward.

4. Press and release the SET/PRGM button
 - Both LEDs will flash BLUE then go out.

The UP limit is now programmed.

1-2. Enter Programming Mode

HOLD
UNTIL
LED
Lights

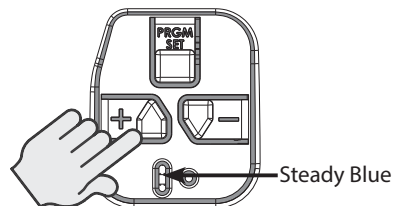

RELEASE

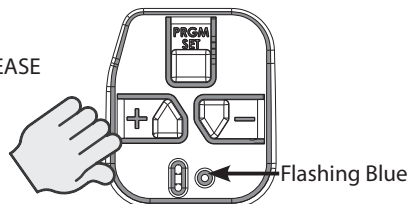

3. Adjust Door Position

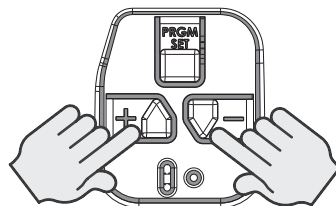

4. Lock Programming

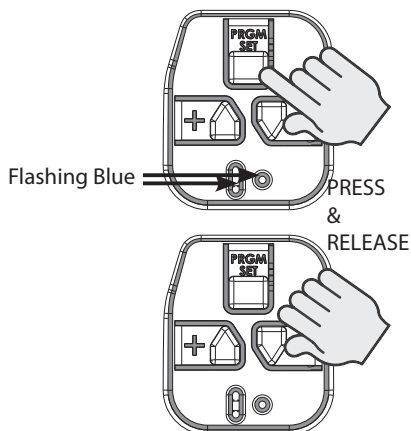

PROGRAMMING FORCE AND CONTACT REVERSE

Force Control

The force controls are automatically set when the wall control is used for the first time with garage door opener. The door **MUST** complete one full cycle, from full open to full close and then, full close to full open, before the settings are automatically recorded.

WARNING

TO AVOID INJURY OR DAMAGE

- **NEVER** adjust the force settings to adjust for damage, including an unbalanced door, binding door track or broken spring.
- Perform a CONTACT REVERSE TEST monthly.

AVERTISSEMENT

Pour éviter les blessures ou des dommages

- **NE JAMAIS** régler la force pour compenser des dommages, y compris une porte mal équilibrée, un rail de porte coincant ou des ressorts cassés.
- Tous les mois, EFFECTUEZ LE TEST D'INVERSION AU CONTACT.

1. Press and release the Wall Control button and allow the garage door to travel and stop at the DOWN limit.
2. Press and release the wall control button and allow the garage door to travel and stop at the UP limit.

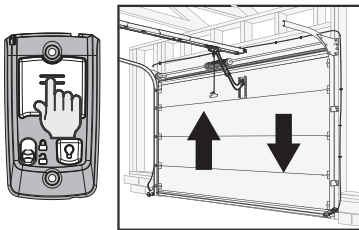

Force Control Adjustments

Force settings are programmed from the factory to remain within safe parameters. These should not require adjustments. However, certain circumstances may require adjustment.

Refer to the "SPECIAL INSTALLATION INFORMATION" section to adjust the force settings.

Contact Reverse Test

NOTE: The limit and Force settings **MUST BE COMPLETED** before performing the Contact Reverse Test.

1. With the garage door open, lay a 2 X 4 board flat on the floor at the center of the door opening.
2. Close the garage door using the wall control.

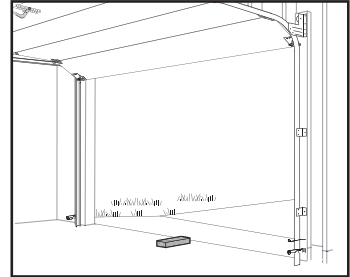
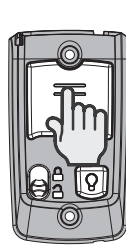

- When the door contacts the board, it should stop and reverse direction within 2 seconds to the full open position.
- The long LED light on the powerhead will begin to flash RED with the reversal of the door.
- Remove the 2" x 4" board and operate the opener with the wall control again. This cycle will clear the flashing red LEDs.

Contact Reverse Adjustment

If the door stops before contacting the board or if it does not reverse direction to fully open after contact with the board, it may be due to an improperly set DOWN limit. Verify settings by:

1. Repeat the "Down Travel Limit" section to make certain the door is closing tight against the floor.
2. Repeat the "Force Control" section on the left to set force limits.
3. Repeat the "Contact Reverse Test" above.

Repeat this process as needed until the door passes the Contact Reverse Test.

Refer to the "SPECIAL INSTALLATION INFORMATION" section to adjust the force settings.

PROGRAMMING ADDITIONAL REMOTE CONTROLS

THE REMOTE CONTROLS INCLUDED WITH THIS OPENER MAY HAVE BEEN PROGRAMMED AT THE FACTORY FOR YOUR CONVENIENCE.

NOTE: The following instructions are for remote control transmitters purchased separately in addition to those provided with this opener, but can also be used if *any* remote(s) may require re-programming.

NOTE: Each programming step has a 30 second time limit for completion after the function is initiated. After 30 seconds, two LED's will illuminate RED indicating time has expired and the step must be re-started. Restart the step as many times as necessary to complete the programming.

NOTE: Do not hold remote too close to the powerhead when programming remote buttons.

NOTE: Each button on each remote must be programmed separately, following these steps.

1. Remove the battery's protective film from the remote by pulling straight down.
2. Press and hold the SET/PRGM button on the opener for two seconds.
 - The ROUND LED will turn BLUE.
 - The LONG LED will then flash PURPLE.
3. Stand at least 5 feet away from opener and slowly press and release the desired button on the remote two times.
 - Both opener LEDs will flash and turn off indicating the remote has been programmed.
4. Press the desired remote button again.
 - The opener should run.

To program the same remote for other garage door openers, repeat the steps above using one of the other remaining remote buttons.

REPEAT STEPS 1 TO 4 FOR EACH OPENER AND REMOTE

NOTE: It is possible to press the remote button too quickly or lightly. If the LEDs do not go off, press the remote button several more times to achieve confirmation.

BASIC PROGRAMMING IS COMPLETE AND YOUR GARAGE DOOR OPENER IS READY TO USE.

Refer to the "SPECIAL INSTALLATION INFORMATION" section to erase remote devices from memory.

1. Activate Remote



2. Enter Programming Mode

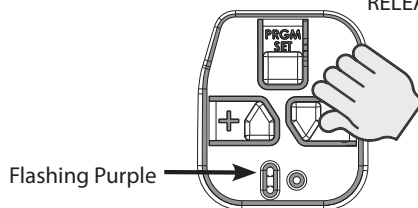
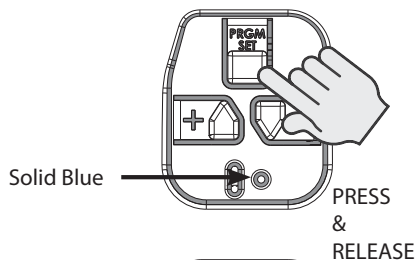

3. Press Remote Button Twice

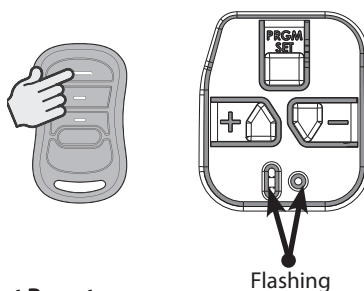

4. Test Remote

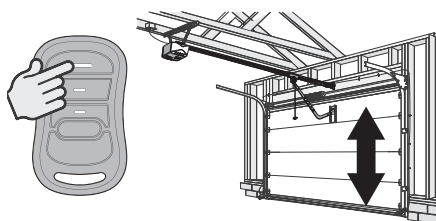

PROGRAMMING WIRELESS WALL CONSOLE

Included with select models

QuickView setup.

Please see complete instructions that accompany Wireless Wall Console

STEP 1) Program Wall Console to Garage Door Opener

Open console cover and remove battery tab before programming.

Place opener into remote control programming mode (SEE PAGE 9):

1. Press and hold the program button on the opener until the round LED turns blue, then release.
2. The round LED will go out and the long LED will begin flashing purple.
3. Press the DOOR button on the WALL CONSOLE 3 times or until door operates.

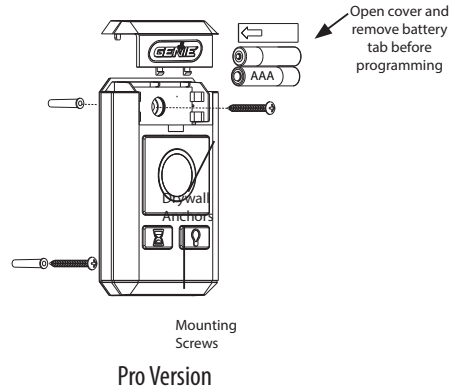
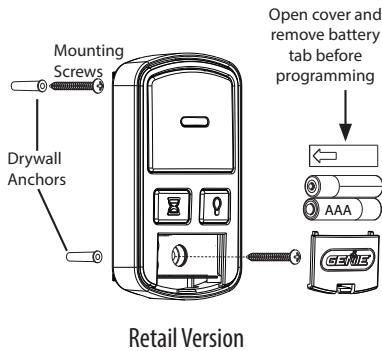

STEP 2) Operating the Door with Wall Console

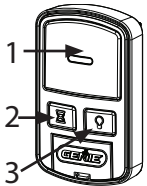

1. DOOR Button - Runs garage door opener.
2. DELAY Button - Each press adds a 10 second delay for door operation (up to 3 times for up to 30 sec.). Press the delay button and door will automatically operate after set delay.
3. LIGHT Button - Overrides the automatic timed light function of the garage door opener.

STEP 3) Mounting the Wall Console

The Wall Console MUST be mounted within sight of the garage door(s) at least five feet above the floor and clear of any moving door part. Use UNINTENDED OPERATION decal in lieu of standard console warning decal.

1. Remove battery cover and batteries.
2. Drill 3/32" pilot hole for the slotted mounting hole screw (included) or 5/32" if using drywall anchors.
3. Install a screw into the pilot hole, leaving a 1/8" gap between the screw head and wall.
4. Hook the slotted mount, on back of console, over the screw.
5. Mark and drill a pilot hole for the screw under the battery cover (included) and secure console to wall
6. Reinstall batteries and cover.

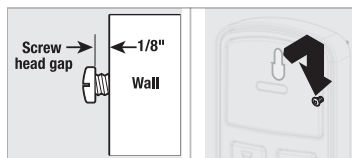
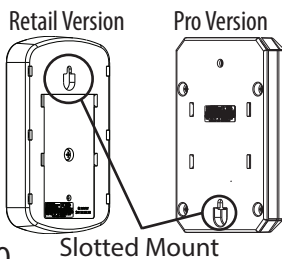

Apply unintended operation decal next to wall console.

PROGRAMMING KEYPAD (abbreviated)

QuickView Single Door setup.

Please see complete instructions that accompany keypad



Activate keypad by opening battery compartment and pull protective tab. Reinstall compartment door to begin programming.

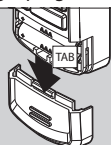

Program Keypad before mounting.

STEP 1) PROGRAMMING A PIN NUMBER (Single Door)

The existing factory default Personal Identification Number (PIN) for this keypad is the number sequence: 3-5-7

Sync the opener and the keypad by performing the following:

1. Ensure the keypad back lighting is off.
2. Place garage door opener into remote control PROGRAMMING MODE (SEE PAGE 9).
3. Press 3-5-7 in sequence on the keypad.
4. Press the UP/DOWN key 3 to 4 times slowly until garage door opener operates.
 - This completes the programming of a single door opener (door 1) and keypad.
 - *IT IS RECOMMENDED THAT YOU CHANGE THIS PIN FROM THE EXISTING FACTORY DEFAULT SETTING of 3-5-7. See STEP 2 below.*

STEP 2) CHANGING DEFAULT PIN OF 3-5-7

1. Enter the factory default pin of 3-5-7.
2. Press PROGRAM key once.
3. Enter a new PIN of your choice (3-8 digits).
4. Press PROGRAM key once.
 - *Your PIN has been changed and your previous PIN will no longer operate the keypad or opener.*

STEP 3) OPERATING THE KEYPAD WITH THE OPENER

Single Door Operation:

1. Ensure number pad back lighting is off.
2. Enter PIN number.
3. Press the UP/DOWN key.
4. Opener will operate.

NOTE: Keypad will remain active for 15 seconds after a successful entry is made. During this 15 seconds ANY key will operate the opener.

Resetting a PIN:

Press and hold both the **PROGRAM** key and the Up/Down key for about five seconds.

The LED's will slowly blink and then go out. When the LED stops blinking, the old programming has been successfully erased.

To create a new PIN, start with STEP 1.

Mounting Keypad

The keypad **MUST** be mounted within sight of the garage door(s) at least five feet above the floor and clear of any moving door part.

1. Remove battery cover and batteries.

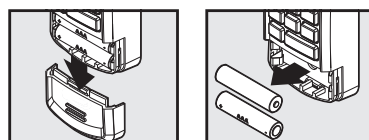

2. Drill 3/32" pilot hole for the top mounting screw (included).
3. Install a screw into the pilot hole, leaving a 1/8" gap between the screw head and wall.

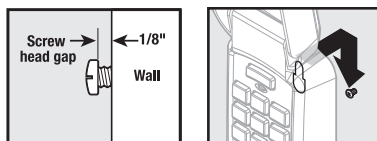

4. Hook the slotted mount, on back of keypad, over the screw.

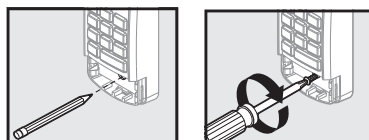

5. Mark and drill a pilot hole for the bottom screw (included) and secure keypad to wall (DO NOT overtighten).
6. Reinstall batteries and cover.

PROGRAMMING VEHICLE CONTROLS (abbreviated)

Programming HomeLink® System

Step 1) Clear HomeLink

Clear HomeLink by pressing and holding down the first and third buttons until the indicator on the HomeLink blinks slow and then fast for 20 seconds; then release both buttons.

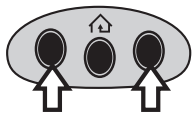

NOTE: Clearing the HomeLink will remove all previously programmed garage door openers.

Step 2) Train HomeLink to the Remote

Choose the button on the HomeLink that will be used to open the door.

NOTE: Hold the Remote two inches from the HomeLink button.

Hold down the remote button. While holding, press and hold the chosen HomeLink button.

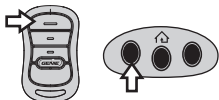

Hold down both buttons until the indicator on the HomeLink blinks slow then fast. Once it blinks, release both buttons.

Step 3) Program HomeLink to the Opener

(Place opener into programming mode) - SEE PAGE 9

A. Press the chosen HomeLink button for two seconds and release. Press that same button again for two seconds and release. The long LED will flash blue and then turn off.

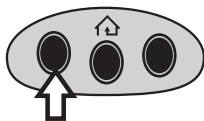

B. Press the HomeLink button a few more times until door moves.

NOTE: For additional instructions, see the motor vehicle manual, or visit www.homelink.com or visit www.geniecompany.com

Programming Car2U® System

Step 1) Clear Car2U to default settings

The default setting for the Car2U system is:

• Button 1 = Genie® Manufactured Openers

• Button 2 = LiftMaster® Manufactured Openers

• Button 3 = Wayne Dalton® Manufactured Openers

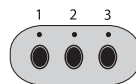

- A. Press and hold buttons 1 and 3 for 20 seconds or until all three LEDs begin to flash.
- B. Release both buttons. The Car2U system is now set to the Factory Default settings

NOTE: Clearing the Car2U remote will remove all previously programmed garage door openers.

Step 2) Program Car2U to the Opener

(Place opener into programming mode) - SEE PAGE 9

- A. Press the designated Car2U button for two seconds and release. Press that same button again for two seconds and release. The long LED will flash blue and then turn off.
- B. Press the Car2U button a few times more until door moves.

Step 3) Changing Factory Default Button for a Genie® Opener

- A. Press and hold buttons 1 & 3 for **ONE SECOND** and release—all three LEDs will light solid red.
- B. Press and hold the button (2 or 3) to change it to—the corresponding LED will flash. While continuing to hold that button, press and release button 1. Press and release button 1 again.
- C. Release the button being held in step B and wait for the LED to stop flashing. This button is now set. Repeat Step 2 for second Opener.

NOTE: For additional instructions see the motor vehicle manual, learcar2u.com.

SETTING UP ALADDIN CONNECT®

Perform these steps only after opener is fully installed, programmed and tested.

IMPORTANT SAFETY INSTRUCTIONS	CONSIGNES DE SÉCURITÉ IMPORTANTES
<p style="text-align: center;">WARNING</p> <p>TO REDUCE THE RISK OF SEVERE INJURY OR DEATH, READ AND FOLLOW ALL INSTRUCTIONS.</p> <ol style="list-style-type: none">1. Never allow children to operate or play with door controls.2. Install the entrapment WARNING placard next to the wall control in a prominent location.3. NO PERSONS SHOULD CROSS THE PATH OF A MOVING DOOR.4. NEVER GO UNDER A STOPPED/PARTIALLY OPEN DOOR.5. The Aladdin Connect® operating system is designed for unattended operation. The door could move unexpectedly. <p style="text-align: center;">SAVE THESE INSTRUCTIONS</p>	<p style="text-align: center;">AVERTISSEMENT</p> <p>POUR RÉDUIRE LE RISQUE DE BLESSURES GRAVES VOIRE MORTELLES, LIRE ET COMPRENDRE TOUTES LES INSTRUCTIONS.</p> <ol style="list-style-type: none">1. NE JAMAIS laisser les enfants utiliser ou jouer avec les commandes de l'ouvre-porte.2. Placer l'étiquette d'AVERTISSEMENT en cas de coincage à proximité du bouton mural ou de la console murale de manière à ce qu'elle soit bien en évidence.3. NE JAMAIS PASSER SOUS LA PORTE EN MOUVEMENT.4. NE JAMAIS PASSER SOUS UNE PORTE À L'ARRÊT PARTIELLEMENT OUVERTE.5. Le système d'exploitation Aladdin Connect™ a été conçu pour fonctionner sans surveillance. La porte peut se déplacer de façon inattendue. <p style="text-align: center;">CONSERVER CES INSTRUCTIONS</p>

Genie® Integrated Aladdin Connect® Models

The Aladdin Connect® system is a convenient mobile device app to operate garage door openers/controllers from anywhere.

The Aladdin Connect® app has the following features:

- Customize access for different users.
- Customize notifications to receive alerts when the garage door is operated, by a specific user, at a specific time or day.
- Review history of opener usage showing dates and times when the opener was operated and by what user.
- Create custom rules to notify you or close the door at specific times or if you door is open for a specific duration.
- Connect your opener to operate with smart home platforms.

1 **Check Wi-Fi Signal**

Before beginning the set-up process please verify the ability to receive a strong Wi-Fi signal in the garage. Connect smartphone to the home Wi-Fi and walk into the garage. Place phone where garage door opener will be mounted. The Wi-Fi signal strength at that location must be at least two bars.

If home Wi-Fi signal does not adequately cover the garage, try the following steps to help improve the signal strength.

- Make sure that the Wi-Fi router is out in the open, not behind a large electronics or in a cabinet.
- Moving the Wi-Fi router closer to the garage.
- Purchase a Wi-Fi extender, available at most electronics stores.

Device Wi-Fi Signal strength indicator



Scan for iOS app



Apple and the Apple logo are trademarks of Apple Inc., registered in the U.S. and other countries. App Store is a service mark of Apple Inc.

Scan for Android app



Follow the Aladdin Connect® app instructions

Follow steps per the app instructions.

- Create an account
- Add a device
- Set up Wi-Fi
- Add users and rules

For help at any time contact The Genie Company at 1-866-599-4995 or visit our website. www.geniecompany.com/aladdinconnect

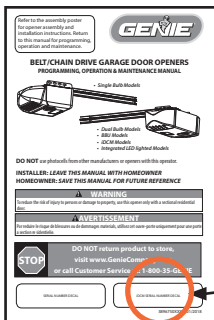

Scan the Aladdin Connect® QR Code on the front of this manual or on the powerhead when prompted by the Aladdin Connect® app.

Install WARNING placard

Once the app configuration is complete, open the door with the wall control, wait 10 seconds, and then close the door and wait 10 seconds. Look at the door status (open or closed) in the app. If the door status is not correct repeat the opening, pausing 10 seconds, closing, and pausing 10 seconds a few times until the door status displays correctly in the app.

Place included unintended operation warning placard next to garage door openers wall button.

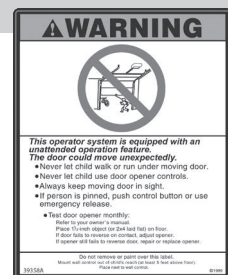

NOTE: This placard should be used in lieu of the standard WARNING placard included with this opener.

NOTE: Use of this product, the software embedded within this product and the related application software is subject to the Terms and Conditions available at: www.geniecompany.com/aladdinconnect

Force Setting Guide:

⚠ WARNING

TO AVOID INJURY OR DAMAGE

- **NEVER** adjust the force settings to adjust for damage, including an unbalanced door, binding door track or broken spring.
- Perform a CONTACT REVERSE TEST monthly.

⚠ AVERTISSEMENT

Pour éviter les blessures ou des dommages

- **NE JAMAIS** régler la force pour compenser des dommages, y compris une porte mal équilibrée, un rail de porte coincant ou des ressorts cassés.
- Tous les mois, EFFECTUEZ LE TEST D'INVERSION AU CONTACT.

Force Settings:

Force settings are pre-programmed at the factory and applied during the Open/Closed Limit settings steps. For normal use, these settings should not need adjustment.

Conditions possibly requiring adjustments are:

1. Doors with very stiff weather seals.
2. Doors that start down, STOP, and reverse before closing.
3. Doors that start up, but STOP before they completely open.

1. **Press and hold** both UP & DOWN arrow buttons until the ROUND LED turns RED. Release buttons.
 - LEDs will show current force level. SEE CHART.
2. Press either the UP or DOWN arrow button until the desired UP force setting is shown. SEE CHART.
3. Press the PRGM button to lock the desired UP FORCE setting.
 - LEDs will now show the current DOWN FORCE setting. SEE CHART.
4. Press either the UP or DOWN arrow button until desired DOWN force setting is shown. SEE CHART.
5. Press the PRGM button to lock the desired DOWN FORCE setting.
 - Both LEDs will turn BLUE then go out confirming that the force settings have been changed and are locked.
6. Opener is now ready to operate and test.
7. Operate door from the wall console two full cycles then perform safety contact reverse test.

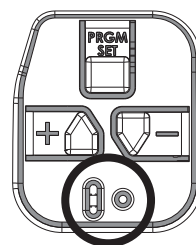
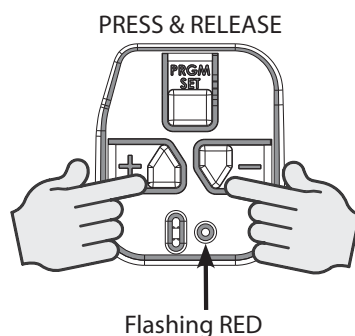

FORCE SETTING CHART

Force Level	Long LED	Round LED
1 (LOWEST)	OFF	BLUE
2	BLUE	OFF
3	BLUE	BLUE
4	OFF	VIOLET
5	VIOLET	OFF
6	VIOLET	VIOLET
7	OFF	RED
8	RED	OFF
9 (HIGHEST)	RED	RED

CLEARING MEMORY OF REMOTES

NOTE: Clearing memory of remotes from the powerhead will clear ALL programmed remotes, wireless keypads and vehicle transmitters. The opener will no longer recognize any signal from any remote device, including a missing remote device. This does not include the Aladdin Connect

All remaining (or recovered) remotes, vehicles and wireless keypads MUST be reprogrammed.

NOTE: The garage door opener will operate normally using the wall console.

1. Press and hold the SET/PRGM button on the opener for two seconds.
 - The ROUND LED will turn BLUE.
 - The ROUND LED will then flash PURPLE.
2. Press and hold the UP & DOWN buttons at the same time until both LEDs turn off.
 - Both opener LEDs will flash and turn off indicating that all remotes have been erased.
3. Press any remote button.
 - The opener should NOT run.

1. Enter Programming Mode

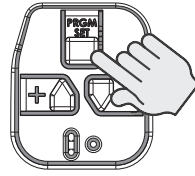

Solid Blue

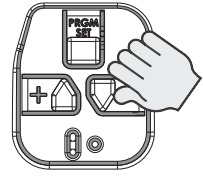

Flashing Purple

2. Press and Hold + & - Buttons

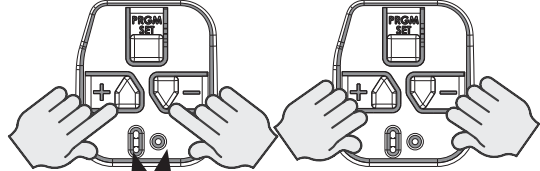

Flashing
Blue

Release when
LEDs turn off

3. Test Remote

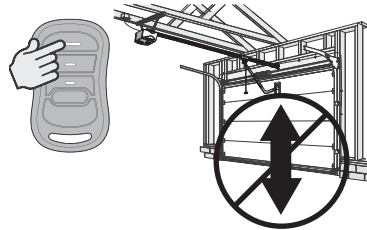

Chain/Belt Adjustments for Tube Type Rails:

NOTE: Might be necessary after unit is installed and run for the first time.

If excessive chain/belt sag is noticed below the rail:

1. Open the door until carriage is about mid travel and stop.
2. Disengage the carriage and manually close the door.
3. Loosen nuts on turnbuckle using 7/16" wrenches.
4. Rotate turnbuckle counter-clockwise until slack is removed from chain/belt.
5. When measured on the opposite side of the rail from the turnbuckle, a properly adjusted chain/belt will have a 1/4" gap to the bottom of the rail.
6. Tighten nuts to secure turnbuckle.
7. Be sure that chain/belt is not twisted or bound.
8. Manually open door to re-engage carriage to turnbuckle.

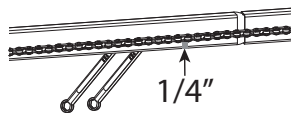
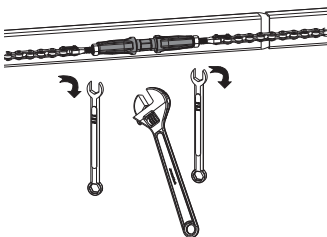

Installing Safe-T-Beams® on multiple garage doors (Preventing “cross-talk”)

LOCATING SAFE-T-BEAM® PAIRS View from Top Down
Transmitter (RED LED) and Receiver (GREEN LED)

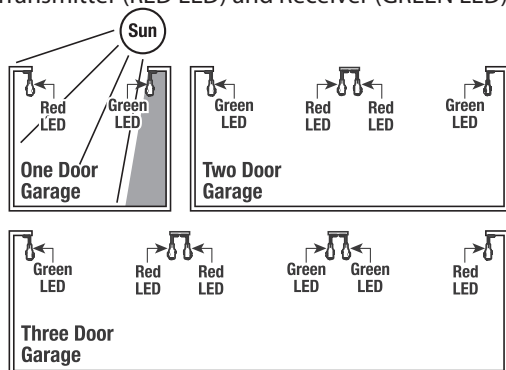

Single Garage Door

- Determine which side of the garage receives direct sunlight.
- Position the Transmitter (Red LED) on the direct sunlight side.

Multiple Garage Doors

- NEVER position Safe-T-Beam® modules where signals will cross.
- Place the Transmitter (Red LED) Safe-T-Beams on adjacent doors facing in opposite directions.

NOTE: Direct sunlight creates interference with Safe-T-Beam® Receiver (Green LED). STB modules CAN be positioned further away from the door opening if necessary to avoid sunlight but no further off the wall to maintain alignment with the Transmitter (Red LED) module.

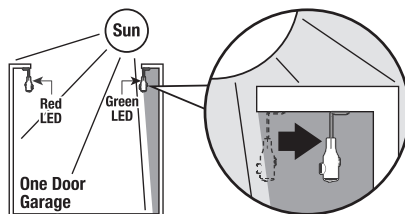

NOTE: Only use Safe-T-Beams® that are included with this opener. **DO NOT** use other brands or types of photocells on this opener.

Safe-T-Beam® Self-Diagnostic Troubleshooting Chart

Source (RED LED)	Sensor (Green LED)	Possible Problem	Solution
ON	ON	Normal Operation	None Required
OFF	OFF	<ul style="list-style-type: none"> • Opener not powered • Wiring from opener bad 	<ul style="list-style-type: none"> • Check breakers, fuses, plugs • Check wiring for shorts
OFF	ON	<ul style="list-style-type: none"> • Wiring to source missing or bad • Power has been interrupted 	<ul style="list-style-type: none"> • Check wiring • Remove power and reapply
2 BLINKS	ON	<ul style="list-style-type: none"> • Beam not aligned • Beam obstructed • Sensor defective 	<ul style="list-style-type: none"> • Check source, Sensor alignment • Check for obstruction • Contact Customer Support
2 BLINKS	OFF	<ul style="list-style-type: none"> • Wire to sensor missing or bad • Sensor defective 	<ul style="list-style-type: none"> • Check wiring • Contact Customer Support
3 BLINKS	ON	<ul style="list-style-type: none"> • Sensor receiving interference 	<ul style="list-style-type: none"> • Determine source of interference • Contact Customer Support

PERMANENT WIRING INSTRUCTIONS:

NOTE: Permanent wiring should only be performed by a professional licensed electrician.

1. Cut existing power cord OUTSIDE CHASSIS.
2. Remove strain relief and power cord.
3. Wire connections must be made INSIDE CHASSIS and there must be at least 6" of new power supply line wire INSIDE CHASSIS. (CHECK LOCAL ELECTRICAL CODES. Conduit, strain relief, and wire nuts are not provided.)

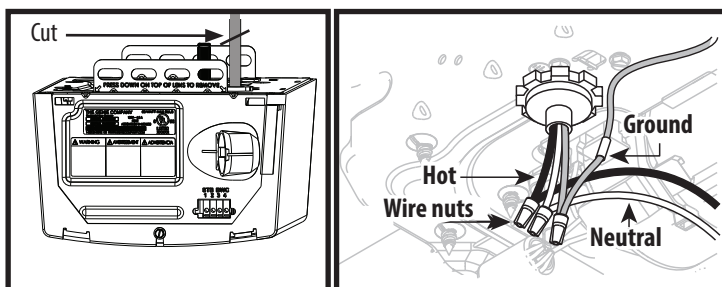

Installing Battery Backup

Perform these steps only after opener is fully installed, programmed and tested.

Battery backup devices from other manufacturers will not operate with this opener.

Use only Genie Battery Backup type battery that was provided. Genie P/N 111658.0002.S (Battery only)

Installing the Battery Backup:

For units that included optional battery backup (BBU)

1. Unplug powerhead from power source.
2. **Dual bulb models:** Tilt BBU approximately 45° and lower into slots in the top rear of the powerhead.
3. Fasten to powerhead with 2 supplied self tapping screws.

NOTE: There are no holes in rear cover. Self Tapping screws will self tap through cover.

- **Single bulb models:** Attach BBU assembly next to the opener and install mounting screws to ceiling or framing.
4. Plug battery harness into plug located at the top of the powerhead.
 5. Reconnect powerhead to power source.

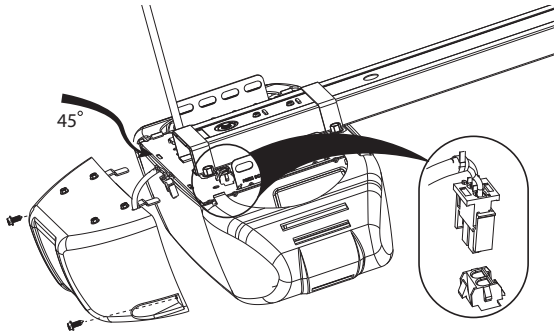

Dual Bulb Models

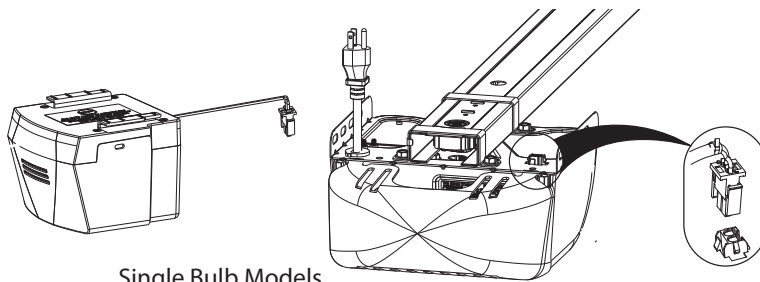

Single Bulb Models

See the troubleshooting section for condition LED's that will illuminate once the Battery Backup is operational.

Both LEDs will signal solid GREEN under normal, fully charged, conditions.

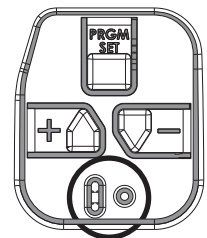

CAUTION TO PREVENT POSSIBLE SERIOUS INJURY or DEATH from electrocution AND REDUCE RISK of FIRE
— Disconnect ALL electric power sources and battery power BEFORE performing ANY service or maintenance.
Install only in DRY locations - NOT INTENDED FOR OUTDOOR USE.
Use only 12V,5AH,SLA replacement battery (P/N 111658.0002.S).

ATTENTION POUR ÉVITER LES BLESSURES GRAVES VOIRE MORTELLE PAR ÉLECTROCUATION POUR RÉDUIRE ES LES RISQUES D'INCENDIE
— Débrancher toutes les sources d'alimentation électriques et la pile avant d'effectuer des opérations de réparation ou d'entretien.
Installer uniquement dans des endroits secs—NE DOIT PAS ÊTRE UTILISÉ À L'EXTÉRIEUR.
Utiliser uniquement une pile de remplacement de 12V,5AH,SLA (réf. 111658.0002.S).

Testing The Genie Battery Backup

NOTE: It is recommended that the battery backup be allowed to charge for 48 hours prior to testing. Initially, the opener may not operate from the battery backup mode if battery is not fully charged.

NOTE: Opener will run at a reduced speed when operating from battery backup.

1. Run the opener using the wall control or remote to ensure it is working properly.
2. Turn off power to opener by unplugging from outlet or turning off breaker.
3. Press wall control or remote control. Opener will run at a slower speed than normal.

NOTE: See troubleshooting guide in this manual if any of the steps above fail.

Work light will not operate while in battery backup mode. (Courtesy white LED's will illuminate.)

4. After successful test, reconnect powerhead to power source.

IMPORTANT SAFETY INSTRUCTIONS

⚠ WARNING

To reduce the risk of severe injury or death, read and follow all instructions.

1. **NEVER** let children operate or play with the door controls.
2. Keep remote away from children.
3. **ALWAYS** keep the moving door in sight and away from people and objects until door is completely closed. NO ONE SHOULD CROSS THE PATH OF THE MOVING DOOR.
4. **NEVER** GO UNDER A STOPPED, PARTIALLY OPEN DOOR.
5. Test opener monthly. The door **MUST** reverse on contact with a 1-1/2" high object (or 2" x 4" board laid flat) at the center of the doorway on the floor. After adjusting either the force or limit of travel, retest door opener. Failure to adjust the opener properly may cause severe injury or death.
6. When possible, use emergency release only when door is closed. Use caution when using this release with the door open. Weak or broken springs are capable of increasing the rate of door closing and increasing the risk of severe injury or death.
7. **KEEP DOORS PROPERLY BALANCED.** See your garage door Owner's Manual. An improperly balanced door increases the risk of severe injury or death. Have a trained door system technician make repairs to cables, spring assemblies, and other hardware.

SAVE THESE INSTRUCTIONS

IMPORTANTES CONSIGNES DE SÉCURITÉ

⚠ AVERTISSEMENT

Pour réduire le risque de blessures graves voire mortelles, lire et comprendre toutes les instructions.

1. **NE JAMAIS** permettre aux enfants d'actionner ou de jouer avec les commandes de la porte.
2. Tenir les télécommandes hors de la portée des enfants.
3. **TOUJOURS** garder en vue la porte en mouvement et tenir à l'écart toute personne ou objet jusqu'à ce que la porte soit totalement fermée. **PERSONNE NE DOIT TRAVERSER LA TRAJECTOIRE D'UNE PORTE EN MOUVEMENT.**
4. **NE JAMAIS** PASSER SOUS UNE PORTE À L'ARRÊT PARTIELLEMENT OUVERTE.
5. Tester l'ouvre-porte une fois par mois. La porte de garage **DOIT** inverser sa course au contact d'un objet de 4 cm (planche de 5 sur 10 cm) posé à plat sur le sol au centre de l'ouverture de la porte. Après avoir réglé la force ou la limite de la course, retenter l'ouvre-porte de garage. Un mauvais réglage de l'ouvre-porte peut entraîner des blessures graves voire mortelles.
6. Utiliser, dans la mesure du possible le déclenchement d'urgence uniquement lorsque la porte est fermée. Utiliser le déclenchement d'urgence avec prudence lorsque la porte est ouverte. Des ressorts faibles ou brisés peuvent faire descendre la porte rapidement ce qui peut entraîner des blessures graves voire mortelles.
7. **VEILLER À CE QUE LA PORTE SOIT CORRECTEMENT ÉQUILIBRÉE.** Consulter le manuel du propriétaire de la porte de garage. Une porte déséquilibrée pourrait entraîner de graves blessures voire mortelles. Demander à un technicien spécialisé en système de portes de se charger des réparations des câbles, des ressorts et de toute autre quincaillerie.

CONSERVER CES INSTRUCTIONS

⚠ WARNING

Use of any other wall control can cause unexpected operation of the door and loss of lighting feature. Locate wall console within sight of the door but far enough from door to prevent contacting it while operating the console. Control must be at least 5 feet above the floor to prevent small children from operating it.

⚠ AVERTISSEMENT

L'utilisation d'une autre commande murale pourrait produire des résultats inattendus de la porte ainsi que le dysfonctionnement de l'éclairage. Localisez la console murale en vue de la porte et suffisamment loin de la porte pour éviter tout contact pendant l'utilisation de la console. La commande doit être à une hauteur minimale de 1,5 m au-dessus du sol afin que les jeunes enfants ne puissent pas l'atteindre.

Regular inspection/maintenance for the door and opener should be performed at regular intervals to ensure the system runs at peak safety, performance and efficiency.

MAINTENANCE ITEM	INTERVALS	DETAILS
Contact Reverse Test	Monthly	See Page 8 to run system test.
Lubricate Door Hardware	Monthly	Lubricate Rollers & Hinges with a light weight general purpose grease.
Safe-T-Beam® system check	Monthly	Check wiring for loose connections, cracks or worn insulation. Clean lenses of dirt & debris.
Door Balance	Monthly	See Maintenance Detail A
Battery Backup System	Monthly	Unplug opener from outlet. Test opener with remote or wall console. Replace battery if needed. See page 20.
Chain/Belt Adjustments	Yearly	Inspect chain/belt for excessive slack, adjust as necessary.
Remote Battery replacement	As Needed	See Maintenance Detail B
Light Bulb Replacement	As Needed	See Maintenance Detail C

A - Door Inspection

Perform the Door inspection as follows:

With the door closed, pull manual emergency release handle DOWN and away from door and let go to disengage the carriage from the drive chain or belt FIG.1.

- Raise and lower the door manually. Door should move freely and smoothly.
- Raise door manually about 3' to 4' feet from floor and let go.. Door should remain stationary or slowly drift closed. FIG. 2.

If door opens or closes rapidly, CONTACT A TRAINED DOOR SYSTEM TECHNICIAN to have your door springs serviced.

- Close the door.
- Place the carriage in the “engage” position Reverse of FIG. 1.
- Operate door using remote or wall control. The carriage will reattach itself to the drive chain/belt.

⚠ WARNING

- Garage door hardware (springs, cables, brackets, pulleys, etc.) are under extreme pressure and tension.
- **DO NOT** attempt to repair or adjust door springs or any hardware, and **DO NOT OPERATE** garage door automatically or manually if door is improperly balanced or springs are broken.
- **CONTACT A TRAINED DOOR SYSTEM TECHNICIAN.**

⚠ AVERTISSEMENT

- La quincaillerie de la porte de garage (ressorts, câbles, supports, poulies, etc.) sont sous des pressions et des tensions extrêmes.
- **NE PAS** réparer ni régler les ressorts de la porte ou toute autre pièce de quincaillerie et **NE PAS ACTIONNER** la porte manuellement ou automatiquement si elle n'est pas correctement équilibrée ou si des ressorts sont cassés.
- **CONTACTEZ UN TECHNICIEN SPÉCIALISÉ EN SYSTÈME DE PORTES**

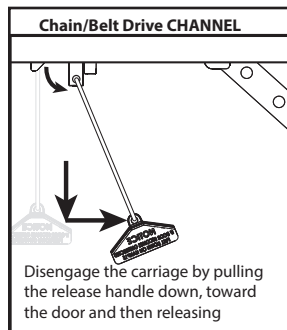
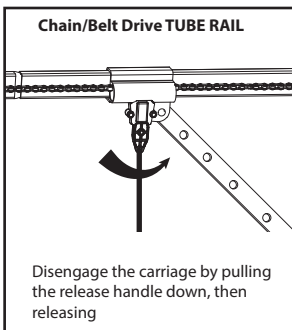

DO NOT use release cord to pull door.

FIG.1

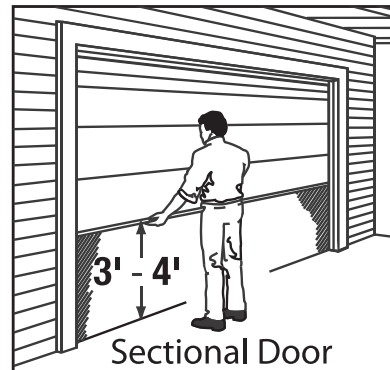

FIG 2

B- Changing Remote Batteries

Remote Battery Replacement (1-button)

Replace remote battery with a CR2032 coin cell battery.

1. Slide the battery cover off.
2. Slide out the old battery and slide in the new. Be sure positive side (+) is UP.
3. Slide the battery cover on until it snaps into place.



Remote Battery Replacement (3-button)

Replace remote battery with a CR2032 coin cell battery.

1. Open remote case using a washer or coin that fits into the slot on the top of the remote.
2. Replace battery. Be sure positive side (+) is UP.
3. Align components and snap case closed.

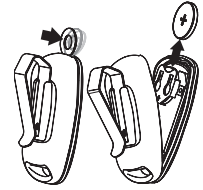

C - Changing Lightbulbs

⚠ WARNING

- Use extreme caution when working from a ladder or step stool or serious injury can occur.
- When replacing light cover, make sure wires are not pinched or near moving parts.
- Use only properly rated incandescent, LED or CFL light bulbs.
- DO NOT use bulbs with a rating greater than 60 Watts.
- Use A19 size light bulbs. DO NOT use bulbs having a short neck.

⚠ AVERTISSEMENT

- Faire particulièrement attention lors de travaux effectués depuis une échelle ou en escabeau.
- En refermant le couvercle de l'éclairage, s'assurer que les fils ne sont ni coincés ni près des pièces mobiles.
- Utilisez uniquement incandescence correctement classé, LED ou des ampoules fluocompactes.
- NE PAS utiliser des ampoules avec une note supérieure à 60 Watts
- Utilisez A19 ampoules de taille. NE PAS utiliser des ampoules ayant un cou court.

1. Disconnect power to opener.
2. Open powerhead lens covers by pressing down on upper locking tabs and pull away from powerhead.
3. Replace old light bulbs with 60 Watt MAXIMUM incandescent, CFL or LED equivalent**.

* Genie LED light bulbs, which are specifically made for garage door openers, are recommended.

4. Install lens cover(s).
5. Reconnect power to door opener.
6. Test light operation.

NOTE: Use of standard LED bulbs may reduce the range of your remote controls*.

1 Light Models

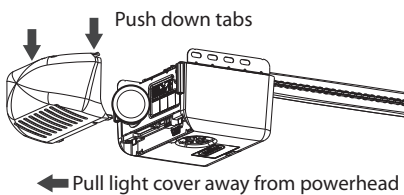

2 Light Models

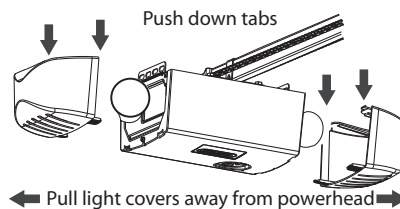

Models equipped with integrated LED lighting require specialty kits available for order in the replacement parts section.

****Integrated Aladdin Connect®** models require a **MINIMUM 40 Watt** or equivalent bulb, 60 watt maximum.



* Genie LED light bulbs are designed to reduce or eliminate reduced remote range issues caused by common LED bulbs. They also offer better product life by making them resistant to vibration caused by the opener, and cold or damp weather. See website for details at www.geniecompany.com.

6

TROUBLESHOOTING

Use the guide below along with the self diagnostic powerhead LEDs to help troubleshoot any problems.



Need help or have questions? **DO NOT RETURN** to the store.

Visit www.geniecompany.com or call Customer Service at 1-800-35-GENIE.

Opener does NOT operate when wall control is pressed.	<ul style="list-style-type: none"> • Turn Sure-Lock™ OFF See page 4. • Check power source. <ul style="list-style-type: none"> – Plug a lamp into outlet used for powerhead. If lamp works, power source is OK. – If not, check fuse or circuit breaker. • If power is OK, <ul style="list-style-type: none"> – Check connections at powerhead terminals and at wall console. • Check for reversed, broken or cut wires. Staples can cut insulation and short wires. Repair or replace.
Opener runs, but door does not move.	<ul style="list-style-type: none"> • Make sure carriage is engaged with chain/belt turnbuckle. Refer to installation poster or download poster from www.geniecompany.com • Check to make sure chain/belt is not broken or off its pulley.
Opener works from wall control, but NOT from remote.	<ul style="list-style-type: none"> • Check all remotes. • Replace remote battery. See page 20. • Program remotes to powerhead. See page 9.
Remote has less than 25 feet operating range or no operation.	<ul style="list-style-type: none"> • Relocate remote inside car and /or point remote at garage door. • Replace battery. See page 20. • Reposition door opener antenna. • Eliminate possible competing signals (radio, etc.). • LED bulbs may be interfering with remote signal. See page 21.
Door starts down, then STOPS and goes back up. OR Safe-T-Beam® System malfunction.	<ul style="list-style-type: none"> • If a NEW installation, check Door Arm position. Refer to Installation poster or download poster from www.geniecompany.com. • If NEW Installation, make sure ONLY the Safe-T-Beams® that came with this opener are installed. • Check if limits are properly set. See pages 6-7. Adjust limits as needed. • Check if Safe-T-Beam® red LED is flashing. See page 16, Safe-T-Beam® system check. • Check Safe-T-Beam® system for beam obstruction or misalignment of lenses. See page 16, Safe-T-Beam® system. • Check garage door for binding. See page 19. • If an operational problem exists, and opener will not close, the opener can be forced to close as follows: Press _____ and hold the wall control button until door is completely closed. • Check for interference from adjacent Safe-T-Beam® units. See page 16. • Contact Genie at 1-800-35-GENIE.
Door starts down, then STOPS before it is closed. OR Door will only open.	<ul style="list-style-type: none"> • Check Safe-T-Beam® wire connection at powerhead and at STBs. See page 16, Safe-T-Beam® system check. • Check if limits are properly set. See pages 6-7. Adjust limits as needed. • Check CONTACT REVERSE. See page 8. • Check garage door for binding. See maintenance and adjustment. Page 19. • Check closing "FORCE" control. See page 8, or Force settings. Page 14.
Door starts up, but STOPS before it is completely open.	<ul style="list-style-type: none"> • Check if limits are properly set. See pages 6-7. Adjust limits as needed. • Be sure door, opener, springs are in good repair, properly lubricated and balanced. • Check closing/opening "FORCE" control. See page 8, or Force settings Page 14. • If you suspect a problem with the garage door hardware or springs, visit www.geniecompany.com and use the "dealer locator" to hire a local door service professional. NEVER try to repair door hardware or springs yourself.
Door will only run closed.	<ul style="list-style-type: none"> • Turn Sure-Lock™ OFF See page 4. • Check if limits are properly set. See pages 6-7. • Check door balance, condition, and door spring. See page 19. • Check opening "FORCE" control. See page 8, or Force settings. Page 14. • If you suspect a problem with the garage door hardware or springs, visit www.geniecompany.com and use the "dealer locator" to hire a local door service professional. NEVER try to repair door hardware or springs yourself.
Door opener starts for no reason.	<ul style="list-style-type: none"> • Button stuck on wall control or remote. • Was remote lost or stolen? Erase all remotes from powerhead memory and program new remotes. See page 15.
Noisy operation.	<ul style="list-style-type: none"> • Be sure all door fasteners are tight. • Be sure garage door is in good repair, properly lubricated and balanced. • Be sure opener is in good repair.
Door opener runs slow.	<ul style="list-style-type: none"> • Check operating condition of door. Door may need professional repair/adjustment. • Is this opener installed on a one-piece door? This opener is not designed to operate a one-piece door.

POWERHEAD LEDS

Powerhead LED		Possible Problem	Solution
Round LED	Long LED		
OFF	OFF	Normal operation.	None required.
		No response from unit.	Check power supply. Contact a trained door system professional.
ON/RED/ STEADY	ON/RED/ STEADY	Limits NOT set properly.	Re-program limits, see pages 6-7.
ON/RED/ FLASHING	ON/RED/ FLASHING	Program error.	Unplug unit, wait 5 seconds, plug in.
		Component failure.	Contact a trained door system technician.
ON/BLUE/ FLASHING	OFF	Remote NOT programmed.	Program remote, see page 9.
ON/PURPLE/ FLASHING	OFF	Remote NOT programmed.	Program remote, see page 9.
ON/RED/ FLASHING	OFF	Safe-T-Beam® physical obstruction.	Remote obstruction, recheck unit.
		Safe-T-Beam® signal interference.	Check alignment of Safe-T-Beam® pair and nearest other Safe-T-Beam® pair, see page 16.
OFF	ON/RED/ FLASHING	Door contact in UP or DOWN travel.	Remove obstruction.
		Door component failure detected.	Check door spring, track, rollers, hinges and fixtures.
OFF	ON/RED/ STEADY	Thermal cutout.	DO NOT unplug unit. Wait until LED clears before operating.
ON/PURPLE/ STEADY	ON/PURPLE/ STEADY	Component error.	Contact a trained door system technician.
OFF	ON/BLUE/ FLASHING	Door will not open.	Check Sure-Lock™. Sure-Lock™ should be OFF for normal operation (see page 4).
ON/PURPLE/ FLASHING	ON/PURPLE/ FLASHING	Radio receiver error.	Unplug the unit. Wait 5 seconds and plug the unit back in. If problems persist, contact a trained door system technician.

Battery Backup Troubleshooting LEDS

ON/GREEN STEADY	ON/GREEN STEADY	OK=Charged, Battery Backup	None Required
ON/GREEN FLASHING	ON/GREEN FLASHING	Discharging, Battery Backup	Power is out. Battery in use.
ON/YELLOW FLASHING	ON/YELLOW FLASHING	Charging, Battery Backup	None Required
ON/RED TO YELLOW FLASHING	ON/RED TO YELLOW FLASHING	Dead Battery, Battery Backup	Allow to charge 48 hours. If charging fails, Replace Battery.
ON/WHITE STEADY	ON/WHITE STEADY	Battery Backup in Operation	No Fault. Courtesy light while in battery backup mode. Light will turn off after 4 minutes.

LED DISPLAY UNDER NORMAL OPERATING CONDITIONS

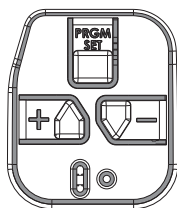

Standard Models
NO LED DISPLAY

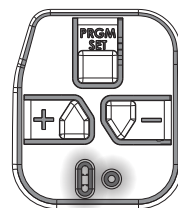

Battery Back-up Models
BOTH LEDS = STEADY GREEN

Please have your specific opener model number (on opener powerhead) or serial number (front of this manual) when ordering parts.

TUBE RAIL PARTS ONLY

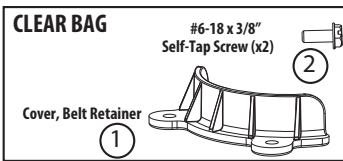
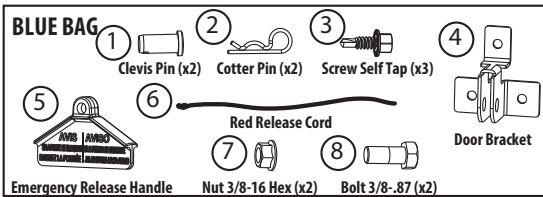
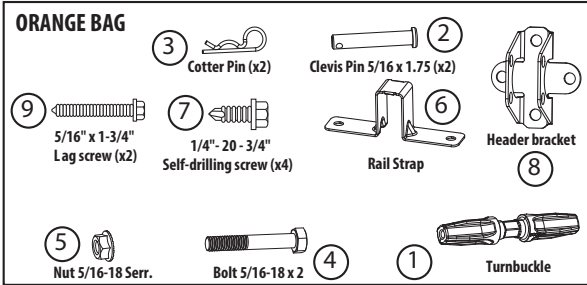

A 39010R.S PARTS PK, MOUNTING, ORANGE

Item #	Part Number	Description	Qty.
1	TURNBUCKLE	1	
2	PIN, CLEVIS, 5/16 X 1-3/4	2
3	COTTER, HAIRPIN, .0725 DI	2
4	BOLT, HH, PLD, 5/16-18 X 2	1
5	NUT, 5/16-18 HX SERR FLG	1
6	STRAP, RAIL, RECT	1
7	SCR, SERR HWH, AB, 1/4-14	4
8	BRKT, HEADER, RECT RAIL	1
9	SCR, LAG, HWH, TPG, 5/16"X1	2

B 39011R.S PARTS PK, MOUNTING, BLUE

Item #	Part Number	Description	Qty.
1	PIN, CLEVIS	2
2	PIN, COTTER	2
3	SCREW, SELF TAPPING 1/4 -14 X 5/8	3
4	BRACKET, HEADER	1
5	EMERGENCY RELEASE HANDLE	1
6	EMERGENCY RELEASE CORD	2
7	NUT, FLANGE 3/8-16	2
8	BOLT, 3/6-16 X .87	2

D 39012R.S PARTS PACK, CLEAR, BELT

Item #	Part Number	Description	Qty.
1	COVER, BELT RETAINER	1
2	SCR, SF TP #6-18 X 3/8	2

ALL RETAIL OPENERS

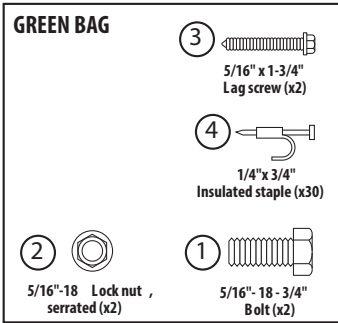

C 37105S.S PARTS PK, INSTALL, GREEN

Item #	Part Number	Description	Qty.
1	BOLT, HH, PLD, 5/16-18 X 3	2
2	NUT, 5/16-18 HX SERR FLG	2
3	SCR, LAG, HWH, TPG, 5/16"X1	2
4	PARTS PK, INSULATED STAP	30

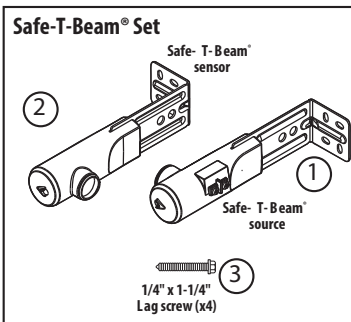

E 37220R Safe-T-Beam Set

Item #	Part Number	Description	Qty.
1	XMTR ASSY, STB 1	1
2	RCVR ASSY, STB 1	1
3	SCR, #10-16 X 1.25	4

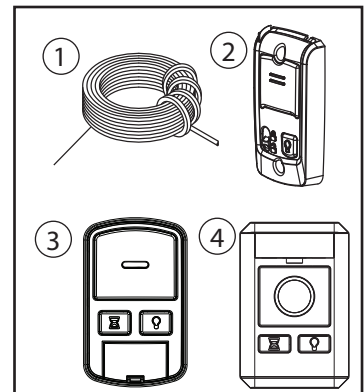

ACCESSORIES

Item #	Part Number	Description
1	35265B.S	90ft. LOW VOLTAGE WIRE SPOOL
2	39902R	WIRED WALL CONSOLE
3	39165R	WIRELESS WALL CONSOLE (RETAIL)
4	39902R	WIRELESS WALL CONSOLE (PRO)

REPLACEMENT POWERHEAD PARTS

Item #	Description	QTY.
1	COVER, MAIN	1
2	LENS	2
3	SECONDARY COVER	2
4	MOTOR ASSEMBLY	1
5	LED LIGHT ASSEMBLY	2
6	TRANSFORMER, 120VAC	1
7	PCB, DC CONTROLLER	1
8	POWER CORD, 45"	1
9	ICDM BOARD (Integrated Wi-Fi Models Only)	1
10	BATTERY BACKUP COVER ASSY.	2
11	BATTERY BACKUP BATTERY	1

DUAL BULB MODELS Two-Piece Lens

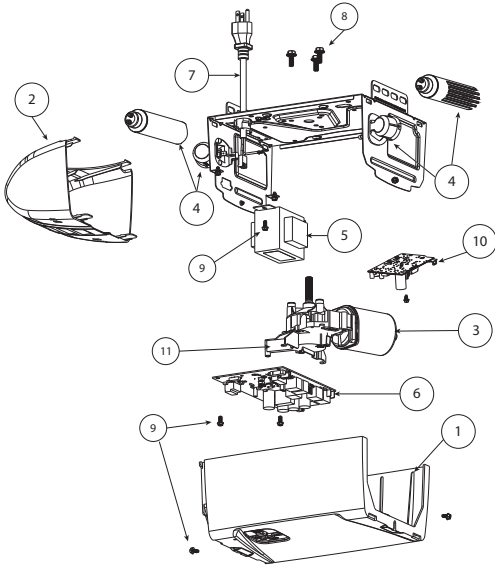
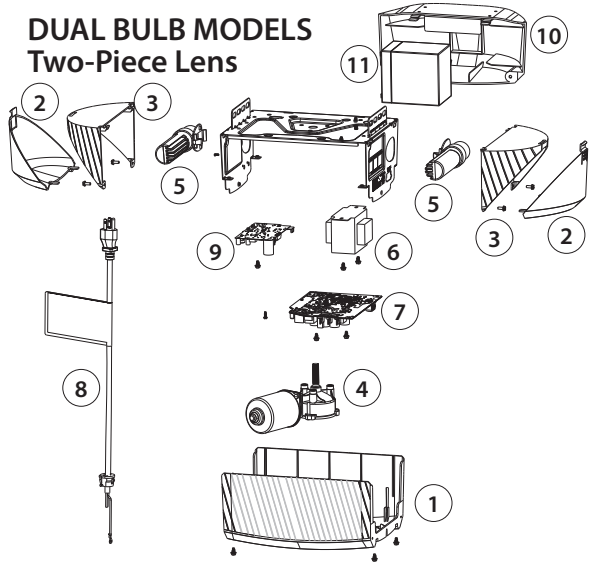

DUAL BULB MODELS One-Piece Lens

Item	Description	QTY.
1	COVER	1
2	LENS	2
3	MOTOR & OPTO ASSEMBLY	1
4	SOCKET, ANGLED LIGHT/LED LIGHT ASSEMBLY	2
5	TRANSFORMER, 120VAC	1
6	PCB, DC CONTROLLER	1
7	POWER CORD, 72"	1
8	SCR, M6-1 X 12 HWH THDF (3pk)	1
9	SCR, HHD, SLTD, TAP, #8X5/1 (3pk)	2
10	iDCM CONTROL BOARD	1
11	OPTO ASSEMBLY	1
A	BATTERY ONLY	1
B	BATTERY BACKUP COVER W/SCREWS	1

Please have your specific opener model number (on opener powerhead) or serial number (front of this manual) when ordering parts.

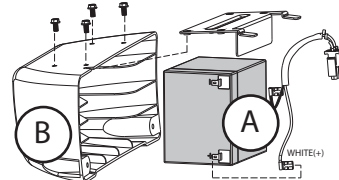

SINGLE BULB POWERHEAD & TUBE RAIL & ACCESSORY PARTS

SINGLE BULB MODELS

Item	Description	QTY.
1	COVER	1
2	LENS	2
3	MOTOR & OPTO ASSEMBLY	1
4	SOCKET, ANGLED LIGHT/LED LIGHT ASSEMBLY	2
5	TRANSFORMER, 120VAC	1
6	PCB, DC CONTROLLER	1
7	POWER CORD, 72"	1
8	SCR, M6-1 X 12 HWH THDF (3pk)	1
9	SCR, HHD, SLTD, TAP, #8X5/1 (3pk)	2
10	iDCM CONTROL BOARD	1
11	OPTO ASSEMBLY	1
A	BATTERY ONLY	1
B	BATTERY BACKUP COVER W/SCREWS	1

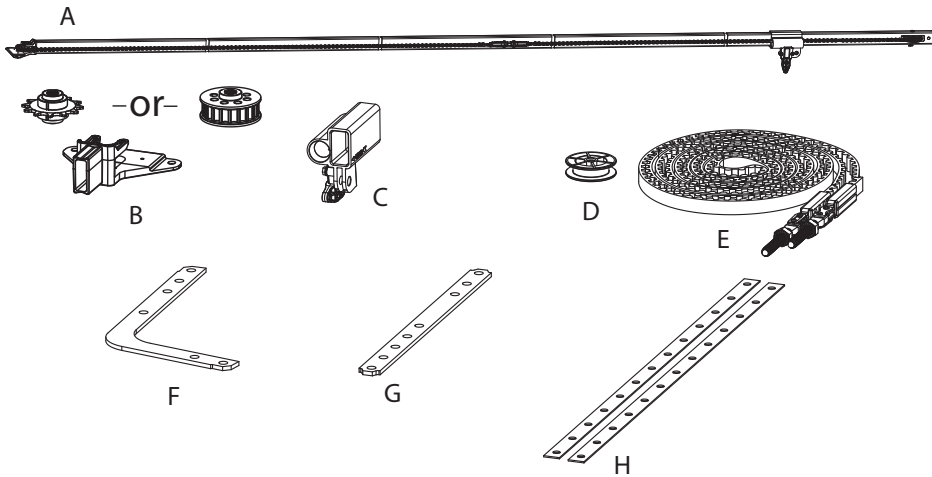
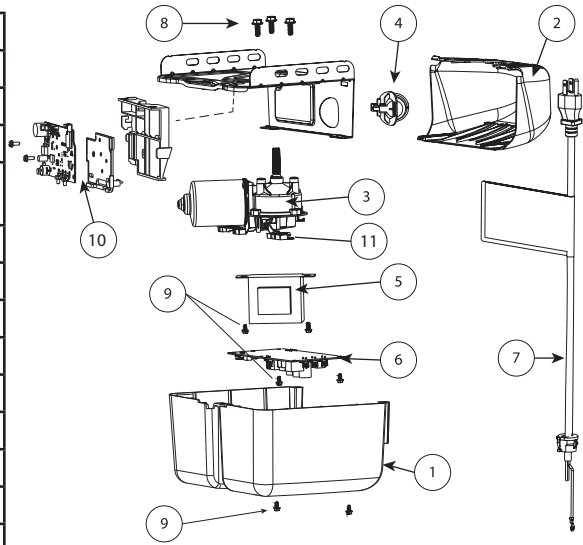

Please have your specific opener model number (on opener powerhead) or serial number (front of this manual) when ordering parts.

Item #	Part Number	Description	Qty.
A	39410R.S	5-pcs. Rail Assembly Complete (Chain)	1
	39411R.S	5-pcs. Rail Assembly Complete (Belt)	1
B	39277R.S	Sprocket Support Assembly (Chain).....	1
	39278R.S	Sprocket Support Assembly (Belt).....	1
C	38893R.S	Carriage Assembly.....	1
D	39276R.S	Idler Pulley.....	1
E	39352R.S	Chain Assembly (7Ft).....	1
	39354R.S	Belt Assembly(7Ft)	1
F	37476A.S	Door Arm,Curved.....	1
G	37475A.S	Door Arm,Straight	1
H	21243B.S	Strap,Hanging,3/4 X 25.....	2
N/S	39027R	Rail Extension Kit, TUBE RAIL (Chain)	
N/S	39026R	Rail Extension Kit, TUBE RAIL (Belt)	

CHANNEL PARTS

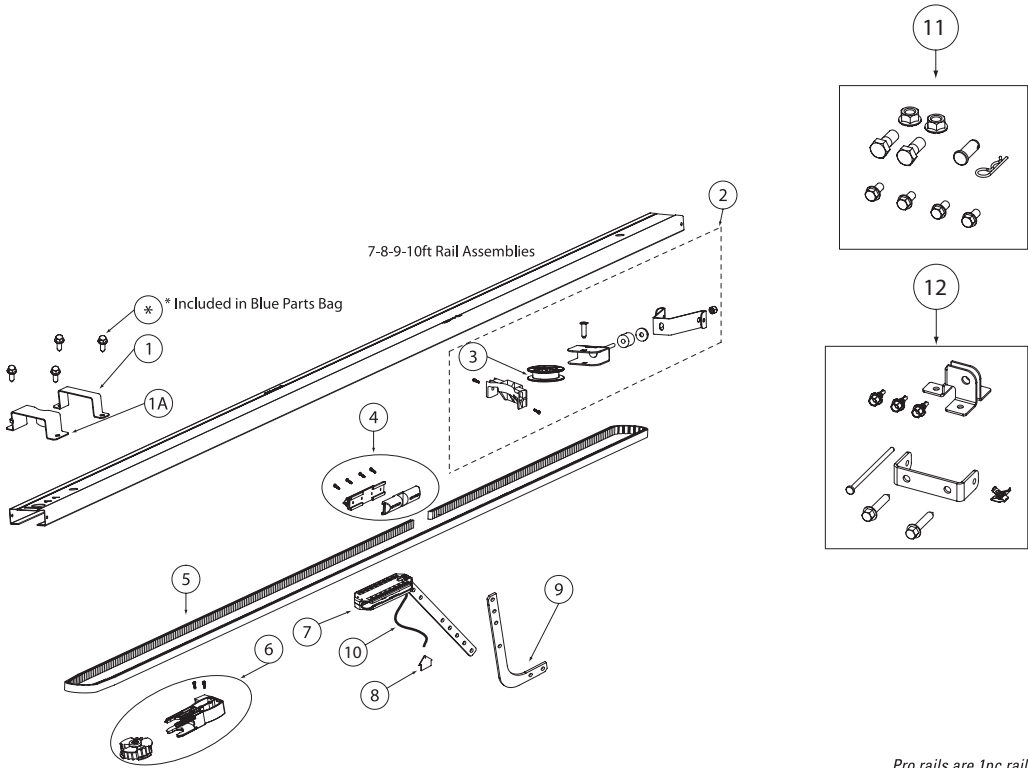

Pro rails are 1pc rails.
*Belt version shown here

Item	Part Number	Description	QTY.
1	36728A.S	Head To Rail Bracket (Need 2 for Chain, 1 for Belt)	1
1A	36987A.S	Head To Rail Bracket Belt Guard (for Belt only)	1
2	37857R.S	Tensioner Assembly	1
3	36764A.S	Pulley Tensioner	1
4	37557R.S	Chain Bullet Assembly	1
	37556R.S	Belt Bullet Assembly	1
5	37562R.S	Chain & Bullet Assembly, 7 ft	1
	37562S.S	Chain & Bullet Assembly, 8 ft	1
	37562T.S	Chain & Bullet Assembly, 10 ft (292")	1
	39381R.S	Chain & Bullet Assembly, 10 ft (303")	1
	37561R.S	Belt & Bullet Assembly, 7 ft	1
	37561S.S	Belt & Bullet Assembly, 8 ft	1
	37561W.S	Belt & Bullet Assembly, 9 ft (268")	1
	39380U.S	Belt & Bullet Assembly, 9 ft (279")	1
	37561T.S	Belt & Bullet Assembly, 10 ft (292")	1
	39380R.S	Belt & Bullet Assembly, 10 ft (303")	1
6	37559R.S	Chain Drive Sprocket Assembly	1
	37558R.S	Belt Drive Sprocket Assembly	1
7	36773R.S	Carriage Assembly, 7 ft Doors	1
	36773S.S	Carriage Assembly, 8 ft Doors	1
	36773T.S	Carriage Assembly, 9, 10 ft Doors	1
8	37107C.S	Carriage Release Handle	1

Item	Part Number	Description	QTY.
9	26013D.S	Curved Door Arm	1
10	37461R.S	Release Cord Assembly, 7' (32")	1
	37461S.S	Release Cord Assembly, 8' (44")	1
	37461T.S	Release Cord Assembly, 9-14' (116")	1
11	37049R.S	Installation Parts Pack (Blue Bag)	1
12	37047R.S	Mounting Parts Pack (Orange Bag)	1
NS	37714S.S	Wire Clips, (50 pcs)	1
NS	38245R.S	3PC Service Rail, C-Channel Chain Drive Rail	1
NS	38246R.S	3PC Service Rail, C-Channel Belt Drive Rail	1



Look for this Safety Alert Symbol below. This symbol indicates a potential personal safety hazard that can result in injury or death.

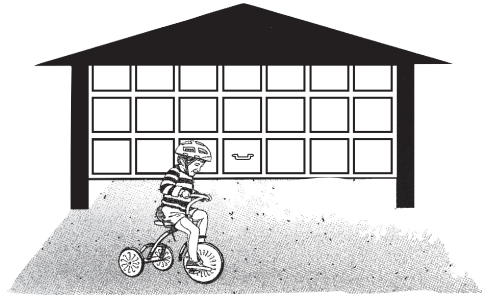

A GARAGE DOOR IS THE LARGEST MOVING OBJECT IN THE HOME.

These doors are often operated by electric door openers. Proper installation, operation, maintenance, and testing of the garage door and automatic opener are necessary to provide safe, trouble-free operation.

An improperly adjusted garage door or automatic opener can exert deadly force when the door closes. This could lead to serious injury or death from being hit by a closing garage door or from being trapped under the door.



A few simple precautions can protect our family and friends from potential harm. Please take a few minutes to read the following safety and maintenance tips. Refer to your garage door and opener owner's manual for details specific to your garage door and automatic opener.



Do not stand or walk under a moving door! Do not let children or adults play "beat the door."

It is dangerous and can result in serious injury or death. Adults should set a good example.

Know how to use the emergency release, in case someone is pinned by the door.



Do not let children play with or use the transmitters or remote controls. Always place or store them out of the reach of children.



DASMA SAFETY GUIDELINES



The push button wall control should be out of reach of children.

(at least 5 feet from the floor) and away from all moving parts. Mount and use the button where you can clearly see the moving garage door.



GARAGE DOOR OPENERS ARE NOT TOYS.

Careless operation and allowing children to play with or use garage door opener controls can lead to tragic results. Discuss garage door safety with your children. Explain the danger of being trapped under the door.

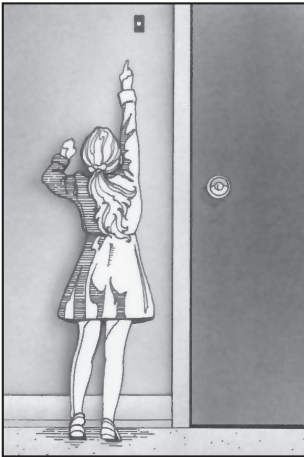

WHEN USING THE PUSH BUTTON OR TRANSMITTER, KEEP THE DOOR IN SIGHT UNTIL IT COMPLETELY STOPS MOVING.

Teach children never to play under or near an open garage door.

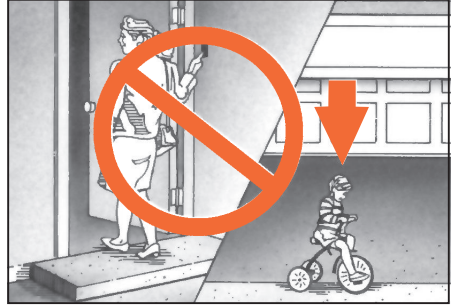

Teach children to keep their hands and fingers clear of section joints, hinges, track, springs, and other door parts.

Contact with a moving door or its hardware could cause injury. These injuries can also happen with garage doors that don't have automatic openers.



**National
Safety
Council**

This important information is provided by the U.S. Consumer Product Safety Commission, the National Safety Council, and the Industry Coalition for Automatic Garage Door Opener Safety.



THE GENIE COMPANY
1 DOOR DRIVE
MOUNT HOPE, OHIO 44660
1-800-35-GENIE (354-3643)
www.geniecompany.com