

GA-X79-UD3

User's Manual

Rev. 1001

12ME-X79UD3-1001R

Declaration of Conformity

Wb, Manufacturer/Importer
G.B.T. Technology Trading GmbH
Bültenkoppl 16, 22047 Hamburg, Germany

(description of the apparatus, system, preparation to which it refers)

01071003
GEMX13-UD3

(reference to the EMC Directive)

(reference to the specification under which conformity is claimed)
in accordance with the EMC Directive 2004/108/E

EN 55011
Limits and methods of measurement
of radio disturbance characteristics of
radio transmitting apparatus and
high frequency equipment

EN 61000-3-2
 EN 61000-3-3

Disturbances in supply systems caused
by household appliances and similar
electrical equipment "Voltage fluctuations"

EN 55013
Limits and methods of measurement
of radio disturbance characteristics of
broadcast receivers and associated
equipment

EN 55024

Information Technology
equipment/Immunity
characteristics-Limits and methods of
measurement

EN 55014-1
Limits and methods of measurement
of radio disturbance characteristics of
portable tools and similar electrical
apparatus

EN 50082-1
 EN 50082-2

Generic immunity standard Part 1:
Residual, commercial and light industry
Generic immunity standard Part 2:
Industrial environment

EN 55015
Limits and methods of measurement
of radio disturbance characteristics of
fluorescent lamps and luminaires

EN 55014-2

Immunity requirements for household
appliances tools and similar apparatus

EN 55020
Immunity from radio interference of
broadcast receivers and associated
equipment

EN 50081-2

EMC requirements for uninterruptible
power systems (UPS)

EN 55022

Limits and methods of measurement
of radio disturbance characteristics of
information technology equipment

DIN VDE 0885
 part 10
 part 15

Colored distribution systems; Equipment
for receiving and/or distribution from
cable and television signals

CE marking



(CE conformity marking)

EN 60065

Safety requirements for mains operated
electronic and related apparatus for
household and similar general use

EN 60950

Safety for information technology equipment
including electrical business equipment

EN 60335

Safety of household and similar
electrical appliances

EN 50081-1

General and Safety requirements for
uninterruptible power systems (UPS)

Manufacturer/Importer

Signature: Timmy Huang

(Stamp)

Date: Oct. 28, 2011

Name: Timmy Huang

DECLARATION OF CONFORMITY

Per FCC Part 2 Section 2.1077(a)



Responsible Party Name: G.B.T. INC. (U.S.A.)

Address: 17358 Railroad Street

City of Industry, CA 91748

Phone/Fax No: (626) 854-9338/ (626) 854-9326

hereby declares that the product

Product Name: **Motherboard**

Model Number: GA-GA-X79-UD3

Conforms to the following specifications:

FCC Part 15, Subpart B, Section 15.107(a) and Section 15.109

(a), Class B Digital Device

Supplementary Information:

This device complies with part 15 of the FCC Rules. Operation is
subject to the following two conditions: (1) This device may not
cause harmful and (2) this device must accept any interference received,
including that may cause undesired operation.

Representative Person's Name: ERIC LU

Signature: Eric Lu

Date: Oct. 28, 2011

Copyright

© 2011 GIGA-BYTE TECHNOLOGY CO., LTD. All rights reserved.

The trademarks mentioned in this manual are legally registered to their respective owners.

Disclaimer

Information in this manual is protected by copyright laws and is the property of GIGABYTE. Changes to the specifications and features in this manual may be made by GIGABYTE without prior notice. No part of this manual may be reproduced, copied, translated, transmitted, or published in any form or by any means without GIGABYTE's prior written permission.

Documentation Classifications

In order to assist in the use of this product, GIGABYTE provides the following types of documentations:

- For quick set-up of the product, read the Quick Installation Guide included with the product.
- For detailed product information, carefully read the User's Manual.

For product-related information, check on our website at:

<http://www.gigabyte.com>

Identifying Your Motherboard Revision

The revision number on your motherboard looks like this: "REV: X.X." For example, "REV: 1.0" means the revision of the motherboard is 1.0. Check your motherboard revision before updating motherboard BIOS, drivers, or when looking for technical information.

Example:

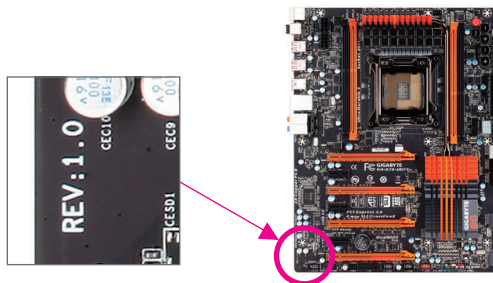

Table of Contents

Box Contents	6
Optional Items	6
GA-X79-UD3 Motherboard Layout.....	7
GA-X79-UD3 Motherboard Block Diagram.....	8
Chapter 1 Hardware Installation	9
1-1 Installation Precautions	9
1-2 Product Specifications	10
1-3 Installing the CPU and CPU Cooler.....	13
1-3-1 Installing the CPU	13
1-3-2 Installing the CPU Cooler	15
1-4 Installing the Memory	16
1-4-1 4 Channel Memory Configuration.....	16
1-4-2 Installing a Memory	17
1-5 Installing an Expansion Card.....	18
1-6 Setting up AMD CrossFire™/NVIDIA SLI Configuration	19
1-7 Back Panel Connectors	20
1-8 Internal Connectors	22
Chapter 2 BIOS Setup	33
2-1 Startup Screen.....	34
2-2 The Main Menu.....	35
2-3 M.I.T.	37
2-4 System	47
2-5 BIOS Features	48
2-6 Peripherals.....	50
2-7 Power Management.....	53
2-8 Save & Exit Setup.....	55

Chapter 3 Drivers Installation	57
3-1 Installing Chipset Drivers.....	57
3-2 Application Software.....	58
3-3 Technical Manuals	58
3-4 Contact.....	59
3-5 System	59
3-6 Download Center	60
3-7 New Program.....	60
Chapter 4 Unique Features.....	61
4-1 Xpress Recovery2.....	61
4-2 BIOS Update Utilities.....	64
4-2-1 Updating the BIOS with the Q-Flash Utility	64
4-2-2 Updating the BIOS with the @BIOS Utility.....	67
4-3 EasyTune 6	68
4-4 Q-Share	69
4-5 eXtreme Hard Drive (X.H.D).....	70
4-6 Cloud OC	71
Chapter 5 Appendix.....	73
5-1 Configuring SATA Hard Drive(s).....	73
5-1-1 Configuring Intel X79 SATA Controllers	73
5-1-2 Configuring Marvell 88SE9172 SATA Controllers.....	79
5-1-3 Installing the SATA RAID/AHCI Driver and Operating System.....	85
5-2 Configuring Audio Input and Output.....	92
5-2-1 Configuring 2/4/5.1/7.1-Channel Audio.....	92
5-2-2 Configuring S/PDIF Out.....	94
5-2-3 Enabling the Dolby Home Theater Function	95
5-2-4 Configuring Microphone Recording.....	96
5-2-5 Using the Sound Recorder	98
5-3 Troubleshooting	99
5-3-1 Frequently Asked Questions	99
5-3-2 Troubleshooting Procedure	100
5-3-3 Regulatory Statements	102

Box Contents

- GA-X79-UD3 motherboard
- Motherboard driver disk
- User's Manual
- Quick Installation Guide
- Four SATA cables
- I/O Shield
- One 2-Way SLI bridge connector
- One 3-Way SLI bridge connector
- One 4-Way SLI bridge connector
- One 2-Way CrossFire bridge connector

The box contents above are for reference only and the actual items shall depend on the product package you obtain.
The box contents are subject to change without notice.

Optional Items

- 2-port USB 2.0 bracket (Part No. 12CR1-1UB030-5*R)
- 2-port SATA power cable (Part No. 12CF1-2SERPW-0*R)
- 3.5" Front Panel with 2 USB 3.0/2.0 ports (Part No. 12CR1-FPX582-0*R)
- COM port cable (Part No. 12CF1-1CM001-3*R)

GA-X79-UD3 Motherboard Layout

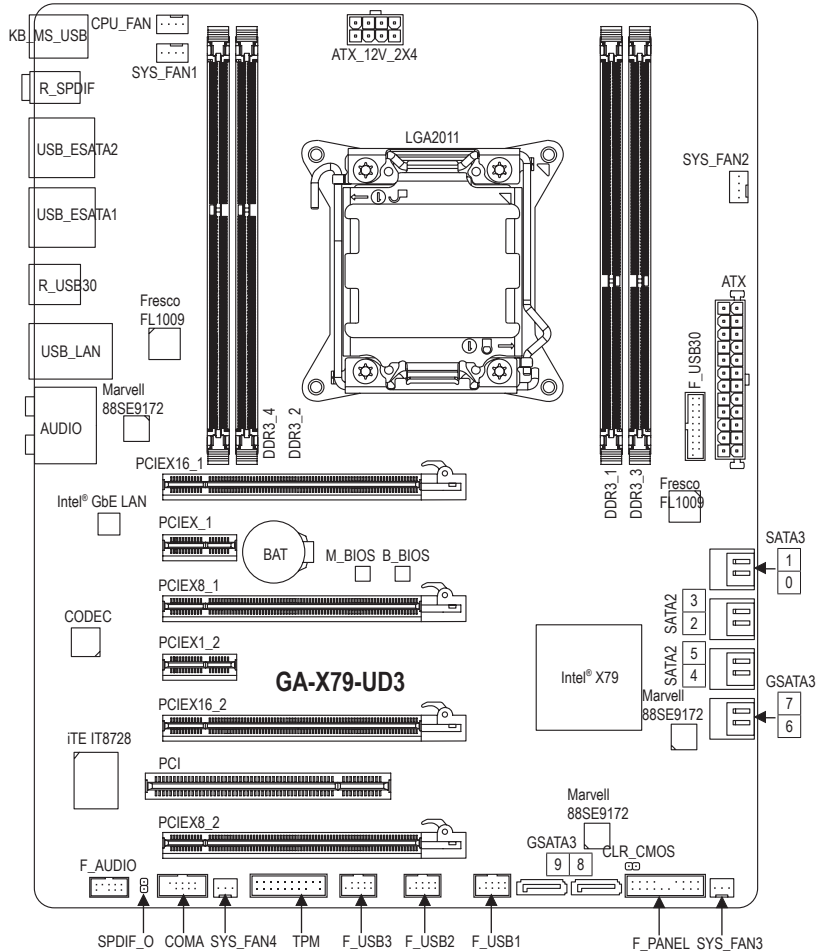

GA-X79-UD3 Motherboard Block Diagram

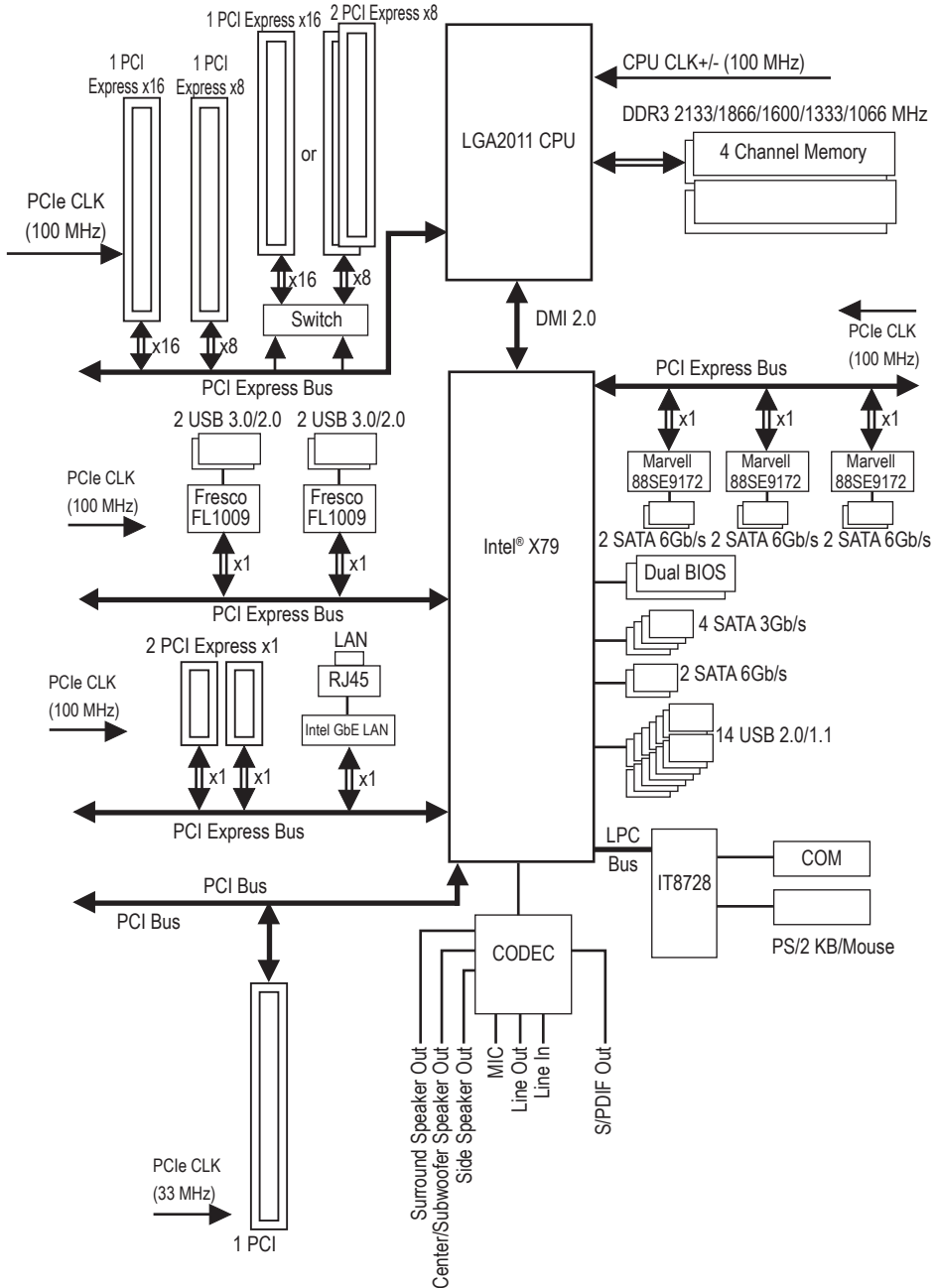









Chapter 1 Hardware Installation





1-1 Installation Precautions







The motherboard contains numerous delicate electronic circuits and components which can become damaged as a result of electrostatic discharge (ESD). Prior to installation, carefully read the user's manual and follow these procedures:

- Prior to installation, make sure the chassis is suitable for the motherboard.
- Prior to installation, do not remove or break motherboard S/N (Serial Number) sticker or warranty sticker provided by your dealer. These stickers are required for warranty validation.
- Always remove the AC power by unplugging the power cord from the power outlet before installing or removing the motherboard or other hardware components.
- When connecting hardware components to the internal connectors on the motherboard, make sure they are connected tightly and securely.
- When handling the motherboard, avoid touching any metal leads or connectors.
- It is best to wear an electrostatic discharge (ESD) wrist strap when handling electronic components such as a motherboard, CPU or memory. If you do not have an ESD wrist strap, keep your hands dry and first touch a metal object to eliminate static electricity.
- Prior to installing the motherboard, please have it on top of an antistatic pad or within an electrostatic shielding container.
- Before unplugging the power supply cable from the motherboard, make sure the power supply has been turned off.
- Before turning on the power, make sure the power supply voltage has been set according to the local voltage standard.
- Before using the product, please verify that all cables and power connectors of your hardware components are connected.
- To prevent damage to the motherboard, do not allow screws to come in contact with the motherboard circuit or its components.
- Make sure there are no leftover screws or metal components placed on the motherboard or within the computer casing.
- Do not place the computer system on an uneven surface.
- Do not place the computer system in a high-temperature environment.
- Turning on the computer power during the installation process can lead to damage to system components as well as physical harm to the user.
- If you are uncertain about any installation steps or have a problem related to the use of the product, please consult a certified computer technician.

1-2 Product Specifications

	CPU	<ul style="list-style-type: none"> ◆ Support for Intel® Core™ i7 processors in the LGA2011 package (Go to GIGABYTE's website for the latest CPU support list.) ◆ L3 cache varies with CPU
	Chipset	<ul style="list-style-type: none"> ◆ Intel® X79 Express Chipset
	Memory	<ul style="list-style-type: none"> ◆ 4 x 1.5V DDR3 DIMM sockets supporting up to 32 GB of system memory <ul style="list-style-type: none"> * Due to Windows 32-bit operating system limitation, when more than 4 GB of physical memory is installed, the actual memory size displayed will be less than 4 GB. ◆ 4 channel memory architecture ◆ Support for DDR3 2133/1866/1600/1333/1066 MHz memory modules ◆ Support for non-ECC memory modules ◆ Support for Extreme Memory Profile (XMP) memory modules (Go to GIGABYTE's website for the latest supported memory speeds and memory modules.)
	Audio	<ul style="list-style-type: none"> ◆ Realtek ALC898 codec ◆ High Definition Audio ◆ 2/4/5.1/7.1-channel ◆ Support for Dolby® Home Theater ◆ Support for S/PDIF Out
	LAN	<ul style="list-style-type: none"> ◆ 1 x Intel GbE LAN phy (10/100/1000 Mbit)
	Expansion Slots	<ul style="list-style-type: none"> ◆ 2 x PCI Express x16 slots, running at x16 (PCIEX16_1, PCIEX16_2) <ul style="list-style-type: none"> * For optimum performance, if only one PCI Express graphics card is to be installed, be sure to install it in the PCIEX16 slot. ◆ 2 x PCI Express x16 slots, running at x8 (PCIEX8_1, PCIEX8_2) <ul style="list-style-type: none"> * The PCIEX8_2 slot shares bandwidth with the PCIEX16_2 slot. When the PCIEX8_2 slot is populated, the PCIEX16_2 slot will operate at up to x8 mode. (All PCI Express x16 slots conform to PCI Express 3.0 standard.) ◆ 2 x PCI Express x1 slots (All PCI Express x1 slots conform to PCI Express 2.0 standard.) ◆ 1 x PCI slot
	Multi-Graphics Technology	<ul style="list-style-type: none"> ◆ Support for 4-Way/3-Way/2-Way AMD CrossFire™/NVIDIA SLI technology <ul style="list-style-type: none"> * The PCIEX16 slots operate at up to x8 mode when 4-Way/3-Way AMD CrossFire™/NVIDIA SLI is enabled.
	Storage Interface	<ul style="list-style-type: none"> ◆ Chipset: <ul style="list-style-type: none"> - 2 x SATA 6Gb/s connectors (SATA3 0/1) supporting up to 2 SATA 6Gb/s devices - 4 x SATA 3Gb/s connectors (SATA2 2/3/4/5) supporting up to 4 SATA 3Gb/s devices - Support for RAID 0, RAID 1, RAID 5, and RAID 10 <ul style="list-style-type: none"> * When a RAID set is built across the SATA 6Gb/s and SATA 3Gb/s channels, the system performance of the RAID set may vary depending on the devices being connected.

	Storage Interface <ul style="list-style-type: none"> ◆ 3 x Marvell 88SE9172 chips: <ul style="list-style-type: none"> - 4 x SATA 6Gb/s connectors (GSATA3 6/7/8/9) supporting up to 4 SATA 6Gb/s devices - Support for RAID 0 and RAID 1 - 2 x eSATA 6Gb/s connectors on the back panel, supporting up to 2 SATA 6Gb/s devices - Support for RAID 0 and RAID 1
	USB <ul style="list-style-type: none"> ◆ Chipset: <ul style="list-style-type: none"> - Up to 14 USB 2.0/1.1 ports (8 ports on the back panel, 6 ports available through the internal USB headers) ◆ 2 x Fresco FL1009 chips: <ul style="list-style-type: none"> - Up to 4 USB 3.0/2.0 ports (2 ports on the back panel, 2 ports available through the internal USB header)
	Internal Connectors <ul style="list-style-type: none"> ◆ 1 x 24-pin ATX main power connector ◆ 1 x 8-pin ATX 12V power connector ◆ 6 x SATA 6Gb/s connectors ◆ 4 x SATA 3Gb/s connectors ◆ 1 x CPU fan header ◆ 4 x system fan headers ◆ 1 x front panel header ◆ 1 x front panel audio header ◆ 1 x S/PDIF Out header ◆ 3 x USB 2.0/1.1 headers ◆ 1 x USB 3.0/2.0 header ◆ 1 x serial port header ◆ 1 x Clear CMOS jumper ◆ 1 x Trusted Platform Module (TPM) header
	Back Panel Connectors <ul style="list-style-type: none"> ◆ 1 x PS/2 keyboard/mouse port ◆ 1 x optical S/PDIF Out connector ◆ 1 x coaxial S/PDIF Out connector ◆ 8 x USB 2.0/1.1 ports ◆ 2 x USB 3.0/2.0 ports ◆ 2 x eSATA 6Gb/s connectors ◆ 1 x RJ-45 port ◆ 6 x audio jacks (Center/Subwoofer Speaker Out/Rear Speaker Out/Side Speaker Out/Line In/Line Out/Microphone)

	I/O Controller	<ul style="list-style-type: none"> ◆ iTE IT8728 chip
	Hardware Monitor	<ul style="list-style-type: none"> ◆ System voltage detection ◆ CPU/System temperature detection ◆ CPU/System fan speed detection ◆ CPU overheating warning ◆ CPU/System fan fail warning ◆ CPU/System fan speed control <ul style="list-style-type: none"> * Whether the CPU/system fan speed control function is supported will depend on the CPU/system cooler you install.
	BIOS	<ul style="list-style-type: none"> ◆ 2 x 64 Mbit flash ◆ Use of licensed AMI EFI BIOS ◆ Support for DualBIOS™ ◆ PnP 1.0a, DMI 2.7, WfM 2.0, SM BIOS 2.7, ACPI 5.0
	Unique Features	<ul style="list-style-type: none"> ◆ Support for @BIOS ◆ Support for Q-Flash ◆ Support for Xpress BIOS Rescue ◆ Support for Download Center ◆ Support for Xpress Install ◆ Support for Xpress Recovery2 ◆ Support for EasyTune <ul style="list-style-type: none"> * Available functions in EasyTune may differ by motherboard model. ◆ Support for eXtreme Hard Drive (X.H.D) ◆ Support for ON/OFF Charge ◆ Support for Cloud OC ◆ Support for 3TB+ Unlock ◆ Support for Q-Share
	Bundled Software	<ul style="list-style-type: none"> ◆ Norton Internet Security (OEM version)
	Operating System	<ul style="list-style-type: none"> ◆ Support for Microsoft® Windows 7/Vista/XP
	Form Factor	<ul style="list-style-type: none"> ◆ ATX Form Factor; 30.5cm x 24.4cm

* GIGABYTE reserves the right to make any changes to the product specifications and product-related information without prior notice.

1-3 Installing the CPU and CPU Cooler



Read the following guidelines before you begin to install the CPU:

- Make sure that the motherboard supports the CPU.
(Go to GIGABYTE's website for the latest CPU support list.)
- Always turn off the computer and unplug the power cord from the power outlet before installing the CPU to prevent hardware damage.
- Locate the pin one of the CPU. The CPU cannot be inserted if oriented incorrectly. (Or you may locate the notches on both sides of the CPU and alignment keys on the CPU socket.)
- Apply an even and thin layer of thermal grease on the surface of the CPU.
- Do not turn on the computer if the CPU cooler is not installed, otherwise overheating and damage of the CPU may occur.
- Set the CPU host frequency in accordance with the CPU specifications. It is not recommended that the system bus frequency be set beyond hardware specifications since it does not meet the standard requirements for the peripherals. If you wish to set the frequency beyond the standard specifications, please do so according to your hardware specifications including the CPU, graphics card, memory, hard drive, etc.

1-3-1 Installing the CPU

- A. Locate the alignment keys on the motherboard CPU socket and the notches on the CPU.

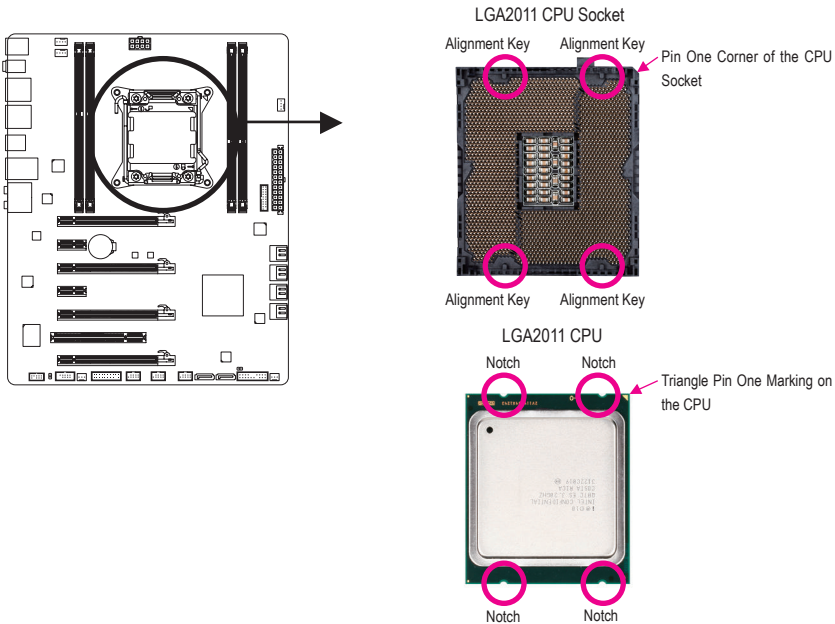

B. Follow the steps below to correctly install the CPU into the motherboard CPU socket.



- Before installing the CPU, make sure to turn off the computer and unplug the power cord from the power outlet to prevent damage to the CPU.
- To protect the socket contacts, do not remove the protective plastic cover unless the CPU is inserted into the CPU socket. Save the cover properly and replace it if the CPU is removed.

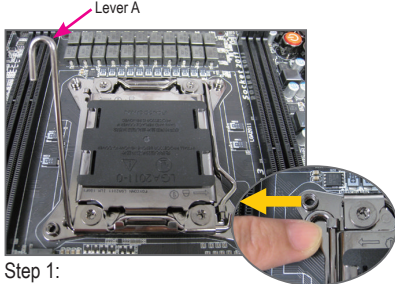

Step 1:
Push the lever closest to the "unlock" marking "☐" (below referred as lever A) down and away from the socket to release it.

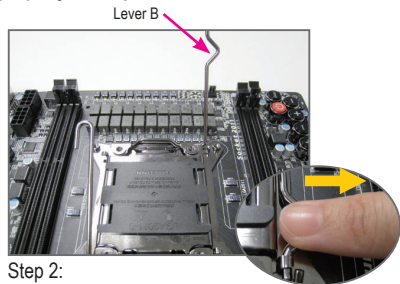

Step 2:
Push the lever closest to the "lock" marking "☐" (below referred as lever B) down and away from the socket. Then lift the lever.



Step 3:
Gently press lever A to allow the load plate to rise. Open the load plate. (Note: DO NOT touch the socket contacts after the load plate is opened.)



Step 4:
Hold the CPU with your thumb and index fingers. Align the CPU pin one marking (triangle) with the pin one corner of the CPU socket (or align the CPU notches with the socket alignment keys) and carefully insert the CPU into the socket vertically.



Step 5:
Once the CPU is properly inserted, carefully replace the load plate. Then secure lever B under its retention tab. The protective plastic cover may pop off from the load plate during the process of engaging the lever. Remove the cover. Save the cover properly and always replace it when the CPU is not installed.



Step 6:
Finally, secure lever A under its retention tab to complete the installation of the CPU.

1-3-2 Installing the CPU Cooler

Refer to the steps below to correctly install the CPU cooler on the motherboard. (Actual installation process may differ depending the CPU cooler to be used. Refer to the user's manual for your CPU cooler.)



Step 1:
Apply an even and thin layer of thermal grease on the surface of the installed CPU.

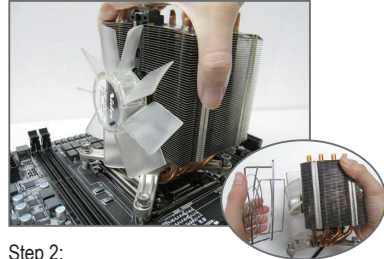

Step 2:
Place the cooler atop the CPU, aligning the four mounting screws with the mounting holes on the ILM. (If your cooler has a fan grill which may cause interference when you tighten the screws, remove it first and replace it after tightening the screws.)

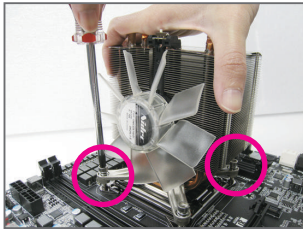

Step 3:
Use one hand to hold the cooler and the other to tighten the screws in a diagonal sequence with a screw driver. Begin tightening a screw with a few turns and repeat with the screw diagonally opposite the one you just tightened. Then do the same to the other pair. Next, fully tighten the four screws.

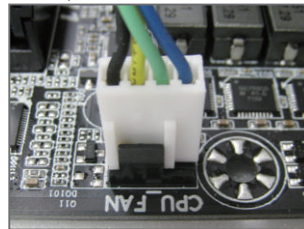

Step 4:
Finally, attach the power connector of the CPU cooler to the CPU fan header (CPU_FAN) on the motherboard.



Use extreme care when removing the CPU cooler because the thermal grease/tape between the CPU cooler and CPU may adhere to the CPU. Inadequately removing the CPU cooler may damage the CPU.

1-4 Installing the Memory



Read the following guidelines before you begin to install the memory:

- Make sure that the motherboard supports the memory. It is recommended that memory of the same capacity, brand, speed, and chips be used.
(Go to GIGABYTE's website for the latest supported memory speeds and memory modules.)
- Always turn off the computer and unplug the power cord from the power outlet before installing the memory to prevent hardware damage.
- Memory modules have a foolproof design. A memory module can be installed in only one direction. If you are unable to insert the memory, switch the direction.

1-4-1 4 Channel Memory Configuration

This motherboard provides four DDR3 memory sockets and supports 4 Channel Technology. After the memory is installed, the BIOS will automatically detect the specifications and capacity of the memory. The four DDR3 memory sockets are divided into four channels and each channel has one memory socket as following:

- ▶▶ Channel A: DDR3_4
- ▶▶ Channel B: DDR3_2
- ▶▶ Channel C: DDR3_1
- ▶▶ Channel D: DDR3_3

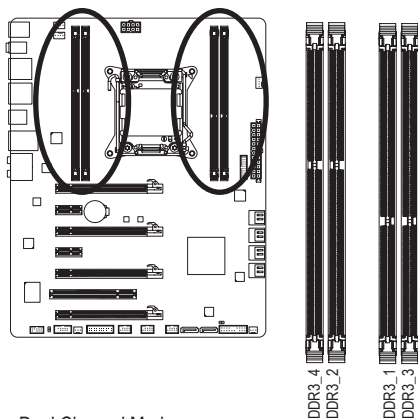

- Dual Channel Mode:
To enable Dual Channel mode, install two memory modules in any two of the four memory sockets.
- 3 Channel Mode:
To enable three Channel mode, install three memory modules in any three of the four memory sockets.
- 4 Channel Mode:
To enable four Channel mode, install four memory modules in the four memory sockets.

For optimum performance, when installing one memory module, we recommend that you install it in the DDR3_1 socket. When installing two memory modules, we recommend that you install them in the DDR3_1 and DDR3_2 sockets.

1-4-2 Installing a Memory

 Before installing a memory module, make sure to turn off the computer and unplug the power cord from the power outlet to prevent damage to the memory module.

DDR3 and DDR2 DIMMs are not compatible to each other or DDR DIMMs. Be sure to install DDR3 DIMMs on this motherboard.

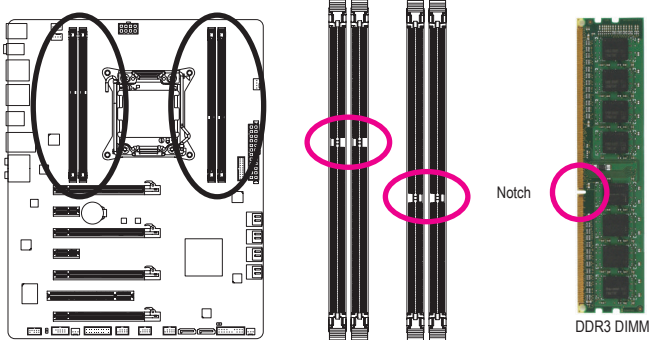

A DDR3 memory module has a notch, so it can only fit in one direction. Follow the steps below to correctly install your memory modules in the memory sockets.

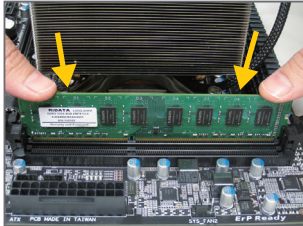

Step 1:

Note the orientation of the memory module. Spread the retaining clips at both ends of the memory socket. Place the memory module on the socket. As indicated in the picture on the left, place your fingers on the top edge of the memory, push down on the memory and insert it vertically into the memory socket.

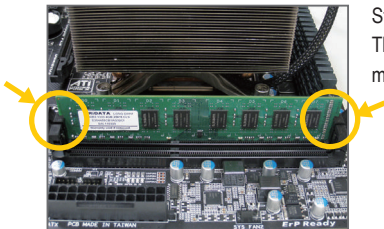

Step 2:

The clips at both ends of the socket will snap into place when the memory module is securely inserted.

1-5 Installing an Expansion Card



Read the following guidelines before you begin to install an expansion card:

- Make sure the motherboard supports the expansion card. Carefully read the manual that came with your expansion card.
- Always turn off the computer and unplug the power cord from the power outlet before installing an expansion card to prevent hardware damage.

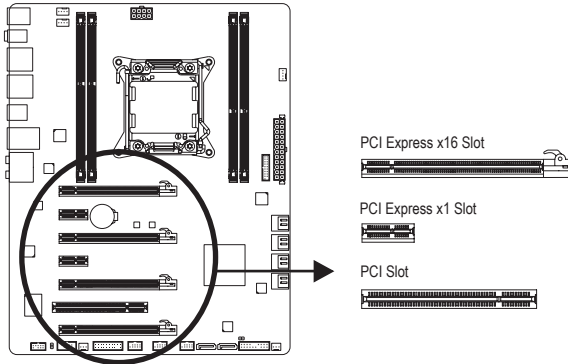

Follow the steps below to correctly install your expansion card in the expansion slot.

1. Locate an expansion slot that supports your card. Remove the metal slot cover from the chassis back panel.
2. Align the card with the slot, and press down on the card until it is fully seated in the slot.
3. Make sure the metal contacts on the card are completely inserted into the slot.
4. Secure the card's metal bracket to the chassis back panel with a screw.
5. After installing all expansion cards, replace the chassis cover(s).
6. Turn on your computer. If necessary, go to BIOS Setup to make any required BIOS changes for your expansion card(s).
7. Install the driver provided with the expansion card in your operating system.



- Installing a Graphics Card:
Gently push down on the top edge of the card until it is fully inserted into the PCI Express slot. Make sure the card is securely seated in the slot and does not rock.



- Removing the Card:
Press the latch at the end of the PCI Express slot to release the card and then pull the card straight up from the slot.

1-6 Setting up AMD CrossFire™/NVIDIA SLI Configuration

A. System Requirements

- The 2-Way CrossFire and 2-Way SLI technologies currently support Windows 7, Vista, XP operating systems
- The 3-Way/4-Way CrossFireX/SLI technologies currently support Windows 7 and Vista operating systems
- A CrossFire/SLI-supported motherboard with two/three PCI Express x16 slots and correct driver
- Two/three/four CrossFire/SLI-ready graphics cards of identical brand and chip and correct driver
(Current GPUs that support 3-Way/4-Way CrossFire technology include the ATI Radeon HD 3800, HD 4800, HD 5800 series, and AMD Radeon HD 6800 and HD 6900 series. Current GPUs that support 3-Way/4-Way SLI technology include the NVIDIA 8800 GTX, 8800 Ultra, 9800 GTX, GTX 260, GTX 280, GTX 470, GTX 480, GTX 570, GTX 580, and GTX 590 series.)
- CrossFire ^(Note)/SLI bridge connectors
- A power supply with sufficient power is recommended ^(Note) (Refer to the manual of your graphics cards for the power requirement)

B. Connecting the Graphics Cards

Step 1:

Observe the steps in "1-5 Installing an Expansion Card" and install CrossFire/SLI graphics cards on the PCI Express x16 slots. (To set up a 2-Way configuration, we recommend installing the graphics cards on the PCIEX16_1 and PCIEX16_2 slots.)

Step 2:

Insert the CrossFire ^(Note)/SLI bridge connectors in the CrossFire/SLI gold edge connectors on top of the cards.

Step 3:

Plug the display cable into the graphics card on the PCIEX16_1 slot.

C. Configuring the Graphics Card Driver

C-1. To Enable CrossFire Function

After installing the graphics card driver in the operating system, go to the **Catalyst Control Center**. Browse to **PerformanceAMD CrossFireX™ Configuration** and ensure the **Enable CrossFireX™** check box is selected and click **Apply**. (Available combination options are dependent on the number of graphics cards you install.)

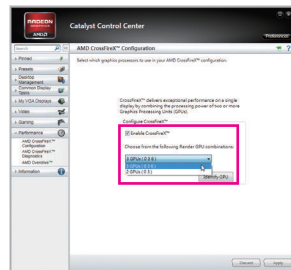

C-2. To Enable SLI Function

After installing the graphics card driver in the operating system, go to the **NVIDIA Control Panel**. Browse to the **Set SLI and PhysX Configuration** screen and ensure **Maximize 3D performance** is enabled.

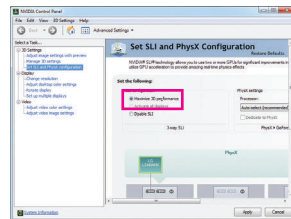

(Note) The bridge connectors may be needed or not depending on your graphics cards.



Procedure and driver screen for enabling CrossFire/SLI technology may differ by graphics cards. Refer to the manual that came with your graphics cards for more information about enabling CrossFire/SLI technology.

1-7 Back Panel Connectors

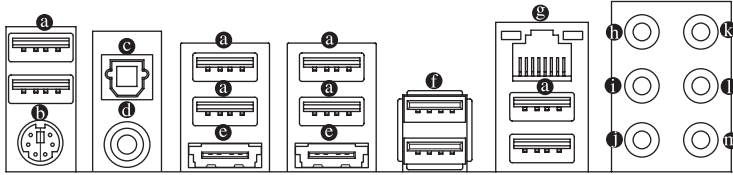

a) USB 2.0/1.1 Port

The USB port supports the USB 2.0/1.1 specification. Use this port for USB devices such as a USB keyboard/mouse, USB printer, USB flash drive and etc.

b) PS/2 Keyboard/Mouse Port

Use this port to connect a PS/2 mouse or keyboard.

c) Optical S/PDIF Out Connector

This connector provides digital audio out to an external audio system that supports digital optical audio. Before using this feature, ensure that your audio system provides an optical digital audio in connector.

d) Coaxial S/PDIF Out Connector

This connector provides digital audio out to an external audio system that supports coaxial optical audio. Before using this feature, ensure that your audio system provides an coaxial digital audio in connector.

e) eSATA 6Gb/s Connector

The eSATA 6Gb/s port conforms to SATA 6Gb/s standard and is compatible with SATA 3Gb/s and SATA 1.5Gb/s standard. Use the port to connect an external SATA device or a SATA port multiplier.

f) USB 3.0/2.0 Port

The USB 3.0 port supports the USB 3.0 specification and is compatible to the USB 2.0/1.1 specification. Use this port for USB devices such as a USB keyboard/mouse, USB printer, USB flash drive and etc.

g) RJ-45 LAN Port

The Gigabit Ethernet LAN port provides Internet connection at up to 1 Gbps data rate. The following describes the states of the LAN port LEDs.

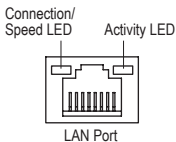

Connection/Speed LED:

State	Description
Orange	1 Gbps data rate
Green	100 Mbps data rate
Off	10 Mbps data rate

Activity LED:

State	Description
Blinking	Data transmission or receiving is occurring
Off	No data transmission or receiving is occurring



- When removing the cable connected to a back panel connector, first remove the cable from your device and then remove it from the motherboard.
- When removing the cable, pull it straight out from the connector. Do not rock it side to side to prevent an electrical short inside the cable connector.

① **Center/Subwoofer Speaker Out Jack (Orange)**

Use this audio jack to connect center/subwoofer speakers in a 5.1/7.1-channel audio configuration.

② **Rear Speaker Out Jack (Black)**

Use this audio jack to connect rear speakers in a 7.1-channel audio configuration.

③ **Side Speaker Out Jack (Gray)**

Use this audio jack to connect side speakers in a 4/5.1/7.1-channel audio configuration.

④ **Line In Jack (Blue)**

The default line in jack. Use this audio jack for line in devices such as an optical drive, walkman, etc.

⑤ **Line Out Jack (Green)**

The default line out jack. Use this audio jack for a headphone or 2-channel speaker. This jack can be used to connect front speakers in a 4/5.1/7.1-channel audio configuration.

⑥ **Mic In Jack (Pink)**

The default Mic in jack. Microphones must be connected to this jack.



In addition to the default speakers settings, the ① ~ ⑥ audio jacks can be reconfigured to perform different functions via the audio software. Only microphones still **MUST** be connected to the default Mic in jack (⑥). Refer to the instructions on setting up a 2/4/5.1/7.1-channel audio configuration in Chapter 5, "Configuring 2/4/5.1/7.1-Channel Audio."

1-8 Internal Connectors

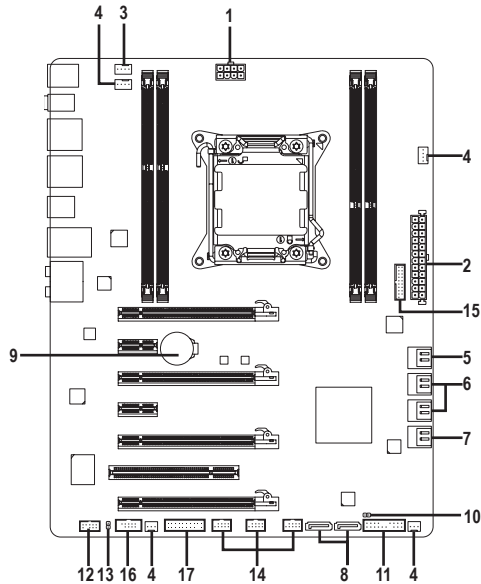

1)	ATX_12V_2X4	10)	CLR_CMOS
2)	ATX	11)	F_PANEL
3)	CPU_FAN	12)	F_AUDIO
4)	SYS_FAN1/2/3/4	13)	SPDIF_O
5)	SATA3 0/1	14)	F_USB1/F_USB2/F_USB3
6)	SATA2 2/3/4/5	15)	F_USB30
7)	GSATA3 6/7	16)	COMA
8)	GSATA3 8/9	17)	TPM
9)	BAT		



Read the following guidelines before connecting external devices:

- First make sure your devices are compliant with the connectors you wish to connect.
- Before installing the devices, be sure to turn off the devices and your computer. Unplug the power cord from the power outlet to prevent damage to the devices.
- After installing the device and before turning on the computer, make sure the device cable has been securely attached to the connector on the motherboard.

1/2) ATX_12V_2X4/ATX (2x4 12V Power Connector and 2x12 Main Power Connector)

With the use of the power connector, the power supply can supply enough stable power to all the components on the motherboard. Before connecting the power connector, first make sure the power supply is turned off and all devices are properly installed. The power connector possesses a foolproof design. Connect the power supply cable to the power connector in the correct orientation. The 12V power connector mainly supplies power to the CPU. If the 12V power connector is not connected, the computer will not start.



To meet expansion requirements, it is recommended that a power supply that can withstand high power consumption be used (500W or greater). If a power supply is used that does not provide the required power, the result can lead to an unstable or unbootable system.

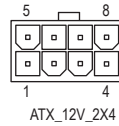
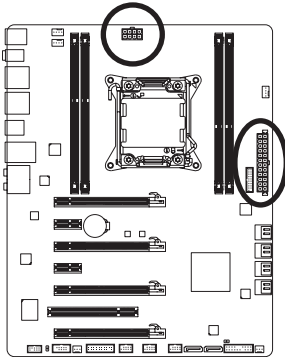

ATX_12V_2X4:

Pin No.	Definition
1	GND (Only for 2x4-pin 12V)
2	GND (Only for 2x4-pin 12V)
3	GND
4	GND
5	+12V (Only for 2x4-pin 12V)
6	+12V (Only for 2x4-pin 12V)
7	+12V
8	+12V

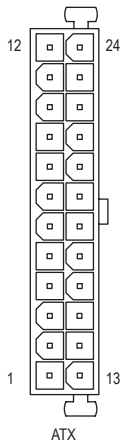

ATX:

Pin No.	Definition	Pin No.	Definition
1	3.3V	13	3.3V
2	3.3V	14	-12V
3	GND	15	GND
4	+5V	16	PS_ON (soft On/Off)
5	GND	17	GND
6	+5V	18	GND
7	GND	19	GND
8	Power Good	20	-5V
9	5VSB (stand by +5V)	21	+5V
10	+12V	22	+5V
11	+12V (Only for 2x12-pin ATX)	23	+5V (Only for 2x12-pin ATX)
12	3.3V (Only for 2x12-pin ATX)	24	GND (Only for 2x12-pin ATX)

3/4) CPU_FAN/SYS_FAN1/SYS_FAN2/SYS_FAN3/SYS_FAN4 (Fan Headers)

The motherboard has a 4-pin CPU fan header (CPU_FAN), two 4-pin (SYS_FAN1/SYS_FAN2) and two 3-pin (SYS_FAN3/SYS_FAN4) system fan headers. Most fan headers possess a foolproof insertion design. When connecting a fan cable, be sure to connect it in the correct orientation (the black connector wire is the ground wire). The motherboard supports fan speed control, which requires the use of a cooler with fan speed control design. For optimum heat dissipation, it is recommended that a system fan be installed inside the chassis.

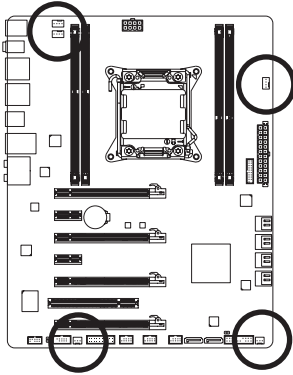

CPU_FAN



SYS_FAN1



SYS_FAN2



SYS_FAN3/SYS_FAN4

CPU_FAN:

Pin No.	Definition
1	GND
2	+12V/Speed Control
3	Sense
4	Speed Control

SYS_FAN1:

Pin No.	Definition
1	GND
2	+12V /Speed Control
3	Sense
4	Reserve

SYS_FAN2:

Pin No.	Definition
1	GND
2	+12V
3	Sense
4	Speed Control

SYS_FAN3/SYS_FAN4:

Pin No.	Definition
1	GND
2	+12V
3	Sense



- Be sure to connect fan cables to the fan headers to prevent your CPU and system from overheating. Overheating may result in damage to the CPU or the system may hang.
- These fan headers are not configuration jumper blocks. Do not place a jumper cap on the headers.

5) SATA3 0/1 (SATA 6Gb/s Connectors, Controlled by Intel X79 Chipset)

The SATA connectors conform to SATA 6Gb/s standard and are compatible with SATA 3Gb/s and SATA 1.5Gb/s standard. Each SATA connector supports a single SATA device. The "SATA3 0" and "SATA3 1" connectors support RAID 0 and RAID 1. RAID 5 and RAID 10 can be implemented on the two connectors with the "SATA2 2/3/4/5" connector ^(Note). Refer to Chapter 5, "Configuring SATA Hard Drive(s)," for instructions on configuring a RAID array.

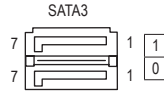
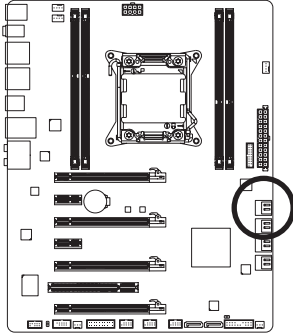

Pin No.	Definition
1	GND
2	TXP
3	TXN
4	GND
5	RXN
6	RXP
7	GND

6) SATA2 2/3/4/5 (SATA 3Gb/s Connectors, Controlled by Intel X79 Chipset)

The SATA connectors conform to SATA 3Gb/s standard and are compatible with SATA 1.5Gb/s standard. Each SATA connector supports a single SATA device. The Intel X79 Chipset supports RAID 0, RAID 1, RAID 5, and RAID 10. Refer to Chapter 5, "Configuring SATA Hard Drive(s)," for instructions on configuring a RAID array.

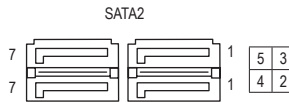
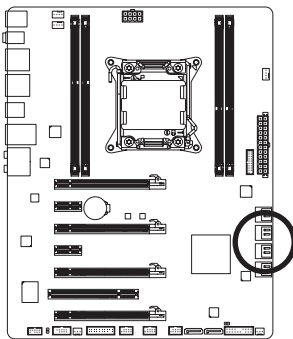

Pin No.	Definition
1	GND
2	TXP
3	TXN
4	GND
5	RXN
6	RXP
7	GND



Please connect the L-shaped end of the SATA cable to your SATA hard drive.



- A RAID 0 or RAID 1 configuration requires at least two hard drives. If more than two hard drives are to be used, the total number of hard drives must be an even number.
- A RAID 5 configuration requires at least three hard drives. (The total number of hard drives does not have to be an even number.)
- A RAID 10 configuration requires four hard drives.

(Note) When a RAID set is built across the SATA 6Gb/s and SATA 3Gb/s channels, the system performance of the RAID set may vary depending on the devices being connected.

7) GSATA3 6/7 (SATA 6Gb/s Connectors, Controlled by Marvell 88SE9172 Chip)

The SATA connectors conform to SATA 6Gb/s standard and are compatible with SATA 3Gb/s and SATA 1.5Gb/s standard. Each SATA connector supports a single SATA device. The Marvell 88SE9172 chip supports RAID 0 and RAID 1. Refer to Chapter 5, "Configuring SATA Hard Drive(s)," for instructions on configuring a RAID array.

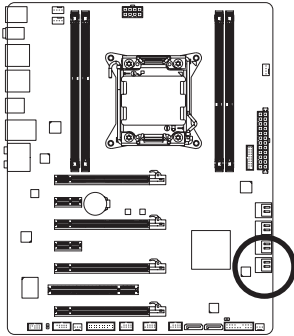

Pin No.	Definition
1	GND
2	TXP
3	TXN
4	GND
5	RXN
6	RXP
7	GND

8) GSATA3 8/9 (SATA 6Gb/s Connectors, Controlled by Marvell 88SE9172 Chip)

The SATA connectors conform to SATA 6Gb/s standard and are compatible with SATA 3Gb/s and SATA 1.5Gb/s standard. Each SATA connector supports a single SATA device. The Marvell 88SE9172 chip supports RAID 0 and RAID 1. Refer to Chapter 5, "Configuring SATA Hard Drive(s)," for instructions on configuring a RAID array.

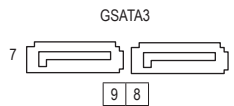
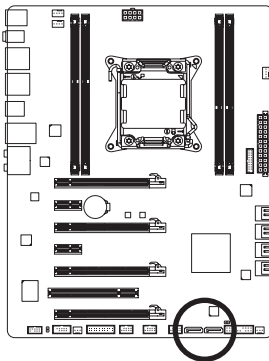

Pin No.	Definition
1	GND
2	TXP
3	TXN
4	GND
5	RXN
6	RXP
7	GND



Please connect the L-shaped end of the SATA cable to your SATA hard drive.



A RAID 0 or RAID 1 configuration requires two hard drives.

9) BAT (Battery)

The battery provides power to keep the values (such as BIOS configurations, date, and time information) in the CMOS when the computer is turned off. Replace the battery when the battery voltage drops to a low level, or the CMOS values may not be accurate or may be lost.

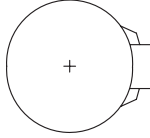
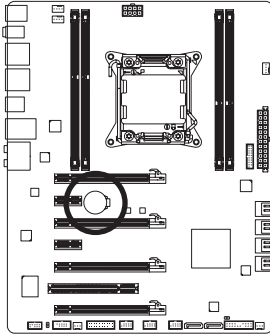

You may clear the CMOS values by removing the battery:

1. Turn off your computer and unplug the power cord.
2. Gently remove the battery from the battery holder and wait for one minute. (Or use a metal object like a screwdriver to touch the positive and negative terminals of the battery holder, making them short for 5 seconds.)
3. Replace the battery.
4. Plug in the power cord and restart your computer.



- Always turn off your computer and unplug the power cord before replacing the battery.
- Replace the battery with an equivalent one. Danger of explosion if the battery is replaced with an incorrect model.
- Contact the place of purchase or local dealer if you are not able to replace the battery by yourself or uncertain about the battery model.
- When installing the battery, note the orientation of the positive side (+) and the negative side (-) of the battery (the positive side should face up).
- Used batteries must be handled in accordance with local environmental regulations.

10) CLR_CMOS (Clearing CMOS Jumper)

Use this jumper to clear the CMOS values (e.g. date information and BIOS configurations) and reset the CMOS values to factory defaults. To clear the CMOS values, use a metal object like a screwdriver to touch the two pins for a few seconds.

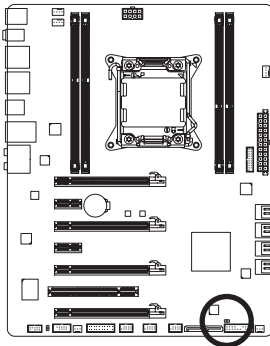

 Open: Normal

 Short: Clear CMOS Values



- Always turn off your computer and unplug the power cord from the power outlet before clearing the CMOS values.
- After system restart, go to BIOS Setup to load factory defaults (select Load Optimized Defaults) or manually configure the BIOS settings (refer to Chapter 2, "BIOS Setup," for BIOS configurations).

11) F_PANEL (Front Panel Header)

Connect the power switch, reset switch, speaker, chassis intrusion switch/sensor and system status indicator on the chassis to this header according to the pin assignments below. Note the positive and negative pins before connecting the cables.

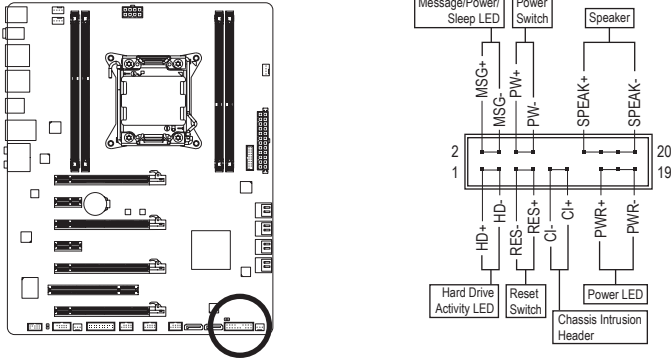

- **MSG/PWR** (Message/Power/Sleep LED, Yellow/Purple):

System Status	LED
S0	On
S1	Blinking
S3/S4/S5	Off

Connects to the power status indicator on the chassis front panel. The LED is on when the system is operating. The LED keeps blinking when the system is in S1 sleep state. The LED is off when the system is in S3/S4 sleep state or powered off (S5).

- **PW** (Power Switch, Red):

Connects to the power switch on the chassis front panel. You may configure the way to turn off your system using the power switch (refer to Chapter 2, "BIOS Setup," "Power Management Setup," for more information).

- **SPEAK** (Speaker, Orange):

Connects to the speaker on the chassis front panel. The system reports system startup status by issuing a beep code. One single short beep will be heard if no problem is detected at system startup.

- **HD** (Hard Drive Activity LED, Blue)

Connects to the hard drive activity LED on the chassis front panel. The LED is on when the hard drive is reading or writing data.

- **RES** (Reset Switch, Green):

Connects to the reset switch on the chassis front panel. Press the reset switch to restart the computer if the computer freezes and fails to perform a normal restart.

- **CI** (Chassis Intrusion Header, Gray):

Connects to the chassis intrusion switch/sensor on the chassis that can detect if the chassis cover has been removed. This function requires a chassis with a chassis intrusion switch/sensor.



The front panel design may differ by chassis. A front panel module mainly consists of power switch, reset switch, power LED, hard drive activity LED, speaker and etc. When connecting your chassis front panel module to this header, make sure the wire assignments and the pin assignments are matched correctly.

12) F_AUDIO (Front Panel Audio Header)

The front panel audio header supports Intel High Definition audio (HD) and AC'97 audio. You may connect your chassis front panel audio module to this header. Make sure the wire assignments of the module connector match the pin assignments of the motherboard header. Incorrect connection between the module connector and the motherboard header will make the device unable to work or even damage it.

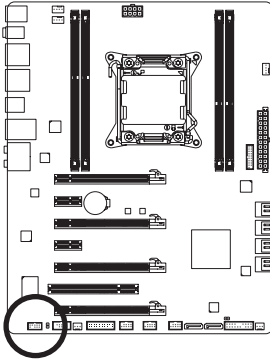

For HD Front Panel Audio:

Pin No.	Definition
1	MIC2_L
2	GND
3	MIC2_R
4	-ACZ_DET
5	LINE2_R
6	GND
7	FAUDIO_JD
8	No Pin
9	LINE2_L
10	GND

For AC'97 Front Panel Audio:

Pin No.	Definition
1	MIC
2	GND
3	MIC Power
4	NC
5	Line Out (R)
6	NC
7	NC
8	No Pin
9	Line Out (L)
10	NC



- The front panel audio header supports HD audio by default. If your chassis provides an AC'97 front panel audio module, refer to the instructions on how to activate AC'97 functionality via the audio software in Chapter 5, "Configuring 2/4/5.1/7.1-Channel Audio."
- Audio signals will be present on both of the front and back panel audio connections simultaneously. If you want to mute the back panel audio (only supported when using an HD front panel audio module), refer to Chapter 5, "Configuring 2/4/5.1/7.1-Channel Audio."
- Some chassis provide a front panel audio module that has separated connectors on each wire instead of a single plug. For information about connecting the front panel audio module that has different wire assignments, please contact the chassis manufacturer.

13) SPDIF_O (S/PDIF Out Header)

This header supports digital S/PDIF Out and connects a S/PDIF digital audio cable (provided by expansion cards) for digital audio output from your motherboard to certain expansion cards like graphics cards and sound cards. For example, some graphics cards may require you to use a S/PDIF digital audio cable for digital audio output from your motherboard to your graphics card if you wish to connect an HDMI display to the graphics card and have digital audio output from the HDMI display at the same time. For information about connecting the S/PDIF digital audio cable, carefully read the manual for your expansion card.

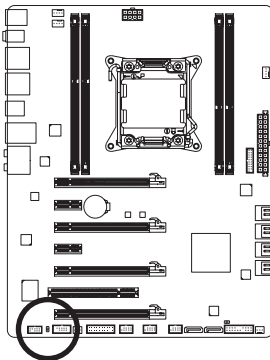

Pin No.	Definition
1	SPDIF_O
2	GND

14) F_USB1/F_USB2/F_USB3 (USB 2.0/1.1 Headers)

The headers conform to USB 2.0/1.1 specification. Each USB header can provide two USB ports via an optional USB bracket. For purchasing the optional USB bracket, please contact the local dealer.

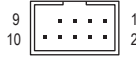
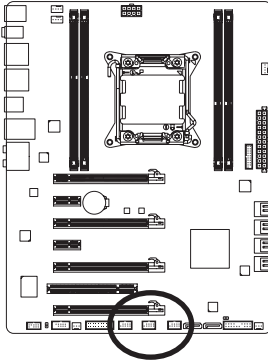

Pin No.	Definition
1	Power (5V)
2	Power (5V)
3	USB DX-
4	USB DY-
5	USB DX+
6	USB DY+
7	GND
8	GND
9	No Pin
10	NC

15) F_USB30 (USB 3.0/2.0 Header)

The header conforms to USB 3.0/2.0 specification and can provide two USB ports. For purchasing the optional 3.5" front panel that provides two USB 3.0/2.0 ports, please contact the local dealer.

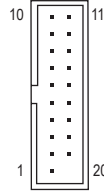
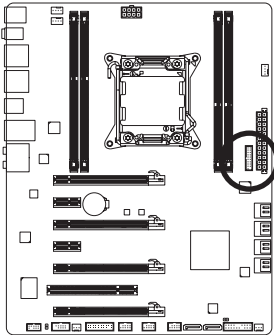

Pin No.	Definition	Pin No.	Definition
1	VBUS	11	D2+
2	SSRX1-	12	D2-
3	SSRX1+	13	GND
4	GND	14	SSTX2+
5	SSTX1-	15	SSTX2-
6	SSTX1+	16	GND
7	GND	17	SSRX2+
8	D1-	18	SSRX2-
9	D1+	19	VBUS
10	NC	20	No Pin



When the system is in S4/S5 mode, only the USB ports routed to the F_USB1 header can support the ON/OFF Charge function.



- Do not plug the IEEE 1394 bracket (2x5-pin) cable into the USB 2.0/1.1 header.
- Prior to installing the USB bracket, be sure to turn off your computer and unplug the power cord from the power outlet to prevent damage to the USB bracket.

16) COMA (Serial Port Header)

The COM header can provide one serial port via an optional COM port cable. For purchasing the optional COM port cable, please contact the local dealer.

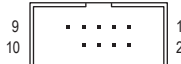
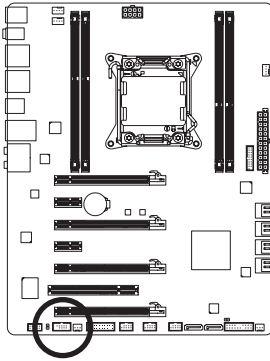

Pin No.	Definition
1	NDCD-
2	NSIN
3	NSOUT
4	NDTR-
5	GND
6	NDSR-
7	NRTS-
8	NCTS-
9	NRI-
10	No Pin

17) TPM (Trusted Platform Module Header)

You may connect a TPM (Trusted Platform Module) to this header.

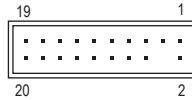
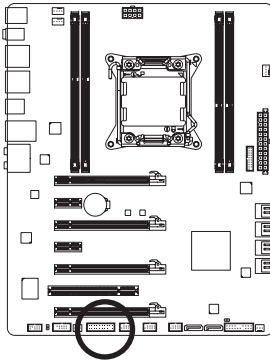

Pin No.	Definition	Pin No.	Definition
1	LCLK	11	LAD0
2	GND	12	GND
3	LFRAME	13	NC
4	No Pin	14	ID
5	LRESET	15	SB3V
6	NC	16	SERIRQ
7	LAD3	17	GND
8	LAD2	18	NC
9	VCC3	19	NC
10	LAD1	20	SUSCLK

Chapter 2 BIOS Setup

BIOS (Basic Input and Output System) records hardware parameters of the system in the CMOS on the motherboard. Its major functions include conducting the Power-On Self-Test (POST) during system startup, saving system parameters and loading operating system, etc. BIOS includes a BIOS Setup program that allows the user to modify basic system configuration settings or to activate certain system features. When the power is turned off, the battery on the motherboard supplies the necessary power to the CMOS to keep the configuration values in the CMOS.

To access the BIOS Setup program, press the <Delete> key during the POST when the power is turned on.

To upgrade the BIOS, use either the GIGABYTE Q-Flash or @BIOS utility.

- Q-Flash allows the user to quickly and easily upgrade or back up BIOS without entering the operating system.
- @BIOS is a Windows-based utility that searches and downloads the latest version of BIOS from the Internet and updates the BIOS.

For instructions on using the Q-Flash and @BIOS utilities, refer to Chapter 4, "BIOS Update Utilities."



- Because BIOS flashing is potentially risky, if you do not encounter problems using the current version of BIOS, it is recommended that you not flash the BIOS. To flash the BIOS, do it with caution. Inadequate BIOS flashing may result in system malfunction.
- It is recommended that you not alter the default settings (unless you need to) to prevent system instability or other unexpected results. Inadequately altering the settings may result in system's failure to boot. If this occurs, try to clear the CMOS values and reset the board to default values. (Refer to the "Load Optimized Defaults" section in this chapter or introductions of the battery/clearing CMOS jumper in Chapter 1 for how to clear the CMOS values.)

2-1 Startup Screen

The following startup Logo screen will appear when the computer boots.

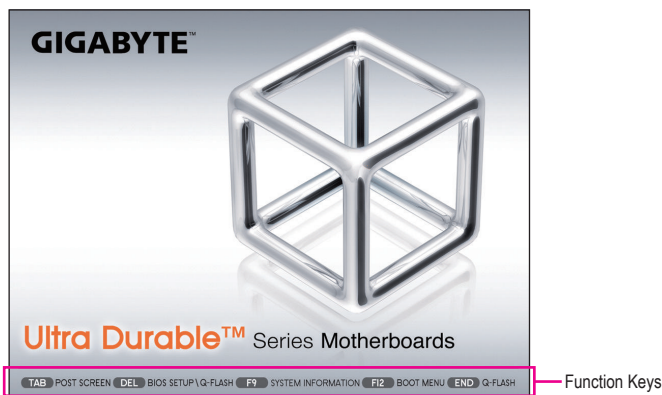

Function Keys:

<TAB>: POST SCREEN

Press the <Tab> key to skip the startup Logo. To turn off the startup Logo, refer to the instructions on the **Full Screen LOGO Show** item on page 51.

: BIOS SETUP\Q-FLASH

Press the <Delete> key to enter BIOS Setup or to access the Q-Flash utility in BIOS Setup.

<F9>: SYSTEM INFORMATION

Press the <F9> key to display your system information.

<F12>: BOOT MENU

Boot Menu allows you to set the first boot device without entering BIOS Setup. In Boot Menu, use the up arrow key <↑> or the down arrow key <↓> to select the first boot device, then press <Enter> to accept. The system will boot from the device immediately.

Note: The setting in Boot Menu is effective for one time only. After system restart, the device boot order will still be based on BIOS Setup settings.

<END>: Q-FLASH

Press the <End> key to access the Q-Flash utility directly without having to enter BIOS Setup first.

2-2 The Main Menu

On the main menu of the BIOS Setup program, press arrow keys to move among the items and press <Enter> to accept or enter a sub-menu. Or you can use your mouse to select the item you want.

(Sample BIOS Version: F2a)

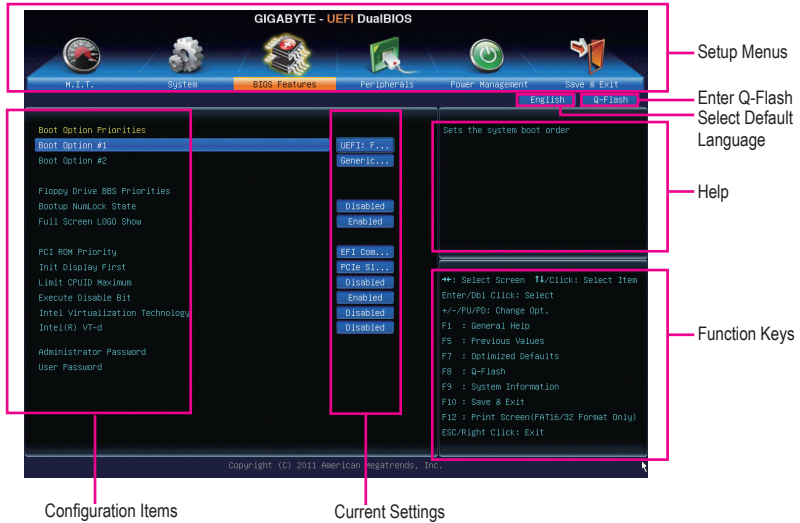

BIOS Setup Program Function Keys

<←><→>	Move the selection bar to select a setup menu
<↑><↓>	Move the selection bar to select an configuration item on a menu
<Enter>	Execute command or enter a menu
<+>/<Page Up>	Increase the numeric value or make changes
<->/<Page Down>	Decrease the numeric value or make changes
<F5>	Restore the previous BIOS settings for the current menu
<F7>	Load the optimized BIOS default settings for the current menu
<F8>	Access the Q-Flash utility
<F9>	Display system information
<F10>	Save all the changes and exit the BIOS Setup program
<F12>	Capture the current screen as an image and save it to your USB drive
<Esc>	Main Menu: Exit the BIOS Setup program Submenus: Exit current submenu

BIOS Setup Menus

■ M.I.T.

Use this menu to configure the clock, frequency, and voltages of your CPU and memory, etc. Or check the system/CPU temperatures, voltages, and fan speeds.

■ System

Use this menu to configure the default language used by the BIOS and system time and date. This menu also displays information on the devices connected to the SATA ports.

■ BIOS Features

Use this menu to configure the device boot order, advanced features available on the CPU, and the primary display adapter.

■ Peripherals

Use this menu to configure all peripheral devices, such as SATA, USB, integrated audio, and integrated LAN, etc.

■ Power Management

Use this menu to configure all the power-saving functions.

■ Save & Exit Setup

Save all the changes made in the BIOS Setup program to the CMOS and exit BIOS Setup. You can save the current BIOS settings to a profile or load optimized defaults for optimal-performance system operations.



- If the system is not stable as usual, load optimized defaults to set your system to its defaults.
- The BIOS Setup menus described in this chapter are for reference only and may differ by BIOS version.

2-3 M.I.T.



Whether the system will work stably with the overclock/overvoltage settings you made is dependent on your overall system configurations. Incorrectly doing overclock/overvoltage may result in damage to CPU, chipset, or memory and reduce the useful life of these components. This page is for advanced users only and we recommend you not to alter the default settings to prevent system instability or other unexpected results. (Inadequately altering the settings may result in system's failure to boot. If this occurs, clear the CMOS values and reset the board to default values.)



This section provides information on the BIOS version, CPU base clock, CPU frequency, memory frequency, total memory size, CPU temperature, Vcore, and memory voltages.

► **M.I.T. Current Status**

This screen provides information on CPU/memory frequencies/parameters.

► **Advanced Frequency Settings**



☞ **BCLK/PCIe Clock Control**

Enables or disables the control of CPU base clock and PCIe bus frequency. **Enabled** will allow the **Host Clock Frequency** and **Processor Base Clock** items below to be configurable. Note: If your system fails to boot after overclocking, please wait for 20 seconds for automated system reboot, or clear the CMOS values to reset the board to default values. (Default: Disabled)

☞ **Host Clock Frequency**

Allows you to manually set the host clock frequency (which controls CPU, PCIe, and memory frequencies) in 0.01 MHz increments. This item is configurable only when **BCLK/PCIe Clock Control** is enabled. When you change the **Host Clock Frequency** setting, the **Memory Frequency (Mhz)** setting below will be changed synchronously.

Important: It is highly recommended that the frequency be set in accordance with the CPU specifications.

☞ **Processor Base Clock**

Allows you to configure the **Processor Base Clock** by multiplying the **Host Clock Frequency** by several preset host clock multipliers. This item is configurable only when **BCLK/PCIe Clock Control** is enabled. When you change the **Processor Base Clock** setting, the **Memory Frequency (Mhz)** setting below will be changed synchronously.

Important: It is highly recommended that the frequency be set in accordance with the CPU specifications.

☞ **CPU Clock Ratio**

Allows you to alter the clock ratio for the installed CPU. The adjustable range is dependent on the CPU being installed.

☞ **CPU Frequency**

This value is determined by multiplying the **Processor Base Clock** value by the **CPU Clock Ratio** value.

▶ Advanced CPU Core Features



☞ CPU Clock Ratio, CPU Frequency

The settings under the two items above are synchronous to that under the same items on the **Advanced Frequency Settings** menu.

☞ Internal CPU PLL Overvoltage

Enabled allows CPU PLL voltage to operate at a higher value. **Disabled** allows CPU PLL voltage to operate at default value. **Auto** lets the BIOS automatically configure this setting. (Default: Auto)

☞ Real-Time CPU Ratio Control in OS (Note)

Enabled allows you to make real-time changes to the CPU clock ratio in your operating system. (Default: Disabled)

☞ Intel(R) Turbo Boost Technology (Note)

Allows you to determine whether to enable the Intel CPU Turbo Boost technology. **Auto** lets the BIOS automatically configure this setting. (Default: Auto)

☞ Turbo Ratio (1-Core Active)~(6-Core Active) (Note)

Allows you to set the CPU Turbo ratios for different number of active cores. **Auto** sets the CPU Turbo ratios according to the CPU specifications. (Default: Auto)

☞ Turbo Power Limit (Watts)

Allows you to set a power limit for CPU Turbo mode. When the CPU power consumption exceeds the specified power limit, the CPU will automatically reduce the core frequency in order to reduce the power. **Auto** sets the power limit according to the CPU specifications. (Default: Auto)

☞ Core Current Limit (Amps)

Allows you to set a current limit for CPU Turbo mode. When the CPU current exceeds the specified current limit, the CPU will automatically reduce the core frequency in order to reduce the current. **Auto** sets the current limit according to the CPU specifications. (Default: Auto)

(Note) This item is present only when you install a CPU that supports this feature. For more information about Intel CPUs' unique features, please visit Intel's website.

- ☞ **CPU Core Enabled** (Note 1)

Allows you to determine the number of CPU cores you want to enable. **Auto** lets the BIOS automatically configure this setting. (Default: Auto)
- ☞ **Hyper-Threading Technology** (Note 1)

Allows you to determine whether to enable Hyper-Threading technology when using an Intel CPU that supports this function. This feature only works for operating systems that support multi-processor mode. **Auto** lets the BIOS automatically configure this setting. (Default: Auto)
- ☞ **CPU Enhanced Halt (C1E)** (Note 1)

Enables or disables Intel CPU Enhanced Halt (C1E) function, a CPU power-saving function in system halt state. When enabled, the CPU core frequency and voltage will be reduced during system halt state to decrease power consumption. **Auto** lets the BIOS automatically configure this setting. (Default: Auto)
- ☞ **C3/C6 State Support** (Note 1)

Allows you to determine whether to let the CPU enter C3/C6 mode in system halt state. When enabled, the CPU core frequency and voltage will be reduced during system halt state to decrease power consumption. The C3/C6 state is a more enhanced power-saving state than C1. **Auto** lets the BIOS automatically configure this setting. (Default: Auto)
- ☞ **CPU Thermal Monitor** (Note 1)

Enables or disables Intel CPU Thermal Monitor function, a CPU overheating protection function. When enabled, the CPU core frequency and voltage will be reduced when the CPU is overheated. **Auto** lets the BIOS automatically configure this setting. (Default: Auto)
- ☞ **CPU EIST Function** (Note 1)

Enables or disables Enhanced Intel SpeedStep Technology (EIST). Depending on CPU loading, Intel EIST technology can dynamically and effectively lower the CPU voltage and core frequency to decrease average power consumption and heat production. **Auto** lets the BIOS automatically configure this setting. (Default: Auto)
- ☞ **Bi-Directional PROCHOT** (Note 1)

 - ▶▶ Auto Lets BIOS automatically configure this setting. (Default)
 - ▶▶ Enabled When the CPU or chipset detects that an overheating is occurring, PROCHOT signals will be emitted to lower CPU performance to decrease heat production.
 - ▶▶ Disabled Only allows the CPU to detect whether an overheating is occurring to emit PROCHOT signals.
- ☞ **Extreme Memory Profile (X.M.P.)** (Note 2)

Allows the BIOS to read the SPD data on XMP memory module(s) to enhance memory performance when enabled.

 - ▶▶ Disabled Disables this function. (Default)
 - ▶▶ Profile1 Uses Profile 1 settings.
 - ▶▶ Profile2 (Note 2) Uses Profile 2 settings.
- ☞ **System Memory Multiplier (SPD)**

Allows you to set the system memory multiplier. **Auto** sets memory multiplier according to memory SPD data. (Default: Auto)

(Note 1) This item is present only when you install a CPU that supports this feature. For more information about Intel CPUs' unique features, please visit Intel's website.

(Note 2) This item is present only when you install a memory module that supports this feature.

Memory Frequency(Mhz)

The first memory frequency value is the normal operating frequency of the memory being used; the second is the memory frequency that is automatically adjusted according to the **Host Clock Frequency**, **Processor Base Clock**, and **System Memory Multiplier** settings.

Advanced Memory Settings



Extreme Memory Profile (X.M.P.) (Note), System Memory Multiplier (SPD), Memory Frequency(Mhz)

The settings under the three items above are synchronous to those under the same items on the **Advanced Frequency Settings** menu.

Performance Enhance

Allows the system to operate at three different performance levels.

- ▶▶ Normal Lets the system operate at its basic performance level.
- ▶▶ Turbo Lets the system operate at its good performance level. (Default)
- ▶▶ Extreme Lets the system operate at its best performance level.

DRAM Timing Selectable

Quick and **Expert** allows the **Channel Interleaving**, **Rank Interleaving**, and memory timing settings below to be configurable. Options are: Auto (default), Quick, Expert.

Profile DDR Voltage

When using a non-XMP memory module or **Extreme Memory Profile (X.M.P.)** is set to **Disabled**, this item will display as **1.50V**. When **Extreme Memory Profile (X.M.P.)** is set to **Profile1** or **Profile2**, this item will display the value based on the SPD data on the XMP memory.

Profile VTT Voltage

The value displayed here is dependent on the CPU being used.

(Note) This item is present only when you install a memory module that supports this feature.

➤ **Channel Interleaving**

Enables or disables memory channel interleaving. **Enabled** allows the system to simultaneously access different channels of the memory to increase memory performance and stability. **Auto** lets the BIOS automatically configure this setting. (Default: Auto)

➤ **Rank Interleaving**

Enables or disables memory rank interleaving. **Enabled** allows the system to simultaneously access different ranks of the memory to increase memory performance and stability. **Auto** lets the BIOS automatically configure this setting. (Default: Auto)

▶ **Channel A/B/C/D Timing Settings**

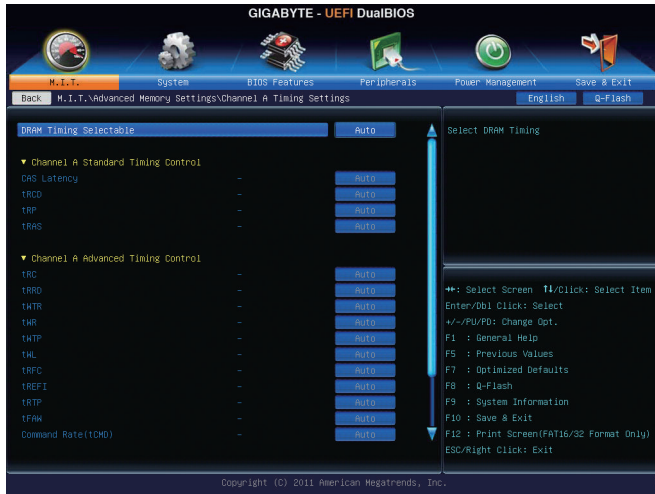

This sub-menu provides memory timing settings for each channel of memory. The respective timing setting screens are configurable only when **DRAM Timing Selectable** is set to **Quick** or **Expert**. Note: Your system may become unstable or fail to boot after you make changes on the memory timings. If this occurs, please reset the board to default values by loading optimized defaults or clearing the CMOS values.

► **Advanced Voltage Settings**

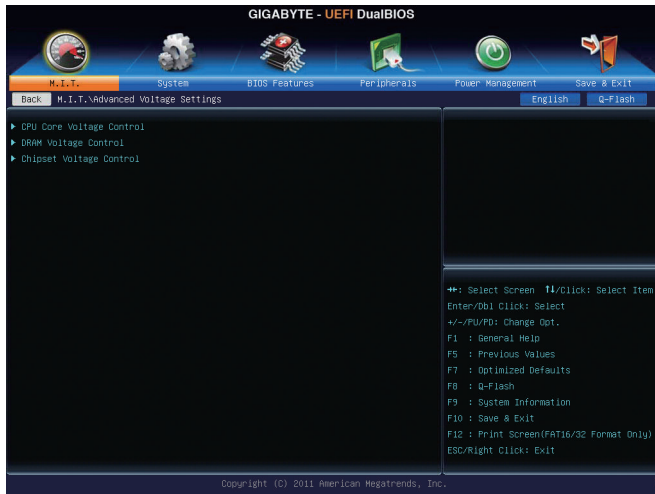

This sub-menu allows you to set CPU, memory, and Chipset voltages.

► PC Health Status



☞ Reset Case Open Status

- Disabled Keeps or clears the record of previous chassis intrusion status. (Default)
- Enabled Clears the record of previous chassis intrusion status and the **Case Opened** field will show "No" at next boot.

☞ Case Opened

Displays the detection status of the chassis intrusion detection device attached to the motherboard CI header. If the system chassis cover is removed, this field will show "Yes", otherwise it will show "No". To clear the chassis intrusion status record, set **Reset Case Open Status** to **Enabled**, save the settings to the CMOS, and then restart your system.

- ☞ **CPU Vcore/Dram Channel A/B Voltage/Dram Channel C/D Voltage/+5V/+12V+/CPU VTT**
Displays the current system voltages.
- ☞ **CPU Temperature/PCH Temperature/System Temperature**
Displays current CPU/Chipset/system temperature.
- ☞ **CPU Fan Speed/System Fan Speed**
Displays current CPU/system fan speeds.
- ☞ **CPU Warning Temperature**
Sets the warning threshold for CPU temperature. When CPU temperature exceeds the threshold, BIOS will emit warning sound. Options are: Disabled (default), 60°C/140°F, 70°C/158°F, 80°C/176°F, 90°C/194°F.
- ☞ **CPU Fan Fail Warning/System Fan Fail Warning**
Allows the system to emit warning sound if the CPU fan or system fans are not connected or fail. Check the fan condition or fan connection when this occurs. (Default: Disabled)
- ☞ **CPU Fan Speed Control**
Allows you to determine whether to enable the CPU fan speed control function and adjust the fan speed.
 - ▶▶ Normal Allows the CPU fan to run at different speeds according to the CPU temperature. You can adjust the fan speed with EasyTune based on your system requirements. (Default)
 - ▶▶ Silent Allows the CPU fan to run at slow speeds.
 - ▶▶ Manual Allows you to control the CPU fan speed under the **Slope PWM** item.
 - ▶▶ Disabled Allows the CPU fan to run at full speeds.
- ☞ **Slope PWM**
Allows you to control the CPU fan speed. This item is configurable only when **CPU Fan Speed Control** is set to **Manual**. Options are: 0.75 PWM value /°C ~ 2.50 PWM value /°C.
- ☞ **1st System Fan Speed Control (SYS_FAN1 Connector)**
Allows you to determine whether to enable the system fan speed control function for the system fan connected to the SYS_FAN1 connector and adjust the fan speed.
 - ▶▶ Normal Allows the system fan to run at different speeds according to the system temperature. You can adjust the fan speed with EasyTune based on your system requirements. (Default)
 - ▶▶ Silent Allows the CPU fan to run at slow speeds.
 - ▶▶ Manual Allows you to control the CPU fan speed under the **Slope PWM** item.
 - ▶▶ Disabled Allows the CPU fan to run at full speeds.
- ☞ **Slope PWM**
Allows you to control the system fan speed. This item is configurable only when **1st System Fan Speed Control** is set to **Manual**. Options are: 0.75 PWM value /°C ~ 2.50 PWM value /°C.
- ☞ **2nd System Fan Speed Control (SYS_FAN2 Connector)**
Allows you to determine whether to enable the system fan speed control function for the system fan connected to the SYS_FAN2 connector and adjust the fan speed.
 - ▶▶ Normal Allows the system fan to run at different speeds according to the system temperature. You can adjust the fan speed with EasyTune based on your system requirements. (Default)
 - ▶▶ Silent Allows the CPU fan to run at slow speeds.
 - ▶▶ Manual Allows you to control the CPU fan speed under the **Slope PWM** item.
 - ▶▶ Disabled Allows the CPU fan to run at full speeds.
- ☞ **Slope PWM**
Allows you to control the system fan speed. This item is configurable only when **2nd System Fan Speed Control** is set to **Manual**. Options are: 0.75 PWM value /°C ~ 2.50 PWM value /°C.

► Miscellaneous Settings

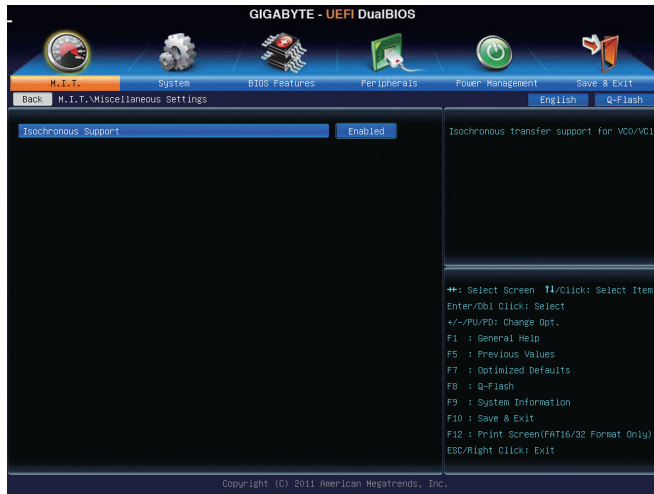

🔗 Isochronous Support

Determines whether to enable specific streams within the CPU and Chipset. This item is present only when you install a CPU that supports this feature. For more information about Intel CPUs' unique features, please visit Intel's website. (Default: Enabled)

2-4 System



This section provides information on your CPU, memory, motherboard model, and BIOS version. You can also select the default language used by the BIOS and manually set the system time.

System Language

Selects the default language used by the BIOS.

System Date

Sets the system date. The date format is week (read-only), month, date, and year. Use <Enter> to switch between the Month, Date, and Year fields and use the up arrow or down arrow key to set the desired value.

System Time

Sets the system time. The time format is hour, minute, and second. For example, 1 p.m. is 13:0:0. Use <Enter> to switch between the Hour, Minute, and Second fields and use the up arrow or down arrow key to set the desired value.

Access Level

Displays the current access level depending on the type of password protection used. (If no password is set, the default will display as Administrator.) The Administrator level allows you to make changes to all BIOS settings; the User level only allows you to make changes to certain BIOS settings but not all.

ATA Port Information

This section provides information on the device connected to each SATA port controlled by Intel X79 Chipset.

2-5 BIOS Features



☞ **Boot Option Priorities**

Specifies the overall boot order from the available devices. For example, you can set hard drive as the first priority (**Boot Option #1**) and DVD ROM drive as the second priority (**Boot Option #2**). The list only displays the device with the highest priority for a specific type. For example, only hard drive defined as the first priority on the **Hard Drive BBS Priorities** submenu will be presented here.

Removable storage devices that support GPT format will be prefixed with "UEFI:" string on the boot device list. To boot from an operating system that supports GPT partitioning, select the device prefixed with "UEFI:" string.

Or if you want to install an operating system that supports GPT partitioning such as Windows 7 64-bit, select the optical drive that contains the Windows 7 64-bit installation disk and is prefixed with "UEFI:" string.

☞ **Hard Drive/CD/DVD ROM Drive/Floppy Drive/Network Device BBS Priorities**

Specifies the boot order for a specific device type, such as hard drives, optical drives, floppy disk drives, and devices that support Boot from LAN function, etc. Press <Enter> on this item to enter the submenu that presents the devices of the same type that are connected. This item is present only if at least one device for this type is installed.

☞ **Bootup NumLock State**

Enables or disables Numlock feature on the numeric keypad of the keyboard after the POST. (Default: Disabled)

☞ **Full Screen LOGO Show**

Allows you to determine whether to display the GIGABYTE Logo at system startup. **Disabled** skips the GIGABYTE Logo when the system starts up. (Default: Enabled)

☞ **PCI ROM Priority**

Allows you to determine which Option ROM to launch. Options are Legacy ROM and EFI Compatible ROM. (Default: EFI Compatible ROM)

☞ **Init Display First**

Specifies the first initiation of the monitor display from the installed PCI or PCI Express graphics cards .

- ▶▶ PCIe Slot 1 Sets the graphics card on the PCIEX16_1 slot as the first display. (Default)
- ▶▶ PCIe Slot 2 Sets the graphics card on the PCIEX8_1 slot as the first display.
- ▶▶ PCIe Slot 3 Sets the graphics card on the PCIEX16_2 slot as the first display.
- ▶▶ PCIe Slot 4 Sets the graphics card on the PCIEX8_2 slot as the first display.
- ▶▶ PCI Sets the graphics card on the PCI slot as the first display.

☞ **Limit CPUID Maximum** (Note)

Allows you to determine whether to limit CPUID maximum value. Set this item to **Disabled** for Windows XP operating system; set this item to **Enabled** for legacy operating system such as Windows NT4.0. (Default: Disabled)

☞ **Execute Disable Bit** (Note)

Enables or disables Intel Execute Disable Bit function. This function may enhance protection for the computer, reducing exposure to viruses and malicious buffer overflow attacks when working with its supporting software and system. (Default: Enabled)

☞ **Intel Virtualization Technology** (Note)

Enables or disables Intel Virtualization Technology. Virtualization enhanced by Intel Virtualization Technology will allow a platform to run multiple operating systems and applications in independent partitions. With virtualization, one computer system can function as multiple virtual systems. (Default: Disabled)

☞ **Intel(R) VT-d** (Note)

Enables or disables Intel Virtualization Technology for Directed I/O. (Default: Disabled)

☞ **Administrator Password**

Allows you to configure an administrator password. Press <Enter> on this item, type the password, and then press <Enter>. You will be requested to confirm the password. Type the password again and press <Enter>. You must enter the administrator password (or user password) at system startup and when entering BIOS Setup. Differing from the user password, the administrator password allows you to make changes to all BIOS settings.

☞ **User Password**

Allows you to configure a user password. Press <Enter> on this item, type the password, and then press <Enter>. You will be requested to confirm the password. Type the password again and press <Enter>. You must enter the administrator password (or user password) at system startup and when entering BIOS Setup. However, the user password only allows you to make changes to certain BIOS settings but not all.

To cancel the password, press <Enter> on the password item and when requested for the password, enter the correct one first. When prompted for a new password, press <Enter> without entering any password. Press <Enter> again when prompted to confirm.

(Note) This item is present only when you install a CPU that supports this feature. For more information about Intel CPUs' unique features, please visit Intel's website.

2-6 Peripherals



☞ LAN PXE Boot Option ROM

Allows you to decide whether to activate the boot ROM integrated with the onboard LAN chip. (Default: Disabled)

☞ LAN Controller

Enables or disables the onboard LAN function. (Default: Enabled)

If you wish to install a 3rd party add-in network card instead of using the onboard LAN, set this item to **Disabled**.

☞ Audio Device Control

Enables or disables the onboard audio function. (Default: Enabled)

If you wish to install a 3rd party add-in audio card instead of using the onboard audio, set this item to **Disabled**.

☞ USB 2.0 Devices (Intel X79 Chipset)

Enables or disables the USB 2.0 controllers integrated with the Intel X79 Chipset. (Default: Enabled)

☞ Intel SATA Control Mode

Enables or disables RAID for the SATA controllers integrated in the Intel X79 Chipset or configures the SATA controllers to AHCI mode.

▶▶ IDE Mode Disables RAID for the SATA controllers and configures the SATA controllers to IDE mode.

▶▶ RAID Mode Enables RAID for the SATA controllers.

▶▶ AHCI Mode Configures the SATA controllers to AHCI mode. Advanced Host Controller Interface (AHCI) is an interface specification that allows the storage driver to enable advanced Serial ATA features such as Native Command Queuing and hot plug. (Default)

▶▶ Disabled Disables the SATA controllers.

☞ Legacy USB Support

Allows USB keyboard/mouse to be used in MS-DOS. (Default: Enabled)

☞ USB3.0 Support (Fresco FL1009 USB Controllers)

Enables or disables the Fresco FL1009 USB 3.0 controllers. (Default: Enabled)

➤ **XHCI Hand-off**

Determines whether to enable XHCI Hand-off feature for an operating system without XHCI Hand-off support. (Default: Enabled)

➤ **EHCI Hand-off**

Determines whether to enable EHCI Hand-off feature for an operating system without EHCI Hand-off support. (Default: Disabled)

➤ **Port 60/64 Emulation**

Enables or disables emulation of I/O ports 64h and 60h. This should be enabled for full legacy support for USB keyboards/mice in MS-DOS or in operating system that does not natively support USB devices. (Default: Enabled)

➤ **USB Storage Devices**

Displays a list of connected USB mass storage devices. You can configure how each device is going to be treated. For example, you can emulate a USB flash drive as a floppy disk drive. (Default: Auto)

▶ **Super IO Configuration**

This section provides information on the super I/O chip and allows you to configure the serial port.

➤ **Serial Port A**

Enables or disables the onboard serial port. (Default: Enabled)

▶ **Marvell ATA Controller Configuration**



➤ **GSATA Controller (Marvell 88SE9172 Chip, GSATA3 6 and GSATA3 7 connectors)**

Enables or disables RAID for the SATA controllers integrated in the Marvell 88SE9172 chip or configures the SATA controllers to AHCI mode.

- ▶▶ IDE Mode Disables RAID for the SATA controllers and configures the SATA controllers to IDE mode.
- ▶▶ RAID Mode Enables RAID for the SATA controllers.
- ▶▶ AHCI Mode Configures the SATA controllers to AHCI mode. Advanced Host Controller Interface (AHCI) is an interface specification that allows the storage driver to enable advanced Serial ATA features such as Native Command Queuing and hot plug. (Default)
- ▶▶ Disabled Disables the SATA controllers.

☞ **GSATA Controller (Marvell 88SE9172 Chip, GSATA3 8 and GSATA3 9 connectors)**

Enables or disables RAID for the SATA controllers integrated in the Marvell 88SE9172 chip or configures the SATA controllers to AHCI mode.

- ▶▶ IDE Mode Disables RAID for the SATA controllers and configures the SATA controllers to IDE mode.
- ▶▶ RAID Mode Enables RAID for the SATA controllers.
- ▶▶ AHCI Mode Configures the SATA controllers to AHCI mode. Advanced Host Controller Interface (AHCI) is an interface specification that allows the storage driver to enable advanced Serial ATA features such as Native Command Queuing and hot plug. (Default)
- ▶▶ Disabled Disables the SATA controllers.

☞ **GSATA Controller (Marvell 88SE9172 Chip, eSATA ports on the back panel)**

Enables or disables RAID for the SATA controllers integrated in the Marvell 88SE9172 chip or configures the SATA controllers to AHCI mode.

- ▶▶ IDE Mode Disables RAID for the SATA controllers and configures the SATA controllers to IDE mode.
- ▶▶ RAID Mode Enables RAID for the SATA controllers.
- ▶▶ AHCI Mode Configures the SATA controllers to AHCI mode. Advanced Host Controller Interface (AHCI) is an interface specification that allows the storage driver to enable advanced Serial ATA features such as Native Command Queuing and hot plug. (Default)
- ▶▶ Disabled Disables the SATA controllers.

2-7 Power Management



AC BACK

Determines the state of the system after the return of power from an AC power loss.

- ▶▶ Always Off The system stays off upon the return of the AC power. (Default)
- ▶▶ Always On The system is turned on upon the return of the AC power.
- ▶▶ Memory The system returns to its last known awake state upon the return of the AC power.

Power On by Keyboard

Allows the system to be turned on by a PS/2 keyboard wake-up event.

Note: you need an ATX power supply providing at least 1A on the +5VSB lead.

- ▶▶ Disabled Disables this function. (Default)
- ▶▶ Any Key Press any key to turn on the system.
- ▶▶ Keyboard 98 Press POWER button on the Windows 98 keyboard to turn on the system.

Resume by Alarm

Determines whether to power on the system at a desired time. (Default: Disabled)

If enabled, set the date and time as following:

- ▶▶ Wake up day: Turn on the system at a specific time on each day or on a specific day in a month.
- ▶▶ Wake up hour/minute/second: Set the time at which the system will be powered on automatically.

Note: When using this function, avoid inadequate shutdown from the operating system or removal of the AC power, or the settings may not be effective.

ACPI Sleep State

Specifies the ACPI sleep state when the system enters suspend.

- ▶▶ S1(CPU Stop Clock) Enables the system to enter the ACPI S1 sleep state. In S1 sleep state, the system appears suspended and stays in a low power mode. The system can be resumed at any time.

- ▶▶ S3(Suspend to RAM) Enables the system to enter the ACPI S3 sleep state. In S3 sleep state, the system appears to be off and consumes less power than in the S1 state. When signaled by a wake-up device or event, the system resumes to its working state exactly where it was left off. (Default)
- ▶▶ Suspend Disabled Disables this function.
- ⊟ **High Precision Event Timer** ^(Note)
Enables or disables High Precision Event Timer (HPET) for Windows 7/Vista operating system. (Default: Enabled)
- ⊟ **Soft-Off by PWR-BTTN**
Configures the way to turn off the computer in MS-DOS mode using the power button.
 - ▶▶ Instant-Off Press the power button and then the system will be turned off instantly. (Default)
 - ▶▶ Delay 4 Sec. Press and hold the power button for 4 seconds to turn off the system. If the power button is pressed for less than 4 seconds, the system will enter suspend mode.
- ⊟ **Wake on LAN from S5**
Allows the system to be awakened from S5 ACPI sleep state by a wake-up signal from the onboard LAN. (Default: Enabled)
- ⊟ **ErP Support**
Determines whether to let the system consume less than 1W power in S5 (shutdown) state. (Default: Disabled)
Note: When this item is set to **Enabled**, the following functions will become unavailable: PME event wake up, power on by mouse, power on by keyboard, and wake on LAN.

(Note) Supported on Windows 7/Vista operating system only.

2-8 Save & Exit Setup



☞ Save & Exit Setup

Press <Enter> on this item and select **Yes**. This saves the changes to the CMOS and exits the BIOS Setup program. Select **No** or press <Esc> to return to the BIOS Setup Main Menu.

☞ Exit Without Saving

Press <Enter> on this item and select **Yes**. This exits the BIOS Setup without saving the changes made in BIOS Setup to the CMOS. Select **No** or press <Esc> to return to the BIOS Setup Main Menu.

☞ Load Optimized Defaults

Press <Enter> on this item and select **Yes** to load the optimal BIOS default settings. The BIOS default settings help the system to operate in optimum state. Always load the optimized defaults after updating the BIOS or after clearing the CMOS values.

☞ Boot Override

Allows you to select a device to boot immediately. Press <Enter> on the device you select and select **Yes** to confirm. Your system will restart automatically and boot from that device.

☞ Save Profiles

This function allows you to save the current BIOS settings to a profile. You can create up to 4 profiles and save as Setup Profile 1~ Setup Profile 4.

☞ Load Profiles

If your system becomes unstable and you have loaded the BIOS default settings, you can use this function to load the BIOS settings from a profile created before, without the hassles of reconfiguring the BIOS settings. First select the profile you wish to load and then press <Enter> to complete.

Chapter 3 Drivers Installation



- Before installing the drivers, first install the operating system.
- After installing the operating system, insert the motherboard driver disk into your optical drive. The driver Autorun screen is automatically displayed which looks like that shown in the screen shot below. (If the driver Autorun screen does not appear automatically, go to My Computer, double-click the optical drive and execute the **Run.exe** program.)

3-1 Installing Chipset Drivers



Now Loading Please wait...

After inserting the driver disk, "Xpress Install" will automatically scan your system and then list all the drivers that are recommended to install. You can click the **Install All** button and "Xpress Install" will install all the recommended drivers. Or click **Install Single Items** to manually select the drivers you wish to install.

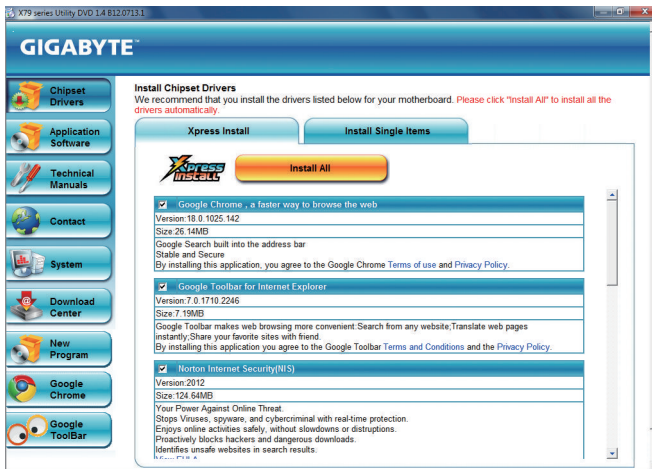

- Please ignore the popup dialog box(es) (e.g. the **Found New Hardware Wizard**) displayed when "Xpress Install" is installing the drivers. Failure to do so may affect the driver installation.
- Some device drivers will restart your system automatically during the driver installation. After the system restart, "Xpress Install" will continue to install other drivers.
- After "Xpress Install" installs all of the drivers, a dialog box will appear asking whether to install new GIGABYTE utilities. Click **Yes** to automatically install the utilities. Or click **No** if you want to manually select the utilities to install on the **Application Software** page later.
- For USB 2.0 driver support under the Windows XP operating system, please install the Windows XP Service Pack 1 or later. After installing the SP1 (or later), if a question mark still exists in **Universal Serial Bus Controller** in **Device Manager**, please remove the question mark (by right-clicking your mouse and select **Uninstall**) and restart the system. (The system will then autodetect and install the USB 2.0 driver.)

3-2 Application Software

This page displays all the utilities and applications that GIGABYTE develops and some free software. You can click the **Install** button on the right of an item to install it.

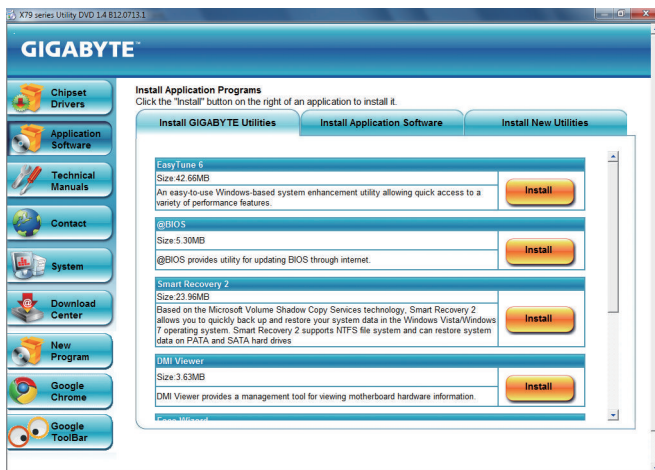

3-3 Technical Manuals

This page provides the content descriptions for this driver disk.

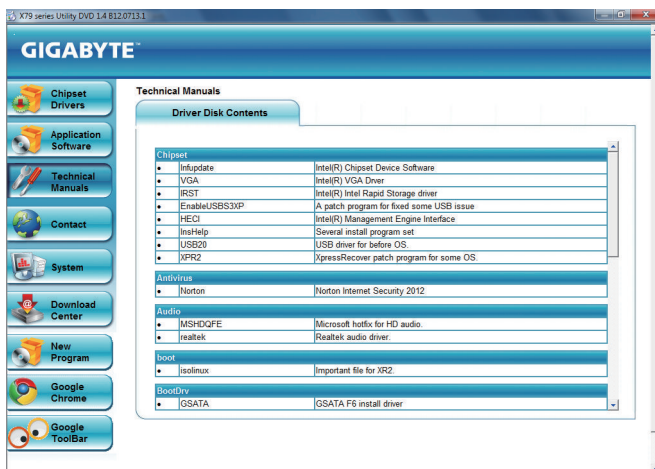

3-4 Contact

For the detailed contact information of the GIGABYTE Taiwan headquarter or worldwide branch offices, click the URL on this page to link to the GIGABYTE website.



3-5 System

This page provides the basic system information.

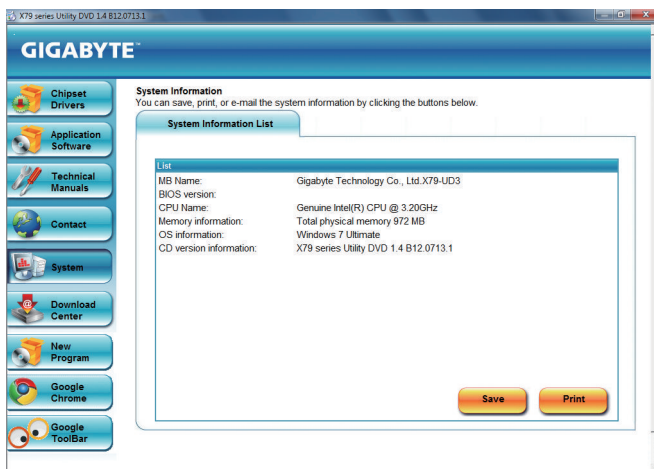

3-6 Download Center

To update the BIOS, drivers, or applications, click the **Download Center** button to link to the GIGABYTE website. The latest version of the BIOS, drivers, or applications will be displayed.

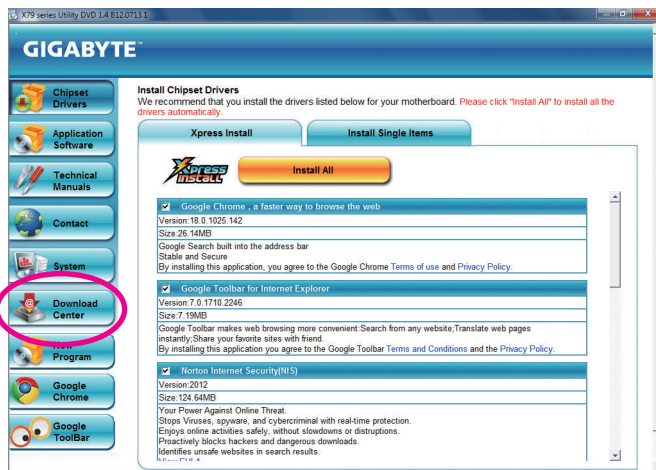

3-7 New Program

This page provides a quick link to GIGABYTE's lately developed utilities for users to install. You can click the **Install** button on the right of an item to install it.

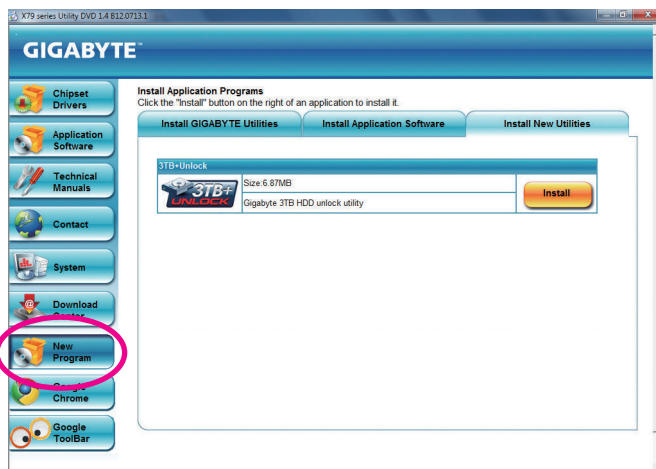

Chapter 4 Unique Features

4-1 Xpress Recovery2



Xpress Recovery2 is a utility that allows you to quickly compress and back up your system data and perform restoration of it. Supporting NTFS, FAT32, and FAT16 file systems, Xpress Recovery2 can back up data on PATA and SATA hard drives and restore it.

Before You Begin:

- Xpress Recovery2 will check the first physical hard drive ^(Note) for the operating system. Xpress Recovery2 can only back up/restore the first physical hard drive that has the operating system installed.
- As Xpress Recovery2 will save the backup file at the end of the hard drive, make sure to leave enough unallocated space in advanced (10 GB or more is recommended; actual size requirements vary, depending on the amount of data).
- It is recommended to back up your system soon after the operating system and drivers are installed.
- The amount of data and hard drive access speed may affect the speed at which the data is backed up/restored.
- It takes longer to back up a hard drive than to restore it.

System Requirements:

- At least 512 MB of system memory
- VESA compatible graphics card
- Windows XP with SP1 or later, Windows Vista, Windows 7



- Xpress Recovery and Xpress Recovery2 are different utilities. For example, a backup file created with Xpress Recovery cannot be restored using Xpress Recovery2.
- USB hard drives are not supported.
- RAID drives are not supported.
- GPT partitions are not supported.
- Hard drives larger than 2.2 TB are not supported.

Installation and Configuration:

Turn on your system to boot from the Windows 7 setup disk.

A. Installing Windows 7 and Partitioning the Hard Drive

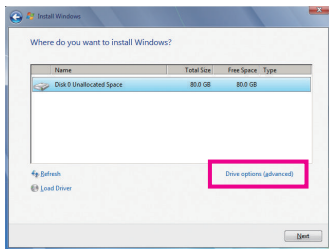

Step 1:
Click **Drive options**.

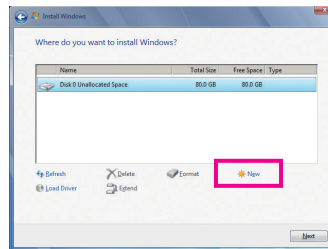

Step 2:
Click **New**.

(Note) Xpress Recovery2 checks the first physical hard drive in the following sequence: The first SATA connector, the second SATA connector and so forth. For example, When hard drives are attached to the first and third SATA connectors, the hard drive on the first SATA connector is the first physical drive.

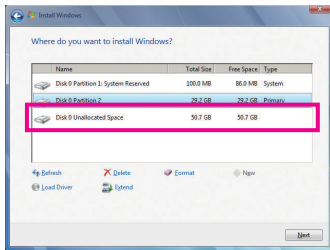

Step 3:
When partitioning your hard drive, make sure to leave unallocated space (10 GB or more is recommended; actual size requirements vary, depending on the amount of data) and begin the installation of the operating system.

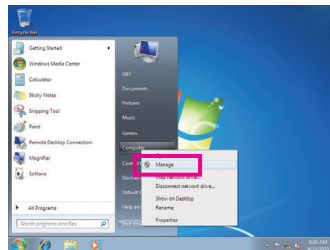

Step 4:
After the operating system is installed, click **Start**, right-click the **Computer** and select **Manage**. Go to **Disk Management** to check disk allocation.

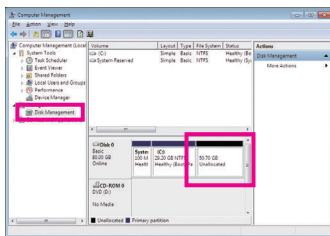

Step 5:
Xpress Recovery2 will save the backup file to the unallocated space (black stripe along the top). Please note that if there is no enough unallocated space, Xpress Recovery2 cannot save the backup file.

B. Accessing Xpress Recovery2

Boot from the motherboard driver disk to access Xpress Recovery2. When you see the following message: Press any key to startup Xpress Recovery2, press any key to enter Xpress Recovery2.

C. Using the Backup Function in Xpress Recovery2



Step 1:
Select **BACKUP** to start backing up your hard drive data.

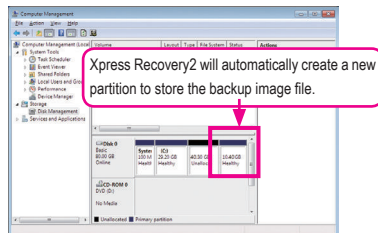

Step 2:
When finished, go to **Disk Management** to check disk allocation.

D. Using the Restore Function in Xpress Recovery2



Select **RESTORE** to restore the backup to your hard drive in case the system breaks down. The **RESTORE** option will not be present if no backup is created before.

E. Removing the Backup



Step 1:

If you wish to remove the backup file, select **REMOVE**.

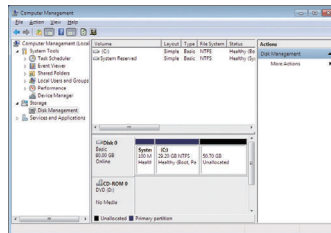

Step 2:

After the backup file is removed, no backup image file will be present in **Disk Management** and hard drive space will be freed up.

F. Exiting Xpress Recovery2



Select **REBOOT** to exit Xpress Recovery2.

4-2 BIOS Update Utilities

GIGABYTE motherboards provide two unique BIOS update tools, Q-Flash™ and @BIOS™. GIGABYTE Q-Flash and @BIOS are easy-to-use and allow you to update the BIOS without the need to enter MS-DOS mode. Additionally, this motherboard features the DualBIOS™ design, which enhances protection for the safety and stability of your computer by adding one more physical BIOS chip.



What is DualBIOS™?

Motherboards that support DualBIOS have two BIOS onboard, a main BIOS and a backup BIOS. Normally, the system works on the main BIOS. However, if the main BIOS is corrupted or damaged, the backup BIOS will take over on the next system boot and copy the BIOS file to the main BIOS to ensure normal system operation. For the sake of system safety, users cannot update the backup BIOS manually.



What is Q-Flash™?

With Q-Flash you can update the system BIOS without having to enter operating systems like MS-DOS or Windows first. Embedded in the BIOS, the Q-Flash tool frees you from the hassles of going through complicated BIOS flashing process.



What is @BIOS™?

@BIOS allows you to update the system BIOS while in the Windows environment. @BIOS will download the latest BIOS file from the nearest @BIOS server site and update the BIOS.

4-2-1 Updating the BIOS with the Q-Flash Utility

A. Before You Begin

1. From GIGABYTE's website, download the latest compressed BIOS update file that matches your motherboard model.
2. Extract the file and save the new BIOS file (e.g. X79UD3.F1) to your USB flash drive or hard drive. Note: The USB flash drive or hard drive must use FAT32/16/12 file system.
3. Restart the system. During the POST, press the <End> key to enter Q-Flash. Note: You can access Q-Flash by either pressing the <End> key during the POST or pressing the <F8> key in BIOS Setup. However, if the BIOS update file is saved to a hard drive in RAID/AHCI mode or a hard drive attached to an independent SATA controller, use the <End> key during the POST to access Q-Flash.



Because BIOS flashing is potentially risky, please do it with caution. Inadequate BIOS flashing may result in system malfunction.

B. Updating the BIOS

In the main menu of Q-Flash, use the keyboard or mouse to select an item to execute. When updating the BIOS, choose the location where the BIOS file is saved. The following procedure assumes that you save the BIOS file to a USB flash drive.

Step 1:

1. Insert the USB flash drive containing the BIOS file into the computer. In the main menu of Q-Flash, select **Update BIOS From Drive**.



- The **Save Main BIOS to Drive** option allows you to save the current BIOS file.
- Q-Flash only supports USB flash drive or hard drives using FAT32/16/12 file system.
- If the BIOS update file is saved to a hard drive in RAID/AHCI mode or a hard drive attached to an independent SATA controller, use the <End> key during the POST to access Q-Flash.

2. Select **Flash Disk**.

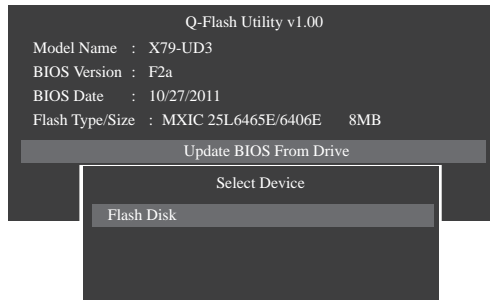

3. Select the BIOS update file.



Make sure the BIOS update file matches your motherboard model.

Step 2:

The process of the system reading the BIOS file from the USB flash drive is displayed on the screen. When the message "Are you sure to update BIOS?" appears, select **Yes** to begin the BIOS update. The monitor will display the update process.



- **Do not turn off or restart the system when the system is reading/updating the BIOS.**
- **Do not remove the USB flash drive or hard drive when the system is updating the BIOS.**

Step 3:

When the update process is complete, select **Reboot** to reboot the system.

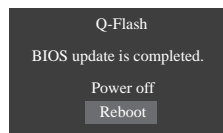

Step 4:

After the system reboots, you will see the new BIOS version on the POST screen.

Step 5:

During the POST, press <Delete> to enter BIOS Setup. Select **Load Optimized Defaults** on the **Save & Exit** screen and press <Enter> to load BIOS defaults. System will re-detect all peripheral devices after a BIOS update, so we recommend that you reload BIOS defaults.

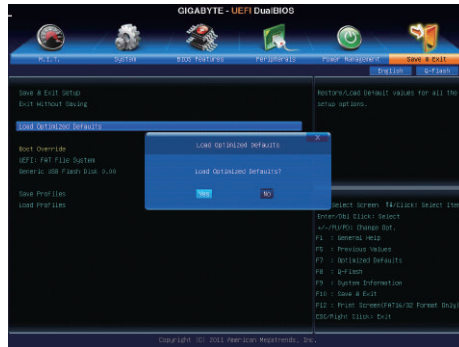

Select **Yes** to load BIOS defaults

Step 6:

Select **Save & Exit Setup** and press <Enter>. And then select **Yes** to save settings to CMOS and exit BIOS Setup. The procedure is complete after the system restarts.





4-2-2 Updating the BIOS with the @BIOS Utility

A. Before You Begin

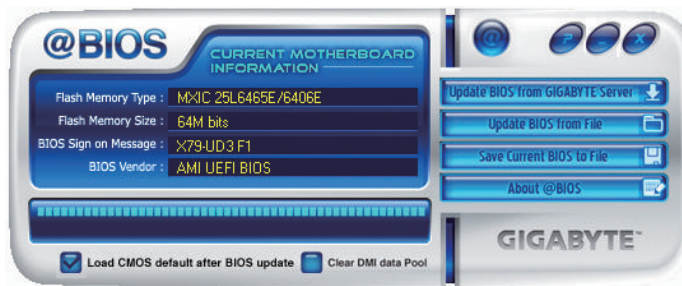
1. In Windows, close all applications and TSR (Terminate and Stay Resident) programs. This helps prevent unexpected failures when performing a BIOS update.
2. During the BIOS update process, ensure the Internet connection is stable and do NOT interrupt the Internet connection (for example, avoid a power loss or switching off the Internet). Failure to do so may result in a corrupted BIOS or a system that is unable to start.
3. Do not use the G.O.M. (GIGABYTE Online Management) function when using @BIOS.
4. GIGABYTE product warranty does not cover any BIOS damage or system failure resulting from an inadequate BIOS flashing.

B. Using @BIOS



1.  **Update the BIOS Using the Internet Update Function:**
Click **Update BIOS from GIGABYTE Server**, select the @BIOS server site closest to your location and then download the BIOS file that matches your motherboard model. Follow the on-screen instructions to complete.
 If the BIOS update file for your motherboard is not present on the @BIOS server site, please manually download the BIOS update file from GIGABYTE's website and follow the instructions in "Update the BIOS without Using the Internet Update Function" below.
2.  **Update the BIOS without Using the Internet Update Function:**
Click **Update BIOS from File**, then select the location where you save the BIOS update file obtained from the Internet or through other source. Follow the on-screen instructions to complete.
3.  **Save the Current BIOS File:**
Click **Save Current BIOS to File** to save the current BIOS file.
4.  **Load BIOS Defaults after BIOS Update:**
Select the **Load CMOS default after BIOS update** check box and then the system will automatically load BIOS defaults after BIOS update and after the system restarts.

C. After Updating the BIOS

Restart your system after updating the BIOS.



Make sure that the BIOS file to be flashed matches your motherboard model. Updating the BIOS with an incorrect BIOS file could cause your system not to boot.







4-3 EasyTune 6

GIGABYTE's EasyTune 6 is a simple and easy-to-use interface that allows users to fine-tune their system settings or do overclock/overvoltage in Windows environment. The user-friendly EasyTune 6 interface also includes tabbed pages for CPU and memory information, letting users read their system-related information without the need to install additional software.

The EasyTune 6 Interface



Tabs Information

Tab	Function
	The CPU tab provides information on the installed CPU and motherboard.
	The Memory tab provides information on the installed memory module(s). You can select memory module on a specific slot to see its information.
	<p>The Tuner tab allows you to change memory settings and voltages.</p> <ul style="list-style-type: none"> • Quick Boost mode provides you with 3 levels of CPU frequency/base clock to choose to achieve desired system performance. After making changes in Quick Boost mode or clicking Default to restore to default values, be sure to restart your system for these changes to take effect. • Easy mode provides information on CPU/memory. • Advanced mode allows you to individually change system clock settings and voltages settings using the sliders. • Save allows you to save the current settings to a new profile (.txt file). • Load allows you to load previous settings from a profile. <p>After making changes in Easy mode/Advanced mode, be sure to click Set for these changes to take effect or click Default to restore to default values.</p>
	The Graphics tab allows you to change the core clock and memory clock for your ATI or NVIDIA graphics card.
	The Smart tab allows you to specify a Smart Fan mode. Smart Fan Advanced mode allows the fan speed to be changed linearly based on the temperature thresholds you set.
	The HW Monitor tab allows you to monitor hardware temperature, voltage and fan speed and set temperature/fan speed alarm. You can choose the alert sound from the buzzer or use your own sound file (.wav file).



Available functions in EasyTune 6 may differ by motherboard model. Grayed-out area(s) indicates that the item is not configurable or the function is not supported.



Incorrectly doing overclock/overvoltage may result in damage to the hardware components such as CPU, chipset, and memory and reduce the useful life of these components. Before you do the overclock/overvoltage, make sure that you fully know each function of EasyTune 6, or system instability or other unexpected results may occur.

4-4 Q-Share

Q-Share is an easy and convenient data sharing tool. After configuring your LAN connection settings and Q-Share, you are able to share your data with computers on the same network, making full use of Internet resources.

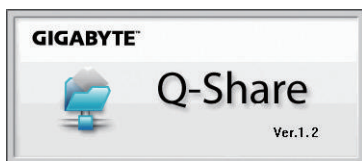

Directions for using Q-Share

After installing Q-Share from the motherboard driver disk, go to Start>All Programs>GIGABYTE>Q-Share.exe to launch the Q-Share tool. Find the **Q-Share** icon  in the notification area and right-click on this icon to configure the data sharing settings.



Figure 1. Data Sharing Disabled



Figure 2. Data Sharing Enabled

Options Descriptions

Option	Description
Connect ...	Displays the computers with data sharing enabled
Enable Incoming Folder ...	Enables data sharing
Disable Incoming Folder ...	Disables data sharing
Open Incoming Folder : C:\Q-ShareFolder	Accesses the shared data folder
Change Incoming Folder : C:\Q-ShareFolder	Changes the data folder to be shared <small>(Note)</small>
Update Q-Share ...	Updates Q-Share online
About Q-Share ...	Displays the current Q-Share version
Exit...	Exits Q-Share

(Note) This option is available only when data sharing is NOT enabled.

4-5 eXtreme Hard Drive (X.H.D)



With GIGABYTE eXtreme Hard Drive (X.H.D) ^(Note 1), users can quickly configure a RAID-ready system for RAID 0 when a new SATA drive is added. For a RAID 0 array that already exists, users also can use X.H.D to easily add a hard drive into the array to expand its capacity. All with a simple click of a button, X.H.D helps to enhance your hard drive read/write performance without the need for complex and time-consuming configurations. The following procedure details the steps to set up a RAID-ready system and configure it for RAID 0.

A. Setting Up a RAID-Ready System

Step 1: Configure the system BIOS

Enter the system BIOS Setup program to enable RAID for the Intel SATA controllers.

Step 2: Install the RAID driver and operating system

The X.H.D utility supports Windows 7/Vista/XP. Before installing the operating system, you have to load the SATA controller driver first. Without the driver, the hard drive may not be recognized during the Windows setup process. (For more details, refer to Chapter 5, "Installing the SATA RAID/AHCI Driver and Operating System.")

Step 3: Install the motherboard drivers and the X.H.D utility

After installing the operating system, insert the motherboard driver disk. You can click the Xpress Install All button to automatically install all motherboard drivers, including the X.H.D utility. Or you can go to the Application Software screen to individually install the X.H.D utility later.

B. Using GIGABYTE eXtreme Hard Drive (X.H.D)



Instructions ^(Note 2):

Before launching X.H.D, make sure the newly added harddrive has equal or greater capacity than the RAID-ready system drive. (To add a new hard drive into a RAID 0 array that's been created earlier, make sure the new drive is greater than or equal to the biggest drive in the array.)

1. **Auto** To automatically set up a RAID 0 array:
Click **Auto** to automatically and quickly set up a RAID 0 array.
2. **Manual** To manually set up a RAID array ^(Note 3):
Click **Manual** to access the Intel Rapid Storage Technology, with which you can build a RAID 0, RAID 1, or other supported RAID array depending on your needs and hardware components.
3. **Cancel** Exits the X.H.D utility:
Click **Cancel** to exit the X.H.D utility.

(Note 1) The X.H.D utility only supports the SATA controllers integrated in the Intel Chipset.

(Note 2) It is recommended that before you run the X.H.D utility, back up all of your data to avoid risk of hardware damage or lost of data.

(Note 3) If you manually build a non-RAID 0 array, you'll not be able to automatically set up a RAID 0 array later using the **Auto** function.

4-6 Cloud OC



Cloud OC ^(Note 1) is an easy-to-use overclocking utility designed for system overclocking via virtually any Internet-connected device, such as a smart phone, iPhone, notebook PC, etc. By simply connecting to an Internet browser via LAN, wireless LAN, or Bluetooth ^(Note 2) and logging in to the Cloud OC server, you can easily access three major functions of Cloud OC, including Tuner (system tweaking), System Info (system monitoring), and Control (system status control).

A. Launching Cloud OC

Step 1:

The first time you launch Cloud OC, the system will request you to set up a password which will be required for login to the Cloud OC server.

Step 2:

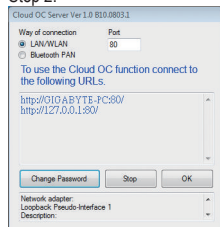

Find the **Cloud OC** icon  in the notification area and right click the icon to select **Start Server** to launch the Cloud OC server. The Cloud OC server will provide a dedicated IP and you can enter this IP address in an Internet-connected browser to log in to the Cloud OC server later.

Step 3:



When the Cloud OC web page appears, click **Login**, enter the previously configured password, and then click **Send** and you will be able to view

your system status.

B. Directions for use ^(Note 3)



• **Tuner** (System Tweaking):

The **Tuner** tab provides a full range of tweaking options that include CPU, memory, graphics, and PCIe frequencies and voltages. Click the <+> or <-> button under an item you want to configure or directly enter a value, and click **Set XXXX** to complete.



• **System Info** (System Monitoring):

The **System Info** tab enables real time PC system status monitoring for values such as CPU temperature, cooling fan speeds, CPU VCore and system temperature.

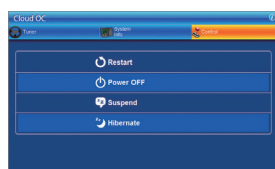

• **Control** (System Status Control):

The **Control** tab allows for controlling system power states with restart, power off, suspend, and hibernate options.

(Note 1) Supported on Windows 7, Vista, and XP. For Windows XP, be sure to update Internet Explorer to version 7.0 or later. When using Cloud OC, make sure the Internet connection is normal. Cloud OC will be unable to connect to the remote computer when the Internet is disconnected or when the remote computer is in power off, standby, or hibernation mode.

(Note 2) Bluetooth PAN (Personal Area Network) support is required.

(Note 3) Available functions may differ by motherboard model.

Chapter 5 Appendix

5-1 Configuring SATA Hard Drive(s)

RAID Levels

	RAID 0	RAID 1	RAID 5	RAID 10
Minimum Number of Hard Drives	≥2	2	≥3	≥4
Array Capacity	Number of hard drives * Size of the smallest drive	Size of the smallest drive	(Number of hard drives -1) * Size of the smallest drive	(Number of hard drives/2) * Size of the smallest drive
Fault Tolerance	No	Yes	Yes	Yes

To configure SATA hard drive(s), follow the steps below:

- A. Install SATA hard drive(s) in your computer.
- B. Configure SATA controller mode in BIOS Setup.
- C. Configure a RAID array in RAID BIOS. ^(Note 1)
- D. Install the SATA RAID/AHCI driver and operating system. ^(Note 2)

Before you begin

Please prepare:

- At least two SATA hard drives (to ensure optimal performance, it is recommended that you use two hard drives with identical model and capacity). If you do not want to create RAID, you may prepare only one hard drive.
- Windows 7/Vista/XP ^(Note 3) setup disk.
- Motherboard driver disk.
- A USB floppy disk drive (needed during Windows XP installation) ^(Note 3)
- An empty formatted floppy disk (needed during Windows XP installation) ^(Note 3)

5-1-1 Configuring Intel X79 SATA Controllers

A. Installing SATA hard drive(s) in your computer

Attach one end of the SATA signal cable to the rear of the SATA hard drive and the other end to available SATA port on the motherboard. If there is more than one SATA controller on your motherboard, refer to "Chapter 1," "Hardware Installation," to identify the SATA controller for the SATA port. (For example, on this motherboard, the SATA3 0/1 ^(Note 4) and SATA2 2/3/4/5 ports are supported by the X79 Chipset.) Then connect the power connector from your power supply to the hard drive.

(Note 1) Skip this step if you do not want to create RAID array on the SATA controller.

(Note 2) Required when the SATA controller is set to AHCI or RAID mode.

(Note 3) The X79 SATA RAID/AHCI driver does not support Windows XP.

(Note 4) When a RAID set is built across the SATA 6Gb/s and SATA 3Gb/s channels, the system performance of the RAID set may vary depending on the devices being connected.

B. Configuring SATA controller mode in BIOS Setup

Make sure to configure the SATA controller mode correctly in system BIOS Setup.

Step 1:

Turn on your computer and press <Delete> to enter BIOS Setup during the POST (Power-On Self-Test). To create RAID, set **Intel SATA Controller Mode** under the **Peripherals** menu to **RAID Mode** (Figure 1) (**AHCI mode** by default). If you do not want to create RAID, set this item to **IDE Mode** or **AHCI Mode**.



Figure 1

Step 2:

Save changes and exit BIOS Setup.



The BIOS Setup menus described in this section may differ from the exact settings for your motherboard. The actual BIOS Setup menu options you will see shall depend on the motherboard you have and the BIOS version.

C. Configuring a RAID array in RAID BIOS

Enter the RAID BIOS setup utility to configure a RAID array. Skip this step and proceed with the installation of Windows operating system for a non-RAID configuration.

Step 1:

After the POST memory test begins and before the operating system boot begins, look for a message which says "Press <Ctrl-I> to enter Configuration Utility" (Figure 2). Press <Ctrl> + <I> to enter the RAID Configuration Utility.

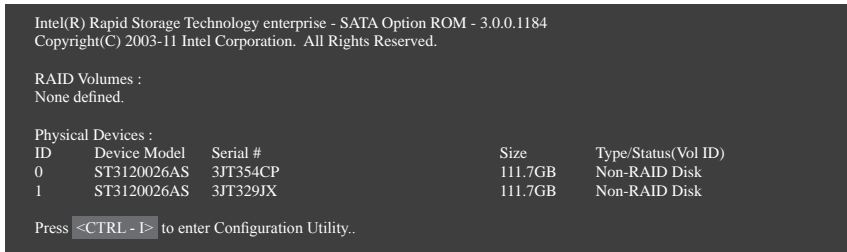

Figure 2

Step 2:

After you press <Ctrl> + <I>, the **MAIN MENU** screen will appear (Figure 3).

Create RAID Volume

If you want to create a RAID array, select **Create RAID Volume** in **MAIN MENU** and press <Enter>.

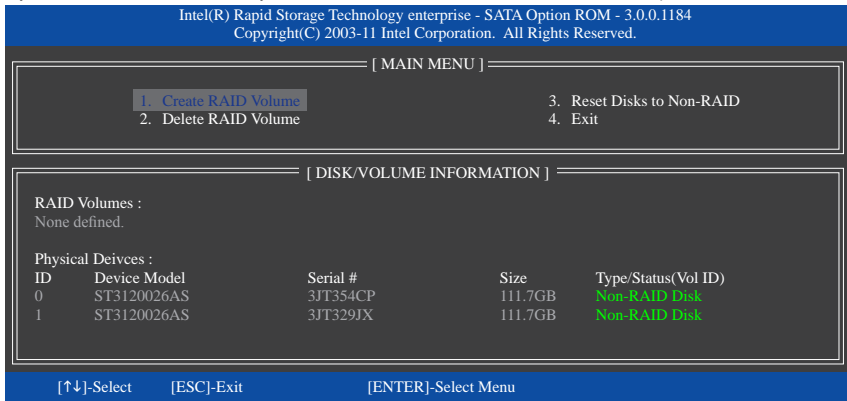

Figure 3

Step 3:

After entering the **CREATE VOLUME MENU** screen, enter a volume name with 1~16 letters (letters cannot be special characters) under the **Name** item and press <Enter>. Then, select a RAID level (Figure 4). RAID levels supported include RAID 0, RAID 1, RAID 10, and RAID 5 (the selections available depend on the number of the hard drives being installed). Press <Enter> to proceed.

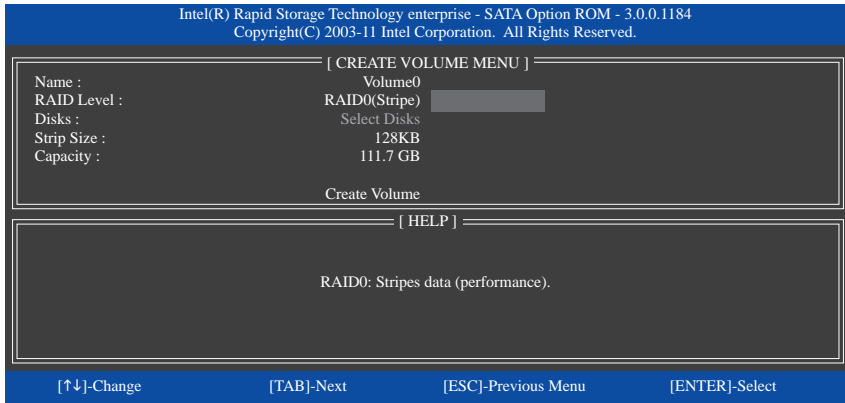

Figure 4

Step 4:

Under **Disks** item, select the hard drives to be included in the RAID array. If only two hard drives are installed, they will be automatically assigned to the array. Set the stripe block size (Figure 5) if necessary. The stripe block size can be set from 4 KB to 128 KB. Once you have selected the stripe block size, press <Enter>.

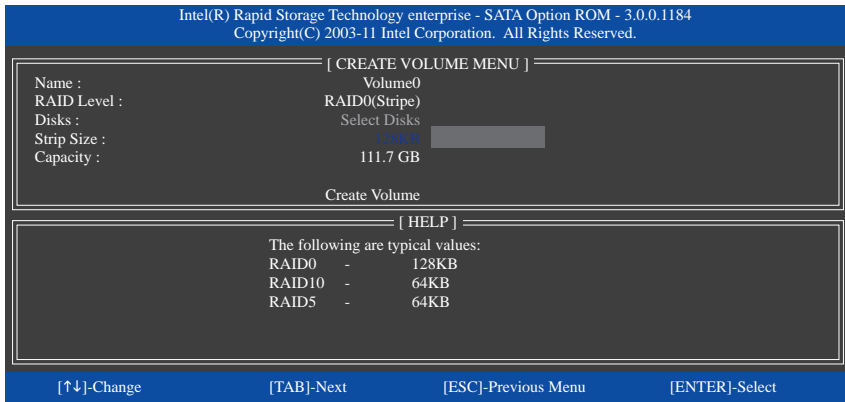

Figure 5

Step 5:

Enter the array capacity and press <Enter>. Finally press <Enter> on the **Create Volume** item to begin creating the RAID array. When prompted to confirm whether to create this volume, press <Y> to confirm or <N> to cancel (Figure 6).

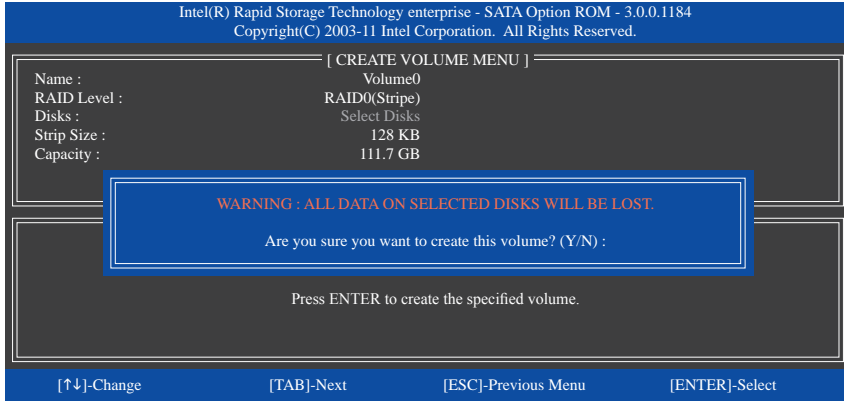

Figure 6

When completed, you can see detailed information about the RAID array in the **DISK/VOLUME INFORMATION** section, including the RAID level, stripe block size, array name, and array capacity, etc. (Figure 7)

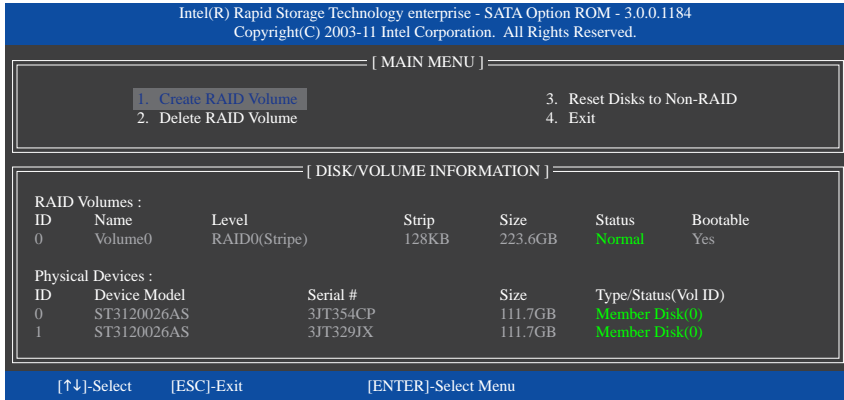

Figure 7

To exit the RAID BIOS utility, press <Esc> or select **4. Exit** in **MAIN MENU**.

Now, you can proceed to install the SATA RAID/AHCI driver and operating system.

Delete RAID Volume

To delete a RAID array, select **Delete RAID Volume** in **MAIN MENU** and press <Enter>. In the **DELETE VOLUME MENU** section, use the up or down arrow key to select the array to be deleted and press <Delete>. When prompted to confirm your selection (Figure 8), press <Y> to confirm or <N> to abort.

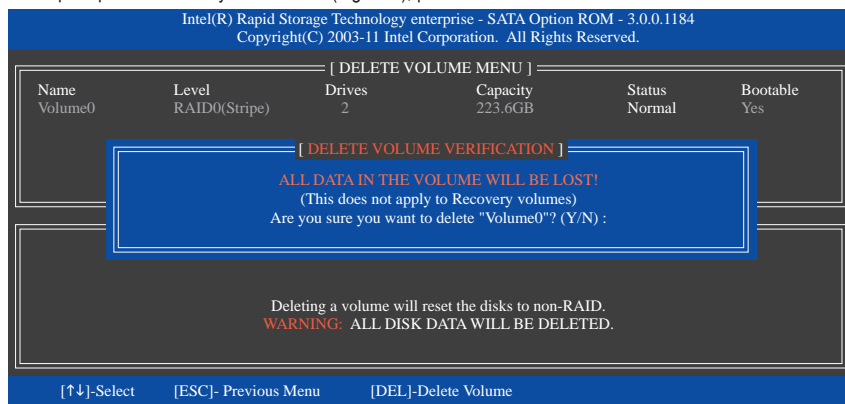

Figure 8

5-1-2 Configuring Marvell 88SE9172 SATA Controllers

A. Installing SATA hard drive(s) in your computer

Attach one end of the SATA signal cable to the rear of the SATA hard drive and the other end to available SATA port on the motherboard. The Marvell 88SE9172 SATA controllers control the onboard GSATA3 6/7/8/9 connectors and the eSATA ports on the back panel. Then connect the power connector from your power supply to the hard drive.

B. Configuring SATA controller and RAID mode in BIOS Setup

Make sure to configure the SATA controller mode correctly in system BIOS Setup.

Step 1:

Turn on your computer and press <Delete> to enter BIOS Setup during the POST. To create RAID, go to **Peripherals** and set **GSATA Controller** on the **Marvell ATA Controller Configuration** submenu to **RAID Mode** (Figure 2) (**AHCI mode** by default). If you do not want to create RAID, set this item to **IDE Mode** or **AHCI Mode**.



Figure 1



The BIOS Setup menus described in this section may differ from the exact settings for your motherboard. The actual BIOS Setup menu options you will see shall depend on the motherboard you have and the BIOS version.



Figure 2



The first **GSATA Controller** item controls the "GSATA3 6" and "GSATA3 7" connectors. The second **GSATA Controller** item controls the "GSATA3 8" and "GSATA3 9" connectors. The third **GSATA Controller** item controls the eSATA ports on the back panel.

Step 2:

Save changes and exit BIOS Setup.

C. Configuring a RAID array in RAID BIOS

Enter the RAID BIOS setup utility to configure a RAID array. Skip this step and proceed to the installation of Windows operating system for a non-RAID configuration.

After the POST memory test begins and before the operating system boot begins, look for a message which says "Press <Ctrl>+<M> to enter BIOS Setup or <Space> to continue" (Figure 3). Press <Ctrl> + <M> to enter the RAID setup utility.

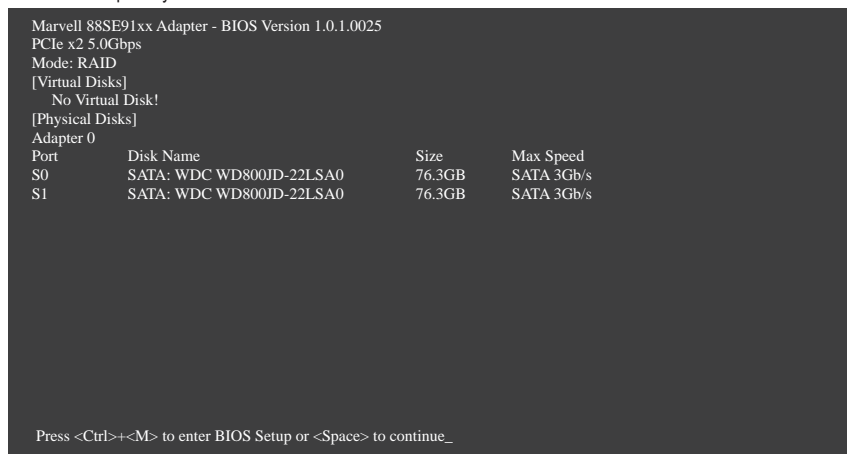

Figure 3

On the main screen of the RAID setup utility (Figure 4), use the left or right arrow key to move through tabs.

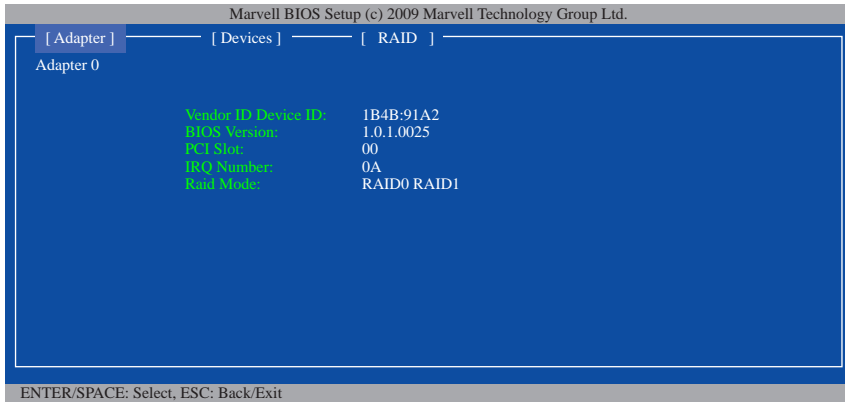

Figure 4

Create a RAID Array:

Step 1: On the main screen, press <Enter> on the RAID tab. Then the RAID Config menu appears (Figure 5). Press <Enter> on the Create VD item.

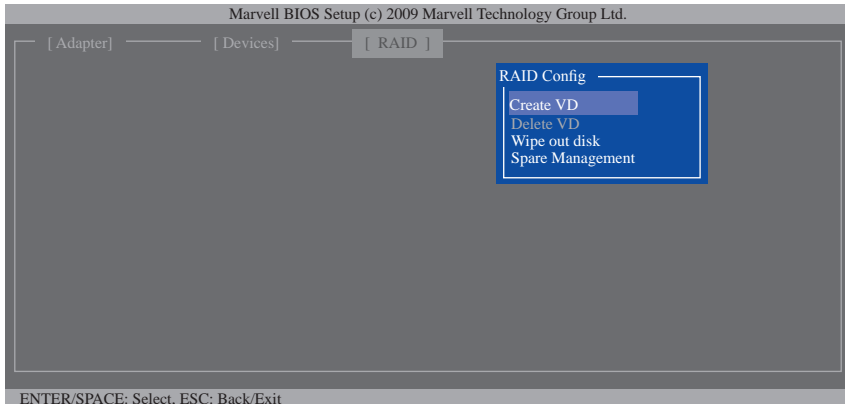

Figure 5

Step 2: The next screen displays the two hard drives you installed. Press <Enter> or <Space> on the two hard drives respectively to add them into the RAID array. Selected hard drives are marked with an asterisk (Figure 6). Then press <Enter> on **NEXT**.

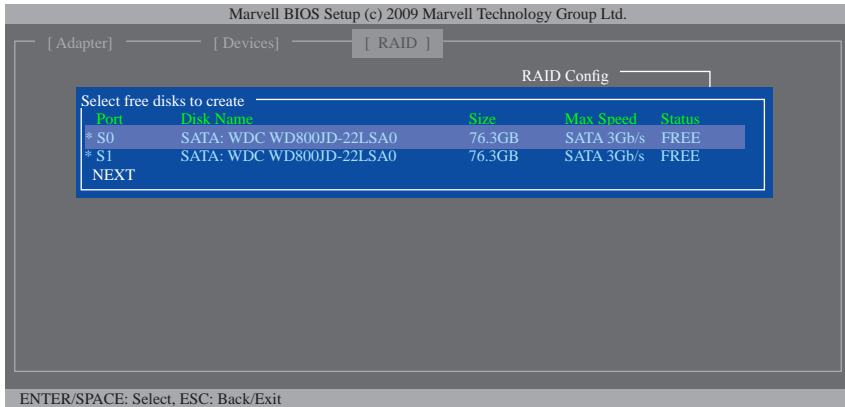

Figure 6

Step 3: On the **Create VD** menu (Figure 7), use the up or down arrow key to move the selection bar to select an item and press <Enter> to display options. Set the required items in sequence and press the down arrow key to proceed to the next item.

Sequence:

1. **RAID Level:** Select a RAID level. Options include RAID 0 (Stripe) and RAID 1 (Mirror).
2. **Stripe Size:** Select the stripe block size. Options include 32 KB, 64 KB, and 128 KB.
3. **Quick Init:** Select whether to quickly erase old data on the hard drives when creating the array.
4. **Cache Mode:** Select write-back or write-through cache.
5. **VD Name:** Enter an array name with 1~10 letters (letters cannot be special characters).

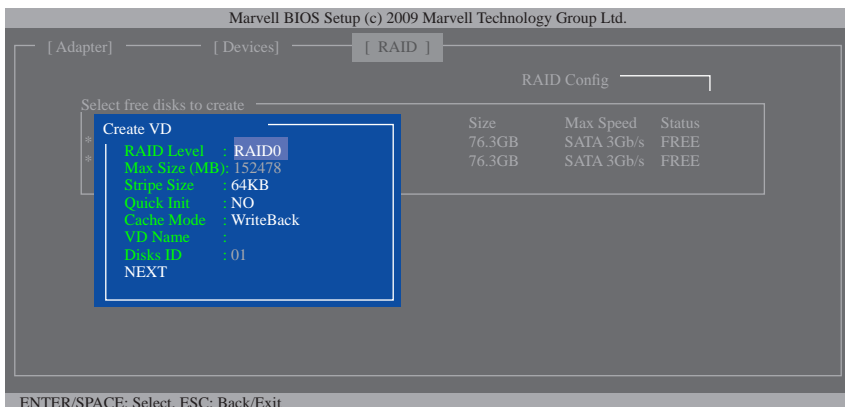

Figure 7

6. **NEXT**: After completing the settings above, move to **NEXT** and press <Enter> to begin creating the array. When prompted to confirm, press <Y> to confirm or <N> to cancel (Figure 8).

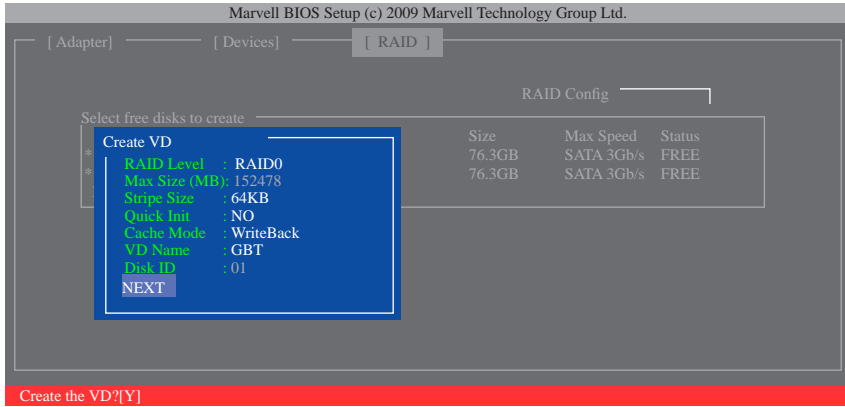

Figure 8

When completed, the **RAID** tab will display the new array. (Figure 9)

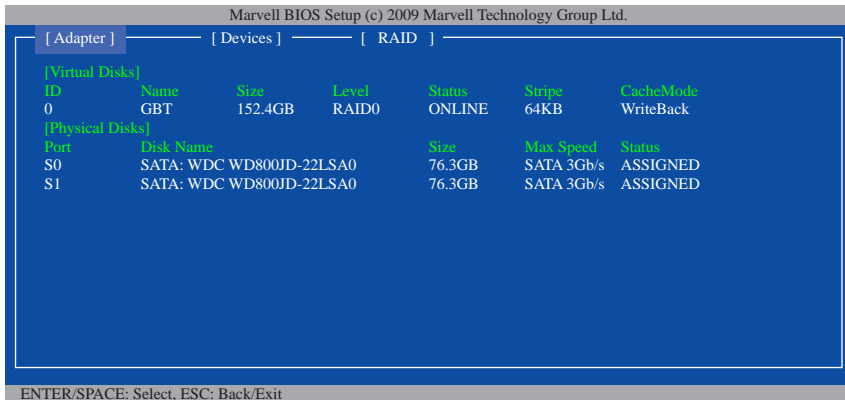

Figure 9

To exit the RAID BIOS utility, press <Esc> on the main screen and press <Y> to confirm. Now, you can proceed to install the operating system.

Delete the RAID Array:

To delete the existing array, press <Enter> on the **RAID** tab and select **Delete VD**. When the **Delete VD** menu appears, press <Enter> on the array to select it and then press <Enter> on **NEXT**. When prompted, press <Y> to confirm (Figure 10). When the message "Do you want to delete the VD's MBR?" appears, press <Y> to clear the MBR or press other keys to ignore.

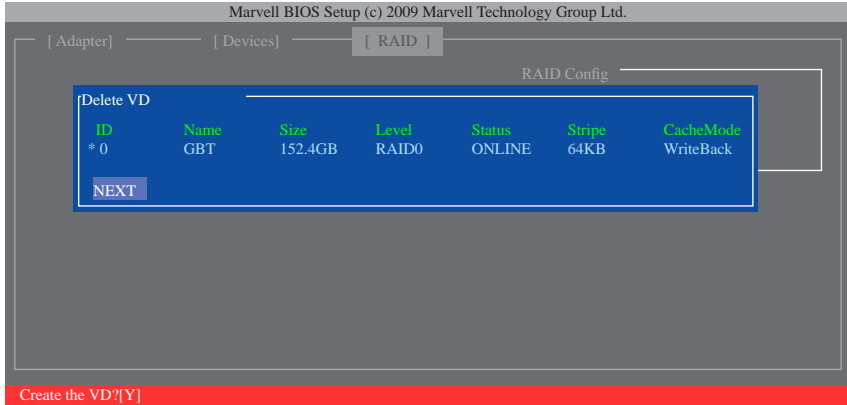

Figure 10

Use the Marvell Storage Utility in the Operating System:

With the Marvell Storage utility, you can set up an array or view the current array status in the operating system. To install the utility, insert the motherboard driver disk, then go to **Application Software\Install Application Software** and select **Marvell Storage Utility** to install. Note: After the installation, you must login the utility with the same account name and password that you use to login the operating system. If you did not set the account password before, click **Login** to enter the Marvell Storage Utility directly. Please note that if you set the hard drive(s) to IDE or AHCI mode, it is normal that you will not see the hard drive(s) in the Marvell Storage Utility.

5-1-3 Installing the SATA RAID/AHCI Driver and Operating System

With the correct BIOS settings, you are ready to install the operating system.

A. Installing Windows 7/Vista

(The following instructions use Windows 7 as the example operating system.)

Step 1:

Boot from the Windows 7/Vista setup disk and perform standard OS installation steps. When you arrive at the "Where do you want to install Windows?" screen, select **Load Driver**.

Step 2:

Insert the motherboard driver disk and then browse to the location of the driver. The locations of the drivers are as follows:

For the Intel X79:

RAID/AHCI driver for Windows 32-Bit: \BootDrv\IRSTe\32Bit

RAID/AHCI driver for Windows 64-Bit: \BootDrv\IRSTe\64Bit

For the Marvell 88SE9172:

RAID driver for Windows 32-bit: \BootDrv\Marvell\RAID\i386

RAID driver for Windows 64-bit: \BootDrv\Marvell\RAID\amd64

AHCI driver for Windows 32-bit: \BootDrv\Marvell\AHCI\Floppy32

AHCI driver for Windows 64-bit: \BootDrv\Marvell\AHCI\Floppy64

Step 3:

For Intel X79, select **Intel(R) C600 Series Chipset SATA RAID Controller** (Figure 1). For Marvell 88SE9172, select **Marvell 91xx SATA 6G RAID Controller** (Figure 2). Click **Next** to load the driver and continue the OS installation.

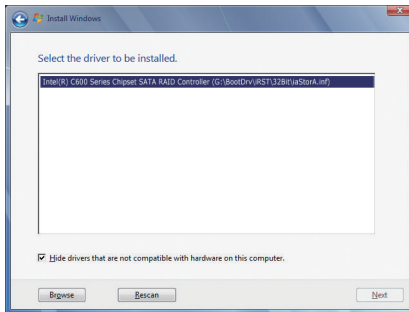

Figure 1

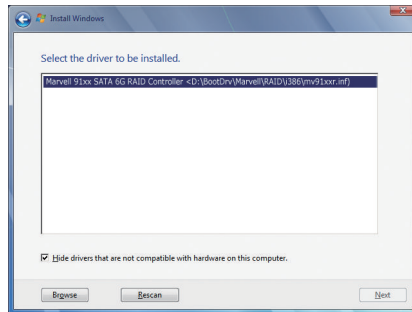

Figure 2

B. Installing Windows XP (For the Marvell 88SE9172) ^(Note)

Before installing Windows XP, connect a USB floppy disk drive to your computer first because you need to install the SATA RAID/AHCI driver from a floppy disk that contains the driver during the OS installation. Without the driver, the hard drive(s) may not be recognized during the Windows setup process. First, copy the driver from the motherboard driver disk to a floppy disk. Refer to the methods below.

Method A:

- For RAID mode, copy all files in the **BootDrv\Marvell\RAID\Floppy32** folder to your floppy disk. To install Windows 64-Bit, copy the files in the **Floppy64** folder.
- For AHCI mode, depending on whether you want to install the 32- or 64-bit version, copy the files in the **AHCI\Floppy32** or **AHCI\Floppy64** folder.

Method B:

Steps:

- 1: Use an alternative system and insert the motherboard driver disk.
- 2: From your optical drive folder, double click the **Menu.exe** file in the **BootDrv** folder. A Command Prompt window will open similar to that in Figure 3.
- 3: Insert the blank formatted disk (if you're using a USB floppy disk drive, make sure it is designated as drive A). Select the controller driver by pressing the corresponding letter from the menu and press <Enter>. For example, from the menu in Figure 3, select **7) Marvell RAID driver**. (For AHCI drive(s), select **Marvell AHCI driver**.)

Your system will then automatically copy the driver files to the floppy disk. Press any key to exit when finished.

```
1>Intel Matrix Storage driver for 32bit system
2>Intel Matrix Storage driver for 64bit system
3>1GIBYTE SATA driver for 32bit system
4>1GIBYTE SATA driver for 64bit system
5>Marvell AHCI driver for 32bit system
6>Marvell AHCI driver for 64bit system
7>Marvell RAID driver
8>Intel Rapid Storage driver for 32bit system
9>Intel Rapid Storage driver for 64bit system
0>exit
=
```

Figure 3

(Note) The X79 SATA RAID/AHCI driver does not support Windows XP.

Refer to the following for installing the driver during the Windows setup process.

Step 1:

Restart your system to boot from the Windows XP setup disk and press <F6> as soon as you see the message "Press F6 if you need to install a 3rd party SCSI or RAID driver." A screen will then appear asking you to specify an additional SCSI adapter. Press <S>.

Step 2:

Insert the floppy disk containing the SATA RAID/AHCI driver and press <Enter>. Select either the 32-bit or 64-bit items depending on whether you want to install the 32-bit or 64-bit version of Windows XP (Figure 4). Both of the **Marvell shared library** and **Marvell 91xx SATA Controller** need to be installed. Below we assume that you are installing the 32-bit version. First select **Marvell shared library for 32bit (install first)** and press <Enter>. On the next screen, press <S> to return to the screen in Figure 4. Then select **Marvell 91xx SATA Controller 32bit Driver** and press <Enter>. When both of the two drivers appear on the confirmation screen, press <Enter> to continue the driver installation.

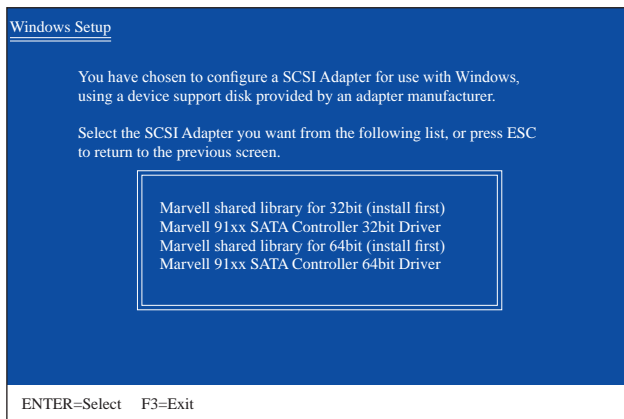

Figure 4

Step 3:

On the next screen, press <Enter> to continue the driver installation. After the driver installation, you can proceed with the Windows XP installation.

C. Rebuilding an Array

Rebuilding is the process of restoring data to a hard drive from other drives in the array. Rebuilding applies only to fault-tolerant arrays such as RAID 1, RAID 5, and RAID 10 arrays. The procedures below assume a new drive is added to replace a failed drive to rebuild a RAID 1 array. (Note: The new drive must have equal or greater capacity than the old one.)

For the Intel X79:

Turn off your computer and replace the failed hard drive with a new one. Restart your computer.

- **Enabling Automatic Rebuild**

Step 1:

When the message "Press <Ctrl-I> to enter Configuration Utility" appears, press <Ctrl> + <I> to enter the RAID Configuration Utility. The following screen appears after you enter the RAID Configuration Utility.

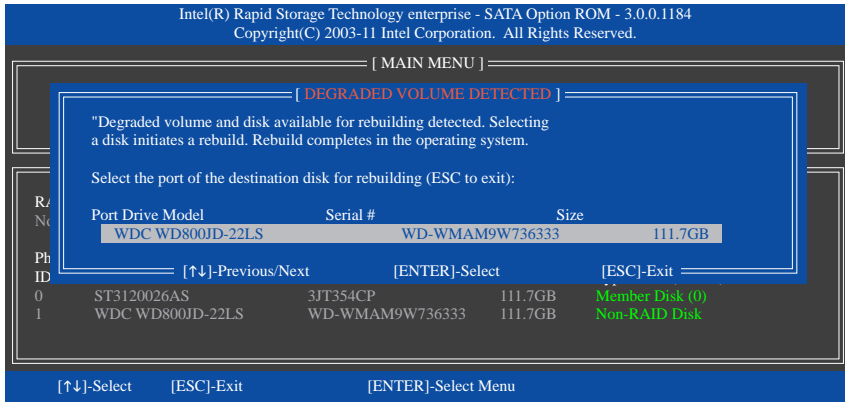

Step 2:

Select the new hard drive to add into the array to be rebuilt and press <Enter>. The following screen appears, indicating that an automatic rebuild will be performed after you enter the operating system. You can access **Intel Rapid Storage Technology enterprise** from **All Programs** in the **Start** menu. You will see that the status of the array displays as **Rebuilding**. If you do not enable automatic rebuild on this stage, you have to manually rebuild the array in the operating system (see the next page for more details).

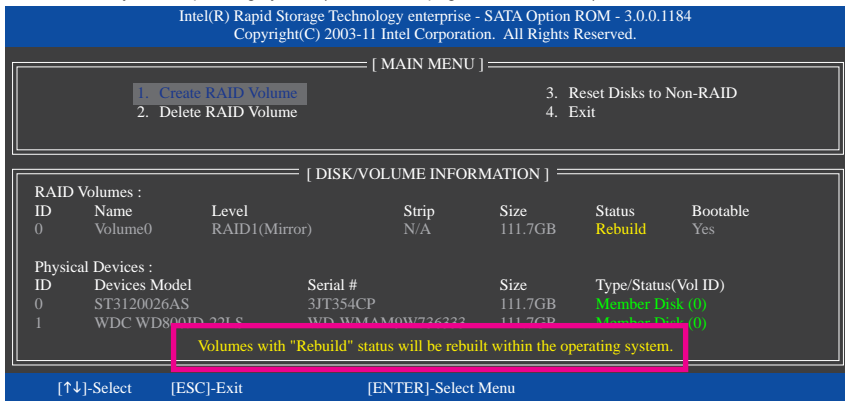

- **Performing the Rebuild in the Operating System**

While in the operating system, make sure the Chipset driver and **Intel Rapid Storage Technology Enterprise RAID Port Drivers** have been installed from the motherboard driver disk. Then launch **Intel Rapid Storage Technology enterprise** from **All Programs** in the **Start** menu.

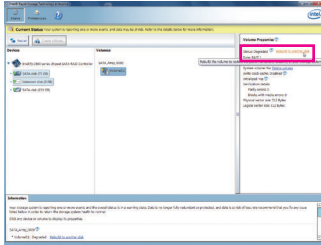

Step 1:

On the right panel of the screen, click **Rebuild** to another disk under **Volume Properties**.

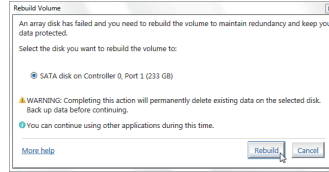

Step 2:

Select a new drive to rebuild the RAID and click **Rebuild**.

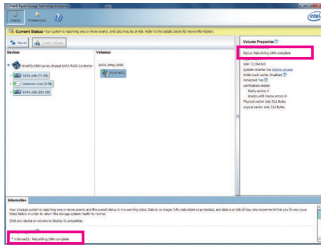

The **Status** item on the right of the screen and the **Information** section on the bottom display the rebuild progress.

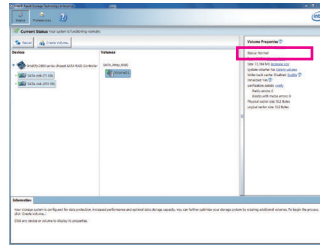

Step 3:

After the RAID volume rebuilding, the **Status** will display as **Normal**.

For the Marvell 88SE9172:

Turn off your computer and replace the failed hard drive with a new one. Restart your computer. To enable an automatic rebuild in the operating system, you have to set the new hard drive as a Spare drive in the RAID setup utility first.

- **Enabling Automatic Rebuild**

Step 1:

When the message "Press <Ctrl>+<M> to enter BIOS Setup or <Space> to continue" appears, press <Ctrl> + <M> to enter the RAID setup utility. On the main screen, press <Enter> on the **RAID** tab and then press <Enter> on **Spare Management**.



Step 2:

The new hard drive will be displayed on the screen. Press <Enter> or <Space> on the new hard drive to select it and then press <Enter> on **NEXT**. When prompted, press <Y> to confirm. The new hard drive is now set as a Spare drive.

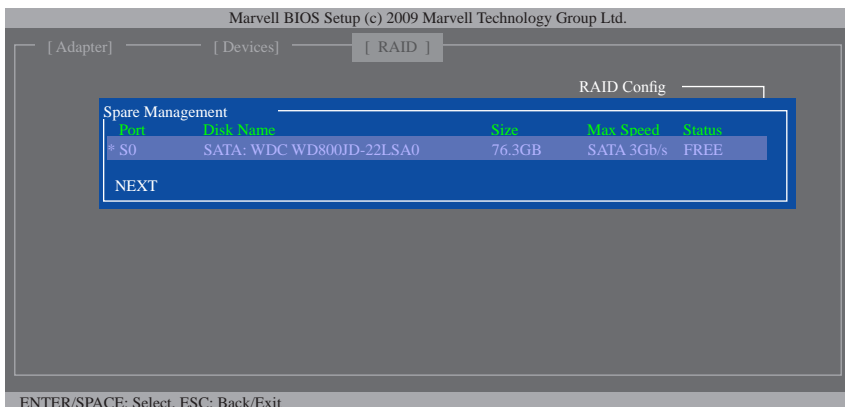

Step 3:

Make sure you have installed the Marvell RAID driver and Marvell Storage Utility from the motherboard driver disk. While in the operating system, launch the Marvell Storage Utility from Start/All Programs/Marvell Storage Utility/Marvell Tray, right-click on the  icon in the notification area, and select **Open MSU**. Then login the Marvell Storage Utility.

Under **Virtual Disk 0**, the **Property** tab displays the rebuild progress on the right of the **Background Activity Progress** item, indicating that the RAID volume is being rebuilt. When completed, the status will display as **Done**.

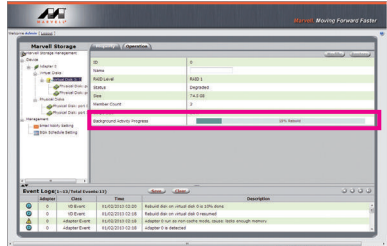

- **Manually Rebuilding RAID 1 in the Operating System**

You can manually rebuild a RAID 1 array without setting the new hard drive as a Spare drive in the RAID setup utility first. While in the operating system, open the Marvell Storage Utility and login.

Step 1:

Under **Virtual Disk 0**, click the **Operation** tab and select **Rebuild**.

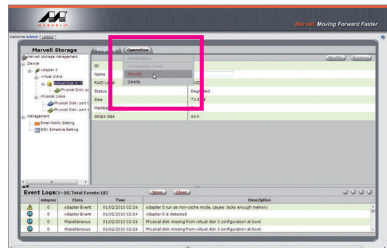

Step 2:

The screen will display the new hard drive. Click on the hard drive to select it and click the **Submit** button to begin the rebuild.

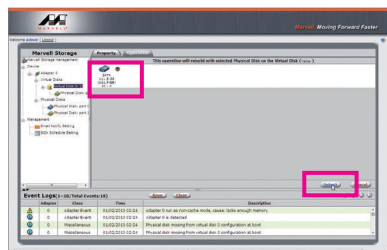

5-2 Configuring Audio Input and Output

5-2-1 Configuring 2/4/5.1/7.1-Channel Audio

The motherboard provides six audio jacks on the back panel which support 2/4/5.1/7.1-channel ^(Note) audio. The picture to the right shows the default audio jack assignments.



The integrated HD (High Definition) audio provides jack retasking capability that allows the user to change the function for each jack through the audio driver.

For example, in a 4-channel audio configuration, if a Side speaker is plugged into the default Center/Subwoofer speaker out jack, you can retask the Center/Subwoofer speaker out jack to be Side speaker out.



- To install a microphone, connect your microphone to the Mic in jack and manually configure the jack for microphone functionality.
- Audio signals will be present on both of the front and back panel audio connections simultaneously. If you want to mute the back panel audio (only supported when using an HD front panel audio module), refer to instructions on the next page.

High Definition Audio (HD Audio)

HD Audio includes multiple high quality digital-to-analog converters (DACs) that support 44.1KHz/48KHz/96KHz/192KHz sampling rate. HD Audio features multistreaming capabilities that allow multiple audio streams (in and out) to be simultaneously processed. For example, users can listen to MP3 music, have an Internet chat, make a telephone call over the Internet, and etc. all at the same time.

A. Configuring Speakers

(The following instructions use Windows 7 as the example operating system.)

Step 1:

After installing the audio driver, the **HD Audio Manager** icon  will appear in the notification area. Double-click the icon to access the **HD Audio Manager**.

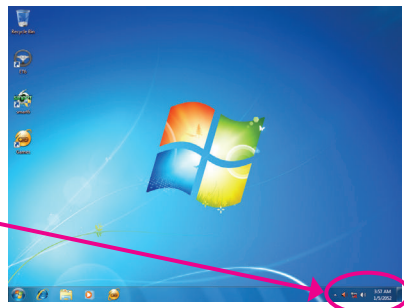

(Note) 2/4/5.1/7.1-Channel Audio Configurations:

Refer to the following for multi-channel speaker configurations.

- 2-channel audio: Headphone or Line out.
- 4-channel audio: Front speaker out and Side speaker out.
- 5.1-channel audio: Front speaker out, Side speaker out, and Center/Subwoofer speaker out.
- 7.1-channel audio: Front speaker out, Rear speaker out, Center/Subwoofer speaker out, and Side speaker out.

Step 2:

Connect an audio device to an audio jack. The **The current connected device is** dialog box appears. Select the device according to the type of device you connect. Then click **OK**.

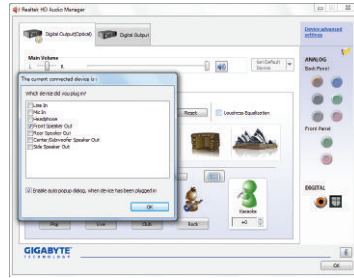

Step 3:

On the **Speakers** screen, click the **Speaker Configuration** tab. In the **Speaker Configuration** list, select **Stereo**, **Quadraphonic**, **5.1 Speaker**, or **7.1 Speaker** according to the type of speaker configuration you wish to set up. Then the speaker setup is completed.

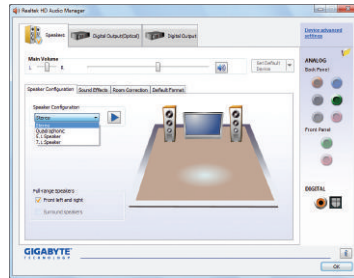

B. Configuring Sound Effect

You may configure an audio environment on the **Sound Effects** tab.

C. Activating an AC'97 Front Panel Audio Module

If your chassis provides an AC'97 front panel audio module, to activate the AC'97 functionality, click the tool icon on the **Speaker Configuration** tab. On the **Connector Settings** dialog box, select the **Disable front panel jack detection** check box. Click **OK** to complete.

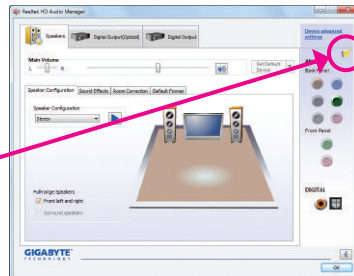
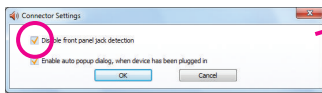

D. Muting the Back Panel Audio (For HD Audio Only)

Click **Device advanced settings** on the top right corner on the **Speaker Configuration** tab to open the **Device advanced settings** dialog box. Select the **Mute the rear output device, when a front headphone plugged in** check box. Click **OK** to complete.

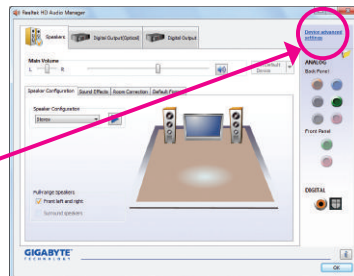
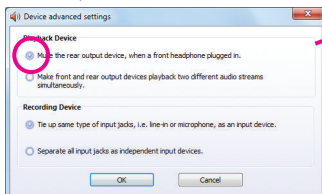

5-2-2 Configuring S/PDIF Out

The S/PDIF Out jacks can transmit audio signals to an external decoder for decoding to get the best audio quality.

1. Connecting a S/PDIF Out Cable:

Connect a S/PDIF coaxial cable or a S/PDIF optical cable (either one) to the corresponding S/PDIF out connector as shown below and an external decoder for transmitting the S/PDIF digital audio signals.

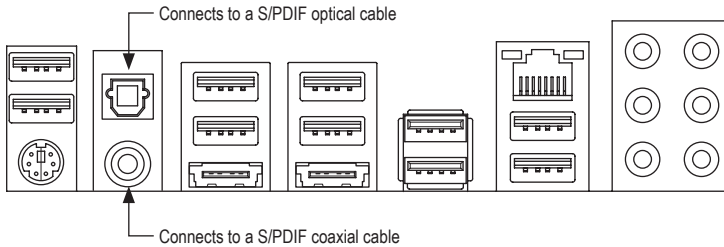

2. Configuring S/PDIF Out:

On the **Digital Output(Optical)** screen (Note), click the **Default Format** tab and then select the sample rate and bit depth. Click **OK** to complete.

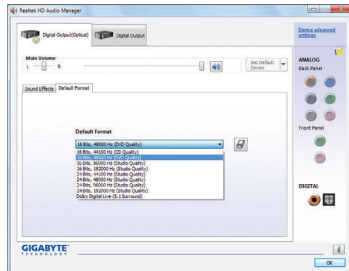

(Note) Enter the **Digital Output(Optical)** screen to configure further settings if you use the S/PDIF Out connector(s) on the back panel for digital audio output or enter the **Digital Output** screen if you use the internal S/PDIF Out connector (SPDIF_O) for digital audio output.

5-2-3 Enabling the Dolby Home Theater Function



Before Dolby Home Theater is enabled, you get only 2-channel playback output (from the front speakers) when playing 2-channel stereo sources. You must play 4-, 5.1-, or 7.1- channel content to get 4-, 5.1-, or 7.1- channel audio effects. With Dolby Home Theater enabled, 2-channel stereo content will be transformed into multi-channel audio, creating a virtual surround sound environment.

Step 1:

The **Dolby Home Theater** icon  will appear in the notification area. Click the icon to access the **Dolby Home Theater**.

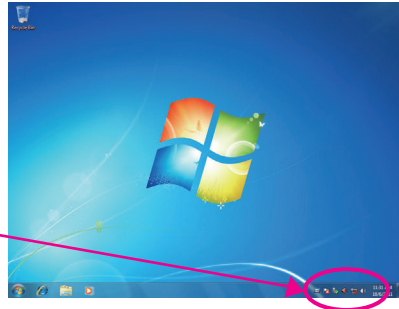

Step 2:

Click the **Customize** button on the **Dolby Home Theater** panel to open advanced settings.



5-2-4 Configuring Microphone Recording

Step 1:

After installing the audio driver, the **HD Audio Manager** icon will appear in the notification area. Double-click the icon to access the **HD Audio Manager**.

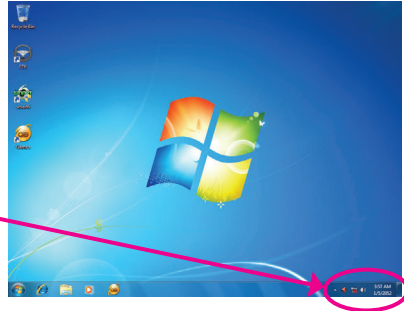

Step 2:

Connect your microphone to the Mic in jack (pink) on the back panel or the Mic in jack (pink) on the front panel. Then configure the jack for microphone functionality. Note: The microphone functions on the front panel and back panel cannot be used at the same time.

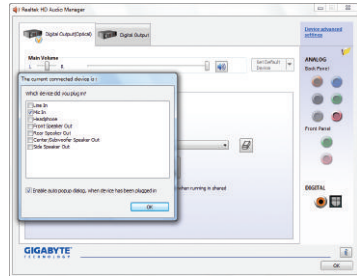

Step 3:

Go to the **Microphone** screen. Do not mute the recording volume, or you'll not be able to record the sound. To hear the sound being recorded during the recording process, do not mute the playback volume. It is recommended that you set the volumes at a middle level.

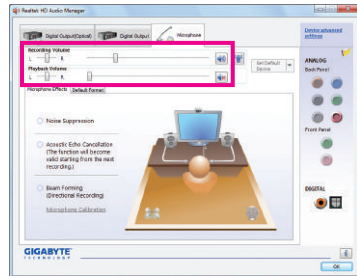

Step 4:

To raise the recording and playback volume for the microphone, click the **Microphone Boost** icon on the right of the **Recording Volume** slider and set the Microphone Boost level.

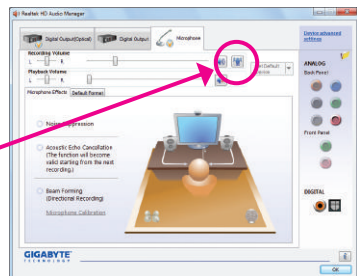
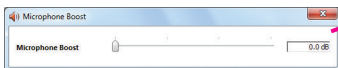

Step 5:

After completing the settings above, click **Start**, point to **All Programs**, point to **Accessories**, and then click **Sound Recorder** to begin the sound recording.

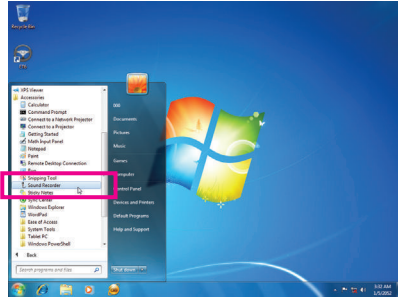

* Enabling Stereo Mix

If the HD Audio Manager does not display the recording device you wish to use, refer to the steps below. The following steps explain how to enable Stereo Mix (which may be needed when you want to record sound from your computer).

Step 1:

Locate the  icon in the notification area and right-click on this icon. Select **Recording Devices**.

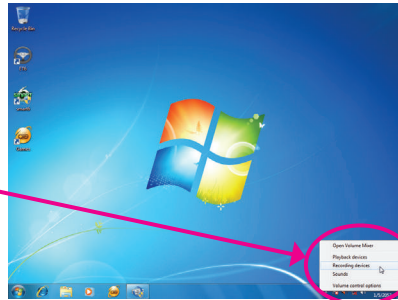

Step 2:

On the **Recording** tab, right-click on an empty space and select **Show Disabled Devices**.

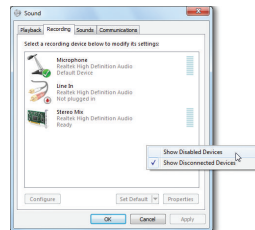

Step 3:

When the **Stereo Mix** item appears, right-click on this item and select **Enable**. Then set it as the default device.

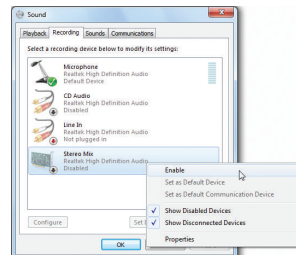

Step 4:

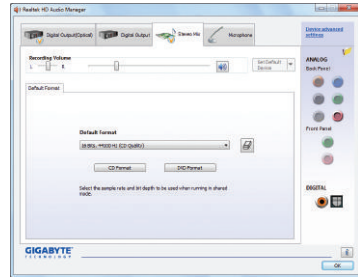

Now you can access the **HD Audio Manager** to configure **Stereo Mix** and use **Sound Recorder** to record the sound.

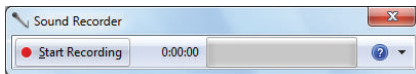

5-2-5 Using the Sound Recorder



A. Recording Sound

1. Make sure you have connected the sound input device (e.g. microphone) to the computer.
2. To record the audio, click the **Start Recording** button .
3. To stop recording audio, click the **Stop Recording** button .

Be sure to save the recorded audio file upon completion.

B. Playing the Recorded Sound

You can play your recording in a digital media player program that supports your audio file format.

5-3 Troubleshooting

5-3-1 Frequently Asked Questions

To read more FAQs for your motherboard, please go to the **Support & Downloads\FAQ** page on GIGABYTE's website.

Q: In the BIOS Setup program, why are some BIOS options missing?

A: Some advanced options are hidden in the BIOS Setup program. Press <Delete> to enter BIOS Setup during the POST. In the Main Menu, press <Ctrl>+<F1> to show the advanced options.

Q: Why is the light of my keyboard/optical mouse still on after the computer shuts down?

A: Some motherboards provide a small amount of standby power after the computer shuts down and that's why the light is still on.

Q: How do I clear the CMOS values?

A: For motherboards that have a CMOS_SW button, press this button to clear the CMOS values (before doing this, please turn off the computer and unplug the power cord). For motherboards that have a clearing CMOS jumper, refer to the instructions on the CLR_CMOS jumper in Chapter 1 to short the jumper to clear the CMOS values. If your board doesn't have this jumper, refer to the instructions on the motherboard battery in Chapter 1. You can temporarily remove the battery from the battery holder to stop supplying power to the CMOS, which will clear the CMOS values after about one minute.

Q: Why do I still get a weak sound even though I have turned my speaker to the maximum volume?

A: Make sure your speaker is equipped with an internal amplifier. If not, try a speaker with power/amplifier.

Q: Why cannot I install the onboard HD audio driver successfully? (For Windows XP only)

A: Step 1: First, make sure Service Pack 1 or Service Pack 2 has been installed (check in My Computer > Properties > General > System). If not, please update it from Microsoft's website. Then make sure the Microsoft UAA Bus Driver for High Definition Audio has been installed successfully (check in My Computer > Properties > Hardware > Device Manager > System Devices).

Step 2: Check if **Audio Device on High Definition Audio Bus** or **Unknown device** is present in **Device Manager** or **Sound, video, and game controllers**. If yes, please disable this device. (If not, skip this step.)

Step 3: Then go back to My Computer > Properties > Hardware > Device Manager > System devices and right-click on **Microsoft UAA Bus Driver for High Definition Audio** and select **Disable** and **Uninstall**.

Step 4: In **Device Manager**, right-click on the computer name and select **Scan for hardware changes**. When the **Add New Hardware Wizard** appears, click **Cancel**. Then install the onboard HD audio driver from the motherboard driver disk or download the audio driver from GIGABYTE's website to install.

For more details, go to the **Support & Downloads\FAQ** page on our website and search for "onboard HD audio driver."

5-3-2 Troubleshooting Procedure

If you encounter any troubles during system startup, follow the troubleshooting procedure below to solve the problem.

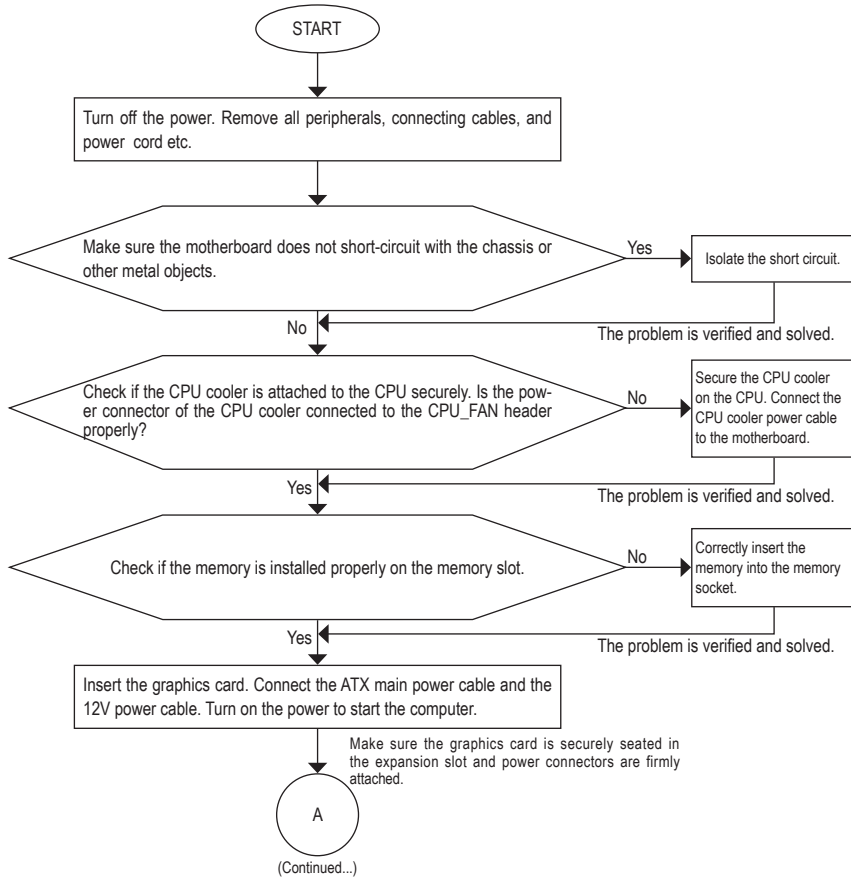

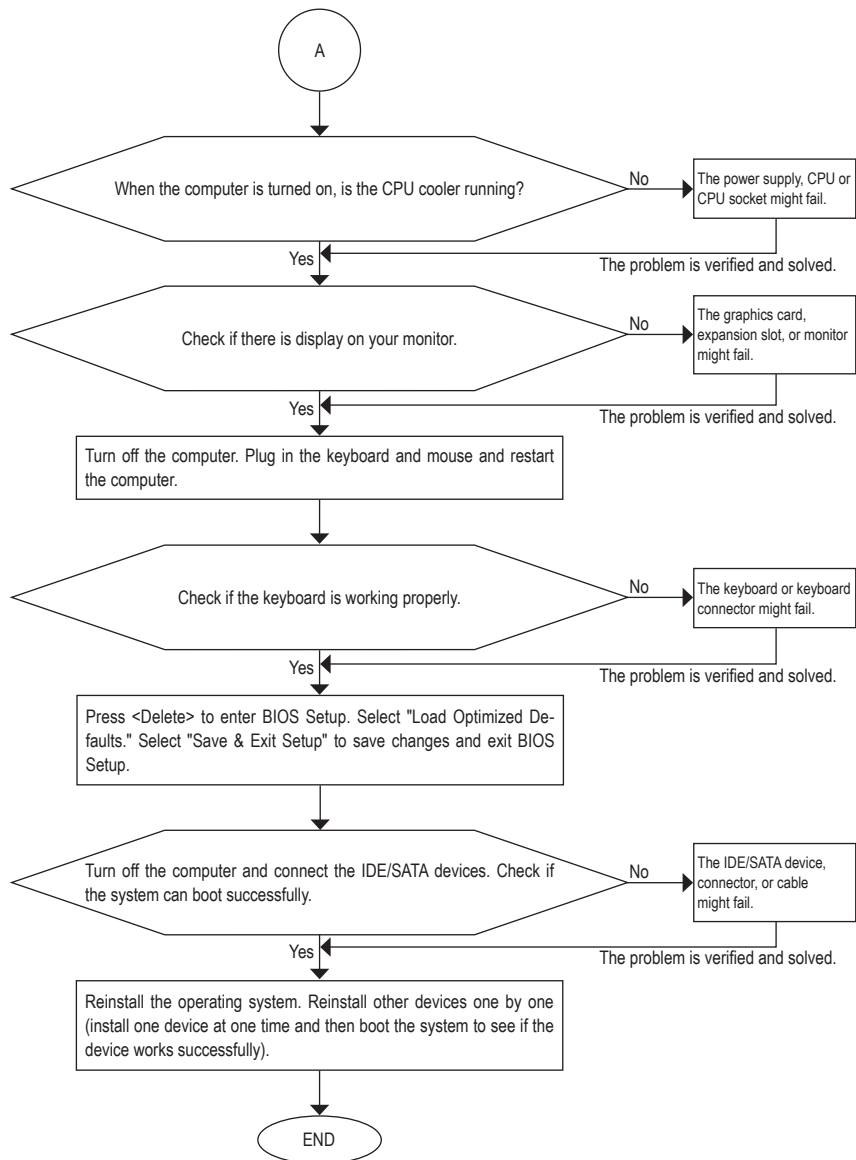

If the procedure above is unable to solve your problem, contact the place of purchase or local dealer for help. Or go to the **Support & Downloads\Technical Support** page to submit your question. Our customer service staff will reply you as soon as possible.

5-3-3 Regulatory Statements

Regulatory Notices

This document must not be copied without our written permission, and the contents there of must not be imparted to a third party nor be used for any unauthorized purpose. Contravention will be prosecuted. We believe that the information contained herein was accurate in all respects at the time of printing. GIGABYTE cannot, however, assume any responsibility for errors or omissions in this text. Also note that the information in this document is subject to change without notice and should not be construed as a commitment by GIGABYTE.

Our Commitment to Preserving the Environment

In addition to high-efficiency performance, all GIGABYTE motherboards fulfill European Union regulations for RoHS (Restriction of Certain Hazardous Substances in Electrical and Electronic Equipment) and WEEE (Waste Electrical and Electronic Equipment) environmental directives, as well as most major worldwide safety requirements. To prevent releases of harmful substances into the environment and to maximize the use of our natural resources, GIGABYTE provides the following information on how you can responsibly recycle or reuse most of the materials in your "end of life" product.

Restriction of Hazardous Substances (RoHS) Directive Statement

GIGABYTE products have not intended to add and safe from hazardous substances (Cd, Pb, Hg, Cr+6, PBDE and PBB). The parts and components have been carefully selected to meet RoHS requirement. Moreover, we at GIGABYTE are continuing our efforts to develop products that do not use internationally banned toxic chemicals.

Waste Electrical & Electronic Equipment (WEEE) Directive Statement

GIGABYTE will fulfill the national laws as interpreted from the 2002/96/EC WEEE (Waste Electrical and Electronic Equipment) directive. The WEEE Directive specifies the treatment, collection, recycling and disposal of electric and electronic devices and their components. Under the Directive, used equipment must be marked, collected separately, and disposed of properly.

WEEE Symbol Statement

The symbol shown below is on the product or on its packaging, which indicates that this product must not be disposed of with other waste. Instead, the device should be taken to the waste collection centers for activation of the treatment, collection, recycling and disposal procedure. The separate collection and recycling of your waste equipment at the time of disposal will help to conserve natural resources and ensure that it is recycled in a manner that protects human health and the environment. For more information about where you can drop off your waste equipment for recycling, please contact your local government office, your household waste disposal service or where you purchased the product for details of environmentally safe recycling.



- When your electrical or electronic equipment is no longer useful to you, "take it back" to your local or regional waste collection administration for recycling.
- If you need further assistance in recycling, reusing in your "end of life" product, you may contact us at the Customer Care number listed in your product's user's manual and we will be glad to help you with your effort.

Finally, we suggest that you practice other environmentally friendly actions by understanding and using the energy-saving features of this product (where applicable), recycling the inner and outer packaging (including shipping containers) this product was delivered in, and by disposing of or recycling used batteries properly. With your help, we can reduce the amount of natural resources needed to produce electrical and electronic equipment, minimize the use of landfills for the disposal of "end of life" products, and generally improve our quality of life by ensuring that potentially hazardous substances are not released into the environment and are disposed of properly.



Contact Us

- **GIGA-BYTE TECHNOLOGY CO., LTD.**

Address: No.6, Bao Chiang Road, Hsin-Tien Dist.,
New Taipei City 231, Taiwan

TEL: +886-2-8912-4000

FAX: +886-2-8912-4005

Tech. and Non-Tech. Support (Sales/Marketing) :

<http://esupport.gigabyte.com>

WEB address (English): <http://www.gigabyte.com>

WEB address (Chinese): <http://www.gigabyte.tw>

- **G.B.T. INC. - U.S.A.**

TEL: +1-626-854-9338

FAX: +1-626-854-9326

Tech. Support: <http://esupport.gigabyte.com>

Warranty Info: <http://rma.gigabyte.us>

Web address: <http://www.gigabyte.us>

- **G.B.T. INC (USA) - Mexico**

Tel: +1-626-854-9338 x 215 (Soporte de habla hispano)

FAX: +1-626-854-9326

Correo: soporte@gigabyte-usa.com

Tech. Support: <http://rma.gigabyte.us>

Web address: <http://latam.giga-byte.com>

- **Giga-Byte SINGAPORE PTE. LTD. - Singapore**

WEB address : <http://www.gigabyte.sg>

- **Thailand**

WEB address : <http://th.giga-byte.com>

- **Vietnam**

WEB address : <http://www.gigabyte.vn>

- **NINGBO G.B.T. TECH. TRADING CO., LTD. - China**

WEB address : <http://www.gigabyte.cn>

- Shanghai**

TEL: +86-21-63400912

FAX: +86-21-63400682

- Beijing**

TEL: +86-10-62102838

FAX: +86-10-62102848

- Wuhan**

TEL: +86-27-87685981

FAX: +86-27-87579461

- GuangZhou**

TEL: +86-20-87540700

FAX: +86-20-87544306

- Chengdu**

TEL: +86-28-85483135

FAX: +86-28-85256822

- Xian**

TEL: +86-29-85531943

FAX: +86-29-85510930

- Shenyang**

TEL: +86-24-83992342

FAX: +86-24-83992102

- **GIGABYTE TECHNOLOGY (INDIA) LIMITED - India**

WEB address : <http://www.gigabyte.in>

- **Saudi Arabia**

WEB address : <http://www.gigabyte.com.sa>

- **Gigabyte Technology Pty. Ltd. - Australia**

WEB address : <http://www.gigabyte.com.au>

- **G.B.T. TECHNOLOGY TRADING GMBH - Germany**

WEB address : <http://www.gigabyte.de>

- **G.B.T. TECH. CO., LTD. - U.K.**

WEB address : <http://www.giga-byte.co.uk>

- **Giga-Byte Technology B.V. - The Netherlands**

WEB address : <http://www.giga-byte.nl>

- **GIGABYTE TECHNOLOGY FRANCE - France**

WEB address : <http://www.gigabyte.fr>

- **Sweden**

WEB address : <http://www.gigabyte.se>

- **Italy**

WEB address : <http://www.giga-byte.it>

- **Spain**

WEB address : <http://www.giga-byte.es>

- **Greece**

WEB address : <http://www.gigabyte.com.gr>

- **Czech Republic**

WEB address : <http://www.gigabyte.cz>

- **Hungary**

WEB address : <http://www.giga-byte.hu>

- **Turkey**

WEB address : <http://www.gigabyte.com.tr>

- **Russia**

WEB address : <http://www.gigabyte.ru>

- **Poland**

WEB address : <http://www.gigabyte.pl>

- **Ukraine**

WEB address : <http://www.gigabyte.ua>

- **Romania**

WEB address : <http://www.gigabyte.com.ro>

- **Serbia**

WEB address : <http://www.gigabyte.co.rs>

- **Kazakhstan**

WEB address : <http://www.gigabyte.kz>

You may go to the GIGABYTE website, select your language in the language list on the top right corner of the website.

- **GIGABYTE eSupport**

To submit a technical or non-technical (Sales/Marketing) question, please link to:

<http://esupport.gigabyte.com>

