

HERO4 SILVER

/ Join the GoPro Movement



facebook.com/GoPro



youtube.com/GoPro



twitter.com/GoPro



instagram.com/GoPro

To download this user manual in a different language, visit **gopro.com/support**.

Pour télécharger ce manuel de l'utilisateur dans une autre langue, rendez-vous sur **gopro.com/support**.

Wenn Sie dieses Benutzerhandbuch in einer anderen Sprache herunterladen möchten, besuchen Sie **gopro.com/support**.

Per scaricare questo manuale utente in un'altra lingua, visita **gopro.com/support**.

Para descargar este manual de usuario en otro idioma, visite **gopro.com/support**.

Para baixar este manual do usuário em outro idioma, acesse **gopro.com/support**.

このユーザーマニュアルの他言語版をダウンロードするには、**gopro.com/support**にアクセスしてください。

若要下載其他語言版本的使用說明書，請前往：**gopro.com/support**。

如需下載本用戶手冊的其他語言版本，請訪問**gopro.com/support**。

Чтобы загрузить это руководство пользователя на другом языке, посетите страницу **gopro.com/support**.



/ Table of Contents

The Basics	6
Getting Started	8
Camera Displays	14
Camera Icons	18
Camera Menus	20
Camera Modes	22
Navigating Settings Menus	23
Video Mode	25
Photo Mode	37
Multi-Shot Mode	44
Playback Mode	53
Setup Mode	60
Connecting to the GoPro App	69
Transferring Files to a Computer	70
Protune™	71
Battery	77
Important Messages	82
Camera Housing	84

/ Table of Contents

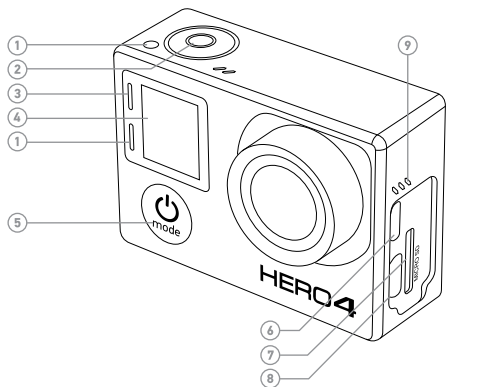
Using the Mounts	89
Troubleshooting	92
Customer Support	94
Trademarks	94
Regulatory Information	94



- | | |
|--|--|
| 1. Camera Status Light (red) | 7. microSD Card Slot
(microSD card not included) |
| 2. Shutter/Select Button [] | 8. Mini-USB Port
(supports composite A/V
cable/ 3.5mm stereo mic
adapter, not included) |
| 3. Wireless Status Light (blue) | 9. Audio Alert |
| 4. Camera Status Screen | |
| 5. Power/Mode Button [] | |
| 6. Micro HDMI Port
(cable not included) | |

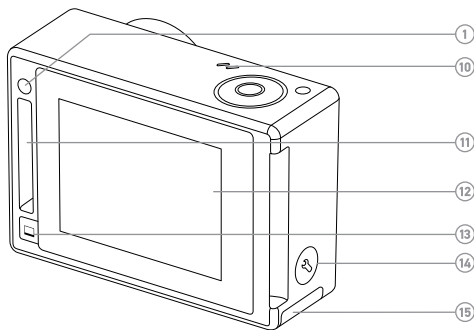

- | |
|--|
| 10. Microphone |
| 11. HERO Port |
| 12. Touch Display |
| 13. Touch Display Sleep/Wake
Button [] |
| 14. Settings/Tag Button [] |
| 15. Battery Door |

CHARGING THE BATTERY

1. Remove the camera from its housing.

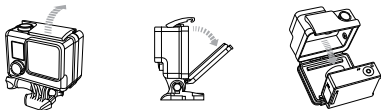

2. Remove the camera side door and insert a microSD card (sold separately). The card must have a minimum rating of Class 10 or UHS-I, and a capacity up to 64GB. Visit gopro.com/support for the list of GoPro-tested microSD cards.

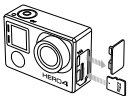

3. Open the bottom door, insert the battery and then close the bottom door.

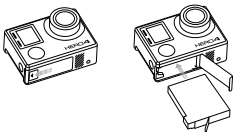

4. Charge the battery by connecting the camera to a computer or other USB charging adapter using the included USB cable. The camera status light turns on during charging and turns off when charging is complete.



WARNING: Using a wall charger other than a GoPro Wall Charger can damage the GoPro battery and could result in fire or leakage. Only use chargers marked: output 5V 1A. If you do not know the voltage and current of your charger, use the included USB cable to charge the camera from your computer.

When charging with a computer, be sure that the computer is connected to a power source. If the camera status light does not turn on, use a different USB port.

The included lithium-ion battery comes partially charged. No damage occurs to the camera or battery if used prior to a full charge.

For more battery information, see *Battery*.



WARNING: Use caution when using your GoPro as part of your active lifestyle. Always be aware of your surroundings to avoid injury to yourself and others.





Abide by all local laws when using your GoPro and related mounts and accessories, including all privacy laws, which may restrict recording in certain areas.

CAMERA SOFTWARE UPDATES

To get the latest features and best performance from your HERO4 camera, make sure you are using the most current camera software. You can update your camera software via the GoPro App or GoPro software. For more information, visit gopro.com/getstarted.

CAMERA DEFAULT SETTINGS

The HERO4 Silver camera powers up with the following default settings:

	Video	1080p60
	Photo	12MP, Wide Field of View (FOV)
	Multi-Shot	Burst option (set to 30 photos in 1 second)
	QuikCapture	Off
	Wireless	Off

PRO TIP: To open the settings menu for the current mode, swipe up on the touch display or press the **Settings/Tag** button [].

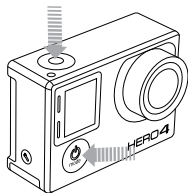



POWERING ON + OFF

To Power On:

Press the **Power/Mode** button [] once. The camera status lights (red) flash three times and the sound indicator emits three beeps. When the camera status screen displays information, your camera is on.

To Power Off:

Press and hold the **Power/Mode** button [] for two seconds. The camera status lights (red) flash several times and the sound indicator emits seven beeps.

PRO TIP: When the camera is off and QuikCapture is enabled, you can turn the camera on and immediately begin capturing video or Time Lapse photos just by pressing the **Shutter/Select** button []. Press once for video, press and hold for Time Lapse photos. Press again to stop recording and power off the camera. For details, see *QuikCapture in Setup Mode*.

INSERTING + REMOVING MICROSD CARDS

The HERO4 Silver camera is compatible with microSD, microSDHC, and microSDXC memory cards with a capacity up to 64GB (sold separately). You must use a microSD card with a minimum rating of Class 10 or UHS-I. (For a list of the GoPro-tested microSD cards, visit gopro.com/support.) GoPro recommends using brand name memory cards for maximum reliability in high-vibration activities.



To Insert the microSD Card:

Slide the memory card into the card slot with the label facing the front of the camera.

When fully inserted, the card clicks into place.

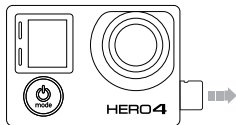

To Remove the microSD Card:

Place your fingernail against the edge of the memory card and lightly press it further into the camera.

The card springs out far enough to be removed.

NOTICE: Use care when handling memory cards. Avoid liquids, dust and debris. As a precaution, power off the camera before inserting or removing the card. Check manufacturer guidelines regarding use in acceptable temperature ranges.

Your HERO4 Silver features a status screen on the front of the camera and a larger touch display on the back.

CAMERA STATUS SCREEN

The camera status screen on the front of the camera displays the following information about modes and settings:

1. Camera Modes/FOV
(field of view)
2. Camera Settings
3. Resolution/fps
(frames per second)
4. Protune™
5. Number of Files Captured
6. Time/Storage/Files
7. Wireless
8. Battery Life

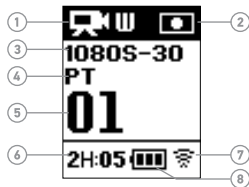

Note: The icons that appear on the camera status screen vary by mode.

TOUCH DISPLAY

The integrated touch display on the back of the camera lets you control your camera and its settings, and preview and play back videos and photos. You can also use it as a viewfinder so you can see what your camera sees for easy shot-framing.

Turning the Touch Display On/Off

The touch display automatically turns on/off when you power the camera on/off.

PRO TIP: To conserve battery power while your camera is on, press the **Touch Display Sleep/Wake** button [] to dim your screen when it is not in use.

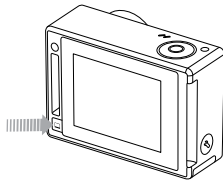

Gestures

Use these gestures to navigate the touch display:

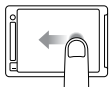

Swipe Left

Display camera modes.

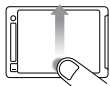

Swipe Up from Bottom Edge

Open the settings menu for the current mode.

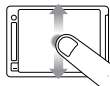

Swipe Up/Down

Move through settings lists.

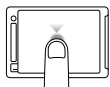

Tap

Select an item, turn a setting on/off.

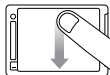

Swipe Down from Top Edge

Close the settings menu.

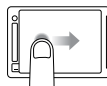

Swipe Right

Display the last captured video or photo.

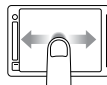

Swipe Left/Right

Display gallery images (**Playback** mode).

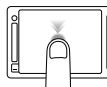





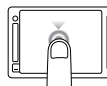























Double Tap















Change FOV in preview mode.



Press for Two Seconds

Lock the touch display.

	Auto Low Light		Language
	Auto Off		LEDs
	Beeps		Looping
	Burst Photos		Megapixels
	Color		Multi-Shot Mode
	Continuous Photos		Night Lapse
	Date/Time		Night Photo
	Default Mode		On-Screen Display
	Delete		Orientation
	Exposure Value Compensation		Photo Mode
	Field of View		Playback Mode
	Frames Per Second		Protune
	Interval		QuikCapture
	ISO Limit		Rate



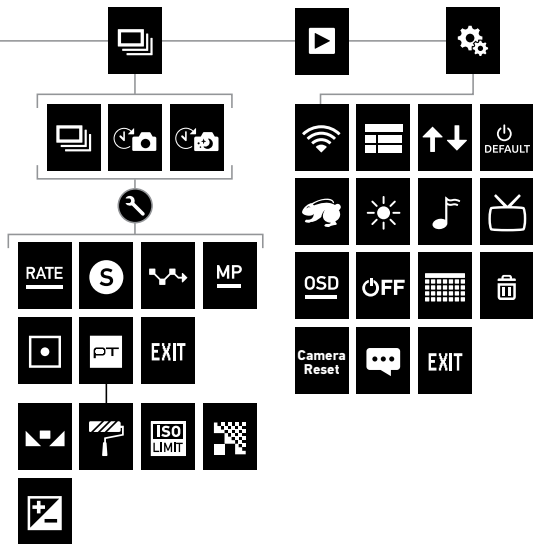
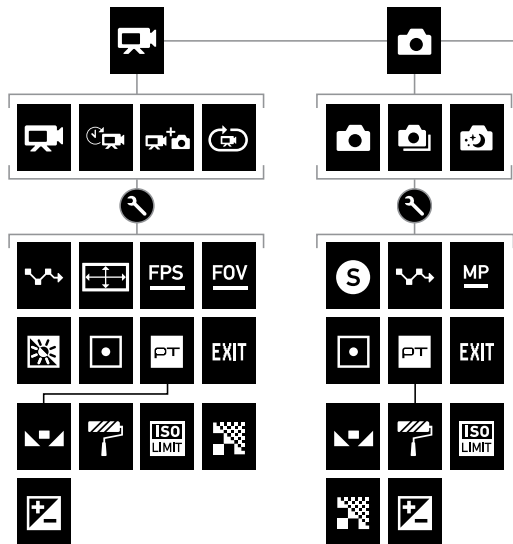

	Setup Mode
	Sharpness
	Shutter
	Single Photo
	Spot Meter
	Time Lapse
	Touch Display
	Video
	Video + Photo
	Video Format
	Video Mode
	Video Resolution
	White Balance
	Wireless



/ Camera Modes

The HERO4 Silver features several camera modes. Swipe left on the touch display, or press the **Power/Mode** button [] repeatedly to cycle through the modes.

These modes appear:

	Video	Record video
	Photo	Capture a single photo
	Multi-Shot	Capture a series of photos (Time Lapse, Burst, etc.)
	Playback	Play back videos and photos
	Setup	Adjust general camera settings

/ Navigating Settings Menus

Each camera mode has its own settings menu. With your HERO4 Silver, you can navigate the settings menus using the touch display or the buttons on the camera.

TO NAVIGATE WITH THE TOUCH DISPLAY:

1. Verify that the camera is in the desired camera mode. If an icon for that mode does not appear in the upper left corner of the touch display, swipe left and then tap the mode.

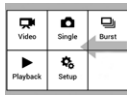



2. From the bottom of the screen, swipe up to open the settings menu for that mode.



3. Swipe up or down to scroll through the settings for that mode.
4. Tap and swipe, as needed, to select a new option for the setting.
5. To exit the settings menu, swipe down from the top of the screen, tap Exit, or press the **Settings/Tag** button [].

TO NAVIGATE WITH THE CAMERA BUTTONS:

1. Verify that the camera is in the desired camera mode. If an icon for that mode does not appear on the camera status screen, press the **Power/Mode** button [] repeatedly until it appears.
2. Press the **Settings/Tag** button [] to open the settings menu for that mode.
3. Use the **Power/Mode** button [] to cycle through the settings.

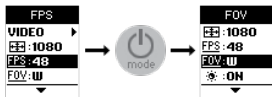

4. Press the **Shutter/Select** button [] to cycle through the options within a setting. To select an option, leave the option highlighted when you move to another screen.





5. To go back to the previous screen or exit the settings menu, press the **Settings/Tag** button [].

Video mode contains four capture modes: Video, Time Lapse Video, Video + Photo and Video Looping.

Capture Mode	Description
Video (default)	Captures video.
Time Lapse Video	Creates video from frames captured at specific intervals. Time Lapse Video is available only in 4K and 2.7K 4:3 resolutions. Time Lapse Video is captured without audio. Protune™, Auto Low Light, and Spot Meter are not available in this capture mode. <i>Note: 2.7K 4:3 resolution is available only for Time Lapse video.</i>
Video + Photo	Simultaneously captures both video and photos. You can set the camera to capture a photo at selected intervals while you record video. For details, see <i>Video + Photo Intervals</i> in this section.
Looping	Lets you continuously record and save only the best moments, which helps to conserve space on your microSD card. Protune is not available in this capture mode.

CAPTURING VIDEO

1. Swipe left to display the camera modes, and then tap the upper left icon (**Video** mode).
2. If necessary, select a different video capture mode (Video, Time Lapse Video, Video + Photo, or Video Looping):
 - a. Swipe up to open the settings menu.
 - b. Tap Mode, and then tap the desired capture mode.
 - c. Swipe down to close the settings menu. The icon for the selected capture mode appears in the upper left on your camera displays.
3. Press the **Shutter/Select** button []. The camera beeps once and the camera status lights flash while the camera is recording.
4. To stop capturing, press the **Shutter/Select** button []. The camera status lights flash three times and the camera beeps three times.

If the memory card is full or the battery is out of power, your camera automatically stops recording. Your video is saved before the camera powers off.

PRO TIP: When the camera is off and QuikCapture is enabled, you can turn the camera on and immediately begin capturing video just by pressing the **Shutter/Select** button []. Press again to stop recording and power off the camera. For details, see *Setup Mode*.

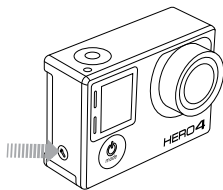

HIGHLIGHT TAGGING

You can mark specific moments in your video during recording or playback with HiLight Tags. HiLight Tags make it easy to find the best highlights to share.

You can add tags with your camera, the GoPro App, or the Smart Remote (sold separately).

To Add a HiLight Tag with Your Camera:

While recording or playing back video, press the **Settings/Tag** button [].

PRO TIP: In the app, tap the screen during playback to display the HiLight Tags on the progress bar.

VIDEO SETTINGS

Four capture modes are available for **Video** mode: Video, Time Lapse Video, Video + Photo and Video Looping. The capture mode that you select determines the **Video** settings that appear in the rest of the menu.

For instructions on how to change the following settings, see *Navigating Settings Menus*.

PRO TIP: To open the settings menu for the current mode, swipe up on the touch display or press the **Settings/Tag** button [].

INTERVAL

The Interval setting applies to Time Lapse Video, Video + Photo and Looping. Interval determines the amount of time that passes between each captured frame.

Time Lapse Video Intervals

Available intervals for Time Lapse Video range from 0.5 seconds (default) to 60 seconds.

Interval	Examples
0.5-2 seconds	Surfing, biking or other sport
2 seconds	Busy street corner
5-10 seconds	Sunset
10-60 seconds	Lengthy activities, such as construction projects

Video + Photo Intervals

Available intervals for Video + Photo range from 5-60 seconds. The quality of the photo depends on the selected video resolution and FOV.

Looping Intervals

Available intervals for Looping are 5, 20, 60 and 120 minutes. For example, if you select a 5-minute interval, only the previous 5 minutes is saved when you stop recording. If you record for 5 minutes and do not press the **Shutter/Select** button [] to stop recording and save, the camera begins a new 5-minute interval by recording over your previous 5 minutes of footage.

You can also select max video as the interval. With this option, the camera records until the memory card is full, then overwrites the content.

Note: To use Looping, be sure that your microSD card has sufficient space.

PRO TIP: Multiple chapter files are written to your memory card so that small segments of content can be overwritten during loop recording. When viewing this content on a computer, you see separate files for each time segment. Use GoPro software to combine the files into a longer video.

RESOLUTION, FPS AND FOV

The HERO4 Silver includes the video resolutions listed below.

Video Resolution	NTSC/ PAL	FOV	Screen Resolution
4K	15/12.5	Ultra Wide	3840x2160, 16:9
2.7K	30/25 24/24	Ultra Wide, Medium	2704x1520, 16:9
1440p	48/48 30/25 24/24	Ultra Wide	1920x1440, 4:3
1080p	60/50 48/48 30/25 24/24	Ultra Wide, Medium, Narrow	1920x1080, 16:9
1080p SuperView™	60/50 48/48 30/25 24/24	Ultra Wide	1920x1080, 16:9
960p	100/100 60/50	Ultra Wide	1280x960, 4:3

/ Video Mode

Video Resolution	NTSC/ PAL	FOV	Screen Resolution
720p	120/120 60/50 30/25	Ultra Wide, Medium, Narrow	1280x720, 16:9
720p SuperView	100/100 60/50	Ultra Wide	1280x720, 16:9
WVGA	240/240	Ultra Wide	848x480, 16:9

PRO TIP: To open the settings menu for the current mode, swipe up on the touch display or press the **Settings/Tag** button [].

/ Video Mode

Video Resolution	Best Use
4K	Stunning high-resolution video with professional low-light performance. 8MP stills available from video. Recommended for tripod or fixed position shots.
2.7K	16:9 resolution video downscales to provide stunning, cinema-quality results for professional productions.
1440p	Recommended for body-mounted shots. Larger viewing area and high frame rate yield the smoothest, most immersive results for high-action capture.
1080p	Great for all shots. High resolution and frame rate yield stunning results.
1080p SuperView	SuperView delivers the world's most immersive field of view. Recommended for body-or gear-mounted shots. More vertical 4:3 content is automatically stretched to full-screen 16:9 for stunning widescreen playback on your computer or TV.

Video Resolution	Best Use
960p	Use for body-mounted shots and when slow motion is desired.* Provides large viewing area and smooth results for high action capture.
720p	Good for handheld shots and when slow motion is desired.*
720p SuperView	SuperView delivers the world's most immersive field of view. Good for body- or gear-mounted shots. More vertical 4:3 content is automatically stretched to full-screen 16:9 for stunning widescreen playback on your computer or TV.
WVGA	Good when super slow motion is desired and standard definition is acceptable.

** For slow motion at high frame rates, turn off Auto Low Light. If shooting indoors, be sure you have sufficient light.*

FOV	Best Use
Ultra Wide	Largest field of view, increased image stability. Good for action shots where you want to capture as much as possible within the frame.
Medium	Mid-range field of view, moderate image stability.
Narrow	Smallest field of view, reduced image stability. Reduced distortion. Good for capturing content at a distance.

PRO TIP: Easily create epic GoPro-style videos using free GoPro software. Learn more and download this software at gopro.com/getstarted.

**LOW LIGHT**

Auto Low Light allows you to shoot in low-light environments or when quickly transitioning in and out of low-light conditions. The camera automatically adjusts fps to achieve the optimal exposure and best results.

Auto Low Light is not available for 240 fps or 30 fps and below. The options for this setting are on (default) and off.

**SPOT METER**

Spot Meter lets you film from a dark space while pointing the camera into a brighter setting, such as when recording the outdoors from within a car. When Spot Meter is turned on, [] appears on the camera displays. The options for this setting are off (default) and on.

*Note: Changes that you make to the Spot Meter setting in **Video** mode apply only to video capture. To adjust this setting for photo capture, adjust the setting in **Photo** mode. To adjust this setting for multi-shot capture, adjust the setting in **Multi-Shot** mode.*

**PROTUNE**

For details about Protune settings, see *Protune*.

*Note: Changes that you make to the Protune settings in **Video** mode apply only to video capture. To adjust this setting for photo capture, adjust the setting in **Photo** mode. To adjust this setting for multi-shot capture, adjust the setting in **Multi-Shot** mode.*

Photo mode contains three capture modes: Single, Continuous and Night.





Capture Mode	Description
Single (default)	Captures a single photo.
Continuous	Captures a series of photos continuously while holding down the Shutter/Select button [].
Night	Captures a single photo with a customizable exposure time up to 30 seconds. For available exposure times and examples of when to use them, see <i>Shutter</i> in <i>Photo Settings</i> .

PRO TIP: For Night photo, be sure to use the right Shutter setting for the situation. For details, see *Shutter* in *Photo Settings*.

CAPTURING A SINGLE OR NIGHT PHOTO

1. Swipe left to display the camera modes, and then tap the middle icon in the upper row (**Photo** mode).
2. If necessary, select a different photo capture mode (Single or Night):
 - a. Swipe up to open the settings menu.
 - b. Tap Mode, and then tap the desired capture mode.
 - c. Swipe down to close the settings menu. The icon for the selected capture mode appears in the upper left on your camera displays.
3. Press the **Shutter/Select** button []. The camera beeps two times, the camera status lights flash and the counter on the camera status screen increases by one.

CAPTURING CONTINUOUS PHOTOS

1. Select Continuous mode:
 - a. Swipe left to display the camera modes, and then tap the middle icon in the top row (**Photo** mode).
 - b. Swipe up to open the settings menu.
 - c. Tap Mode, and then tap Continuous.
 - d. Tap [] to close the settings menu. The Continuous icon [] appears in the upper left on your camera displays.
2. Press and hold the **Shutter/Select** button []. The camera beeps and the camera status lights flash repeatedly.
3. To stop capturing, release the **Shutter/Select** button []. The counter on the camera status screen increases by one for every photo captured.



PRO TIP: While capturing video, you can manually take a photo at any time by pressing the **Power/Mode** button []. Press and hold the **Power/Mode** button [] to capture a photo every 5 seconds.

PHOTO SETTINGS

Three capture modes are available for **Photo** mode: Single, Continuous and Night. The capture mode that you select determines the **Photo** settings that appear in the rest of the menu.

For instructions on how to change the following settings, see *Navigating Settings Menus*.

PRO TIP: To open the settings menu for the current mode, swipe up on the touch display or press the **Settings/Tag** button [].

SHUTTER

Shutter applies only to Night Photo and Night Lapse and determines the amount of time that the shutter is open. The options for this setting are auto (up to 2 seconds), 2, 5, 10, 15, 20 or 30 seconds. The default setting is auto.

Settings	Examples
Auto (up to 2 sec)	Sunrise, sunset, dawn, dusk, twilight, night
2 sec, 5 sec, 10 sec	Dawn, dusk, twilight, traffic at night, Ferris wheel, fireworks, light painting
20 sec	Night sky (with light)
30 sec	Night stars, Milky Way (complete darkness)

PRO TIP: For best results when using the Shutter setting, mount your camera on a tripod or other stable surface to reduce the amount of blur in your video or photos.

INTERVAL

Interval applies only to Continuous photo. Available intervals are 3 (default), 5 or 10 photos every second.

MP MEGAPIXELS

The HERO4 Silver captures photos at 12MP, 7MP or 5MP.

*Note: Changes that you make to the Megapixels setting in **Photo** mode apply only to photo capture. To adjust this setting for multi-shot capture, adjust the setting in **Multi-Shot** mode.*

Photo Resolution	Field of View (FOV)
12MP Wide (default) 7MP Wide	Largest field of view. Good for action shots where you want to capture as much as possible within the frame.
7MP Medium 5MP Medium	Mid-range field of view.

SPOT METER

Spot Meter lets you capture photos from a dark space while pointing the camera into a brighter setting, such as when recording the outdoors from within a car. When Spot Meter is turned on, [] appears on the camera displays. The options for this setting are off (default) and on.

*Note: Changes that you make to the Spot Meter setting in **Photo** mode apply only to photo capture. To adjust this setting for video capture, adjust the setting in **Video** mode. To adjust this setting for multi-shot capture, adjust the setting in **Multi-Shot** mode.*

PROTUNE

For details about Protune settings, see *Protune*.



*Note: Changes that you make to the Protune settings in **Photo** mode apply only to photo capture. To adjust this setting for video capture, adjust the setting in **Video** mode. To adjust this setting for multi-shot capture, adjust the setting in **Multi-Shot** mode.*

Multi-Shot mode contains three capture modes: Burst, Time Lapse and Night Lapse.

Capture Mode	Description
Burst (default)	Captures up to 30 photos in 1 second. Perfect for capturing the definitive moment in fast-action sports.
Time Lapse	Captures a series of photos at specified intervals. You can use Time Lapse to capture photos of any activity, so you can choose the best ones later.
Night Lapse	Captures a series of photos at specific intervals and exposure times. Use Night Lapse in low light environments, such as when capturing the night sky over a period of time. For available exposure times and examples of when to use them, see <i>Shutter</i> in <i>Multi-Shot Settings</i> .



PRO TIP: For longer exposure times during the day, use Night Lapse.

CAPTURING BURST PHOTOS

1. Select Burst mode:
 - a. Swipe left to display the camera modes, and then tap the upper right icon (**Multi-Shot** mode).
 - b. Swipe up to open the settings menu.
 - c. Tap Mode, and then tap Burst.
 - d. Swipe down to close the settings menu. The Burst icon [] appears in the upper left on your camera displays.
2. Press the **Shutter/Select** button []. The camera status lights flash and the camera beeps multiple times.

See *Rate* in this section for options available for Burst photos.

CAPTURING TIME LAPSE OR NIGHT LAPSE PHOTOS

1. Select the desired capture mode (Time Lapse or Night Lapse):
 - a. Swipe left to display the camera modes, and then tap the upper right icon (**Multi-Shot** mode).
 - b. Swipe up to open the settings menu.
 - c. Tap Mode, and then tap the desired capture mode (Time Lapse or Night Lapse).
 - d. Swipe down to close the settings menu. The icon for the selected capture mode appears in the upper left on your camera displays.
2. Press the **Shutter/Select** button []. The camera initiates countdown and the camera status lights flash each time a photo is captured.
3. To stop capturing, press **Shutter/Select** button []. The camera status lights flash three times and the camera beeps three times.

PRO TIP: When the camera is off and QuikCapture is enabled, you can turn the camera on and immediately begin capturing Time Lapse photos just by pressing and holding the **Shutter/Select** button []. Press again to stop recording and power off the camera. For details, see *Setup Mode*.

MULTI-SHOT SETTINGS

Three capture modes are available for **Multi-Shot** mode: Burst, Time Lapse and Night Lapse. The capture mode that you select determines the **Multi-Shot** settings that appear in the rest of the menu.

For instruction on how to change the following settings, see *Navigating Settings Menus*.

PRO TIP: To open the settings menu for the current mode, swipe up on the touch display or press the **Settings/Tag** button [].

RATE

Rate applies only to Burst. Photos can be captured at the following rates:

3 photos in 1 second

5 photos in 1 second

10 photos in 1 second

10 photos in 2 seconds

10 photos in 3 seconds

30 photos in 1 second (default)

30 photos in 2 seconds

30 photos in 3 seconds

30 photos in 6 seconds

PRO TIP: Sometimes 30 photos in 1 second is too fast. Try a slower Burst interval to better match the action.

S SHUTTER

Shutter applies only to Night Photo and Night Lapse and determines the amount of time that the shutter is open. The options for this setting are auto, 2, 5, 10, 15, 20 or 30 seconds. The default setting is auto.

Settings	Examples
Auto (up to 2 sec)	Sunrise, sunset, dawn, dusk, twilight, night
2 sec, 5 sec, 10 sec	Dawn, dusk, twilight, traffic at night, Ferris wheel, fireworks, light painting
20 sec	Night sky (with light)
30 sec	Night stars, Milky Way (complete darkness)

PRO TIP: For best results when using the Shutter setting, mount your camera on a tripod or other stable surface to reduce the amount of blur in your video or photos.



Interval applies only to Time Lapse and Night Lapse. Interval determines the amount of time that passes between each captured frame.

Time Lapse Intervals

Available intervals for Time Lapse range from 0.5 seconds (default) to 60 seconds.

Interval	Examples
0.5-2 seconds	Surfing, biking or other sport
2 seconds	Busy street corner
5-10 seconds	Sunset
10-60 seconds	Lengthy activities, such as construction projects

Night Lapse Intervals

Available intervals for Night Lapse range from 4 seconds to 60 minutes. Continuous (default) causes the Interval to match the Shutter setting. For example, if Shutter is set to 10 seconds and Interval is set to continuous, your camera captures a photo every 10 seconds.



The HERO4 Silver captures photos at 12MP, 7MP or 5MP.

*Note: Changes that you make to the Megapixels setting in **Multi-Shot** mode apply only to multi-shot capture. To adjust this setting for photo capture, adjust the setting in **Photo** mode.*

Settings	Description
12MP Wide (default) 7MP Wide	Largest field of view. Good for action shots where you want to capture as much as possible within the frame.
7MP Medium 5MP Medium	Mid-range field of view.



Spot Meter lets you capture photos from a dark space while pointing the camera into a brighter setting, such as when recording the outdoors from within a car. When Spot Meter is turned on, [] appears on the camera status screen. The options for this setting are off (default) and on.

*Note: Changes that you make to the Spot Meter setting in **Multi-Shot** mode apply only to multi-shot capture. To adjust this setting for video capture, adjust the setting in **Video** mode. To adjust this setting for photo capture, adjust the setting in **Photo** mode.*



For details about Protune settings, see *Protune*.

*Note: Changes that you make to the Protune settings in **Multi-Shot** mode apply only to multi-shot capture. To adjust this setting for video capture, adjust the setting in **Video** mode. To adjust this setting for photo capture, adjust the setting in **Photo** mode.*



You can play back your content on the camera's touch display, your computer, TV or smartphone/tablet (using the GoPro App).

You can also play back content by inserting the microSD card directly into a device, such as a computer or compatible TV. With this method, playback resolution depends on the resolution of the device and its ability to play back that resolution.

PLAYING BACK VIDEOS AND PHOTOS ON YOUR HERO4 SILVER







With the HERO4 Silver touch display, you can play back your videos and photos directly on your camera.

To Play Back Content Using the Touch Display:

1. Swipe left, and then tap **Playback**.
2. Swipe up to scroll through the thumbnails.
Note: For photo series (Burst, Time Lapse, Night Lapse and Continuous photos), the thumbnail displays the first photo in the series.
3. Tap a video or photo to open it in full-screen view.
4. For video, tap [].
5. To return to the thumbnails screen, tap [].
6. To exit **Playback** mode, swipe down and then tap [].

PRO TIP: When you are not in **Playback** mode, swipe right on the touch display to display the last captured video or photo.



To Play Back Content When the Camera is in a Housing:

1. Power on the camera.
2. Press the **Power/Mode** button [] to cycle to **Playback** mode.
3. Press the **Shutter/Select** button [] to select **Playback**.
4. In thumbnail preview, use the **Power/Mode** button [] to cycle through the thumbnails.
5. Press the **Shutter/Select** button [] to view a thumbnail.
6. To exit **Playback** mode, use the **Power/Mode** button [] to cycle to [], then press the **Shutter/Select** button [] to select it.



CREATING SHORT CLIPS FROM A VIDEO

Video trimming lets you create short clips of your favorite shots from your video files. Clips are saved as new files that can be shared through the GoPro App and used during editing in GoPro Studio.

To Create a Short Clip from a Video:

1. In **Playback** mode, tap the video that contains the clip that you want to save.
2. Tap [] to begin playing the video.
3. When you reach the point where you want to start clipping, tap [].
4. Tap []. By default, the duration of the clip is 5 seconds.

5. If needed, select one of these options:

- To save a longer clip, tap the 5 sec icon repeatedly to cycle through the options. You can save a clip with a duration of 5, 15, or 30 seconds.
 - To save a photo of the frame in view, tap Still.
6. Tap [] to review the clip before saving it.
 7. If needed, adjust the starting point of the clip by tapping [].
To adjust the ending point, tap [].
Note: If you adjust the starting or ending points, the duration of the clip remains the same.
 8. Tap Save. The clip is saved as a separate video file. Still photos are saved as photo files. Your original video file is unchanged.

PRO TIP: After you create clips from a video, you can delete the original file to save space on your microSD card.

PLAYING BACK VIDEOS AND PHOTOS ON A COMPUTER

For best results playing back your content on a computer, visit gopro.com/getstarted to download the latest GoPro software. Be sure your Mac® or Windows® computer meets these minimum system requirements:

	Windows	Mac
Operating System	Windows 7, 8.x	OS X® 10.8 or later
CPU	Intel® Core 2 Duo™ (Intel Quad Core™ i7 or better recommended)	Intel® Dual Core™ (Intel Quad Core i7 or better recommended)
Graphics Card	Card that supports OpenGL1.2 or later	Intel® Dual Core™ (Intel Quad Core i7 or better recommended)
Screen Resolution	1280 x800	1280 x768

	Windows	Mac
RAM	4GB	4GB
Hard Drive	5400 RPM internal drive (7200 RPM drive or SSD recommended) If external, use USB 3.0 or eSATA	5400 RPM internal drive (7200 RPM drive or SSD recommended) If external, use Thunderbolt, FireWire or USB 3.0







To Play Back Content on Your Computer:

1. Download the latest GoPro software from gopro.com/getstarted.
2. Connect the camera to your computer using the included USB cable.
3. Copy the files to your computer or external hard drive.
4. Play back your content with GoPro software.

PLAYING BACK VIDEOS AND PHOTOS ON YOUR TV

Playing back videos and photos on your TV/HDTV requires a micro HDMI, composite or combo cable (all sold separately).

To Play Back Content on a TV:

1. Plug the camera into a TV/HDTV with a micro HDMI cable, composite cable or combo cable.
2. Select the input on your TV that corresponds to the port into which you plugged the cable.
3. Power on the camera.
4. Press the **Power/Mode** button [] to cycle to **Playback** [] mode, and then press the **Shutter/Select** button [] to select it.
5. Use the **Power/Mode** button [] to navigate files.
6. Use the **Shutter/Select** button [] to open a file in full-screen view.
7. When a file is selected, use [] and [] to navigate backward and forward to see more media files on your memory card.

Note: HDMI playback depends on the resolution of the device, and is certified up to 1080p.

PLAYING BACK CONTENT ON A SMARTPHONE/TABLET

1. Connect your camera to the GoPro App. For details, see *Connecting to the GoPro App*.
2. Use the controls on the app to play back your footage on your smartphone/tablet.

PRO TIP: While playing back your video, you can add HiLight Tags to mark the best moments. On the camera, press the **Settings/Tag** button [] to add a tag. In the GoPro App, tap the HiLight Tag icon.

In **Setup** mode, you can change settings that apply to all camera modes. For instructions on how to change the following settings, see *Navigating Settings Menus*.

 **WIRELESS**



When Wireless is on, a Wireless status icon appears on the camera status screen and the blue wireless light blinks intermittently. The default setting for Wireless is off.

Setting	Description
PAIR	Lets you pair your camera to a smartphone/tablet (through the GoPro App) or a GoPro remote (sold separately). For instructions on pairing to a smartphone/tablet, see <i>Connecting to the GoPro App</i> . For instructions on pairing to a GoPro remote, see the user manual for the remote.
MODE	After pairing, Mode lets you connect the camera to the GoPro App or a GoPro remote (sold separately). <i>Note: RC and APP are combined into one Mode option if you paired your camera with a smartphone/tablet that uses Bluetooth® LE.</i>

PRO TIP: If you forgot your camera's name or password, use the Camera Reset setting (Reset Wi-Fi option) in **Setup** mode to reset them to the defaults. The default password is *goprohero*.

 **TOUCH DISPLAY**

These settings let you manage the touch display to conserve battery power.

Setting	Description
Sleep 	Automatically dims the touch display after a period of inactivity. The options for this setting are 1 minute (default), 2 minutes, 3 minutes and Never. To manually dim the screen or to wake it, press the Touch Display Sleep/Wake button [].
Lock 	Lets you use gestures to lock and unlock the touch display. The options for this setting are off and on (default). Turn this setting on to prevent accidental input on the touch display. When this setting is on, press the touch display for two seconds to lock it. To unlock the touch display, slide down and hold.

Setting	Description
Brightness 	Determines the level of light on the touch display. The options for this setting are high (default), medium and low.
Touch Display On/Off	Turns the touch display on or off when the camera is powered on. The options for this setting are on (default) and off.

ORIENTATION

If you mount your camera upside down, you might have to rotate the files during editing. This setting eliminates the need to flip your video or photos after recording.

Setting	Description
Up (default)	Camera is always assumed to be right-side up.
Down	Camera is always assumed to be upside down.
Auto	(Auto Image Rotation) Camera automatically selects Up or Down, based on the orientation of the camera when recording begins.

DEFAULT MODE

You can select the capture mode that appears when the camera powers on. The options are Video, Time Lapse Video, Video + Photo, Video Looping, Single, Continuous, Night, Burst, Time Lapse and Night Lapse.

QUIKCAPTURE



With QuikCapture, you can quickly turn your camera on and begin capturing video or Time Lapse photos. The options for this setting are on and off (default).

Note: QuikCapture is disabled when the camera is connected to the remote or the GoPro App.

To Capture Video with QuikCapture:

With the camera powered off, press and release the **Shutter/Select** button []. Your camera automatically powers on and begins capturing video.

To Capture Time Lapse Photos with QuikCapture:

With the camera powered off, press and hold the **Shutter/Select** button [] until you see the Time Lapse icon []. Your camera automatically powers on and begins capturing Time Lapse photos.

To Stop Recording:

Press and release the **Shutter/Select** button [] to stop recording and power off the camera.

LEDS

This setting determines which camera status lights (red) to activate. The options for this setting are 4 (top, bottom, front, back), 2 (front and back), or off (none). The default setting is 4.

Note: The Wireless status light (blue) is always activated unless you select off for this setting.

BEEPS

You can set the volume for the sound indicators to be 100% (default), 70% or off.

VIDEO FORMAT

The Video Format setting governs frame rates for recording and playback when viewing video on a TV/HDTV.

Setting	Description
NTSC (default)	Viewing video in North America
PAL	Viewing video on a PAL TV/HDTV (most televisions outside of North America)

ON-SCREEN DISPLAY

The OSD (on-screen display) setting determines whether the recording icons and file information on video and on the viewing screen appear during playback. The options for this setting are on (default) and off.

Note: When this setting is on and you are playing back content directly on your camera, you can tap the touch display to quickly show or hide the recording and file information.

AUTO OFF

Your camera can be configured to automatically power off after a specific period (1 minute - 5 minutes) in which no videos or photos are captured and no buttons are pressed. You can also configure the camera to never automatically power off (default).

Note: Your camera does not automatically power off when connected to the GoPro App or the remote.

DATE/TIME

Your camera's date and time are automatically set when you connect your camera to the GoPro App or GoPro software. This setting lets you manually set the date and time. If the battery is removed from the camera for an extended period of time, you must reset the date and time (automatically or manually).

DELETE

This setting lets you delete the last file, or delete all files and format the memory card. Deleting all files is useful after you transfer your files to your computer and want to make room on your memory card for more content. LED lights blink until the operation is complete.

NOTICE: If you select All/Format, the memory card is reformatted, which deletes every file on the card.

/ Setup Mode

CAMERA RESET

With this setting, you can reset your camera's settings or username and password.

Setting	Description
Reset Defaults	Returns all settings to their default values. This option retains the Date/Time setting, the camera's name and wireless password, and remote control pairing. <i>Note: If your camera is not responding but you do not want to lose your settings, press and hold the Power/Mode button for 8 seconds.</i>
Reset Wi-Fi	Resets the camera's name and password to the defaults. The default password is <i>goprohero</i> .



LANGUAGE

This setting changes the language that appears on the camera displays. The options are English (default) and simplified Chinese.

/ Connecting to the GoPro App

The GoPro App lets you control your camera remotely using a smartphone or tablet. Features include full camera control, live preview, playback and sharing of content, and camera software updates.

TO CONNECT YOUR HERO4 SILVER TO THE GOPRO APP:

1. Download the GoPro App to your smartphone/tablet from the Apple App Store, Google Play, or the Windows Phone Store.
2. Follow the app's on-screen instructions to connect your camera.

*Note: If needed, the default password for your camera is *goprohero*.*

For complete pairing instructions, visit gopro.com/support.

PRO TIP: If the camera is powered on and ready to capture videos or photos, you can press and hold the **Settings/Tag** button [] for two seconds to turn Wireless on/off. You can also do this when the camera is powered off.

To play back your video and photos on a computer, you must first transfer these files to a computer.

TO TRANSFER FILES TO A COMPUTER:

1. Download and install the latest GoPro software from gopro.com/getstarted.
2. Connect the camera to your computer using the included USB cable.

PRO TIP: You can also transfer files to a computer using a card reader (sold separately). Connect the card reader to your computer and insert the microSD card into the reader. You can then transfer files to your computer or delete selected files on your card.

PROTUNE BENEFITS

Protune unlocks the camera's full potential, yielding stunning image quality and cinema-caliber video and photos optimized for professional productions. Protune gives content creators more flexibility and workflow efficiency than ever before.

Protune is compatible with professional color correction tools, GoPro software and other video and photo editing software.

Protune enables manual control of White Balance, Color, ISO Limit, Sharpness and Exposure Value Compensation for advanced control and customization of your video footage and photos.

*Note: Changes that you make to the Protune settings apply only to the mode in which they are changed. To adjust this setting for video capture, adjust the settings in **Video** mode. To adjust this setting for photo capture, adjust the settings in **Photo** mode. To adjust this setting for multi-shot capture, adjust the settings in **Multi-Shot** mode.*



The options for this setting are off (default) and on. When Protune is on, *PT* appears on the camera displays. Protune is available for all video and photo resolutions.

WHITE BALANCE

White balance adjusts the overall color tone of videos and photos.

Setting	Description
Auto (default)	Automatically adjusts the color tone based on the environmental conditions
3000K	Warm light (incandescent or sunrise/sunset lighting)
5500K	Slightly cool light (cool fluorescent or average daylight)
6500K	Cool light (overcast conditions)
Native	Minimally color-corrected file from the image sensor that allows for more precise adjustments in post-production

COLOR

Color allows you to adjust the color profile of your video footage or photos.

Color Setting	Resulting Color Profile
GoPro Color (default)	Provides GoPro color-corrected profile (same great color as when Protune is turned off).
Flat	Provides neutral color profile that can be color-corrected to better match footage captured with other equipment, offering more flexibility in post-production. Due to its long curve, Flat captures more details in shadows and highlights.

**ISO LIMIT**

ISO Limit adjusts the camera's sensitivity in low-light environments, and creates a balance between brightness and resulting image noise. Image noise refers to the degree of graininess in the image.

Protune for Video ISO Limit

Setting	Resulting Quality
6400	Brighter video in low light, highest image noise
3200	Brighter video in low light, increased image noise
1600 (default)	Moderately bright video in low light, moderate image noise
800	Darker video in low light, marginal image noise
400	Darker video in low light, -minimum image noise

Protune for Photo ISO Limit

Setting	Resulting Quality
800 (default)	Brighter photo in very low light, increased image noise
400	Brighter photo in very low light, moderate image noise
200	Darker photo in indoor lighting, marginal image noise
100	Darker photo in indoor lighting, minimal image noise

**SHARPNESS**

Sharpness controls the sharpness of your video footage or photos.

Sharpness Setting	Resulting Quality
High (default)	Ultra-sharp video or photo
Medium	Moderately sharp video or photo
Low	Softer video or photo



EXPOSURE VALUE COMPENSATION (EV COMP)

Exposure Value Compensation affects the brightness of your video or photo. Adjusting this setting can improve image quality when shooting in environments with contrasting lighting conditions.

Settings

-2.0	-1.5	-1.0	-0.5	0 (default)	+0.5	+1.0	+1.5	+2.0
------	------	------	------	-------------	------	------	------	------

PRO TIP: Exposure Value Compensation adjusts brightness within the existing ISO Limit. If brightness has already reached the ISO Limit in a low-light environment, increasing the Exposure Value Compensation does not have any effect.

RESET

This option resets all Protune settings to their default values.

MAXIMIZING BATTERY LIFE

The battery icon on the camera screen blinks when the battery drops below 10%. If the battery reaches 0% while recording, the camera saves the file and powers off.

To maximize battery life, close the GoPro App. To maximize battery life when shooting longer-duration activities, turn off the touch display. Extreme cold temperatures can decrease battery life. To maximize battery life in cold conditions, keep the camera in a warm place prior to use. Shooting at higher frame rates and resolutions, and shooting with Protune turned on, increase power consumption.

PRO TIP: QuikCapture helps maximize battery life. For details, see *QuikCapture in Setup Mode*.

The battery charges to 100% in approximately two hours when using GoPro's USB-compatible Wall or Auto Charger.

You can also charge the battery outside the camera using the Dual Battery Charger (sold separately).

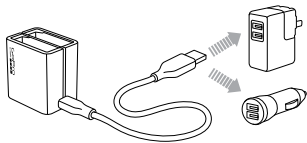

No damage occurs to the camera or battery if used prior to full charge. Spare batteries and additional charging accessories are available at gopro.com.

REMOVING THE BATTERY FROM THE CAMERA

The HERO4 Silver battery is designed to have a tight fit to maximize reliability in high-vibration activities.

To Remove the Battery:

1. Open the battery door by placing your thumb in the indentation in the battery door (on the bottom of the camera) and sliding it to the left. Allow the door to open.
2. Grasp the battery pull-tab and remove the battery from the camera.

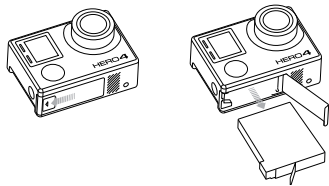

BATTERY STORAGE AND HANDLING

The camera contains sensitive components, including the battery. Avoid exposing your camera and battery to very cold or very hot temperatures. Low or high temperature conditions may temporarily shorten the battery life or cause the camera to temporarily stop working properly. Avoid dramatic changes in temperature or humidity when using the camera, as condensation may form on or within the camera.

The camera housing protects the camera and battery from water damage. For more information, see *Camera Housing*. Do not turn on your camera if it is wet. If your camera is already on, turn it off and remove the battery immediately. Allow the camera to dry thoroughly before using it again. Do not dry the camera or battery with an external heat source such as a microwave oven or hair dryer. Damage to the camera or battery caused by contact with liquid is not covered under the warranty.

Do not store your battery with metal objects, such as coins, keys or necklaces. If the battery terminals come in contact with metal objects, this may cause a fire.

BATTERY DISPOSAL

Most rechargeable lithium-ion batteries are classified as non-hazardous waste and are safe for disposal in the normal municipal waste stream. Many localities have laws in place requiring battery recycling. Check your local laws to make sure that you can dispose of rechargeable batteries in your regular trash. To safely dispose of lithium-ion batteries, protect terminals from exposure to other metal with packing, masking or electrical tape so they do not cause a fire while being transported.

Lithium-ion batteries, however, do contain recyclable materials and are accepted for recycling by the Rechargeable Battery Recycling Corporation's (RBRC) Battery Recycling Program. We encourage you to visit Call2Recycle at call2recycle.org or call 1-800-BATTERY in North America to find a convenient recycling location.

Never dispose of a battery in a fire because it may explode.



WARNING: Do not drop, disassemble, open, crush, bend, deform, puncture, shred, microwave, incinerate or paint the camera. Do not insert foreign objects into the battery opening on the camera. Do not use the camera or the battery if it has been damaged—for example, if cracked, punctured or harmed by water. Disassembling or puncturing the battery can cause an explosion or fire.

MICROSD CARD MESSAGES

NO SD	No card present. The camera requires a microSD, microSDHC or microSDXC card (sold separately) to capture videos and photos.
FULL	Card is full. Delete files or swap card.
SD ERR	Camera is unable to read card formatting. Reformat the card in the camera.

PRO TIP: Reformat your microSD card on a regular basis to ensure that the card remains in good condition.

FILE REPAIR ICON



If your last video file was corrupted during recording, the camera displays the File Repair icon while it tries to repair the file. When this process is finished, press any button to continue using the camera.

TEMPERATURE ICON



The Temperature icon appears on the camera status screen when the camera becomes too hot and needs to cool down. Simply let it sit and cool before attempting to use it again. Your camera was designed to identify conditions of overheating and is designed to respond accordingly.

ASSEMBLING THE CAMERA HOUSING

To Remove the Camera From the Housing:

1. Lift the front of the latch up to disengage it from the camera housing.
2. Pivot the latch backward and pull it up to release the backdoor.
3. Pull open the housing backdoor and remove the camera.

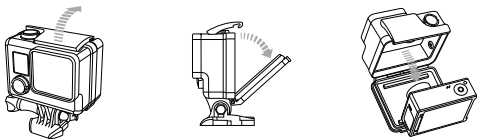

To Secure the Camera in the Housing:

1. Open the housing and place the camera into position.
2. Make sure the seal around the backdoor is free of debris.
3. Close the housing backdoor and squeeze it closed to ensure a good seal.
4. Pivot the hinged arm backwards and hook the lip of the latch into the grooved top of the housing backdoor.
5. Push the latch down to snap it into place.

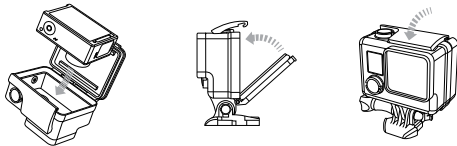

WARNING: Always secure the camera in its housing when using the camera in or around water. Do not get the camera or the battery wet.

Your HERO4 Silver camera comes with three types of backdoors: Standard Backdoor, Skeleton Backdoor and Touch Backdoor.

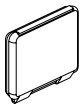

The Standard Backdoor makes the housing waterproof to 131' (40m). Use this door when you need to protect the camera from water, dirt, sand and other environmental hazards.

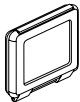

The Touch Backdoor (waterproof) lets you use the Touch Display and provides waterproof protection to 10' (3m).

NOTICE: Touch functions do not work underwater. In extreme altitude and temperatures, keep housing unlatched until use.



The Skeleton Backdoor (non-waterproof) provides better sound quality by allowing more sound to reach the camera's microphone. It also reduces wind noise at speeds up to 100mph when mounted on helmets, motorcycles, bikes and other fast-moving vehicles. Use this backdoor only when sand, excessive dirt/dust and water damage are not a risk. This backdoor is also recommended for use inside vehicles.

PRO TIP: Apply Rain-X® or a similar anti-beading solution to the camera housing lens to prevent water spots from forming when using your camera in rain or water.

SWAPPING BACKDOORS

You can switch the backdoor of your HERO4 Silver camera to suit your activity and shooting conditions.

To Change the Backdoor:

1. Open the backdoor of the housing so that it hangs downwards.
2. Firmly pull the backdoor downwards until it snaps free from the main housing.
3. Line up the replacement backdoor into the hinge opening.
4. Push upwards on the backdoor until it clicks into place.

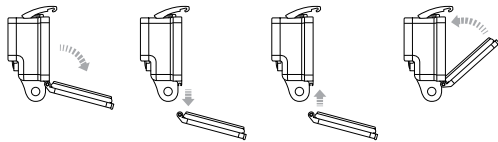

PREVENTING WATER DAMAGE TO YOUR CAMERA

The rubber seal that lines the camera housing forms a waterproof barrier that protects your HERO4 Silver in wet and underwater conditions.

Keep the camera housing's rubber seal clean. A single hair or grain of sand can cause a leak and damage your camera.

After every use in salt water, rinse the outside of the camera housing with non-salt water and dry. Not doing this can eventually cause corrosion of the hinge pin and salt buildup in the seal, which can cause failure.

To clean the seal, rinse in fresh water and shake dry (drying with a cloth may cause lint to compromise the seal). Re-install the seal into the grooves in the backdoor of the camera housing.



WARNING: Failure to follow these steps each time you use your GoPro can result in leaks that may damage or destroy your camera. Water will damage both the camera and the battery, which could cause an explosion or fire. Your warranty does not cover water damage resulting from user error.

ATTACHING YOUR CAMERA TO MOUNTS

To attach your HERO4 Silver camera to a mount, you need a Quick Release Buckle and/or thumb screw, depending on the mount you are using. For more information on mounts, visit gopro.com/support.

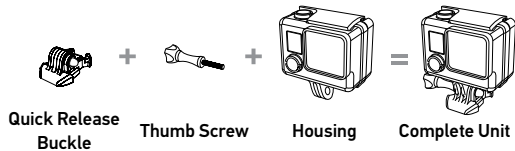

USING CURVED + FLAT ADHESIVE MOUNTS

The Curved + Flat Adhesive Mounts make it easy to attach the camera to curved and flat surfaces of helmets, vehicles and gear. Using the Quick Release Buckle, the assembled camera housing can be clicked on and off the secured Curved or Flat Adhesive Mounts.

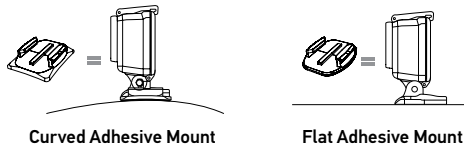

MOUNTING GUIDELINES

Follow these guidelines when attaching adhesive mounts:

- Attach the adhesive mounts at least 24 hours prior to use.
- Adhesive mounts must be mounted only on smooth surfaces. Porous or textured surfaces do not enable a proper bond. When applying the mount, firmly press it into place and ensure full contact over the entire surface.
- Apply adhesive mounts to clean surfaces only. Wax, oil, dirt or other debris reduce adhesion, which can result in a weak bond and risk of losing the camera should the connection fail.
- Attach adhesive mounts in room temperature conditions. Mount adhesives do not bond properly if applied in cold or damp environments to cold or damp surfaces, or if the surface is not room temperature.

For more information on mounts, visit gopro.com/support.

WARNING: If using your camera with a GoPro mount or strap intended for use with a helmet, always select a helmet that meets the applicable safety standard.



Choose the right helmet for your particular sport or activity and make sure that it is the right fit and size for you. Inspect your helmet to ensure that it is in good condition and follow the helmet manufacturer's instructions on safe helmet use.

Any helmet that has sustained a major impact should be replaced. No helmet can protect against injury in every accident.

LOCKING PLUG

If you are using HERO4 Silver in sports such as surfing or skiing, use the standalone white locking plug to securely lock the Quick Release Buckle fingers into place.

To Attach the Locking Plug:

1. Loop the circular ring over the thumbscrew. The circular ring acts as a leash to prevent dropping or losing the locking plug.
2. Slide the Quick Release Buckle into the mount until it clicks into place.
3. Press the U-shaped part of the plug into the U-shaped space in the Quick Release Buckle.

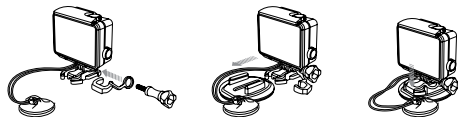

WARNING: To avoid injury in the event of an accident, do not use the locking plug or tether when using a mounting device on a helmet or other personal protective gear.

MY GOPRO WON'T POWER ON

Make sure your GoPro is charged. To charge your camera, use the included USB cable and a computer. You can also use the GoPro Wall or Auto Charger.

MY GOPRO WON'T RESPOND WHEN I PRESS A BUTTON

Press and hold the **Power/Mode** button [] for 8 seconds to reset your camera. This reset saves all of your content and settings, and powers off your camera.

MY PLAYBACK IS CHOPPY

Choppy playback is typically not a problem with the file. If your footage skips, one of these situations is likely the cause:

- Using an incompatible video player. Not all video players support the H.264 codec. For best results, use the latest GoPro software, available for free at gopro.com/getstarted.
- The computer does not meet the minimum requirements for HD playback. The higher the resolution and frame rate of your video, the harder the computer has to work to play it back. Make sure that your computer meets the minimum requirements listed in *Playback Mode*.
- Playing a high bitrate HD video file over a low bandwidth USB connection. Transfer the file to the computer to play back.

If your computer does not meet the minimum requirements, record at 720p30 with Protune off, and make sure that all other programs on your computer are closed.

I FORGOT MY CAMERA'S USERNAME OR PASSWORD

To reset the username and password to the defaults, go to **Setup** mode. Tap Camera Reset, and then tap Reset Wi-Fi. The camera name is reset, and the password is reset to *goprohero*.

I WANT TO RESET MY GOPRO SETTINGS TO THE DEFAULTS

In **Setup** mode, select Camera Reset, and then select Reset Defaults. This option does not reset the Date/Time or your camera's username and wireless password.

I POWERED OFF MY GOPRO, BUT THE BLUE LIGHT IS STILL BLINKING

The blue light indicates that Wireless is on. To turn off Wireless, press and hold the **Settings/Tag** button [] for four seconds.

For more answers to commonly asked questions, see gopro.com/support.

GoPro is dedicated to providing the best possible service. To reach GoPro Customer Support, visit [**gopro.com/support**](http://gopro.com/support).

/ Trademarks

GoPro, HERO, the GoPro logo, the GoPro Be a HERO logo, BacPac, Protune, SuperView, and Wear It. Mount It. Love It. are trademarks or registered trademarks of GoPro, Inc. in the US and internationally. Other names and marks are the property of their respective owners.

/ Regulatory Information

To see the complete list of country certifications, refer to the Important Product + Safety Information included with your camera.

