

HERO 6

BLACK

USER MANUAL

JOIN THE GOPRO MOVEMENT



facebook.com/GoPro



youtube.com/GoPro



twitter.com/GoPro



instagram.com/GoPro

TABLE OF CONTENTS

Your HERO6 Black	6
Getting Started	8
Navigating Your GoPro	17
Map of Modes and Settings	22
Capturing Video and Photos	24
Settings for Your Activities	26
QuikCapture	28
Controlling Your GoPro with Your Voice	30
Playing Back Your Content	34
Using Your Camera with an HDTV	37
Connecting to Other Devices	39
Offloading Your Content	41
Video Mode: Capture Modes	45
Video Mode: Settings	47
Video Mode: Advanced Settings	55
Photo Mode: Capture Modes	57
Photo Mode: Settings	59
Photo Mode: Advanced Settings	61
Time Lapse Mode: Capture Modes	63

TABLE OF CONTENTS

Time Lapse Mode: Settings	65
Time Lapse Mode: Advanced Settings	69
Advanced Controls	70
Connecting to an Audio Accessory	80
Customizing Your GoPro	81
Important Messages	85
Resetting Your Camera	86
Mounting	87
Removing the Side Door	5
Maintenance	93
Battery Information	94
Troubleshooting	97
Customer Support	99
Trademarks	99
HEVC Advance Notice	100
Regulatory Information	100

YOUR HERO6 BLACK

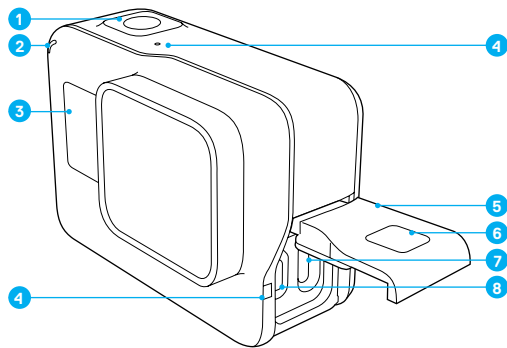

1. Shutter Button []
2. Camera Status Light
3. Camera Status Screen
4. Microphone
5. Side Door

6. Latch Release Button
7. USB-C Port
8. Micro HDMI Port
(cable not included)
9. Touch Display

YOUR HERO6 BLACK

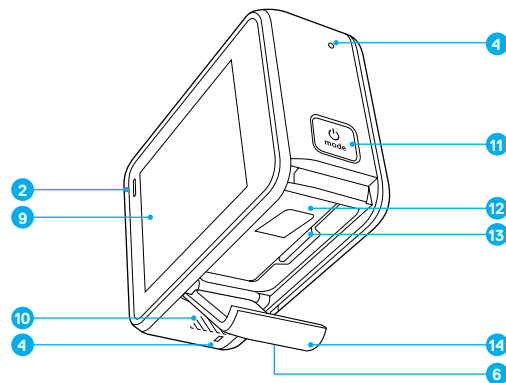

10. Speaker
11. Mode Button []
12. Battery
13. microSD Card Slot
14. Battery Door

For information about mounting items that are included in the box, see *Mounting* (page 87).

GETTING STARTED

Welcome to your new HERO6 Black! Let's get started.

MICROSD CARDS

To capture video and photos, you need a microSD card (sold separately).

Use brand name memory cards that meet these requirements:

- microSD, microSDHC, or microSDXC
- Class 10 or UHS-I rating
- Capacity up to 256GB

For a list of the recommended microSD cards, visit gopro.com/workswithgopro.

If the memory card becomes full during recording, your camera stops recording and displays *FULL* on the touch display.

NOTICE: Use care when handling memory cards. Avoid liquids, dust and debris. As a precaution, power off the camera before inserting or removing the card. Check the memory card manufacturer's guidelines for information about use in acceptable temperature ranges.

Inserting the microSD Card

1. Hold down the **Latch Release** button on the battery door, then slide the door open.

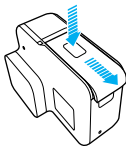

GETTING STARTED

2. Insert a microSD card with the label facing the battery, then close the door.

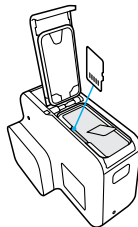

Note: To remove the card, press it into the slot with your fingernail and it will pop out.

Reformatting Your microSD Card

For best performance, always reformat your microSD card before first use. To keep the card in good condition, reformat it on a regular basis.

Note: Reformatting erases all of your content, so be sure to offload your photos and videos first.

To reformat your card, swipe down, then tap Preferences > Format SD Card > Delete.

GETTING STARTED

CHARGING THE BATTERY

For the best experience with your new camera, fully charge the battery before first use.

1. Hold down the **Latch Release** button on the battery door, then slide the door open.

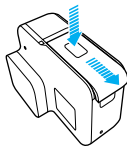

2. Insert the battery, then close the door.

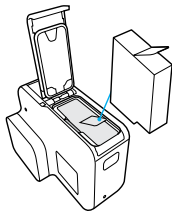

GETTING STARTED

3. Hold down the **Latch Release** button on the side door, then slide the door open.

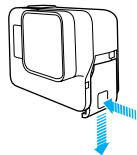

4. Connect the camera to a computer or other USB charging adapter using the included USB-C cable. The camera status light turns on during charging and turns off when charging is complete.
When charging with a computer, be sure that the computer is connected to a power source. If the camera status light does not turn on, use a different USB port.

The battery charges to 100% in about 2 hours. For more information, see [Battery Information](#) (page 94).

PRO TIP: For fastest charging, use GoPro's Supercharger (sold separately) and its included cable. You can also charge your camera with a USB-compatible wall charger or auto charger.

GETTING STARTED

UPDATING YOUR CAMERA SOFTWARE

To get the latest features and best performance from your GoPro, make sure your camera is always using the most current software.

Updating with the GoPro App

When you connect your camera to the GoPro app, you are automatically notified if an update is available.

1. Download the app from the Apple® App Store® or Google Play.™
2. Follow the on-screen instructions in the app to connect your camera.
If an update is available, the app provides instructions for installing it.

Updating with the Quik Desktop App

When you connect your camera to the Quik desktop app, you are automatically notified if an update is available.

1. Download the Quik desktop app from gopro.com/apps.
2. Connect your camera to your computer with the included USB-C cable. If an update is available, the app provides instructions for installing it.

Updating Manually (with an SD Card Reader/Adapter)

1. Visit gopro.com/update.
2. Select your camera, then click the option to update the camera manually.
3. Follow the on-screen instructions.

PRO TIP: To see your current software version, swipe down from the main screen, then tap Preferences > About This GoPro.

GETTING STARTED

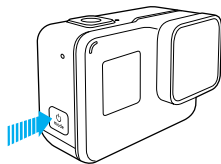

POWERING ON + OFF

To Power On:

Press the **Mode** button []. The camera beeps several times while the camera status lights flash. When information appears on the touch display or the camera status screen, your camera is on.

To Power Off:

Press and hold the **Mode** button [] for two seconds. The camera beeps several times while the camera status lights flash.



WARNING: Use caution when using your GoPro as part of your active lifestyle. Always be aware of your surroundings to avoid injury to yourself and others.

Abide by all local laws when using your GoPro and related mounts and accessories, including all privacy laws, which may restrict recording in certain areas.

GETTING STARTED

CAMERA STATUS SCREEN

You can see the basics for your current setting on the front screen of the camera:

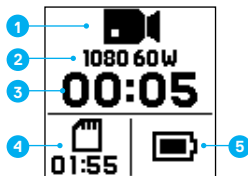

1. Camera Mode
2. Settings
3. Number of Files Captured or Video Duration
4. Remaining microSD Card Storage
5. Battery Status

Note: The icons and settings that appear on the camera status screen vary by mode. Those shown above are for Video mode.

GETTING STARTED

TOUCH DISPLAY

The touch display's main screen contains the following information about modes and settings. The settings that appear vary by mode.

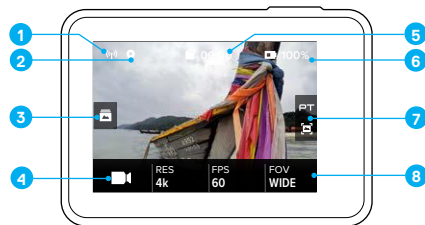

1. Wireless Status
2. GPS Status
3. Media Status*
4. Camera Mode
5. Time Remaining/Photos Taken
6. Battery Status
7. Advanced Settings (icons)
8. Settings

Note: The touch display does not work under water.

**Icon is visible only if your memory card contains footage. Swipe right to access your video and photos.*

GETTING STARTED

TOUCH DISPLAY GESTURES

Use these gestures to navigate the touch display. When swiping, swipe from the edge of the screen.

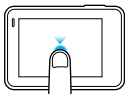

Tap

Selects an item, turns a setting on/off.

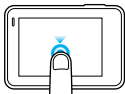

Press and Hold

Accesses Exposure Control setting.

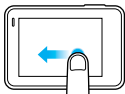

Swipe Left

Accesses advanced settings (if available) for the current mode.

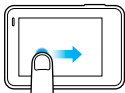

Swipe Right

Displays your media.

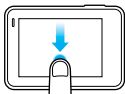

Swipe Down

From the main screen, opens the Connections and Preferences menus. Otherwise, returns to the main screen.

PRO TIP: You can automatically lock the touch display to prevent accidental input. For details, see [Auto Lock](#) (page 83).

NAVIGATING YOUR GOPRO

MODES

HERO6 Black contains three camera modes: Video, Photo, and Time Lapse.

Video

Video mode contains two capture modes: Video and Looping. For descriptions of each capture mode, see [Video Mode: Capture Modes](#) (page 45).

Photo

Photo mode contains three capture modes: Photo, Burst, and Night. For descriptions of each capture mode, see [Photo Mode: Capture Modes](#) (page 57).

Time Lapse

Time Lapse mode contains three capture modes: Time Lapse Video, Time Lapse Photo, and Night Lapse Photo. For descriptions of each capture mode, see [Time Lapse Mode: Capture Modes](#) (page 63).

For a visual map of your GoPro's modes and settings, see [Map of Modes and Settings](#) (page 22).

NAVIGATING YOUR GOPRO

NAVIGATING WITH THE TOUCH DISPLAY

1. From the main screen, tap the icon in the lower left corner.
2. Tap one of the mode icons at the top of the screen (Video, Photo, or Time Lapse).
3. Tap a capture mode in the list below it.

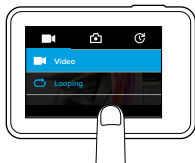

4. On the main screen, tap the setting that you want to change.
5. Tap a new option (available options are white). The camera returns you to the main screen.



NAVIGATING YOUR GOPRO

If you select a video resolution (RES) that does not support the frames per second (FPS) setting that is selected, a message appears that tells you how to select a new FPS setting. A similar message appears if you select an FPS that is not supported by the selected resolution.

6. To change an advanced setting, swipe left.

Note: Not all capture modes have advanced settings.

7. To turn on an advanced setting, tap [].

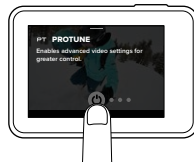

8. To return to the main screen, swipe down.

NAVIGATING YOUR GOPRO



CHANGING MODES WITH THE MODE BUTTON

The **Mode** button lets you quickly cycle through the capture modes that you set. For example, if you previously selected Video in Video mode, Night Photo in Photo mode, and Time Lapse Video in Time Lapse mode, pressing the **Mode** button cycles through those capture modes. Note that Burst photo always appears in this cycle.

NAVIGATING WITH THE BUTTONS

If you use the camera under water, use the buttons and the camera status screen to change modes and settings.

Note: The Connections and Preferences menus are not available when navigating with the buttons.

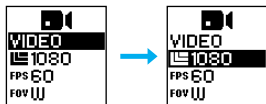

1. With the camera powered on, hold down the **Mode** button [] and press the **Shutter** button [].
2. Use the **Mode** button [] to scroll through the settings.

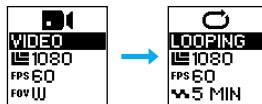

NAVIGATING YOUR GOPRO

3. Press the **Shutter** button [] to move through the options within a setting. To select an option, leave the option highlighted.



4. To exit, select one of these options:
 - Press and hold the **Shutter** button [].
 - Press the **Mode** button [] repeatedly until you get to Done, then press the **Shutter** button [] to select it.

MAP OF MODES AND SETTINGS

MAP OF MODES AND SETTINGS

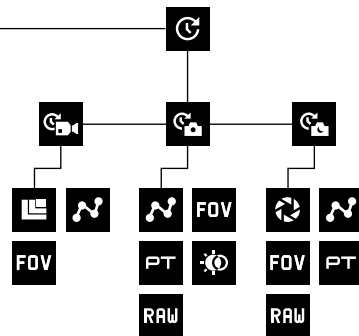
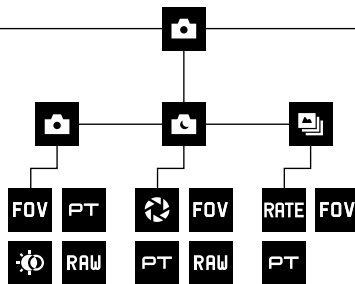
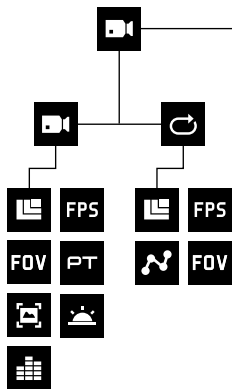

 Auto Low Light

 Burst

FOV FOV

FPS FPS

 High Dynamic Range (HDR)

 Interval

 Looping

 Manual Audio Control

 Night Photo

 Night Lapse Photo

 Photo Mode / Photo

PT Protune

RATE Rate

RAW RAW Format

 Resolution (RES)

 Shutter

 Time Lapse Mode

 Time Lapse Photo

 Time Lapse Video

 Video Mode / Video

 Video Stabilization

CAPTURING VIDEO AND PHOTOS

CAPTURING VIDEO AND PHOTOS

With this method, you leave the camera powered on and capture, as needed. You can use the touch display to preview your shots and change modes and settings before capturing.

1. If needed, select a different mode:
 - a. Tap the icon in the lower left corner of the touch display.



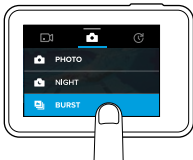

- b. Tap one of the mode icons at the top of the screen.
- c. Tap a capture mode in the list below it.



2. If needed, select different settings. For details about settings, see [Video Mode: Capture Modes](#) (page 45), [Photo Mode: Capture Modes](#) (page 57), or [Time Lapse Mode: Capture Modes](#) (page 63).

CAPTURING VIDEO AND PHOTOS

3. Press the **Shutter** button []. The camera beeps and the camera status lights flash while the camera is capturing.
4. To stop capturing video or time lapse, press the **Shutter** button []. The camera beeps and the camera status lights flash quickly.

PRO TIP: You can also capture video and photos using voice commands. For details, see [Controlling Your GoPro with Your Voice](#) (page 30).

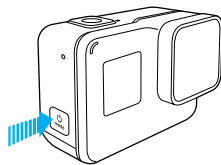

ADDING HIGHLIGHT TAGS

You can mark specific moments in your video during recording or playback with HiLight Tags. HiLight Tags make it easy to find the best highlights to share.

While recording or playing back video, press the **Mode** button [].

PRO TIP: You can also add HiLight Tags during recording with the GoPro app, Voice Control, or the Smart Remote.

SETTINGS FOR YOUR ACTIVITIES

For best results, use the guidelines below when capturing specific activities.

Activity	Video Setting	Photo Capture Mode
Automobile	<ul style="list-style-type: none">1080p60, Wide FOV2.7K120, Wide FOV4K60, Wide FOV	Photo or continuous photo, Wide FOV
Family/travel	<ul style="list-style-type: none">1080p60, Wide FOV4K60, Wide FOV	Photo or continuous photo, Wide FOV
Cycling, mountain biking	<ul style="list-style-type: none">1080p60, SuperView FOV1440p60, Wide FOV2.7K60 4:3, Wide FOV	Time Lapse Photo (2-second Interval), Wide FOV
Hiking	<ul style="list-style-type: none">1440p30, Wide FOV4K30 4:3, Wide FOV	Time Lapse Photo (5-second Interval), Wide FOV, or Photo, Wide FOV
Flying the Karma Drone	<ul style="list-style-type: none">1080p60, Linear FOV4K60, Wide FOV	Time Lapse Photo (2-second Interval), Wide FOV, or Photo with RAW Format setting on and Wide FOV

SETTINGS FOR YOUR ACTIVITIES

Activity	Video Setting	Photo Capture Mode
Motorcycle, motocross	<ul style="list-style-type: none">1080p60, SuperView FOV2.7K60 4:3, Wide FOV	Time Lapse Photo (2-second Interval), Wide FOV
Skiing, snowboarding (non-POV*)	<ul style="list-style-type: none">1080p120, Wide FOV1080p240, Wide FOV2.7K120, Wide FOV4K60, Wide FOV	Burst (30/3 Rate), Wide FOV
Skiing, snowboarding (POV*)	<ul style="list-style-type: none">1440p60, Wide FOV2.7K60 4:3, Wide FOV	Time Lapse Photo (0.5-second Interval), Wide FOV, or Burst (30/3 Rate), Wide FOV
Surfing	<ul style="list-style-type: none">1080p240, Wide FOV	Time Lapse Photo (5-second Interval), Wide FOV
Underwater activities	<ul style="list-style-type: none">1080p60, Wide FOV4K60, Wide FOV	Time Lapse Photo (2-second Interval), Wide FOV
Water activities	<ul style="list-style-type: none">1080p120, Wide FOV1080p240, Wide FOV2.7K120, Wide FOV	Time Lapse Photo (5-second Interval), Wide FOV

*Point of view (POV) shots are those taken from your point of view. Non-POV shots are those taken from a different perspective (for example, with the camera mounted on a ski pole or surfboard).

PRO TIP: Get an awesome video of your activity—automatically. For details, see [Creating a QuikStory](#) (page 41).

QUIKCAPTURE

QuikCapture is the easiest way to capture video or time lapse photos with HERO6 Black. Because the camera is powered on only when it is capturing, you also conserve battery power.

CAPTURING VIDEO WITH QUIKCAPTURE

1. With the camera powered off, press the **Shutter** button [].

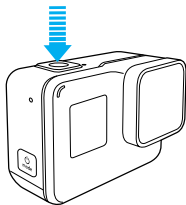

Your camera powers on, beeps several times, and automatically begins capturing video. The camera status lights blink while the camera is recording.

2. To stop recording, press the **Shutter** button [] again.
The camera stops recording, beeps several times, and automatically powers off.

To capture other types of video or photos, see [Capturing Video and Photos](#) (page 24).

QUIKCAPTURE

CAPTURING TIME LAPSE PHOTOS WITH QUIKCAPTURE

In addition to showing how a scene changes over time, time lapse photos are also useful for capturing a series of photos to be sure you get the shot you want.

1. With the camera powered off, press and hold the **Shutter** button [] for three seconds until capture begins.

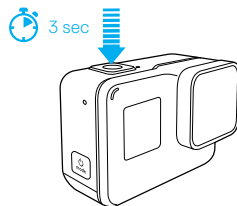

Your camera powers on, beeps several times, and automatically begins capturing time lapse photos. The camera status lights blink once for each photo captured.

2. To stop capturing, press the **Shutter** button [] again.
The camera stops recording, beeps several times, and automatically powers off to maximize battery life.

To capture other types of video or photos, see [Capturing Video and Photos](#) (page 24).

TURNING QUIKCAPTURE OFF

QuikCapture is on by default, but you can turn it off, if needed.

1. From the main screen, swipe down.
2. Tap Preferences > QuikCapture.
3. Tap Off.



CONTROLLING YOUR GOPRO WITH YOUR VOICE

You can control your HERO6 Black with your voice using a set of specific commands (see list below).

Note: Voice Control performance may be impacted by distance, wind, and noisy conditions. Keep the product clean and clear of debris.

USING VOICE CONTROL

Voice Control works best when you and your GoPro are in close proximity.

1. From the main screen, swipe down.
2. Tap [] to turn on Voice Control.
Note: You can also turn Voice Control on or off from the Preferences menu. Tap Preferences > On Camera Voice Control, then select an option.
3. If this is the first time you turned on voice control, confirm or change the voice control language.
4. Say a command from [List of Voice Commands](#) (page 31).
5. To turn off Voice Control manually, swipe down on the main screen, then tap []. Voice Control also turns off when your camera automatically powers off. For details, see [Auto Off](#) (page 82).

PRO TIP: To extend the voice control of your camera in windy and noisy environments, use Remo (Waterproof Voice Activated Remote). For details, visit gopro.com.

CONTROLLING YOUR GOPRO WITH YOUR VOICE

LIST OF VOICE COMMANDS

Two types of commands are available with Voice Control:

- Action commands let you immediately capture video or photos. For example, if you just stopped recording video, you can say the command to take a photo or begin capturing time lapse—without having to first change the mode.
- Mode commands are useful if you want to quickly select a mode and then use the **Shutter** button to capture.

Your camera does not need to be in a specific mode to capture video or photos. You can use the action commands from any mode. Your camera captures video or photos based on the settings you previously selected.

Action Command	Description
GoPro turn on	Powers on the camera [see Powering On Your GoPro with Your Voice (page 33) for details]
GoPro start recording	Starts capturing video
GoPro HiLight	Adds a HiLight Tag to video during recording
That was sick	Adds a HiLight Tag to video during recording
GoPro stop recording	Stops capturing video
GoPro take a photo	Captures a single photo
GoPro shoot burst	Captures burst photos
GoPro start time lapse	Starts capturing time lapse

CONTROLLING YOUR GOPRO WITH YOUR VOICE

Action Command	Description
GoPro stop time lapse	Stops capturing time lapse
GoPro turn off	Powers off the camera
GoPro edit my story	Moves video and photos from your most recent session (based on location and date) to your phone to create a QuikStory™ <i>Note: If the QuikStories feature is turned on in the GoPro app, video and photos are automatically moved from your camera to your phone to create a QuikStory. This voice command lets you move the content immediately instead of waiting for the automatic process.</i>

Mode Command	Description
GoPro Video mode	Changes the camera mode to Video (does <i>not</i> capture video)
GoPro Photo mode	Changes the camera mode to Photo mode (does <i>not</i> capture photos)
GoPro Burst mode	Changes the camera mode to Burst mode (does <i>not</i> capture burst photos)
GoPro Time Lapse mode	Changes the camera mode to Time Lapse (does <i>not</i> capture time lapse photos)



For the most updated list of commands, visit gopro.com/help.

CONTROLLING YOUR GOPRO WITH YOUR VOICE

PRO TIP: If you are recording video or time lapse, you must stop recording before issuing a new command.

POWERING ON YOUR GOPRO WITH YOUR VOICE

With this setting, your GoPro responds to voice commands when it is powered off. This setting is in effect for 8 hours after you power off your GoPro.

1. From the main screen, swipe down.
2. Tap [] to turn on Voice Control.
3. Tap Preferences > Wake On Voice (in the Voice Control section).
4. Tap On.
5. Power off the camera using either the voice command or the **Mode** button [].
6. Say a command from [List of Voice Commands](#) (page 31).

CHANGING YOUR VOICE CONTROL LANGUAGE

1. From the main screen, swipe down.
2. Tap Preferences > Language (in the Voice Control section).
3. Tap a language.

PLAYING BACK YOUR CONTENT

You can play back your content on a mobile device, a computer, the camera's touch display, or a TV.

VIEWING VIDEO AND PHOTOS ON A MOBILE DEVICE

1. Connect your camera to GoPro app. For details, see [Connecting to the GoPro App](#) (page 39).
2. Use the controls on the app to play back your footage on your smartphone/tablet.

PRO TIP: While playing back your video with the GoPro app, you can mark the best moments by tapping [] to add a HiLight Tag.

VIEWING VIDEO AND PHOTOS ON A COMPUTER



To play back your video and photos on a computer, you must first transfer these files to a computer. For details, see [Offloading Your Content](#) (page 41).

You can also play back content by inserting the microSD card directly into a computer. With this method, playback resolution depends on the resolution of the computer and its ability to play back that resolution.



When viewing files on a microSD card or in your computer's file directory, you can see that videos are saved as both .mp4 and .lrv files. Files with an .lrv extension cannot be played or shared directly.

PLAYING BACK YOUR CONTENT

VIEWING VIDEO AND PHOTOS ON YOUR HERO6 BLACK

1. Swipe right to access your video and photos. If your microSD card contains a lot of content, it might take a minute for it to load.
2. To display only a certain type of content, select a filter:
 - Media - Displays all videos and photos.
 - HiLights - Displays content that includes a HiLight Tag.
 - Photos - Displays photos, including those that are part of a series (continuous, burst, time lapse, night lapse).
 - Video - Displays videos. Swipe up to scroll through the thumbnails.
Note: For multi-shot photo series, the thumbnail displays the first photo in the series.
3. Tap a video or photo to open it in full-screen view.
Note: For multi-shot photo series, press and hold to open the series.
4. To add a HiLight Tag, tap []. HiLight Tags make it easy to find the best video and photos to share.
5. To return to the thumbnails screen, tap [].
6. To exit, swipe down.

DELETING VIDEO AND PHOTOS FROM YOUR HERO6 BLACK

1. Swipe right to access your video and photos.
2. Tap [].
3. Tap the items that you want to delete. To delete everything on the card, tap [].
4. Tap [].
5. Tap Delete.

PLAYING BACK YOUR CONTENT

SAVING A PHOTO FROM A SERIES

You can save an individual photo from a burst, time lapse photo, or night photo series.

1. Swipe right, then tap the photo series that contains the photo that you want to save.
2. Press and hold the series to open it.
3. Tap [▶] to move through the series.
4. Tap [📷] to save a photo outside of the series.

VIEWING VIDEO AND PHOTOS ON AN HDTV

For details, see *Using Your Camera with an HDTV* (page 37).

USING YOUR CAMERA WITH AN HDTV

VIEWING VIDEOS AND PHOTOS ON AN HDTV

You can connect your camera to an HDTV and view your content on the large screen. This playback requires a micro HDMI cable (sold separately).

Note: HDMI playback depends on the resolution of the device, and is certified up to 1080p.

1. Power on the camera.
2. Tap Preferences > HDMI Output > Media.
3. Use a micro HDMI cable to connect the HDMI port on the camera to an HDTV.
4. Select the HDMI input on your TV.
5. Press the **Mode** button [ⓘ] to move through the controls, then press the **Shutter** button [⊙] to select the control.
For example, to move through each thumbnail, press the **Mode** button [ⓘ] to move to [▶], then press the **Shutter** button [⊙] repeatedly to move through the files.
6. To open a file in full-screen view, tap [📺].

You can also play back content by inserting the microSD card directly into a compatible TV. With this method, playback resolution depends on the resolution of the TV and its ability to play back that resolution.

PRO TIP: When viewing your videos and photos on an HDTV, you can also navigate using gestures on the touch display.

USING YOUR CAMERA WITH AN HDTV

CAPTURING VIDEO AND PHOTOS WHILE CONNECTED TO AN HDTV

This option lets you see the live preview from your camera when it is connected to an HDTV or monitor.

1. Power on the camera.
2. Tap Preferences > HDMI Output, then select one of these options:
 - To display your camera's live preview with the icons from the touch display, tap Monitor.
 - To display your camera's live preview on the HDTV without the icons or overlays that you see during recording on the camera's touch display, tap Live.
3. Use a micro HDMI cable to connect the HDMI port on the camera to an HDTV.
4. Select the HDMI input on your TV.
5. Use the **Shutter** button [] on the camera to start and stop recording.

CONNECTING TO OTHER DEVICES

CONNECTING TO THE GOPRO APP

With the GoPro app, your HERO6 Black footage automatically moves to your phone and transforms into a QuikStory™—an awesome video with effects and music. You can also use the app to control your GoPro, create short clips, share your favorites, and more.

Connecting to the GoPro App for the First Time

1. Download the GoPro app to your mobile device from the Apple® App Store® or Google Play™.
2. Follow the app's on-screen instructions to connect your camera.

Note for iOS: When prompted, be sure to allow notifications from the GoPro app so you know when a QuikStory is ready. For more information, see [Creating a QuikStory](#) (page 41).

Connecting to the GoPro App after the First Time

After connecting to the GoPro app for the first time, you can connect in the future through the Connections menu on the camera.

1. If your camera's wireless is not already turned on, swipe down, then tap Connections > Wireless Connections.
2. In the GoPro app, follow the on-screen instructions to connect your camera.

CONNECTING TO THE SMART REMOTE OR REMO

For details about connecting HERO6 Black to the Smart Remote or Remo (Waterproof Voice Activated Remote), see the user manual for the device at gopro.com/help.

CONNECTING TO OTHER DEVICES

CONNECTING TO BLUETOOTH DEVICES

You can connect your GoPro to Bluetooth devices that track statistics about your activity. That data is then automatically added to your video to create a more engaging record of your activity.

1. Connect your camera to the GoPro app. For details, see [Connecting to the GoPro App](#) (page 39).
2. In the app, open the camera's settings, then tap Bluetooth Devices.
3. Follow the on-screen instructions.

SELECTING A DIFFERENT CONNECTION SPEED

By default, your GoPro uses the 5GHz Wi-Fi band to connect to other devices. This band provides faster transfer speed than the 2.4GHz band. The transfer speed affects how long it takes for your video and photos to be copied to your phone to create a QuikStory.

To use the 5GHz band, your phone and region must also work with that band. Otherwise, you can change the Wi-Fi band on your GoPro to 2.4GHz.

1. Swipe down, then tap Connections > Wi-Fi Band.
2. Tap 2.4GHz.

OFFLOADING YOUR CONTENT

CREATING A QUIKSTORY

QuikStories automatically copies video and photos from your camera to your mobile device. Then the GoPro app serves up an edited video, complete with music and effects—a QuikStory. You can save and edit your QuikStory, or delete it from your phone.

1. Set up QuikStories:
 - a. Connect your camera to the GoPro app. For details, see [Connecting to the GoPro App](#) (page 39).
Note for iOS: When prompted, be sure to allow notifications from the GoPro app.
 - b. Close the app.
2. Capture video and photos on your camera.
3. Open the GoPro app and swipe down from the home screen. Your camera automatically moves content from your most recent session to your mobile device. When your QuikStory is ready, you receive a notification on your phone.
4. Open the QuickStory and preview it.
5. Make additional edits, if needed.
6. Save the QuikStory, then share it with your friends.

OFFLOADING YOUR CONTENT TO A COMPUTER

To play back your video and photos on a computer, you must first transfer these files to a computer. Transferring also frees up space on your microSD card for new content.

1. Be sure that your computer is running the latest version of the operating system.
2. Download and install the Quik desktop app from gopro.com/apps.
3. Connect the camera to your computer using the included USB-C cable.
4. Power on the camera and follow the on-screen instructions in Quik.

OFFLOADING YOUR CONTENT

PRO TIP: To transfer files to a computer using a card reader (sold separately) and your computer's file explorer, connect the card reader to the computer, then insert the microSD card. You can then transfer files to your computer or delete selected files on your card. Note that you must use a card reader to offload RAW photos or RAW audio files.

AUTO UPLOADING YOUR CONTENT TO THE CLOUD

With a subscription to GoPro Plus, you can use Auto Upload to upload your content to the cloud. You can then view, edit, and share it from any of your devices.

Note: When you upload your content to the cloud, your original files remain on your camera.

1. Subscribe to GoPro Plus:
 - a. Download the GoPro app to your mobile device from the Apple® App Store® or Google Play™.
 - b. Follow the app's on-screen instructions to connect your camera.
 - c. If this is the first time you are connecting to the app, follow the on-screen instructions to subscribe to GoPro Plus. Otherwise, tap [] next to the image of your camera and follow the instructions.
2. Connect your camera to a power outlet. When the battery is charged, Auto Upload begins.

Note: Once you set up Auto Upload, you do not need to connect your camera to the GoPro app to use this feature.

The files in the cloud are optimized for the web, so might not be full resolution. To offload files in their full resolution, connect your camera to the Quik desktop app and offload the files to your computer.

PRO TIP: You can also use the Quik desktop app to transfer your files to your computer. Quik then uploads the files to your GoPro Plus account.

OFFLOADING YOUR CONTENT

MANUALLY UPLOADING YOUR CONTENT TO THE CLOUD

This option lets you upload content to the cloud without waiting for the camera battery to charge. (Your GoPro must be connected to a power outlet to use this option.)

1. Subscribe to GoPro Plus. For details, see [Auto Uploading Your Content to the Cloud](#) (page 42).
2. Connect your camera to a power outlet.
3. From the main screen, swipe down.
4. Tap Preferences > Manual Upload.

ACCESSING YOUR CLOUD CONTENT ON YOUR MOBILE DEVICE

1. Open the GoPro app.
2. Tap [], and then select Cloud. You can view, edit, and share your content.

PRO TIP: To turn your cloud content into an edited video, open the Quik app, tap [], then select GoPro Plus.

TURNING OFF AUTO UPLOAD

You can temporarily turn off Auto Upload on the camera to prevent automatic upload to GoPro Plus when you connect your camera to a power outlet.

1. Swipe down, then tap Connections > Auto Upload > Upload.
2. Tap Off.

OFFLOADING YOUR CONTENT

CONNECTING TO A DIFFERENT WIRELESS NETWORK

If you want to use a different wireless network for Auto Upload, you can select that network from the camera.

1. Swipe down, then tap **Connections > Auto Upload > Networks**.
2. Tap the name of a network. The network must not be hidden or require an end user license agreement (such as the network in a hotel).
3. If needed, enter the password.
4. Tap [✓] to save the new network.

VIDEO MODE: CAPTURE MODES

Video mode contains two capture modes: Video and Looping. Each capture mode has its own settings.

VIDEO

This capture mode is for traditional video capture. The default settings are 1080p60 Wide, with Video Stabilization and Auto Low Light both turned on. For more information, see these topics:

 [HERO06 Black Video Resolutions](#) (page 51)

 [Protune](#) (page 74)

 [Video Stabilization](#) (page 55)

 [Auto Low Light](#) (page 55)

 [Manual Audio Control](#) (page 56)

LOOPING VIDEO

Use Looping to continuously record video, but save only the moments that you want. For example, if you select a 5-minute interval, only the previous 5 minutes are saved when you press the **Shutter** button to stop recording. If you record for 5 minutes and do not press the **Shutter** button to stop recording and save, the camera records a new 5-minute interval by recording over your previous 5 minutes of footage.

This capture mode is useful when you are recording events that contain long periods of inactivity that you don't want to save, such as fishing or recording from a car dashboard.

VIDEO MODE: CAPTURE MODES

The default settings for Looping are 1080p60 Wide, with the Interval set at 5 minutes. Looping is not available in 4K 4:3. For more information, see these topics:

 [HERO6 Black Video Resolutions](#) (page 51)

 [Interval \(Video\)](#) (page 54)

PRO TIP: Automatically create GoPro-style videos using QuikStories. For details, see [Creating a QuikStory](#) (page 41).

VIDEO MODE: SETTINGS

VIDEO RESOLUTION

Video resolution (RES) refers to the number of horizontal lines in the video. For example, 1080p means that the video has 1920 horizontal lines, each with a width of 1080 pixels. Higher numbers of lines and pixels result in greater detail and clarity. So, a video with resolution of 4K is considered higher quality than 1080p because it consists of 3840 lines, each with a width of 2160 pixels.

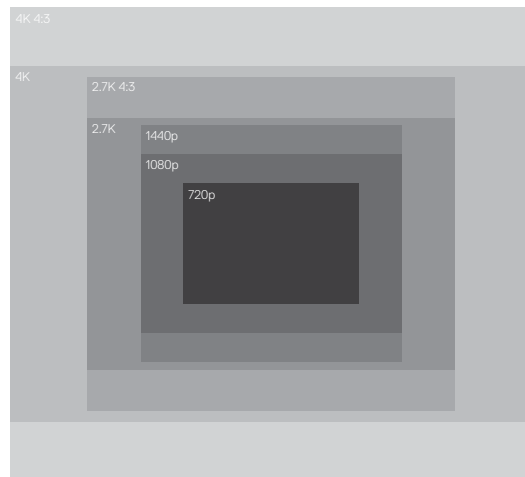

VIDEO MODE: SETTINGS

Use this table to help you determine the best resolution for your activity. Be sure to confirm that your phone, computer, or TV can support the selected setting, especially if you are using higher resolutions and frame rates.

Video Resolution	Best Use
4K	Stunning high-resolution video with 8MP stills available from video. Recommended for tripod or fixed position shots, automotive activities, and use with Karma or the Karma Grip.
4K 4:3	Highest resolution and clarity for point-of-view capture. This taller video frame provides additional view above and below a traditional 4K 16:9 frame.
2.7K	16:9 resolution video downscales to provide stunning, cinema-quality results for professional productions.
2.7K 4:3	Recommended for point-of-view body mounted/action mounted cameras that require high resolution and clarity with the ability for fluid slow motion.
1440p	Recommended for body-mounted shots. Aspect ratio of 4:3 captures a larger vertical viewing area, compared to 1080p. High frame rates yield smooth, immersive results for high-action capture. Great for sharing to social media.

VIDEO MODE: SETTINGS

Video Resolution	Best Use
1080p	Great for all shots and for sharing to social media. High resolution and frame rate yield stunning results. This resolution is available in all FOVs and its high FPS options (240 fps and 120 fps) enable slow motion during editing.
720p	Good for handheld shots and when slow motion is desired.

FRAMES PER SECOND (FPS)

Frames per second (FPS) refers to the number of video frames that are captured in each second.

When selecting a resolution and FPS, consider the activity that you want to capture. Higher resolutions result in greater detail and clarity, but are generally available at lower fps values. Lower resolutions result in less detail and clarity, but support higher FPS values, which are important for capturing motion. Higher FPS values can also be used to create slow-motion videos.

ASPECT RATIO

GoPro video resolutions use two aspect ratios: either 16:9 or 4:3. Standard televisions and editing programs use 16:9. Footage shot in 4:3 is 33% taller, but must be cropped to 16:9 for playback on a TV. (If footage is not cropped, it appears with black bars on the sides of the image.)

VIDEO MODE: SETTINGS

FIELD OF VIEW (FOV)

The field of view (FOV) refers to how much of the scene can be captured through the camera lens. For Video mode, SuperView FOV captures the largest amount of the scene, while Linear FOV captures the least.

The FOV options that appear are based on the selected resolution and fps.

FOV	Best Use
SuperView	SuperView delivers the world's most immersive field of view. Good for body-or gear-mounted shots. More vertical 4:3 content is automatically stretched to full-screen 16:9 for stunning widescreen playback on your computer or TV.
Wide (default)	Large field of view that is good for action shots where you want to capture as much as possible within the frame. This FOV results in a fisheye look, especially around the edge of the scene. (You can crop that out during editing, if needed.)
Linear	Mid-range field of view that removes the fisheye effect found in the Wide FOV. Subjects close to the edge of the frame might have some level of distortion, so this option might not be appropriate for those shots. Good for capturing aerial footage or any other shot where you want a more traditional perspective.

In addition to selecting an FOV, you can further zoom in or out on a subject. For details, see [Zoom](#) (page 70).

VIDEO MODE: SETTINGS

HERO6 BLACK VIDEO RESOLUTIONS

Video Resolution (RES)	FPS (NTSC/PAL) ¹	FOV	Screen Resolution	Aspect Ratio
4K	60/50	Wide	3840x2160	16:9
4K	30/25 24/24	Wide, SuperView	3840x2160	16:9
4K 4:3	30/25 24/24	Wide	4096x3072	4:3
2.7K	120/100	Wide	2704x1520	16:9
2.7K	60/50 30/25 24/24	Linear, Wide, SuperView	2704x1520	16:9
2.7K 4:3	60/50 30/25 24/24	Linear, Wide	2704x2028	4:3
1440p	60/50 30/25 24/24	Linear, Wide	1920x1440	4:3
1080p	240/200	Wide	1920x1080	16:9

VIDEO MODE: SETTINGS

Video Resolution (RES)	FPS (NTSC/PAL)	FOV	Screen Resolution	Aspect Ratio
1080p	120/100 60/50 30/25 24/24	Linear, Wide, SuperView	1920x1080	16:9
720p	60/50	Linear, Wide	1280x720	16:9

¹ NTSC and PAL refer to the video format, which depends on the region that you are in. For more information, see [Video Format](#) (page 37).

For more information about resolution, FPS, or FOV, see these topics:

 [Video Resolution](#) (page 47)

FPS [Frames Per Second \(FPS\)](#) (page 49)

FOV [Field of View \(FOV\)](#) (page 50)

For suggested settings, see [Settings for Your Activities](#) (page 26).

VIDEO MODE: SETTINGS



High Resolutions/High Frame Rates

When capturing video at high resolutions or high frame rates in warm ambient temperatures, the camera may become warm and use more power.

In addition, lack of airflow around the camera and using the camera with the GoPro app further increase camera temperature and power consumption, and decrease camera recording time.

If the camera gets too hot, a message appears on the screen indicating that the camera is shutting down. For details, see [Important Messages](#) (page 85).

When recording in high-performance video modes, capture shorter video clips when in stationary use, and/or limit your use of features that increase power consumption, such as the GoPro app. To control your camera remotely at higher temperatures, use a GoPro remote or Remo (Waterproof Voice Activated Remote) (both sold separately) instead of the GoPro app.

VIDEO MODE: SETTINGS



INTERVAL (LOOPING VIDEO)

The Interval setting applies to Looping and determines the length of each captured segment.

Available intervals are 5 (default), 20, 60, and 120 minutes. You can also select Max as the interval. With this option, the camera records until the memory card is full, then overwrites the content.

PT PROTUNE

In Video mode, Protune is available only for the Video capture mode. For details about Protune settings, see [Protune](#) (page 74).

VIDEO MODE: ADVANCED SETTINGS



VIDEO STABILIZATION

This setting adjusts the footage to offset for motion during capture. The result is smoother footage, especially in activities with relatively small but fast motion including cycling, motorcycling, and handheld uses. The options for this setting are On (default) and Off. To access this advanced setting, see [Navigating with the Touch Display](#) (page 18).

Video Stabilization is available for all resolutions, except 4K60, 4K 4:3, 2.7K120, 2.7K60 4:3, and 1080p240. For Wide FOV, the image is cropped 10%. This setting is not available for Looping video.

PRO TIP: The more narrow the FOV, the greater the effect of Video Stabilization.



AUTO LOW LIGHT

Auto Low Light allows you to shoot in low-light environments or when quickly transitioning in and out of low-light conditions. When possible, the camera automatically adjusts fps to achieve the optimal exposure and best results.

The options for this setting are On and Off (default). Auto Low Light is available for frame rates higher than 30 fps, except 240 fps.

When Auto Low Light and Video Stabilization are both on and Auto Low Light activates, Video Stabilization is temporarily turned off to deliver optimal image quality in the dark scene.

To access this advanced setting, see [Navigating with the Touch Display](#) (page 18).

VIDEO MODE: ADVANCED SETTINGS



MANUAL AUDIO CONTROL

By default, this setting is off and your camera automatically switches between recording in stereo and filtering wind noise to achieve the best audio balance. When this setting is on, you can manually select which of these two filters to apply.

For example, you might want to turn on this setting and select Wind Only if you are recording outdoors on a windy day. You might select Stereo Only if you are recording in a club or theater where consistent stereo audio is a priority and wind is not a factor.

To access this advanced setting, see [Navigating with the Touch Display](#) (page 18).

PHOTO MODE: CAPTURE MODES

Photo mode contains three capture modes: Photo, Night, and Burst. All photos are captured at 12MP. Each capture mode has its own settings.

PHOTO

Photo captures either single or continuous photos. For continuous photos, hold down the **Shutter** button. Continuous photos are captured at a rate of 3 or 30 photos per second, depending on lighting conditions.

The default FOV for Photo is Wide, with all advanced settings turned off. For more information, see these topics:

FOV [Field of View \(FOV\) \(Photos\)](#) (page 60)

PT [Protune](#) (page 74)

 [High Dynamic Range \(Photo\)](#) (page 61)

RAW [RAW Format](#) (page 62)

NIGHT

Night captures photos in dim to dark light. The shutter remains open longer to let in more light in dark environments, so Night is not recommended for handheld shots or mounted shots where the camera might move during exposure.

The default settings for Night are Wide FOV, with the Shutter set to Auto. For more information, see these topics:

 [Shutter \(Night Photo\)](#) (page 59)

FOV [Field of View \(FOV\) \(Photos\)](#) (page 60)

PT [Protune](#) (page 74)

RAW [RAW Format](#) (page 62)

PHOTO MODE: CAPTURE MODES

BURST

Burst captures up to 30 photos in 1 second, so it is perfect for capturing fast-moving activities. The default FOV for Burst is Wide, with the Rate set to 30 photos in 1 second. For more information, see these topics:

RATE *Rate* (page 59)

FOV *Field of View (FOV) (Photos)* (page 60)

PT *Protune* (page 74)

PHOTO MODE: SETTINGS



SHUTTER (NIGHT PHOTO)

In Photo mode, Shutter applies only to Night. This setting lets you determine the amount of time that the shutter is open. The default option is Auto.

Settings	Examples
Auto (up to 30 sec)	Sunrise, sunset, dawn, dusk, twilight, night
2 sec, 5 sec, 10 sec, 15 sec	Dawn, dusk, twilight, traffic at night, Ferris wheel, fireworks, light painting
20 sec	Night sky (with light)
30 sec	Night stars, Milky Way (complete darkness)

PRO TIP: To reduce the amount of blur when using Night, mount your camera on a tripod or other surface that is stable and cannot move.

RATE RATE

This setting applies only to Burst. These rates are available:

- Auto (up to 30 photos in 1 second)
- 30 photos in 1, 2, 3, or 6 seconds
- 10 photos in 1, 2, or 3 seconds
- 5 photos in 1 second
- 3 photos in 1 second

PHOTO MODE: SETTINGS

FOV FIELD OF VIEW (FOV) (PHOTOS)

Your camera includes two FOV options for photos. All photos are captured at 12MP.

FOV	Description
Wide	Largest field of view. Good for action shots to capture as much as possible within the frame. This FOV results in a fisheye look, especially around the edge of the scene. (You can crop that out during editing, if needed.)
Linear	Mid-range field of view that removes the fisheye effect found in the Wide FOV. Good for capturing aerial footage or any other shot where you want a more traditional perspective.

PHOTO MODE: ADVANCED SETTINGS

PT PROTUNE

In Photo mode, Protune is available for all three capture modes (Photo, Night, Burst). For details about Protune settings, see [Protune](#) (page 74).

HIGH DYNAMIC RANGE (PHOTO)

High Dynamic Range (HDR) retains a greater level of detail and color in an image. This setting is especially useful for scenes that include shadows or bright areas.

In Photo mode, HDR is available with these exceptions:

- HDR applies only to the Photo capture mode.
- HDR is not available for Continuous photos (that is, when pressing and holding the **Shutter** button while in the Photo capture mode).
- RAW Format and Exposure Control must be turned off.
- If Protune is turned on, HDR is available only if Exposure Value Compensation is less than zero and Color is set to GoPro Color.

The options for this setting are Off (default) and On. To access this advanced setting, see [Navigating with the Touch Display](#) (page 18).

PHOTO MODE: ADVANCED SETTINGS

RAW RAW FORMAT

When this setting is turned on, all photos are captured with an accompanying .jpg image for immediate viewing on your camera or sharing with the GoPro app. RAW photos are saved as .gpr files, which are based on the Adobe .dng format. These files can be used in Adobe Camera Raw (ACR), version 9.7 or later. You can also use Adobe Photoshop Lightroom CC (2015.7 release or later) and Adobe Photoshop Lightroom 6 (version 6.7 or later).

In Photo mode, RAW Format is available for Photo and Night, with these exceptions:

- High Dynamic Range must be turned off.
- FOV must be set to Wide.
- Zoom must be off.
- RAW Format is not available when capturing continuous photos (that is, when pressing and holding the **Shutter** button while in the Photo capture mode).

The options for this setting are Off (default) and On. To access this advanced setting, see [Navigating with the Touch Display](#) (page 18).

PRO TIP: Photos in .gpr format are captured in the same location and with the same file name as .jpg files. To access them, insert your microSD card into a card reader and locate the files with your computer's file explorer.

TIME LAPSE MODE: CAPTURE MODES

Time Lapse mode contains three capture modes: Time Lapse Video, Time Lapse Photo, and Night Lapse Photo. Each capture mode has its own settings.

TIME LAPSE VIDEO

Time Lapse Video creates video from frames captured at specific intervals. This option lets you capture a time lapse event and immediately view or share it as a video.

The default resolution for Time Lapse Video is 4K, with the default interval set at 0.5 second. Time Lapse Video is captured without audio. For more information, see these topics:



[Time Lapse Video Resolution](#) (page 65)



[Interval \(Time Lapse\)](#) (page 67)



[Field of View \(FOV\) \(Time Lapse\)](#) (page 68)

TIME LAPSE PHOTO

Time Lapse Photo captures a series of photos at specified intervals. Use this mode to capture photos of any activity, then choose the best ones later.

The default settings for Time Lapse Photo are Wide FOV with Interval set at 0.5 second. For more information, see these topics:



[Interval \(Time Lapse\)](#) (page 67)



[Field of View \(FOV\) \(Time Lapse\)](#) (page 68)



[Protune](#) (page 74)



[RAW Format \(Time Lapse\)](#) (page 69)

TIME LAPSE MODE: CAPTURE MODES

NIGHT LAPSE PHOTO

Night Lapse Photo captures a series of photos at set intervals when there is minimal light. The shutter remains open longer to let in more light in dark environments.

The default settings for Night Lapse Photo are Wide FOV, with Interval and Shutter both set to Auto. For more information, see these topics:

 [Shutter \(Time Lapse\)](#) (page 66)

 [Interval \(Time Lapse\)](#) (page 67)

FOV [Field of View \(FOV\) \(Time Lapse\)](#) (page 68)

PT [Protune](#) (page 74)

RAW [RAW Format \(Time Lapse\)](#) (page 69)

TIME LAPSE MODE: SETTINGS

TIME LAPSE VIDEO RESOLUTION

In Time Lapse mode, resolution and FOV apply only to Time Lapse Video.

Video resolution refers to the number of horizontal lines in the video. Higher resolutions result in greater detail and clarity. So, a video with resolution of 2.7K is considered higher quality than 1080p because it consists of 2704 lines, each with a width of 1520 pixels. (1080p video contains 1920 horizontal lines, each with a width of 1080 pixels.)

The field of view (FOV) refers to how much of the scene (measured in degrees) can be captured through the camera lens. Wide FOV captures the largest amount of the scene.

Available resolutions for Time Lapse Video are 4K, 2.7K 4:3, and 1080p.

TIME LAPSE MODE: SETTINGS



SHUTTER (TIME LAPSE)

In Time Lapse mode, this setting applies only to Night Lapse Photo. Shutter lets you determine the amount of time that the shutter is open. The default option is Auto.

Use this table to help you select the most appropriate setting for your activity:

Settings	Examples
Auto (up to 2 sec)	Sunrise, sunset, dawn, dusk, twilight, night
2 sec, 5 sec, 10 sec, 15 sec	Dawn, dusk, twilight, traffic at night, Ferris wheel, fireworks, light painting
20 sec	Night sky (with light)
30 sec	Night stars, Milky Way (complete darkness)

PRO TIP: To reduce the amount of blur when using Night Lapse Photo, mount your camera on a tripod or other surface that is stable and cannot move.

TIME LAPSE MODE: SETTINGS



INTERVAL (TIME LAPSE)

The Interval setting determines the amount of time that passes between each captured frame.

Time Lapse Photo and Time Lapse Video Intervals

Available intervals for Time Lapse Video are 0.5 (default), 1, 2, 5, 10, 30, and 60 seconds.

Interval	Examples
0.5-2 seconds	Surfing, biking or other sport
2 seconds	Busy street corner
5-10 seconds	Clouds or outdoor scenes with long durations
10-60 seconds	Lengthy activities, such as construction or artwork

Night Lapse Photo Interval

Interval determines the rate at which photos are captured. Night Lapse intervals are Auto, 4, 5, 10, 15, 20, and 30 seconds, and 1, 2, 5, 30, and 60 minutes.

Auto (default) causes the Interval to match the Shutter setting. For example, if Shutter is set to 10 seconds and Interval is set to Auto, your camera captures a photo every 10 seconds.

TIME LAPSE MODE: SETTINGS

Interval	Examples
Auto	Great for all exposures (captures as quickly as possible, depending on the Shutter setting)
4-5 seconds	Evening city scene, street lighting, or scenes with movement
10-15 seconds	Dim lighting with slow scene changes, like night clouds with a bright moon
20-30 seconds	Very low light or very slow scene changes, like stars with minimal ambient or street light

FOV FIELD OF VIEW (FOV) (TIME LAPSE)

Your camera includes two FOV options for time lapse.

FOV	Description
Wide	Largest field of view. Good for action shots to capture as much as possible within the frame. This FOV results in a fisheye look, especially around the edge of the scene. (You can crop that out during editing, if needed.)
Linear	Mid-range field of view that removes the fisheye distortion. Good for capturing aerial footage or any other shot where you want a more traditional perspective.

TIME LAPSE MODE: ADVANCED SETTINGS

PT PROTUNE

In Time Lapse mode, Protune is available for Time Lapse Photo and Night Lapse Photo. For details about Protune settings, see [Protune](#) (page 74).

RAW RAW FORMAT (TIME LAPSE)

When this setting is turned on, all photos are captured with an accompanying .jpg image for immediate viewing on your camera or sharing with the GoPro app. RAW photos are saved as .gpr files, which are based on the Adobe .dng format. These files can be used in Adobe Camera Raw (ACR), version 9.7 or later. You can also use Adobe Photoshop Lightroom CC (2015.7 release or later) and Adobe Photoshop Lightroom 6 (version 6.7 or later).

In Time Lapse mode, RAW Format is available for Time Lapse Photo and Night Lapse Photo, with these exceptions:

- High Dynamic Range must be turned off.
- FOV must be set to Wide.
- Zoom must be off.
- For Time Lapse Photo, the Interval must be at least 5 seconds.
- For Night Lapse Photo, the Shutter setting must be at least 5 seconds.

The options for this setting are Off (default) and On. To access this advanced setting, see [Navigating with the Touch Display](#) (page 18).

PRO TIP: Photos in .gpr format are captured in the same location and with the same file name as .jpg files. To access them, insert your microSD card into a card reader and locate the files with your computer's file explorer.

ADVANCED CONTROLS

ZOOM

The Zoom setting lets you adjust how close or far away the subject appears in your video or photo. The default is no zoom.

Adjusting the Zoom Level

1. Tap FOV.
2. Move the slider up or down to the zoom level that you want.
3. To exit the setting, tap the screen. The level that you set applies only to that capture mode and remains until you change capture modes or power off the camera.



This setting is available for all capture modes, with these exceptions:

- Zoom is available for all video resolutions, except 4K, 4K 4:3, 2.7K120, and 1080p240.
- Zoom is not available when the FOV is set to SuperView.
- For photo capture modes, Zoom is available only when RAW Format and Exposure Control are turned off.
- You cannot change the Zoom level while you are capturing video.

ADVANCED CONTROLS

EXPOSURE CONTROL

By default, your camera uses the entire image to determine the appropriate exposure level. However, Exposure Control lets you select an area that you want the camera to prioritize when determining exposure. This setting is particularly useful in shots where an important region might otherwise be over- or underexposed.

When you change this setting, the touch display immediately shows you the effect on your image. If you change capture modes, the camera returns to using the entire scene to determine the correct level of exposure.

Using Exposure Control with Auto Exposure

With this option, the camera always bases exposure on the area of the touch display that you select, regardless of what is in that area.

Suppose your camera is mounted on your dashboard. You might want to select the upper part of the touch display so that the exposure is based on the scene outside of the windshield and not on the dashboard (which might cause the scene outside to be overexposed).

1. Press the touch display until a square outline shrinks to the middle of the screen.
2. Drag the square to the area that you want to use to set the exposure level. (You can also tap that area instead of dragging the square.)
3. Tap [✓] in the lower right corner.

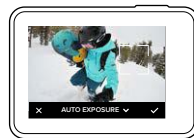

ADVANCED CONTROLS

Using Exposure Control with Locked Exposure

With this option, the camera locks the exposure. That exposure level remains until you cancel it.

For example, suppose you are snowboarding on a sunny day. By manually setting the exposure level based on your subject's jacket, the images that you capture throughout the day are based on the jacket. So, they are less likely to be underexposed compared to the bright snow.

1. Press the touch display until a square outline shrinks to the middle of the screen.
2. Drag the square to the area that you want to use to set the exposure level. (You can also tap that area instead of dragging the square.)
3. Tap Auto Exposure to change it to Locked Exposure.
4. Confirm that the exposure looks the way you want it to, and then tap [✓] in the lower right corner to lock the exposure.

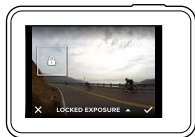

ADVANCED CONTROLS

Canceling Exposure Control

Exposure Control is automatically canceled when you select a different capture mode or restart the camera. You can also cancel this setting manually (below). When you cancel the exposure setting that you previously set, the camera returns to using the entire scene to determine the correct level of exposure.

1. Press the touch display until a square outline shrinks to the middle of the screen.
2. Tap [✕] in the lower left corner.

PRO TIP: For advanced exposure settings, see [Exposure Value Compensation](#) (page 78).

ADVANCED CONTROLS

PROTUNE

Protune unlocks the camera's full potential, yielding stunning image quality and cinema-caliber video and photos optimized for professional productions. Protune gives content creators more flexibility and workflow efficiency than ever before.

Protune is compatible with professional color correction tools, the Quik desktop app, and other video and photo editing software.

Protune enables manual control of color, white balance, shutter speed, and more for advanced control and customization of your video footage and photos.

PT Protune

Protune is available as an advanced setting for all capture modes, except Looping and Time Lapse Video. To access this advanced setting, see [Navigating with the Touch Display](#) (page 18). The options for this setting are Off (default) and On. When Protune is on, [**PT**] appears on the camera screens.

Some Protune settings are not available when you use Exposure Control. Protune is available for all video resolutions.

Changes that you make to Protune settings in one capture mode apply only to that capture mode. For example, changing the White Balance for Night photos does not affect White Balance for Burst photos.

ADVANCED CONTROLS

Color

Color lets you adjust the color profile of your video or photos. When you change this setting, the touch display immediately shows you the effect on your image.

Color Setting	Resulting Color Profile
GoPro Color (default)	Provides GoPro color-corrected profile (same great color as when Protune is turned off).
Flat	Provides neutral color profile that can be color-corrected to better match footage captured with other equipment, offering more flexibility in post-production. Due to its long curve, Flat captures more details in shadows and highlights.

White Balance

White Balance lets you adjust the color temperature of video and photos to optimize for cool or warm lighting conditions. When you change this setting, the touch display immediately shows you the effect on your image.

Options for this setting are Auto (default), 2300K, 2800K, 3200K, 4000K, 4500K, 5500K, 6000K, 6500K, and Native. Lower values result in warmer tones.

You can also select Native to create a minimally color-corrected file from the image sensor that allows for more precise adjustments in post-production.

ADVANCED CONTROLS

ISO ↓ ISO Minimum

ISO ↑ ISO Maximum

ISO Minimum and ISO Maximum let you set a range for the camera's sensitivity to light and image noise. ISO settings create a balance between brightness and resulting image noise. Image noise refers to the degree of graininess in the image.

In low light, higher ISO values result in brighter images, but with greater image noise. Lower values result in darker images with lower image noise. When you change this setting, the touch display immediately shows you the effect on your image. The default for ISO Maximum is 1600 for video and 3200 for photos. The default for ISO Minimum is 100.

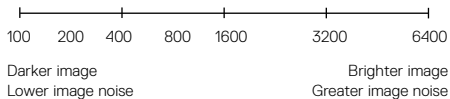

For the Video and Photo capture modes, ISO behavior depends on the Shutter setting (in Protune). The ISO Maximum that you select is used as the maximum ISO value. The ISO value that is applied might be lower, depending on the lighting conditions.

PRO TIP: To lock the ISO at a specific value, set ISO Minimum and ISO Maximum to the same values.

ADVANCED CONTROLS

 Shutter

The Shutter setting in Protune applies only to the Video and Photo capture modes. This setting determines the amount of time that the shutter is open. When you change this setting, the touch display immediately shows you the effect on your image. The default setting is Auto.

For Photo, the options for this setting are Auto, 1/125, 1/250, 1/500, 1/1000, and 1/2000 second.

For Video, the options for this setting depend on the FPS setting, as noted below.

Settings	Example 1: 1080p30	Example 2: 1080p60
Auto	Auto	Auto
1/FPS	1/30 sec	1/60 sec
1/(2xFPS)	1/60 sec	1/120 sec
1/(4xFPS)	1/120 sec	1/240 sec
1/(8xFPS)	1/480 sec	1/960 sec

PRO TIP: To reduce the amount of blur in your video and photos when using the Shutter setting, mount your camera on a tripod or other surface that is stable and cannot move.

ADVANCED CONTROLS



Exposure Value Compensation (EV Comp)

Exposure Value Compensation affects the brightness of your video or photo. Adjusting this setting can improve image quality when shooting in environments with contrasting lighting conditions.

Options for this setting range from -2.0 to +2.0. The default setting is 0.

When you change this setting, the touch display immediately shows you the effect on your image. Higher values result in brighter images.

For Video, this setting is available only if Shutter is set to Auto.

For information about adjusting exposure based on a certain area of your scene, see [Exposure Control](#) (page 71).

PRO TIP: Exposure Value Compensation adjusts brightness within the existing ISO setting. If brightness has already reached the ISO setting in a low-light environment, increasing the Exposure Value Compensation does not have any effect. To continue increasing the brightness, select a higher ISO value.



Sharpness

Sharpness controls the quality of details captured in your video footage or photos. Options for this setting are High (default), Medium, and Low.

When you change this setting, the touch display immediately shows you the effect on your image.

PRO TIP: If you plan to increase sharpness during editing, select Low for this setting.

ADVANCED CONTROLS



RAW Audio

This setting applies only to the Video capture mode and creates a separate .wav file for your video, in addition to the standard .mp4 audio track. You can select the level of processing to apply to the RAW audio track. This setting is useful if you want a separate .wav file to share or use in post-processing.

Option	Description
Off (default)	No separate .wav file is created.
Low	Applies minimal processing. Ideal if you apply audio processing in post-production.
Med	Applies processing based on the Manual Audio Control setting (wind and/or stereo). If Manual Audio Control is turned off, the camera automatically switches between wind filtering and stereo audio.
High	Applies full audio processing (automatic gain and AAC encoding).

PRO TIP: Audio files in .wav format are captured in the same location and with the same file name as .mp4 files. To access them, insert your microSD card into a card reader and locate the files with your computer's file explorer.

Reset

This option resets all Protune settings to their default values.

CONNECTING TO AN AUDIO ACCESSORY

An accessory microphone or other component can provide enhanced audio for your captured video.

1. Connect the audio accessory to your camera's USB-C port using GoPro's Pro 3.5mm Mic Adapter (sold separately).
2. From the camera's main screen, swipe down.
3. Tap Preferences > Audio Input.
4. Tap an option:

Option	Description
Standard Mic (default)	Supports non-powered mics
Standard Mic+	Supports non-powered mics and provides 20dB boost
Powered Mic	Supports self-powered mics
Powered Mic+	Supports self-powered mics and provides 20dB boost
Line In	Supports line-level output from other audio equipment (mixing board, guitar preamplifier, karaoke machine, etc.)

Note: If you are not sure which option to select, refer to the information from your microphone manufacturer.

CUSTOMIZING YOUR GOPRO

From changing the beep volume to turning off the status lights, you can set up your camera to work the way that you want.

CHANGING PREFERENCES

1. Swipe down, then tap Preferences.
2. Tap a setting, then tap a new option.
3. To exit, swipe down.

DATE AND TIME

The date and time are automatically updated when you connect your camera to the GoPro app or the Quik desktop app. However, you can manually change these settings, if needed.

Note: If the battery is removed from the camera for an extended period of time, you must reset the date and time (automatically or manually).

DATE FORMAT

The date format is automatically based on the camera language that you select. However, you can manually change this setting, if needed. The options are DD.MM.YY, MM.DD.YY, and YY.MM.DD.

BEEP VOLUME

Sets the volume of your GoPro's alerts. The options are High (default), Med, Low, and Off.

LED

Sets which status lights blink. The options are All On (default), All Off, and Front Off.

PRO TIP: Turn the front status light off if you are capturing in an area with windows or mirrors that might cause reflection in the shot.

CUSTOMIZING YOUR GOPRO

DEFAULT MODE

Sets the capture mode that your GoPro defaults to when powering up. The options are Video (default), Time Lapse Video, Looping, Photo, Night, Burst, Time Lapse Photo, and Night Lapse Photo.

Note: This setting does not affect QuikCapture.

AUTO OFF

Powers off your GoPro after a period of inactivity to save battery life. The options are 5 minutes, 15 minutes (default), 30 minutes, and Never.

Note: Voice Control is not available when the camera is off unless the Wake On Voice setting is turned on. When using Voice Control, consider selecting a higher time period (or Never) for Auto Off.

SCREENSAVER

Turns off the touch display after a period of inactivity to save battery life. The options are 1 minute (default), 2 minutes, 3 minutes, and Never. To turn on the touch display again, tap anywhere on the screen. When the touch display turns off, you can still use the camera buttons and Voice Control.

BRIGHTNESS

Adjusts the brightness level of the touch display. The options are 10% to 100% (default).

CUSTOMIZING YOUR GOPRO



AUTO-ROTATION

This setting determines the orientation of your video or photos to help you prevent upside down footage.

Setting	Description
Auto	(Auto Image Rotation) Camera automatically selects Up or Down, based on the orientation of the camera when recording begins. Ensures that your resulting image is always right-side up.
Up (default)	Camera is set to always capture in right-side up orientation.
Down	Camera is set to always capture in upside down orientation.

AUTO LOCK

Locks the touch display to prevent accidental input. This setting is off by default.

- To turn on Auto Lock, swipe down, then tap []. To temporarily unlock the screen, swipe down, then tap the touch display.
- To turn off Auto Lock, swipe down, then tap [].

CUSTOMIZING YOUR GOPRO

GPS

Captures the location where your video and photos were taken. To see this information, view the video or photos on a compatible desktop or mobile application. For details, visit gopro.com/help.

LANGUAGE

Sets the language that appears on the camera.

VIDEO FORMAT

Sets the regional frame rates that your camera uses for recording and playing back video on a TV/HDTV. Selecting the appropriate option for your region helps prevent flicker when capturing video indoors.

Setting	Description
NTSC	Select this option to play back your video on an NTSC TV (most televisions in North America)
PAL	Select this option to play back your video on a PAL TV (most televisions outside of North America)

IMPORTANT MESSAGES

TEMPERATURE ICON



The Temperature icon appears on the camera status screen when the camera becomes too hot and needs to cool down. Simply let it sit and cool before attempting to use it again. Your camera was designed to identify conditions of overheating and shuts down when needed.

FILE REPAIR ICON



If recording stopped abruptly and the video file was not properly saved, the file might become corrupted. If this happens, the camera displays the File Repair icon while it tries to repair the file. When this process is finished, you receive a message stating whether the repair was successful or failed. Press any button to continue using the camera.

MICROSD CARD MESSAGES

NO SD	No card present. The camera requires a microSD, microSDHC or microSDXC card (sold separately) to capture videos and photos.
FULL	The card is full. Delete some files or insert a different card.
SD ERR	The camera is unable to read the card formatting. Reformat the card in the camera.

RESETTING YOUR CAMERA

RESTARTING YOUR GOPRO

If your camera is not responding, press and hold the **Mode** button [] for 8 seconds to shut down the camera and then restart it. All settings are retained.

RESETTING ALL SETTINGS TO THE DEFAULTS

This option resets all of your camera settings to the defaults, except Date, Time, camera name and password, Language, and Video Format.

1. From the main screen, swipe down.
2. Tap Preferences > Camera Defaults, and then tap Reset.

RESETTING THE CONNECTIONS

This option clears your connections list and resets the camera's password. If you reset the connections, you must reconnect your devices to your GoPro.

1. From the main screen, swipe down.
2. Tap Connections > Reset Connections, and then tap Reset.

RESTORING FACTORY SETTINGS

Follow the steps below to reset all settings, clear your connections, and deregister the camera from your GoPro Plus account. This option is useful if you are reselling your camera and want to reset it to its original state.

Note: This option does not change your camera's software version.

1. From the main screen, swipe down.
2. Tap Preferences > Factory Reset, and then tap Reset.

Restoring factory settings does not erase all content from your microSD card. To clear your microSD card, see [Reformatting Your microSD Card](#) (page 9).

MOUNTING

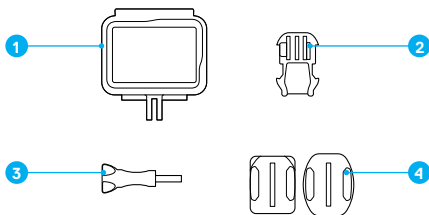

1. The Frame
2. Mounting Buckle
3. Thumb Screw
4. Curved + Flat Adhesive Mounts

THE FRAME

The Frame (for HERO6 Black/HERO5 Black) provides additional protection for your camera if you drop it, so you might want to keep it in The Frame during certain activities, even if the camera is not mounted.

HERO6 Black is waterproof to 33' (10m) with the doors closed—no additional housing is needed when using the camera in or around water.

NOTICE: The Frame does not provide additional waterproof protection.

PRO TIP: During water activities, use a camera tether for added security and use a Floaty to keep your camera afloat (both sold separately). For more information, visit gopro.com.

MOUNTING

ATTACHING YOUR CAMERA TO MOUNTS

To attach your camera to a mount, you need The Frame (for HERO6 Black/HERO5 Black) and a mounting buckle and/or thumb screw, depending on the mount you are using.

1. Secure the camera in The Frame:
 - a. Open the latch.
 - b. Slide the camera into the frame. The bottom front of The Frame has a raised edge. Be sure the front of the camera sits flush against it.
 - c. Close the door.
 - d. Lock the latch.

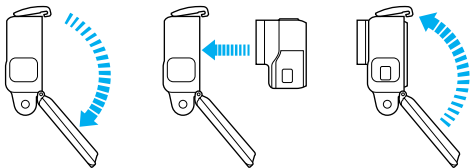

2. Attach The Frame to the mounting buckle.

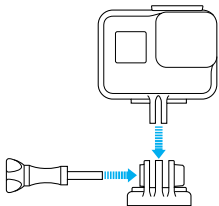

MOUNTING

3. Follow the [Mounting Guidelines](#) (page 89) to attach an adhesive mount to a surface.
4. Attach the mounting buckle to the mount:
 - a. Flip up the mounting buckle plug.
 - b. Slide the buckle into the mount until it clicks into place.
 - c. Press down on the plug so that it sits flush with the buckle.

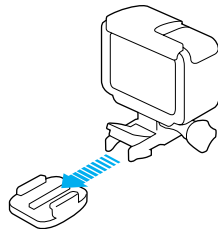

PRO TIP: If you mount your HERO6 Black upside down, the camera automatically changes the orientation of your image to be right-side up. For more information, see [Auto-Rotation](#) (page 83).

MOUNTING GUIDELINES

Follow these guidelines when attaching adhesive mounts to curved and flat surfaces of helmets, vehicles, and gear:

- Attach the adhesive mounts at least 24 hours before use.
- Adhesive mounts must be mounted only on smooth surfaces. Porous or textured surfaces do not enable a proper bond. When applying the mount, firmly press it into place and ensure full contact over the entire surface.

MOUNTING

- Apply adhesive mounts only to clean, dry surfaces. Wax, oil, dirt or other debris reduce adhesion, which can result in a weak bond and risk of losing the camera should the connection fail.
- Attach adhesive mounts in room temperature conditions. Adhesives do not bond properly if applied in cold or damp environments to cold or damp surfaces.
- Check state and local regulations and laws to ensure that attaching a camera to equipment (such as hunting equipment) is permitted. Always comply with regulations that restrict the use of consumer electronics or cameras.
- During water activities, use a camera tether and Floaty (both sold separately) for added security to keep your camera afloat.



WARNING: To avoid injury, do not use a tether when mounting the camera on a helmet. Do not mount the camera directly on skis or snowboards.

For more information about mounts, visit gopro.com.



WARNING: If using your camera with a GoPro mount or strap intended for use with a helmet, always select a helmet that meets the applicable safety standard.

Choose the right helmet for your particular sport or activity and make sure that it is the right fit and size for you. Inspect your helmet to ensure that it is in good condition, and follow the helmet manufacturer's instructions on safe helmet use.

Any helmet that has sustained a major impact should be replaced. No helmet can protect against injury in every accident.

REMOVING THE SIDE DOOR

In some situations, such as charging the camera within The Frame, connecting to audio or HDMI accessories, or connecting to a GoPro drone, you must remove the side door to access the ports.



WARNING: Remove the side door only when you are using the camera in a dry, dust-free environment. When the door is open or removed, the camera is not waterproof. Never operate the camera with the battery door open.

REMOVING THE SIDE DOOR

1. Hold down the Latch Release button and slide the door open.
2. Pull the door off of the camera.

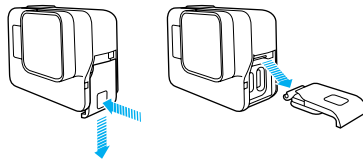

REMOVING THE SIDE DOOR

REATTACHING THE SIDE DOOR

1. Hold down the Latch Release button and extend the tab on the door.



2. Press the tab onto the small silver bar.

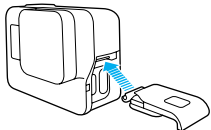

MAINTENANCE

Follow these guidelines to get the best performance from your camera:

- The camera is waterproof to 33' (10m)—no housing needed. Ensure that the doors are closed before using the camera in or around water, dirt, or sand.
- Before closing the doors, be sure the seals are free of debris. If needed, clean with a cloth.
- Before opening the doors, be sure the camera is free of water or debris. If needed, rinse the camera with fresh water and dry it with a cloth.
- If sand or debris hardens around the doors, soak the camera in warm tap water for 15 minutes and then rinse thoroughly to remove the debris before opening the doors.
- In wet environments, dry the touch display with a soft cloth so that it registers your touch.
- For best audio performance, shake the camera or blow on the mic to remove water and debris from the microphone holes. To prevent damage to the internal waterproof membranes, do not use compressed air to blow into the mic holes.
- After every use in salt water, rinse the camera with fresh water, and dry with a soft cloth.
- To clean the lens or the lens cover, wipe it with a soft, lint-free cloth. If debris becomes lodged between the lens and the trim ring, flush it out with water or air. Do not insert foreign objects around the lens.

BATTERY INFORMATION

MAXIMIZING BATTERY LIFE

A message appears on the touch display if the battery drops below 10%. If the battery reaches 0% while recording, the camera saves the file and powers off.

To maximize battery life, follow these guidelines when possible:

- Turn off Wireless Connections
- Turn off GPS
- Capture video at lower frame rates and resolutions
- Turn off Protune
- Use these settings:
 - [QuikCapture](#) (page 28)
 - [Screensaver](#) (page 82)
 - [Auto Off](#) (page 82)
 - [Brightness](#) (page 82)

RECORDING WHILE CHARGING

Using the USB-C cable that came with your camera, you can capture video and photos while the camera is plugged in to a USB charging adapter, the GoPro Supercharger, another GoPro charger, or the GoPro Portable Power Pack. Although the battery does not charge during recording, you can use one of the above methods to power the camera and obtain extended recording time. When you stop recording, charging resumes. (You cannot record while charging the camera through a computer.)

Note: Because the side door is open, the camera is not waterproof during charging.

BATTERY INFORMATION



WARNING: Using a wall charger other than a GoPro charging device can damage the GoPro camera battery and could result in fire or leakage. With the exception of the GoPro Supercharger (sold separately), only use chargers marked: Output 5V 1A. If you do not know the voltage and current of your charger, use the included USB cable to charge the camera from your computer.

BATTERY STORAGE AND HANDLING

The camera contains sensitive components, including the battery. Avoid exposing your camera to very cold or very hot temperatures. Low or high temperature conditions may temporarily shorten the battery life or cause the camera to temporarily stop working properly. Avoid dramatic changes in temperature or humidity when using the camera, as condensation may form on or within the camera.

Do not dry the camera or battery with an external heat source such as a microwave oven or hair dryer. Damage to the camera or battery caused by contact with liquid inside the camera is not covered under the warranty.

Do not store your battery with metal objects, such as coins, keys or necklaces. If the battery terminals come in contact with metal objects, this may cause a fire.

Do not make any unauthorized alterations to the camera. Doing so may compromise safety, regulatory compliance, performance, and may void the warranty.

BATTERY INFORMATION



WARNING: Do not drop, disassemble, open, crush, bend, deform, puncture, shred, microwave, incinerate or paint the camera or battery. Do not insert foreign objects into the battery opening on the camera. Do not use the camera or the battery if it has been damaged—for example, if cracked, punctured or harmed by water. Disassembling or puncturing the battery can cause an explosion or fire.

BATTERY DISPOSAL

Most rechargeable lithium-ion batteries are classified as non-hazardous waste and are safe for disposal in the normal municipal waste stream. Many localities have laws in place requiring battery recycling. Check your local laws to make sure that you can dispose of rechargeable batteries in your regular trash. To safely dispose of lithium-ion batteries, protect terminals from exposure to other metal with packing, masking or electrical tape so they do not cause a fire while being transported.

Lithium-ion batteries, however, do contain recyclable materials and are accepted for recycling by the Rechargeable Battery Recycling Corporation's (RBRC) Battery Recycling Program. We encourage you to visit Call2Recycle at call2recycle.org or call 1-800-BATTERY in North America to find a convenient recycling location.

Never dispose of a battery in a fire because it may explode.



WARNING: Only use manufacturer-recommended replacement batteries for your camera.

TROUBLESHOOTING

I'M NOT SURE WHICH SETTINGS TO USE
See [Settings for Your Activities](#) (page 26).

MY GOPRO WON'T POWER ON
Make sure your GoPro is charged. To charge your camera, use the included USB-C cable and a computer. You can also use GoPro's Supercharger or USB-compatible Wall Charger or Auto Charger (all sold separately) or any charging device marked with output 5V 1A. (Supercharger's output is 5V 2A.)

MY GOPRO WON'T RESPOND WHEN I PRESS A BUTTON
See [Restarting Your GoPro](#) (page 86).

PLAYBACK ON MY COMPUTER IS CHOPPY
Choppy playback is typically not a problem with the file. If your footage skips, one of these situations is likely the cause:

- Using an incompatible video player. Not all video players support the H.265/HEVC and H.264 codecs. For best results, download the latest version of the Quik desktop app for free at gopro.com/apps.
- The computer does not meet the minimum requirements for HD playback. The higher the resolution and frame rate of your video, the harder the computer has to work to play it back. Make sure that your computer meets the minimum requirements for the playback software. If your computer does not meet the minimum requirements, record at 1080p60 with Protune off, and make sure that all other programs on your computer are closed. If that resolution does not improve the playback, try 720p60.

TROUBLESHOOTING

I FORGOT MY CAMERA'S USERNAME OR PASSWORD

Swipe down, then tap Connections > Name & Password.

I DON'T KNOW WHAT SOFTWARE VERSION I HAVE

From the main screen, swipe down. Then tap Preferences > About This GoPro. The Version Number displays the software version that you are running.

I CAN'T FIND MY CAMERA'S SERIAL NUMBER

The camera's serial number is listed in several places:

- In Preferences > About This GoPro
- On the inside of the battery bay (remove the battery to see it)
- On your camera's microSD card (in the version.txt file in the MSC folder)

For more answers to commonly asked questions, see gopro.com/help.

CUSTOMER SUPPORT

GoPro is dedicated to providing the best possible service. To reach GoPro Customer Support, visit gopro.com/help.

TRADEMARKS

GoPro, HERO, Session, Karma and their respective logos are trademarks or registered trademarks of GoPro, Inc. in the United States and other countries. © 2017 GoPro, Inc. All rights reserved. Made in China. Hecho en China. For patent information, visit gopro.com/patents. GoPro, Inc., 3000 Clearview Way, San Mateo CA 94402 | GoPro GmbH, Floessergasse 2, 81369 Munich, Germany

THIS PRODUCT IS SOLD WITH A LIMITED LICENSE AND IS AUTHORIZED TO BE USED ONLY IN CONNECTION WITH HEVC CONTENT THAT MEETS EACH OF THE THREE FOLLOWING QUALIFICATIONS: (1) HEVC CONTENT ONLY FOR PERSONAL USE; (2) HEVC CONTENT THAT IS NOT OFFERED FOR SALE; AND (3) HEVC CONTENT THAT IS CREATED BY THE OWNER OF THE PRODUCT. THIS PRODUCT MAY NOT BE USED IN CONNECTION WITH HEVC ENCODED CONTENT CREATED BY A THIRD PARTY, WHICH THE USER HAS ORDERED OR PURCHASED FROM A THIRD PARTY, UNLESS THE USER IS SEPARATELY GRANTED RIGHTS TO USE THE PRODUCT WITH SUCH CONTENT BY A LICENSED SELLER OF THE CONTENT. YOUR USE OF THIS PRODUCT IN CONNECTION WITH HEVC ENCODED CONTENT IS DEEMED ACCEPTANCE OF THE LIMITED AUTHORITY TO USE AS NOTED ABOVE

REGULATORY INFORMATION

To see the complete list of country certifications, refer to the Important Product + Safety Instructions included with your camera or visit gopro.com/help.

