

# Grandstream Networks, Inc.

---

HT801/HT802

Analog Telephone Adaptors

## User Guide



## **COPYRIGHT**

©2019 Grandstream Networks, Inc. <http://www.grandstream.com>

All rights reserved. Information in this document is subject to change without notice. Reproduction or transmittal of the entire or any part, in any form or by any means, electronic or print, for any purpose without the express written permission of Grandstream Networks, Inc. is not permitted.

The latest electronic version of this user manual is available for download here:

<http://www.grandstream.com/support>

Grandstream is a registered trademark and Grandstream logo is trademark of Grandstream Networks, Inc. in the United States, Europe and other countries.

## **CAUTION**

Changes or modifications to this product not expressly approved by Grandstream, or operation of this product in any way other than as detailed by this User Manual, could void your manufacturer warranty.

## **WARNING**

Please do not use a different power adaptor with your devices as it may cause damage to the products and void the manufacturer warranty.



## GNU GPL INFORMATION

HT801/HT802 firmware contains third-party software licensed under the GNU General Public License (GPL). Grandstream uses software under the specific terms of the GPL. Please see the GNU General Public License (GPL) for the exact terms and conditions of the license.

Grandstream GNU GPL related source code can be downloaded from Grandstream web site from:

<http://www.grandstream.com/support/faq/gnu-general-public-license/gnu-gpl-information-download>



## Table of Content

<b>DOCUMENT PURPOSE .....</b>	<b>7</b>
<b>CHANGE LOG .....</b>	<b>8</b>
Firmware Version 1.0.19.11 .....	8
Firmware Version 1.0.17.5 .....	8
Firmware Version 1.0.15.4 .....	8
Firmware Version 1.0.13.7 .....	8
Firmware Version 1.0.11.6 .....	8
Firmware Version 1.0.10.6 .....	8
Firmware Version 1.0.9.3 .....	8
Firmware Version 1.0.8.7 .....	8
Firmware Version 1.0.5.11 .....	8
Firmware Version 1.0.3.7 .....	9
Firmware Version 1.0.2.7 .....	9
Firmware Version 1.0.2.3 .....	9
Firmware Version 1.0.1.9 .....	9
<b>GUI INTERFACE EXAMPLES .....</b>	<b>10</b>
<b>WELCOME .....</b>	<b>11</b>
<b>PRODUCT OVERVIEW .....</b>	<b>12</b>
Feature Highlights .....	12
HT801/HT802 Technical Specifications .....	13
<b>GETTING STARTED .....</b>	<b>15</b>
Equipment Packaging .....	15
HT801/HT802 Ports Description .....	16
Connecting HT801/HT802 .....	17
HT801/HT802 LEDs Pattern .....	17
<b>CONFIGURATION GUIDE .....</b>	<b>19</b>



Obtain HT801/HT802 IP Address via Connected Analogue Phone.....	19
Understanding HT801/HT802 Interactive Voice Prompt Response Menu .....	19
Configuration via Web Browser .....	21
<i>Accessing the Web UI</i> .....	21
<i>Web UI Access Level Management</i> .....	22
<i>Saving the Configuration Changes</i> .....	22
<i>Changing Admin Level Password</i> .....	23
<i>Changing User Level Password</i> .....	23
<i>Changing Viewer Password</i> .....	23
<i>Changing HTTP Web Port</i> .....	24
NAT Settings .....	24
DTMF Methods .....	25
Preferred Vocoder (Codec).....	25
Configuring the HT801/HT802 Through Voice Prompts .....	25
Register a SIP Account .....	26
Rebooting the HT801/HT802 from Remote .....	28
<b>CALL FEATURES.....</b>	<b>29</b>
<b>CALL OPERATIONS .....</b>	<b>31</b>
Placing a phone call.....	31
Direct IP calls .....	31
Call Hold .....	32
Call Waiting .....	32
Call Transfer.....	32
<i>Blind Transfer</i> .....	32
<i>Attended Transfer</i> .....	32
3-Way Conferencing .....	33
Call Return .....	33
Inter-Port Calling.....	33
Flash Digit Control.....	34



<b>RESTORE FACTORY DEFAULT SETTINGS .....</b>	<b>35</b>
Using the Reset Button .....	35
Using the IVR Command .....	35
<b>EXPERIENCING HT801/HT802 .....</b>	<b>37</b>



## Table of Tables

Table 1: HT801/HT802 Features at a Glance .....	12
Table 2: HT801/HT802 FXS Analog Telephone Adapter Technical Specifications .....	13
Table 3: Definition of the HT801/HT802 Connectors .....	16
Table 4: HT801/HT802 LEDs Pattern Description .....	18
Table 5: Voice Prompt Menu .....	19
Table 6: HT801/HT802 Call Features .....	29
Table 7: MAC Address Key Mapping .....	35

## Table of Figures

Figure 1: HT801 Package Contents .....	15
Figure 2: HT802 Package Contents .....	15
Figure 3: HT801 Back Panel .....	16
Figure 4: HT802 Back Panel .....	16
Figure 5: Connecting the HT801/HT802 .....	17
Figure 6: HT801/HT802 LEDs Pattern .....	17
Figure 7: Admin Level Password .....	23
Figure 8: User Level Password .....	23
Figure 9: Viewer Level Password .....	24
Figure 10: Web HTTP Port .....	24
Figure 11: SIP Accounts Settings .....	27
Figure 12: Account Status .....	28



## DOCUMENT PURPOSE

This document describes the basic concept and tasks necessary to use and configure your HT801/HT802. And it covers the topic of connecting and configuring the HT801/HT802, making basic operations and the call features. Please visit <http://www.grandstream.com/support> to download the latest “HT801/HT802 User Guide”.

This guide covers following topics:

- [Product overview.](#)
- [Getting started.](#)
- [Configuration guide.](#)
- [Call features.](#)
- [Call operations.](#)
- [Upgrading and provisioning.](#)
- [Restore factory default settings.](#)





## CHANGE LOG

This section documents significant changes from previous versions of user guide for HT801/HT802. Only major new features or major document updates are listed here. Minor updates for corrections or editing are not documented here.

### **Firmware Version 1.0.19.11**

- No major changes.

### **Firmware Version 1.0.17.5**

- No major changes.

### **Firmware Version 1.0.15.4**

- No major changes.

### **Firmware Version 1.0.13.7**

- Added the support to verify if configured Gateway is on the same subnet as the configured IP address.

### **Firmware Version 1.0.11.6**

- No major changes.

### **Firmware Version 1.0.10.6**

- Add support for codec G722. [HT801/HT802 Technical Specifications]

### **Firmware Version 1.0.9.3**

- No major changes.

### **Firmware Version 1.0.8.7**

- Added support for upgrade device via [FTP/FTPS] server. [Upgrade Protocol] [UPGRADE PROTOCOL]

### **Firmware Version 1.0.5.11**

- Changed default "Upgrade Via" from HTTP to HTTPS. [Upgrade Protocol] [UPGRADE PROTOCOL]
- Added support for 3 level access through RADIUS authorization (Admin, User and viewer).



### **Firmware Version 1.0.3.7**

- No major changes.

### **Firmware Version 1.0.2.7**

- No major changes.

### **Firmware Version 1.0.2.3**

- No major changes.

### **Firmware Version 1.0.1.9**

- This is the initial version.



## GUI INTERFACE EXAMPLES

[http://www.grandstream.com/sites/default/files/Resources/ht80X\\_web\\_gui.zip](http://www.grandstream.com/sites/default/files/Resources/ht80X_web_gui.zip)

1. Screenshot of Login Page
2. Screenshots of Status Page
3. Screenshots of Basic Settings Page
4. Screenshots of Advanced Settings Page
5. Screenshots of FXS Port 1 Page
6. Screenshots of FXS Port 2 Page



## WELCOME

The HT801/HT802 analog telephone adaptors provide transparent connectivity for analog phones and faxes to the world of internet voice. Connecting to any analog phone, fax or PBX, the HT801/HT802 are an effective and flexible solution for accessing internet-based telephone services and corporate intranet systems across established LAN and internet connections. The Grandstream handy tones HT801/HT802 are new additions to the popular handy tone ATA product family. This manual will help you learn how to operate and manage your HT801/HT802 analog telephone adaptor and make the best use of its many upgraded features including simple and quick installation, 3-way conferencing, direct IP-IP Calling, and new provisioning support among other features. The HT801/HT802 are very easy to manage and configure and are specifically designed to be an easy to use and affordable VoIP solution for both the residential user and the teleworker.





## PRODUCT OVERVIEW

The HT801 is a one-port analog telephone adapter (ATA) while the HT802 is a 2-port analog telephone adapter (ATA) that allows users to create a high-quality and manageable IP telephony solution for residential and office environments. Its ultra-compact size, voice quality, advanced VoIP functionality, security protection and auto provisioning options enable users to take advantage of VoIP on analog phones and enables service providers to offer high quality IP service. The HT801/HT802 are an ideal ATA for individual use and for large scale commercial IP voice deployments.

### Feature Highlights

The following table contains major features of HT801 and HT802:

**Table 1: HT801/HT802 Features at a Glance**

<p><b>HT801</b></p> 	<ul style="list-style-type: none"> <li>• 1 SIP profile through 1 FXS port on HT801, 2 SIP profiles through 2 FXS ports on HT802 and single 10/100Mbps port on both models.</li> <li>• 3-way voice conferencing.</li> <li>• Wide range of caller ID formats.</li> <li>• Advanced telephony features, including call transfer, call forward, call-waiting, do not disturb, message waiting indication, multi-language prompts, flexible dial plan and more.</li> <li>• T.38 Fax for creating Fax-over-IP and GR-909 Line Testing Functionalities.</li> <li>• TLS and SRTP security encryption technology to protect calls and accounts.</li> <li>• Automated provisioning options include TR-069 and XML config files.</li> <li>• Failover SIP server automatically switches to secondary server if main server loses connection.</li> <li>• Use with Grandstream's UCM series of IP PBXs for Zero Configuration provisioning.</li> </ul>
<p><b>HT802</b></p> 	

## HT801/HT802 Technical Specifications

The following table resume all the technical specifications including the protocols / standards supported, voice codecs, telephony features, languages and Upgrade/ Provisioning settings for the HT801/HT802.

**Table 2: HT801/HT802 FXS Analog Telephone Adapter Technical Specifications**

<b>Interfaces</b>		
	<b>HT801</b>	<b>HT802</b>
<b>Telephone Interfaces</b>	One (1) RJ11 FXS port	Two (2) RJ11 FXS ports.
<b>Network Interface</b>	One (1) 10/100Mbps auto-sensing Ethernet port (RJ45).	
<b>LED Indicators</b>	POWER, INTERNET, PHONE	POWER, INTERNET, PHONE1, PHONE2.
<b>Factory Reset Button</b>	Yes.	
<b>Voice, Fax, Modem</b>		
	<b>HT801</b>	<b>HT802</b>
<b>Telephony Features</b>	Caller ID display or block, call waiting, flash, blind or attended transfer, forward, hold, do not disturb, 3-way conference.	
<b>Voice Codecs</b>	G.711 with Annex I (PLC) and Annex II (VAD/CNG), G.723.1, G.729A/B, G.726, G722, iLBC, OPUS, dynamic jitter buffer, advanced line echo cancellation.	
<b>Fax over IP</b>	T.38 compliant Group 3 Fax Relay up to 14.4kpbs and auto-switch to G.711 for Fax Pass-through.	
<b>Short/Long Haul Ring Load</b>	5 REN: Up to 1km on 24 AWG.	2 REN: Up to 1km on 24 AWG.
<b>Caller ID</b>	Bellcore Type 1 & 2, ETSI, BT, NTT, and DTMF-based CID.	
<b>Disconnect Methods</b>	Busy Tone, Polarity Reversal/Wink, Loop Current.	
<b>Signaling</b>		
	<b>HT801</b>	<b>HT802</b>
<b>Network Protocols</b>	TCP/IP/UDP, RTP/RTCP, FTP/FTPS, HTTP/HTTPS, ARP/RARP, ICMP, DNS, DHCP, NTP, TFTP, SSH, Telnet, STUN, SIP (RFC3261), SIP over TCP/TLS, SRTP, TR-069, DDNS.	
<b>QoS</b>	Layer 3 (ToS, DiffServ, MPLS).	
<b>DTMF Methods</b>	In-audio, RFC2833 and/or SIP INFO.	
<b>Provisioning and Control</b>	HTTP, HTTPS, FTP, FTPS, SSH, Telnet, TFTP, TR-069, secure and automated provisioning using AES encryption, syslog.	



Security		
	HT801	HT802
<b>Media</b>	SRTP.	
<b>Control</b>	TLS/SIPS/HTTPS/SSH/Telnet.	
<b>Management</b>	Syslog support, SSH, Telnet remote management using web browser.	
Physical		
	HT801	HT802
<b>Universal Power Supply</b>	Input: 100-240VAC, 50-60Hz. Output: 5.0VDC/1.0A.	
<b>Environmental</b>	Operational: 32° – 104°F or 0° – 40°C. Storage: 14° – 140°F or -10° – 60°C. Humidity: 10 – 90% Non-condensing.	
<b>Dimensions and Weight</b>	<ul style="list-style-type: none"> <li>• 100mm x 100mm x 29.5mm</li> <li>• 102g</li> </ul>	<ul style="list-style-type: none"> <li>• 100mm x 100mm x 29.5mm</li> <li>• 114g (without package).</li> </ul>
Compliance		
	HT801	HT802
<b>Compliance</b>	FCC Part15B EN55032, EN55024, EN61000-3-2, EN61000-3-3, EN60950-1, AS/NZS CISPR22, AS/NZS60950.1, S003	FCC 15B, AS/NZS CISPR22, AS/NZS60950, EN55022, EN55024, EN60950, EN61000-3-2, EN61000-3-3, UL (Power supply).

## GETTING STARTED

This chapter provides basic installation instructions including the list of the packaging contents and information for obtaining the best performance with the HT801/HT802.

### Equipment Packaging

The HT801 ATA package contains:

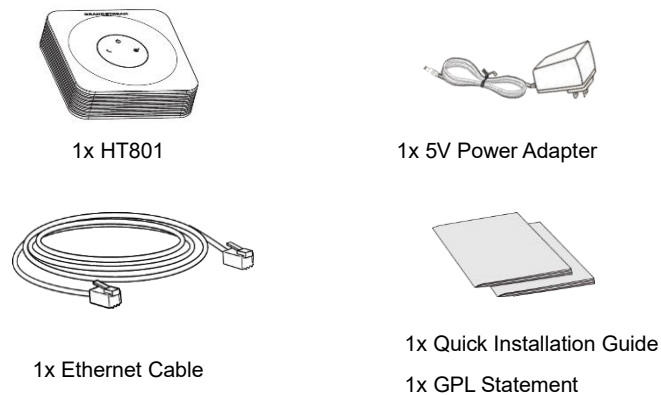

**Figure 1: HT801 Package Contents**

The HT802 ATA package contains:

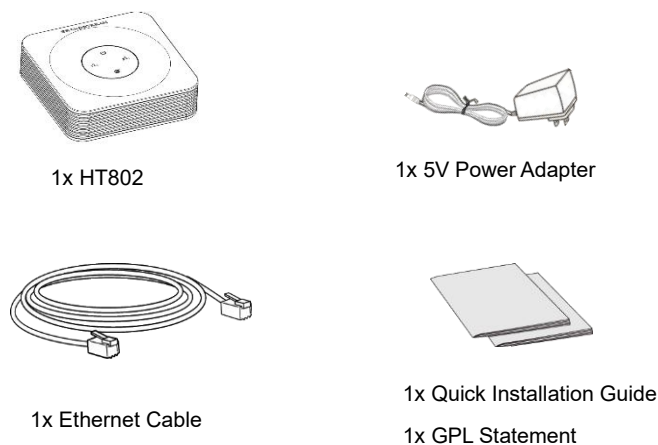

**Figure 2: HT802 Package Contents**

**Note:** Check the package before installation. If you find anything missing, contact your system administrator.



## HT801/HT802 Ports Description

The following figure describes the different ports on the back panel of the HT801.

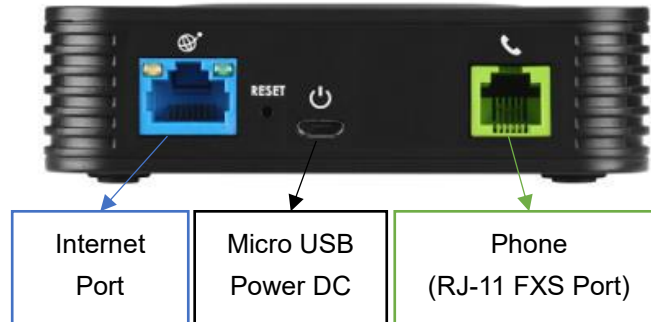

Figure 3: HT801 Back Panel

The following figure describes the different ports on the back panel of the HT802.

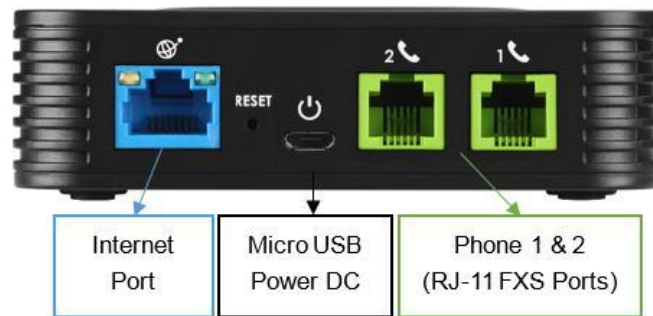

Figure 4: HT802 Back Panel

Table 3: Definition of the HT801/HT802 Connectors

<b>Phone for HT801 Phone 1 &amp; 2 for HT802</b>	Used to connect the analog phones / fax machines to the phone adapter using an RJ-11 telephone cable.
<b>Internet port</b>	Used to connect the phone adapter to your router or gateway using an Ethernet RJ45 network cable.
<b>Micro USB Power</b>	Connects the phone adapter to PSU (5V – 1A).
<b>Reset</b>	Factory reset button, press for 7 seconds to reset factory default settings.

## Connecting HT801/HT802

The HT801 and HT802 are designed for easy configuration and easy installation, to connect your HT801 or HT802, please follow the steps above:

1. Insert a standard RJ11 telephone cable into the phone port and connect the other end of the telephone cable to a standard touch-tone analog telephone.
2. Insert the Ethernet cable into the internet or LAN port of the HT801/ht802 and connect the other end of the Ethernet cable to an uplink port (a router or a modem, etc.)
3. Insert the power adapter into the HT801/HT802 and connect it to a wall outlet.

Power, Ethernet and Phone LEDs will be solidly lit when the HT801/HT802 is ready for use.



Figure 5: Connecting the HT801/HT802





## HT801/HT802 LEDs Pattern

There are 3 LED buttons on HT801 and 4 LED buttons on HT802 that help you manage the status of your Handy Tone.



Figure 6: HT801/HT802 LEDs Pattern

**Table 4: HT801/HT802 LEDs Pattern Description**

LED Lights	Status
<b>Power LED</b> 	The Power LED lights up when the HT801/HT802 is powered on and it flashes when the HT801/HT802 is booting up.
<b>Internet LED</b> 	The Ethernet LED lights up when the HT801/HT802 is connected to your network through the Ethernet port and it flashes when there is data being sent or received.
<b>Phone LED for HT801</b>  <b>Phone LED 1&amp;2 for HT802</b>  	The phone LED 1 & 2 indicates status of the respective FXS Ports-phone on the back panel <ul style="list-style-type: none"> <li>• OFF - Unregistered</li> <li>• ON (Solid Blue) - Registered and Available</li> <li>• Blinking every second - Off-Hook / Busy</li> <li>• Slow blinking - FXS LEDs indicates voicemail</li> </ul>

## CONFIGURATION GUIDE

The HT801/HT802 can be configured via one of two ways:

- The IVR voice prompt menu.
- The Web GUI embedded on the HT801/HT802 using PC's web browser.

### Obtain HT801/HT802 IP Address via Connected Analogue Phone

HT801/HT802 is by default configured to obtain the IP address from DHCP server where the unit is located.

To know which IP address is assigned to your HT801/HT802, you should access to the "[Interactive Voice Response Menu](#)" of your adapter via the connected phone and check its IP address mode.

Please refer to the steps below to access the interactive voice response menu:

1. Use a telephone connected to phone for the HT801 or phone 1 or phone 2 ports of your HT802.
2. Press \*\*\* (press the star key three times) to access the IVR menu and wait until you hear "Enter the menu option".
3. Press 02 and the current IP address will be announced.

### Understanding HT801/HT802 Interactive Voice Prompt Response Menu

The HT801/HT802 has a built-in voice prompt menu for simple device configuration which lists actions, commands, menu choices, and descriptions. The IVR menu work with any phone connected to the HT801/HT802. Pick up the handset and dial "\*\*\*\*" to use the IVR menu.

Table 5: Voice Prompt Menu

Menu	Voice Prompt	Options
<b>Main Menu</b>	"Enter a Menu Option"	Press "*" for the next menu option Press "#" to return to the main menu Enter 01-05, 07,10, 13-17,47 or 99 menu options
<b>01</b>	"DHCP Mode", "Static IP Mode"	Press "9" to toggle the selection If using "Static IP Mode", configure the IP address information using menus 02 to 05.



		If using “Dynamic IP Mode”, all IP address information comes from the DHCP server automatically after reboot.
<b>02</b>	“IP Address “ + IP address	The current WAN IP address is announced If using “Static IP Mode”, enter 12-digit new IP address. <b>You need to reboot the HT801/HT802 for the new IP address to take Effect.</b>
<b>03</b>	“Subnet “ + IP address	Same as menu 02
<b>04</b>	“Gateway “ + IP address	Same as menu 02
<b>05</b>	“DNS Server “ + IP address	Same as menu 02
<b>07</b>	Preferred Vocoder	Press “ <b>9</b> ” to move to the next selection in the list: <ul style="list-style-type: none"> <li>• PCM U / PCM A</li> <li>• iLBC</li> <li>• G-726</li> <li>• G-723</li> <li>• G-729</li> <li>• OPUS</li> <li>• G722</li> </ul>
<b>10</b>	“MAC Address”	Announces the Mac address of the unit.
<b>13</b>	Firmware Server IP Address	Announces current Firmware Server IP address. Enter 12-digit new IP address.
<b>14</b>	Configuration Server IP Address	Announces current Config Server Path IP address. Enter 12-digit new IP address.
<b>15</b>	Upgrade Protocol	Upgrade protocol for firmware and configuration update. Press “ <b>9</b> ” to toggle between <b>TFTP / HTTP / HTTPS / FTP / FTPS</b> . Default is HTTPS.
<b>16</b>	Firmware Version	Firmware version information.
<b>17</b>	Firmware Upgrade	Firmware upgrade mode. Press “ <b>9</b> ” to toggle among the following three options: <ul style="list-style-type: none"> <li>• always check</li> <li>• check when pre/suffix changes</li> <li>• never upgrade</li> </ul>



47	“Direct IP Calling”	Enter the target IP address to make a direct IP call, after dial tone. (See “ <i>Make a Direct IP Call</i> ”.)
86	Voice Mail	Access to your voice mails messages.
99	“RESET”	Press “9” to reboot the device Enter MAC address to restore factory default setting (See <b>Restore Factory Default Setting</b> section)
701-702	Phone calls between different ports of the same HT802	HT802 supports inter-port calling from voice menu. 70X (X is the port number)
	“Invalid Entry”	Automatically returns to main menu
	“Device not registered”	This prompt will be played immediately after off hook If the device is not register and the option “Outgoing Call without Registration” is in NO

### Five success tips when using the voice prompt

- “\*” shifts down to the next menu option and “#” returns to the main menu.
- “9” functions as the ENTER key in many cases to confirm or toggle an option.
- All entered digit sequences have known lengths - 2 digits for menu option and 12 digits for IP address. For IP address, add 0 before the digits if the digits are less than 3 (i.e. - 192.168.0.26 should be key in like 192168000026. No decimal is needed).
- Key entry cannot be deleted but the phone may prompt error once it is detected.

### Configuration via Web Browser

The HT801/HT802 embedded Web server responds to HTTP GET/POST requests. Embedded HTML pages allow a user to configure the HT801/HT802 through a web browser such as Google Chrome, Mozilla Firefox and Microsoft’s IE.

### Accessing the Web UI

1. Connect the computer to the same network as your HT801/HT802.
2. Make sure the HT801/HT802 is booted up.
3. You may check your HT801/HT802 IP address using the IVR on the connected phone. Please see [Obtain HT802 IP Address Via Connected Analogue Phone.](#)
4. Open Web browser on your computer.



5. Enter the HT801/HT802's IP address in the address bar of the browser.
6. Enter the administrator's password to access the Web Configuration Menu.

**Notes:**

- The computer must be connected to the same sub-network as the HT801/HT802. This can be easily done by connecting the computer to the same hub or switch as the HT801/HT802.
- Recommended Web browsers:
  - **Microsoft Internet Explorer:** version 10 or higher.
  - **Google Chrome:** version 58.0.3 or higher.
  - **Mozilla Firefox:** version 53.0.2 or higher.
  - **Safari:** version 5.1.4 or higher.
  - **Opera:** version 44.0.2 or higher.

### Web UI Access Level Management

There are two default passwords for the login page:

User Level	Password	Web Pages Allowed
End User Level	123	Only Status and Basic Settings
Administrator Level	admin	All pages
Viewer Level	viewer	Only checking, Not allowed to modify content.

The password is case sensitive with maximum length of 25 characters.

When changing any settings, always submit them by pressing the **Update** or **Apply** button on the bottom of the page. After submitting the changes in all the Web GUI pages, reboot HT801/HT802 to have the changes take effect if necessary; most of the options under the **Advanced Settings** and **FXS Port (x)** pages require reboot.

### Saving the Configuration Changes

After users makes changes to the configuration, pressing the **Update** button will save but not apply the changes until the **Apply** button is clicked. Users can instead directly press the **Apply** button. We recommend rebooting or powering cycle the phone after applying all the changes.



## Changing Admin Level Password

1. Access your HT801/HT802 web UI by entering its IP address in your favorite browser (screenshots below are from HT802 but the same applies to HT801).
2. Enter your admin password (default: admin).
3. Press **Login** to access your settings and navigate to **Advanced Settings > Admin Password**.
4. Enter the new admin password.
5. Confirm the new admin password.
6. Press **Apply** at the bottom of the page to save your new settings.

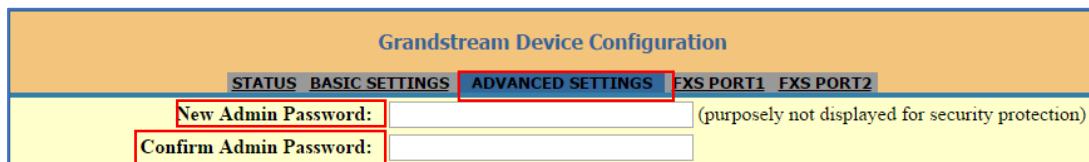

The screenshot shows the 'Grandstream Device Configuration' interface. At the top, there are navigation tabs: STATUS, BASIC SETTINGS, **ADVANCED SETTINGS**, FXS PORT1, and FXS PORT2. Below the tabs, there are two input fields: 'New Admin Password:' and 'Confirm Admin Password:'. The 'New Admin Password' field has a note '(purposely not displayed for security protection)' to its right. The 'Confirm Admin Password' field is empty.

Figure 7: Admin Level Password

## Changing User Level Password

1. Access your HT801/HT802 web UI by entering its IP address in your favorite browser.
2. Enter your admin password (default: admin).
3. Press **Login** to access your settings and navigate to **Basic Settings > End User Password**.
4. Enter the new user password.
5. Confirm the new end-user password.
6. Press **Apply** at the bottom of the page to save your new settings.

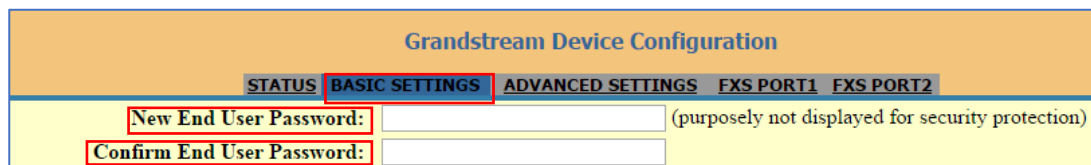

The screenshot shows the 'Grandstream Device Configuration' interface. At the top, there are navigation tabs: STATUS, **BASIC SETTINGS**, ADVANCED SETTINGS, FXS PORT1, and FXS PORT2. Below the tabs, there are two input fields: 'New End User Password:' and 'Confirm End User Password:'. The 'New End User Password' field has a note '(purposely not displayed for security protection)' to its right. The 'Confirm End User Password' field is empty.

Figure 8: User Level Password

## Changing Viewer Password

1. Access your HT801/HT802 web UI by entering its IP address in your favorite browser.
2. Enter your admin password (default: admin).
3. Press **Login** to access your settings.
4. Go to **Basic Settings → New Viewer Password** and enter the new viewer password.
5. Confirm the new viewer password.
6. Press **Apply** at the bottom of the page to save your new settings.



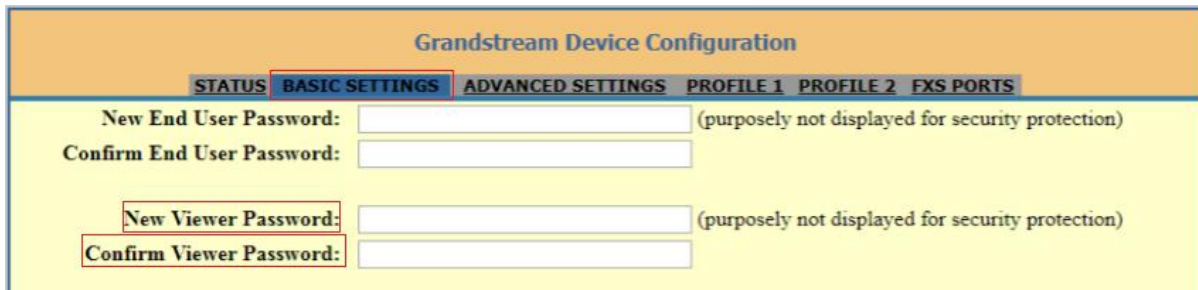

**Grandstream Device Configuration**

STATUS
**BASIC SETTINGS**
ADVANCED SETTINGS
PROFILE 1
PROFILE 2
FXS PORTS

New End User Password:  (purposely not displayed for security protection)

Confirm End User Password:

New Viewer Password:  (purposely not displayed for security protection)

Confirm Viewer Password:

Figure 9: Viewer Level Password

## Changing HTTP Web Port

1. Access your HT801/HT802 web UI by entering its IP address in your favorite browser.
2. Enter your admin password (default: admin).
3. Press **Login** to access your settings and navigate to **Basic Settings > Web Port**.
4. Change the current port to your desired/new HTTP port. Ports accepted are in range [1-65535].
5. Press **Apply** at the bottom of the page to save your new settings.

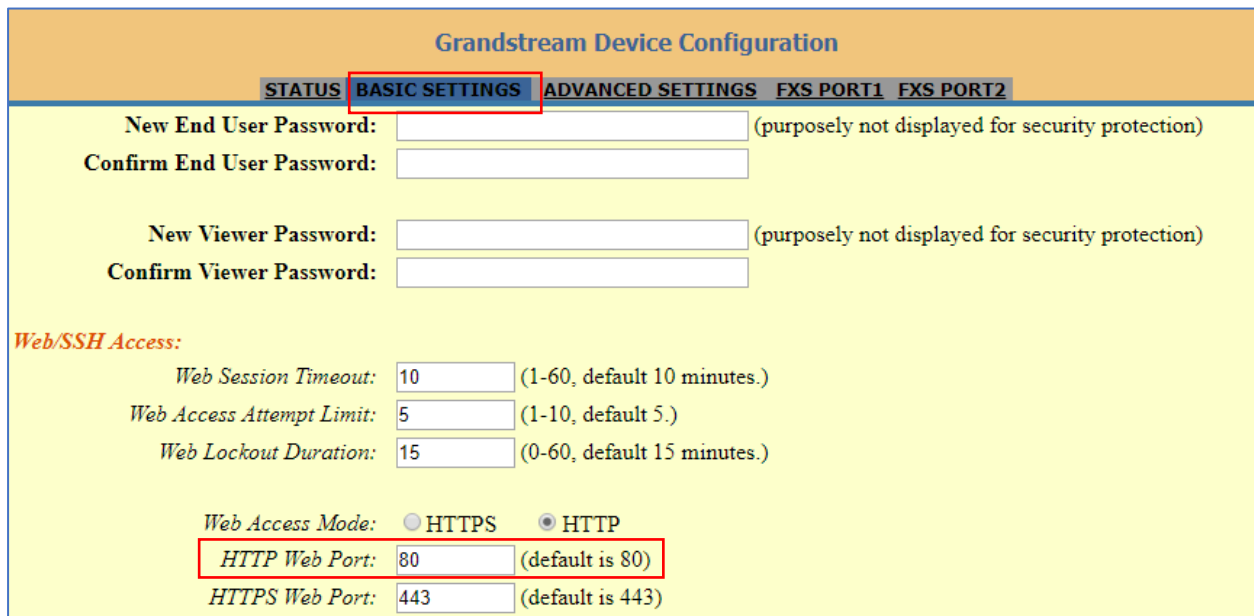

**Grandstream Device Configuration**

STATUS
**BASIC SETTINGS**
ADVANCED SETTINGS
FXS PORT1
FXS PORT2

New End User Password:  (purposely not displayed for security protection)

Confirm End User Password:

New Viewer Password:  (purposely not displayed for security protection)

Confirm Viewer Password:

**Web/SSH Access:**

Web Session Timeout:  (1-60, default 10 minutes.)

Web Access Attempt Limit:  (1-10, default 5.)

Web Lockout Duration:  (0-60, default 15 minutes.)

Web Access Mode:  HTTPS  HTTP

HTTP Web Port:  (default is 80)

HTTPS Web Port:  (default is 443)

Figure 10: Web HTTP Port

## NAT Settings

If you plan to keep the Handy Tone within a private network behind a firewall, we recommend using STUN Server. The following three settings are useful in the STUN Server scenario:

1. STUN Server (under advanced settings webpage) Enter a STUN server IP (or FQDN) that you may have or look up a free public STUN Server on the internet and enter it on this field. If using Public IP, keep this field blank.



2. Use Random SIP/RTP Ports (under advanced settings webpage) This setting depends on your network settings. Generally, if you have multiple IP devices under the same network, it should be set to Yes. If using a public IP address, set this parameter to No.
3. NAT traversal (under the FXS web page) Set this to Yes when gateway is behind firewall on a private network.

## DTMF Methods

The HT801/HT802 support the following DTMF mode:

- DTMF in-audio
- DTMF via RTP (RFC2833)
- DTMF via SIP INFO

Set priority of DTMF methods according to your preference. This setting should be based on your server DTMF setting.

## Preferred Vocoder (Codec)

The HT801/HT802 supports following voice codecs. On FXS ports pages, choose the order of your favorite codecs:

- PCMU/A (or G711 $\mu$ /a)
- G729 A/B
- G723.1
- G726
- iLBC
- OPUS
- G722

## Configuring the HT801/HT802 Through Voice Prompts

As mentioned previously, The HT801/HT802 has a built-in voice prompt menu for simple device configuration. Please refer to "[Understanding HT801/HT802 Interactive Voice Prompt Response Menu](#)" for more information about IVR and how to access its menu.

- **DHCP MODE**

Select voice menu option 01 to allow the HT801/HT802 to use DHCP.

- **STATIC IP MODE**

Select voice menu option 01 to allow the HT801/HT802 to enable the STATIC IP mode, then use option 02, 03, 04, 05 to set up IP address, Subnet Mask, Gateway and DNS server respectively.



- **FIRMWARE SERVER IP ADDRESS**

Select voice menu option 13 to configure the IP address of the firmware server.

- **CONFIGURATION SERVER IP ADDRESS**

Select voice menu option 14 to configure the IP address of the configuration server.

- **UPGRADE PROTOCOL**

Select the menu option 15 to choose firmware and configuration upgrade protocol between TFTP, HTTP and HTTPS, FTP and FTPS. Default is HTTPS.

- **FIRMWARE UPGRADE MODE**

Select voice menu option 17 to choose firmware upgrade mode among the following three options:

“Always check, check when pre/suffix changes, and never upgrade”.

## Register a SIP Account

The HT801 supports 1 FXS port which can be configured with 1 SIP account, while HT802 supports 2 FXS ports which can be configured with 2 SIP accounts. Please refer to the following steps to register your accounts via web user interface.

1. Access your HT801/HT802 web UI by entering its IP address in your favorite browser.
2. Enter your admin password (default: admin) and press **Login** to access your settings.
3. Go to **FXS Port (1 or 2)** pages.
4. In **FXS Port** tab, set the following:
  - a. **Account Active** to **Yes**.
  - b. **Primary SIP Server** field with your SIP server IP address or FQDN.
  - c. **Failover SIP Server** with your Failover SIP Server IP address or FQDN. Leave empty if not available.
  - d. **Prefer Primary SIP Server** to **No** or **Yes** depending on your configuration. Set to **No** if no Failover SIP Server is defined. If “**Yes**”, account will register to Primary SIP Server when failover registration expires.
  - e. **Outbound Proxy**: Set your Outbound Proxy IP Address or FQDN. Leave empty if not available.
    - f. **SIP User ID**: User account information, provided by VoIP service provider (ITSP). Usually in the form of digit like phone number or a phone number.
    - g. **Authenticate ID**: SIP service subscriber’s Authenticate ID used for authentication. Can be identical to or different from SIP User ID.



- h. **Authenticate Password:** SIP service subscriber's account password to register to SIP server of ITSP. For security reasons, the password will field will be shown as empty.
  - i. **Name:** Any name to identify this specific user.
5. Press **Apply** at the bottom of the page to save your configuration.

**Grandstream Device Configuration**

STATUS
BASIC SETTINGS
ADVANCED SETTINGS
FXS PORT1
FXS PORT2

**Account Active:**  No  Yes

**Primary SIP Server:**  (e.g., sip.mycompany.com, or IP address)

**Failover SIP Server:**  (Optional, used when primary server no response)

**Prefer Primary SIP Server:**  No  Yes (yes - will register to Primary Server if Failover registration expires)

**Outbound Proxy:**  (e.g., proxy.myprovider.com, or IP address, if any)

**Backup Outbound Proxy:**  (e.g., proxy.myprovider.com, or IP address, if any)

**Prefer Primary Outbound Proxy:**  No  Yes (yes - will reregister via Primary Outbound Proxy if registration expires)

**Allow DHCP Option 120( override SIP server ):**  No  Yes

**SIP Transport:**  UDP  TCP  TLS (default is UDP)

**SIP URI Scheme When Using TLS:**  sip  sips

**Use Actual Ephemeral Port in Contact with TCP/TLS:**  No  Yes

**NAT Traversal:**  No  Keep-Alive  STUN  UPnP

**SIP User ID:**  (the user part of an SIP address)

**Authenticate ID:**  (can be identical to or different from SIP User ID)

**Authenticate Password:**  (purposely not displayed for security protection)

**Name:**  (optional, e.g., John Doe)

**Figure 11: SIP Accounts Settings**

After applying your configuration, your account will register to your SIP Server, you can verify if it has been correctly registered with your SIP server from your HT801/HT802 web interface under **Status > Port Status > Registration** (If it displays **Registered**, it means that your account is fully registered, otherwise it will display **Not Registered** so in this case you must double check the settings or contact your provider).

**Grandstream Device Configuration**

STATUS
BASIC SETTINGS
ADVANCED SETTINGS
FXS PORT1
FXS PORT2

**MAC Address:** 00:0B:82:83:62:0A  
**IPv4 Address:** 192.168.6.160  
**IPv6 Address:**  
**Product Model:** HT802  
**Hardware Version:** V1.5A Part Number -- 9610003715A  
**Software Version:** Program -- 1.0.5.11 Bootloader -- 1.0.5.3 Core -- 1.0.5.3 Base -- 1.0.5.11  
 CPE -- 1.0.1.67  
**Software Status:** Running Mem: 18472  
**System Up Time:** 08:29:09 up 27 min  
**PPPoE Link Up:** Disabled  
**NAT:** Unknown NAT

**Port Status:**

Port	Hook	User ID	Registration
FXS 1	On Hook	001	Registered
FXS 2	On Hook		Not Registered

**Port Options:**

Port	DND	Forward	Busy Forward	Delayed Forward
FXS 1	No			
FXS 2	No			

**Figure 12: Account Status**

**Note:** When all the FXS ports are registered (for HT802), the simultaneous ring will have one second delay between each ring on each phone.

### Rebooting the HT801/HT802 from Remote

Press the “Reboot” button at the bottom of the configuration menu to reboot the ATA remotely. The web browser will then display a message window to confirm that reboot is underway. Wait 30 seconds to log in again.

## CALL FEATURES

The HT801/HT802 support all the traditional and advanced telephony features.

Table 6: HT801/HT802 Call Features

Key	Call features
*02	<b>Forcing a Codec</b> (per call) *027110 (PCMU), *027111 (PCMA), *02723 (G723), *02729 (G729), *027201 (iLBC). *02722 (G722).
*03	<b>Disable LEC</b> (per call) Dial “*03” +” number”. No dial tone is played in the middle.
*16	<b>Enable SRTP.</b>
*17	<b>Disable SRTP.</b>
*30	<b>Block Caller ID</b> (for all subsequent calls).
*31	<b>Send Caller ID</b> (for all subsequent calls).
*47	<b>Direct IP Calling.</b> Dial “*47” + “IP address”. No dial tone is played in the middle.
*50	<b>Disable Call Waiting</b> (for all subsequent calls).
*51	<b>Enable Call Waiting</b> (for all subsequent calls).
*67	<b>Block Caller ID (per call).</b> Dial “*67” +” number”. No dial tone is played in the middle.
*82	<b>Send Caller ID (per call).</b> Dial “*82” +” number”. No dial tone is played in the middle.
*69	<b>Call Return Service:</b> Dial *69 and the phone will dial the last incoming phone number received.
*70	<b>Disable Call Waiting (per call).</b> Dial “*70” +” number”. No dial tone is played in the middle.
*71	<b>Enable Call Waiting (per call).</b> Dial “*71” +” number”. No dial tone is played in the middle.
*72	<b>Unconditional Call Forward:</b> Dial “*72” and then the forwarding number followed by “#”. Wait for dial tone and hang up. (Dial tone indicates successful forward)
*73	<b>Cancel Unconditional Call Forward.</b> To cancel “Unconditional Call Forward”, dial “*73”, wait for dial tone, then hang up.
*74	<b>Enable Paging Call:</b> Dial “*74” and then the destination phone number you want to page.



<b>*78</b>	<b>Enable Do Not Disturb (DND):</b> When enabled all incoming calls are rejected.
<b>*79</b>	<b>Disable Do Not Disturb (DND):</b> When disabled, incoming calls are accepted.
<b>*87</b>	<b>Blind Transfer.</b>
<b>*90</b>	<b>Busy Call Forward:</b> Dial “*90” and then the forwarding number followed by “#”. Wait for dial tone then hang up.
<b>*91</b>	<b>Cancel Busy Call Forward.</b> To cancel “Busy Call Forward”, dial “*91”, wait for dial tone, then hang up.
<b>*92</b>	<b>Delayed Call Forward.</b> Dial “*92” and then the forwarding number followed by “#”. Wait for dial tone then hang up.
<b>*93</b>	<b>Cancel Delayed Call Forward.</b> To cancel Delayed Call Forward, dial “*93”, wait for dial tone, then hang up.
<b>Flash/ Hook</b>	Toggles between active call and incoming call (call waiting tone). If not in conversation, flash/hook will switch to a new channel for a new call.
<b>#</b>	Pressing pound sign will serve as Re-Dial key.

## CALL OPERATIONS

### Placing a phone call

To make the outgoing calls using your HT801/HT802:

1. Pick up the handset of the connected phone;
2. Dial the number directly and wait for 4 seconds (Default “No Key Entry Timeout”); or
3. Dial the number directly and press # (Use # as dial key” must be configured in web configuration).

#### Examples:

1. Dial an extension directly on the same proxy, (e.g. 1008), and then press the # or wait for 4 seconds;
2. Dial an outside number (e.g. (626) 666-7890), first enter the prefix number (usually 1+ or international code) followed by the phone number. Press # or wait for 4 seconds. Check with your VoIP service provider for further details on prefix numbers.

### Direct IP calls

Direct IP calling allows two parties, that is, a FXS Port with an analog phone and another VoIP Device, to talk to each other in an ad hoc fashion without a SIP proxy.

#### Elements necessary to completing a Direct IP Call:

- Both HT801/HT802 and other VoIP Device, have public IP addresses, or
- Both HT801/HT802 and other VoIP Device are on the same LAN using private IP addresses, or
- Both HT801/HT802 and other VoIP Device can be connected through a router using public or private IP addresses (with necessary port forwarding or DMZ).

The HT801/HT802 supports two ways to make Direct IP Calling:

#### Using IVR

1. Pick up the analog phone then access the voice menu prompt by dialing “\*\*\*\*”;
2. Dial “47” to access the direct IP call menu;
3. Enter the IP address after the dial tone and voice prompt “Direct IP Calling”.

#### Using Star Code

1. Pick up the analog phone then dial “\*47”;
2. Enter the target IP address.

**Note:** No dial tone will be played between step 1 and 2 and destination ports can be specified using “\*” (encoding for “.”) followed by the port number.

#### Examples of Direct IP Calls:





a) If the target IP address is 192.168.0.160, the dialing convention is **\*47 or Voice Prompt with option 47, then 192\*168\*0\*160**, followed by pressing the “#” key if it is configured as a send key or wait 4 seconds.

In this case, the default destination port 5060 is used if no port is specified;

b) If the target IP address/port is 192.168.1.20:5062, then the dialing convention would be: **\*47 or Voice Prompt with option 47, then 192\*168\*0\*160\*5062** followed by pressing the “#” key if it is configured as a send key or wait for 4 seconds.

**Note:** When completing direct IP call, the “**Use Random SIP/RTP Port**” should be set to “NO”.

## Call Hold

You can place a call on hold by pressing the “flash” button on the analog phone (if the phone has that button).

Press the “flash” button again to release the previously held Caller and resume conversation. If no “flash” button is available, use “hook flash” (toggle on-off hook quickly). You may drop a call using hook flash.

## Call Waiting

The call waiting tone (3 short beeps) indicates an incoming call, if the call waiting feature is enabled.

To toggle between incoming call and current call, you need to press the “flash” button the first call is placed on hold.

Press the “flash” button to toggle between the active calls.

## Call Transfer

### Blind Transfer

Assume that the call is established between phone A and B are in conversation. The phone A wants to *blind transfer* phone B to phone C:

1. On the phone A presses FLASH to hear the dial tone.
2. The phone A dials \*87 then dials caller C’s number, and then # (or wait for 4 seconds).
3. The phone A will hear the dial tone. Then, A can hang up.

**Note:** “Enable Call Feature” must be set to “Yes” in web configuration page.

### Attended Transfer

Assume that the call is established between phone A and B are in conversation. The phone A wants to *attend transfer* phone B to phone C:

1. On the phone A presses FLASH to hear the dial tone.



2. Phone A dials the phone C's number followed by # (or wait for 4 seconds).
3. If phone C answers the call, phones A and C are in conversation. Then A can hang up to complete transfer.
4. If phone C does not answer the call, phone A can press "flash" to resume call with phone B.

**Note:** When attended transfer fails and A hangs up, the HT801/HT802 will ring back user A to remind A that B is still on the call. A can pick up the phone to resume conversation with B.

### 3-Way Conferencing

The HT801/HT802 supports Bellcore style 3-way Conference. To perform the 3-way conference, we assume that the call is established between phone A and B are in conversation. Phone A(HT801/HT802) wants to bring third phone C into conference:

1. Phone A presses FLASH (on the analog phone, or Hook Flash for old model phones) to get a dial tone.
2. Phone A dials C's number then # (or wait for 4 seconds).
3. If phone C answers the call, then A presses FLASH to bring B, C in the conference.
4. If phone C does not answer the call, phone A can press FLASH back to talk to phone B.
5. If phone A presses FLASH during conference, the phone C will be dropped out.
6. If phone A hangs up, the conference will be terminated for all three parties when configuration "Transfer on Conference Hang up" is set to "No". If the configuration is set to "Yes", A will transfer B to C so that B and C can continue the conversation.

### Call Return

To call back to the latest incoming number.

1. Pick up the handset of the connected phone (Off-hook).
2. After hearing the dial tone, input "\*69".
3. Your phone will automatically call back to the latest incoming number.

**Note:** All star code (\*XX) related features mentioned above are supported by ATA default settings. If your service provider provides different feature codes, please contact them for instructions.

### Inter-Port Calling

In some cases, a user may want to make phone calls between the phones connected to the ports of the same HT802 when it is used as a standalone unit, without the use of a SIP server. In such cases, users still will be able to make inter-port calls by using the IVR feature.



On the HT802 inter-port calling is achieved by dialing \*\*\* 70X (X is the port number). For example, the user connected to port 1 can be reached by dialing \*\*\* and 701.

## Flash Digit Control

If the option “Flash Digit Control” is enabled on web UI, call operation will require different steps as follows:

- **Call Hold:**

Assume that the call is established between phone A and B.

The phone A received a call from C, then it held B to answer C.

Press the “Flash + 1” to hang up the current call (A – C) and resume call on hold (B).

Or press “Flash + 2” to hold current call (A – C) and resume call on hold (B).

- **Attended transfer:**

Assume that the call is established between phone A and B. The phone A wants to *attend transfer* phone B to phone C:

1. On the phone A presses FLASH to hear the dial tone.
2. Phone A dials the phone C’s number followed by # (or wait for 4 seconds).
3. If phone C answers the call, phones A and C are in conversation. Then A can press “Flash + 4” to complete transfer.

- **3-Way Conferencing:**

Assume that the call is established, and phone A and B are in conversation. Phone A(HT801/HT802) wants to bring third phone C into conference:

1. Phone A presses Flash (on the analog phone, or Hook Flash for old model phones) to get a dial tone.
2. Phone A dials C’s number then # (or wait for 4 seconds).
3. When phone C answers the call, then A can press “Flash +3” to bring B, C in the conference.



## RESTORE FACTORY DEFAULT SETTINGS

---

 **Warning:**

Restoring the Factory Default Settings will delete all configuration information on the phone. Please backup or print all the settings before you restore to the factory default settings. Grandstream is not responsible for restoring lost parameters and cannot connect your device to your VoIP service provider.

---

There are three (3) methods for resetting your unit:

### Using the Reset Button

To reset default factory settings using the reset button please follow the steps above:

1. Unplug the Ethernet cable.
2. Locate the reset hole on the back panel of your HT801/HT802.
3. Insert a pin in this hole, and press for about 7 seconds.
4. Take out the pin. All unit settings are restored to factory settings.

### Using the IVR Command

Reset default factory settings using the IVR prompt:

1. Dial “\*\*\*\*” for voice prompt.
2. Enter “99” and wait for “reset” voice prompt.
3. Enter the encoded MAC address (Look below on how to encode MAC address).
4. Wait 15 seconds and device will automatically reboot and restore factory settings.

### Encode the MAC Address

1. Locate the MAC address of the device. It is the 12-digit HEX number on the bottom of the unit.
2. Key in the MAC address. Use the following mapping:

Table 7: MAC Address Key Mapping

Key	Mapping
0-9	0-9
A	22 (press the “2” key twice, “A” will show on the LCD)
B	222



<b>C</b>	2222
<b>D</b>	33 (press the “3” key twice, “D” will show on the LCD)
<b>E</b>	333
<b>F</b>	3333

For example: if the MAC address is 000b8200e395, it should be keyed in as “0002228200333395”.



## EXPERIENCING HT801/HT802

Please visit our website: <http://www.grandstream.com> to receive the most up- to-date updates on firmware releases, additional features, FAQs, documentation and news on new products.

We encourage you to browse our [product related documentation](#), [FAQs](#) and [User and Developer Forum](#) for answers to your general questions. If you have purchased our products through a Grandstream Certified Partner or Reseller, please contact them directly for immediate support.

Our technical support staff is trained and ready to answer all of your questions. Contact a technical support member or [submit a trouble ticket online](#) to receive in-depth support.

Thank you again for purchasing Grandstream analogue telephone adapter, it will be sure to bring convenience to both your business and personal life.

