



HP DeskJet 2130 All-in-One series

Table of contents

1 HP DeskJet 2130 series Help	1
2 Get started	3
Printer parts	4
Control panel features	5
Status lights	6
Load media	10
Load an original on the scanner glass	14
Paper basics	15
Open the HP printer software (Windows)	17
Sleep mode	18
Auto-Off	19
3 Print	21
Print documents	22
Print photos	24
Print envelopes	26
Print using the maximum dpi	27
Tips for print success	28
4 Copy and scan	31
Copy documents	32
Scan	33
Tips for copy and scan success	36
5 Manage ink cartridges	37
Check estimated ink levels	38
Order ink supplies	39
Replace ink cartridges	40
Use single-cartridge mode	42
Cartridge warranty information	43

Tips for working with cartridges	44
6 Connect your printer	45
Connect your printer to your computer with a USB cable (non-network connection)	46
Connect a new printer	47
7 Solve a problem	49
Jams and paper-feed issues	50
Ink cartridge issues	54
Printing issues	56
Copy issues	64
Scan issues	65
Printer hardware issues	66
HP support	67
Appendix A Technical information	69
Hewlett-Packard Company notices	70
Specifications	71
Environmental product stewardship program	73
Regulatory notices	78
Index	83

1 HP DeskJet 2130 series Help

Learn how to use your HP DeskJet 2130 series.

- [Get started on page 3](#)
- [Print on page 21](#)
- [Copy and scan on page 31](#)
- [Manage ink cartridges on page 37](#)
- [Connect your printer on page 45](#)
- [Technical information on page 69](#)
- [Solve a problem on page 49](#)

2 Get started

- [Printer parts](#)
- [Control panel features](#)
- [Status lights](#)
- [Load media](#)
- [Load an original on the scanner glass](#)
- [Paper basics](#)
- [Open the HP printer software \(Windows\)](#)
- [Sleep mode](#)
- [Auto-Off](#)

Printer parts

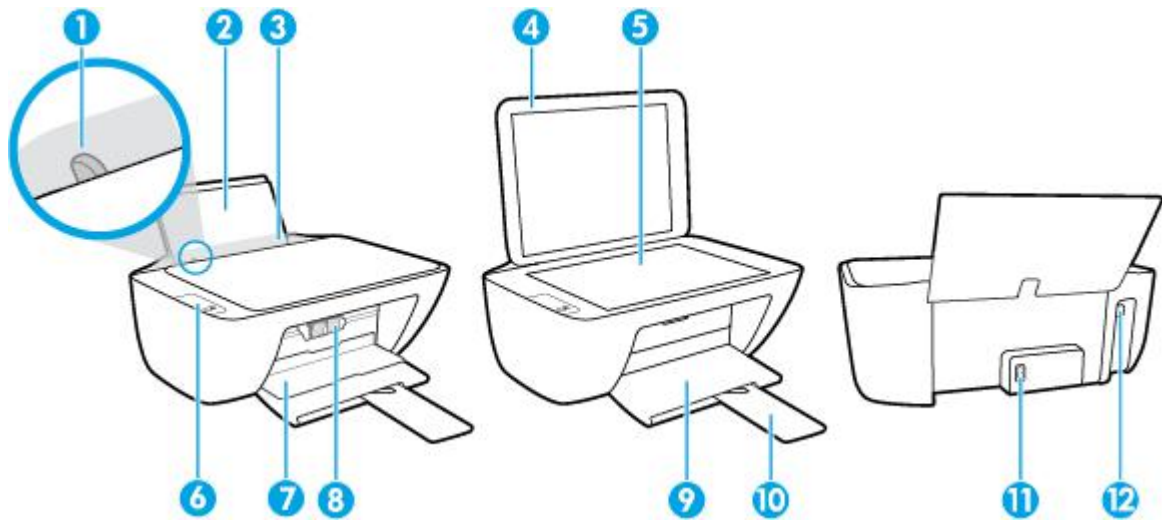

1	Paper-width guide
2	Input tray
3	Input tray shield
4	Scanner lid
5	Scanner glass
6	Control panel
7	Cartridge access door
8	Ink cartridges
9	Output tray
10	Output tray extender (also referred to as the tray extender)
11	Power connection
12	USB port

Control panel features

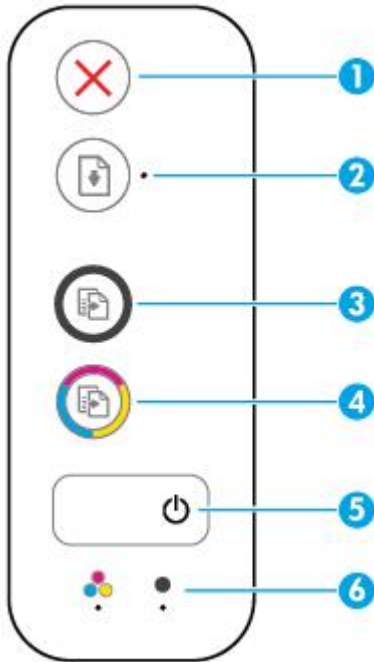

Feature	Description
1	Cancel button: Stops the current operation.
2	Resume button: Resumes a job after a disruption (for example, after loading paper or clearing a paper jam). Resume light: Indicates the printer is in a warning or error state.
3	Start Copy Black button: Starts a black-and-white copy job. To increase the number of black-and-white copies, press the button multiple times. Copying will start two seconds after the last button press.
4	Start Copy Color button: Starts a color copy job. To increase the number of color copies, press the button multiple times. Copying will start two seconds after the last button press.
5	Power button: Turns the printer on or off.
6	Ink Alert lights: Indicates low ink or an ink cartridge problem.

Status lights

- **Power button light**



Status	Description
On	The printer is on.
Off	The printer is powered off.
Dimmed	Indicates the printer is in Sleep mode. The printer automatically enters Sleep mode after 5 minutes of inactivity.
Blinking	The printer is processing a job. To cancel the job, press the Cancel button (✗).
Fast blinking	If the cartridge access door is open, close it. If the cartridge access door is closed and the light is fast blinking, the printer is in an error state that you can resolve by following the on-screen messages from the computer. If you do not see any on-screen messages, try printing a document to generate an on-screen message.

- The **Resume** light is blinking.



Cause	Solution
There is no paper in the input tray.	Load paper in the input tray, and then press the Resume button (📄) to continue printing. For information about how to load paper, see Load media on page 10 .

- The **Resume** light is off and one **Ink Alert** light is on.

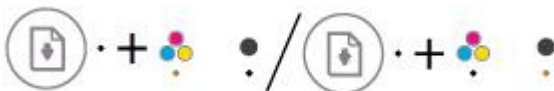

Cause	Solution
One of the following might have occurred.	— If one of the ink cartridges is missing, the printer enters the single-cartridge mode. To exit the single-cartridge mode, insert the corresponding ink cartridge. For more information about the single-cartridge mode, see Use single-cartridge mode on page 42 .
— The corresponding ink cartridge is missing.	— If both ink cartridges are installed in the printer, remove the corresponding ink cartridge, make sure there is no plastic tape on it, and then reinsert the ink cartridge securely. For more information, see Replace ink cartridges on page 40 .
— The corresponding ink cartridge is installed improperly, or still has plastic tape on it.	— If the ink cartridge is low on ink, the printer can continue to print using the remaining ink. The quality of printed documents might be affected. Replace the ink cartridge when the print quality is no longer acceptable. For more information, see Replace ink cartridges on page 40 .
— The corresponding ink cartridge is low on ink.	

- The **Resume** light is off and both **Ink Alert** lights are on.



Cause

Both ink cartridges are low on ink.

Solution

The printer can continue to print using the remaining ink. The quality of printed documents might be affected. Replace the ink cartridges when the print quality is no longer acceptable. For information about how to replace ink cartridges, see [Replace ink cartridges on page 40](#).

- The **Resume** light is off and one **Ink Alert** light is blinking.



Cause

The corresponding ink cartridge is incompatible, damaged, or incorrectly installed.

Solution

- Make sure that you are using the correct HP ink cartridge for your printer.
- Make sure the corresponding ink cartridge is installed in the correct slot.
- If the error persists, replace the ink cartridge. For information about how to replace ink cartridges, see [Replace ink cartridges on page 40](#).

- The **Resume** light is off and both **Ink Alert** lights are blinking.



Cause

One of the following might have occurred.

- Both ink cartridges are missing.
- Both ink cartridges are installed improperly, or still have plastic tape on them.
- Both ink cartridges are incompatible or damaged.

Solution

- If there is no ink cartridge installed in the printer, install the ink cartridges.
- If both ink cartridges are installed in the printer, remove the cartridges, make sure there is no plastic tape on them, and then reinsert the ink cartridges securely.
- Make sure that you are using the correct HP ink cartridges for your printer.
- If the error persists, replace the ink cartridges. For information about how to replace ink cartridges, see [Replace ink cartridges on page 40](#).

- The **Resume** light is blinking and one **Ink Alert** light is on.



Cause	Solution
<p>One of the following might have occurred.</p> <ul style="list-style-type: none"> — A counterfeit or previously used ink cartridge is installed. — The corresponding ink cartridge is very low on ink. 	<ul style="list-style-type: none"> — If the corresponding ink cartridge is newly installed, it might be counterfeit or previously used. Refer to the message in your HP printer software for more information. — If the corresponding ink cartridge is not newly installed, it is very low on ink. Press the Resume button () to continue printing, and replace the ink cartridge when the print quality is no longer acceptable. For information about how to replace ink cartridges, see Replace ink cartridges on page 40.

- The **Resume** light is blinking and both **Ink Alert** lights are on.



Cause	Solution
<p>One of the following might have occurred.</p> <ul style="list-style-type: none"> — The counterfeit or previously used ink cartridges are installed. — Both of the ink cartridges are very low on ink. 	<ul style="list-style-type: none"> — If the ink cartridges are newly installed, they might be counterfeit or previously used. Refer to the message in the HP printer software for more information. — If the ink cartridges are not newly installed, they are very low on ink. Press the Resume button () to continue printing, and replace the ink cartridges when the print quality is no longer acceptable. For information about how to replace ink cartridges, see Replace ink cartridges on page 40.

- The **Resume** light is blinking, the **Power** button light is on, and both **Ink Alert** lights are blinking.



Cause	Solution
<p>One of the following might have occurred.</p> <ul style="list-style-type: none"> — There is a paper jam. — The cartridge carriage inside the printer has stalled. 	<p>Clear paper jams or carriage jams if any. For more information, see Jams and paper-feed issues on page 50.</p>

- The **Resume** light, the **Power** button light, and both **Ink Alert** lights are blinking.



Cause	Solution
One of the following might have occurred.	Reset the printer.
— The scanner is not working.	1. Turn off the printer.
— The printer is in an error state.	2. Unplug the power cord.
	3. Wait a minute, and then plug the power cord back in.
	4. Turn on the printer.
	If the problem persists, contact HP. The printer can still print even if the scanner is not working.

Load media

Select a paper size to continue.

To load full-size paper

1. Raise the input tray.



2. Slide the paper-width guide to the left.

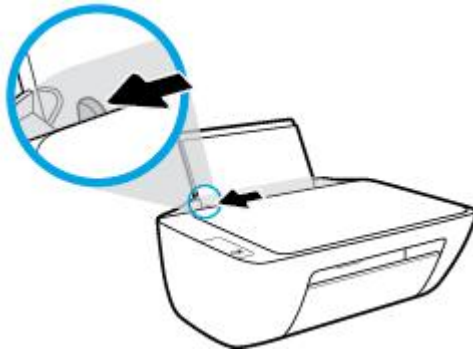

3. Insert a stack of paper into the input tray with the short edge down and the print side up, and slide the stack of paper down until it stops.



4. Slide the paper-width guide to the right until it stops at the edge of the paper.

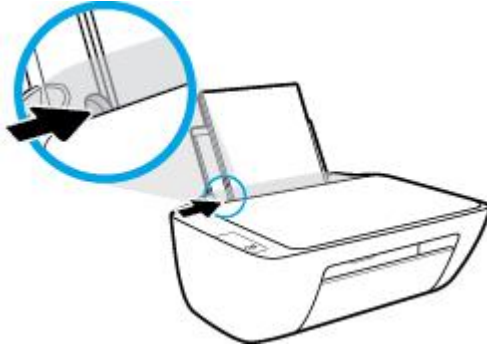

5. Lower the output tray and pull out the output tray extender.



To load small-size paper

1. Raise the input tray.



2. Slide the paper-width guide to the left.



3. Insert a stack of photo paper into the far-right side of the input tray with the short edge down and the print side up, and slide the stack of paper down until it stops.



4. Slide the paper-width guide to the right until it stops at the edge of the paper.

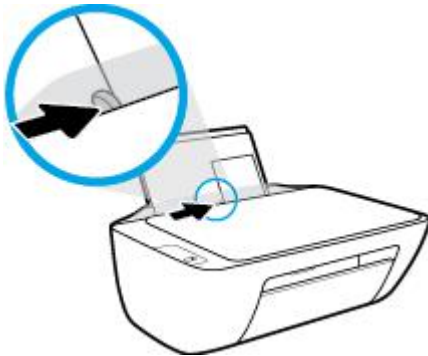

5. Lower the output tray and pull out the output tray extender.



To load envelopes

1. Raise the input tray.



2. Slide the paper-width guide to the left.

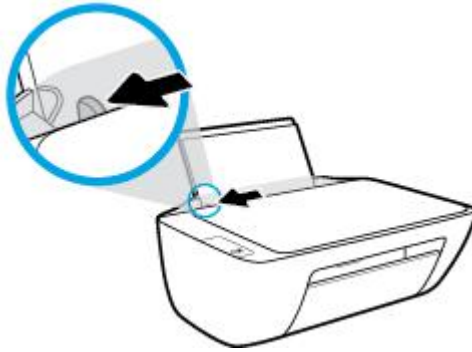

3. Insert one or more envelopes into the far-right side of the input tray and slide the stack of envelopes down until it stops.

The side to be printed on should face up. The flap should be on the left side and facing down.



4. Slide the paper-width guide to the right against the stack of envelopes until it stops.

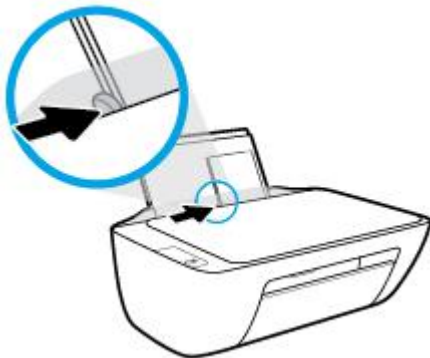

5. Lower the output tray and pull out the output tray extender.



Load an original on the scanner glass

To load an original on the scanner glass

1. Lift the scanner lid.

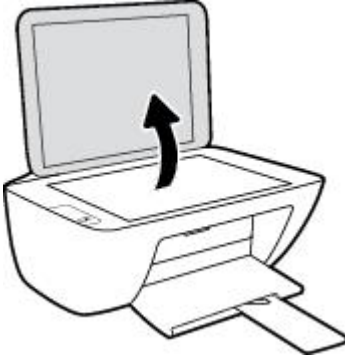

2. Load the original print-side down on the right corner of the scanner glass.



3. Close the scanner lid.

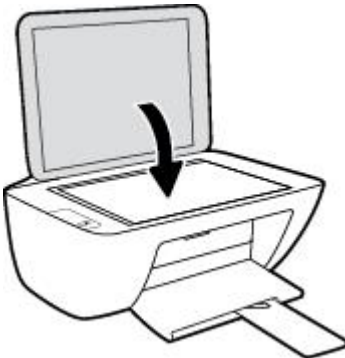

Paper basics

The printer is designed to work well with most types of office paper. It is best to test a variety of print paper types before buying large quantities. Use HP paper for optimum print quality. Visit the HP website at www.hp.com for more information about HP paper.



HP recommends plain papers with the ColorLok logo for printing everyday documents. All papers with the ColorLok logo are independently tested to meet high standards of reliability and print quality, and produce documents with crisp, vivid color, bolder blacks, and that dry faster than ordinary plain papers. Look for papers with the ColorLok logo in a variety of weights and sizes from major paper manufacturers.

This section contains the following topics:

- [Recommended papers for printing](#)
- [Order HP paper supplies](#)

Recommended papers for printing

If you want the best print quality, HP recommends using HP papers that are specifically designed for the type of project you are printing.

Depending on your country/region, some of these papers might not be available.

Photo printing

- **HP Premium Plus Photo Paper**

HP Premium Plus Photo Paper is HP's highest-quality photo paper for your best photos. With HP Premium Plus Photo Paper, you can print beautiful photos that are instant-dry so you can share them right off the printer. It is available in several sizes, including A4, 8.5 x 11 inches, 4 x 6 inches (10 x 15 cm), 5 x 7 inches (13 x 18 cm), and in two finishes - glossy or soft gloss (semi-gloss). Ideal for framing, displaying, or gifting your best photos and special photo projects. HP Premium Plus Photo Paper delivers exceptional results with professional quality and durability.

- **HP Advanced Photo Paper**

This glossy photo paper features an instant-dry finish for easy handling without smudging. It resists water, smears, fingerprints, and humidity. Your prints have a look and feel comparable to a store-processed photo. It is available in several sizes, including A4, 8.5 x 11 inches, 10 x 15 cm (4 x 6 inches), 13 x 18 cm (5 x 7 inches). It is acid-free for longer lasting documents.

- **HP Everyday Photo Paper**

Print colorful, everyday snapshots at a low cost, using paper designed for casual photo printing. This affordable photo paper dries quickly for easy handling. Get sharp, crisp images when you use this paper with any inkjet printer. It is available in glossy finish in several sizes, including A4, 8.5 x 11 inches, 5 x 7 inches, and 4 x 6 inches (10 x 15 cm). It is acid-free for longer lasting documents.

- **HP Photo Value Packs**

HP Photo Value Packs conveniently package original HP ink cartridges and HP Advanced Photo Paper to save you time and take the guesswork out of printing affordable, lab-quality photos with your HP

printer. Original HP inks and HP Advanced Photo Paper have been designed to work together so your photos are long lasting and vivid, print after print. Great for printing out an entire vacation's worth of photos or multiple prints to share.

Business documents

- **HP Premium Presentation Paper 120g Matte or HP Professional Paper 120 Matt**

This paper is a heavy two-sided matte paper perfect for presentation, proposals, reports, and newsletters. It is heavyweight for an impressive look and feel.

- **HP Brochure Paper 180g Glossy or HP Professional Paper 180 Glossy**

These papers are glossy-coated on both sides for two-sided use. They are the perfect choice for near-photographic reproductions and business graphics for report covers, special presentations, brochures, mailers, and calendars.

- **HP Brochure Paper 180g Matte or HP Professional Paper 180 Matte**

These papers are matte-coated on both sides for two-sided use. They are the perfect choice for near-photographic reproductions and business graphics for report covers, special presentations, brochures, mailers, and calendars.

Everyday printing

All the papers listed for everyday printing feature ColorLok Technology for less smearing, bolder blacks, and vivid colors.

- **HP Bright White Inkjet Paper**

HP Bright White Inkjet Paper delivers high-contrast colors and sharp text. It is opaque enough for two-sided color usage with no show-through, which makes it ideal for newsletters, reports, and flyers.

- **HP Printing Paper**

HP Printing Paper is a high-quality multifunction paper. It produces documents that look and feel more substantial than documents printed on standard multipurpose or copy paper. It is acid-free for longer lasting documents.

- **HP Office Paper**

HP Office Paper is a high-quality multifunction paper. It is suitable for copies, drafts, memos, and other everyday documents. It is acid-free for longer lasting documents.

- **HP Office Recycled Paper**

HP Office Recycled Paper is a high-quality multifunction paper made with 30% recycled fiber.

Order HP paper supplies

The printer is designed to work well with most types of office paper. Use HP paper for optimum print quality.

To order HP papers and other supplies, go to www.hp.com. At this time, some portions of the HP website are available in English only.

HP recommends plain papers with the ColorLok logo for printing and copying of everyday documents. All papers with the ColorLok logo are independently tested to meet high standards of reliability and print quality, and produce documents with crisp, vivid color, bolder blacks and shorter dry-time than ordinary plain papers. Look for papers with the ColorLok logo in a variety of weights and sizes from major paper manufacturers.

Open the HP printer software (Windows)

After installing the HP printer software, double-click the printer icon on the desktop or do one of the following to open the printer software:

- **Windows 8.1:** Click the down arrow in lower left corner of the Start screen, and then select the printer name.
- **Windows 8:** Right-click an empty area on the Start screen, click **All Apps** on the app bar, and then select the printer name.
- **Windows 7, Windows Vista, and Windows XP:** From the computer desktop, click **Start**, select **All Programs**, click **HP**, click the folder for the printer, and then select the icon with the printer's name.

Sleep mode

- Power usage is reduced while in Sleep mode.
- After initial setup of printer, the printer will enter Sleep mode after 5 minutes of inactivity.
- The **Power** button light is dimmed in Sleep mode.
- The time to Sleep mode cannot be changed.

Auto-Off

This feature turns the printer off after 2 hours of inactivity to help reduce energy use. **Auto-Off turns the printer off completely, so you must use the Power button to turn the printer back on.** If your printer supports this energy saving feature, Auto-Off is automatically enabled or disabled depending on printer capabilities and connection options. Even when Auto-Off is disabled, the printer enters Sleep mode after 5 minutes of inactivity to help reduce energy use.

- Auto-Off is enabled when the printer is turned on, if the printer does not have network or fax capability, or is not using these capabilities.
- Auto-Off is disabled when a printer's wireless or Wi-Fi Direct capability is turned on or when a printer with fax, USB, or Ethernet network capability establishes a fax, USB, or Ethernet network connection.

3 Print

- [Print documents](#)
- [Print photos](#)
- [Print envelopes](#)
- [Print using the maximum dpi](#)
- [Tips for print success](#)

Print documents

Before printing documents, make sure you have paper loaded in the input tray and the output tray is open. For more information about loading paper, see [Load media on page 10](#).

To print a document (Windows)

1. From your software, select **Print**.
2. Make sure your printer is selected.
3. Click the button that opens the **Properties** dialog box.

Depending on your software application, this button might be called **Properties**, **Options**, **Printer Setup**, **Printer Properties**, **Printer**, or **Preferences**.

4. Select the appropriate options.
 - On the **Layout** tab, select **Portrait** or **Landscape** orientation.
 - On the **Paper/Quality** tab, select the appropriate paper type from the **Media** drop-down list in the **Tray Selection** area, select the appropriate print quality in the **Quality Settings** area, and then select the appropriate color in the **Color** area.
 - Click **Advanced** to select the appropriate paper size from the **Paper Size** drop-down list.
5. Click **OK** to close the **Properties** dialog box.
6. Click **Print** or **OK** to begin printing.

To print documents (OS X)

1. From the **File** menu in your software, choose **Print**.
2. Make sure your printer is selected.
3. Specify the page properties.

If you do not see options on the Print dialog, click **Show Details**.



NOTE: The following options are available for a USB connected printer. Locations for the options can vary from one application to another.

- Choose the paper size.



NOTE: If you change the **Paper Size** ensure that you have loaded the correct paper.

- Select the orientation.
- Enter the scaling percentage.

4. Click **Print**.

To print on both sides of the page (Windows)

1. From your software, select **Print**.
2. Make sure your printer is selected.

3. Click the button that opens the **Properties** dialog box.

Depending on your software application, this button might be called **Properties, Options, Printer Setup, Printer Properties, Printer,** or **Preferences.**

4. Select the appropriate options.
 - On the **Layout** tab, select **Portrait** or **Landscape** orientation.
 - On the **Paper/Quality** tab, select the appropriate paper type from the **Media** drop-down list in the **Tray Selection** area, select the appropriate print quality in the **Quality Settings** area, and then select the appropriate color in the **Color** area.
 - Click **Advanced** to select the appropriate paper size from the **Paper Size** drop-down list.
5. On the **Layout** tab, select an appropriate option from the **Print on Both Sides Manually** drop-down list.
6. After you print the first side, follow the on-screen instructions to reload the paper with the blank side up and top of the page down, and then click **Continue.**
7. Click **OK** to print.

To print on both sides of the page (OS X)

1. From the **File** menu in your software, choose **Print.**
2. In the Print dialog, choose **Paper Handling** from the pop-up menu and set **Page Order** to **Normal.**
3. Set **Pages to Print** to **Odd only.**
4. Click **Print.**
5. After all of the odd numbered pages have printed, remove the document from the output tray.
6. Reload the document so that the end that came out of the printer is now going into the printer and the blank side of the document is facing toward the front of the printer.
7. In the Print dialog, return to the **Paper Handling** pop-up menu and set the page order to **Normal** and the pages to print to **Even Only.**
8. Click **Print.**

Print photos

Before printing photos, make sure you have photo paper loaded in the input tray and the output tray is open. For more information about loading paper, see [Load media on page 10](#).

To print a photo on photo paper (Windows)

1. From your software, select **Print**.
2. Make sure your printer is selected.
3. Click the button that opens the **Properties** dialog box.

Depending on your software application, this button might be called **Properties**, **Options**, **Printer Setup**, **Printer Properties**, **Printer**, or **Preferences**.

4. Select the appropriate options.
 - On the **Layout** tab, select **Portrait** or **Landscape** orientation.
 - On the **Paper/Quality** tab, select the appropriate paper type from the **Media** drop-down list in the **Tray Selection** area, select the appropriate print quality in the **Quality Settings** area, and then select the appropriate color in the **Color** area.
 - Click **Advanced** to select the appropriate photo size from the **Paper Size** drop-down list.
5. Click **OK** to return to the **Properties** dialog box.
6. Click **OK**, and then click **Print** or **OK** in the **Print** dialog box.

 **NOTE:** After the printing is finished, remove unused photo paper from the input tray. Store the photo paper so it does not start to curl, which could reduce the quality of your printout.

To print a photo from the computer (OS X)

1. From the **File** menu in your software, choose **Print**.
2. Make sure your printer is selected.
3. Set the print options.

If you do not see options on the Print dialog, click **Show Details**.

 **NOTE:** The following options are available for a USB connected printer. Locations for the options can vary from one application to another.

- a. Choose the appropriate paper size in the **Paper Size** pop-up menu.

 **NOTE:** If you change the **Paper Size** ensure that you have loaded the correct paper.

- b. Select an **Orientation**.
- c. From the pop-up menu, choose **Paper Type/Quality**, and then choose the following settings:

- **Paper Type:** The appropriate photo paper type
 - **Quality: Best or Maximum dpi**
 - Click the **Color Options** disclosure triangle, and then choose the appropriate **Photo Fix** option.
 - **Off:** applies no changes to the image.
 - **Basic:** automatically focuses the image; moderately adjusts image sharpness.
4. Select any other print settings you want, and then click **Print**.

Print envelopes

Before printing envelopes, make sure you have envelopes loaded in the input tray and the output tray is open. You can load one or more envelopes into the input tray. Do not use shiny or embossed envelopes or envelopes that have clasps or windows. For more information about loading envelopes, see [Load media on page 10](#).

 **NOTE:** For specific details on how to format text for printing on envelopes, consult the help files in your word application.

To print an envelope (Windows)

1. From your software, select **Print**.
2. Make sure your printer is selected.
3. Click the button that opens the **Properties** dialog box.

Depending on your software application, this button might be called **Properties**, **Options**, **Printer Setup**, **Printer Properties**, **Printer**, or **Preferences**.

4. Select the appropriate options.
 - On the **Layout** tab, select **Portrait** or **Landscape** orientation.
 - On the **Paper/Quality** tab, select the appropriate paper type from the **Media** drop-down list in the **Tray Selection** area, select the appropriate print quality in the **Quality Settings** area, and then select the appropriate color in the **Color** area.
 - Click **Advanced** to select the appropriate envelope size from the **Paper Size** drop-down list.
5. Click **OK**, and then click **Print** or **OK** in the **Print** dialog box.

To print envelopes (OS X)

1. From the **File** menu in your software, choose **Print**.
2. Make sure your printer is selected.
3. Set the print options.

If you do not see options on the Print dialog, click **Show Details**.

 **NOTE:** The following options are available for a USB connected printer. Locations for the options can vary from one application to another.

- a. Select the appropriate envelope size from the **Paper Size** pop-up menu.

 **NOTE:** If you change the **Paper Size** ensure that you have loaded the correct paper.

- b. From the pop-up menu, choose **Paper Type/Quality**, and verify the paper type setting is set to **Plain Paper**.
4. Click **Print**.

Print using the maximum dpi

Use maximum dots per inch (dpi) to print high-quality, sharp images on photo paper.

Printing in maximum dpi takes longer than printing with other settings and requires a large amount of disk space.

For a list of supported print resolutions, visit the [HP DeskJet 2130 series support website at www.hp.com/support](http://www.hp.com/support).

To print in maximum dpi mode (Windows)

1. From your software, select **Print**.
2. Make sure your printer is selected.
3. Click the button that opens the **Properties** dialog box.

Depending on your software application, this button might be called **Properties, Options, Printer Setup, Printer Properties, Printer,** or **Preferences**.

4. Click the **Paper/Quality** tab.
5. From the **Media** drop-down list, select an appropriate paper type.
6. Click the **Advanced** button.
7. In the **Printer Features** area, select **Yes** from the **Print in Max DPI** drop-down list.
8. Select the appropriate paper size from the **Paper Size** drop-down list.
9. Click **OK** to close the advanced options.
10. Confirm **Orientation** on the **Layout** tab, and then click **OK** to print.

To print using maximum dpi (OS X)

1. From the **File** menu in your software, choose **Print**.
2. Make sure your printer is selected.
3. Set the print options.

If you do not see options on the Print dialog, click **Show Details**.



NOTE: The following options are available for a USB connected printer. Locations for the options can vary from one application to another.

- a. Choose the appropriate paper size in the **Paper Size** pop-up menu.



NOTE: If you change the **Paper Size** ensure that you have loaded the correct paper.

- b. From the pop-up menu, choose **Paper Type/Quality**, and then choose the following settings:
 - **Paper Type:** The appropriate paper type
 - **Quality: Maximum dpi**
4. Select any other print settings that you want, and then click **Print**.

Tips for print success

To print successfully, the HP ink cartridges should be functioning properly with sufficient ink, the paper should be loaded correctly, and the printer should have the appropriate settings.

Print settings do not apply to copying or scanning.

Ink tips

- Use original HP ink cartridges.
- Install both the black and tri-color cartridges correctly.
For more information, see [Replace ink cartridges on page 40](#).
- Check the estimated ink levels in the ink cartridges to make sure there is sufficient ink.
For more information, see [Check estimated ink levels on page 38](#).
- If the print quality is not acceptable, see [Printing issues on page 56](#) for more information.

Paper loading tips

- Load a stack of paper (not just one page). All of the paper in the stack should be in the same size and type to avoid a paper jam.
- Load the paper with side to be printed on facing up.
- Ensure that paper loaded in the input tray lays flat, and the edges are not bent or torn.
- Adjust the paper-width guide in the input tray to fit snugly against all paper. Make sure the paper-width guide does not bend the paper in the input tray.
For more information, see [Load media on page 10](#).

Printer settings tips (Windows)

- To change default print settings, open the HP printer software, click **Print & Scan**, and then click **Set Preferences**. For information how to open the printer software, see [Open the HP printer software \(Windows\) on page 17](#).
 - To select the number of pages to print per sheet, on the **Layout** tab, select the appropriate option from the **Pages per Sheet** drop-down list.
 - To view more printing settings, on the **Layout** or **Paper/Quality** tab, click the **Advanced** button to open the **Advanced Options** dialog box.
 - **Print in Grayscale:** Allows you to print a black and white document using the black ink only. Select **Black Ink Only**, and then click **OK**. It also allows you to print a high quality black and white image. Select **High Quality Grayscale**, and then click **OK**.
 - **Pages per Sheet Layout:** Helps you specify the order of the pages if you print the document with more than two pages per sheet.
-
-  **NOTE:** The preview on the **Layout** tab cannot reflect what you select from the **Pages per Sheet Layout** drop-down list.
-
- **HP Real Life Technologies:** This feature smooths and sharpens images and graphics for improved print quality.

- **Booklet:** Allows you to print a multiple-page document as a booklet. It places two pages on each side of a sheet that can then be folded into a booklet in half size of the paper. Select a binding method from the drop-down list, and then click **OK**.
 - **Booklet-LeftBinding:** The binding side after folded into a booklet appears at the left side. Select the option if your reading habit is from left to right.
 - **Booklet-RightBinding:** The binding side after folded into a booklet appears at the right side. Select the option if your reading habit is from right to left.



NOTE: The preview on the **Layout** tab cannot reflect what you select from the **Booklet** drop-down list.

- **Pages to Print:** Allows you to print the odd pages only, print the even pages only, or print all pages.
- **Page Borders:** Allows you to add borders to the pages if you print the document with two or more pages per sheet.



NOTE: The preview on the **Layout** tab cannot reflect what you select from the **Page Borders** drop-down list.

- You can use printing shortcut to save time setting printing preferences. A printing shortcut stores the setting values that are appropriate for a particular kind of job, so that you can set all the options with a single click. To use it, go to the **Printing Shortcut** tab, select one printing shortcut, and then click **OK**.

To add a new printing shortcut, after making settings on the **Layout** or **Paper/Quality** tab, click the **Printing Shortcut** tab, click **Save As** and enter a name, and then click **OK**.

To delete a printing shortcut, select it, and then click **Delete**.



NOTE: You cannot delete the default printing shortcuts.

Printer settings tips (OS X)

- On the Print dialog, use the **Paper Size** pop-up menu to select the size of paper loaded in the printer.
- On the Print dialog, choose the **Paper Type/Quality** pop-up menu and select the appropriate paper type and quality.
- To print a black and white document using only black ink, choose the **Paper Type/Quality** from the pop-up menu and choose **Grayscale** from the Color pop-up menu.

Notes

- Original HP ink cartridges are designed and tested with HP printers and papers to help you easily produce great results, time after time.



NOTE: HP cannot guarantee the quality or reliability of non-HP supplies. Product service or repairs required as a result of using a non-HP supply will not be covered under warranty.

If you believe the purchased original HP ink cartridges, go to:

www.hp.com/go/anticounterfeit

- Ink level warnings and indicators provide estimates for planning purposes only.



NOTE: When you receive a low-ink warning message, consider having a replacement ink cartridge available to avoid possible printing delays. You do not need to replace the ink cartridges until the print quality becomes unacceptable.

- You can print your document on both sides of the paper manually.

4 Copy and scan

- [Copy documents](#)
- [Scan](#)
- [Tips for copy and scan success](#)

Copy documents



NOTE: All documents are copied in normal quality print mode. You cannot change the print mode quality when copying.



To copy documents

1. Load paper in the input tray.

For information about how to load paper, see [Load media on page 10](#).

2. Load the original print side down on the right front corner of the scanner glass.

For more information, see [Load an original on the scanner glass on page 14](#).

3. Press either the **Start Copy Black** button () or the **Start Copy Color** button () to make a copy.

Copying will start two seconds after the last button press.



TIP: You can increase the number of copies by pressing the button multiple times.

Scan

- [Scan to a computer](#)
- [Create a new scan shortcut \(Windows\)](#)
- [Change scan settings \(Windows\)](#)

Scan to a computer

Before scanning to a computer, make sure you have already installed the HP recommended printer software. The printer and computer must be connected and turned on.

To scan a document or photo to a file (Windows)

1. Load the original print side down on the right front corner of the scanner glass.
2. Double-click the printer icon on the desktop or do one of the following to open the printer software:
 - **Windows 8.1:** Click the down arrow in lower left corner of the Start screen, and then select the printer name.
 - **Windows 8:** Right-click an empty area on the Start screen, click **All Apps** on the app bar, and then select the printer name.
 - **Windows 7, Windows Vista, and Windows XP:** From the computer desktop, click **Start**, select **All Programs**, click **HP**, click the folder for the printer, and then select the icon with the printer's name.
3. In the printer software, click **Scan a Document or Photo**.
4. Select the type of scan you want and then click **Scan**.
 - Choose **Save as PDF** to save the document (or photo) as a PDF file.
 - Choose **Save as JPEG** to save the photo (or document) as an image file.



NOTE: Click the **More** link at the top right corner of the Scan dialog to review and modify settings for any scan.

For more information, see [Change scan settings \(Windows\) on page 35](#).

If **Show Viewer After Scan** is selected, you can make adjustments to the scanned image in the preview screen.

To scan a document or photo to email (Windows)

1. Load the original print side down on the right front corner of the scanner glass.
2. Double-click the printer icon on the desktop or do one of the following to open the printer software:
 - **Windows 8.1:** Click the down arrow in lower left corner of the Start screen, and then select the printer name.
 - **Windows 8:** Right-click an empty area on the Start screen, click **All Apps** on the app bar, and then select the printer name.
 - **Windows 7, Windows Vista, and Windows XP:** From the computer desktop, click **Start**, select **All Programs**, click **HP**, click the folder for the printer, and then select the icon with the printer's name.

3. In the printer software, click **Scan a Document or Photo** .
4. Select the type of scan you want and then click **Scan** .

Choose **Email as PDF** or **Email as JPEG** to open your email software with the scanned file as an attachment.



NOTE: Click the **More** link at the top right corner of the Scan dialog to review and modify settings for any scan.

For more information, see [Change scan settings \(Windows\) on page 35](#).

If **Show Viewer After Scan** is selected, you can make adjustments to the scanned image in the preview screen.

To scan an original from HP printer software (OS X)

1. Open HP Scan.
HP Scan is located in the **Applications/Hewlett-Packard** folder at the top level of the hard disk.
2. Click **Scan** .
3. Choose the type of scan profile you want and follow the on-screen instructions.

Create a new scan shortcut (Windows)

You can create your own scan shortcut to make scanning easier. For example, you might want to regularly scan and save photos in PNG format, rather than JPEG.

1. Load the original print side down on the right front corner of the scanner glass.
2. Double-click the printer icon on the desktop or do one of the following to open the printer software:
 - **Windows 8.1:** Click the down arrow in lower left corner of the Start screen, and then select the printer name.
 - **Windows 8:** Right-click an empty area on the Start screen, click **All Apps** on the app bar, and then select the printer name.
 - **Windows 7, Windows Vista, and Windows XP:** From the computer desktop, click **Start**, select **All Programs**, click **HP**, click the folder for the printer, and then select the icon with the printer's name.
3. In the printer software, click **Scan a Document or Photo** .
4. Click **Create New Scan Shortcut** .
5. Enter a descriptive name, choose an existing shortcut on which to base your new shortcut, and then click **Create** .

For example, if you are creating a new shortcut for photos, choose either **Save as JPEG** or **Email as JPEG** . This makes available the options for working with graphics when scanning.

6. Change the settings for your new shortcut to meet your needs, and then click the save icon to the right of the shortcut.



NOTE: Click the **More** link at the top right corner of the Scan dialog to review and modify settings for any scan.

For more information, see [Change scan settings \(Windows\) on page 35](#).

Change scan settings (Windows)

You can modify any of the scan settings either for a singular use or save the changes to use permanently. These settings include options such as page size and orientation, scan resolution, contrast, and the folder location for saved scans.

1. Load the original print side down on the right front corner of the scanner glass.
2. Double-click the printer icon on the desktop or do one of the following to open the printer software:
 - **Windows 8.1:** Click the down arrow in lower left corner of the Start screen, and then select the printer name.
 - **Windows 8:** Right-click an empty area on the Start screen, click **All Apps** on the app bar, and then select the printer name.
 - **Windows 7, Windows Vista, and Windows XP:** From the computer desktop, click **Start**, select **All Programs**, click **HP**, click the folder for the printer, and then select the icon with the printer's name.
3. In the printer software, click **Scan a Document or Photo**.
4. Click the **More** link in the top right corner of the HP Scan dialog.

The detailed settings pane appears on the right. The left column summarizes the current settings for each section. The right column allows you to change the settings in the highlighted section.

5. Click each section at the left of the detailed settings pane to review the settings in that section.

You can review and change most settings using drop-down menus.

Some settings allow greater flexibility by displaying a new pane. These are indicated by a + (plus sign) at the right of the setting. You must either accept or cancel any changes on this pane to return to the detailed settings pane.

6. When you have finished changing settings, do one of the following.
 - Click **Scan**. You are prompted to save or reject the changes to the shortcut after the scan is finished.
 - Click the save icon to the right of the shortcut, and then click **Scan**.

Tips for copy and scan success

Use the following tips to copy and scan successfully:

- Keep the glass and the back of the lid clean. The scanner interprets anything it detects on the glass as part of the image.
- Load your original, print side down, on the right front corner of the glass.
- To make a large copy of a small original, scan the original into the computer, resize the image in the scanning software, and then print a copy of the enlarged image.
- To avoid incorrect or missing scanned text, make sure the brightness is set appropriately in the software.

5 Manage ink cartridges

This section contains the following topics:

- [Check estimated ink levels](#)
- [Order ink supplies](#)
- [Replace ink cartridges](#)
- [Use single-cartridge mode](#)
- [Cartridge warranty information](#)
- [Tips for working with cartridges](#)

Check estimated ink levels

You can easily check the ink supply level to determine how soon you might need to replace an ink cartridge. The ink supply level shows an estimate of the amount of ink remaining in the ink cartridges.

To check the ink levels from the HP printer software (Windows)

1. Open the HP printer software. For more information, see [Open the HP printer software \(Windows\) on page 17](#).
2. In the printer software, click the **Estimated Ink Levels** tab.

To check the ink levels from the HP printer software (OS X)

1. Open HP Utility.
HP Utility is located in the **Hewlett-Packard** folder in the **Applications** folder at the top level of the hard disk.
2. Select the HP DeskJet 2130 series from the list of devices at the left of the window.
3. Click **Supplies Status**.
The estimated ink levels appear.
4. Click **All Settings** to return to the **Information and Support** pane.

 **NOTE:** If you have installed a refilled or remanufactured ink cartridge, or an ink cartridge that has been used in another printer, the ink level indicator might be inaccurate or unavailable.

 **NOTE:** Ink level warnings and indicators provide estimates for planning purposes only. When you receive a low-ink warning message, consider having a replacement ink cartridge available to avoid possible printing delays. You do not have to replace the ink cartridges until the print quality is unacceptable.

 **NOTE:** Ink from the ink cartridges is used in the printing process in a number of different ways, including in the initialization process, which prepares the printer and cartridges for printing, and in printhead servicing, which keeps print nozzles clear and ink flowing smoothly. In addition, some residual ink is left in the ink cartridge after it is used. For more information, see www.hp.com/go/inkusage.

Order ink supplies

Before ordering cartridges, locate the correct cartridge number.

To locate the cartridge number on the printer

- The cartridge number is located inside the cartridge access door.



To locate the cartridge number from the printer software (Windows)

1. Open the HP printer software. For more information, see [Open the HP printer software \(Windows\) on page 17](#).
2. In the printer software, click **Shop**, click **Shop For Supplies Online**, and then follow the on-screen instructions.

To find the print cartridge reorder numbers (OS X)

1. Open HP Utility.

 **NOTE:** HP Utility is located in the **Hewlett-Packard** folder in the **Applications** folder at the top level of the hard disk.

2. Click **Supplies Info**.

The print cartridge ordering numbers appear.

3. Click **All Settings** to return to the **Information and Support** pane.

To order original HP supplies for the HP DeskJet 2130 series, go to www.hp.com/buy/supplies. If prompted, choose your country/region, and then follow the prompts to find the right cartridges for your printer.

 **NOTE:** Ordering ink cartridges online is not supported in all countries/regions. If it is not available in your country/region, you may still view supplies information and print a list for reference when shopping at a local HP reseller.

Replace ink cartridges

To replace the ink cartridges

1. Check that power is on.
2. Remove the ink cartridge.
 - a. Open the cartridge access door and wait for the print carriage to move to the center of the printer.

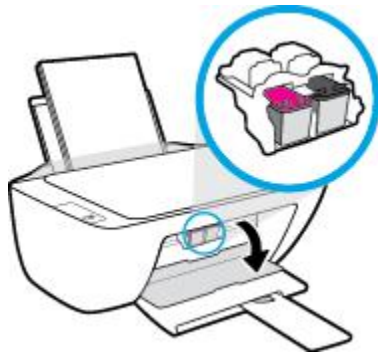

- b. Press down to release the ink cartridge, and then remove it from the slot.

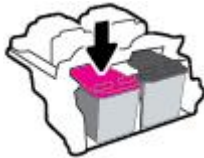

3. Insert a new ink cartridge.
 - a. Remove the ink cartridge from the packaging.

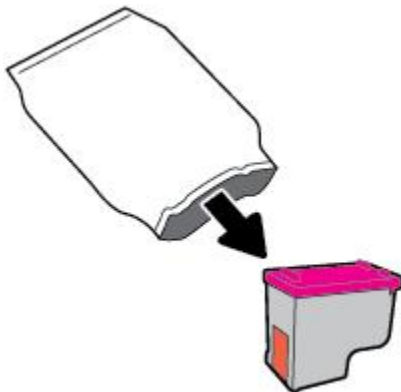

- b. Remove the plastic tape using the pull tab.

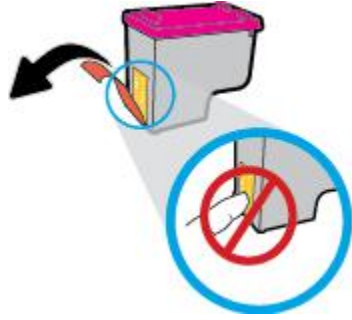

 **NOTE:** Do not touch the electrical contacts on the ink cartridge.

- c. Slide the ink cartridge into the slot until it clicks into place.

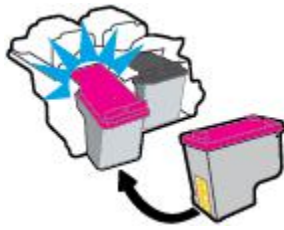

- d. Close the cartridge access door.



 **NOTE:** The HP printer software prompts you to align the ink cartridges when you print a document after installing the new ink cartridge.

Use single-cartridge mode

Use the single-cartridge mode to operate the printer with only one ink cartridge. The single-cartridge mode is initiated when an ink cartridge is removed from the ink cartridge carriage.



NOTE: When the printer operates in single-cartridge mode, a message is displayed on the computer screen. If the message is displayed and two ink cartridges are installed in the printer, verify that the protective piece of plastic tape has been removed from each ink cartridge. When the plastic tape covers the ink cartridge contacts, the printer cannot detect that the ink cartridge is installed. If there is no plastic tape on the cartridges, try cleaning the cartridge contacts. For information about cleaning ink cartridge contacts, see [ink cartridge issues on page 54](#).

To exit the single-cartridge mode

- Install both the black and tri-color ink cartridges in the printer.

Cartridge warranty information

The HP cartridge warranty is applicable when the cartridge is used in its designated HP printing device. This warranty does not cover HP ink cartridges that have been refilled, remanufactured, refurbished, misused, or tampered with.

During the warranty period, the cartridge is covered as long as the HP ink is not depleted and the end of warranty date has not been reached. The end of warranty date, in YYYY/MM/DD format, may be found on the cartridge as indicated:

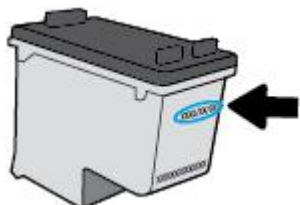

For a copy of the HP Limited Warranty Statement, see the printed documentation that came with the printer.

Tips for working with cartridges

Use the following tips to work with cartridges:

- To protect the cartridges from drying out, always turn the printer off using the **Power** button, and wait until the **Power** button light goes out.
- Do not open or untape cartridges until you are ready to install them. Leaving tape on the cartridges reduces ink evaporation.
- Insert the cartridges into the correct slots. Match the color and icon of each cartridge to the color and icon for each slot. Make sure the cartridges snap into place.
- Align the printer for best print quality. See [Printing issues on page 56](#) for more information.
- When the Estimated Ink Levels screen shows one or both cartridges in a low state, consider getting replacement cartridges to avoid possible printing delays. You do not need to replace the cartridges until print quality becomes unacceptable. See [Replace ink cartridges on page 40](#) for more information.
- If you remove a cartridge from the printer for any reason, try to replace it again as soon as possible. Outside of the printer, if unprotected, cartridges begin to dry out.

6 Connect your printer

- [Connect your printer to your computer with a USB cable \(non-network connection\)](#)
- [Connect a new printer](#)

Connect your printer to your computer with a USB cable (non-network connection)

The printer supports a rear USB 2.0 High Speed port for connection to a computer.

To connect the printer with the USB cable

1. Insert the printer software CD in the computer CD-ROM drive.



NOTE: Do not connect the USB cable to the printer until you are prompted to do so.

2. Follow the on-screen instructions. When you are prompted, connect the printer to the computer by selecting **USB** on the **Connection Options** screen.
3. Follow the on-screen instructions.

If the printer software has been installed, the printer will operate as a plug-and-play device. If the software has not been installed, insert the CD that came with the printer and follow the on-screen instructions.

Connect a new printer

If you have not connected the printer to your computer, or you want to connect another new printer of the same model to your computer, you can use the following instructions to set up the connection.



NOTE: Use this method if you have already installed the printer software.

To connect a new printer (Windows)

1. Open the printer software. For more information, see [Open the HP printer software \(Windows\) on page 17](#).
2. In the printer software, click **Utilities**.
3. Select **Printer Setup & Software**.
4. Select **Connect a new printer**. Follow the on-screen instructions.

To connect a new printer (OS X)

1. Open **System Preferences**.
2. Depending on your operating system, click **Print & Fax**, **Print & Scan**, or **Printers & Scanners** in the **Hardware** section.
3. Click + below the list of printers at the left.
4. Select the new printer from the list.

7 Solve a problem

This section contains the following topics:

- [Jams and paper-feed issues](#)
- [Ink cartridge issues](#)
- [Printing issues](#)
- [Copy issues](#)
- [Scan issues](#)
- [Printer hardware issues](#)
- [HP support](#)

Jams and paper-feed issues

What do you want to do?

Clear a paper jam

Solve paper jam issues.	Use an HP online troubleshooting wizard Instructions for clearing paper jams and resolving issues with paper or the paper feed.
---	--

 **NOTE:** The HP online troubleshooting wizards may not be available in all languages.

Read general instructions in the Help for clearing paper jams

Paper jams can occur in several locations.

To clear a paper jam from the input tray

1. Press the **Cancel** button (✗) to try to clear the jam automatically. If this does not work, complete the following steps to clear the jam manually.
2. Pull the paper gently out of the input tray.



3. Make sure there is no foreign object in the paper path, and then reload paper.

 **NOTE:** The input tray shield can prevent foreign debris from falling into the paper path and causing serious paper jams. Do not take down the input tray shield.

4. Press the **Resume** button () on the control panel to continue the current job.

To clear a paper jam from the output tray

1. Press the **Cancel** button (✗) to try to clear the jam automatically. If this does not work, complete the following steps to clear the jam manually.

2. Pull the paper gently out of the output tray.



3. Press the **Resume** button (⏪) on the control panel to continue the current job.

To clear a paper jam from the cartridge access area

1. Press the **Cancel** button (✖) to try to clear the jam automatically. If this does not work, complete the following steps to clear the jam manually.
2. Remove the jammed paper.
 - a. Press the **Power** button (⏻) to turn off the printer.
 - b. Open the cartridge access door.
 - c. If the print carriage is in the center of the printer, slide it to the right.

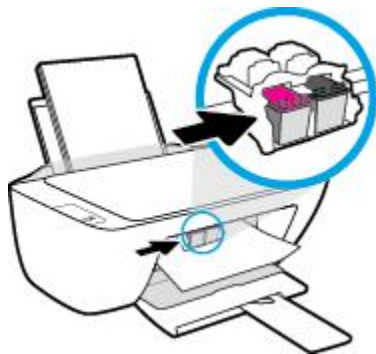

- d. Remove the jammed paper.
- 
- e. Close the cartridge access door.
3. Press the **Power** button (⏻) to turn on the printer.

To clear a paper jam inside of the printer

1. Press the **Cancel** button (✘) to try to clear the jam automatically. If this does not work, complete the following steps to clear the jam manually.
2. Press the **Power** button (⏻) to turn off the printer.
3. Turn the printer over, locate the cleanout door on the bottom of the printer, and then pull both tabs on the cleanout door to open it.

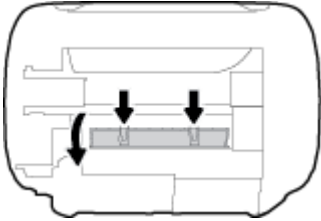

4. Remove the jammed paper.

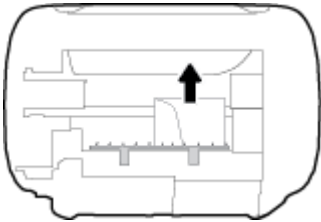

5. Close the cleanout door. Gently push the door towards the printer until both latches snap into place.

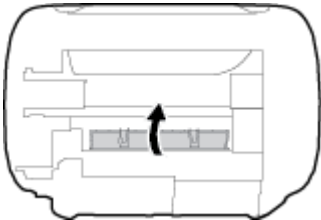

6. Turn the printer over, and then press the **Power** button (⏻) to turn on the printer.

Clear a print carriage jam

[Resolve a print carriage jam.](#)

Use an HP online troubleshooting wizard

If something is blocking the print carriage or it does not move easily, get step-by-step instructions.



NOTE: The HP online troubleshooting wizards may not be available in all languages.

Read general instructions in the Help for clearing a print carriage jams

- ▲ Remove any objects, such as paper, that are blocking the print carriage.



NOTE: Do not use any tools or other devices to remove jammed paper. Always use caution when removing jammed paper from inside the printer.

Learn how to avoid paper jams

To help avoid paper jams, follow these guidelines.

- Do not overfill the input tray.
- Remove printed papers from the output tray frequently.
- Ensure that paper loaded in the input tray lays flat, and the edges are not bent or torn.
- Do not combine different paper types and paper sizes in the input tray; the entire stack of paper in the input tray must be the same size and type.
- Adjust the paper-width guide in the input tray to fit snugly against all paper. Make sure the paper-width guide does not bend the paper in the input tray.
- Do not force paper too far down in the input tray.
- Do not add paper while the printer is printing. If the printer is about to run out of paper, wait until the out of paper message appears before adding paper.

Solve paper-feed problems

What kind of problem are you having?

- **Paper is not picked up from the input tray**
 - Make sure paper is loaded in the input tray. For more information, see [Load media on page 10](#).
 - Adjust the paper-width guide in the input tray to fit snugly against all paper. Make sure the paper-width guide does not bend the paper in the input tray.
 - Make sure paper in the input tray is not curled. Uncurl paper by bending it in the opposite direction of the curl.
- **Pages are skewing**
 - Make sure the paper is loaded in the far-right side of the input tray and the paper-width guide is fit against the left side of the paper.
 - Load paper into the printer only when it is not printing.
- **Multiple pages are being picked up**
 - Adjust the paper-width guide in the input tray to fit snugly against all paper. Make sure the paper-width guide does not bend the paper in the input tray.
 - Make sure the input tray is not overloaded with paper.
 - Make sure the pieces of the loaded paper are not sticking together.
 - Use HP paper for optimum performance and efficiency.

Ink cartridge issues

Identify whether an ink cartridge has a problem

To identify whether an ink cartridge has a problem, check the status of the corresponding **Ink Alert** light on the printer control panel. For more information, see [Status lights on page 6](#).

If you get an ink cartridge problem message from the printer software that states at least one of the cartridges has a problem, do the following to identify whether a cartridge has a problem.

1. Remove the black cartridge and then close the cartridge access door.
 - If the **Ink Alert** light for the tri-color cartridge blinks, the tri-color cartridge has a problem.
 - If the **Ink Alert** light for the tri-color cartridge does not blink, the tri-color cartridge does not have a problem.
2. Install the black cartridge back in the printer, remove tri-color cartridge, and then close the cartridge access door.
 - If the **Ink Alert** light for the black cartridge blinks, the black cartridge has a problem.
 - If the **Ink Alert** light for the black cartridge does not blink, the black cartridge does not have a problem.

Fix ink cartridge problems

If an error occurs after a cartridge is installed, or if a message indicates a cartridge problem, try removing the ink cartridges, verifying the protective piece of plastic tape has been removed from each ink cartridge, and then reinserting the ink cartridges. If this does not work, clean the cartridge contacts. If the problem is still not resolved, replace the ink cartridges. For information about replacing ink cartridges, see [Replace ink cartridges on page 40](#).

To clean cartridge contacts

CAUTION: The cleaning procedure should take only a few minutes. Make sure that the ink cartridges are reinstalled in the printer as soon as possible. It is not recommended to leave the ink cartridges outside of the printer longer than 30 minutes. This could result in damage to the printhead or the ink cartridges.

1. Check that power is on.
2. Open the cartridge access door and wait for the print carriage to move to the center of the printer.



3. Remove the ink cartridge indicated in the error message.

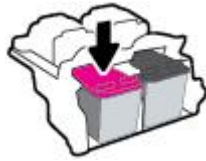

4. Clean the cartridge contacts and printer contacts.

- a. Hold the ink cartridge by its sides with the bottom pointing up and locate the electrical contacts on the ink cartridge.

The electrical contacts are the small gold-colored dots on the ink cartridge.

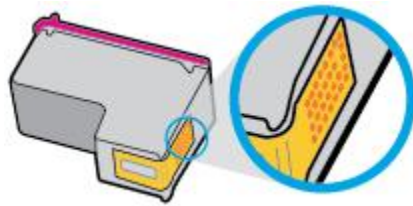

- b. Wipe only the contacts with a dry swab or lint-free cloth.

CAUTION: Be careful to wipe only the contacts, and do not smear any of the ink or other debris elsewhere on the ink cartridge.

- c. On the inside of the printer, locate the contacts for the cartridge.

The printer contacts are the set of gold-colored bumps positioned to meet the contacts on the ink cartridge.

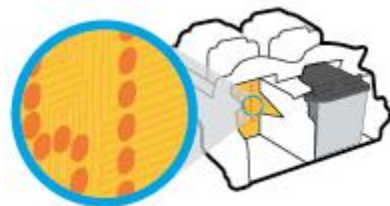

- d. Use a dry swab or lint-free cloth to wipe the contacts.

5. Reinstall the ink cartridge.

6. Close the cartridge access door.

7. Check if the error message has gone away. If you still receive the error message, turn the printer off, and then on.

 **NOTE:** If one ink cartridge is causing problems, you can remove it and use the single-cartridge mode to operate the printer with only one ink cartridge.

Fix ink cartridge incompatible issues

The ink cartridge is not compatible with your printer. Replace it with a new ink cartridge. For more information, see [Replace ink cartridges on page 40](#).

Printing issues

What do you want to do?

Fix problems with page not printing (unable to print)

HP Print and Scan Doctor	The HP Print and Scan Doctor is a utility that will try to diagnose and fix the issue automatically. NOTE: This utility is only available for Windows operation system.
Troubleshoot problems with print jobs not printing.	Use an HP online troubleshooting wizard Get step-by-step instructions if the printer is not responding or printing.



NOTE: The HP Print and Scan Doctor and the HP online troubleshooting wizards may not be available in all languages.

Read general instructions in the Help for unable to print issues

To resolve print issues (Windows)

Make sure that the printer is turned on and that there is paper in the input tray. If you are still unable to print, try the following in order:

1. Check for error messages from the printer software and resolve them by following the on-screen instructions.
2. Disconnect and reconnect the USB cable.
3. Verify that the printer is not paused or offline.

To verify that the printer is not paused or offline

- a. Depending upon your operating system, do one of the following:
 - **Windows 8.1 and Windows 8:** Point to or tap the upper-right corner of the screen to open the Charms bar, click the **Settings** icon, click or tap **Control Panel**, and then click or tap **View devices and printers**.
 - **Windows 7:** From the Windows **Start** menu, click **Devices and Printers**.
 - **Windows Vista:** From the Windows **Start** menu, click **Control Panel**, and then click **Printers**.
 - **Windows XP:** From the Windows **Start** menu, click **Control Panel**, and then click **Printers and Faxes**.
 - b. Either double-click the icon for your printer or right-click the icon for your printer and select **See what's printing** to open the print queue.
 - c. On the **Printer** menu, make sure there are no check marks next to **Pause Printing** or **Use Printer Offline**.
 - d. If you made any changes, try to print again.
4. Verify that the printer is set as the default printer.

To verify that the printer is set as the default printer

- a. Depending upon your operating system, do one of the following:
 - **Windows 8.1 and Windows 8:** Point to or tap the upper-right corner of the screen to open the Charms bar, click the **Settings** icon, click or tap **Control Panel**, and then click or tap **View devices and printers**.
 - **Windows 7:** From the Windows **Start** menu, click **Devices and Printers**.
 - **Windows Vista:** From the Windows **Start** menu, click **Control Panel**, and then click **Printers**.
 - **Windows XP:** From the Windows **Start** menu, click **Control Panel**, and then click **Printers and Faxes**.
 - b. Make sure the correct printer is set as the default printer.

The default printer has a check mark in a black or green circle next to it.
 - c. If the wrong printer is set as the default printer, right-click the correct printer and select **Set as Default Printer**.
 - d. Try using your printer again.
5. Restart the print spooler.

To restart the print spooler

- a. Depending upon your operating system, do one of the following:

Windows 8.1 and Windows 8

- i. Point to or tap the upper-right corner of the screen to open the Charms bar, and then click the **Settings** icon.
- ii. Click or tap **Control Panel**, and then click or tap **System and Security**.
- iii. Click or tap **Administrative Tools**, and then double-click or double-tap **Services**.
- iv. Right-click or touch and hold **Print Spooler**, and then click **Properties**.
- v. On the **General** tab, next to **Startup type**, make sure that **Automatic** is selected.
- vi. If the service is not already running, under **Service status**, click or tap **Start**, and then click or tap **OK**.

Windows 7

- i. From the Windows **Start** menu, click **Control Panel**, **System and Security**, and then **Administrative Tools**.
- ii. Double-click **Services**.
- iii. Right-click the **Print Spooler**, and then click **Properties**.
- iv. On the **General** tab, next to **Startup type**, make sure that **Automatic** is selected.
- v. If the service is not already running, under **Service status**, click **Start**, and then click **OK**.

Windows Vista

- i. From the Windows **Start** menu, click **Control Panel, System and Maintenance, Administrative Tools**.
- ii. Double-click **Services**.
- iii. Right-click the **Print Spooler service**, and then click **Properties**.
- iv. On the **General** tab, next to **Startup type**, make sure that **Automatic** is selected.
- v. If the service is not already running, under **Service status**, click **Start**, and then click **OK**.

Windows XP

- i. From the Windows **Start** menu, right click **My Computer**.
 - ii. Click **Manage**, and then click **Services and Applications**.
 - iii. Double-click **Services**, and then select **Print Spooler**.
 - iv. Right-click **Print Spooler**, and click **Restart** to restart the service.
- b. Make sure the correct printer is set as the default printer.
- The default printer has a check mark in a black or green circle next to it.
- c. If the wrong printer is set as the default printer, right-click the correct printer and select **Set as Default Printer**.
- d. Try using your printer again.
6. Restart the computer.
7. Clear the print queue.

To clear the print queue

- a. Depending upon your operating system, do one of the following:
 - **Windows 8.1 and Windows 8:** Point to or tap the upper-right corner of the screen to open the Charms bar, click the **Settings** icon, click or tap **Control Panel**, and then click or tap **View devices and printers**.
 - **Windows 7:** From the Windows **Start** menu, click **Devices and Printers**.
 - **Windows Vista:** From the Windows **Start** menu, click **Control Panel**, and then click **Printers**.
 - **Windows XP:** From the Windows **Start** menu, click **Control Panel**, and then click **Printers and Faxes**.
- b. Double-click the icon for your printer to open the print queue.
- c. On the **Printer** menu, click **Cancel all documents** or **Purge Print Document**, and then click **Yes** to confirm.
- d. If there are still documents in the queue, restart the computer and try printing again after the computer has restarted.
- e. Check the print queue again to make sure it is clear, and then try to print again.

To resolve print issues (OS X)

1. Check for error messages and resolve.
2. Disconnect and reconnect the USB cable.
3. Verify that the product is not paused or offline.

To verify that the product is not paused or offline

- a. In **System Preferences**, click **Print & Fax**.
- b. Click the **Open Print Queue** button.
- c. Click a print job to select it.

Use the following buttons to manage the print job:

- **Delete:** Cancel the selected print job.
 - **Hold:** Pause the selected print job.
 - **Resume:** Continue a paused print job.
 - **Pause Printer:** Pause all print jobs in the print queue.
- d. If you made any changes, try to print again.
4. Restart the computer.

Fix print quality issues

[Step-by-step instructions for resolving most print quality issues.](#)

Troubleshoot print quality issues online

Read general instructions in the Help for resolving print quality issues



NOTE: To protect the cartridges from drying out, always turn the printer off using the **Power** button, and wait until the **Power** button light goes out.

To improve print quality (Windows)

1. Make sure you are using original HP ink cartridges.
2. Check the printer software to make sure you have selected the appropriate paper type from the **Media** drop-down list and print quality from the **Quality Settings** drop-down list.

In the printer software, click **Print & Scan** and then click **Set Preferences** to access the print properties.
3. Check the estimated ink levels to determine if the ink cartridges are low on ink.

For more information, see [Check estimated ink levels on page 38](#). If the ink cartridges are low on ink consider replacing them.
4. Check the paper type.

For best print quality, use high quality HP paper, or papers that adhere to the ColorLok® standard. For more information, see [Paper basics on page 15](#).

Always make sure the paper you are printing on is flat. For best results when printing images, use HP Advanced Photo Paper.

Store specialty paper in its original packaging inside a resealable plastic bag on a flat surface in a cool, dry place. When you are ready to print, remove only the paper you plan to use immediately. When you have finished printing, return any unused photo paper to the plastic bag. This prevents the photo paper from curling.

5. Align the ink cartridges.

To align the ink cartridges

- a.** Load letter or A4 unused plain white paper into the input tray.
- b.** Open the printer software. For more information, see [Open the HP printer software \(Windows\) on page 17](#).
- c.** In the printer software, click **Print & Scan** and then click **Maintain Your Printer** to access the printer toolbox.

The printer toolbox appears.

- d.** Click **Align Ink Cartridges** on the **Device Services** tab.

The printer prints an alignment page.

- e.** Follow the on-screen instructions to load the cartridge alignment page print side down on the scanner glass, and then click **Scan** to scan the alignment page.

The printer aligns the ink cartridges. Recycle or discard the cartridge alignment sheet.

6. Print a diagnostics page if the ink cartridges are not low on ink.

To print a diagnostics page

- a.** Load letter or A4 unused plain white paper into the input tray.
- b.** Open the printer software. For more information, see [Open the HP printer software \(Windows\) on page 17](#).
- c.** In the printer software, click **Print & Scan** and then click **Maintain Your Printer** to access the printer toolbox.
- d.** Click **Print Diagnostic Information** on the **Device Reports** tab to print a diagnostics page.

- e. Review the blue, magenta, yellow, and black boxes on the diagnostics page.

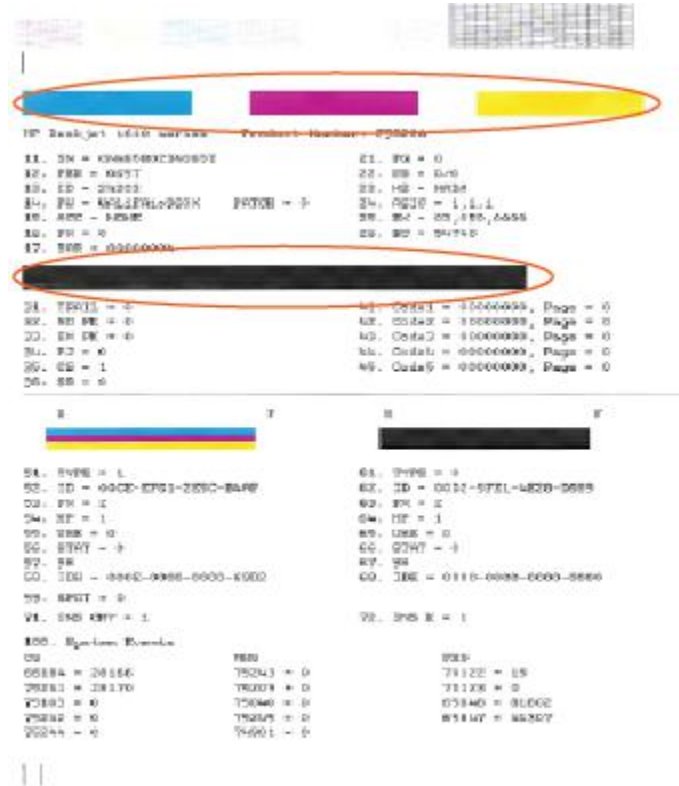

- 7. Clean the ink cartridges, if the diagnostic page shows steaks or missing portions of the color and black boxes.

To clean the ink cartridges

- a. Load letter or A4 unused plain white paper into the input tray.
- b. Open the printer software. For more information, see [Open the HP printer software \(Windows\) on page 17](#).
- c. In the printer software, click **Print & Scan** and then click **Maintain Your Printer** to access the **Printer Toolbox**.
- d. Click **Clean Ink Cartridges** on the **Device Services** tab. Follow the on-screen instructions.

To improve print quality (OS X)

- 1. Make sure you are using original HP cartridges.
- 2. Make sure you have selected the appropriate paper type and print quality in the **Print** dialog.
- 3. Check the estimated ink levels to determine if the cartridges are low on ink.

Consider replacing the print cartridges if they are low on ink.

4. Check the paper type.

For best print quality, use high quality HP paper, or papers that adhere to the ColorLok® standard. For more information, see [Paper basics on page 15](#).

Always make sure the paper you are printing on is flat. For best results when printing images, use HP Advanced Photo Paper.

Store specialty paper in its original packaging inside a resealable plastic bag on a flat surface in a cool, dry place. When you are ready to print, remove only the paper you plan to use immediately. When you have finished printing, return any unused photo paper to the plastic bag. This prevents the photo paper from curling.

5. Align the printer cartridges.

To align print cartridges from the software

- a. Load Letter or A4 plain, white paper in the paper tray.
- b. Open HP Utility.



NOTE: HP Utility is located in the **Hewlett-Packard** folder in the **Applications** folder at the top level of the hard disk.

- c. Select the HP DeskJet 2130 series from the list of devices at the left of the window.
- d. Click **Align**.
- e. Click **Align** and follow the on-screen instructions.
- f. Click **All Settings** to return to the **Information and Support** pane.

6. Print a test page.

To print a test page

- a. Load Letter or A4 plain, white paper in the paper tray.
- b. Open HP Utility.



NOTE: HP Utility is located in the **Hewlett-Packard** folder in the **Applications** folder at the top level of the hard disk.

- c. Select the HP DeskJet 2130 series from the list of devices at the left of the window.
- d. Click **Test Page**.
- e. Click the **Print Test Page** button, and follow the on-screen instructions.

Check the test page for jagged lines in the text or streaks in the text and colored boxes. If you are seeing jagged lines, or streaks, or no ink in portions of the boxes, then automatically clean the cartridges.

7. If the diagnostic page shows streaks or missing portions of the text or colored boxes, clean the print cartridges automatically.

To automatically clean the print head

- a. Load Letter or A4 plain, white paper in the paper tray.
- b. Open HP Utility.



NOTE: HP Utility is located in the **Hewlett-Packard** folder in the **Applications** folder at the top level of the hard disk.

- c. Select the HP DeskJet 2130 series from the list of devices at the left of the window.
- d. Click **Clean Printheads**.
- e. Click **Clean**, and follow the on-screen instructions.



CAUTION: Clean the print head only when necessary. Unnecessary cleaning wastes ink and shortens the life of the print head.



NOTE: If print quality still seems poor after you complete cleaning, try aligning the printer. If print quality problems persist after cleaning and aligning, contact HP support.

- f. Click **All Settings** to return to the **Information and Support** pane.

Copy issues

Troubleshoot copy problems.	Use an HP online troubleshooting wizard Get step-by-step instructions if the printer does not create a copy, or if your printouts are low quality.
---	---



NOTE: The HP online troubleshooting wizards may not be available in all languages.

[Tips for copy and scan success on page 36](#)

Scan issues

HP Print and Scan Doctor	The HP Print and Scan Doctor is a utility that will try to diagnose and fix the issue automatically. NOTE: This utility is only available for Windows operation system.
Solve scan problems	Use an HP online troubleshooting wizard Get step-by-step instructions if you cannot create a scan or if your scans are low quality.



NOTE: The HP Print and Scan Doctor and the HP online troubleshooting wizards may not be available in all languages.

[Tips for copy and scan success on page 36](#)

Printer hardware issues

Close cartridge access door

- Cartridge door must be closed to begin printing.



The printer shuts down unexpectedly

- Check the power and power connections.
- Make sure the printer's power cord is connected firmly to a functioning power outlet.



NOTE: When Auto-Off is enabled, the printer will automatically turn off after 2 hours of inactivity to help reduce energy use. For more information, see [Auto-Off on page 19](#).

Resolve printer failure

- Turn the printer off, then on. If that does not resolve the problem, contact HP.

HP support

For the latest product updates and support information, visit the [HP DeskJet 2130 series support website at www.hp.com/support](http://www.hp.com/support). HP online support provides a variety of options for help with your printer:



Drivers & downloads: Download software drivers and updates, as well as product manuals and documentation that came in the box with your printer.



HP support forums: Visit HP Support Forums for answers to common questions and issues. You can view questions posted by other HP customers, or sign in and post your own questions and comments.



Troubleshooting: Use HP online tools to detect your printer and find recommended solutions.

Contact HP

If you need help from an HP technical support representative to solve a problem, visit the [Contact Support website](#). The following contact options are available at no cost for in-warranty customers (HP agent-assisted support for out-of-warranty customers may require a fee):



Chat with an HP support agent online.



Call an HP support agent.

When contacting HP support, be prepared to provide the following information:

- Product name (Located on the printer, such as HP DeskJet 2130)
- Product number (located inside the cartridge access door)



- Serial number (located on the back or bottom of the printer)

Register printer

By taking just a few quick minutes to register, you can enjoy quicker service, more efficient support, and product support alerts. If you did not register your printer while installing the software, you can register now at <http://www.register.hp.com>.

Additional warranty options

Extended service plans are available for the HP DeskJet 2130 series at additional costs. Go to www.hp.com/support, select your country/region and language, then explore the extended warranty options available for your printer.

A Technical information

The technical specifications and international regulatory information for the HP DeskJet 2130 series are provided in this section.

For additional specifications, see the printed documentation that came with the HP DeskJet 2130 series.

This section contains the following topics:

- [Hewlett-Packard Company notices](#)
- [Specifications](#)
- [Environmental product stewardship program](#)
- [Regulatory notices](#)

Hewlett-Packard Company notices

The information contained herein is subject to change without notice.

All rights reserved. Reproduction, adaptation, or translation of this material is prohibited without prior written permission of Hewlett-Packard, except as allowed under the copyright laws. The only warranties for HP products and services are set forth in the express warranty statements accompanying such products and services. Nothing herein should be construed as constituting an additional warranty. HP shall not be liable for technical or editorial errors or omissions contained herein.

© 2014 HP Development Company, L.P.

Microsoft®, Windows®, Windows® XP, Windows Vista®, Windows® 7, Windows® 8, and Windows® 8.1 are U.S. registered trademarks of Microsoft Corporation.

Specifications

Technical specifications for the HP DeskJet 2130 series are provided in this section. For more product specifications, see the Product Data Sheet at www.hp.com/support.

System requirements

- Software and system requirements can be found in the Readme file, which is available on the HP printer software CD provided with your printer.
- For information about future operating system releases and support, visit the HP online support website at www.hp.com/support.

Environmental specifications

- Recommended operating temperature range: 15°C to 30°C (59°F to 86°F)
- Allowable operating temperature range: 5°C to 40°C (41°F to 104°F)
- Humidity: 15% to 80% RH non-condensing; 28°C maximum dewpoint
- Nonoperating (Storage) temperature range: -40°C to 60°C (-40°F to 140°F)
- In the presence of high electromagnetic fields, it is possible the output from the HP DeskJet 2130 series may be slightly distorted
- HP recommends using a USB cable less than or equal to 3 m (10 feet) in length to minimize injected noise due to potential high electromagnetic fields

Input tray capacity

- Plain paper sheets (80 g/m² [20lb]): Up to 60
- Envelopes: Up to 5
- Index cards: Up to 20
- Photo paper sheets: Up to 20

Output tray capacity

- Plain paper sheets (80 g/m² [20lb]): Up to 25
- Envelopes: Up to 5
- Index cards: Up to 10
- Photo paper sheets: Up to 10

Paper size

- For a complete list of supported media sizes, see the printer software.

Paper weights

- Plain Paper: 64 to 90 g/m² (16 to 24 lb)
- Envelopes: 75 to 90 g/m² (20 to 24 lb)

- Cards: Up to 200 g/m² (110-lb index maximum)
- Photo Paper: Up to 280 g/m² (75 lb)

Print specifications

- Print speeds vary according to the complexity of the document
- Method: drop-on-demand thermal inkjet
- Language: PCL3 GUI

Copy specifications

- Digital image processing
- Copy speeds vary according to the complexity of the document and model

Scan specifications

- Resolution: up to 1200 x 1200 ppi optical
For more information about ppi resolution, see the scanner software.
- Color: 24-bit color, 8-bit grayscale (256 levels of gray)
- Maximum scan size from glass: 21.6 x 29.7 cm (8.5 x 11.7 inches)

Print resolution

- For a list of supported print resolutions, visit the [HP DeskJet 2130 series support website at www.hp.com/support](http://www.hp.com/support).

Cartridge yield

- Visit www.hp.com/go/learnaboutesupplies for more information on estimated cartridge yields.

Acoustic information

- If you have Internet access, you can access acoustic information from the [HP website](http://www.hp.com).

Environmental product stewardship program

Hewlett-Packard is committed to providing quality products in an environmentally sound manner. Design for recycling has been incorporated into this product. The number of materials has been kept to a minimum while ensuring proper functionality and reliability. Dissimilar materials have been designed to separate easily. Fasteners and other connections are easy to locate, access, and remove using common tools. High priority parts have been designed to access quickly for efficient disassembly and repair.

For more information, visit HP's Commitment to the Environment Web site at:

www.hp.com/hpinfo/globalcitizenship/environment

- [Eco-Tips](#)
- [European Union Commission Regulation 1275/2008](#)
- [Paper use](#)
- [Plastics](#)
- [Material safety data sheets](#)
- [Recycling program](#)
- [HP inkjet supplies recycling program](#)
- [Power consumption](#)
- [Disposal of waste equipment by users](#)
- [Chemical substances](#)
- [The Table of Hazardous Substances/Elements and their Content \(China\)](#)
- [Restriction of hazardous substance \(Ukraine\)](#)
- [Restriction of hazardous substance \(India\)](#)
- [EPEAT](#)
- [China SEPA Eco Label User Information](#)
- [China Energy Label for Printer, Fax and Copier](#)

Eco-Tips

HP is committed to helping customers reduce their environmental footprint. Please visit the HP Environmental Programs and Initiatives website for more information on HP's environmental initiatives.

www.hp.com/hpinfo/globalcitizenship/environment/

European Union Commission Regulation 1275/2008

For product power data, including the power consumption of the product in networked standby if all wired network ports are connected and all wireless network ports are activated, please refer to section P14 'Additional Information' of the product IT ECO Declaration at www.hp.com/hpinfo/globalcitizenship/environment/productdata/itecodesktop-pc.html.

Paper use

This product is suited for the use of recycled paper according to DIN 19309 and EN 12281:2002.

Plastics

Plastic parts over 25 grams are marked according to international standards that enhance the ability to identify plastics for recycling purposes at the end of product life.

Material safety data sheets

Material safety data sheets (MSDS) can be obtained from the HP website at:

www.hp.com/go/msds

Recycling program

HP offers an increasing number of product return and recycling programs in many countries/regions, and partners with some of the largest electronic recycling centers throughout the world. HP conserves resources by reselling some of its most popular products. For more information regarding recycling of HP products, please visit:

www.hp.com/hpinfo/globalcitizenship/environment/recycle/

HP inkjet supplies recycling program

HP is committed to protecting the environment. The HP Inkjet Supplies Recycling Program is available in many countries/regions, and lets you recycle used print cartridges and ink cartridges free of charge. For more information, go to the following website:

www.hp.com/hpinfo/globalcitizenship/environment/recycle/

Power consumption

Hewlett-Packard printing and imaging equipment marked with the ENERGY STAR® logo is qualified to the U.S. Environmental Protection Agency's ENERGY STAR specifications for imaging equipment. The following mark will appear on ENERGY STAR qualified imaging products:



Additional ENERGY STAR qualified imaging product model information is listed at: www.hp.com/go/energystar

Disposal of waste equipment by users



This symbol means do not dispose of your product with your other household waste. Instead, you should protect human health and the environment by handing over your waste equipment to a designated collection point for the recycling of waste electrical and electronic equipment. For more information, please contact your household waste disposal service, or go to <http://www.hp.com/recycle>.

Chemical substances

HP is committed to providing our customers with information about the chemical substances in our products as needed to comply with legal requirements such as REACH (*Regulation EC No 1907/2006 of the European Parliament and the Council*). A chemical information report for this product can be found at: www.hp.com/go/reach.

The Table of Hazardous Substances/Elements and their Content (China)

产品中有毒物质或元素的名称及含量 根据中国《电子信息产品污染控制管理办法》						
部件名称	有毒有害物质或元素					
	铅 (Pb)	汞 (Hg)	镉 (Cd)	六价铬 (Cr(VI))	多溴联苯 (PBB)	多溴二苯醚 (PBDE)
外壳和托盘	0	0	0	0	0	0
电线	0	0	0	0	0	0
印刷电路板	X	0	0	0	0	0
打印系统	X	0	0	0	0	0
显示器	X	0	0	0	0	0
喷墨打印机墨盒	0	0	0	0	0	0
驱动光盘	X	0	0	0	0	0
扫描仪	X	X	0	0	0	0
网络配件	X	0	0	0	0	0
电池板	X	0	0	0	0	0
自动双面打印系统	0	0	0	0	0	0
外部电源	X	0	0	0	0	0

本表格依据SJ/T 11364 的规定编制。
 0: 表示该有害物质在该部件所有均质材料中的含量均在GB/T 26572 规定的限量要求以下。
 X: 表示该有害物质至少在该部件的某一均质材料中的含量超出GB/T 26572 规定的限量要求。

此表中所有名称中含“X”的部件均符合欧盟 RoHS 立法。

注: 环保使用期限的参考标识取决于产品正常工作的温度和湿度等条件。

Restriction of hazardous substance (Ukraine)

Технічний регламент щодо обмеження використання небезпечних речовин (Україна)

Обладнання відповідає вимогам Технічного регламенту щодо обмеження використання деяких небезпечних речовин в електричному та електронному обладнанні, затвердженого постановою Кабінету Міністрів України від 3 грудня 2008 № 1057

Restriction of hazardous substance (India)

Restriction of hazardous substances (India)

This product complies with the "India E-waste (Management and Handling) Rule 2011" and prohibits use of lead, mercury, hexavalent chromium, polybrominated biphenyls or polybrominated diphenyl ethers in concentrations exceeding 0.1 weight % and 0.01 weight % for cadmium, except for the exemptions set in Schedule 2 of the Rule.

EPEAT

EPEAT

Most HP products are designed to meet EPEAT. EPEAT is a comprehensive environmental rating that helps identify greener electronics equipment. For more information on EPEAT go to www.epeat.net. For information on HP's EPEAT registered products go to www.hp.com/hpinfo/globalcitizenship/environment/pdf/epeat_printers.pdf.

China SEPA Eco Label User Information

中国环境标识认证产品用户说明

噪声大于63.0Db(A)的办公设备不宜放置于办公室内。请在独立的隔离区域使用。

如需长时间使用本产品或打印大量文件。请确保在通风良好的房间内使用。

如您需要确认本产品处于零能耗状态。请按下电源关闭按钮。并将插头从电源插座断开。

您可以使用再生纸。以减少资源耗费。

复印机、打印机和传真机能源效率标识 实施规则

依据“复印机、打印机和传真机能源效率标识实施规则”，该打印机具有中国能效标识。标识上显示的能效等级和操作模式值根据“复印机、打印机和传真机能效限定值及能效等级”标准（“GB 21521”）来确定和计算。

1. 能效等级

产品能效等级分为3级，其中1级能效最高。能效限定值根据产品类型和打印速度由标准确定。能效等级则根据基本功耗水平以及网络接口和内存等附加组件和功能的功率因子之和来计算。

2. 能效信息

喷墨打印机

- 操作模式功率

睡眠状态的能耗按照 GB 21521 标准来衡量和计算。该数据以瓦特 (W) 表示。

- 待机功率

待机状态是产品连接到电网电源上功率最低的状态。该状态可以延续无限长时间，且使用者无法改变此状态下产品的功率。对于“成像设备”产品，“待机”状态通常相当于“关闭”状态，但也可能相当于“准备”状态或“睡眠”状态。该数据以瓦特 (W) 表示。

- 睡眠状态预设延迟时间

出厂前由制造商设置的时间决定了该产品在完成主功能后进入低耗模式（例如睡眠、自动关机）的时间。该数据以分钟表示。

- 附加功能功率因子之和

网络接口和内存等附加功能的功率因子之和。该数据以瓦特 (W) 表示。

标识上显示的能耗数据是根据典型配置测量得出的数据。此类配置包含登记备案的打印机依据复印机、打印机和传真机能源效率标识实施规则所选的所有配置。因此，该特定产品型号的实际能耗可能与标识上显示的数据有所不同。

要了解规范的更多详情，请参考最新版的 GB 21521 标准。

Regulatory notices

The HP DeskJet 2130 series meets product requirements from regulatory agencies in your country/region.

This section contains the following topics:

- [Regulatory model identification number](#)
- [FCC statement](#)
- [Notice to users in Korea](#)
- [VCCI \(Class B\) compliance statement for users in Japan](#)
- [Notice to users in Japan about the power cord](#)
- [Noise emission statement for Germany](#)
- [Visual display workplaces statement for Germany](#)
- [European Union Regulatory Notice](#)
- [Declaration of conformity](#)

Regulatory model identification number

For regulatory identification purposes, your product is assigned a Regulatory Model Number. The Regulatory Model Number for your product is SNPRH-1504-01. This regulatory number should not be confused with the marketing name (HP DeskJet 2130 All-in-One Printer, HP DeskJet Ink Advantage 2135 All-in-One Printer, etc.) or product numbers (F5S28A, F5S28B, F5S28C, F5S28D, F5S29A, F5S29B, F5S29C, etc.).

FCC statement

FCC statement

The United States Federal Communications Commission (in 47 CFR 15.105) has specified that the following notice be brought to the attention of users of this product.

This equipment has been tested and found to comply with the limits for a Class B digital device, pursuant to Part 15 of the FCC Rules. These limits are designed to provide reasonable protection against harmful interference in a residential installation. This equipment generates, uses and can radiate radio frequency energy and, if not installed and used in accordance with the instructions, may cause harmful interference to radio communications. However, there is no guarantee that interference will not occur in a particular installation. If this equipment does cause harmful interference to radio or television reception, which can be determined by turning the equipment off and on, the user is encouraged to try to correct the interference by one or more of the following measures:

- Reorient or relocate the receiving antenna.
- Increase the separation between the equipment and the receiver.
- Connect the equipment into an outlet on a circuit different from that to which the receiver is connected.
- Consult the dealer or an experienced radio/TV technician for help.

For further information, contact:

Manager of Corporate Product Regulations
Hewlett-Packard Company
3000 Hanover Street
Palo Alto, Ca 94304
(650) 857-1501

Modifications (part 15.21)

The FCC requires the user to be notified that any changes or modifications made to this device that are not expressly approved by HP may void the user's authority to operate the equipment.

This device complies with Part 15 of the FCC Rules. Operation is subject to the following two conditions: (1) this device may not cause harmful interference, and (2) this device must accept any interference received, including interference that may cause undesired operation.

Notice to users in Korea

B 급 기기 (가정용 방송통신기기)	이 기기는 가정용(B급)으로 전자파적합등록을 한 기기로서 주로 가정에서 사용하는 것을 목적으로 하며, 모든 지역에서 사용할 수 있습니다.
------------------------	--

VCCI (Class B) compliance statement for users in Japan

この装置は、クラスB情報技術装置です。この装置は、家庭環境で使用することを目的としていますが、この装置がラジオやテレビジョン受信機に近接して使用されると、受信障害を引き起こすことがあります。取扱説明書に従って正しい取り扱いをして下さい。

VCCI-B

Notice to users in Japan about the power cord

製品には、同梱された電源コードをお使い下さい。
同梱された電源コードは、他の製品では使用出来ません。

Noise emission statement for Germany

Geräuschemission

LpA < 70 dB am Arbeitsplatz im Normalbetrieb nach DIN 45635 T. 19

Visual display workplaces statement for Germany

GS-Erklärung (Deutschland)

Das Gerät ist nicht für die Benutzung im unmittelbaren Gesichtsfeld am Bildschirmarbeitsplatz vorgesehen. Um störende Reflexionen am Bildschirmarbeitsplatz zu vermeiden, darf dieses Produkt nicht im unmittelbaren Gesichtsfeld platziert werden.

European Union Regulatory Notice



Products bearing the CE marking comply with one or more of the following EU Directives as may be applicable: Low Voltage Directive 2006/95/EC, EMC Directive 2004/108/EC, Ecodesign Directive 2009/125/EC, R&TTE Directive 1999/5/EC, RoHS Directive 2011/65/EU. Compliance with these directives is assessed using applicable European Harmonised Standards. The full Declaration of Conformity can be found at the following website: www.hp.com/go/certificates (Search with the product model name or its Regulatory Model Number (RMN), which may be found on the regulatory label.)

The point of contact for regulatory matters is:

Hewlett-Packard GmbH, Dept./MS: HQ-TRE, Herrenberger Strasse 140, 71034 Boeblingen, GERMANY

Declaration of conformity



DECLARATION OF CONFORMITY

according to ISO/IEC 17050-1 and EN 17050-1

DoC #: SNPRH-1504-01-Rev A

Supplier's Name: Hewlett-Packard Company
Supplier's Address: 20, Jia Feng Road Waigaoqiao Free Trade Zone Pudong, Shanghai, PRC 200131
declares, that the product
Product Name and Model: 2) HP DeskJet 2130 All-in-One printer series
HP DeskJet Ink Advantage 2135 All-in-One printer series
Regulatory Model Number: 1) SNPRH-1504-01
Product Options: All
conforms to the following Product Specifications and Regulations:

EMC:

CISPR 22: Ed5 2005+A1:2005+A2:2006 Class B
EN 55022: 2006 +A1:2007 Class B
EN 55024:1998 + A1:2001 + A2:2003
EN 61000-3-2:2006 +A1:2009 +A2:2009
EN 61000-3-3:2008
FCC CFR 47 Part 15 Class B
ICES-003, Issue 4 Class B Class B

Safety:

EN 60950-1:2006 +A11:2009 +A1:2010 +A12:2011
IEC 60950-1:2005 +A1:2009
EN 63479:2010

Energy Use:

Regulation (EC) No. 1275/2008
ENERGY STAR® Qualified Imaging Equipment Operational Mode (OM) Test Procedure
EN 50564:2011
IEC 62301:2005

RoHS:

EN 50581:2012

The product herewith complies with the requirements of the Low Voltage Directive 2006/95/EC, the EMC Directive 2004/108/EC, the R&TTE Directive 1999/5/EC, the Ecodesign Directive 2009/125/EC, the RoHS Directive 2011/65/EU and carries the **CE** marking accordingly.

This device complies with part 15 of the FCC Rules. Operation is subject to the following two conditions:

(1) This device may not cause harmful interference, and (2) this device must accept any interference received, including interference that may cause undesired operation.

Additional Information:

- 1) This product is assigned a Regulatory Model Number which stays with the regulatory aspects of the design. The Regulatory Model Number is the main product identifier in the regulatory documentation and test reports, this number should not be confused with the marketing name or the product numbers.

15 Dec, 2014

Shen HongBo

ICS Product Hardware Quality Engineering, Manager

Local contact for regulatory topics only:

EU: Hewlett-Packard GmbH, HQ-TRE, Herrenberger Strasse 140, 71034 Boeblingen, Germany
U.S.: Hewlett-Packard, 3000 Hanover St., Palo Alto, CA 94304, U.S.A. 650-857-1501 www.hp.eu/certificates

Index

B

buttons, control panel 5

C

carriage

clear carriage jams 52

control panel

buttons 5

features 5

copy

specifications 72

customer support

warranty 68

E

environment

Environmental product

stewardship program 73

environmental specifications 71

J

jams

clear 50

M

multi-feeds, troubleshoot 53

O

operating systems supported 71

P

paper

clear jams 50

HP, order 16

skewed pages 53

troubleshoot feeding 53

paper-feed problems, troubleshoot

53

power

troubleshoot 66

print

specifications 72

troubleshoot 66

printer software (Windows)

opening 17

R

recycle

ink cartridges 74

regulatory notices 78

regulatory model identification

number 78

S

scan

scan specifications 72

skew, troubleshoot

print 53

specifications

system requirements 71

system requirements 71

T

technical information

copy specifications 72

environmental specifications 71

print specifications 72

scan specifications 72

trays

clear paper jams 50

troubleshoot feeding 53

troubleshoot

multiple pages are picked 53

paper not picked up from tray

53

paper-feed problems 53

power 66

print 66

skewed pages 53

W

warranty 68

Windows

system requirements 71

