



**HP DeskJet 3630 All-in-One series**



---

# Table of contents

|   |           |
|---|-----------|
| <b>1 HP DeskJet 3630 series Help .....</b>              | <b>1</b>  |
| <b>2 Get started .....</b>                              | <b>3</b>  |
| Printer parts .....                                     | 4         |
| Control panel features .....                            | 5         |
| Control panel lights and display icons status .....     | 7         |
| Load media .....  | 15        |
| Change the default paper size detected by printer ..... | 19        |
| Load an original on the scanner glass .....             | 20        |
| Paper basics .....                                      | 21        |
| Open the HP printer software (Windows) .....            | 23        |
| Sleep mode .....  | 24        |
| Quiet Mode .....  | 25        |
| Auto-Off .....  | 26        |
| <b>3 Print .....</b>                                    | <b>27</b> |
| Print from your computer .....                          | 28        |
| Print from your mobile device .....                     | 33        |
| Print with AirPrint .....                               | 34        |
| Tips for print success .....                            | 35        |
| <b>4 Use Web Services .....</b>                         | <b>39</b> |
| What are Web Services? .....                            | 40        |
| Set up Web Services .....                               | 41        |
| Print with HP ePrint .....                              | 42        |
| Use HP Printables .....                                 | 43        |
| Use the HP Connected website .....                      | 44        |
| Remove Web Services .....                               | 45        |
| Tips for using Web Services .....                       | 46        |

|   |            |
|---|------------|
| <b>5 Copy and scan .....</b>  | <b>47</b>  |
| Copy documents .....  | 48         |
| Scan using the HP printer software .....  | 49         |
| Scan using Webscan .....  | 52         |
| Tips for copy and scan success .....  | 53         |
| <br>  |            |
| <b>6 Manage ink cartridges .....</b>  | <b>55</b>  |
| Check estimated ink levels .....  | 56         |
| Order ink supplies .....  | 57         |
| Replace ink cartridges .....  | 58         |
| Use single-cartridge mode .....   | 61         |
| Cartridge warranty information .....  | 62         |
| Tips for working with cartridges .....  | 63         |
| <br>  |            |
| <b>7 Connect your printer .....</b>   | <b>65</b>  |
| Connect your printer to a wireless network with a router .....                        | 66         |
| Connect wirelessly to the printer without a router .....                              | 69         |
| Wireless settings .....   | 73         |
| Connect your printer to your computer with a USB cable (non-network connection) ..... | 74         |
| Change from a USB connection to a wireless network .....                              | 75         |
| Advanced printer management tools (for networked printers) .....                      | 76         |
| Tips for setting up and using a networked printer .....                               | 78         |
| <br>  |            |
| <b>8 Solve a problem .....</b>  | <b>79</b>  |
| Jams and paper-feed issues .....  | 80         |
| Ink cartridge issues .....  | 85         |
| Printing issues .....   | 88         |
| Copy issues .....   | 96         |
| Scan issues .....   | 97         |
| Network and connection issues .....   | 98         |
| Printer hardware issues .....   | 100        |
| Control panel error codes .....   | 101        |
| HP support .....  | 102        |
| <br>  |            |
| <b>Appendix A Technical information .....</b>   | <b>105</b> |
| Hewlett-Packard Company notices .....   | 106        |
| Specifications .....  | 107        |
| Environmental product stewardship program .....                                       | 109        |
| Regulatory notices .....  | 116        |





---

# 1 HP DeskJet 3630 series Help

Learn how to use your HP DeskJet 3630 series.

- [Get started on page 3](#)
- [Print on page 27](#)
- [Use Web Services on page 39](#)
- [Copy and scan on page 47](#)
- [Manage ink cartridges on page 55](#)
- [Connect your printer on page 65](#)
- [Technical information on page 105](#)
- [Solve a problem on page 79](#)





---

## 2 Get started

- [Printer parts](#)
- [Control panel features](#)
- [Control panel lights and display icons status](#)
- [Load media](#)
- [Change the default paper size detected by printer](#)
- [Load an original on the scanner glass](#)
- [Paper basics](#)
- [Open the HP printer software \(Windows\)](#)
- [Sleep mode](#)
- [Quiet Mode](#)
- [Auto-Off](#)

## Printer parts

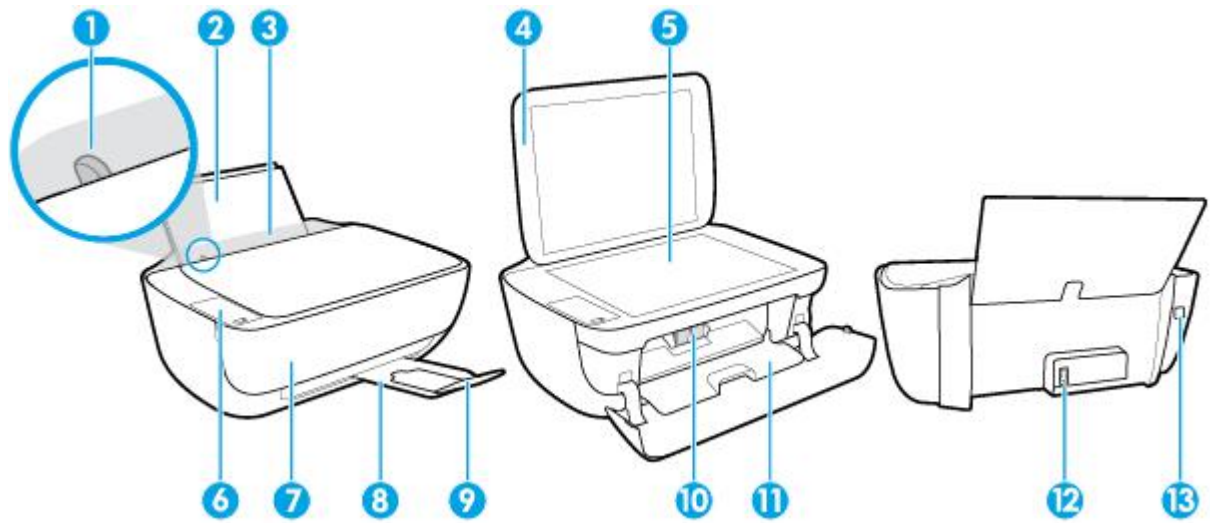

|    |  |
|----|--|
| 1  | Paper-width guide  |
| 2  | Input tray   |
| 3  | Input tray shield  |
| 4  | Scanner lid  |
| 5  | Scanner glass  |
| 6  | Control panel  |
| 7  | Front door   |
| 8  | Output tray  |
| 9  | Output tray extender (also referred to as the tray extender) |
| 10 | Ink cartridges   |
| 11 | Cartridge access door  |
| 12 | Power connection   |
| 13 | USB port   |

# Control panel features

## Overview of buttons and lights

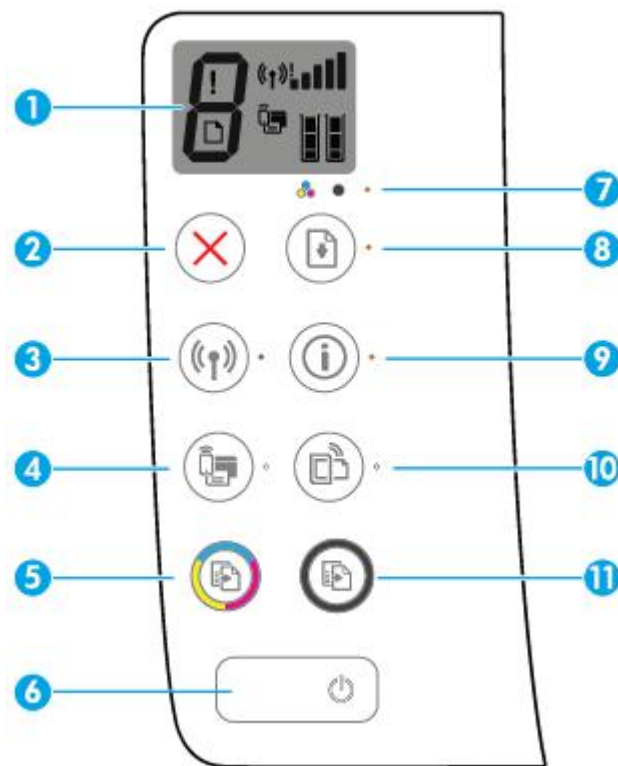



| Feature | Description   |
|---------|---|
| 1       | <b>Control panel display</b> : Indicates number of copies, media errors, wireless status and signal strength, Wi-Fi Direct status, and ink levels.  |
| 2       | <b>Cancel</b> button: Stops the current operation.  |
| 3       | <b>Wireless</b> button: Turns on or off the printer wireless capabilities.<br><b>Wireless</b> light: Indicates whether the printer is connected to a wireless network.  |
| 4       | <b>Wi-Fi Direct</b> button: Turns on or off Wi-Fi Direct.<br><b>Wi-Fi Direct</b> light: Indicates the on or off status of Wi-Fi Direct.   |
| 5       | <b>Start Copy Color</b> button: Starts a color copy job. To increase the number of color copies, press the button multiple times. Copying will start two seconds after the last button press.   |
| 6       | <b>Power</b> button: Turns the printer on or off.   |
| 7       | <b>Ink Alert</b> light: Indicates low ink or ink cartridge problems.  |
| 8       | <b>Resume</b> button: Resumes a job after a disruption (for example, after loading paper or clearing a paper jam).<br><b>Resume</b> light: Indicates the printer is in a warning or error state.  |
| 9       | <b>Information</b> button: Prints out a printer information page. Press the button in combination with the <b>Wireless</b> button, the Wi-Fi Direct button, or the HP ePrint button to get more specific help pages tied to each of those buttons.<br><b>Information</b> light: Indicates that you can press the <b>Information</b> button to get help. |

| Feature | Description  |
|---------|--|
| 10      | <p><b>HP ePrint</b> button: Turns HP ePrint on or off.</p> <p><b>HP ePrint</b> light: Indicates the on or off status of HP ePrint. A blinking light indicates a problem with the connection to Web Services.</p>         |
| 11      | <p><b>Start Copy Black</b> button: Starts a black-and-white copy job. To increase the number of black-and-white copies, press the button multiple times. Copying will start two seconds after the last button press.</p> |

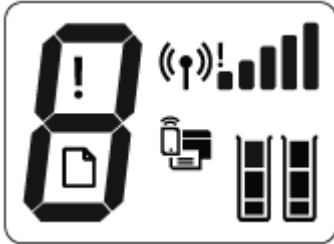
## Control panel display icons



| Icon | Description  |
|------|--|
|      | <b>Number of copies</b> icon: Shows the number of copies when you are copying documents, and alternates between the letter E and a number when the printer is in an error state.   |
|      | <b>Error</b> icon: Indicates an error.   |
|      | <b>Paper Error</b> icon: Indicates a paper-related error.  |
|      | <p><b>Wireless</b> status icons: Show the status of a wireless connection.</p> <p>The wireless status icons consist of three icons, the <b>Wireless</b> icon () , the <b>Wireless Attention</b> icon () , and the <b>Signal Bars</b> icon () .</p>  |
|      | <b>Wi-Fi Direct</b> icon: Indicates Wi-Fi Direct is on or is in the process of being connected.  |
|      | <p><b>Ink Level</b> icons: The left ink icon shows the estimated ink level of the tri-color cartridge, and the right icon shows the estimated ink level of the black cartridge.</p> <p><b>NOTE:</b> Ink level warnings and indicators provide estimates for planning purposes only. When you receive a low-ink warning message, consider having a replacement cartridge available to avoid possible printing delays. You do not need to replace cartridges until the print quality becomes unacceptable.</p> |

# Control panel lights and display icons status

## Power button light







| Status        | Description   |
|---------------|---|
| On            | The printer is on.  |
| Off           | The printer is powered off.   |
| Dimmed        | Indicates the printer is in Sleep mode. The printer automatically enters Sleep mode after 5 minutes of inactivity.  |
| Blinking      | The printer is processing a job. To cancel the job, press the <b>Cancel</b> button (X).   |
| Fast blinking | If the cartridge access door is open, close it. If the cartridge access door is closed and the light is fast blinking, the printer is in an error state that you can resolve by following the on-screen messages from the computer. If you do not see any on-screen messages, try printing a document to generate an on-screen message. |

## Wireless light and icons



- The **Wireless** light next to the **Wireless** button ((P)) and the wireless status icons on the control panel display work together to indicate the status of a wireless connection.

| Status  | Description  |
|---|--|
| The <b>Wireless</b> light, the <b>Wireless</b> icon, and the <b>Signal Bars</b> icon are on.                        | The printer is connected to a wireless network.  |
|   |  |
| The <b>Wireless</b> light is off.   | The wireless capability of the printer is off. To turn on the wireless capability, press the <b>Wireless</b> button ((P)). |
|   |  |
| The <b>Wireless</b> light is blinking, the <b>Wireless</b> icon is on, and the <b>Signal Bars</b> icon are cycling. | The printer is connecting to a wireless network or is in the Wi-Fi Protected Setup (WPS) push mode.                        |
|   |  |
| The <b>Wireless</b> light blinks for three seconds and then turns off.  | The wireless capability of the printer is disabled.  |
|   | Change the wireless settings. For more information, see <a href="#">Wireless settings on page 73</a> .                     |

| Status  | Description   |
|---|---|
| <p>The <b>Wireless</b> light is blinking, and the <b>Wireless</b> icon and <b>Wireless Attention</b> icon are on.</p>              | <p>There is no wireless signal.</p> <ul style="list-style-type: none"> <li>– Make sure your wireless router or access point is powered on.</li> <li>– Move the printer closer to the wireless router.</li> </ul>  |
| <p>The <b>Wireless</b> light is blinking, the <b>Wireless</b> icon is on, and the <b>Wireless Attention</b> icon is blinking.</p>  | <p>One of the following might have occurred.</p> <ul style="list-style-type: none"> <li>– The printer has a problem connecting to the wireless network.</li> <li>– An error occurs or an overlap session is detected when using WPS.</li> </ul> <p>Press the <b>Wireless</b> button () and the <b>Information</b> button () together to run the wireless test, and then review the test report for information on how to solve the problem.</p> |





## Wi-Fi Direct light and icon



| Status  | Description  |
|---|--|
| <p>The <b>Wi-Fi Direct</b> light and icon are on.</p>                                   | <p>Wi-Fi Direct is turned on and ready to use.</p> <p>To learn how to connect to your printer using Wi-Fi Direct, see <a href="#">Connect wirelessly to the printer without a router on page 69</a>.</p>   |
| <p>The <b>Wi-Fi Direct</b> light and icon are off.</p>                                  | <p>Wi-Fi Direct is off.</p> <p>To turn on Wi-Fi Direct, press the <b>Wi-Fi Direct</b> button ()</p>   |
| <p>The <b>Wi-Fi Direct</b> light is blinking.</p>                                       | <p>The printer is connecting to a mobile device in the Wi-Fi Protected Setup (WPS) push mode. Press the <b>Wi-Fi Direct</b> button () to finish connecting.</p> |
| <p>The <b>Wi-Fi Direct</b> light blinks fast for three seconds, and then stays on.</p>  | <p>The printer already has the maximum number of Wi-Fi Direct connection and another device is trying to connect to the printer with Wi-Fi Direct.</p>   |
| <p>The <b>Wi-Fi Direct</b> light blinks fast for three seconds, and then turns off.</p> | <p>Wi-Fi Direct is disabled. For more information, contact the person who set up the printer.</p>  |

## HP ePrint light



| Status   | Description  |
|--|--|
| The <b>HP ePrint</b> light is on.  | The HP ePrint feature is on and ready to use. For information about how to print documents using HP ePrint, see <a href="#">Print with HP ePrint on page 42</a> .  |
| The <b>HP ePrint</b> light is off.                                       | The HP ePrint feature is off.<br><br>To turn on HP ePrint, press the <b>HP ePrint</b> button (  )   |
| The <b>HP ePrint</b> light blinks for three seconds, and then turns off. | One of the following might have occurred. <ul style="list-style-type: none"> <li>– The Web Services have not been setup up.</li> <li>– A mandatory update for the printer is available but has not been installed.</li> <li>– The HP ePrint feature has been disabled.</li> </ul> Press the <b>HP ePrint</b> button (  ) and the <b>Information</b> button (  ) at the same time to print a diagnostic page, and then follow the instructions on the page. |
| The <b>HP ePrint</b> light keeps blinking.                               | The HP ePrint feature is turned on, but the printer is not connected to the Web Services server.<br><br>Press the <b>HP ePrint</b> button (  ) and the <b>Information</b> button (  ) at the same time to print a diagnostic page, and then follow the instructions on the page.  |

### Ink Level icons and Ink Alert light

- One of the **Ink Level** icons is blinking with no segment, and the **Ink Alert** light is on.



| Cause  | Solution   |
|--|--|
| One of the following might have occurred. <ul style="list-style-type: none"> <li>– The corresponding ink cartridge is missing.</li> <li>– The corresponding ink cartridge is installed improperly, or still has plastic tape on it.</li> </ul> | <ul style="list-style-type: none"> <li>– If one of the ink cartridges is missing, the printer enters single-cartridge mode. To exit the single-cartridge mode, insert the corresponding ink cartridge. For more information about the single-cartridge mode, see <a href="#">Use single-cartridge mode on page 61</a>.</li> <li>– If both ink cartridges are installed in the printer, remove the corresponding ink cartridge, make sure there is no plastic tape on it, and then reinsert the ink cartridge securely. For more information, see <a href="#">Replace ink cartridges on page 58</a>.</li> </ul> |

- Both **Ink Level** icons are blinking with no segment, and the **Ink Alert** light is blinking.



| Cause   | Solution   |
|---|--|
| One of the following might have occurred.   | – If there is no ink cartridge installed in the printer, install the ink cartridges.   |
| – Both ink cartridges are missing.  | – If both ink cartridges are installed in the printer, remove the cartridges, make sure there is no plastic tape on them, and then reinsert the ink cartridges securely. |
| – Both ink cartridges are installed improperly, or still have plastic tape on them. | – Make sure that you are using the correct HP ink cartridges for your printer.   |
| – Both ink cartridges are incompatible or damaged.                                  | – If the error persists, replace the ink cartridges. For information about how to replace ink cartridges, see <a href="#">Replace ink cartridges on page 58</a> .        |

- For one of the **Ink Level** icons, only one segment is on.



| Cause  | Solution  |
|--|---|
| The corresponding ink cartridge is low on ink and will need to be replaced soon. | – Continue to print using the remaining ink. The quality of printed documents might be affected.  |
|  | – If the print quality is poor, consider replacing the corresponding ink cartridge. For more information, see <a href="#">Replace ink cartridges on page 58</a> . |

- For both **Ink Level** icons, only one segment is on.



| Cause   | Solution   |
|---|--|
| Both cartridges are low on ink and will need to be replaced soon. | – Continue to print using the remaining ink. The quality of printed documents might be affected.   |
|   | – If the print quality is poor, consider replacing the ink cartridges. For more information, see <a href="#">Replace ink cartridges on page 58</a> . |

- One of the **Ink Level** icons is blinking with no segment, the **Ink Alert** light is on, and the **Resume** light is blinking.



| Cause  | Solution  |
|--|---|
| One of the following might have occurred.                      | – If the corresponding ink cartridge is newly installed, it might be counterfeit or previously used. Refer to the |
| – A counterfeit or previously used ink cartridge is installed. |   |
| – The corresponding ink cartridge is very low on ink.          |   |



| Cause | Solution   |
|-------|--|
|       | <p>message in the HP printer software for more information.</p> <ul style="list-style-type: none"> <li>– If the corresponding ink cartridge is not newly installed, it is very low on ink. Press the <b>Resume</b> button (  ) to continue printing, and replace the ink cartridge when the print quality is no longer acceptable. For information about how to replace ink cartridges, see <a href="#">Replace ink cartridges on page 58</a>.</li> </ul> |

- Both **Ink Level** icons are blinking with no segment, the **Ink Alert** light is on, and the **Resume** light is blinking.



| Cause  | Solution   |
|--|--|
| <p>One of the following might have occurred.</p> <ul style="list-style-type: none"> <li>– The counterfeit or previously used ink cartridges are installed.</li> <li>– Both of the ink cartridges are very low on ink.</li> </ul> | <ul style="list-style-type: none"> <li>– If the ink cartridges are newly installed, they might be counterfeit or previously used. Refer to the message in the HP printer software for more information.</li> <li>– If the ink cartridges are not newly installed, they are very low on ink. Press the <b>Resume</b> button (  ) to continue printing, and replace the ink cartridges when the print quality is no longer acceptable. For information about how to replace ink cartridges, see <a href="#">Replace ink cartridges on page 58</a>.</li> </ul> |

### Error icon, Paper Error icon, and Resume light

- The **Error** icon, the **Paper Error** icon, and the **Resume** light are on.



| Cause                                       | Solution  |
|---|---|
| <p>There is no paper in the input tray.</p> | <p>Load paper in the input tray.</p> <p>For information about how to load paper, see <a href="#">Load media on page 15</a>.</p> |

- The **Error** icon, the **Paper Error** icon, and the **Resume** light are blinking.





| Cause  | Solution  |
|--|---|
| The printer receives a printing job, and detects that there is no paper in the input tray. | Load paper, and then press the <b>Resume</b> button (  ) to continue printing.<br><br>For information about how to load paper, see <a href="#">Load media on page 15</a> . |

### Number of copies icon

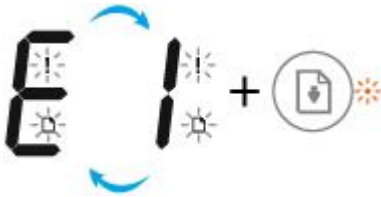
- The **Number of copies** icon is alternating between the letter E and the number 1. At the same time, the **Error** icon, the **Paper Error** icon, and the **Resume** light are blinking.



| Cause  | Solution   |
|--|--|
| The printer receives a printing job, starts feeding paper, and detects that the paper width for the printing job is bigger than the width of the loaded paper. | Press either the <b>Resume</b> button (  ) or the <b>Cancel</b> button (  ) to cancel the printing job and eject paper.<br><br>To avoid the paper size mismatch problem, do one of the following before printing. <ul style="list-style-type: none"> <li>– Change the paper size setting for the printing job to match the paper loaded.</li> <li>– Remove all paper from the input tray, and then load paper that matches the paper size setting for the printing job.</li> </ul> <b>TIP:</b> You can change the default paper size automatically detected by the printer. For more information, see <a href="#">Change the default paper size detected by printer on page 19</a> . |

- The **Number of copies** icon is alternating between the letter E and the number 2. The **Resume** light is off.



| Cause  | Solution   |
|--|--|
| The printer receives a single-page printing job, detects that the paper length for the printing job does not match the length of the loaded paper, and then prints out the page with errors. | <p>To clear the error, press any button on the control panel or wait for two minutes.</p> <p>To avoid the paper length mismatch problem, do one of the following before printing.</p> <ul style="list-style-type: none"> <li>– Change the paper size setting for the printing job to match the paper loaded.</li> <li>– Remove all paper from the input tray, and then load paper that matches the paper size setting for the printing job.</li> </ul> <p><b>TIP:</b> You can change the default paper size automatically detected by the printer. For more information, see <a href="#">Change the default paper size detected by printer on page 19</a>.</p> |

- The **Number of copies** icon is alternating between the letter E and the number 2. At the same time, the **Error** icon, the **Paper Error** icon, and the **Resume** light are blinking.



| Cause  | Solution   |
|--|--|
| The printer receives a multi-page printing job, detects that the paper length for the printing job does not match the length of the loaded paper, and then prints out the first page of the job with errors. | <ul style="list-style-type: none"> <li>– To cancel the printing job, press the <b>Cancel</b> button (✖).</li> <li>– To continue printing the remaining pages, press the <b>Resume</b> button (📄↓). The remaining pages will have the same errors as the first page.</li> </ul> <p><b>TIP:</b> You can change the default paper size automatically detected by the printer. For more information, see <a href="#">Change the default paper size detected by printer on page 19</a>.</p> |

- The **Number of copies** icon is alternating between the letter E and the number 3. At the same time, the **Resume** light and the **Ink Alert** light are blinking.



| Cause  | Solution  |
|--|---|
| The carriage inside the printer has stalled. | <p>Open the cartridge access door and make sure the carriage is not obstructed. Move the carriage to the right, close the cartridge access door, and then press the <b>Resume</b> button (📄↓) to continue printing. See <a href="#">Jams and paper-feed issues on page 80</a> for more information.</p> |

- The **Number of copies** icon is alternating between the letter E and the number 4. At the same time, the **Error** icon, the **Paper Error** icon, the **Resume** light, and the **Ink Alert** light are blinking.



| Cause                 | Solution  |
|-----------------------|---|
| There is a paper jam. | Clear the jam, and then press the <b>Resume</b> button (  ) to continue printing.<br><br>For more information, see <a href="#">Jams and paper-feed issues on page 80</a> . |

- The **Number of copies** icon is alternating between the letter E and the number 5. At the same time, all lights on the control panel are blinking.



| Cause                       | Solution   |
|-----------------------------|--|
| The scanner is not working. | Turn off and turn on the printer.<br><br>If the problem persists, contact HP. The printer still prints even if the scanner is not working. |

- The **Number of copies** icon is alternating between the letter E and the number 6. At the same time, all lights on the control panel are blinking.



| Cause                             | Solution  |
|-----------------------------------|---|
| The printer is in an error state. | Reset the printer. <ol style="list-style-type: none"> <li>1. Turn off the printer.</li> <li>2. Unplug the power cord.</li> <li>3. Wait a minute, and then plug the power cord back in.</li> <li>4. Turn on the printer.</li> </ol> If the problem persists, contact HP. |

## Load media

Select a paper size to continue.

### To load full-size paper

1. Raise the input tray.



2. Slide the paper-width guide to the left.

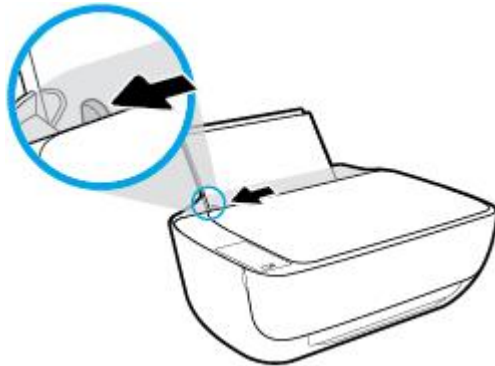

3. Insert a stack of paper into the input tray with the short edge down and the print side up, and slide the stack of paper down until it stops.



4. Slide the paper-width guide to the right until it stops at the edge of the paper.

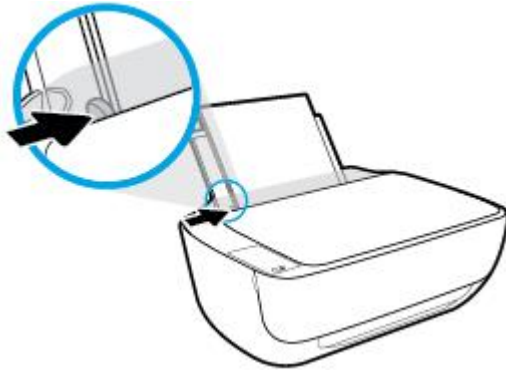

5. Pull out the output tray and the tray extender.



#### To load small-size paper

1. Raise the input tray.



2. Slide the paper-width guide to the left.

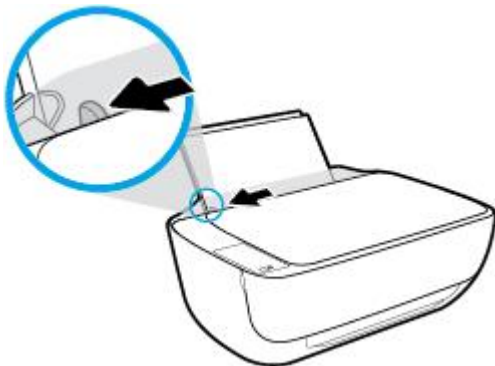

3. Insert a stack of photo paper into the far-right side of the input tray with the short edge down and the print side up, and slide the stack of paper down until it stops.



4. Slide the paper-width guide to the right until it stops at the edge of the paper.

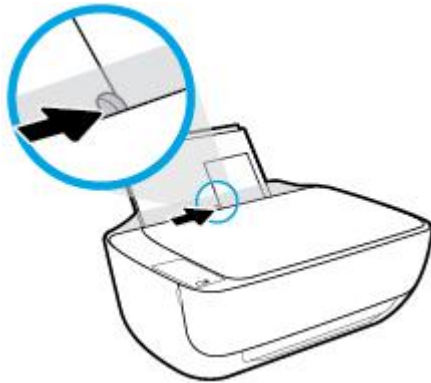

5. Pull out the output tray and the tray extender.



### To load envelopes

1. Raise the input tray.



2. Slide the paper-width guide to the left.

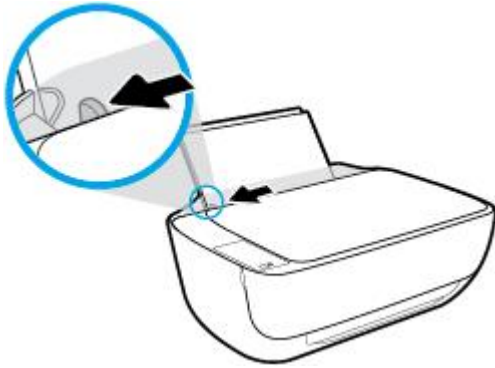

3. Insert one or more envelopes into the far-right side of the input tray and slide the stack of envelopes down until it stops.

The side to be printed on should face up. The flap should be on the left side and facing down.



4. Slide the paper-width guide to the right against the stack of envelopes until it stops.

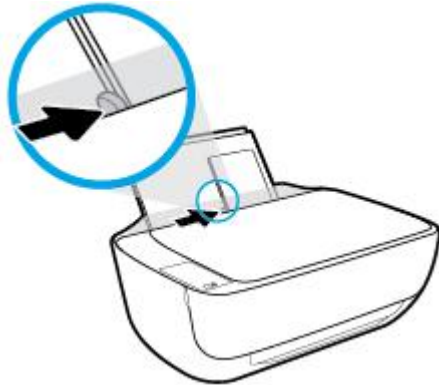

5. Pull out the output tray and the tray extender.





## Change the default paper size detected by printer

The printer can automatically detect whether the input tray has paper loaded and detect whether the loaded paper is large, small, or medium width. You can change the default large, medium, or small paper size detected by the printer.

### To change the default paper size detected by the printer

1. Open the embedded web server (EWS). For more information, see [Open the embedded web server on page 76](#).
2. Click the **Settings** tab.
3. In the **Preferences** section, click **Tray and Paper Management**, and then select the desired option.
4. Click **Apply**.

# Load an original on the scanner glass

To load an original on the scanner glass

1. Lift the scanner lid.

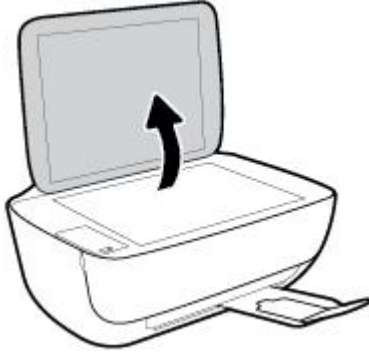

2. Load the original print-side down on the right corner of the scanner glass.

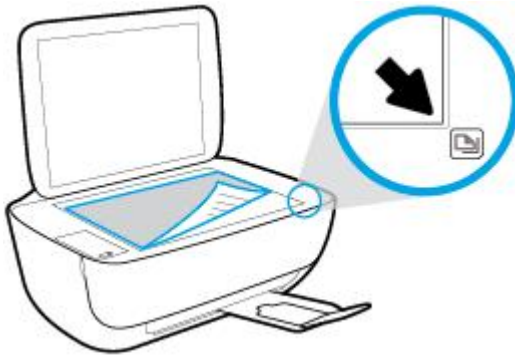

3. Close the scanner lid.

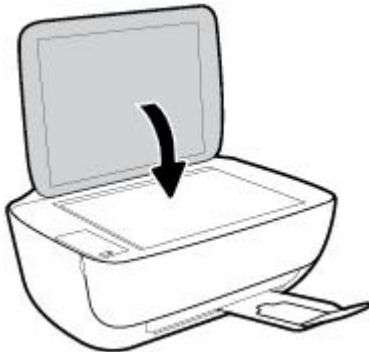

## Paper basics

The printer is designed to work well with most types of office paper. It is best to test a variety of print paper types before buying large quantities. Use HP paper for optimum print quality. Visit the HP website at [www.hp.com](http://www.hp.com) for more information about HP paper.



HP recommends plain papers with the ColorLok logo for printing everyday documents. All papers with the ColorLok logo are independently tested to meet high standards of reliability and print quality, and produce documents with crisp, vivid color, bolder blacks, and that dry faster than ordinary plain papers. Look for papers with the ColorLok logo in a variety of weights and sizes from major paper manufacturers.

This section contains the following topics:

- [Recommended papers for printing](#)
- [Order HP paper supplies](#)

## Recommended papers for printing

If you want the best print quality, HP recommends using HP papers that are specifically designed for the type of project you are printing.

Depending on your country/region, some of these papers might not be available.

### Photo printing

- **HP Premium Plus Photo Paper**

HP Premium Plus Photo Paper is HP's highest-quality photo paper for your best photos. With HP Premium Plus Photo Paper, you can print beautiful photos that are instant-dry so you can share them right off the printer. It is available in several sizes, including A4, 8.5 x 11 inches, 4 x 6 inches (10 x 15 cm), 5 x 7 inches (13 x 18 cm), and in two finishes - glossy or soft gloss (semi-gloss). Ideal for framing, displaying, or gifting your best photos and special photo projects. HP Premium Plus Photo Paper delivers exceptional results with professional quality and durability.

- **HP Advanced Photo Paper**

This glossy photo paper features an instant-dry finish for easy handling without smudging. It resists water, smears, fingerprints, and humidity. Your prints have a look and feel comparable to a store-processed photo. It is available in several sizes, including A4, 8.5 x 11 inches, 10 x 15 cm (4 x 6 inches), 13 x 18 cm (5 x 7 inches). It is acid-free for longer lasting documents.

- **HP Everyday Photo Paper**

Print colorful, everyday snapshots at a low cost, using paper designed for casual photo printing. This affordable photo paper dries quickly for easy handling. Get sharp, crisp images when you use this paper with any inkjet printer. It is available in glossy finish in several sizes, including A4, 8.5 x 11 inches, 5 x 7 inches, and 4 x 6 inches (10 x 15 cm). It is acid-free for longer lasting documents.

- **HP Photo Value Packs**

HP Photo Value Packs conveniently package original HP ink cartridges and HP Advanced Photo Paper to save you time and take the guesswork out of printing affordable, lab-quality photos with your HP

printer. Original HP inks and HP Advanced Photo Paper have been designed to work together so your photos are long lasting and vivid, print after print. Great for printing out an entire vacation's worth of photos or multiple prints to share.

### Business documents

- **HP Premium Presentation Paper 120g Matte or HP Professional Paper 120 Matt**

This paper is a heavy two-sided matte paper perfect for presentation, proposals, reports, and newsletters. It is heavyweight for an impressive look and feel.

- **HP Brochure Paper 180g Glossy or HP Professional Paper 180 Glossy**

These papers are glossy-coated on both sides for two-sided use. They are the perfect choice for near-photographic reproductions and business graphics for report covers, special presentations, brochures, mailers, and calendars.

- **HP Brochure Paper 180g Matte or HP Professional Paper 180 Matte**

These papers are matte-coated on both sides for two-sided use. They are the perfect choice for near-photographic reproductions and business graphics for report covers, special presentations, brochures, mailers, and calendars.

### Everyday printing

All the papers listed for everyday printing feature ColorLok Technology for less smearing, bolder blacks, and vivid colors.

- **HP Bright White Inkjet Paper**

HP Bright White Inkjet Paper delivers high-contrast colors and sharp text. It is opaque enough for two-sided color usage with no show-through, which makes it ideal for newsletters, reports, and flyers.

- **HP Printing Paper**

HP Printing Paper is a high-quality multifunction paper. It produces documents that look and feel more substantial than documents printed on standard multipurpose or copy paper. It is acid-free for longer lasting documents.

- **HP Office Paper**

HP Office Paper is a high-quality multifunction paper. It is suitable for copies, drafts, memos, and other everyday documents. It is acid-free for longer lasting documents.

- **HP Office Recycled Paper**

HP Office Recycled Paper is a high-quality multifunction paper made with 30% recycled fiber.

## Order HP paper supplies

The printer is designed to work well with most types of office paper. Use HP paper for optimum print quality.

To order HP papers and other supplies, go to [www.hp.com](http://www.hp.com). At this time, some portions of the HP website are available in English only.

HP recommends plain papers with the ColorLok logo for printing and copying of everyday documents. All papers with the ColorLok logo are independently tested to meet high standards of reliability and print quality, and produce documents with crisp, vivid color, bolder blacks and shorter dry-time than ordinary plain papers. Look for papers with the ColorLok logo in a variety of weights and sizes from major paper manufacturers.

## Open the HP printer software (Windows)

After installing the HP printer software, double-click the printer icon on the desktop or do one of the following to open the printer software:

- **Windows 8.1:** Click the down arrow in lower left corner of the Start screen, and then select the printer name.
- **Windows 8:** Right-click an empty area on the Start screen, click **All Apps** on the app bar, and then select the printer name.
- **Windows 7, Windows Vista, and Windows XP:** From the computer desktop, click **Start**, select **All Programs**, click **HP**, click the folder for the printer, and then select the icon with the printer's name.

## Sleep mode

- Power usage is reduced while in Sleep mode.
- After initial setup of printer, the printer will enter Sleep mode after 5 minutes of inactivity.
- The **Power** button light is dimmed and the printer control panel display is off in Sleep mode.

To change the time to Sleep mode

1. Open the embedded web server (EWS). For more information, see [Open the embedded web server on page 76](#).
2. Click the **Settings** tab.
3. In the **Power Management** section, click **Energy Save Mode**, and select the desired option.
4. Click **Apply**.

# Quiet Mode

Quiet Mode slows down printing to reduce overall noise without affecting print quality. Quiet Mode only works for printing with **Normal** print quality on plain paper. To reduce printing noise, turn on Quiet Mode. To print at normal speed, turn Quiet Mode off. Quiet Mode is off by default.



**NOTE:** In Quiet Mode, if you print on plain paper with the **Draft** or **Best** print quality, or if you print photos or envelopes, the printer works in the same way as when Quiet Mode is off.

## To turn Quiet Mode on or off from the printer software (Windows)

1. Open the HP printer software. For more information, see [Open the HP printer software \(Windows\) on page 23](#).
2. Click the **Quiet Mode** tab.
3. Click **On** or **Off**.
4. Click **Save Settings**.

## To turn Quiet Mode on or off from the Embedded Web Server (EWS)

1. Open the EWS. For more information, see [Open the embedded web server on page 76](#).
2. Click the **Settings** tab.
3. In the **Preferences** section, select **Quiet Mode**, and then select **On** or **Off**.
4. Click **Apply**.

## Auto-Off

This feature turns the printer off after 2 hours of inactivity to help reduce energy use. **Auto-Off turns the printer off completely, so you must use the Power button to turn the printer back on.** If your printer supports this energy saving feature, Auto-Off is automatically enabled or disabled depending on printer capabilities and connection options. Even when Auto-Off is disabled, the printer enters Sleep mode after 5 minutes of inactivity to help reduce energy use.

- Auto-Off is enabled when the printer is turned on, if the printer does not have network or fax capability, or is not using these capabilities.
- Auto-Off is disabled when a printer's wireless or Wi-Fi Direct capability is turned on or when a printer with fax, USB, or Ethernet network capability establishes a fax, USB, or Ethernet network connection.



---

## 3 Print

- [Print from your computer](#)
- [Print from your mobile device](#)
- [Print with AirPrint](#)
- [Tips for print success](#)

# Print from your computer

- [Print documents](#)
- [Print photos](#)
- [Print envelopes](#)
- [Print using the maximum dpi](#)

## Print documents

Before printing documents, make sure you have paper loaded in the input tray and the output tray is open. For more information about loading paper, see [Load media on page 15](#).

### To print a document (Windows)

1. From your software, select **Print**.
2. Make sure your printer is selected.
3. Click the button that opens the **Properties** dialog box.

Depending on your software application, this button might be called **Properties**, **Options**, **Printer Setup**, **Printer Properties**, **Printer**, or **Preferences**.

4. Select the appropriate options.
  - On the **Layout** tab, select **Portrait** or **Landscape** orientation.
  - On the **Paper/Quality** tab, select the appropriate paper type from the **Media** drop-down list in the **Tray Selection** area, select the appropriate print quality in the **Quality Settings** area, and then select the appropriate color in the **Color** area.
  - Click **Advanced** to select the appropriate paper size from the **Paper Size** drop-down list.
5. Click **OK** to close the **Properties** dialog box.
6. Click **Print** or **OK** to begin printing.

### To print documents (OS X)

1. From the **File** menu in your software, choose **Print**.
2. Make sure your printer is selected.
3. Specify the page properties.

If you do not see options on the Print dialog, click **Show Details**.



**NOTE:** The following options are available for a USB connected printer. Locations for the options can vary from one application to another.

- Choose the paper size.



---

**NOTE:** If you change the **Paper Size** ensure that you have loaded the correct paper.

---

- Select the orientation.
  - Enter the scaling percentage.
4. Click **Print**.

#### To print on both sides of the page (Windows)

1. From your software, select **Print**.
2. Make sure your printer is selected.
3. Click the button that opens the **Properties** dialog box.

Depending on your software application, this button might be called **Properties, Options, Printer Setup, Printer Properties, Printer, or Preferences**.

4. Select the appropriate options.
  - On the **Layout** tab, select **Portrait** or **Landscape** orientation.
  - On the **Paper/Quality** tab, select the appropriate paper type from the **Media** drop-down list in the **Tray Selection** area, select the appropriate print quality in the **Quality Settings** area, and then select the appropriate color in the **Color** area.
  - Click **Advanced** to select the appropriate paper size from the **Paper Size** drop-down list.
5. On the **Layout** tab, select an appropriate option from the **Print on Both Sides Manually** drop-down list.
6. After you print the first side, follow the on-screen instructions to reload the paper with the blank side up and top of the page down, and then click **Continue**.
7. Click **OK** to print.

#### To print on both sides of the page (OS X)

1. From the **File** menu in your software, choose **Print**.
2. In the Print dialog, choose **Paper Handling** from the pop-up menu and set **Page Order** to **Normal**.
3. Set **Pages to Print** to **Odd only**.
4. Click **Print**.
5. After all of the odd numbered pages have printed, remove the document from the output tray.
6. Reload the document so that the end that came out of the printer is now going into the printer and the blank side of the document is facing toward the front of the printer.
7. In the Print dialog, return to the **Paper Handling** pop-up menu and set the page order to **Normal** and the pages to print to **Even Only**.
8. Click **Print**.

## Print photos

Before printing photos, make sure you have photo paper loaded in the input tray and the output tray is open. For more information about loading paper, see [Load media on page 15](#).

### To print a photo on photo paper (Windows)

1. From your software, select **Print**.
2. Make sure your printer is selected.
3. Click the button that opens the **Properties** dialog box.

Depending on your software application, this button might be called **Properties**, **Options**, **Printer Setup**, **Printer Properties**, **Printer**, or **Preferences**.

4. Select the appropriate options.
  - On the **Layout** tab, select **Portrait** or **Landscape** orientation.
  - On the **Paper/Quality** tab, select the appropriate paper type from the **Media** drop-down list in the **Tray Selection** area, select the appropriate print quality in the **Quality Settings** area, and then select the appropriate color in the **Color** area.
  - Click **Advanced** to select the appropriate photo size from the **Paper Size** drop-down list.
5. Click **OK** to return to the **Properties** dialog box.
6. Click **OK**, and then click **Print** or **OK** in the **Print** dialog box.



**NOTE:** After the printing is finished, remove unused photo paper from the input tray. Store the photo paper so it does not start to curl, which could reduce the quality of your printout.

### To print a photo from the computer (OS X)

1. From the **File** menu in your software, choose **Print**.
2. Make sure your printer is selected.
3. Set the print options.

If you do not see options on the Print dialog, click **Show Details**.



**NOTE:** The following options are available for a USB connected printer. Locations for the options can vary from one application to another.

- a. Choose the appropriate paper size in the **Paper Size** pop-up menu.



**NOTE:** If you change the **Paper Size** ensure that you have loaded the correct paper.

- b. Select an **Orientation**.
- c. From the pop-up menu, choose **Paper Type/Quality**, and then choose the following settings:
  - **Paper Type:** The appropriate photo paper type
  - **Quality:** **Best** or **Maximum dpi**
  - Click the **Color Options** disclosure triangle, and then choose the appropriate **Photo Fix** option.

- **Off:** applies no changes to the image.
  - **Basic:** automatically focuses the image; moderately adjusts image sharpness.
4. Select any other print settings you want, and then click **Print**.

## Print envelopes

Before printing envelopes, make sure you have envelopes loaded in the input tray and the output tray is open. You can load one or more envelopes into the input tray. Do not use shiny or embossed envelopes or envelopes that have clasps or windows. For more information about loading envelopes, see [Load media on page 15](#).

---

 **NOTE:** For specific details on how to format text for printing on envelopes, consult the help files in your word application.

---

### To print an envelope (Windows)

1. From your software, select **Print**.
2. Make sure your printer is selected.
3. Click the button that opens the **Properties** dialog box.

Depending on your software application, this button might be called **Properties**, **Options**, **Printer Setup**, **Printer Properties**, **Printer**, or **Preferences**.

4. Select the appropriate options.
  - On the **Layout** tab, select **Portrait** or **Landscape** orientation.
  - On the **Paper/Quality** tab, select the appropriate paper type from the **Media** drop-down list in the **Tray Selection** area, select the appropriate print quality in the **Quality Settings** area, and then select the appropriate color in the **Color** area.
  - Click **Advanced** to select the appropriate envelope size from the **Paper Size** drop-down list.
5. Click **OK**, and then click **Print** or **OK** in the **Print** dialog box.

### To print envelopes (OS X)

1. From the **File** menu in your software, choose **Print**.
2. Make sure your printer is selected.
3. Set the print options.

If you do not see options on the Print dialog, click **Show Details**.

---

 **NOTE:** The following options are available for a USB connected printer. Locations for the options can vary from one application to another.

---

- a. Select the appropriate envelope size from the **Paper Size** pop-up menu.

---

 **NOTE:** If you change the **Paper Size** ensure that you have loaded the correct paper.

---

- b. From the pop-up menu, choose **Paper Type/Quality**, and verify the paper type setting is set to **Plain Paper**.
4. Click **Print**.

## Print using the maximum dpi

Use maximum dots per inch (dpi) to print high-quality, sharp images on photo paper.

Printing in maximum dpi takes longer than printing with other settings and requires a large amount of disk space.

For a list of supported print resolutions, visit the [HP DeskJet 3630 series support website at www.hp.com/support](http://www.hp.com/support).

### To print in maximum dpi mode (Windows)

1. From your software, select **Print**.
2. Make sure your printer is selected.
3. Click the button that opens the **Properties** dialog box.

Depending on your software application, this button might be called **Properties**, **Options**, **Printer Setup**, **Printer Properties**, **Printer**, or **Preferences**.

4. Click the **Paper/Quality** tab.
5. From the **Media** drop-down list, select an appropriate paper type.
6. Click the **Advanced** button.
7. In the **Printer Features** area, select **Yes** from the **Print in Max DPI** drop-down list.
8. Select the appropriate paper size from the **Paper Size** drop-down list.
9. Click **OK** to close the advanced options.
10. Confirm **Orientation** on the **Layout** tab, and then click **OK** to print.

### To print using maximum dpi (OS X)

1. From the **File** menu in your software, choose **Print**.
2. Make sure your printer is selected.
3. Set the print options.

If you do not see options on the Print dialog, click **Show Details**.

---

 **NOTE:** The following options are available for a USB connected printer. Locations for the options can vary from one application to another.

---

- a. Choose the appropriate paper size in the **Paper Size** pop-up menu.

---

 **NOTE:** If you change the **Paper Size** ensure that you have loaded the correct paper.

---

- b. From the pop-up menu, choose **Paper Type/Quality**, and then choose the following settings:
  - **Paper Type:** The appropriate paper type
  - **Quality: Maximum dpi**
4. Select any other print settings that you want, and then click **Print**.

## Print from your mobile device

With HP mobile printing technology, you can print from your smartphone or tablet to your printer easily.

If you are at home or office, to use the printing capabilities already on your smartphone or tablet to print:

1. Make sure your mobile device and printer are on the same network.
2. Select the photo or document you want to print and choose your printer.
3. Confirm print settings and print.

If you want to print without accessing the network, see [Connect wirelessly to the printer without a router on page 69](#) for more information.

If you are on the road, you can print a document by sending an email with the HP ePrint app to your HP ePrint enabled printer. See [Print with HP ePrint on page 42](#) for more information.

For more information, visit the HP Mobile Printing website ( [www.hp.com/go/mobileprinting](http://www.hp.com/go/mobileprinting) ).

## Print with AirPrint

Printing using Apple's AirPrint is supported for iPad (iOS 4.2), iPhone (3GS or later), iPod touch (third generation or later), and Mac (OS X 10.7 or later).

To use AirPrint, ensure the following:

- The printer and the Apple device must be connected to the same network as your AirPrint enabled device. For more information about using AirPrint and about which HP products are compatible with AirPrint, go to [www.hp.com/go/mobileprinting](http://www.hp.com/go/mobileprinting).
- Load paper that matches the paper settings of the printer.

---

 **TIP:** You can change the default paper size automatically detected by the printer. For more information, see [Change the default paper size detected by printer on page 19](#).

---



## Tips for print success

To print successfully, the HP ink cartridges should be functioning properly with sufficient ink, the paper should be loaded correctly, and the printer should have the appropriate settings.

Print settings do not apply to copying or scanning.

### Ink tips

- Use original HP ink cartridges.
- Install both the black and tri-color cartridges correctly.  
For more information, see [Replace ink cartridges on page 58](#).
- Check the estimated ink levels in the ink cartridges to make sure there is sufficient ink.  
For more information, see [Check estimated ink levels on page 56](#).
- If the print quality is not acceptable, see [Printing issues on page 88](#) for more information.

### Paper loading tips

- Load a stack of paper (not just one page). All of the paper in the stack should be in the same size and type to avoid a paper jam.
- Load the paper with side to be printed on facing up.
- Ensure that paper loaded in the input tray lays flat, and the edges are not bent or torn.
- Adjust the paper-width guide in the input tray to fit snugly against all paper. Make sure the paper-width guide does not bend the paper in the input tray.  
For more information, see [Load media on page 15](#).

### Printer settings tips (Windows)

- To change default print settings, open the HP printer software, click **Print & Scan**, and then click **Set Preferences**. For information how to open the printer software, see [Open the HP printer software \(Windows\) on page 23](#).
  - To select the number of pages to print per sheet, on the **Layout** tab, select the appropriate option from the **Pages per Sheet** drop-down list.
  - To view more printing settings, on the **Layout** or **Paper/Quality** tab, click the **Advanced** button to open the **Advanced Options** dialog box.
    - **Print in Grayscale:** Allows you to print a black and white document using the black ink only. Select **Black Ink Only**, and then click **OK**. It also allows you to print a high quality black and white image. Select **High Quality Grayscale**, and then click **OK**.
    - **Pages per Sheet Layout:** Helps you specify the order of the pages if you print the document with more than two pages per sheet.
- 
-  **NOTE:** The preview on the **Layout** tab cannot reflect what you select from the **Pages per Sheet Layout** drop-down list.
- 
- **HP Real Life Technologies:** This feature smooths and sharpens images and graphics for improved print quality.

- **Booklet:** Allows you to print a multiple-page document as a booklet. It places two pages on each side of a sheet that can then be folded into a booklet in half size of the paper. Select a binding method from the drop-down list, and then click **OK**.
  - **Booklet-LeftBinding:** The binding side after folded into a booklet appears at the left side. Select the option if your reading habit is from left to right.
  - **Booklet-RightBinding:** The binding side after folded into a booklet appears at the right side. Select the option if your reading habit is from right to left.



---

**NOTE:** The preview on the **Layout** tab cannot reflect what you select from the **Booklet** drop-down list.

---

- **Pages to Print:** Allows you to print the odd pages only, print the even pages only, or print all pages.
- **Borderless Printing:** Select this feature to print photos without border. Not all paper types support this feature. You will see an alert icon beside the option if the selected paper type in the **Media** drop-down list does not support it.
- **Page Borders:** Allows you to add borders to the pages if you print the document with two or more pages per sheet.



---

**NOTE:** The preview on the **Layout** tab cannot reflect what you select from the **Page Borders** drop-down list.

---

- You can use printing shortcut to save time setting printing preferences. A printing shortcut stores the setting values that are appropriate for a particular kind of job, so that you can set all the options with a single click. To use it, go to the **Printing Shortcut** tab, select one printing shortcut, and then click **OK**.

To add a new printing shortcut, after making settings on the **Layout** or **Paper/Quality** tab, click the **Printing Shortcut** tab, click **Save As** and enter a name, and then click **OK**.

To delete a printing shortcut, select it, and then click **Delete**.



---

**NOTE:** You cannot delete the default printing shortcuts.

---

### Printer settings tips (OS X)

- On the Print dialog, use the **Paper Size** pop-up menu to select the size of paper loaded in the printer.
- On the Print dialog, choose the **Paper Type/Quality** pop-up menu and select the appropriate paper type and quality.
- To print a black and white document using only black ink, choose the **Paper Type/Quality** from the pop-up menu and choose **Grayscale** from the Color pop-up menu.

## Notes

- Original HP ink cartridges are designed and tested with HP printers and papers to help you easily produce great results, time after time.



---

**NOTE:** HP cannot guarantee the quality or reliability of non-HP supplies. Product service or repairs required as a result of using a non-HP supply will not be covered under warranty.

If you believe the purchased original HP ink cartridges, go to:

[www.hp.com/go/anticounterfeit](http://www.hp.com/go/anticounterfeit)

---

- Ink level warnings and indicators provide estimates for planning purposes only.



---

**NOTE:** When you receive a low-ink warning message, consider having a replacement ink cartridge available to avoid possible printing delays. You do not need to replace the ink cartridges until the print quality becomes unacceptable.

---

- You can print your document on both sides of the paper manually.



---

# 4 Use Web Services

- [What are Web Services?](#)
- [Set up Web Services](#)
- [Print with HP ePrint](#)
- [Use HP Printables](#)
- [Use the HP Connected website](#)
- [Remove Web Services](#)
- [Tips for using Web Services](#)

# What are Web Services?

## HP ePrint

- HP ePrint is a free service from HP that allows you to print to your HP ePrint-enabled printer anytime, from any location. It's as simple as sending an email to the email address assigned to your printer when you enable Web Services on the printer. No special drivers or software are needed. If you can send an email, you can print from anywhere, using HP ePrint.

Once you have signed up for an account on HP Connected ( [www.hpconnected.com](http://www.hpconnected.com) ), you can sign in to view your HP ePrint job status, manage your HP ePrint printer queue, control who can use your printer's HP ePrint email address to print, and get help for HP ePrint.

## HP Printables

- HP Printables allow you to easily locate and print preformatted web content, directly from your printer. You can also scan and store your documents digitally on the Web.

HP Printables provide a wide range of content, from store coupons to family activities, news, travel, sports, cooking, photos, and many more. You can even view and print your online images from popular photo sites.

Certain HP Printables also allow you to schedule the delivery of app content to your printer.

Preformatted content designed specifically for your printer means no cut-off text and pictures and no extra pages with only one line of text. On some printers, you can also choose paper and print quality settings on the print preview screen.

# Set up Web Services

Before you set up Web Services, make sure your printer is connected to the Internet using a wireless connection.

## To set up Web Services

1. Open the embedded web server (EWS). For more information, see [Open the embedded web server on page 76](#).
2. Click the **Web Services** tab.
3. In the **Web Services Settings** section, click **Setup**, click **Continue**, and follow the on-screen instructions to accept the terms of use.
4. If prompted, choose to allow the printer to check for and install printer updates.



**NOTE:** If a printer update is available, the printer downloads and installs the update, and then restarts. Repeat the instructions from step 1 to set up Web Services.



**NOTE:** If prompted for proxy settings and if your network uses proxy settings, follow the on-screen instructions to set up a proxy server. If you do not have the proxy details, contact your network administrator or the person who set up the network.

---

5. When the printer is connected to the server, the printer prints an information page. Follow the instructions on the information page to finish the setup.

# Print with HP ePrint



HP HP ePrint allows you to print to your HP ePrint-enabled printer anytime, from any location.

Before you can use HP ePrint, make sure the printer is connected to an active network providing Internet access.

## To print a document using HP ePrint

1. Make sure you have set up Web Services.

For more information, see [Set up Web Services on page 41](#).

2. Press the **HP ePrint** button () and the **Information** button () at the same time to print an information page, and then find the email address for your printer from the page.
3. Email your document to the printer.

- a. On your computer or mobile device, open your email application.

---

 **NOTE:** For information about using the email application on your computer or mobile device, see the documentation provided with the application.

---

- b. Create a new email and attach the document to print.

- c. Send the email to the printer email address.

The printer prints the attached document.

---

 **NOTE:** Enter only the HP ePrint email address in the "To" field. Do not enter any additional email addresses in the other fields. The HP ePrint server does not accept email print jobs if there are multiple addresses in the "To" field or any address in the "Cc" field."

 **NOTE:** The email will be printed once it is received. As with any email, there is no guarantee when or whether it will be received. You can check the print status on HP Connected ([www.hpconnected.com](http://www.hpconnected.com)).

 **NOTE:** Documents printed with HP ePrint may appear different from the original. Style, formatting, and text flow may differ from the original document. For documents that need to be printed with a higher quality (such as legal documents), we recommend that you print from the software application on your computer, where you will have more control over what your printout looks like.

---

## To turn off HP ePrint

- ▲ From the printer control panel, press the **HP ePrint** button ()

---

 **NOTE:** To remove all Web Services, see [Remove Web Services on page 45](#).

---

 [Click here to go online for more information.](#)



## Use HP Printables

Print pages from the web, without using a computer, by setting up HP Printables, a free service from HP. You can print coloring pages, calendars, puzzles, recipes, maps, and more, depending on the apps available in your country/region.

Go to the HP Connected website for more information and specific terms and conditions:  
[www.hpconnected.com](http://www.hpconnected.com).

## Use the HP Connected website

Use HP's free HP Connected website to set up increased security for HP ePrint, and specify the email addresses that are allowed to send email to your printer. You can also get product updates, more apps, and other free services.

Go to the HP Connected website for more information and specific terms and conditions:

[www.hpconnected.com](http://www.hpconnected.com) .

## Remove Web Services

To remove Web Services, complete the following steps:

1. Open the embedded web server (EWS). For more information, see [Open the embedded web server on page 76](#).
2. Click the **Web Services** tab, and then click **Remove Web Services** in the **Web Services Settings** section.
3. Click **Remove Web Services**.
4. Click **Yes** to remove Web Services from your printer.

## Tips for using Web Services

- Learn how to share your photos online and order prints. [Click here to go online for more information.](#)
- Learn about apps for printing recipes, coupons, and other content from the web, simply and easily. [Click here to go online for more information.](#)

---

# 5 Copy and scan

- [Copy documents](#)
- [Scan using the HP printer software](#)
- [Scan using Webscan](#)
- [Tips for copy and scan success](#)

# Copy documents



**NOTE:** All documents are copied in normal quality print mode. You cannot change the print mode quality when copying.

---



## To copy documents

1. Load paper in the input tray.

For information about how to load paper, see [Load media on page 15](#).

2. Load the original print side down on the right front corner of the scanner glass.

For more information, see [Load an original on the scanner glass on page 20](#).

3. Press either the **Start Copy Black** button () or the **Start Copy Color** button () to make a copy.

Copying will start two seconds after the last button press.



**TIP:** You can increase the number of copies by pressing the button multiple times.

---

# Scan using the HP printer software

- [Scan to a computer](#)
- [Create a new scan shortcut \(Windows\)](#)
- [Change scan settings \(Windows\)](#)

## Scan to a computer

Before scanning to a computer, make sure you have already installed the HP recommended printer software. The printer and computer must be connected and turned on.

### To scan a document or photo to a file (Windows)

1. Load the original print side down on the right front corner of the scanner glass.
2. Double-click the printer icon on the desktop or do one of the following to open the printer software:
  - **Windows 8.1:** Click the down arrow in lower left corner of the Start screen, and then select the printer name.
  - **Windows 8:** Right-click an empty area on the Start screen, click **All Apps** on the app bar, and then select the printer name.
  - **Windows 7, Windows Vista, and Windows XP:** From the computer desktop, click **Start**, select **All Programs**, click **HP**, click the folder for the printer, and then select the icon with the printer's name.
3. In the printer software, click **Scan a Document or Photo**.
4. Select the type of scan you want and then click **Scan**.
  - Choose **Save as PDF** to save the document (or photo) as a PDF file.
  - Choose **Save as JPEG** to save the photo (or document) as an image file.



**NOTE:** Click the **More** link at the top right corner of the Scan dialog to review and modify settings for any scan.

For more information, see [Change scan settings \(Windows\) on page 51](#).

If **Show Viewer After Scan** is selected, you can make adjustments to the scanned image in the preview screen.

### To scan a document or photo to email (Windows)

1. Load the original print side down on the right front corner of the scanner glass.
2. Double-click the printer icon on the desktop or do one of the following to open the printer software:
  - **Windows 8.1:** Click the down arrow in lower left corner of the Start screen, and then select the printer name.
  - **Windows 8:** Right-click an empty area on the Start screen, click **All Apps** on the app bar, and then select the printer name.
  - **Windows 7, Windows Vista, and Windows XP:** From the computer desktop, click **Start**, select **All Programs**, click **HP**, click the folder for the printer, and then select the icon with the printer's name.

3. In the printer software, click **Scan a Document or Photo** .
4. Select the type of scan you want and then click **Scan** .

Choose **Email as PDF** or **Email as JPEG** to open your email software with the scanned file as an attachment.



**NOTE:** Click the **More** link at the top right corner of the Scan dialog to review and modify settings for any scan.

For more information, see [Change scan settings \(Windows\) on page 51](#).

If **Show Viewer After Scan** is selected, you can make adjustments to the scanned image in the preview screen.

### To scan an original from HP printer software (OS X)

1. Open HP Scan.  
HP Scan is located in the **Applications/Hewlett-Packard** folder at the top level of the hard disk.
2. Click **Scan** .
3. Choose the type of scan profile you want and follow the on-screen instructions.

### Create a new scan shortcut (Windows)

You can create your own scan shortcut to make scanning easier. For example, you might want to regularly scan and save photos in PNG format, rather than JPEG.

1. Load the original print side down on the right front corner of the scanner glass.
2. Double-click the printer icon on the desktop or do one of the following to open the printer software:
  - **Windows 8.1:** Click the down arrow in lower left corner of the Start screen, and then select the printer name.
  - **Windows 8:** Right-click an empty area on the Start screen, click **All Apps** on the app bar, and then select the printer name.
  - **Windows 7, Windows Vista, and Windows XP:** From the computer desktop, click **Start**, select **All Programs**, click **HP**, click the folder for the printer, and then select the icon with the printer's name.
3. In the printer software, click **Scan a Document or Photo** .
4. Click **Create New Scan Shortcut** .
5. Enter a descriptive name, choose an existing shortcut on which to base your new shortcut, and then click **Create** .

For example, if you are creating a new shortcut for photos, choose either **Save as JPEG** or **Email as JPEG** . This makes available the options for working with graphics when scanning.

6. Change the settings for your new shortcut to meet your needs, and then click the save icon to the right of the shortcut.





**NOTE:** Click the **More** link at the top right corner of the Scan dialog to review and modify settings for any scan.

For more information, see [Change scan settings \(Windows\) on page 51](#).

## Change scan settings (Windows)

You can modify any of the scan settings either for a singular use or save the changes to use permanently. These settings include options such as page size and orientation, scan resolution, contrast, and the folder location for saved scans.

1. Load the original print side down on the right front corner of the scanner glass.
2. Double-click the printer icon on the desktop or do one of the following to open the printer software:
  - **Windows 8.1:** Click the down arrow in lower left corner of the Start screen, and then select the printer name.
  - **Windows 8:** Right-click an empty area on the Start screen, click **All Apps** on the app bar, and then select the printer name.
  - **Windows 7, Windows Vista, and Windows XP:** From the computer desktop, click **Start**, select **All Programs**, click **HP**, click the folder for the printer, and then select the icon with the printer's name.

3. In the printer software, click **Scan a Document or Photo**.

4. Click the **More** link in the top right corner of the HP Scan dialog.

The detailed settings pane appears on the right. The left column summarizes the current settings for each section. The right column allows you to change the settings in the highlighted section.

5. Click each section at the left of the detailed settings pane to review the settings in that section.

You can review and change most settings using drop-down menus.

Some settings allow greater flexibility by displaying a new pane. These are indicated by a + (plus sign) at the right of the setting. You must either accept or cancel any changes on this pane to return to the detailed settings pane.

6. When you have finished changing settings, do one of the following.
  - Click **Scan**. You are prompted to save or reject the changes to the shortcut after the scan is finished.
  - Click the save icon to the right of the shortcut, and then click **Scan**.

[Go online to learn more about using the HP Scan software](#). Learn how to:

- customize scan settings, such as image file type, scan resolution, and contrast levels.
- scan to network folders and cloud drives.
- preview and adjust images before scanning.

## Scan using Webscan

Webscan is a feature of the embedded web server that lets you scan photos and documents from your printer to your computer using a web browser.

This feature is available even if you did not install the printer software on your computer.



---

**NOTE:** By default, Webscan is off. You can enable this feature from the EWS.

If you are unable to open Webscan in the EWS, your network administrator might have turned it off. For more information, contact your network administrator or the person who set up your network.

---

### To enable Webscan

1. Open the embedded web server. For more information, see [Open the embedded web server on page 76](#).
2. Click the **Settings** tab.
3. In the **Security** section, click **Administrator Settings**.
4. Select **Webscan** to enable Webscan.
5. Click **Apply**.

### To scan using Webscan

Scanning using Webscan offers basic scan options. For additional scan options or functionality, scan from the HP printer software.

1. Load the original print side down on the right front corner of the scanner glass.  
For more information, see [Load an original on the scanner glass on page 20](#).
2. Open the embedded web server. For more information, see [Open the embedded web server on page 76](#).
3. Click the **Scan** tab.
4. Click **Webscan** in the left pane, change any settings, and then click **Start Scan**.

## Tips for copy and scan success

Use the following tips to copy and scan successfully:

- Keep the glass and the back of the lid clean. The scanner interprets anything it detects on the glass as part of the image.
- Load your original, print side down, on the right front corner of the glass.
- To make a large copy of a small original, scan the original into the computer, resize the image in the scanning software, and then print a copy of the enlarged image.
- To avoid incorrect or missing scanned text, make sure the brightness is set appropriately in the software.



---

# 6 Manage ink cartridges

This section contains the following topics:

- [Check estimated ink levels](#)
- [Order ink supplies](#)
- [Replace ink cartridges](#)
- [Use single-cartridge mode](#)
- [Cartridge warranty information](#)
- [Tips for working with cartridges](#)

## Check estimated ink levels

You can easily check the ink supply level to determine how soon you might need to replace an ink cartridge. The ink supply level shows an estimate of the amount of ink remaining in the ink cartridges.

### To check the ink levels from the printer control panel

- The **Ink Level** icons on the printer display show an estimate of ink remaining in the ink cartridges.

For more information about the **Ink Level** icons, see [Control panel lights and display icons status on page 7](#).

### To check the ink levels from the HP printer software (Windows)

1. Open the HP printer software. For more information, see [Open the HP printer software \(Windows\) on page 23](#).
2. In the printer software, click the **Estimated Ink Levels** tab.

### To check the ink levels from the HP printer software (OS X)

1. Open HP Utility.  
HP Utility is located in the **Hewlett-Packard** folder in the **Applications** folder at the top level of the hard disk.
2. Select the HP DeskJet 3630 series from the list of devices at the left of the window.
3. Click **Supplies Status**.  
The estimated ink levels appear.
4. Click **All Settings** to return to the **Information and Support** pane.

---

 **NOTE:** If you have installed a refilled or remanufactured ink cartridge, or an ink cartridge that has been used in another printer, the ink level indicator might be inaccurate or unavailable.

 **NOTE:** Ink level warnings and indicators provide estimates for planning purposes only. When you receive a low-ink warning message, consider having a replacement ink cartridge available to avoid possible printing delays. You do not have to replace the ink cartridges until the print quality is unacceptable.

 **NOTE:** Ink from the ink cartridges is used in the printing process in a number of different ways, including in the initialization process, which prepares the printer and cartridges for printing, and in printhead servicing, which keeps print nozzles clear and ink flowing smoothly. In addition, some residual ink is left in the ink cartridge after it is used. For more information, see [www.hp.com/go/inkusage](http://www.hp.com/go/inkusage).

---

# Order ink supplies

Before ordering cartridges, locate the correct cartridge number.

## To locate the cartridge number on the printer

- The cartridge number is located inside the front door.

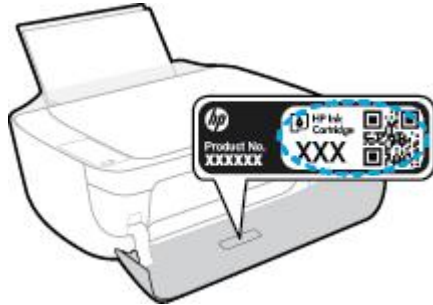

## To locate the cartridge number from the printer software (Windows)

1. Open the HP printer software. For more information, see [Open the HP printer software \(Windows\) on page 23](#).
2. In the printer software, click **Shop**, click **Shop For Supplies Online**, and then follow the on-screen instructions.

## To find the print cartridge reorder numbers (OS X)

1. Open HP Utility.

 **NOTE:** HP Utility is located in the **Hewlett-Packard** folder in the **Applications** folder at the top level of the hard disk.

2. Click **Supplies Info**.

The print cartridge ordering numbers appear.

3. Click **All Settings** to return to the **Information and Support** pane.

To order original HP supplies for the HP DeskJet 3630 series, go to [www.hp.com/buy/supplies](http://www.hp.com/buy/supplies). If prompted, choose your country/region, and then follow the prompts to find the right cartridges for your printer.

 **NOTE:** Ordering ink cartridges online is not supported in all countries/regions. If it is not available in your country/region, you may still view supplies information and print a list for reference when shopping at a local HP reseller.

# Replace ink cartridges

## To replace the ink cartridges

1. Check that power is on.
2. Close the output tray extender, and then rotate the output tray clockwise to stow it in the printer.



3. Remove the ink cartridge.
  - a. Open the front door of the printer.

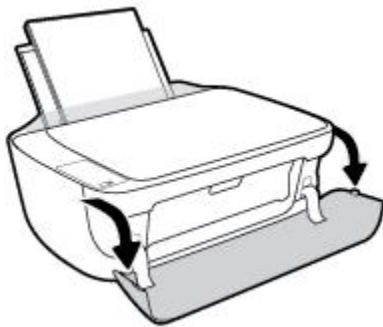

- b. Open the cartridge access door and wait for the print carriage to move to the center of the printer.



- c. Press down to release the ink cartridge, and then remove it from the slot.

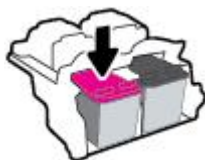



4. Insert a new ink cartridge.
- a. Remove the ink cartridge from the packaging.

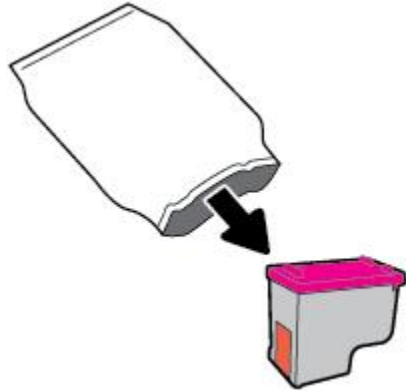

- b. Remove the plastic tape using the pull tab.

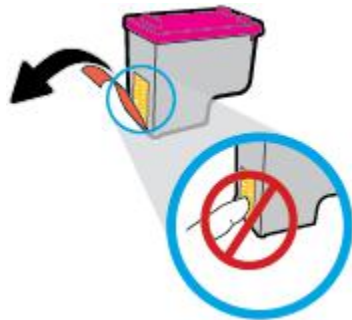

---

 **NOTE:** Do not touch the electrical contacts on the ink cartridge.

---

- c. Slide the ink cartridge into the slot until it clicks into place.



- d. Close the cartridge access door.



---

 **NOTE:** The HP printer software prompts you to align the ink cartridges when you print a document after installing the new ink cartridge.

---

- e. Close the front door of the printer.



- 5. Pull out the output tray and the tray extender.



## Use single-cartridge mode

Use the single-cartridge mode to operate the printer with only one ink cartridge. The single-cartridge mode is initiated when an ink cartridge is removed from the ink cartridge carriage.



**NOTE:** When the printer operates in single-cartridge mode, a message is displayed on the computer screen. If the message is displayed and two ink cartridges are installed in the printer, verify that the protective piece of plastic tape has been removed from each ink cartridge. When the plastic tape covers the ink cartridge contacts, the printer cannot detect that the ink cartridge is installed. If there is no plastic tape on the cartridges, try cleaning the cartridge contacts. For information about cleaning ink cartridge contacts, see [Ink cartridge issues on page 85](#).

### To exit the single-cartridge mode

- Install both the black and tri-color ink cartridges in the printer.

## Cartridge warranty information

The HP cartridge warranty is applicable when the cartridge is used in its designated HP printing device. This warranty does not cover HP ink cartridges that have been refilled, remanufactured, refurbished, misused, or tampered with.

During the warranty period, the cartridge is covered as long as the HP ink is not depleted and the end of warranty date has not been reached. The end of warranty date, in YYYY/MM/DD format, may be found on the cartridge as indicated:



For a copy of the HP Limited Warranty Statement, see the printed documentation that came with the printer.

## Tips for working with cartridges

Use the following tips to work with cartridges:

- To protect the cartridges from drying out, always turn the printer off using the **Power** button, and wait until the **Power** button light goes out.
- Do not open or untape cartridges until you are ready to install them. Leaving tape on the cartridges reduces ink evaporation.
- Insert the cartridges into the correct slots. Match the color and icon of each cartridge to the color and icon for each slot. Make sure the cartridges snap into place.
- Align the printer for best print quality. See [Printing issues on page 88](#) for more information.
- When the Estimated Ink Levels screen shows one or both cartridges in a low state, consider getting replacement cartridges to avoid possible printing delays. You do not need to replace the cartridges until print quality becomes unacceptable. See [Replace ink cartridges on page 58](#) for more information.
- If you remove a cartridge from the printer for any reason, try to replace it again as soon as possible. Outside of the printer, if unprotected, cartridges begin to dry out.



---

# 7 Connect your printer

- [Connect your printer to a wireless network with a router](#)
- [Connect wirelessly to the printer without a router](#)
- [Wireless settings](#)
- [Connect your printer to your computer with a USB cable \(non-network connection\)](#)
- [Change from a USB connection to a wireless network](#)
- [Advanced printer management tools \(for networked printers\)](#)
- [Tips for setting up and using a networked printer](#)

## Connect your printer to a wireless network with a router

 **TIP:** To print a wireless quick start guide, press the **Information** button () for three seconds.

- [Connect your printer to a wireless network using Wi-Fi Protected Setup \(WPS\)](#)
- [Connect your printer to a wireless network using HP printer software](#)

### Connect your printer to a wireless network using Wi-Fi Protected Setup (WPS)

Before you can connect your printer to a wireless network using WPS, make sure you have following:

- A wireless 802.11b/g/n network that includes a WPS-enabled wireless router or access point.

 **NOTE:** The printer only supports connections using 2.4GHz.

- A computer connected to the wireless network that you intend to connect the printer to. Be sure you have installed the HP printer software on the computer.

If you have a WPS router with a WPS push button, follow the **Push Button method**. If you are not certain your router has a push button, follow the **PIN method**.



#### To use the Push Button Configuration (PBC) method

1. Press and hold the **Wireless** button () on the printer for more than three seconds to start WPS push mode. The **Wireless** light starts blinking.
2. Press the WPS button on your router.



 **NOTE:** The product begins a timer for approximately two minutes while a wireless connection is established.

#### To use the PIN method

1. Press the **Wireless** button () and **Information** button () at the same time to print the network configuration page, and then locate a WPS PIN.  
The WPS PIN is printed at the top of the printed information page.
2. Press and hold the **Wireless** button () from the printer control panel for more than three seconds.  
The wireless light starts blinking.
3. Open the configuration utility or software for the wireless router or wireless access point, and then enter the WPS PIN.



---

 **NOTE:** For more information about using the configuration utility, see the documentation provided with the router or wireless access point.

---

Wait for about two minutes. If the printer connects successfully, the **Wireless** light stops blinking but remains lit.

## Connect your printer to a wireless network using HP printer software

To connect the printer to an integrated wireless WLAN 802.11 network, you will need the following:

- A wireless 802.11b/g/n network that includes a wireless router or access point.

---

 **NOTE:** The printer only supports connections using 2.4GHz.

---

- A computer connected to the wireless network that you intend to connect the printer to.
- Network name (SSID).
- WEP key or WPA Passphrase (if needed).

### To connect your printer using HP printer software (Windows)

1. Depending on whether you have installed the HP printer software or not, do one of the following:

#### If you have not installed the HP printer software on your computer

- a. Visit [123.hp.com](http://123.hp.com) to download and install the printer software.

---

 **NOTE:** During the software installation, a USB cable might be required for temporary connection between the printer and the computer. Do not connect the USB cable until the printer software prompts to do so.

---

- b. When you are prompted, select **Wireless**, and then follow the on-screen instructions.

#### If you have the HP printer software installed on your computer

- a. Open the printer software. For more information, see [Open the HP printer software \(Windows\) on page 23](#).
- b. In the printer software, click **Utilities**.
- c. Click **Printer Setup & Software**.
- d. Click **Connect a new printer**, click **Wireless**, and then follow the on-screen instructions.

2. After the printer connects successfully, the blue **Wireless** light stops blinking and remains on.

### To connect your printer using HP printer software (OS X)

1. Depending on whether you have installed the HP printer software or not, do one of the following:

#### If you have not installed the HP printer software on your computer

- a. Insert the printer software CD in your computer.
- b. Double-click the HP Installer icon on the software CD, and then follow the on-screen instructions.

### If you have the HP printer software installed on your computer

- a. Double-click the HP Utility icon (located in the **Hewlett-Packard** folder in the **Applications** folder at the top level of the hard disk).
  - b. On the menu bar at the top of the screen, choose **Setup New Device** from the Devices menu, and then follow the on-screen instructions.
2. After the printer connects successfully, the blue **Wireless** light stops blinking and remains on.

### To connect a new printer (Windows)

1. Open the printer software. For more information, see [Open the HP printer software \(Windows\) on page 23](#).
2. In the printer software, click **Utilities**.
3. Select **Printer Setup & Software**.
4. Select **Connect a new printer**. Follow the onscreen instructions.

### To connect a new printer (OS X)

1. Open **System Preferences**.
2. Depending on your operating system, click **Print & Fax**, **Print & Scan**, or **Printers & Scanners** in the **Hardware** section.
3. Click + below the list of printers at the left.
4. Select the new printer from the list.

# Connect wirelessly to the printer without a router

With Wi-Fi Direct, you can print wirelessly from a computer, smart phone, tablet, or other wireless-capable device—without connecting to an existing wireless network.

## Guidelines for using Wi-Fi Direct

- Make sure your computer or mobile device has the necessary software.
  - If you are using a computer, make sure you have installed the HP printer software.  
If you have not installed the HP printer software on the computer, connect to Wi-Fi Direct first and then install the printer software. Select **Wireless** when prompted by the printer software for a connection type.
  - If you are using a mobile device, make sure you have installed a compatible printing app. For more information about mobile printing, visit [www.hp.com/global/us/en/eprint/mobile\\_printing\\_apps.html](http://www.hp.com/global/us/en/eprint/mobile_printing_apps.html).
- Make sure Wi-Fi Direct for your printer is turned on.
- Up to five computers and mobile devices can use the same Wi-Fi Direct connection.
- Wi-Fi Direct can be used while the printer is also connected either to a computer using a USB cable or to a network using a wireless connection.
- Wi-Fi Direct cannot be used to connect a computer, mobile device, or printer to the Internet.

## Guidelines for using Wi-Fi Direct



- Make sure your computer or mobile device has the necessary software.
  - If you are using a computer, make sure you have installed the HP printer software.  
If you have not installed the HP printer software on the computer, connect to Wi-Fi Direct first and then install the printer software. Select **Wireless** when prompted by the printer software for a connection type.
  - If you are using a mobile device, make sure you have installed a compatible printing app. For more information about mobile printing, visit [www.hp.com/global/us/en/eprint/mobile\\_printing\\_apps.html](http://www.hp.com/global/us/en/eprint/mobile_printing_apps.html).
- Make sure Wi-Fi Direct for your printer is turned on.
- Up to five computers and mobile devices can use the same Wi-Fi Direct connection.
- Wi-Fi Direct can be used while the printer is also connected either to a computer using a USB cable or to a network using a wireless connection.
- Wi-Fi Direct cannot be used to connect a computer, mobile device, or printer to the Internet.

## To turn Wi-Fi Direct on or off

On the printer control panel, press the **Wi-Fi Direct** button (.

- When Wi-Fi Direct is turned on, the **Wi-Fi Direct** light is on steady. To find the Wi-Fi Direct name and password, press the **Information** button () to print a printer information page.



**NOTE:** When you turn on Wi-Fi Direct the first time, the printer automatically prints a Wi-Fi Direct guide. The guide provides instructions about how to use Wi-Fi Direct. After that, you can press the **Wi-Fi Direct** button () and the **Information** button () together to print the Wi-Fi Direct guide. The guide may not be available in all languages.

- When Wi-Fi Direct is turned off, the **Wi-Fi Direct** light is off.
- For more information about the Wi-Fi Direct light status, see [Control panel lights and display icons status on page 7](#).

## To print from a wireless-capable mobile device that supports Wi-Fi Direct

Make sure you have installed the latest version of HP Print Service Plugin on your mobile device. You can download this plugin from the Google Play application store.

1. Make sure you have turned on Wi-Fi Direct on the printer.
2. Turn on Wi-Fi Direct on your mobile device. For more information, see the documentation provided with the mobile device.
3. From your mobile device, select a document from a print enabled application, and then select the option to print the document.

The list of available printers appears.

4. From the list of available printers, choose the Wi-Fi Direct name shown such as DIRECT-\*\*-HP DeskJet 3630 series (where \*\* are the unique characters to identify your printer).
  - If the Wi-Fi Direct connection security for the printer is **Automatic** (the default setting), the mobile device will connect to the printer automatically and send the print job.
  - If the Wi-Fi Direct connection security for the printer is set to **Manual**, do one of the following to connect to the printer and print.
    - If the Wi-Fi Direct light on the printer control panel keeps blinking, press the **Wi-Fi Direct** button (). The light will stop blinking and stay on.
    - If the printer prints out a page with a PIN code, follow the instruction on the page.



**TIP:** You can change the Wi-Fi Direct connection security setting for the printer from the embedded web server (EWS). For more information, see [Open the embedded web server on page 76](#).

## To print from a wireless-capable mobile device that does not support Wi-Fi Direct

Make sure you have installed a compatible printing app on your mobile device. For more information, visit [www.hp.com/global/us/en/eprint/mobile\\_printing\\_apps.html](http://www.hp.com/global/us/en/eprint/mobile_printing_apps.html).

1. Make sure you have turned on Wi-Fi Direct on the printer.
2. Turn on the Wi-Fi connection on your mobile device. For more information, see the documentation provided with the mobile device.



**NOTE:** If your mobile device does not support Wi-Fi, you are not able to use Wi-Fi Direct.

3. From the mobile device, connect to a new network. Use the process you normally use to connect to a new wireless network or hotspot. Choose the Wi-Fi Direct name from the list of wireless networks shown such as DIRECT-\*\*-HP DeskJet 3630 series (where \*\* are the unique characters to identify your printer).

Enter the Wi-Fi Direct password when prompted.

4. Print your document.

## To print from a wireless-capable computer (Windows)

1. Make sure you have turned on Wi-Fi Direct on the printer.
2. Turn on the computer's Wi-Fi connection. For more information, see the documentation provided with the computer.



**NOTE:** If your computer does not support Wi-Fi, you are not able to use Wi-Fi Direct.

3. From the computer, connect to a new network. Use the process you normally use to connect to a new wireless network or hotspot. Choose the Wi-Fi Direct name from the list of wireless networks shown such as DIRECT-\*\*-HP DeskJet 3630 series (where \*\* are the unique characters to identify your printer and XXXX is the printer model located on the printer).

Enter the Wi-Fi Direct password when prompted.

4. Proceed to step 5 if the printer has been installed and connected to the computer over a wireless network. If the printer has been installed and connected to your computer with a USB cable, follow the steps below to install the printer software using the HP Wi-Fi Direct connection.
  - a. Depending on your operating system, do one of the following:
    - **Windows 8.1:** Click the down arrow in lower left corner of the Start screen, select the printer name, and then click **Utilities**.
    - **Windows 8:** Right-click an empty area on the Start screen, click **All Apps** on the app bar, select the printer name, and then click **Utilities**.
    - **Windows 7, Windows Vista, and Windows XP:** From the computer desktop, click **Start**, select **All Programs**, click **HP**, click the folder of your printer.
  - b. Click **Printer Setup & Software**, and then select **Connect a new printer**.

- c. When the **Connection Options** software screen appears, select **Wireless**.  
Select your HP printer software from the list of detected printers.
  - d. Follow the on-screen instructions.
5. Print your document.

#### To print from a wireless-capable computer (OS X)

1. Make sure you have turned on Wi-Fi Direct on the printer.
2. Turn on Wi-Fi on the computer.  
For more information, see the documentation provided by Apple.
3. Click the Wi-Fi icon and choose the Wi-Fi Direct name, such as DIRECT-\*\*-HP DeskJet 3630 series (where \*\* are the unique characters to identify your printer and XXXX is the printer model located on the printer).  
If Wi-Fi Direct is turned on with security, enter the password when prompted.
4. Add the printer.
  - a. Open **System Preferences**.
  - b. Depending on your operating system, click **Print & Fax**, **Print & Scan**, or **Printers & Scanners** in the **Hardware** section.
  - c. Click + below the list of printers at the left.
  - d. Select the printer from the list of detected printers (the word “Bonjour” is listed the right column beside the printer name), and click **Add**.

# Wireless settings

You can set up and manage your printer wireless connection and perform a variety of network management tasks. This includes printing information about network settings, turning the wireless function on or off, and changing wireless settings.

## To turn on or off the wireless capability of the printer

Press the **Wireless** button () to turn on or off the printer wireless capabilities.

- If the printer has an active connection to a wireless network, the **Wireless** light is on solid blue, and the printer display shows the **Wireless** icon and the **Signal Bars** icon.
- If wireless is turned off, the **Wireless** light is off.
- For more information about the wireless status, see [Control panel lights and display icons status on page 7](#).

## To print the wireless network test report and network configuration page

Press the **Wireless** button () and the **Information** button () at the same time.

- The wireless network test report shows the diagnostics results for the status of the wireless network, wireless signal strength, detected networks, and more.
- The network configuration page shows the network status, hostname, network name, and more.

## To change wireless settings (Windows)

This method is available if you have already installed the printer software.



**NOTE:** This method requires a USB cable. Do not connect the USB cable until prompted to do so.

1. Open the HP printer software. For more information, see [Open the HP printer software \(Windows\) on page 23](#).
2. In the printer software, click **Utilities**.
3. Click **Printer Setup & Software**.
4. Select **Reconfigure Wireless Settings**. Follow the on-screen instructions.

## To restore network settings to default settings

- Press the **Wireless** button () and the **Cancel** button () from the printer control panel at the same time, and then hold them for three seconds.

# Connect your printer to your computer with a USB cable (non-network connection)

The printer supports a rear USB 2.0 High Speed port for connection to a computer.

## To connect the printer with the USB cable

1. Visit [123.hp.com](http://123.hp.com) to download and install the printer software.



---

**NOTE:** Do not connect the USB cable to the printer until you are prompted to do so.

---

2. Follow the on-screen instructions. When you are prompted, connect the printer to the computer by selecting **USB** on the **Connection Options** screen.
3. Follow the onscreen instructions.

If the printer software has been installed, the printer will operate as a plug-and-play device.



## Change from a USB connection to a wireless network

If you first set up your printer and installed the software with a USB cable, directly connecting the printer to your computer, you can easily change to a wireless network connection. You will need a wireless 802.11b/g/n network that includes a wireless router or access point.



**NOTE:** The printer only supports connections using 2.4GHz.

---

Before changing from a USB connection to a wireless network, make sure that:

- The printer is connected to your computer with the USB cable until you are prompted to disconnect the cable.
- The computer is connected to the wireless network that you intend to install the printer on.

### Change from a USB connection to a wireless network (Windows)

1. Open the HP printer software. For more information, see [Open the HP printer software \(Windows\) on page 23](#).
2. In the printer software, click **Utilities**.
3. Click **Printer Setup & Software**.
4. Select **Convert a USB connected printer to wireless**. Follow the on-screen instructions.

### To change from a USB connection to a wireless network (OS X)

1. Connect the printer to your wireless network.
2. Use **HP Setup Assistant** in **Applications/Hewlett-Packard/Device Utilities** to change the software connection to wireless for this printer.

## Advanced printer management tools (for networked printers)

When the printer is connected to a network, you can use the embedded web server (EWS) to view status information, change settings, and manage the printer from your computer.

 **NOTE:** You can open and use the EWS without being connected to the Internet. However, some features are not available.



 **NOTE:** To view or change some settings, you might need a password.

- [Open the embedded web server](#)
- [About cookies](#)

### Open the embedded web server

You can use one of the following ways to open the embedded web server.

#### To open the embedded web server through a network



1. From the printer control panel, press the **Wireless** button () and the **Information** button () together to print the network configuration page.
2. Find out the IP address or hostname of the printer from the network configuration page.
3. In a supported web browser on your computer, type the IP address or hostname assigned to the printer.

For example, if the IP address is 192.168.0.12, type the following address into a Web browser: `http://192.168.0.12`.

#### To open the embedded web server from the HP printer software (Windows)

1. Open the printer software. For more information, see [Open the HP printer software \(Windows\) on page 23](#).
2. Click **Print & Scan**, and then click **Printer Home Page (EWS)**.

#### To open the embedded web server through Wi-Fi Direct

1. If the Wi-Fi Direct light is off, press the **Wi-Fi Direct** button () to turn it on. To find the Wi-Fi Direct name and password, press the **Information** button () to print a printer information page.
2. From your wireless computer, turn wireless on, search for and connect to the Wi-Fi Direct name, for example: DIRECT-\*\*-HP DeskJet 3630 series. Enter the Wi-Fi Direct password when prompted.
3. In a supported web browser on your computer, type the following address: `http://192.168.223.1`.

### About cookies

The embedded Web server (EWS) places very small text files (cookies) on your hard drive when you are browsing. These files let the EWS recognize your computer the next time you visit. For example, if you have configured the EWS language, a cookie helps remember which language you have selected so that the next time you access the EWS, the pages are displayed in that language. Some cookies (such as the cookie that stores customer-specific preferences) are stored on the computer until you clear them manually.

You can configure your browser to accept all cookies, or you can configure it to alert you every time a cookie is offered, which allows you to decide which cookies to accept or refuse. You can also use your browser to remove unwanted cookies.



---

**NOTE:** Depending on your printer, if you disable cookies, you also disable one or more of the following features:

---

- Starting where you left the application (especially useful when using setup wizards)
- Remembering the EWS browser language setting
- Personalizing the EWS Home page

For information about how to change your privacy and cookie settings and how to view or delete cookies, see the documentation available with your Web browser.

## Tips for setting up and using a networked printer

Use the following tips to set up and use a networked printer:

- When setting up the wireless networked printer, make sure your wireless router or access point is powered on. The printer searches for wireless routers, then lists the detected network names on the computer.
- If your computer is connected to a Virtual Private Network (VPN), you need to disconnect from the VPN before you can access any other device on your network, including the printer.
- Learn more about configuring your network and the printer for wireless printing. [Click here to go online for more information.](#)
- Learn how to find your network security settings. [Click here to go online for more information.](#)
- Learn about the HP Print and Scan Doctor. [Click here to go online for more information.](#)



**NOTE:** This utility is only available for Windows operation system.

---

- Learn how to change from a USB to wireless connection. [Click here to go online for more information.](#)
- Learn how to work with your firewall and antivirus programs during printer setup. [Click here to go online for more information.](#)

---

# 8 Solve a problem

This section contains the following topics:

- [Jams and paper-feed issues](#)
- [Ink cartridge issues](#)
- [Printing issues](#)
- [Copy issues](#)
- [Scan issues](#)
- [Network and connection issues](#)
- [Printer hardware issues](#)
- [Control panel error codes](#)
- [HP support](#)

# Jams and paper-feed issues

What do you want to do?

## Clear a paper jam

|   |  |
|---|--|
| <a href="#">Solve paper jam issues.</a> | Use an HP online troubleshooting wizard<br>Instructions for clearing paper jams and resolving issues with paper or the paper feed. |
|---|--|

 **NOTE:** The HP online troubleshooting wizards may not be available in all languages.

## Read general instructions in the Help for clearing paper jams

Paper jams can occur in several locations.

### To clear a paper jam from the input tray

1. Press the **Cancel** button (✗) to try to clear the jam automatically. If this does not work, complete the following steps to clear the jam manually.
2. Pull the paper gently out of the input tray.



3. Make sure there is no foreign object in the paper path, and then reload paper.

 **NOTE:** The input tray shield can prevent foreign debris from falling into the paper path and causing serious paper jams. Do not take down the input tray shield.

4. Press the **Resume** button () on the control panel to continue the current job.

### To clear a paper jam from the output tray

1. Press the **Cancel** button (✗) to try to clear the jam automatically. If this does not work, complete the following steps to clear the jam manually.

2. Pull the paper gently out of the output tray.



3. Press the **Resume** button (⏪) on the control panel to continue the current job.

### To clear a paper jam from the cartridge access area

1. Press the **Cancel** button (⏹) to try to clear the jam automatically. If this does not work, complete the following steps to clear the jam manually.
2. Remove the jammed paper.
  - a. Press the **Power** button (⏻) to turn off the printer.
  - b. Close the output tray extender, and then rotate the output tray clockwise to stow it in the printer.



- c. Open the front door of the printer.

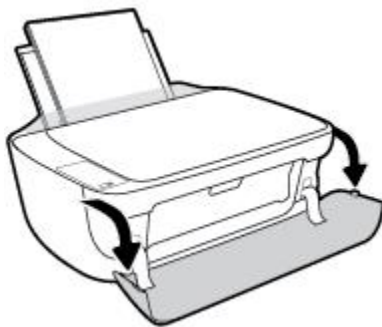

- d. Open the cartridge access door.

- e. If the print carriage is in the center of the printer, slide it to the right.



- f. Remove the jammed paper.



- g. Close the cartridge access door, and then close the front door.

- h. Pull out the output tray and the tray extender.



3. Press the **Power** button (⏻) to turn on the printer.

#### To clear a paper jam inside of the printer

1. Press the **Cancel** button (✖) to try to clear the jam automatically. If this does not work, complete the following steps to clear the jam manually.
2. Press the **Power** button (⏻) to turn off the printer.



3. Turn the printer over, locate the cleanout door on the bottom of the printer, and then pull both tabs on the cleanout door to open it.

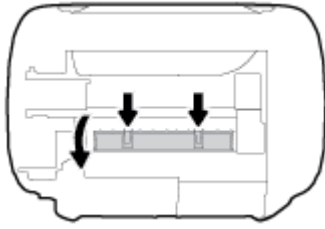

4. Remove the jammed paper.

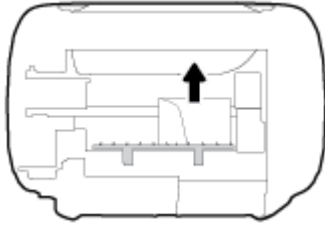

5. Close the cleanout door. Gently push the door towards the printer until both latches snap into place.

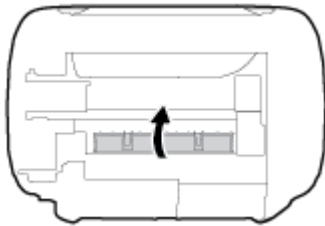

6. Turn the printer over, and then press the **Power** button (⏻) to turn on the printer.

## Clear a print carriage jam

[Resolve a print carriage jam.](#)

Use an HP online troubleshooting wizard

If something is blocking the print carriage or it does not move easily, get step-by-step instructions.



**NOTE:** The HP online troubleshooting wizards may not be available in all languages.

## Read general instructions in the Help for clearing a print carriage jams

- ▲ Remove any objects, such as paper, that are blocking the print carriage.



**NOTE:** Do not use any tools or other devices to remove jammed paper. Always use caution when removing jammed paper from inside the printer.

## Learn how to avoid paper jams

To help avoid paper jams, follow these guidelines.

- Do not overfill the input tray.
- Remove printed papers from the output tray frequently.
- Ensure that paper loaded in the input tray lays flat, and the edges are not bent or torn.
- Do not combine different paper types and paper sizes in the input tray; the entire stack of paper in the input tray must be the same size and type.
- Adjust the paper-width guide in the input tray to fit snugly against all paper. Make sure the paper-width guide does not bend the paper in the input tray.
- Do not force paper too far down in the input tray.
- Do not add paper while the printer is printing. If the printer is about to run out of paper, wait until the out of paper message appears before adding paper.

## Solve paper-feed problems

What kind of problem are you having?

- **Paper is not picked up from the input tray**
  - Make sure paper is loaded in the input tray. For more information, see [Load media on page 15](#).
  - Adjust the paper-width guide in the input tray to fit snugly against all paper. Make sure the paper-width guide does not bend the paper in the input tray.
  - Make sure paper in the input tray is not curled. Uncurl paper by bending it in the opposite direction of the curl.
- **Pages are skewing**
  - Make sure the paper is loaded in the far-right side of the input tray and the paper-width guide is fit against the left side of the paper.
  - Load paper into the printer only when it is not printing.
- **Multiple pages are being picked up**
  - Adjust the paper-width guide in the input tray to fit snugly against all paper. Make sure the paper-width guide does not bend the paper in the input tray.
  - Make sure the input tray is not overloaded with paper.
  - Make sure the pieces of the loaded paper are not sticking together.
  - Use HP paper for optimum performance and efficiency.

# Ink cartridge issues

## Identify whether an ink cartridge has a problem

To identify whether an ink cartridge has a problem, check the status of the **Ink Alert** light and the corresponding **Ink Level** icon. For more information, see [Control panel lights and display icons status on page 7](#).

If you get an ink cartridge problem message from the printer software that states at least one of the cartridges has a problem, do the following to identify whether a cartridge has a problem.

1. Remove the black cartridge and then close the cartridge access door.
  - If the **Ink Level** icon for the tri-color cartridge blinks, the tri-color cartridge has a problem.
  - If the **Ink Level** icon for the tri-color cartridge does not blink, the tri-color cartridge does not have a problem.
2. Install the black cartridge back in the printer, remove tri-color cartridge, and then close the cartridge access door.
  - If the **Ink Level** icon for the black cartridge blinks, the black cartridge has a problem.
  - If the **Ink Level** icon for the black cartridge does not blink, the black cartridge does not have a problem.

## Fix ink cartridge problems

If an error occurs after a cartridge is installed, or if a message indicates a cartridge problem, try removing the ink cartridges, verifying the protective piece of plastic tape has been removed from each ink cartridge, and then reinserting the ink cartridges. If this does not work, clean the cartridge contacts. If the problem is still not resolved, replace the ink cartridges. For information about replacing ink cartridges, see [Replace ink cartridges on page 58](#).

### To clean cartridge contacts

**CAUTION:** The cleaning procedure should take only a few minutes. Make sure that the ink cartridges are reinstalled in the printer as soon as possible. It is not recommended to leave the ink cartridges outside of the printer longer than 30 minutes. This could result in damage to the printhead or the ink cartridges.

1. Check that power is on.
2. Close the output tray extender, and then rotate the output tray clockwise to stow it in the printer.



3. Open the front door of the printer.



4. Open the cartridge access door and wait for the print carriage to move to the center of the printer.



5. Remove the ink cartridge indicated in the error message.

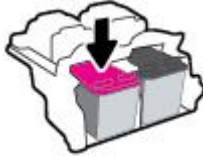

6. Clean the cartridge contacts and printer contacts.

- a. Hold the ink cartridge by its sides with the bottom pointing up and locate the electrical contacts on the ink cartridge.

The electrical contacts are the small gold-colored dots on the ink cartridge.

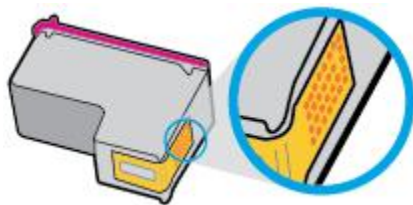

- b. Wipe only the contacts with a dry swab or lint-free cloth.

---

**⚠ CAUTION:** Be careful to wipe only the contacts, and do not smear any of the ink or other debris elsewhere on the ink cartridge.

---

- c. On the inside of the printer, locate the contacts for the cartridge.

The printer contacts are the set of gold-colored bumps positioned to meet the contacts on the ink cartridge.

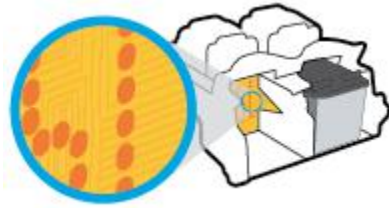

- d. Use a dry swab or lint-free cloth to wipe the contacts.
7. Reinstall the ink cartridge.
8. Close the cartridge access door, and then close the front door.
9. Check if the error message has gone away. If you still receive the error message, turn the printer off, and then on.



---

**NOTE:** If one ink cartridge is causing problems, you can remove it and use the single-cartridge mode to operate the printer with only one ink cartridge.

---

## Fix ink cartridge incompatible issues

The ink cartridge is not compatible with your printer. This error can occur if you install an HP Instant Ink cartridge into a printer that has not been enrolled in the HP Instant Ink program. It can also occur if the HP Instant Ink cartridge was previously used in a different printer enrolled in the HP Instant Ink program.

# Printing issues

What do you want to do?

## Fix problems with page not printing (unable to print)

|   |   |
|---|---|
| <a href="#">HP Print and Scan Doctor</a>                            | The HP Print and Scan Doctor is a utility that will try to diagnose and fix the issue automatically.<br><b>NOTE:</b> This utility is only available for Windows operation system. |
| <a href="#">Troubleshoot problems with print jobs not printing.</a> | Use an HP online troubleshooting wizard<br>Get step-by-step instructions if the printer is not responding or printing.  |



**NOTE:** The HP Print and Scan Doctor and the HP online troubleshooting wizards may not be available in all languages.

## Read general instructions in the Help for unable to print issues

### To resolve print issues (Windows)

Make sure that the printer is turned on and that there is paper in the input tray. If you are still unable to print, try the following in order:

1. Check for error messages from the printer software and resolve them by following the on-screen instructions.
2. If your computer is connected to the printer with a USB cable, disconnect and reconnect the USB cable. If your computer is connected to the printer with a wireless connection, confirm that the connection is working.
3. Verify that the printer is not paused or offline.

### To verify that the printer is not paused or offline

- a. Depending upon your operating system, do one of the following:
  - **Windows 8.1 and Windows 8:** Point to or tap the upper-right corner of the screen to open the Charms bar, click the **Settings** icon, click or tap **Control Panel**, and then click or tap **View devices and printers**.
  - **Windows 7:** From the Windows **Start** menu, click **Devices and Printers**.
  - **Windows Vista:** From the Windows **Start** menu, click **Control Panel**, and then click **Printers**.
  - **Windows XP:** From the Windows **Start** menu, click **Control Panel**, and then click **Printers and Faxes**.
- b. Either double-click the icon for your printer or right-click the icon for your printer and select **See what's printing** to open the print queue.
- c. On the **Printer** menu, make sure there are no check marks next to **Pause Printing** or **Use Printer Offline**.
- d. If you made any changes, try to print again.

4. Verify that the printer is set as the default printer.

#### To verify that the printer is set as the default printer

- a. Depending upon your operating system, do one of the following:
    - **Windows 8.1 and Windows 8:** Point to or tap the upper-right corner of the screen to open the Charms bar, click the **Settings** icon, click or tap **Control Panel**, and then click or tap **View devices and printers**.
    - **Windows 7:** From the Windows **Start** menu, click **Devices and Printers**.
    - **Windows Vista:** From the Windows **Start** menu, click **Control Panel**, and then click **Printers**.
    - **Windows XP:** From the Windows **Start** menu, click **Control Panel**, and then click **Printers and Faxes**.
  - b. Make sure the correct printer is set as the default printer.

The default printer has a check mark in a black or green circle next to it.
  - c. If the wrong printer is set as the default printer, right-click the correct printer and select **Set as Default Printer**.
  - d. Try using your printer again.
5. Restart the print spooler.

#### To restart the print spooler

- a. Depending upon your operating system, do one of the following:
  - Windows 8.1 and Windows 8**
    - i. Point to or tap the upper-right corner of the screen to open the Charms bar, and then click the **Settings** icon.
    - ii. Click or tap **Control Panel**, and then click or tap **System and Security**.
    - iii. Click or tap **Administrative Tools**, and then double-click or double-tap **Services**.
    - iv. Right-click or touch and hold **Print Spooler**, and then click **Properties**.
    - v. On the **General** tab, next to **Startup type**, make sure that **Automatic** is selected.
    - vi. If the service is not already running, under **Service status**, click or tap **Start**, and then click or tap **OK**.
  - Windows 7**
    - i. From the Windows **Start** menu, click **Control Panel**, **System and Security**, and then **Administrative Tools**.
    - ii. Double-click **Services**.
    - iii. Right-click the **Print Spooler**, and then click **Properties**.
    - iv. On the **General** tab, next to **Startup type**, make sure that **Automatic** is selected.
    - v. If the service is not already running, under **Service status**, click **Start**, and then click **OK**.

### Windows Vista

- i. From the Windows **Start** menu, click **Control Panel, System and Maintenance, Administrative Tools**.
- ii. Double-click **Services**.
- iii. Right-click the **Print Spooler service**, and then click **Properties**.
- iv. On the **General** tab, next to **Startup type**, make sure that **Automatic** is selected.
- v. If the service is not already running, under **Service status**, click **Start**, and then click **OK**.

### Windows XP

- i. From the Windows **Start** menu, right click **My Computer**.
  - ii. Click **Manage**, and then click **Services and Applications**.
  - iii. Double-click **Services**, and then select **Print Spooler**.
  - iv. Right-click **Print Spooler**, and click **Restart** to restart the service.
- b. Make sure the correct printer is set as the default printer.  
The default printer has a check mark in a black or green circle next to it.
- c. If the wrong printer is set as the default printer, right-click the correct printer and select **Set as Default Printer**.
- d. Try using your printer again.
6. Restart the computer.
7. Clear the print queue.

### To clear the print queue

- a. Depending upon your operating system, do one of the following:
  - **Windows 8.1 and Windows 8:** Point to or tap the upper-right corner of the screen to open the Charms bar, click the **Settings** icon, click or tap **Control Panel**, and then click or tap **View devices and printers**.
  - **Windows 7:** From the Windows **Start** menu, click **Devices and Printers**.
  - **Windows Vista:** From the Windows **Start** menu, click **Control Panel**, and then click **Printers**.
  - **Windows XP:** From the Windows **Start** menu, click **Control Panel**, and then click **Printers and Faxes**.
- b. Double-click the icon for your printer to open the print queue.
- c. On the **Printer** menu, click **Cancel all documents** or **Purge Print Document**, and then click **Yes** to confirm.
- d. If there are still documents in the queue, restart the computer and try printing again after the computer has restarted.
- e. Check the print queue again to make sure it is clear, and then try to print again.



## To resolve print issues (OS X)

1. Check for error messages and resolve.
2. Disconnect and reconnect the USB cable.
3. Verify that the product is not paused or offline.

### To verify that the product is not paused or offline

- a. In **System Preferences**, click **Print & Fax**.
- b. Click the **Open Print Queue** button.
- c. Click a print job to select it.

Use the following buttons to manage the print job:

- **Delete:** Cancel the selected print job.
  - **Hold:** Pause the selected print job.
  - **Resume:** Continue a paused print job.
  - **Pause Printer:** Pause all print jobs in the print queue.
- d. If you made any changes, try to print again.
4. Restart the computer.

## Fix print quality issues

---

[Step-by-step instructions for resolving most print quality issues.](#)

Troubleshoot print quality issues online

---

## Read general instructions in the Help for resolving print quality issues



**NOTE:** To protect the cartridges from drying out, always turn the printer off using the **Power** button, and wait until the **Power** button light goes out.

---

### To improve print quality (Windows)

1. Make sure you are using original HP ink cartridges.
2. Check the printer software to make sure you have selected the appropriate paper type from the **Media** drop-down list and print quality from the **Quality Settings** drop-down list.

In the printer software, click **Print & Scan** and then click **Set Preferences** to access the print properties.

3. Check the estimated ink levels to determine if the ink cartridges are low on ink.

For more information, see [Check estimated ink levels on page 56](#). If the ink cartridges are low on ink consider replacing them.

4. Check the paper type.

For best print quality, use high quality HP paper, or papers that adhere to the ColorLok® standard. For more information, see [Paper basics on page 21](#).

Always make sure the paper you are printing on is flat. For best results when printing images, use HP Advanced Photo Paper.

Store specialty paper in its original packaging inside a resealable plastic bag on a flat surface in a cool, dry place. When you are ready to print, remove only the paper you plan to use immediately. When you have finished printing, return any unused photo paper to the plastic bag. This prevents the photo paper from curling.

**5.** Align the ink cartridges.

**To align the ink cartridges**

- a.** Load letter or A4 unused plain white paper into the input tray.
- b.** Open the printer software. For more information, see [Open the HP printer software \(Windows\) on page 23](#).
- c.** In the printer software, click **Print & Scan** and then click **Maintain Your Printer** to access the printer toolbox.

The printer toolbox appears.

- d.** Click **Align Ink Cartridges** on the **Device Services** tab.

The printer prints an alignment page.

- e.** Follow the on-screen instructions to load the cartridge alignment page print side down on the scanner glass, and then click **Scan** to scan the alignment page.

The printer aligns the ink cartridges. Recycle or discard the cartridge alignment sheet.

**6.** Print a diagnostics page if the ink cartridges are not low on ink.

**To print a diagnostics page**

- a.** Load letter or A4 unused plain white paper into the input tray.
- b.** Open the printer software. For more information, see [Open the HP printer software \(Windows\) on page 23](#).
- c.** In the printer software, click **Print & Scan** and then click **Maintain Your Printer** to access the printer toolbox.
- d.** Click **Print Diagnostic Information** on the **Device Reports** tab to print a diagnostics page.

- e. Review the blue, magenta, yellow, and black boxes on the diagnostics page.

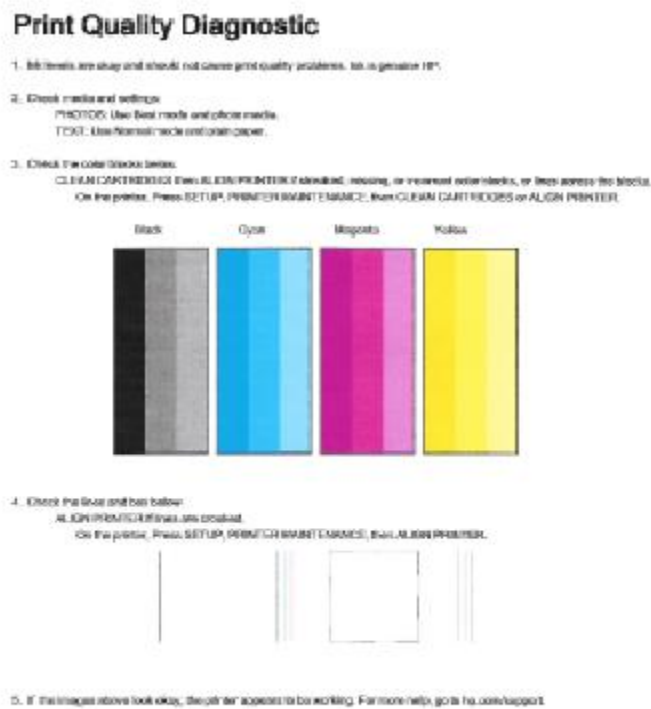

- 7. Clean the ink cartridges, if the diagnostic page shows streaks or missing portions of the color and black boxes.

**To clean the ink cartridges**

- a. Load letter or A4 unused plain white paper into the input tray.
- b. Open the printer software. For more information, see [Open the HP printer software \(Windows\) on page 23](#).
- c. In the printer software, click **Print & Scan** and then click **Maintain Your Printer** to access the **Printer Toolbox**.
- d. Click **Clean Ink Cartridges** on the **Device Services** tab. Follow the on-screen instructions.

**To improve print quality (OS X)**

- 1. Make sure you are using original HP cartridges.
- 2. Make sure you have selected the appropriate paper type and print quality in the **Print** dialog.
- 3. Check the estimated ink levels to determine if the cartridges are low on ink.

Consider replacing the print cartridges if they are low on ink.

4. Check the paper type.

For best print quality, use high quality HP paper, or papers that adhere to the ColorLok® standard. For more information, see [Paper basics on page 21](#).

Always make sure the paper you are printing on is flat. For best results when printing images, use HP Advanced Photo Paper.

Store specialty paper in its original packaging inside a resealable plastic bag on a flat surface in a cool, dry place. When you are ready to print, remove only the paper you plan to use immediately. When you have finished printing, return any unused photo paper to the plastic bag. This prevents the photo paper from curling.

5. Align the printer cartridges.

**To align print cartridges from the software**

- a. Load Letter or A4 plain, white paper in the paper tray.
- b. Open HP Utility.



---

**NOTE:** HP Utility is located in the **Hewlett-Packard** folder in the **Applications** folder at the top level of the hard disk.

---

- c. Select the HP DeskJet 3630 series from the list of devices at the left of the window.
- d. Click **Align**.
- e. Click **Align** and follow the on-screen instructions.
- f. Click **All Settings** to return to the **Information and Support** pane.

6. Print a test page.

**To print a test page**

- a. Load Letter or A4 plain, white paper in the paper tray.
- b. Open HP Utility.



---

**NOTE:** HP Utility is located in the **Hewlett-Packard** folder in the **Applications** folder at the top level of the hard disk.

---

- c. Select the HP DeskJet 3630 series from the list of devices at the left of the window.
- d. Click **Test Page**.
- e. Click the **Print Test Page** button, and follow the on-screen instructions.

Check the test page for jagged lines in the text or streaks in the text and colored boxes. If you are seeing jagged lines, or streaks, or no ink in portions of the boxes, then automatically clean the cartridges.

7. If the diagnostic page shows streaks or missing portions of the text or colored boxes, clean the print cartridges automatically.

### To automatically clean the print head

a. Load Letter or A4 plain, white paper in the paper tray.

b. Open HP Utility.



**NOTE:** HP Utility is located in the **Hewlett-Packard** folder in the **Applications** folder at the top level of the hard disk.

---

c. Select the HP DeskJet 3630 series from the list of devices at the left of the window.

d. Click **Clean Printheads**.

e. Click **Clean**, and follow the on-screen instructions.



**CAUTION:** Clean the print head only when necessary. Unnecessary cleaning wastes ink and shortens the life of the print head.



**NOTE:** If print quality still seems poor after you complete cleaning, try aligning the printer. If print quality problems persist after cleaning and aligning, contact HP support.

---

f. Click **All Settings** to return to the **Information and Support** pane.

# Copy issues

---

|   |   |
|---|---|
| <a href="#">Troubleshoot copy problems.</a> | Use an HP online troubleshooting wizard<br>Get step-by-step instructions if the printer does not create a copy, or if your printouts are low quality. |
|---|---|

---



**NOTE:** The HP online troubleshooting wizards may not be available in all languages.

---

[Tips for copy and scan success on page 53](#)

## Scan issues

|  |   |
|--|---|
| <a href="#">HP Print and Scan Doctor</a> | The HP Print and Scan Doctor is a utility that will try to diagnose and fix the issue automatically.<br><b>NOTE:</b> This utility is only available for Windows operation system. |
| <a href="#">Solve scan problems</a>      | Use an HP online troubleshooting wizard<br><br>Get step-by-step instructions if you cannot create a scan or if your scans are low quality.  |



**NOTE:** The HP Print and Scan Doctor and the HP online troubleshooting wizards may not be available in all languages.

[Tips for copy and scan success on page 53](#)

## Network and connection issues

What do you want to do?



### Fix wireless connection

Choose one of the following troubleshooting options.

|  |  |
|--|--|
| <a href="#">HP Print and Scan Doctor</a> | The HP Print and Scan Doctor is a utility that will try to diagnose and fix the issue automatically.<br><b>NOTE:</b> This utility is only available for Windows operation system.  |
| Use an HP online troubleshooting wizard  | <ul style="list-style-type: none"><li>• <a href="#">Troubleshoot your wireless problem</a>, whether your printer has never been connected or it was connected and is no longer working.</li><li>• <a href="#">Troubleshoot a firewall or antivirus issue</a>, if you suspect that it is preventing your computer from connecting to the printer.</li></ul> |

 **NOTE:** The HP Print and Scan Doctor and the HP online troubleshooting wizards may not be available in all languages.

### Read general instructions in the Help for wireless troubleshooting

- ▲ Press the **Wireless** button () and the **Information** button () at the same time to print the wireless network test report and network configuration page.

### Find network settings for wireless connection

Choose one of the following troubleshooting options.

|   |  |
|---|--|
| <a href="#">HP Print and Scan Doctor</a>                | The HP Print and Scan Doctor is a utility that can tell you the network name (SSID) and password (network key).<br><b>NOTE:</b> This utility is only available for Windows operation system. |
| <a href="#">Use an HP online troubleshooting wizard</a> | Learn how to find your network name (SSID) and wireless password.  |

 **NOTE:** The HP Print and Scan Doctor and the HP online troubleshooting wizards may not be available in all languages.

### Fix Wi-Fi Direct connection

|   |  |
|---|--|
| <a href="#">Use an HP online troubleshooting wizard</a> | Troubleshoot your Wi-Fi Direct problem or learn how to configure Wi-Fi Direct. |
|---|--|

 **NOTE:** The HP online troubleshooting wizards may not be available in all languages.



## Read general instructions in the Help for Wi-Fi Direct troubleshooting

1. Make sure that the **Wi-Fi Direct** light on the printer control panel is on. If the light is off, press the **Wi-Fi Direct** button () to turn it on.
2. From your wireless computer or mobile device, turn on the Wi-Fi connection, and then search for and connect to the Wi-Fi Direct name of your printer.
3. Enter the Wi-Fi Direct password when prompted.
4. If you are using a mobile device, make sure you have installed a compatible printing app. For more information about mobile printing, visit [www.hp.com/global/us/en/eprint/mobile\\_printing\\_apps.html](http://www.hp.com/global/us/en/eprint/mobile_printing_apps.html).

## Convert USB connection to wireless

Choose one of the following troubleshooting options.

|   |   |
|---|---|
| <a href="#">HP Print and Scan Doctor</a>                | The HP Print and Scan Doctor is a utility that will try to diagnose and fix the issue automatically.<br><b>NOTE:</b> This utility is only available for Windows operation system. |
| <a href="#">Use an HP online troubleshooting wizard</a> | Convert a USB connection to wireless or Wi-Fi Direct.   |

 **NOTE:** The HP Print and Scan Doctor and the HP online troubleshooting wizards may not be available in all languages.

[Change from a USB connection to a wireless network on page 75](#)

# Printer hardware issues

## Close cartridge access door

- Cartridge door must be closed to begin printing.



## The printer shuts down unexpectedly

- Check the power and power connections.
- Make sure the printer's power cord is connected firmly to a functioning power outlet.



**NOTE:** When Auto-Off is enabled, the printer will automatically turn off after 2 hours of inactivity to help reduce energy use. For more information, see [Auto-Off on page 26](#).

## Resolve printer failure

- Turn the printer off, then on. If that does not resolve the problem, contact HP.

## Control panel error codes

If the **Number of copies** icon on the printer display is alternating between the letter E and a number, it indicates the printer is in an error state. The letter E and the number work as error codes. For example, if the **Number of copies** icon is alternating between the letter E and the number 4, it indicates that a paper jam has occurred.

To identify the error code and its corresponding solutions, see the information about the **Number of copies** icons in [Control panel lights and display icons status on page 7](#).

## HP support

For the latest product updates and support information, visit the [HP DeskJet 3630 series support website at www.hp.com/support](http://www.hp.com/support). HP online support provides a variety of options for help with your printer:



**Drivers & downloads:** Download software drivers and updates, as well as product manuals and documentation that came in the box with your printer.



**HP support forums:** Visit HP Support Forums for answers to common questions and issues. You can view questions posted by other HP customers, or sign in and post your own questions and comments.



**Troubleshooting:** Use HP online tools to detect your printer and find recommended solutions.

---

## Contact HP

If you need help from an HP technical support representative to solve a problem, visit the [Contact Support website](#). The following contact options are available at no cost for in-warranty customers (HP agent-assisted support for out-of-warranty customers may require a fee):



Chat with an HP support agent online.



Call an HP support agent.

---

When contacting HP support, be prepared to provide the following information:

- Product name (Located on the printer, such as HP DeskJet 3630)
- Product number (located inside the front door)



- Serial number (located on the back or bottom of the printer)

## Register printer

By taking just a few quick minutes to register, you can enjoy quicker service, more efficient support, and product support alerts. If you did not register your printer while installing the software, you can register now at <http://www.register.hp.com>.

## Additional warranty options

Extended service plans are available for the HP DeskJet 3630 series at additional costs. Go to [www.hp.com/support](http://www.hp.com/support), select your country/region and language, then explore the extended warranty options available for your printer.



---

# A Technical information

The technical specifications and international regulatory information for the HP DeskJet 3630 series are provided in this section.

For additional specifications, see the printed documentation that came with the HP DeskJet 3630 series.

This section contains the following topics:

- [Hewlett-Packard Company notices](#)
- [Specifications](#)
- [Environmental product stewardship program](#)
- [Regulatory notices](#)

## Hewlett-Packard Company notices

The information contained herein is subject to change without notice.

All rights reserved. Reproduction, adaptation, or translation of this material is prohibited without prior written permission of Hewlett-Packard, except as allowed under the copyright laws. The only warranties for HP products and services are set forth in the express warranty statements accompanying such products and services. Nothing herein should be construed as constituting an additional warranty. HP shall not be liable for technical or editorial errors or omissions contained herein.

© Copyright 2018 HP Development Company, L.P.

Microsoft®, Windows®, Windows® XP, Windows Vista®, Windows® 7, Windows® 8, and Windows® 8.1 are U.S. registered trademarks of Microsoft Corporation.



# Specifications

Technical specifications for the HP DeskJet 3630 series are provided in this section. For more product specifications, see the Product Data Sheet at [www.hp.com/support](http://www.hp.com/support).

## System requirements

- For information about software and system requirements or future operating system releases and support, visit the HP online support website at [www.hp.com/support](http://www.hp.com/support).

## Environmental specifications

- Recommended operating temperature range: 15°C to 30°C (59°F to 86°F)
- Allowable operating temperature range: 5°C to 40°C (41°F to 104°F)
- Humidity: 15% to 80% RH non-condensing; 28°C maximum dewpoint
- Nonoperating (Storage) temperature range: -40°C to 60°C (-40°F to 140°F)
- In the presence of high electromagnetic fields, it is possible the output from the HP DeskJet 3630 series may be slightly distorted
- HP recommends using a USB cable less than or equal to 3 m (10 feet) in length to minimize injected noise due to potential high electromagnetic fields

## Input tray capacity

- Plain paper sheets (80 g/m<sup>2</sup> [20lb]): Up to 60
- Envelopes: Up to 5
- Index cards: Up to 20
- Photo paper sheets: Up to 20

## Output tray capacity

- Plain paper sheets (80 g/m<sup>2</sup> [20lb]): Up to 25
- Envelopes: Up to 5
- Index cards: Up to 10
- Photo paper sheets: Up to 10

## Paper size

- For a complete list of supported media sizes, see the printer software.

## Paper weights

- Plain Paper: 64 to 90 g/m<sup>2</sup> (16 to 24 lb)
- Envelopes: 75 to 90 g/m<sup>2</sup> (20 to 24 lb)
- Cards: Up to 200 g/m<sup>2</sup> (110-lb index maximum)
- Photo Paper: Up to 280 g/m<sup>2</sup> (75 lb)

### Print specifications

- Print speeds vary according to the complexity of the document
- Method: drop-on-demand thermal inkjet
- Language: PCL3 GUI

### Copy specifications

- Digital image processing
- Copy speeds vary according to the complexity of the document and model

### Scan specifications

- Resolution: up to 1200 x 1200 ppi optical  
For more information about ppi resolution, see the scanner software.
- Color: 24-bit color, 8-bit grayscale (256 levels of gray)
- Maximum scan size from glass: 21.6 x 29.7 cm (8.5 x 11.7 inches)

### Print resolution

- For a list of supported print resolutions, visit the [HP DeskJet 3630 series support website at www.hp.com/support](http://www.hp.com/support).

### Cartridge yield

- Visit [www.hp.com/go/learnaboutsupplies](http://www.hp.com/go/learnaboutsupplies) for more information on estimated cartridge yields.

### Acoustic information

- If you have Internet access, you can access acoustic information from the [HP website](http://www.hp.com).

# Environmental product stewardship program

Hewlett-Packard is committed to providing quality products in an environmentally sound manner. Design for recycling has been incorporated into this product. The number of materials has been kept to a minimum while ensuring proper functionality and reliability. Dissimilar materials have been designed to separate easily. Fasteners and other connections are easy to locate, access, and remove using common tools. High priority parts have been designed to access quickly for efficient disassembly and repair.

For more information, visit HP's Commitment to the Environment Web site at:

[www.hp.com/hpinfo/globalcitizenship/environment](http://www.hp.com/hpinfo/globalcitizenship/environment)

- [Eco-Tips](#)
- [European Union Commission Regulation 1275/2008](#)
- [Paper use](#)
- [Plastics](#)
- [Material safety data sheets](#)
- [Recycling program](#)
- [HP inkjet supplies recycling program](#)
- [Power consumption](#)
- [Disposal of waste equipment by users](#)
- [Chemical substances](#)
- [Declaration of the Presence Condition of the Restricted Substances Marking \(Taiwan\)](#)
- [The Table of Hazardous Substances/Elements and their Content \(China\)](#)
- [Restriction of hazardous substance \(Ukraine\)](#)
- [Restriction of hazardous substance \(India\)](#)
- [EPEAT](#)
- [China SEPA Eco Label User Information](#)
- [China Energy Label for Printer, Fax and Copier](#)

## Eco-Tips

HP is committed to helping customers reduce their environmental footprint. Please visit the HP Environmental Programs and Initiatives website for more information on HP's environmental initiatives.

[www.hp.com/hpinfo/globalcitizenship/environment/](http://www.hp.com/hpinfo/globalcitizenship/environment/)

## European Union Commission Regulation 1275/2008

For product power data, including the power consumption of the product in networked standby if all wired network ports are connected and all wireless network ports are activated, please refer to section P14 'Additional Information' of the product IT ECO Declaration at [www.hp.com/hpinfo/globalcitizenship/environment/productdata/itecodesktop-pc.html](http://www.hp.com/hpinfo/globalcitizenship/environment/productdata/itecodesktop-pc.html).

## Paper use

This product is suited for the use of recycled paper according to DIN 19309 and EN 12281:2002.

## Plastics

Plastic parts over 25 grams are marked according to international standards that enhance the ability to identify plastics for recycling purposes at the end of product life.

## Material safety data sheets

Material safety data sheets (MSDS) can be obtained from the HP website at:

[www.hp.com/go/msds](http://www.hp.com/go/msds)

## Recycling program

HP offers an increasing number of product return and recycling programs in many countries/regions, and partners with some of the largest electronic recycling centers throughout the world. HP conserves resources by reselling some of its most popular products. For more information regarding recycling of HP products, please visit:

[www.hp.com/hpinfo/globalcitizenship/environment/recycle/](http://www.hp.com/hpinfo/globalcitizenship/environment/recycle/)

## HP inkjet supplies recycling program

HP is committed to protecting the environment. The HP Inkjet Supplies Recycling Program is available in many countries/regions, and lets you recycle used print cartridges and ink cartridges free of charge. For more information, go to the following website:

[www.hp.com/hpinfo/globalcitizenship/environment/recycle/](http://www.hp.com/hpinfo/globalcitizenship/environment/recycle/)

## Power consumption

Hewlett-Packard printing and imaging equipment marked with the ENERGY STAR® logo is qualified to the U.S. Environmental Protection Agency's ENERGY STAR specifications for imaging equipment. The following mark will appear on ENERGY STAR qualified imaging products:



Additional ENERGY STAR qualified imaging product model information is listed at: [www.hp.com/go/energystar](http://www.hp.com/go/energystar)

## Disposal of waste equipment by users



This symbol means do not dispose of your product with your other household waste. Instead, you should protect human health and the environment by handing over your waste equipment to a designated collection point for the recycling of waste electrical and electronic equipment. For more information, please contact your household waste disposal service, or go to <http://www.hp.com/recycle>.

## Chemical substances

HP is committed to providing our customers with information about the chemical substances in our products as needed to comply with legal requirements such as REACH (*Regulation EC No 1907/2006 of the European Parliament and the Council*). A chemical information report for this product can be found at: [www.hp.com/go/reach](http://www.hp.com/go/reach).

## Declaration of the Presence Condition of the Restricted Substances Marking (Taiwan)

### 限用物質含有情況標示聲明書

#### Declaration of the Presence Condition of the Restricted Substances Marking

| 單元 Unit                               | 限用物質及其化學符號                                     |                      |                      |  |  |  |
|---------------------------------------|--|----------------------|----------------------|--|--|--|
|                                       | Restricted substances and its chemical symbols |                      |                      |  |  |  |
|                                       | 鉛<br>Lead<br>(Pb)                              | 汞<br>Mercury<br>(Hg) | 鎘<br>Cadmium<br>(Cd) | 六價鉻<br>Hexavalent<br>chromium<br>(Cr <sup>+6</sup> ) | 多溴聯苯<br>Polybrominated<br>biphenyls<br>(PBB) | 多溴二苯醚<br>Polybrominate<br>d diphenyl<br>ethers<br>(PBDE) |
| 外殼和紙匣<br>(External Casings and Trays) | 0  | 0                    | 0                    | 0  | 0  | 0  |
| 電線 (Cables)                           | 0  | 0                    | 0                    | 0  | 0  | 0  |
| 印刷電路板<br>(Printed Circuit Boards)     | —  | 0                    | 0                    | 0  | 0  | 0  |
| 列印引擎(Print Engine)                    | —  | 0                    | 0                    | 0  | 0  | 0  |
| 列印機組件 (Print Assembly)                | —  | 0                    | 0                    | 0  | 0  | 0  |
| 噴墨印表機墨水匣 (Print Supplies)             | 0  | 0                    | 0                    | 0  | 0  | 0  |
| 列印機配件 (Print Accessory)               | —  | 0                    | 0                    | 0  | 0  | 0  |

備考 1. “超出 0.1 wt %” 及 “超出 0.01 wt %” 係指限用物質之百分比含量超出百分比含量基準值。

Note 1: “Exceeding 0.1 wt %” and “exceeding 0.01 wt %” indicate that the percentage content of the restricted substance exceeds the reference percentage value of presence condition.

備考 2. “0” 係指該項限用物質之百分比含量未超出百分比含量基準值。

Note 2: “0” indicates that the percentage content of the restricted substance does not exceed the percentage of reference value of presence.

備考 3. “—” 係指該項限用物質為排除項目。

Note 3: The “—” indicates that the restricted substance corresponds to the exemption.

若要存取產品的最新使用指南或手冊，請前往 [www.support.hp.com](http://www.support.hp.com)。選取搜尋您的產品，然後依照畫面上的指示繼續執行。

To access the latest user guides or manuals for your product, go to [www.support.hp.com](http://www.support.hp.com). Select **Find your product**, and then follow the onscreen instructions.

## The Table of Hazardous Substances/Elements and their Content (China)

| <b>产品中有毒物质或元素的名称及含量</b><br>根据中国《电子信息产品污染控制管理办法》 |           |           |           |                 |               |                 |
|---|-----------|-----------|-----------|-----------------|---------------|-----------------|
| 部件名称  | 有毒有害物质或元素 |           |           |                 |               |                 |
|   | 铅<br>(Pb) | 汞<br>(Hg) | 镉<br>(Cd) | 六价铬<br>(Cr(VI)) | 多溴联苯<br>(PBB) | 多溴二苯醚<br>(PBDE) |
| 外壳和托盘   | 0         | 0         | 0         | 0               | 0             | 0               |
| 电线  | 0         | 0         | 0         | 0               | 0             | 0               |
| 印刷电路板   | X         | 0         | 0         | 0               | 0             | 0               |
| 打印系统  | X         | 0         | 0         | 0               | 0             | 0               |
| 显示器   | X         | 0         | 0         | 0               | 0             | 0               |
| 喷墨打印机墨盒   | 0         | 0         | 0         | 0               | 0             | 0               |
| 驱动光盘  | X         | 0         | 0         | 0               | 0             | 0               |
| 扫描仪   | X         | X         | 0         | 0               | 0             | 0               |
| 网络配件  | X         | 0         | 0         | 0               | 0             | 0               |
| 电池板   | X         | 0         | 0         | 0               | 0             | 0               |
| 自动双面打印系统  | 0         | 0         | 0         | 0               | 0             | 0               |
| 外部电源  | X         | 0         | 0         | 0               | 0             | 0               |

本表格依据SJ/T 11364 的规定编制。  
 0: 表示该有害物质在该部件所有均质材料中的含量均在GB/T 26572 规定的限量要求以下。  
 X: 表示该有害物质至少在该部件的某一均质材料中的含量超出GB/T 26572 规定的限量要求。

此表中所有名称中含“X”的部件均符合欧盟 RoHS 立法。

注: 环保使用期限的参考标识取决于产品正常工作的温度和湿度等条件。

## Restriction of hazardous substance (Ukraine)

|   |
|---|
| <p><b>Технічний регламент щодо обмеження використання небезпечних речовин (Україна)</b></p> <p>Обладнання відповідає вимогам Технічного регламенту щодо обмеження використання деяких небезпечних речовин в електричному та електронному обладнанні, затвердженого постановою Кабінету Міністрів України від 3 грудня 2008 № 1057</p> |
|---|

## Restriction of hazardous substance (India)

|  |
|--|
| <p><b>Restriction of hazardous substances (India)</b></p> <p>This product complies with the "India E-waste (Management and Handling) Rule 2011" and prohibits use of lead, mercury, hexavalent chromium, polybrominated biphenyls or polybrominated diphenyl ethers in concentrations exceeding 0.1 weight % and 0.01 weight % for cadmium, except for the exemptions set in Schedule 2 of the Rule.</p> |
|--|

## EPEAT

### EPEAT

Most HP products are designed to meet EPEAT. EPEAT is a comprehensive environmental rating that helps identify greener electronics equipment. For more information on EPEAT go to [www.epeat.net](http://www.epeat.net). For information on HP's EPEAT registered products go to [www.hp.com/hpinfo/globalcitizenship/environment/pdf/epeat\\_printers.pdf](http://www.hp.com/hpinfo/globalcitizenship/environment/pdf/epeat_printers.pdf).

## China SEPA Eco Label User Information

### 中国环境标识认证产品用户说明

噪声大于63.0Db(A)的办公设备不宜放置于办公室内，请在独立的隔离区域使用。

如需长时间使用本产品或打印大量文件，请确保在通风良好的房间内使用。

如您需要确认本产品处于零能耗状态，请按下电源关闭按钮，并将插头从电源插座断开。

您可以使用再生纸，以减少资源耗费。



## 复印机、打印机和传真机能源效率标识 实施规则

依据“复印机、打印机和传真机能源效率标识实施规则”，该打印机具有中国能效标识。标识上显示的能效等级和操作模式值根据“复印机、打印机和传真机能效限定值及能效等级”标准（“GB 21521”）来确定和计算。

### 1. 能效等级

产品能效等级分为3级，其中1级能效最高。能效限定值根据产品类型和打印速度由标准确定。能效等级则根据基本功耗水平以及网络接口和内存等附加组件和功能的功率因子之和来计算。

### 2. 能效信息

#### 喷墨打印机

- 操作模式功率

睡眠状态的能耗按照 GB 21521 标准来衡量和计算。该数据以瓦特 (W) 表示。

- 待机功率

待机状态是产品连接到电网电源上功率最低的状态。该状态可以延续无限长时间，且使用者无法改变此状态下产品的功率。对于“成像设备”产品，“待机”状态通常相当于“关闭”状态，但也可能相当于“准备”状态或“睡眠”状态。该数据以瓦特 (W) 表示。

- 睡眠状态预设延迟时间

出厂前由制造商设置的时间决定了该产品在完成主功能后进入低耗模式（例如睡眠、自动关机）的时间。该数据以分钟表示。

- 附加功能功率因子之和

网络接口和内存等附加功能的功率因子之和。该数据以瓦特 (W) 表示。

标识上显示的能耗数据是根据典型配置测量得出的数据，此类配置包含登记备案的打印机依据复印机、打印机和传真机能源效率标识实施规则所选的所有配置。因此，该特定产品型号的实际能耗可能与标识上显示的数据有所不同。

要了解规范的更多详情，请参考最新版的 GB 21521 标准。

## Regulatory notices

The HP DeskJet 3630 series meets product requirements from regulatory agencies in your country/region.

This section contains the following topics:

- [Regulatory model identification number](#)
- [FCC statement](#)
- [Notice to users in Korea](#)
- [VCCI \(Class B\) compliance statement for users in Japan](#)
- [Notice to users in Japan about the power cord](#)
- [Noise emission statement for Germany](#)
- [Visual display workplaces statement for Germany](#)
- [European Union Regulatory Notice](#)
- [Declaration of conformity](#)
- [Regulatory wireless statements](#)

### Regulatory model identification number

For regulatory identification purposes, your product is assigned a Regulatory Model Number. The Regulatory Model Number for your product is SNPRH-1501. This regulatory number should not be confused with the marketing name (HP DeskJet 3630 All-in-One Printer, HP DeskJet Ink Advantage 3635 All-in-One Printer, etc.) or product numbers (F5S43A, F5S43B, F5S44A, F5S44B, F5S44C, etc.).

## FCC statement

### FCC statement

The United States Federal Communications Commission (in 47 CFR 15.105) has specified that the following notice be brought to the attention of users of this product.

This equipment has been tested and found to comply with the limits for a Class B digital device, pursuant to Part 15 of the FCC Rules. These limits are designed to provide reasonable protection against harmful interference in a residential installation. This equipment generates, uses and can radiate radio frequency energy and, if not installed and used in accordance with the instructions, may cause harmful interference to radio communications. However, there is no guarantee that interference will not occur in a particular installation. If this equipment does cause harmful interference to radio or television reception, which can be determined by turning the equipment off and on, the user is encouraged to try to correct the interference by one or more of the following measures:

- Reorient or relocate the receiving antenna.
- Increase the separation between the equipment and the receiver.
- Connect the equipment into an outlet on a circuit different from that to which the receiver is connected.
- Consult the dealer or an experienced radio/TV technician for help.

For further information, contact:

Manager of Corporate Product Regulations  
Hewlett-Packard Company  
3000 Hanover Street  
Palo Alto, Ca 94304  
(650) 857-1501

Modifications (part 15.21)

The FCC requires the user to be notified that any changes or modifications made to this device that are not expressly approved by HP may void the user's authority to operate the equipment.

This device complies with Part 15 of the FCC Rules. Operation is subject to the following two conditions: (1) this device may not cause harmful interference, and (2) this device must accept any interference received, including interference that may cause undesired operation.

## Notice to users in Korea

|                        |  |
|------------------------|--|
| B 급 기기<br>(가정용 방송통신기기) | 이 기기는 가정용(B급)으로 전자파적합등록을 한 기기로서 주로 가정에서 사용하는 것을 목적으로 하며, 모든 지역에서 사용할 수 있습니다. |
|------------------------|--|

## VCCI (Class B) compliance statement for users in Japan

この装置は、クラスB情報技術装置です。この装置は、家庭環境で使用することを目的としていますが、この装置がラジオやテレビジョン受信機に近接して使用されると、受信障害を引き起こすことがあります。取扱説明書に従って正しい取り扱いをして下さい。

VCCI-B

## Notice to users in Japan about the power cord

製品には、同梱された電源コードをお使い下さい。  
同梱された電源コードは、他の製品では使用出来ません。

## Noise emission statement for Germany

### Geräuschemission

LpA < 70 dB am Arbeitsplatz im Normalbetrieb nach DIN 45635 T. 19

## Visual display workplaces statement for Germany

### GS-Erklärung (Deutschland)

Das Gerät ist nicht für die Benutzung im unmittelbaren Gesichtsfeld am Bildschirmarbeitsplatz vorgesehen. Um störende Reflexionen am Bildschirmarbeitsplatz zu vermeiden, darf dieses Produkt nicht im unmittelbaren Gesichtsfeld platziert werden.

## European Union Regulatory Notice



Products bearing the CE marking comply with one or more of the following EU Directives as may be applicable: Low Voltage Directive 2006/95/EC, EMC Directive 2004/108/EC, Ecodesign Directive 2009/125/EC, R&TTE Directive 1999/5/EC, RoHS Directive 2011/65/EU. Compliance with these directives is assessed using applicable European Harmonised Standards. The full Declaration of Conformity can be found at the following website: [www.hp.com/go/certificates](http://www.hp.com/go/certificates) (Search with the product model name or its Regulatory Model Number (RMN), which may be found on the regulatory label.)

The point of contact for regulatory matters is:

Hewlett-Packard GmbH, Dept./MS: HQ-TRE, Herrenberger Strasse 140, 71034 Boeblingen, GERMANY

## Products with wireless functionality

### EMF

- This product meets international guidelines (ICNIRP) for exposure to radio frequency radiation.

If it incorporates a radio transmitting and receiving device that in normal use, a separation distance of 20 cm ensures that radio frequency exposure levels comply with EU requirements.

### Wireless functionality in Europe

- This product is designed for use without restrictions in all EU countries plus Iceland, Liechtenstein, Norway and Switzerland.

## Declaration of conformity



### DECLARATION OF CONFORMITY

according to ISO/IEC 17050-1 and EN 17050-1

**DoC #: SNPRH-1501-R2**

**Supplier's Name:** Hewlett-Packard Company  
**Supplier's Address:** 20, Jia Feng Road Waigaoqiao Free Trade Zone Pudong, Shanghai, PRC 200131  
**declares, that the product**  
**Product Name and Model:** HP DeskJet 3630 All-in-One Printer series  
HP DeskJet Ink Advantage 3630 All-in-One Printer series.  
**Regulatory Model Number:<sup>1)</sup>** SNPRH-1501  
**Radio Module:** SDGOB-1392  
**Product Options:** All  
**conforms to the following Product Specifications and Regulations:**

#### **EMC:**

CISPR 22:2008 Class B  
EN 55022:2010 Class B  
EN 55024:2010  
EN 61000-3-2:2006 +A1:2009 +A2:2009  
EN 61000-3-3:2013  
FCC CFR 47 Part 15 Class B  
ICES-003, Issue 5 Class B

#### **Safety:**

EN 60950-1:2006 +A11:2009 +A1:2010 +A12:2011  
IEC 60950-1:2005 +A1:2009  
EN 62479:2010

#### **Telecom:**

EN 300 328 V1.8.1  
EN 301 489-1 V1.9.2  
EN 301 489-17 V2.2.1  
IEC 62311:2007 / EN 62311:2008

#### **Energy Use:**

Regulation (EC) No. 1275/2008  
ENERGY STAR® Qualified Imaging Equipment Operational Mode (OM) Test Procedure  
EN 50564:2011  
IEC 62301:2005

#### **RoHS:**

EN 50581:2012

The product herewith complies with the requirements of the Low Voltage Directive 2006/95/EC, the EMC Directive 2004/108/EC, the R&TTE Directive 1999/5/EC, the Ecodesign Directive 2009/125/EC, the RoHS Directive 2011/65/EU and carries the **CE** marking accordingly.

This device complies with part 15 of the FCC Rules. Operation is subject to the following two conditions:

(1) This device may not cause harmful interference, and (2) this device must accept any interference received, including interference that may cause undesired operation.

#### **Additional Information:**

- 1) This product is assigned a Regulatory Model Number which stays with the regulatory aspects of the design. The Regulatory Model Number is the main product identifier in the regulatory documentation and test reports, this number should not be confused with the marketing name or the product numbers.

Shen HongBo

2014

ICS Product Hardware Quality Engineering, Manager

#### **Local contact for regulatory topics only:**

EU: Hewlett-Packard GmbH, HQ-TRE, Herrenberger Strasse 140, 71034 Boeblingen, Germany  
U.S.: Hewlett-Packard, 3000 Hanover St., Palo Alto, CA 94304, U.S.A. 650-857-1501

[www.hp.eu/certificates](http://www.hp.eu/certificates)

## Regulatory wireless statements

This section contains the following regulatory information pertaining to wireless products:

- [Exposure to radio frequency radiation](#)
- [Notice to users in Brazil](#)
- [Notice to users in Canada](#)
- [Notice to users in Mexico](#)
- [Notice to users in Taiwan](#)
- [Notice to users in Japan](#)
- [Notice to users in Korea](#)

### Exposure to radio frequency radiation

#### Exposure to radio frequency radiation



**Caution** The radiated output power of this device is far below the FCC radio frequency exposure limits. Nevertheless, the device shall be used in such a manner that the potential for human contact during normal operation is minimized. This product and any attached external antenna, if supported, shall be placed in such a manner to minimize the potential for human contact during normal operation. In order to avoid the possibility of exceeding the FCC radio frequency exposure limits, human proximity to the antenna shall not be less than 20 cm (8 inches) during normal operation.

### Notice to users in Brazil

#### Aviso aos usuários no Brasil

Este equipamento opera em caráter secundário, isto é, não tem direito à proteção contra interferência prejudicial, mesmo de estações do mesmo tipo, e não pode causar interferência a sistemas operando em caráter primário.



## Notice to users in Canada

### **Notice to users in Canada/Note à l'attention des utilisateurs canadiens**

Under Industry Canada regulations, this radio transmitter may only operate using an antenna of a type and maximum (or lesser) gain approved for the transmitter by Industry Canada. To reduce potential radio interference to other users, the antenna type and its gain should be so chosen that the equivalent isotropically radiated power (e.i.r.p.) is not more than that necessary for successful communication.

This device complies with Industry Canada licence-exempt RSS standard(s). Operation is subject to the following two conditions: (1) this device may not cause interference, and (2) this device must accept any interference, including interference that may cause undesired operation of the device.

**WARNING!** Exposure to Radio Frequency Radiation The radiated output power of this device is below the Industry Canada radio frequency exposure limits. Nevertheless, the device should be used in such a manner that the potential for human contact is minimized during normal operation.

To avoid the possibility of exceeding the Industry Canada radio frequency exposure limits, human proximity to the antennas should not be less than 20 cm (8 inches).

Conformément au Règlement d'Industrie Canada, cet émetteur radioélectrique ne peut fonctionner qu'avec une antenne d'un type et d'un gain maximum (ou moindre) approuvé par Industrie Canada. Afin de réduire le brouillage radioélectrique potentiel pour d'autres utilisateurs, le type d'antenne et son gain doivent être choisis de manière à ce que la puissance isotrope rayonnée équivalente (p.i.r.e.) ne dépasse pas celle nécessaire à une communication réussie.

Cet appareil est conforme aux normes RSS exemptes de licence d'Industrie Canada. Son fonctionnement dépend des deux conditions suivantes : (1) cet appareil ne doit pas provoquer d'interférences nuisibles et (2) doit accepter toutes interférences reçues, y compris des interférences pouvant provoquer un fonctionnement non souhaité de l'appareil.

**AVERTISSEMENT** relatif à l'exposition aux radiofréquences. La puissance de rayonnement de cet appareil se trouve sous les limites d'exposition de radiofréquences d'Industrie Canada. Néanmoins, cet appareil doit être utilisé de telle sorte qu'il soit mis en contact le moins possible avec le corps humain.

Afin d'éviter le dépassement éventuel des limites d'exposition aux radiofréquences d'Industrie Canada, il est recommandé de maintenir une distance de plus de 20 cm entre les antennes et l'utilisateur.

## Notice to users in Mexico

### **Aviso para los usuarios de México**

La operación de este equipo está sujeta a las siguientes dos condiciones: (1) es posible que este equipo o dispositivo no cause interferencia perjudicial y (2) este equipo o dispositivo debe aceptar cualquier interferencia, incluyendo la que pueda causar su operación no deseada.

Para saber el modelo de la tarjeta inalámbrica utilizada, revise la etiqueta regulatoria de la impresora.

## Notice to users in Taiwan

### 低功率電波輻射性電機管理辦法

#### 第十二條

經型式認證合格之低功率射頻電機，非經許可，公司、商號或使用者均不得擅自變更頻率、加大功率或變更設計之特性及功能。

#### 第十四條

低功率射頻電機之使用不得影響飛航安全及干擾合法通信；經發現有干擾現象時，應立即停用，並改善至無干擾時方得繼續使用。

前項合法通信，指依電信法規定作業之無線電通信。低功率射頻電機須忍受合法通信或工業、科學及醫藥用電波輻射性電機設備之干擾。

## Notice to users in Japan

この機器は技術基準適合証明又は工事設計認証を受けた無線設備を搭載しています。

## Notice to users in Korea

해당 무선설비는 전파혼신 가능성이 있으므로 인명안전과 관련된 서비스는 할 수 없음



---

# Index

## B

buttons, control panel 5

## C

carriage

clear carriage jams 83

control panel

buttons 5

features 5

status icons 6

copy

specifications 108

customer support

warranty 103

## E

embedded web server

opening 76

Webscan 52

environment

Environmental product

stewardship program 109

environmental specifications

107

## J

jams

clear 80

## M

multi-feeds, troubleshoot 84

## N

network connection

wireless connection 66

networks

view and print settings 73

## O

operating systems supported 107

## P

paper

clear jams 80

HP, order 22

skewed pages 84

troubleshoot feeding 84

paper-feed problems, troubleshoot

84

power

troubleshoot 100

print

specifications 108

troubleshoot 100

printer software (Windows)

opening 23

## R

recycle

ink cartridges 110

regulatory notices 116

regulatory model identification

number 116

wireless statements 120

## S

scan

from Webscan 52

scan specifications 108

skew, troubleshoot

print 84

software

Webscan 52

specifications

system requirements 107

status icons 6

system requirements 107

## T

technical information

copy specifications 108

environmental specifications

107

print specifications 108

scan specifications 108

trays

clear paper jams 80

troubleshoot feeding 84

troubleshoot

multiple pages are picked 84

paper not picked up from tray

84

paper-feed problems 84

power 100

print 100

skewed pages 84

## V

view

network settings 73

## W

warranty 103

Webscan 52

Windows

system requirements 107

