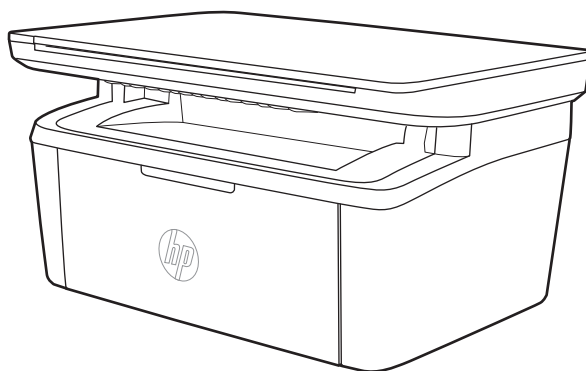




# LaserJet Pro MFP M28-M31

## User Guide



[www.hp.com/support/ljM28MFP](http://www.hp.com/support/ljM28MFP)





HP LaserJet Pro MFP M28-M31

User Guide

## Copyright and License

© Copyright 2018 HP Development Company, L.P.

Reproduction, adaptation, or translation without prior written permission is prohibited, except as allowed under the copyright laws.

The information contained herein is subject to change without notice.

The only warranties for HP products and services are set forth in the express warranty statements accompanying such products and services. Nothing herein should be construed as constituting an additional warranty. HP shall not be liable for technical or editorial errors or omissions contained herein.

Edition 4, 01/2019

## Trademark Credits

Adobe®, Adobe Photoshop®, Acrobat®, and PostScript® are trademarks of Adobe Systems Incorporated.

Apple and the Apple logo are trademarks of Apple Inc., registered in the U.S. and other countries.

OS X is a trademark of Apple Inc., registered in the U.S. and other countries.

AirPrint is a trademark of Apple Inc., registered in the U.S. and other countries.

iPad is a trademark of Apple Inc., registered in the U.S. and other countries.

iPod is a trademark of Apple Inc., registered in the U.S. and other countries.

iPhone is a trademark of Apple Inc., registered in the U.S. and other countries.

Microsoft® and Windows® are U.S. registered trademarks of Microsoft Corporation.

UNIX® is a registered trademark of The Open Group.

---

# Table of contents

<b>1 Printer overview</b> .....	<b>1</b>
Warning icons .....	2
Printer views .....	3
Printer front view .....	3
Printer back view .....	3
Control panel view .....	4
Wireless models .....	4
Base models .....	5
Printer specifications .....	6
Technical specifications .....	6
Supported operating systems .....	6
Mobile printing solutions .....	7
Printer dimensions .....	8
Power consumption, electrical specifications, and acoustic emissions .....	8
Operating-environment range .....	8
Printer hardware setup and software installation .....	9
<b>2 Paper trays</b> .....	<b>11</b>
Introduction .....	12
Load paper trays .....	12
Input tray .....	12
Load and print envelopes .....	13
Introduction .....	13
Print envelopes .....	13
Envelope orientation .....	13
Load and print labels .....	14
Introduction .....	14
Manually feed labels .....	14
Label orientation .....	14

<b>3 Supplies, accessories, and parts</b> .....	<b>15</b>
Order supplies, accessories, and parts .....	16
Ordering .....	16
Supplies and accessories .....	16
Replace the toner cartridge .....	17
Cartridge information .....	17
Remove and replace the toner cartridge .....	17
<b>4 Print</b> .....	<b>21</b>
Print tasks (Windows) .....	22
How to print (Windows) .....	22
Manually print on both sides (Windows) .....	23
Print multiple pages per sheet (Windows) .....	23
Select the paper type (Windows) .....	24
Print tasks (OS X) .....	25
How to print (OS X) .....	25
Manually print on both sides (OS X) .....	25
Print multiple pages per sheet (OS X) .....	25
Select the paper type (OS X) .....	26
Mobile printing .....	27
Introduction .....	27
Wi-Fi Direct (wireless models only) .....	27
Enable or disable Wi-Fi Direct .....	28
Change the printer Wi-Fi Direct name .....	29
AirPrint .....	29
Android embedded printing (wireless models only) .....	30
<b>5 Copy</b> .....	<b>31</b>
Make a copy .....	32
Copy identification card .....	33
<b>6 Scan</b> .....	<b>35</b>
Scan by using the HP Scan software (Windows) .....	36
Scan by using the HP Easy Scan Software (OS X) .....	37
Additional scan tasks .....	38
<b>7 Manage the printer</b> .....	<b>39</b>
Change the printer connection type (Windows) .....	40
Advanced configuration with HP Embedded Web Server (EWS) and HP Device Toolbox (Windows) .....	41
Advanced configuration with HP Utility for OS X .....	43

Open HP Utility .....	43
HP Utility features .....	43
Configure IP network settings .....	45
Introduction .....	45
Printer sharing disclaimer .....	45
View or change network settings .....	45
Manually configure IPv4 TCP/IP parameters .....	45
Printer security features .....	47
Introduction .....	47
Assign or change the system password using the HP Embedded Web Server .....	47
Energy-conservation settings .....	49
Introduction .....	49
Set the Sleep/Auto Off After Inactivity setting .....	49
Set the Shut Down After Inactivity delay and configure the printer to use 1 watt or less of power ....	50
Set the Delay Shut Down setting .....	51
Update the firmware .....	52
Update the firmware using the Firmware Update Utility .....	52
<b>8 Solve problems .....</b>	<b>53</b>
Customer support .....	54
Laser Warning .....	55
Interpret control-panel light patterns .....	56
Restore the factory-set defaults .....	60
A “Cartridge is low” or “Cartridge is very low” message displays .....	61
Change the “Very Low” settings .....	61
Order supplies .....	62
Printer does not pick up paper or misfeeds .....	63
Introduction .....	63
The product does not pick up paper .....	63
The product picks up multiple sheets of paper .....	63
Clear paper jams .....	64
Introduction .....	64
Jam locations .....	64
Experiencing frequent or recurring paper jams? .....	65
Clear jams from the input tray .....	67
Clear jams from inside the product .....	69
Clear jams from the output areas .....	71
Improve print quality .....	73
Introduction .....	73
Update the printer firmware .....	73
Print from a different software program .....	73

Check the paper-type setting for the print job .....	74
Check the paper type setting on the printer .....	74
Check the paper type setting (Windows) .....	74
Check the paper type setting (OS X) .....	74
Check toner-cartridge status .....	74
Cartridge cleaning .....	75
Print a cleaning page .....	76
Visually inspect the toner cartridge .....	76
Check paper and the printing environment .....	76
Step one: Use paper that meets HP specifications .....	76
Step two: Check the environment .....	77
Adjust Print Density .....	77
Resolving print quality problems .....	79
Introduction .....	79
Troubleshoot print quality problems .....	79
Improve copy and scan image quality .....	87
Introduction .....	87
Check the scanner glass for dirt and smudges .....	87
Check the paper settings .....	87
Optimize for text or pictures .....	89
Edge-to-edge copying .....	89
Solve wireless network problems .....	90
Introduction .....	90
Wireless connectivity checklist .....	90
The printer does not print after the wireless configuration completes .....	91
The printer does not print, and the computer has a third-party firewall installed .....	91
The wireless connection does not work after moving the wireless router or printer .....	91
Cannot connect more computers to the wireless printer .....	91
The wireless printer loses communication when connected to a VPN .....	92
The network does not appear in the wireless networks list .....	92
The wireless network is not functioning .....	92
Perform a wireless network diagnostic test .....	92
Reduce interference on a wireless network .....	93
<b>Index .....</b>	<b>95</b>



---

# 1 Printer overview

- [Warning icons](#)
- [Printer views](#)
- [Printer specifications](#)
- [Printer hardware setup and software installation](#)

## For more information:

In the US, go to [www.hp.com/support/ljM28MFP](http://www.hp.com/support/ljM28MFP).

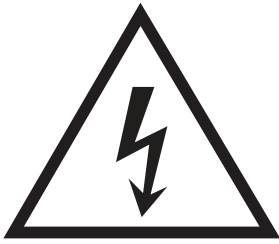
Outside the US, go to [www.hp.com/support](http://www.hp.com/support). Select your country/region. Click **Product Support & Troubleshooting**. Enter the product name, and then select **Search**.

HP's all-inclusive help for your product includes the following information:

- Install and configure
- Learn and use
- Solve problems
- Download software updates
- Join support forums
- Find warranty and regulatory information

## Warning icons

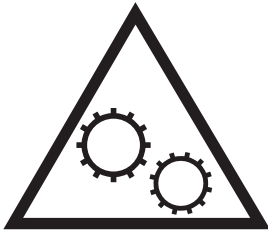
Warning icon definitions: The following warning icons may appear on HP products. Apply appropriate caution where applicable.



• Caution: Electric shock



• Caution: Hot surface



• Caution: Keep body parts away from moving parts

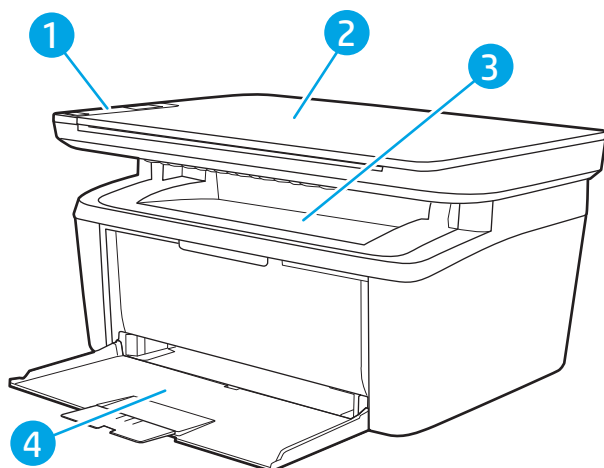


• Caution: Sharp edge in close proximity

## Printer views

- [Printer front view](#)
- [Printer back view](#)
- [Control panel view](#)

### Printer front view

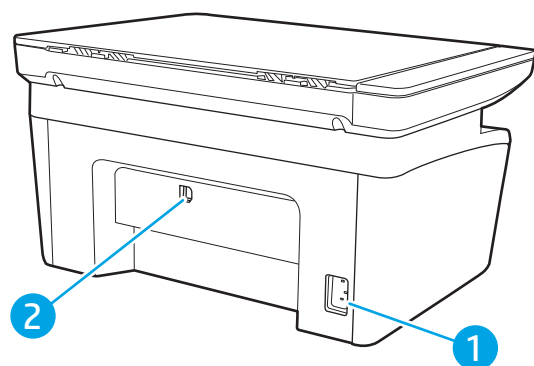


---

1	Control panel
2	Flatbed scanner
3	Output bin
4	Input tray

---

### Printer back view



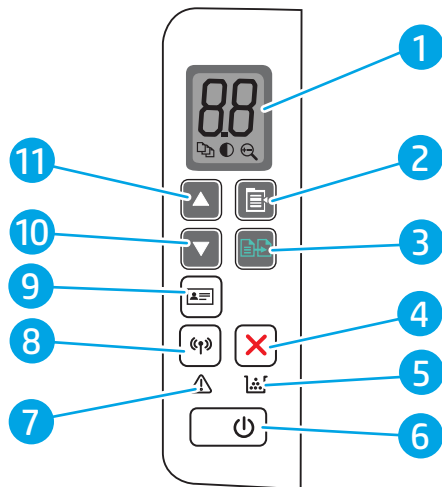
---





1	Power connection
2	USB interface port

---

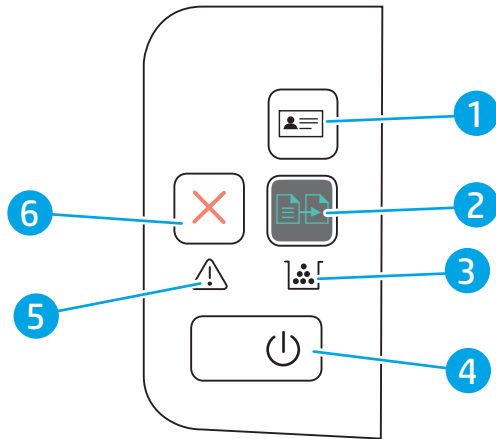
## Control panel view


### Wireless models




1	Control panel LED display	The control panel LED display shows numerical information for copy settings and event codes.
2	Copy Setup button	Use this button to navigate through the Number of Copies, Lighter/Darker, and Reduce/Enlarge options. The default option is Number of Copies.
3	Start Copy button	Use this button to start a copy job. Or, in manual duplex mode, use this button to print the second side of the page.
4	Cancel  button	Press this button to cancel a job.
5	Supplies LED	A Supplies light blinks when a supply error occurs, and it glows without blinking when the supply is very low and replacement is required.
6	Power button/Ready LED	<ul style="list-style-type: none"> <li>Use this button to turn the printer on or off.</li> <li>The Ready light is on when the printer is ready to print. It blinks when the printer is receiving print data and dims when the printer is in a low-power state.</li> </ul>
7	Attention LED	The Attention light blinks when the printer requires user attention. If the Attention light is on, the printer is in an error state.
8	Wireless  button and LED (wireless models only)	<p>Press this button to turn the wireless feature on or off, or to configure a WiFi Direct connection.</p> <p>Press and hold this button to configure a WPS connection.</p> <p>If the wireless LED light is on, there is a stable wireless connection. If it is blinking, there is currently no wireless connection, or there is either a WPS or WiFi Direct configuration process in progress. If it is blinking rapidly, there is an issue with the wireless connection.</p>
9	ID Copy button	Use this button to copy an identification card.
10	Down Arrow  button	Use this button to decrease the value that appears on the display.
11	Up Arrow  button	Use this button to increase the value that appears on the display.

## Base models



1	Copy ID button (HP LaserJet Pro MFP M29 only)	Use this button to copy an identification card.
2	Start Copy button	Use this button to start a copy job.
3	Supplies LED	A Supplies light blinks when a supply error occurs, and it glows without blinking when the supply is very low and replacement is required.
4	Power button/Ready LED	<ul style="list-style-type: none"> <li>Use this button to turn the printer on or off.</li> <li>The Ready light is on when the printer is ready to print. It blinks when the printer is receiving print data and dims when the printer is in a low-power state.</li> </ul>
5	Attention LED	The Attention light blinks when the printer requires user attention. If the Attention light is on, the printer is in an error state.
6	Cancel  button	Press this button to cancel a job.

# Printer specifications

 **IMPORTANT:** The following specifications are correct at the time of publication, but they are subject to change. For current information, see [www.hp.com/support/ljM28MFP](http://www.hp.com/support/ljM28MFP).

- [Technical specifications](#)
- [Supported operating systems](#)
- [Mobile printing solutions](#)
- [Printer dimensions](#)
- [Power consumption, electrical specifications, and acoustic emissions](#)
- [Operating-environment range](#)

## Technical specifications

See [www.hp.com/support/ljM28MFP](http://www.hp.com/support/ljM28MFP) for current information.

## Supported operating systems

The following information applies to the printer-specific Windows and HP print drivers for OS X and to the software installer.

**Windows:** The HP Software Installer installs the PCLmS, or PCLm-S driver depending on the Windows operating system along with optional software when using the full software installer. See the software installation notes for more information.

**OS X:** Mac computers are supported with this printer. Download HP Easy Start either from [123.hp.com/LaserJet](http://123.hp.com/LaserJet) or from the Printer Support page, and then use HP Easy Start to install the HP print driver. HP Easy Start is not included in the HP Software Installer.

1. Go to [123.hp.com/LaserJet](http://123.hp.com/LaserJet).
2. Follow the steps provided to download the printer software.


**Linux:** For information and print drivers for Linux, go to [www.hp.com/go/linuxprinting](http://www.hp.com/go/linuxprinting).

**Table 1-1** Supported operating systems and print drivers

Windows 7, 32-bit and 64-bit	The HP PCLmS printer-specific print driver is installed for this operating system as part of the software installation.	
Windows 8, 32-bit and 64-bit	The HP PCLmS printer-specific print driver is installed for this operating system as part of the software installation.	Windows 8 RT support is provided through Microsoft IN OS Version 4, 32-bit driver.
Windows 8.1, 32-bit and 64-bit	The HP PCLm-S printer-specific print driver is installed for this operating system as part of the software installation.	Windows 8.1 RT support is provided through Microsoft IN OS Version 4, 32-bit driver.
Windows 10, 32-bit and 64-bit	The HP PCLm-S printer-specific print driver is installed for this operating system as part of the software installation.	


**Table 1-1 Supported operating systems and print drivers (continued)**

Windows Server 2008 R2, 64-bit	The HP PCLm.S printer-specific print driver is available for download from the printer-support website. Download the driver, and then use the Microsoft Add Printer tool to install it.	Microsoft retired mainstream support for Windows Server 2008 in January 2015. HP will continue to provide best effort support for the discontinued Server 2008 operating system.
Windows Server 2008 R2, SP1, 64-bit	The HP PCLm.S printer-specific print driver is installed for this operating system as part of the software installation.	
Windows Server 2012	The HP PCLm.S printer-specific print driver is installed for this operating system as part of the software installation.	
Windows Server 2012 R2	The HP PCLm-S printer-specific print driver is installed for this operating system as part of the software installation.	
Windows Server 2016, 64-bit	The HP PCLm.S printer-specific print driver is installed for this operating system as part of the software installation.	
OS X 10.11 El Capitan, OS X 10.12 Sierra, OS X 10.13	To install the print driver, download HP Easy Start from <a href="http://123.hp.com/LaserJet">123.hp.com/LaserJet</a> . Follow the steps provided to install the printer software and print driver.	

 **NOTE:** For a current list of supported operating systems, go to [www.hp.com/support/ljM28MFP](http://www.hp.com/support/ljM28MFP) for HP's all-inclusive help for the printer.

## Mobile printing solutions

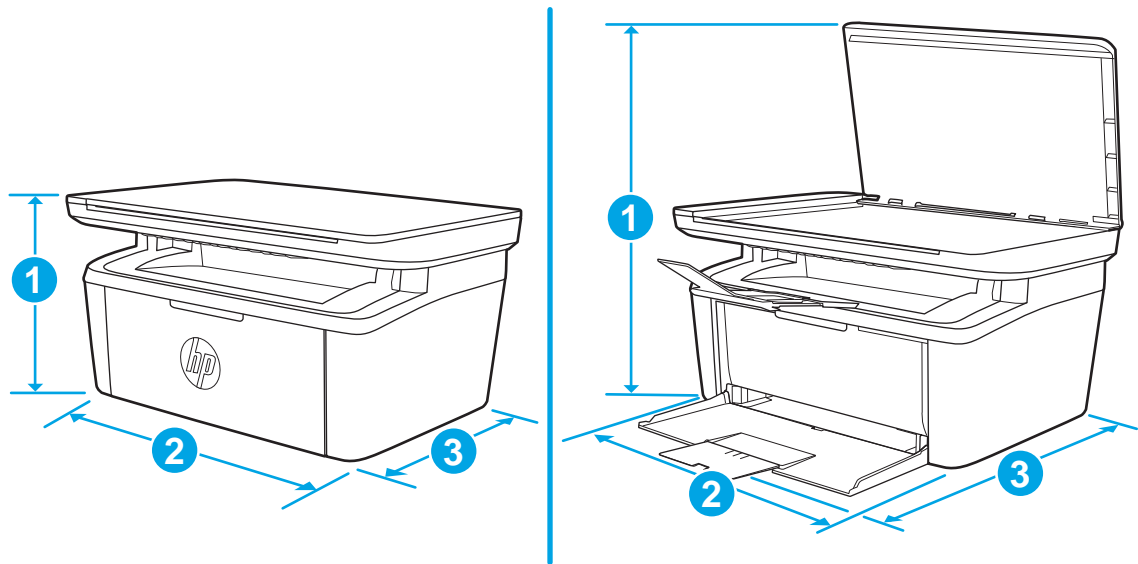
HP offers multiple mobile solutions to enable easy printing to an HP printer from a laptop, tablet, smartphone, or other mobile device. To see the full list and to determine the best choice, go to [www.hp.com/go/LaserJetMobilePrinting](http://www.hp.com/go/LaserJetMobilePrinting).

 **NOTE:** Update the printer firmware to ensure all mobile printing are supported.

- Wi-Fi Direct (wireless models only)
- HP All-in-One Remote app for iOS and Android devices
- Google Cloud Print
- AirPrint
- Android Printing

## Printer dimensions

Figure 1-1 Dimensions for the printer



	Printer fully closed	Printer fully open
1. Height	196 mm (7.7 in)	447 mm (17.6 in)
2. Width	360 mm (14.2 in)	360 mm (14.2 in)
3. Depth	263 mm (10.4 in)	390 mm (15.4 in)
Weight (with cartridges)	5.3 kg (11.7 lb)	

## Power consumption, electrical specifications, and acoustic emissions

See [www.hp.com/support/ljM28MFP](http://www.hp.com/support/ljM28MFP) for current information.

**⚠ CAUTION:** Power requirements are based on the country/region where the printer is sold. Do not convert operating voltages. This will damage the printer and void the printer warranty.

## Operating-environment range

Environment	Recommended	Allowed
Temperature	15° to 27°C (59° to 80.6°F)	15° to 30°C (59° to 86°F)
Relative humidity	20% to 70% relative humidity (RH), non-condensing	10% to 80% (RH), non-condensing



## Printer hardware setup and software installation

For basic setup instructions, see the Setup Poster and Getting Started Guide that came with the printer. For additional instructions, go to HP support on the Web.

Go to [www.hp.com/support/ljM28MFP](http://www.hp.com/support/ljM28MFP) for HP's all-inclusive help for the printer. Find the following support:

- Install and configure
- Learn and use
- Solve problems
- Download software and firmware updates
- Join support forums
- Find warranty and regulatory information



---

## 2 Paper trays

- [Introduction](#)
- [Load paper trays](#)
- [Load and print envelopes](#)
- [Load and print labels](#)

### For more information:


The following information is correct at the time of publication. For current information, see [www.hp.com/support/ljM28MFP](http://www.hp.com/support/ljM28MFP).

HP's all-inclusive help for the printer includes the following information:

- Install and configure
- Learn and use
- Solve problems
- Download software and firmware updates
- Join support forums
- Find warranty and regulatory information

## Introduction

---


 **CAUTION:** Keep hands out of paper trays when closing.

All trays must be closed when moving the printer.

---

## Load paper trays


---

 **NOTE:** To avoid paper jams:

- Never add or remove paper from the tray during printing.
  - Before loading the tray, remove all of the paper from the input tray and straighten the stack.
  - When loading the tray, do not fan the paper.
  - Use paper that is not wrinkled, folded, or damaged.
- 

## Input tray

Load media with the top forward and the side to be printed on facing up. To prevent jams and skewing, always adjust the side media guide.

 **NOTE:** When you add new media, make sure that you remove all of the media from the input tray and straighten the entire stack. This helps prevent multiple sheets of media from feeding through the product at one time, reducing media jams.

---

# Load and print envelopes

## Introduction


The following information describes how to print and load envelopes. Tray 1 holds up to 5 envelopes.

To print envelopes using the manual feed option, follow these steps to select the correct settings in the print driver, and then load the envelopes into the tray after sending the print job to the printer.

## Print envelopes

1. From the software program, select the **Print** option.
2. Select the printer from the list of printers, and then click or tap the **Properties** or **Preferences** button to open the print driver.

 **NOTE:** The name of the button varies for different software programs.

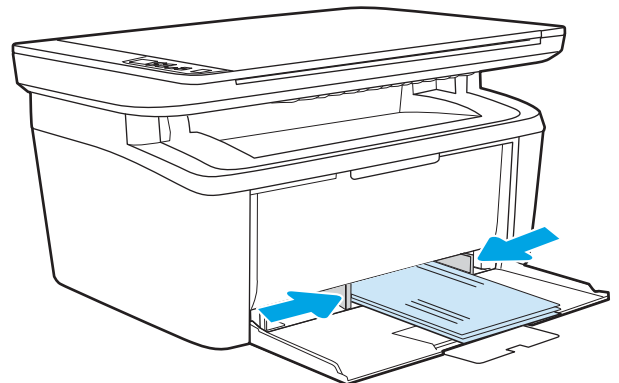
 **NOTE:** In Windows 10, 8.1, and 8, these applications will have a different layout with different features than what is described below for desktop applications. To access the print feature from a Start screen app, complete the following steps:

- **Windows 10:** Select **Print**, and then select the printer.
- **Windows 8 or 8.1:** Select **Devices**, select **Print**, and then select the printer.

3. Click or tap the **Paper/Quality** tab.
4. In the **Media** drop-down list, select **Envelope**.
5. Click the **OK** button to close the **Document Properties** dialog box.
6. In the **Print** dialog box, click the **OK** button to print the job.

## Envelope orientation

Tray	Envelope size	How to load envelopes
Tray 1	Envelope #10, Envelope C5, Envelope DL	Face up Short, postage end toward the back of the tray



# Load and print labels

## Introduction

The following information describes how to print and load labels. Tray 1 holds up to 50 sheets of labels.


To print labels using the manual feed option, follow these steps to select the correct settings in the print driver, and then load the labels into the tray after sending the print job to the printer. When using manual feed, the printer waits to print the job until it detects that the tray has been opened.

## Manually feed labels

1. From the software program, select the **Print** option.
2. Select the printer from the list of printers, and then click or tap the **Properties** or **Preferences** button to open the print driver.

---

 **NOTE:** The name of the button varies for different software programs.

 **NOTE:** In Windows 10, 8.1, and 8, these applications will have a different layout with different features than what is described below for desktop applications. To access the print feature from a Start screen app, complete the following steps:

- **Windows 10:** Select **Print**, and then select the printer.
- **Windows 8 or 8.1:** Select **Devices**, select **Print**, and then select the printer.

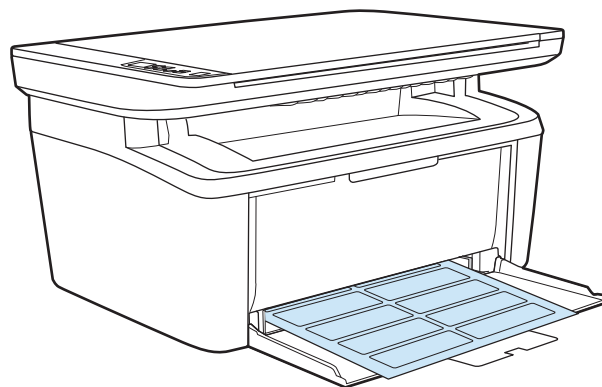
3. Click the **Paper/Quality** tab.
4. In the **Media** drop-down list, select **Labels**.
5. Click the **OK** button to close the **Document Properties** dialog box.
6. In the **Print** dialog box, click the **OK** button to print the job.

## Label orientation

---

Tray	How to load labels
Tray 1	Face-up Top edge toward the back of the tray

---



---

## 3 Supplies, accessories, and parts

- [Order supplies, accessories, and parts](#)
- [Replace the toner cartridge](#)

### For more information:

The following information is correct at the time of publication. For current information, see [www.hp.com/support/ljM28MFP](http://www.hp.com/support/ljM28MFP).

HP's all-inclusive help for the printer includes the following information:

- Install and configure
- Learn and use
- Solve problems
- Download software and firmware updates
- Join support forums
- Find warranty and regulatory information

# Order supplies, accessories, and parts

## Ordering

Order supplies and paper	<a href="http://www.hp.com/go/suresupply">www.hp.com/go/suresupply</a>
Order genuine HP parts or accessories	<a href="http://www.hp.com/buy/parts">www.hp.com/buy/parts</a>
Order through service or support providers	Contact an HP-authorized service or support provider.
Order using the HP Embedded Web Server (EWS)	To access, in a supported Web browser on the computer, enter the printer IP address or host name in the address/URL field. The EWS contains a link to the HP SureSupply Web site, which provides options for purchasing Original HP supplies.

## Supplies and accessories

Item	Description	Cartridge number	Part number
<b>Supplies</b>			
<b>For use only in Europe, Russia, CIS, Mid East and Africa</b>			
HP 44A Black Toner Cartridge	Standard-capacity replacement black toner cartridge	44A	CF244A
<b>For use only in North America, Latin America, Asia Pacific Countries/Regions (Exclude China, India)</b>			
HP 48A Black Toner Cartridge	Standard-capacity replacement black toner cartridge	48A	CF248A
<b>For use only in China, India</b>			
HP 47A Black Toner Cartridge	Standard-capacity replacement black toner cartridge	47A	CF247A



# Replace the toner cartridge

## Cartridge information

Continue printing with the current cartridge until redistributing the toner no longer yields acceptable print quality. To redistribute the toner, remove the toner cartridge from the printer and gently rock the cartridge back and forth about its horizontal axis. For graphical representation, see cartridge replacement instructions. Reinsert the toner cartridge into the printer and close the cover.

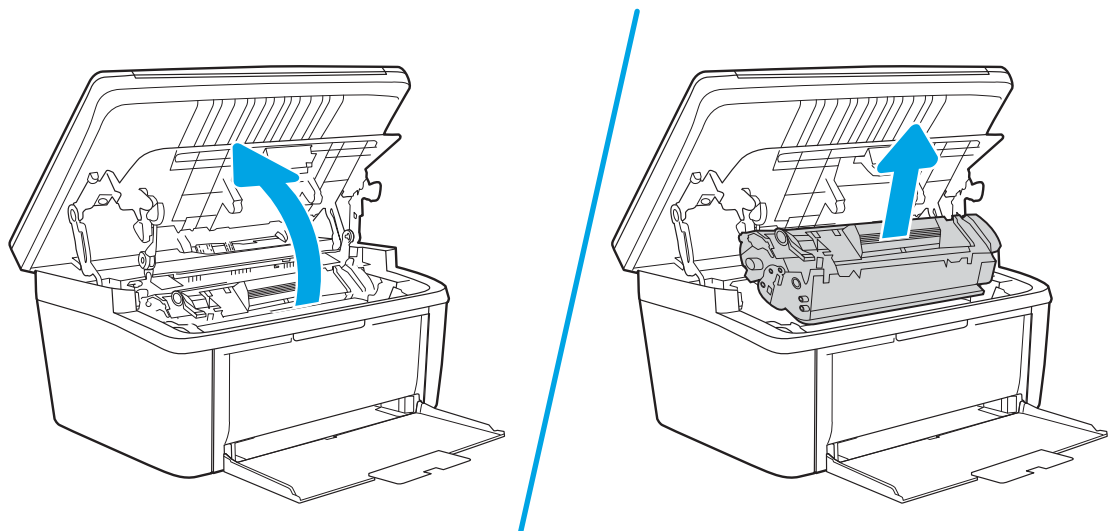
Item	Description	Cartridge number	Part number
<b>Supplies</b>			
<b>For use only in Europe, Russia, CIS, Mid East and Africa</b>			
HP 44A Black Toner Cartridge	Standard-capacity replacement black toner cartridge	44A	CF244A
<b>For use only in North America, Latin America, Asia Pacific Countries/Regions (Exclude China, India)</b>			
HP 48A Black Toner Cartridge	Standard-capacity replacement black toner cartridge	48A	CF248A
<b>For use only in China, India</b>			
HP 47A Black Toner Cartridge	Standard-capacity replacement black toner cartridge	47A	CF247A

Continue printing with the current cartridge until redistributing the toner no longer yields acceptable print quality. To redistribute the toner, remove the toner cartridge from the printer and gently rock the cartridge back and forth about its horizontal axis. For graphical representation, see cartridge replacement instructions. Reinsert the toner cartridge into the printer and close the cover.

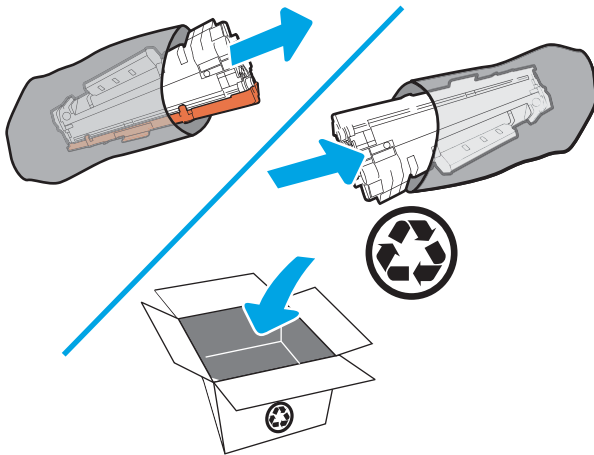
## Remove and replace the toner cartridge

When a print cartridge approaches the end of useful life, you can continue printing with the current cartridge until redistributing the toner no longer yields acceptable print quality.

1. Open the print-cartridge door, and then remove the old print cartridge.

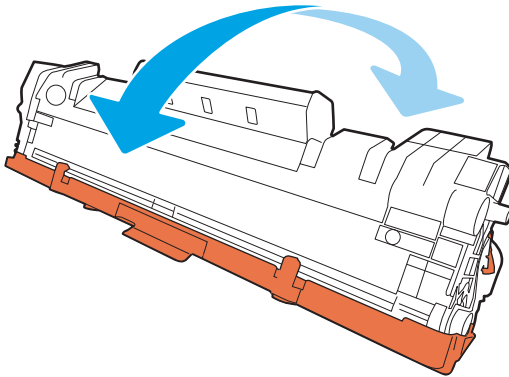


2. Remove the new print cartridge from the packaging. Place the used print cartridge in the bag and box for recycling.

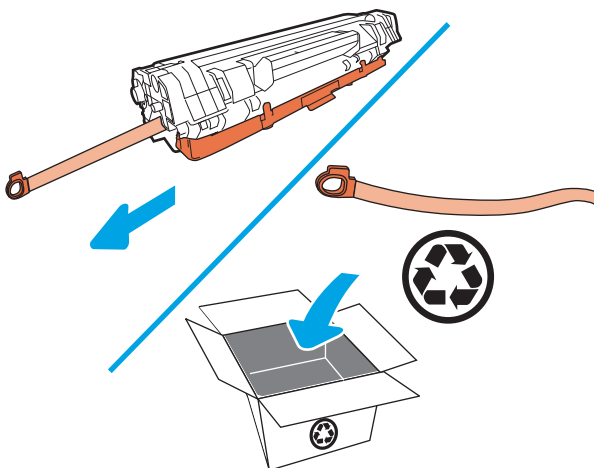


**⚠ CAUTION:** To prevent damage to the print cartridge, hold the print cartridge at each end. Do not touch the OPC cover or the roller surface.

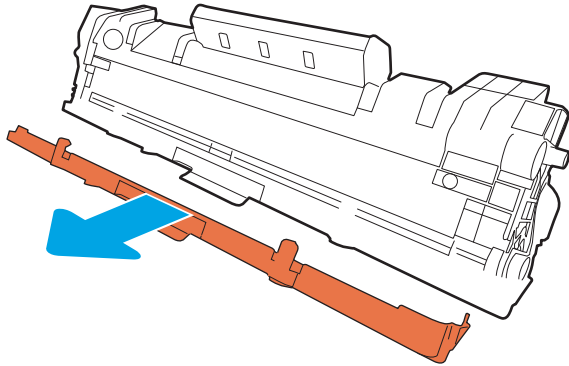
3. Grasp both sides of the print cartridge and gently rock the print cartridge to distribute the toner evenly inside the cartridge.



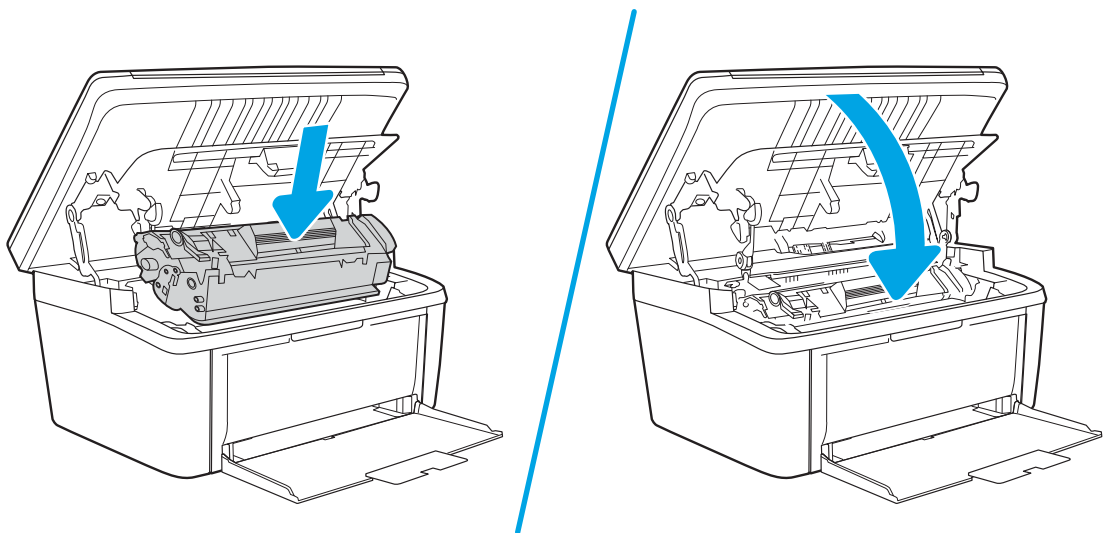
4. Bend the tab on the left side of the cartridge until the tab breaks loose, and then pull the tab until all the tape is removed from the cartridge. Place the tab and tape in the print-cartridge box to return for recycling.



5. Remove the orange cover from the print cartridge.



6. Insert the print cartridge in the product, and then close the print-cartridge door.



**⚠ CAUTION:** If toner gets on your clothing, wipe it off with a dry cloth and wash the clothing in cold water. *Hot water sets toner into the fabric.*



---

## 4 Print

- [Print tasks \(Windows\)](#)
- [Print tasks \(OS X\)](#)
- [Mobile printing](#)


### For more information:

The following information is correct at the time of publication. For current information, see [www.hp.com/support/ljM28MFP](http://www.hp.com/support/ljM28MFP).

HP's all-inclusive help for the printer includes the following information:

- Install and configure
- Learn and use
- Solve problems
- Download software and firmware updates
- Join support forums
- Find warranty and regulatory information

---

 **NOTE:** When the Attention and Ready lights are blinking, the printer is initializing, cleaning, or cooling down. When the printer is cooling down print jobs might pause. Print jobs will continue when the engine is ready. This might take several minutes.

To provide productive printing, this HP LaserJet Pro may automatically enter cool down mode under certain environmental conditions when required.

---

# Print tasks (Windows)


## How to print (Windows)

The following procedure describes the basic printing process for Windows.

1. From the software program, select the **Print** option.
2. Select the printer from the list of printers. To change settings, click or tap the **Properties** or **Preferences** button to open the print driver.

---

 **NOTE:** The name of the button varies for different software programs.

 **NOTE:** In Windows 10, 8.1, and 8, these applications will have a different layout with different features from what is described below for desktop applications. To access the print feature from a Start screen app, complete the following steps:

- **Windows 10:** Select **Print**, and then select the printer.
  - **Windows 8.1 or 8:** Select **Devices**, select **Print**, and then select the printer.
- 
3. Click or tap the tabs in the print driver to configure the available options.
  4. Click or tap the **OK** button to return to the **Print** dialog box. Select the number of copies to print from this screen.
  5. Click or tap the **OK** button to print the job.


## Manually print on both sides (Windows)

Use this procedure for printers that do not have an automatic duplexer installed or to print on paper that the duplexer does not support.

1. From the software program, select the **Print** option.
2. Select the printer from the list of printers, and then click or tap the **Properties** or **Preferences** button to open the print driver.

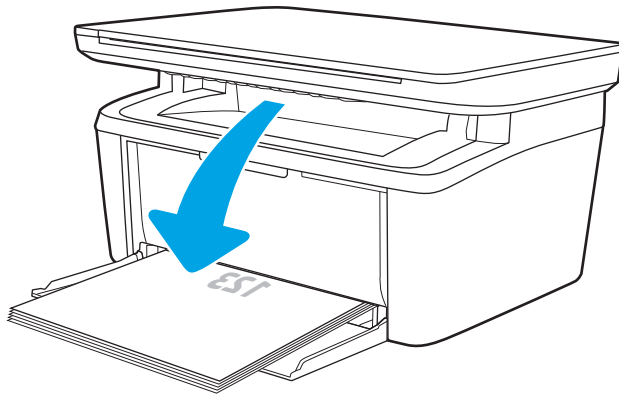
---

 **NOTE:** The name of the button varies for different software programs.

 **NOTE:** In Windows 10, 8.1, and 8, these applications will have a different layout with different features from what is described below for desktop applications. To access the print feature from a Start screen app, complete the following steps:

- **Windows 10:** Select **Print**, and then select the printer.
- **Windows 8.1 or 8:** Select **Devices**, select **Print**, and then select the printer.

3. Click the **Layout** tab.
4. Select the appropriate duplex option from the **Print on Both Sides Manually** drop-down list, and then click the **OK** button.
5. In the **Print** dialog box, click the **OK** button to print the job. The printer will print the first side of all the pages in the document first.
6. Retrieve the printed stack from the output bin, and place it with the printed-side facing down, top edge first in the input tray.




7. At the computer, click the **OK** button to print the second side of the job.
8. If prompted, select the appropriate control panel button to continue.

## Print multiple pages per sheet (Windows)

1. From the software program, select the **Print** option.
2. Select the printer from the list of printers, and then click or tap the **Properties** or **Preferences** button to open the print driver.

---

 **NOTE:** The name of the button varies for different software programs.

 **NOTE:** In Windows 10, 8.1, and 8, these applications will have a different layout with different features from what is described below for desktop applications. To access the print feature from a Start screen app, complete the following steps:

- **Windows 10:** Select **Print**, and then select the printer.
  - **Windows 8.1 or 8:** Select **Devices**, select **Print**, and then select the printer.
- 

3. Click or tap the **Layout** tab.
4. Select the correct **Orientation** option from the drop-down list.
5. Select the correct number of pages per sheet from the **Pages per sheet** drop-down list, and then click or tap the **Advanced** button.
6. Select the correct **Pages per Sheet Layout** option from the drop-down list.
7. Select the correct **Page Borders** option from the drop-down list, click or tap the **OK** button to close the **Advanced Options** dialog box, and then click or tap the **OK** button to close the **Properties** or **Preferences** dialog box.
8. In the **Print** dialog box, click the **OK** button to print the job.

## Select the paper type (Windows)

1. From the software program, select the **Print** option.
2. Select the printer from the list of printers, and then click or tap the **Properties** or **Preferences** button to open the print driver.

 **NOTE:** The name of the button varies for different software programs.

 **NOTE:**

- **Windows 10:** Select **Print**, and then select the printer.
  - **Windows 8.1 or 8:** Select **Devices**, select **Print**, and then select the printer.
- 

3. Click or tap the **Printing Shortcuts** tab.
4. From the **Paper Type** drop-down list, select the correct paper type, and then click or tap the **OK** button to close the **Properties** or **Preferences** dialog box.
5. In the **Print** dialog box, click the **OK** button to print the job.




# Print tasks (OS X)

## How to print (OS X)

The following procedure describes the basic printing process for OS X.

1. Click the **File** menu, and then click the **Print** option.
2. Select the printer.
3. Click **Show Details** or **Copies & Pages**, and then select other menus to adjust the print settings.

---

 **NOTE:** The name of the item varies for different software programs.

---

4. Click the **Print** button.

## Manually print on both sides (OS X)


---

 **NOTE:** This feature is available if you install the HP print driver. It might not be available if you are using AirPrint.

---

1. Click the **File** menu, and then click the **Print** option.
2. Select the printer.
3. Click **Show Details** or **Copies & Pages**, and then click the **Manual Duplex** menu.

---

 **NOTE:** The name of the item varies for different software programs.

---

4. Click the **Manual Duplex** box, and select a binding option.
5. Click the **Print** button.
6. Go to the printer, and remove any blank paper that is in Tray 1.
7. Retrieve the printed stack from the output bin and place it with the printed-side facing down in the input tray.
8. If prompted, touch the appropriate control panel button to continue.

## Print multiple pages per sheet (OS X)

1. Click the **File** menu, and then click the **Print** option.
2. Select the printer.
3. Click **Show Details** or **Copies & Pages**, and then click the **Layout** menu.

---

 **NOTE:** The name of the item varies for different software programs.

---

4. From the **Pages per Sheet** drop-down list, select the number of pages that you want to print on each sheet.
5. In the **Layout Direction** area, select the order and placement of the pages on the sheet.
6. From the **Borders** menu, select the type of border to print around each page on the sheet.
7. Click the **Print** button.

## Select the paper type (OS X)

1. Click the **File** menu, and then click the **Print** option.
2. Select the printer.
3. Click **Show Details** or **Copies & Pages**, and then click the **Media & Quality** menu or the **Paper/Quality** menu.



---

**NOTE:** The name of the item varies for different software programs.

---

4. Select from the **Media & Quality** or **Paper/Quality** options.



---

**NOTE:** This list contains the master set of options available. Some options are not available on all printers.

---

- **Media Type:** Select the option for the type of paper for the print job.
  - **Print Quality:** Select the resolution level for the print job.
5. Click the **Print** button.

# Mobile printing

## Introduction

HP offers multiple mobile solutions to enable easy printing to an HP printer from a laptop, tablet, smartphone, or other mobile device. To see the full list and to determine the best choice, go to [www.hp.com/go/LaserJetMobilePrinting](http://www.hp.com/go/LaserJetMobilePrinting).

---

 **NOTE:** Update the printer firmware to ensure all mobile printing capabilities are supported.

---

## Wi-Fi Direct (wireless models only)

Wi-Fi Direct enables printing from a wireless mobile device without requiring a connection to a network or the Internet.




Wi-Fi Direct does not support all mobile operating systems. If the mobile device does not support Wi-Fi Direct, you must change the wireless network connection of the device to the Wi-Fi Direct connection of the printer before printing.

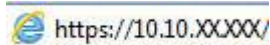
---

 **NOTE:** For non-Wi-Fi Direct capable mobile devices, the Wi-Fi Direct connection only enables printing. After using Wi-Fi Direct to print, you must reconnect to a local network in order to access the Internet.


---

To access the printer Wi-Fi Direct connection, complete the following steps:

1. Print a configuration page to determine the IP address or host name.
  - a. Press and hold the Start Copy  button until the Ready  light begins blinking.
  - b. Release the Start Copy  button.
2. Open a web browser, and in the address line, type the IP address or host name exactly as it displays on the printer configuration page. Press the **Enter** key on the computer keyboard. The EWS opens.




---

 **NOTE:** If the web browser displays a message indicating that accessing the website might not be safe, select the option to continue to the website. Accessing this website will not harm the computer.

---

3. On the **Networking** tab, click the **Wi-Fi Direct Setup** link in the left navigation pane.
4. Choose one of the following connection methods:
  - **Manual**
  - **Automatic**
5. On the mobile device, open the **Wi-Fi** or the **Wi-Fi Direct** menu.
6. From the list of available networks, select the printer name.


---


 **NOTE:** If the printer name does not display, you might be out of range of the Wi-Fi Direct signal. Move the device closer to the printer.

---

7. If prompted, enter the Wi-Fi Direct password.

---

 **NOTE:** For Android devices that support Wi-Fi Direct, if the connection method is set to **Automatic**, the connection will occur automatically, without a password prompt. If the connection method is set to **Manual**, you will need to either press the **Wireless** button on the printer to connect to an Android device, or provide a personal identification number (PIN) — displayed on the printed report — as a password to connect to a Windows (8.1 or later) device.

 **NOTE:** To access the Wi-Fi Direct password, from the EWS open the **Networking** tab, and then click **Wi-Fi Direct Setup**.

---

8. Open the document, and then select the **Print** option.
9. Select the printer from the list of available printers, and then select **Print**.
10. After the print job is complete, some mobile devices need to be reconnected to the local network.

The following devices and computer operating systems support **Wi-Fi Direct**:

- Android 4.0 and later tablets and phones with the HP Print Service or Mopria mobile printing plugin installed
- Most Windows 8.1 computers, tablets, and laptops that have the HP print driver installed

The following devices and computer operating systems do not support **Wi-Fi Direct**, but can print to a printer that does:

- Apple iPhone and iPad
- Mac computers running OS X




For more information on Wi-Fi Direct printing, go to [www.hp.com/go/wirelessprinting](http://www.hp.com/go/wirelessprinting).


Wi-Fi Direct capabilities can be enabled or disabled from the HP Embedded Web Server (EWS).

## Enable or disable Wi-Fi Direct


Wi-Fi Direct capabilities must be enabled first from the printer EWS.

### Step one: Open the HP Embedded Web Server

1. Print a configuration page to determine the IP address or host name.
  - a. Press and hold the Start Copy  button until the Ready  light begins blinking.
  - b. Release the Start Copy  button.
2. Open a web browser, and in the address line, type the IP address or host name exactly as it displays on the printer configuration page. Press the **Enter** key on the computer keyboard. The EWS opens.

 <https://10.10.XXXX/>

---


 **NOTE:** If the web browser displays a message indicating that accessing the website might not be safe, select the option to continue to the website. Accessing this website will not harm the computer.

---

### Step two: Enable or disable Wi-Fi Direct

1. On the **Networking** tab, click the **Wi-Fi Direct Setup** link in the left navigation pane.
2. Select the **On** option, and then click **Apply**. Selecting the **Off** option disables Wi-Fi Direct printing.

---




 **NOTE:** In environments where more than one model of the same printer is installed, it might be helpful to provide each printer a unique Wi-Fi Direct name for easier printer identification for Wi-Fi Direct printing.

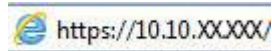
---

## Change the printer Wi-Fi Direct name

Follow this procedure to change the printer Wi-Fi Direct name using the HP Embedded Web Server (EWS):

### Step one: Open the HP Embedded Web Server

1. Print a configuration page to determine the IP address or host name.
  - a. Press and hold the Start Copy  button until the Ready  light begins blinking.
  - b. Release the Start Copy  button.
2. Open a web browser, and in the address line, type the IP address or host name exactly as it displays on the printer configuration page. Press the **Enter** key on the computer keyboard. The EWS opens.



 **NOTE:** If the web browser displays a message indicating that accessing the website might not be safe, select the option to continue to the website. Accessing this website will not harm the computer.

---

### Step two: Change the Wi-Fi Direct name


1. On the **Networking** tab, click the **Wi-Fi Direct Setup** link in the left navigation pane.
2. In the **Wi-Fi Direct Name** field, enter the new name.
3. Click **Apply**.

## AirPrint

Direct printing using Apple's AirPrint is supported for iOS and from Mac computers running OS X 10.7 Lion and newer. Use AirPrint to print directly to the printer from an iPad, iPhone (3GS or later), or iPod touch (third generation or later) in the following mobile applications:

- Mail
- Photos
- Safari
- iBooks
- Select third-party applications

To use AirPrint, the printer must be connected to the same network (sub-net) as the Apple device. For more information about using AirPrint and about which HP printers are compatible with AirPrint, go to [www.hp.com/go/LaserJetMobilePrinting](http://www.hp.com/go/LaserJetMobilePrinting).

 **NOTE:** Before using AirPrint with a USB connection, verify the version number. AirPrint versions 1.3 and earlier do not support USB connections.

---

## Android embedded printing (wireless models only)

HP's built-in print solution for Android and Kindle enables mobile devices to automatically find and print to HP printers that are either on a network or within wireless range for Wi-Fi Direct printing.

The print solution is built into the many versions of the operating system.



**NOTE:** If printing is not available on your device, go to the [Google Play > Android apps](#) and install the HP Print Service Plugin.

---

For more information on how to use Android embedded printing and which Android devices are supported, go to [www.hp.com/go/LaserJetMobilePrinting](http://www.hp.com/go/LaserJetMobilePrinting).

---

# 5 Copy

- [Make a copy](#)
- [Copy identification card](#)

## For more information:

The following information is correct at the time of publication. For current information, see [www.hp.com/support/ljM28MFP](http://www.hp.com/support/ljM28MFP).

HP's all-inclusive help for the printer includes the following information:

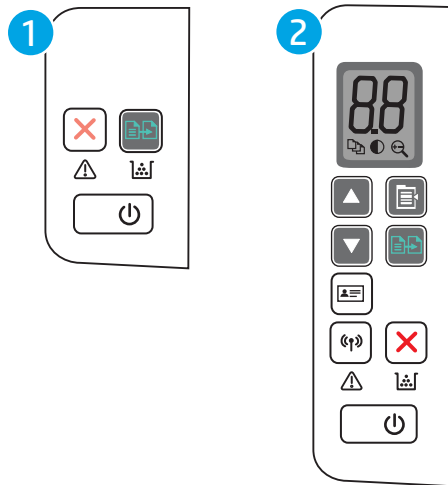
- Install and configure
- Learn and use
- Solve problems
- Download software and firmware updates
- Join support forums
- Find warranty and regulatory information

## Make a copy

Follow these steps to make a copy from the scanner glass:

- ▲ Load the document on the scanner glass according to the indicators on the printer.

 **NOTE:** The steps vary according to the type of control panel.








- |   |                                  |
|---|----------------------------------|
| 1 | Base model LED control panel     |
| 2 | Wireless model LED control panel |

### Base model control panel

- ▲ Press the Start Copy  button to start copying.

 **NOTE:** To increase the number of copies, press the Start Copy  button repeatedly (up to nine times) to get multiple copies.



### Wireless model control panel

1. Press the Copy Setup  button to choose any of the following copy settings.
  - Select the Number of Copies  setting, and then use the arrow keys to adjust the number of copies.
  - Select the Lighter/Darker  setting, and then use the arrow keys to adjust the darkness setting for the current copy job.
  - Select the Enlarge/Reduce  setting, and then use the arrow keys to adjust the size percentage of the copy job.
2. Press the Start Copy  button to start copying.



## Copy identification card

Use the **ID Copy** feature to copy both sides of identification card, or other small-size documents, onto the same side of one sheet of paper. The printer prints both images at the same time.

1. Place the ID card onto the left side of the scanner glass.
2. Close the scanner lid and touch the **ID Copy** button  to start copying. When it finishes, the attention LED blinks.
3. Place the second side of the ID card on the same section of the scanner glass.
4. Touch the **ID Copy** button  again to start copying.
5. The page prints.



---

## 6 Scan

- [Scan by using the HP Scan software \(Windows\)](#)
- [Scan by using the HP Easy Scan Software \(OS X\)](#)
- [Additional scan tasks](#)

### For more information:

The following information is correct at the time of publication. For current information, see [www.hp.com/support/ljM28MFP](http://www.hp.com/support/ljM28MFP).

HP's all-inclusive help for the printer includes the following information:

- Install and configure
- Learn and use
- Solve problems
- Download software and firmware updates
- Join support forums
- Find warranty and regulatory information

## Scan by using the HP Scan software (Windows)

Use the HP Scan software to initiate scanning from software on your computer. You can save the scanned image as a file or send it to another software application.

1. Load the document on the scanner glass according to the indicators on the printer.
2. From the computer, open the HP Printer Assistant.
  - **Windows 10:** From the **Start** menu, click **All Apps**, click **HP**, and then select the printer name.
  - **Windows 8.1:** Click the down arrow in lower left corner of the **Start** screen, and then select the printer name.
  - **Windows 8:** Right-click an empty area on the **Start** screen, click **All Apps** on the app bar, and then select the printer name.
  - **Windows 7:** From the computer desktop, click **Start**, select **All Programs**, click **HP**, click the folder for the printer, and then select the printer name.
3. In the HP Printer Assistant, select **Scan**, and then select **Scan a Document or Photo**.
4. Adjust the settings if necessary.
5. Click **Scan**.

## Scan by using the HP Easy Scan Software (OS X)

Use the HP Easy Scan software to initiate scanning from software on your computer.

1. Load the document on the scanner glass according to the indicators on the printer.
2. From the computer, open **HP Easy Scan**, which is located in the **Applications** folder.
3. Follow the on-screen instructions to scan the document.
4. When you have scanned all the pages, click **File** and then **Save** to save them to a file.

## Additional scan tasks

Go to [www.hp.com/support/ljM28MFP](http://www.hp.com/support/ljM28MFP).

Instructions are available for performing specific scan tasks, such as the following:

- How to scan a general photo or document
- How to scan as editable text (OCR)
- How to scan multiple pages into a single file

---

# 7 Manage the printer

- [Change the printer connection type \(Windows\)](#)
- [Advanced configuration with HP Embedded Web Server \(EWS\) and HP Device Toolbox \(Windows\)](#)
- [Advanced configuration with HP Utility for OS X](#)
- [Configure IP network settings](#)
- [Printer security features](#)
- [Energy-conservation settings](#)
- [Update the firmware](#)

## For more information:

The following information is correct at the time of publication. For current information, see [www.hp.com/support/ljM28MFP](http://www.hp.com/support/ljM28MFP).

HP's all-inclusive help for the printer includes the following information:

- Install and configure
- Learn and use
- Solve problems
- Download software and firmware updates
- Join support forums
- Find warranty and regulatory information

## Change the printer connection type (Windows)

If you are already using the printer and you wish to change the way it is connected, use **Device Setup & Software** to change the connection. For example, connect the new printer to the computer using a USB, or change the connection from a USB to a wireless connection.

To open **Device Setup & Software**, complete the following procedure:

1. Open the HP Printer Assistant.
  - **Windows 10:** From the **Start** menu, click **All Apps**, click **HP**, and then select the printer name.
  - **Windows 8.1:** Click the down arrow in lower left corner of the **Start** screen, and then select the printer name.
  - **Windows 8:** Right-click an empty area on the **Start** screen, click **All Apps** on the app bar, and then select the printer name.
  - **Windows 7:** From the computer desktop, click **Start**, select **All Programs**, click **HP**, click the folder for the printer, and then select the printer name.
2. In the HP Printer Assistant, select **Tools** from the navigation bar, and then select **Device Setup & Software**.



# Advanced configuration with HP Embedded Web Server (EWS) and HP Device Toolbox (Windows)


Use the HP Embedded Web Server to manage printing functions from your computer instead of the printer control panel.


- View printer status information
- Determine the remaining life for all supplies and order new ones
- View and change tray configurations
- Receive notification of printer and supplies events
- View and change network configuration

The HP Embedded Web Server works when the printer is connected to an IP-based network. The HP Embedded Web Server does not support IPX-based printer connections. You do not have to have Internet access to open and use the HP Embedded Web Server.

When the printer is connected to the network, the HP Embedded Web Server is automatically available.

---

 **NOTE:** HP Device Toolbox is software used to connect to the HP Embedded Web Server when the printer is connected to a computer via USB. It is available only if a full installation was performed when the printer was installed on a computer. Depending on how the printer is connected, some features might not be available.




 **NOTE:** The HP Embedded Web Server is not accessible beyond the network firewall.

---

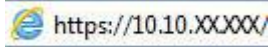
## Method one: Open the HP Embedded Web Server (EWS) from the software

1. Open the HP Printer Assistant.
  - **Windows 10:** From the **Start** menu, click **All Apps**, click **HP**, and then select the printer name.
  - **Windows 8.1:** Click the down arrow in lower left corner of the **Start** screen, and then select the printer name.
  - **Windows 8:** Right-click an empty area on the **Start** screen, click **All Apps** on the app bar, and then select the printer name.
  - **Windows 7:** From the computer desktop, click **Start**, select **All Programs**, click **HP**, click the folder for the printer, and then select the printer name.
2. In the HP Printer Assistant, select **Print**, and then select **HP Device Toolbox**.

## Method two: Open the HP Embedded Web Server (EWS) from a web browser

1. Print a configuration page to determine the IP address or host name.
  - a. Press and hold the Start Copy  button until the Ready  light begins blinking.
  - b. Release the Start Copy  button.

- Open a web browser, and in the address line, type the IP address or host name exactly as it displays on the configuration report. Press the **Enter** key on the computer keyboard. The EWS opens.



**NOTE:** If the web browser displays a message indicating that accessing the website might not be safe, select the option to continue to the website. Accessing this website will not harm the computer.

Tab or section	Description
<p><b>Home tab</b></p> <p>Provides printer, status, and configuration information.</p>	<ul style="list-style-type: none"> <li><b>Device Status:</b> Shows the printer status and shows the approximate percent life remaining of HP supplies.</li> <li><b>Supplies Status:</b> Shows the approximate percent life remaining of HP supplies. Actual supply life remaining can vary. Consider having a replacement supply available to install when print quality is no longer acceptable. The supply does not need to be replaced unless the print quality is no longer acceptable.</li> <li><b>Device Configuration:</b> Shows the information found on the printer configuration page.</li> <li><b>Network Summary:</b> Shows the information found on the printer network configuration page.</li> <li><b>Event Log:</b> Shows a list of all printer events and errors.</li> <li><b>Open Source Licenses:</b> Shows a summary of the licenses for open source software programs that can be used with the printer.</li> </ul>
<p><b>System tab</b></p> <p>Provides the ability to configure the printer from your computer.</p>	<ul style="list-style-type: none"> <li><b>Device Information:</b> Provides basic printer and company information.</li> <li><b>Paper Setup:</b> Change the default paper-handling settings for the printer.</li> <li><b>Energy Settings:</b> Change the default times for entering Sleep/Auto Off mode or automatic shut down.</li> <li><b>System Setup:</b> Change the system defaults for the printer.</li> <li><b>Supply Settings:</b> Change the settings for <b>Cartridge is low</b> alert and other supplies information.</li> <li><b>Service:</b> Perform the cleaning procedure on the printer.</li> <li><b>Administration:</b> Set or change the printer password. Enable or disable printer features.</li> </ul> <p><b>NOTE:</b> The <b>System</b> tab can be password-protected. If this printer is on a network, always consult with the administrator before changing settings on this tab.</p>
<p><b>Copy tab</b></p>	<p>Use this tab to set up the default copy settings.</p> <p><b>NOTE:</b> The <b>Copy</b> tab can be password-protected. If this printer is on a network, always consult with the administrator before changing settings on this tab.</p>
<p><b>Networking tab</b></p> <p>(Network-connected printers only)</p> <p>Provides the ability to change network settings from your computer.</p>	<p>Network administrators can use this tab to control network-related settings for the printer when it is connected to an IP-based network. It also allows the network administrator to set up Wi-Fi Direct functionality. This tab does not appear if the printer is directly connected to a computer.</p> <p><b>NOTE:</b> The <b>Networking</b> tab can be password-protected. If this printer is on a network, always consult with the administrator before changing settings on this tab.</p>

# Advanced configuration with HP Utility for OS X

Use the HP Utility to check printer status or to view or change printer settings from a computer.

You can use the HP Utility when the printer is connected with a USB cable or is connected to a TCP/IP-based network.

## Open HP Utility

1. At the computer, open the **Applications** folder.
2. Select **HP**, and then select **HP Utility**.

## HP Utility features

The HP Utility toolbar includes these items:

- **Devices:** Click this button to show or hide Mac products found by the HP Utility.
- **All Settings:** Click this button to return to the HP Utility main view.
- **HP Support:** Click this button to open a browser and go to the HP support website.
- **Supplies:** Click this button to open the HP SureSupply website.
- **Registration:** Click this button to open the HP registration website.
- **Recycling:** Click this button to open the HP Planet Partners Recycling Program website.

HP Utility consists of pages that you open by clicking in the **All Settings** list. The following table describes the tasks that you can perform with HP Utility.

Item	Description
Supplies Status	Show the printer supplies status and gain access to links for ordering supplies online.
Device Information	Show information about the currently selected printer, including the printer Service ID (if assigned), the firmware version (FW Version), the Serial Number, and the IP address.
Commands	Send special characters or print commands to the printer after the print job. <b>NOTE:</b> This option is available only after you open the <b>View</b> menu and select the <b>Show Advanced Options</b> item.
File Upload	Transfer files from the computer to the printer. You can upload the following types of files: <ul style="list-style-type: none"><li>○ HP LaserJet printer command language (.PRN)</li><li>○ Portable document format (.PDF)</li><li>○ Postscript (.PS)</li><li>○ Text (.TXT)</li></ul>
Power Management	Configure the printer economy settings.
Update Firmware	Transfer a firmware update file to the printer. <b>NOTE:</b> This option is available only after you open the <b>View</b> menu and select the <b>Show Advanced Options</b> item.
HP Connected	Access the HP Connected website.

Item	Description
<b>Message Center</b>	Display error events that have occurred with the printer.
<b>Network Settings</b> (Network-connected printers only)	Configure the network settings, such as the IPv4 settings, IPv6 settings, Bonjour settings, and other settings.
<b>Supplies Management</b>	Configure how the printer should behave when supplies are nearing the end of their estimated life.
<b>Trays Configuration</b>	Change paper size and type for each of the trays.
<b>Additional Settings</b>	Open the HP Embedded Web Server (EWS) for the printer. <b>NOTE:</b> USB connections are not supported.
<b>Proxy Server Settings</b>	Configure a proxy server for the printer.

# Configure IP network settings

- [Introduction](#)
- [Printer sharing disclaimer](#)
- [View or change network settings](#)
- [Manually configure IPv4 TCP/IP parameters](#)

## Introduction




Use the following sections to configure the printer network settings.

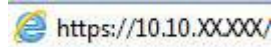
## Printer sharing disclaimer

HP does not support peer-to-peer networking, as the feature is a function of Microsoft operating systems and not of the HP printer drivers. Go to Microsoft at [www.microsoft.com](http://www.microsoft.com).

## View or change network settings

Use the HP Embedded Web Server to view or change IP configuration settings.

1. Open the HP Embedded Web Server (EWS):
  - a. Print a configuration page to determine the IP address or host name.
    - i. Press and hold the Start Copy  button until the Ready  light begins blinking.
    - ii. Release the Start Copy  button.
  - b. Open a web browser, and in the address line, type the IP address or host name exactly as it displays on the printer configuration page. Press the **Enter** key on the computer keyboard. The EWS opens.






 **NOTE:** If the web browser displays a message indicating that accessing the website might not be safe, select the option to continue to the website. Accessing this website will not harm the computer.

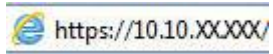
2. Click the **Networking** tab to obtain network information. Change settings as needed.

## Manually configure IPv4 TCP/IP parameters

Use the EWS to manually set an IPv4 address, subnet mask, and default gateway.

1. Open the HP Embedded Web Server (EWS):
  - a. Print a configuration page to determine the IP address or host name.
    - i. Press and hold the Start Copy  button until the Ready  light begins blinking.
    - ii. Release the Start Copy  button.

- b. Open a web browser, and in the address line, type the IP address or host name exactly as it displays on the printer configuration page. Press the **Enter** key on the computer keyboard. The EWS opens.



 **NOTE:** If the web browser displays a message indicating that accessing the website might not be safe, select the option to continue to the website. Accessing this website will not harm the computer.

2. Click the **Networking** tab.
3. In the **IPv4 Configuration** area, select **Manual IP**, and then edit the IPv4 configuration settings.
4. Click the **Apply** button.

# Printer security features

## Introduction

The printer includes several security features to restrict who has access to configuration settings, to secure data, and to prevent access to valuable hardware components.

- [Assign or change the system password using the HP Embedded Web Server](#)

## Assign or change the system password using the HP Embedded Web Server




Assign an administrator password for access to the printer and the HP Embedded Web Server so that unauthorized users cannot change the printer settings.

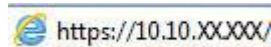
1. Open the HP Embedded Web Server (EWS):


### Direct-connected printers

- a. Open the HP Printer Assistant.
  - **Windows 10:** From the **Start** menu, click **All Apps**, click **HP**, and then select the printer name.
  - **Windows 8.1:** Click the down arrow in lower left corner of the **Start** screen, and then select the printer name.
  - **Windows 8:** Right-click an empty area on the **Start** screen, click **All Apps** on the app bar, and then select the printer name.
  - **Windows 7:** From the computer desktop, click **Start**, select **All Programs**, click **HP**, click the folder for the printer, and then select the printer name.
- b. In the HP Printer Assistant, select **Print**, and then select **HP Device Toolbox**.

### Network-connected printers

- a. Print a configuration page to determine the IP address or host name.
  - i. Press and hold the Start Copy  button until the Ready  light begins blinking.
  - ii. Release the Start Copy  button.
- b. Open a web browser, and in the address line, type the IP address or host name exactly as it displays on the printer configuration page. Press the **Enter** key on the computer keyboard. The EWS opens.



 **NOTE:** If the web browser displays a message indicating that accessing the website might not be safe, select the option to continue to the website. Accessing this website will not harm the computer.

2. On the **System** tab, click the **Administration** link in the left navigation pane.
3. In the area labeled **Product Security**, enter the password in the **Password** field.
4. Re-enter the password in the **Confirm Password** field.
5. Click the **Apply** button.



---

**NOTE:** Make note of the password and store it in a safe place.

---



# Energy-conservation settings

- [Introduction](#)
- [Set the Sleep/Auto Off After Inactivity setting](#)
- [Set the Shut Down After Inactivity delay and configure the printer to use 1 watt or less of power](#)
- [Set the Delay Shut Down setting](#)

## Introduction

The printer includes several economy features to conserve energy and supplies.

## Set the Sleep/Auto Off After Inactivity setting

Use the EWS to set the amount of idle time before the printer enters sleep mode.




Complete the following procedure to change the Sleep/Auto Off After setting:

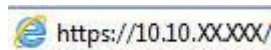
1. Open the HP Embedded Web Server (EWS):

### Direct-connected printers

- a. Open the HP Printer Assistant.
  - **Windows 10:** From the **Start** menu, click **All Apps**, click **HP**, and then select the printer name.
  - **Windows 8.1:** Click the down arrow in lower left corner of the **Start** screen, and then select the printer name.
  - **Windows 8:** Right-click an empty area on the **Start** screen, click **All Apps** on the app bar, and then select the printer name.
  - **Windows 7:** From the computer desktop, click **Start**, select **All Programs**, click **HP**, click the folder for the printer, and then select the printer name.
- b. In the HP Printer Assistant, select **Print**, and then select **HP Device Toolbox**.

### Network-connected printers

- a. Print a configuration page to determine the IP address or host name.
  - i. Press and hold the Start Copy  button until the Ready  light begins blinking.
  - ii. Release the Start Copy  button.
- b. Open a web browser, and in the address line, type the IP address or host name exactly as it displays on the printer configuration page. Press the **Enter** key on the computer keyboard. The EWS opens.



 **NOTE:** If the web browser displays a message indicating that accessing the website might not be safe, select the option to continue to the website. Accessing this website will not harm the computer.


2. Click the **System** tab, and then select **Energy Settings**.

3. From the **Sleep/Auto Off After Inactivity** drop-down, select the time for the delay.
4. Click the **Apply** button.

## Set the Shut Down After Inactivity delay and configure the printer to use 1 watt or less of power

Use the EWS to set the amount of time before the printer shuts down.

---

 **NOTE:** After the printer shuts down, the power consumption is 1 watt or less.

---




Complete the following procedure to change the Shut Down After Delay setting:

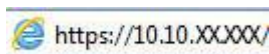
1. Open the HP Embedded Web Server (EWS):

### Direct-connected printers

- a. Open the HP Printer Assistant.
  - **Windows 10:** From the **Start** menu, click **All Apps**, click **HP**, and then select the printer name.
  - **Windows 8.1:** Click the down arrow in lower left corner of the **Start** screen, and then select the printer name.
  - **Windows 8:** Right-click an empty area on the **Start** screen, click **All Apps** on the app bar, and then select the printer name.
  - **Windows 7:** From the computer desktop, click **Start**, select **All Programs**, click **HP**, click the folder for the printer, and then select the printer name.
- b. In the HP Printer Assistant, select **Print**, and then select **HP Device Toolbox**.

### Network-connected printers

- a. Print a configuration page to determine the IP address or host name.
  - i. Press and hold the Start Copy  button until the Ready  light begins blinking.
  - ii. Release the Start Copy .
- b. Open a web browser, and in the address line, type the IP address or host name exactly as it displays on the printer configuration page. Press the **Enter** key on the computer keyboard. The EWS opens.



---

 **NOTE:** If the web browser displays a message indicating that accessing the website might not be safe, select the option to continue to the website. Accessing this website will not harm the computer.

---

2. Click the **System** tab, and then select **Energy Settings**.
3. From the **Shut Down After Inactivity** drop-down, select the time for the delay.

---

 **NOTE:** The default value is **4 hours**.

---

4. Click the **Apply** button.

## Set the Delay Shut Down setting

Use the EWS to select whether or not the printer delays shutting down after the power button is pressed.




Complete the following procedure to change the Delay Shut Down setting:


1. Open the HP Embedded Web Server (EWS):

### Direct-connected printers

- a. Open the HP Printer Assistant.
  - **Windows 10:** From the **Start** menu, click **All Apps**, click **HP**, and then select the printer name.
  - **Windows 8.1:** Click the down arrow in lower left corner of the **Start** screen, and then select the printer name.
  - **Windows 8:** Right-click an empty area on the **Start** screen, click **All Apps** on the app bar, and then select the printer name.
  - **Windows 7:** From the computer desktop, click **Start**, select **All Programs**, click **HP**, click the folder for the printer, and then select the printer name.
- b. In the HP Printer Assistant, select **Print**, and then select **HP Device Toolbox**.


### Network-connected printers

- a. Print a configuration page to determine the IP address or host name.
  - i. Press and hold the Start Copy  button until the Ready  light begins blinking.
  - ii. Release the Start Copy  button.
- b. Open a web browser, and in the address line, type the IP address or host name exactly as it displays on the printer configuration page. Press the **Enter** key on the computer keyboard. The EWS opens.

 <https://10.10.XX.XX/>

 **NOTE:** If the web browser displays a message indicating that accessing the website might not be safe, select the option to continue to the website. Accessing this website will not harm the computer.

2. Click the **System** tab, and then select **Energy Settings**.
3. Select or clear the **Delay when ports are active** option.

 **NOTE:** When this option is selected the printer will not shut down unless all ports are inactive. An active network link will prevent the printer from shutting down.

# Update the firmware

HP offers periodic printer updates. Follow these steps to update the printer firmware for a single printer.

## Update the firmware using the Firmware Update Utility

Use these steps to manually download and install the Firmware Update Utility from HP.com.

---


 **NOTE:** This method is the only firmware update option available for printers connected to the computer via a USB cable. It also works for printers connected to a network.

 **NOTE:** You must have a print driver installed in order to use this method.

---

1. Go to [www.hp.com/go/support](http://www.hp.com/go/support), select your country/region or language, and then click the **Software and Drivers** link.
2. Type the printer name in the search field, press the **ENTER** button, and then select the printer from the list of search results.
3. Select the operating system.
4. Under the **Firmware** section, locate the **Firmware Update Utility**.
5. Click **Download**, click **Run**, and then click **Run** again.
6. When the utility launches, select the printer from the drop-down list, and then click **Send Firmware**.

---

 **NOTE:** To print a configuration page to verify the installed firmware version before or after the update process, click **Print Config**.

---

7. Follow the on-screen instructions to complete the installation, and then click the **Exit** button to close the utility.

---

# 8 Solve problems

- [Customer support](#)
- [Laser Warning](#)
- [Interpret control-panel light patterns](#)
- [Restore the factory-set defaults](#)
- [A “Cartridge is low” or “Cartridge is very low” message displays](#)
- [Printer does not pick up paper or misfeeds](#)
- [Clear paper jams](#)
- [Improve print quality](#)
- [Resolving print quality problems](#)
- [Improve copy and scan image quality](#)
- [Solve wireless network problems](#)

## For more information:

The following information is correct at the time of publication. For current information, see [www.hp.com/support/ljM28MFP](http://www.hp.com/support/ljM28MFP).

HP's all-inclusive help for the printer includes the following information:

- Install and configure
- Learn and use
- Solve problems
- Download software and firmware updates
- Join support forums
- Find warranty and regulatory information

# Customer support

---

Get telephone support for your country/region	Country/region phone numbers are on the flyer that was in the box with the printer or at <a href="http://support.hp.com">support.hp.com</a> .
Have the printer name, serial number, date of purchase, and problem description ready	
Get 24-hour Internet support, and download software utilities and drivers	<a href="http://www.hp.com/support/ljM28MFP">www.hp.com/support/ljM28MFP</a>
Order additional HP service or maintenance agreements	<a href="http://www.hp.com/go/carepack">www.hp.com/go/carepack</a>
Register the printer	<a href="http://www.register.hp.com">www.register.hp.com</a>

---

## Laser Warning



**CAUTION** - CLASS 3B INVISIBLE LASER RADIATION WHEN OPEN. AVOID EXPOSURE TO THE BEAM.

**ATTENTION** - RAYONNEMENT LASER INVISIBLE DE CLASSE 3B EN CAS D'OUVERTURE. ÉVITEZ L'EXPOSITION AU FAISCEAU.

**VORSICHT** - UNSICHTBARE LASERSTRAHLUNG KLASSE 3B, WENN ABDECKUNG GEÖFFNET. NICHT DEM STRAHL AUSSETZEN.

**PRECAUCIÓN** – RADIACIÓN LÁSER INVISIBLE DE CLASE 3B PRESENTE AL ABRIR. EVITE LA EXPOSICIÓN AL HAZ.

**VARNING** - OSYNLIG LASERSTRÅLNING KLASSE 3B VID ÖPPEN LUCKA UNDVIK EXPONERING FÖR LASERSTRÅLNINGEN.

**VAROITUS** - LUOKAN 3B NÄKYMÄTTÖMÄLLE LASER-SÄTEILYÄ AVATTUNA. VÄLTÄ ALTISTUMISTA SÄTEELLE.

**注意** - 打开时，存在不可见的 **3B** 类激光辐射，请避免接触该激光束。




**주의** - 열리엔 등급 3B 비가시레이저방사선이방출됩니다. 광선에 노출을 피하십시오.

**注意** - ここを開くとクラス 3B 不可視レーザー放射が出ます。ビームに身をさらさないこと。


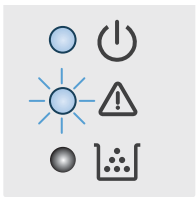





## Interpret control-panel light patterns

If the printer requires user confirmation, the LED control panel alternates between **Go** and a two-digit status code. If the printer requires attention, the LED control panel alternates between **Er** and a two-digit error code. Use the table below to determine any issues with the printer.

**Table 8-1** Status-light legend

	Symbol for "light off"
	Symbol for "light on"
	Symbol for "light blinking"




**Table 8-2** Control-panel light patterns

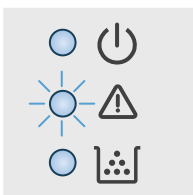
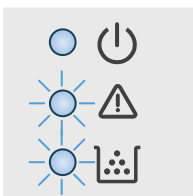
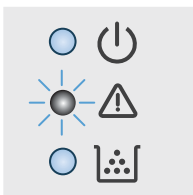
Light status	Error code	State of the printer	Action
The Attention light is blinking.	<b>Go/01</b>	The printer is in manual-feed mode.	Load the correct paper type and size into the input tray. Press the Start Copy  button to continue.
	<b>Go/02</b>	The printer is processing a manual duplex job.	Load the pages into the input tray to print the second sides. Press the Start Copy  button to continue.
	<b>Go/03</b>	The paper type or size of the print job is different than the tray settings.	Load the correct paper type and size into the input tray, or press the Start Copy  button to continue with the paper currently loaded.
	<b>Go/04</b>	The printer has received a request to register this printer with Google Cloud Print.	Press the Start Copy  button to acknowledge this request.
	<b>Go/05</b>	The printer has received a request to connect to this printer using Wi-Fi Direct.	Enter the PIN on the printed report on your mobile device.
	<b>Go/06</b>	The printer has received a request to connect to this printer using Wi-Fi Direct.	Press the Start Copy  button to connect.
	<b>Go/P2</b>	An ID Copy job has been started.	Turn over the identification card and press the ID Copy button to continue.
	<b>Er/01</b>	The input tray is empty.	Load the tray.
	<b>Er/02</b>	A door is open.	Verify that the top cover is fully closed.
	<b>Er/03</b>	The printer failed to pick a sheet of paper to print.	Press Start Copy  to continue.
	<b>Er/04</b>	Paper is jammed in the input tray.	Clear the jam.
	<b>Er/05</b>	Paper is jammed in the toner cartridge area.	Clear the jam.
	<b>Er/06</b>	Paper is jammed in the output bin area.	Clear the jam.

**NOTE:** The Supplies LED might or might not be on in this state depending on the supply status.

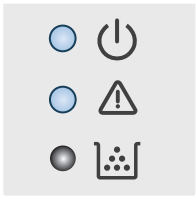
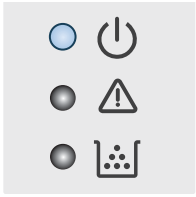
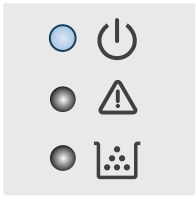



**Table 8-2 Control-panel light patterns (continued)**

Light status	Error code	State of the printer	Action
	<b>Er/25</b>	The loaded paper is not the size needed for the print job.	Replace the paper, or press Start Copy  to continue with the size currently loaded.
	<b>Er/26</b>	The printer has experienced a general engine error.	Press Start Copy  to continue.  If the error repeats, turn off the printer. Wait 30 seconds, and then turn on the printer.
	<b>Er/81</b>	Incorrect firmware has been loaded.	Press Start Copy  to continue. Load the correct firmware.
The Attention light is blinking and the Ready light is on.	<b>Er/08</b>	The supply has reached very low status and is configured to stop.	The cartridge needs to be replaced, or the cartridge setting needs to be changed to <b>Continue</b> in the EWS.. If the supply is configured to <b>Continue</b> , then the Supply light will be on but no error code will display.
The Attention and Supply lights are blinking, and the Ready light is on.	<b>Er/07</b>	The supply is missing or incorrectly installed.	Install or reinstall the supply.
	<b>Er/11</b>	There is an issue with the cartridge.	Make sure the shipping material has been removed from the cartridge, and that the cartridge is compatible and not damaged.
	<b>Er/14</b>	The toner cartridge has been protected and is not allowed to be used in this printer.	Replace the cartridge.
	<b>Er/17</b>	An unauthorized toner cartridge is installed.	Replace the cartridge.
The Attention light is blinking, and Ready and Supply lights are on.	<b>Er/08</b>	The supply has reached very low status and is configured to stop.	The cartridge needs to be replaced, or the cartridge setting needs to be changed to <b>Continue</b> in the EWS.. If the supply is configured to <b>Continue</b> , then the Supply light will be on but no error code will display.



**Table 8-2 Control-panel light patterns (continued)**

Light status	Error code	State of the printer	Action
Attention and Ready lights are on.	<b>Er/30</b>	There is an issue with the flatbed scanner.	Turn off the device and then turn it on. If the problem persists, contact HP support.
	<b>Er/50</b>	There is an issue with the print engine.	Turn off the device and then turn it on. If the problem persists, contact HP support.
	<b>Er/51</b>		
	<b>Er/52</b>		
	<b>Er/54</b>		
	<b>Er/55</b>		
	<b>Er/58</b> <b>Er/59</b>		
Attention light is off and Ready light is on.	<b>Er/66</b>	There is a problem with the wireless hardware.	Turn off the device and then turn it on. If the problem persists, contact HP support.
Attention light is off and Ready light is on.		The printer is in Ready mode. The LCD display will show the current value for the number of copies.	
			
Attention light is off and Ready light is on but dim.		The printer is in Sleep mode.	
			
Attention light is off and Ready light is on but dim.			
			

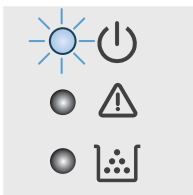
**NOTE:** The Supplies LED might or might not be on in this state depending on the supply status.

**NOTE:** The Supplies LED might or might not be on in this state depending on the supply status.

**NOTE:** The Supplies LED might or might not be on in this state depending on the supply status.

**Table 8-2** Control-panel light patterns (continued)

Light status	Error code	State of the printer	Action
<p>Attention light is off and Ready light is blinking.</p>		<p>The printer is currently processing a job. For print and scan jobs, the LCD display will show the current value for the number of copies. For copy jobs, the LCD display will show the copy number being processed. For ID copy jobs, the LCD display will show "P1" while scanning the front of the identification card, and show "P2" while scanning the back of the identification card.</p>	
<p>The Attention and Ready lights are blinking.</p>		<p>The printer is initializing, cleaning, or cooling down.</p>	



# Restore the factory-set defaults

Restoring the factory-set defaults returns all of the printer and network settings to the factory defaults. It will not reset the page count. To restore the printer to the factory-default settings, follow these steps.

---

**CAUTION:** Restoring the factory-set defaults returns all of the settings to the factory defaults, and it also deletes any pages that are stored in the memory.




---

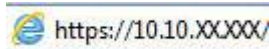
1. Open the HP Embedded Web Server (EWS):

## Direct-connected printers


- a. Open the HP Printer Assistant.
  - **Windows 10:** From the **Start** menu, click **All Apps**, click **HP**, and then select the printer name.
  - **Windows 8.1:** Click the down arrow in lower left corner of the **Start** screen, and then select the printer name.
  - **Windows 8:** Right-click an empty area on the **Start** screen, click **All Apps** on the app bar, and then select the printer name.
  - **Windows 7:** From the computer desktop, click **Start**, select **All Programs**, click **HP**, click the folder for the printer, and then select the printer name.
- b. In the HP Printer Assistant, select **Print**, and then select **HP Device Toolbox**.

## Network-connected printers

- a. Print a configuration page to determine the IP address or host name.
  - i. Press and hold the Start Copy  button until the Ready  light begins blinking.
  - ii. Release the Start Copy  button.
- b. Open a web browser, and in the address line, type the IP address or host name exactly as it displays on the printer configuration page. Press the **Enter** key on the computer keyboard. The EWS opens.



---

 **NOTE:** If the web browser displays a message indicating that accessing the website might not be safe, select the option to continue to the website. Accessing this website will not harm the computer.

---

2. On the **System** tab, click **Service**.
3. In the **Restore Defaults** area, click the **Restore defaults** button.

The printer automatically restarts.

## A “Cartridge is low” or “Cartridge is very low” message displays

**Cartridge is low:** The printer indicates when a cartridge level is low. Actual cartridge life remaining may vary. Consider having a replacement available to install when print quality is no longer acceptable. The cartridge does not need to be replaced now.

Continue printing with the current cartridge until redistributing the toner no longer yields acceptable print quality. To redistribute the toner, remove the toner cartridge from the printer and gently rock the cartridge back and forth about its horizontal axis. For graphical representation, see cartridge replacement instructions. Reinsert the toner cartridge into the printer and close the cover.

**Cartridge is very low:** The printer indicates when the cartridge level is very low. Actual cartridge life remaining may vary. Consider having a replacement available to install when print quality is no longer acceptable. The cartridge does not need to be replaced now unless the print quality is no longer acceptable.

Once an HP toner cartridge has reached **Very Low**, HP’s Premium Protection Warranty on that toner cartridge has ended.

### Change the “Very Low” settings




You can change the way the printer reacts when supplies reach the Very Low state. You do not have to re-establish these settings when you install a new toner cartridge.

1. Open the HP Embedded Web Server (EWS):

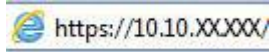
#### Direct-connected printers


- a. Open the HP Printer Assistant.
  - **Windows 10:** From the **Start** menu, click **All Apps**, click **HP**, and then select the printer name.
  - **Windows 8.1:** Click the down arrow in lower left corner of the **Start** screen, and then select the printer name.
  - **Windows 8:** Right-click an empty area on the **Start** screen, click **All Apps** on the app bar, and then select the printer name.
  - **Windows 7:** From the computer desktop, click **Start**, select **All Programs**, click **HP**, click the folder for the printer, and then select the printer name.
- b. In the HP Printer Assistant, select **Print**, and then select **HP Device Toolbox**.

#### Network-connected printers

- a. Print a configuration page to determine the IP address or host name.
  - i. Press and hold the Start Copy  button until the Ready  light begins blinking.
  - ii. Release the Start Copy  button.

- b. Open a web browser, and in the address line, type the IP address or host name exactly as it displays on the printer configuration page. Press the **Enter** key on the computer keyboard. The EWS opens.



 **NOTE:** If the web browser displays a message indicating that accessing the website might not be safe, select the option to continue to the website. Accessing this website will not harm the computer.

2. Select the **System** tab, and then select **Supply Settings**.
3. Select one of the following options from the **Very Low Setting (Black Cartridge)**: drop-down:
  - Select the **Stop** option to set the printer to stop printing until you replace the cartridge.
  - Select the **Continue** option to set the printer to alert you that the cartridge is very low, but to continue printing.

## Order supplies

Order supplies and paper	<a href="http://www.hp.com/go/suresupply">www.hp.com/go/suresupply</a>
Order through service or support providers	Contact an HP-authorized service or support provider.
Order using the HP Embedded Web Server (EWS)	To access, in a supported on your computer, enter the printer IP address or host name in the address/URL field. The EWS contains a link to the HP SureSupply website, which provides options for purchasing Original HP supplies.

# Printer does not pick up paper or misfeeds

## Introduction

The following solutions can help solve problems if the printer is not picking up paper from the tray or is picking up multiple sheets of paper at one time. Either of these situations can result in paper jams.

- [The product does not pick up paper](#)
- [The product picks up multiple sheets of paper](#)

## The product does not pick up paper

If the product does not pick up paper from the tray, try these solutions.

1. Open the product and remove any jammed sheets of paper.
2. Load the tray with the correct size of paper for your job.
3. Make sure the paper size and type are set correctly on the product control panel.
4. Make sure the paper guides in the tray are adjusted correctly for the size of paper. Adjust the guides to the appropriate indentation in the tray.
5. The rollers above the tray might be contaminated. Clean the rollers with a lint-free cloth dampened with warm water.

## The product picks up multiple sheets of paper

If the product picks up multiple sheets of paper from the tray, try these solutions.

1. Remove the stack of paper from the tray and flex it, rotate it 180 degrees, and flip it over. *Do not fan the paper.* Return the stack of paper to the tray.
2. Use only paper that meets HP specifications for this product.
3. Use paper that is not wrinkled, folded, or damaged. If necessary, use paper from a different package.
4. Make sure the tray is not overfilled. If it is, remove the entire stack of paper from the tray, straighten the stack, and then return some of the paper to the tray.
5. Make sure the paper guides in the tray are adjusted correctly for the size of paper. Adjust the guides to the appropriate indentation in the tray.
6. Make sure the printing environment is within recommended specifications.

# Clear paper jams

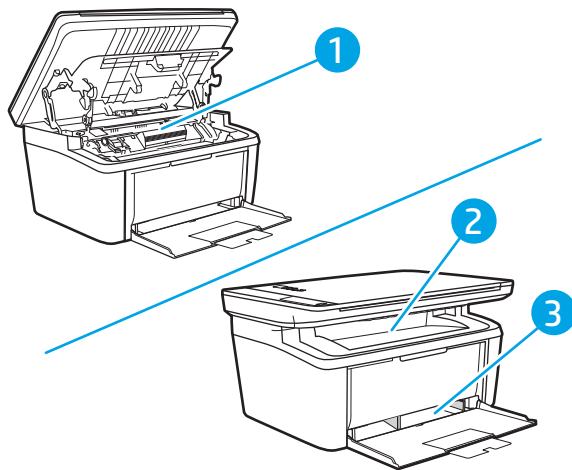
## Introduction

The following information includes instructions for clearing paper jams from the printer.

- [Jam locations](#)
- [Experiencing frequent or recurring paper jams?](#)
- [Clear jams from the input tray](#)
- [Clear jams from inside the product](#)
- [Clear jams from the output areas](#)

## Jam locations

Jams can occur at the following locations in the product.



---

1	Internal areas
---	----------------

---

2	Input tray
---	------------

---

3	Output bin
---	------------

---




 **NOTE:** Jams can occur in more than one location.


---






## Experiencing frequent or recurring paper jams?

Follow these steps to solve problems with frequent paper jams. If the first step does not resolve the problem continue with the next step until you have resolved the problem.

1. If paper has jammed in the printer, clear the jam and then print a configuration page to test the printer.
2. Check that the tray is configured for the correct paper size and type. Adjust paper settings if necessary.
  - a. Print a configuration page to determine the IP address or host name.
    - i. Press and hold the Start Copy  button until the Ready  light begins blinking.
    - ii. Release the Start Copy  button.
  - b. Open a web browser, and in the address line, type the IP address or host name exactly as it displays on the printer configuration page. Press the **Enter** key on the computer keyboard. The EWS opens.

 <https://10.10.XXXX/>

 **NOTE:** If the web browser displays a message indicating that accessing the website might not be safe, select the option to continue to the website. Accessing this website will not harm the computer.

- c. Click the **System** tab, and then click the **Paper Setup** page.
    - d. Select the type of paper that is in the tray.
    - e. Select the size of paper that is in the tray.
3. Turn the printer off, wait 30 seconds, and then turn it on again.
4. Print a cleaning page to remove excess toner from inside the printer.
  - a. Open the HP Printer Assistant.
    - **Windows 10:** From the **Start** menu, click **All Apps**, click **HP**, and then select the printer name.
    - **Windows 8.1:** Click the down arrow in lower left corner of the **Start** screen, and then select the printer name.
    - **Windows 8:** Right-click an empty area on the **Start** screen, click **All Apps** on the app bar, and then select the printer name.
    - **Windows 7:** From the computer desktop, click **Start**, select **All Programs**, click **HP**, click the folder for the printer, and then select the printer name.
  - b. In the HP Printer Assistant, select **Print**, and then select **HP Device Toolbox**.
  - c. On the **System** tab, click **Service**.
  - d. In the **Fuser Cleaning mode** area, click **Start** to begin the cleaning process.
5. Print a configuration page to test the printer.
  - a. Press and hold the Start Copy  button until the Ready  light begins blinking.
  - b. Release the Start Copy  button.

If none of these steps resolves the problem, the printer might need service. Contact HP customer support.

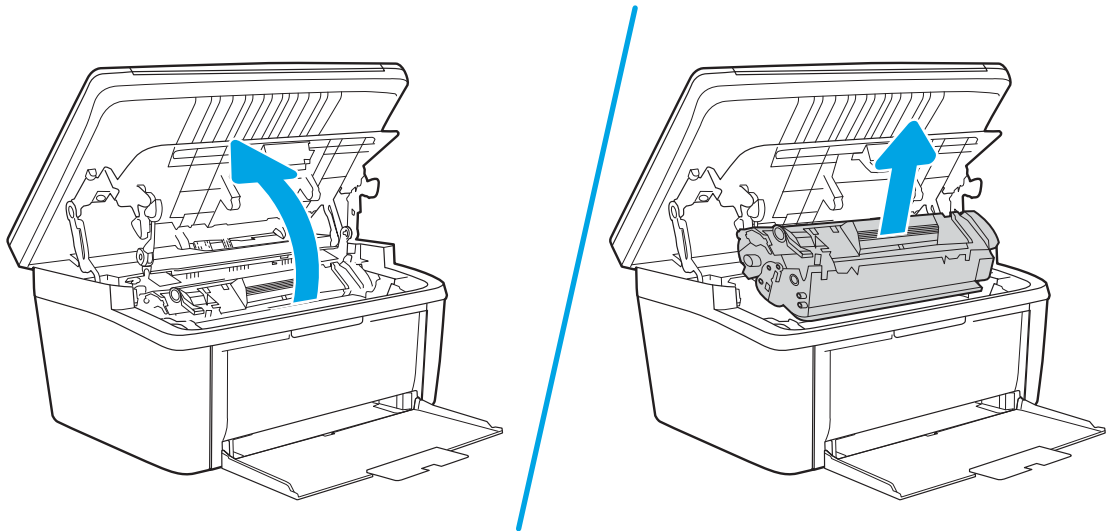
## Clear jams from the input tray

**⚠ CAUTION:** Do not use sharp objects, such as tweezers or needle-nose pliers, to remove jams. Damage caused by sharp objects will not be covered by the warranty.

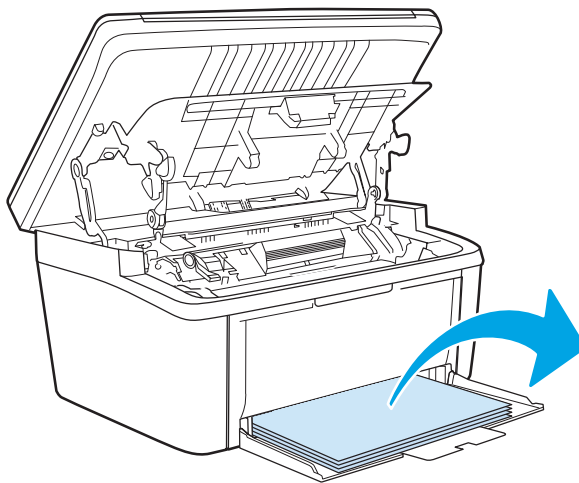
When removing jammed media, pull the jammed media straight away from the product. Pulling jammed media out of the product at an angle can damage the product.

**📝 NOTE:** Depending on where the jam is located, some of the following steps might not be necessary.

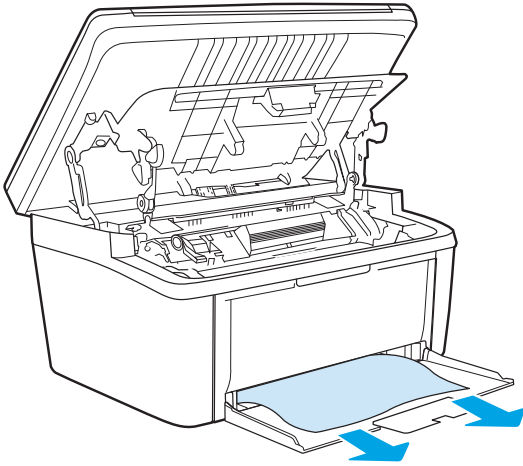
1. Open the print-cartridge door, and then remove the print cartridge.



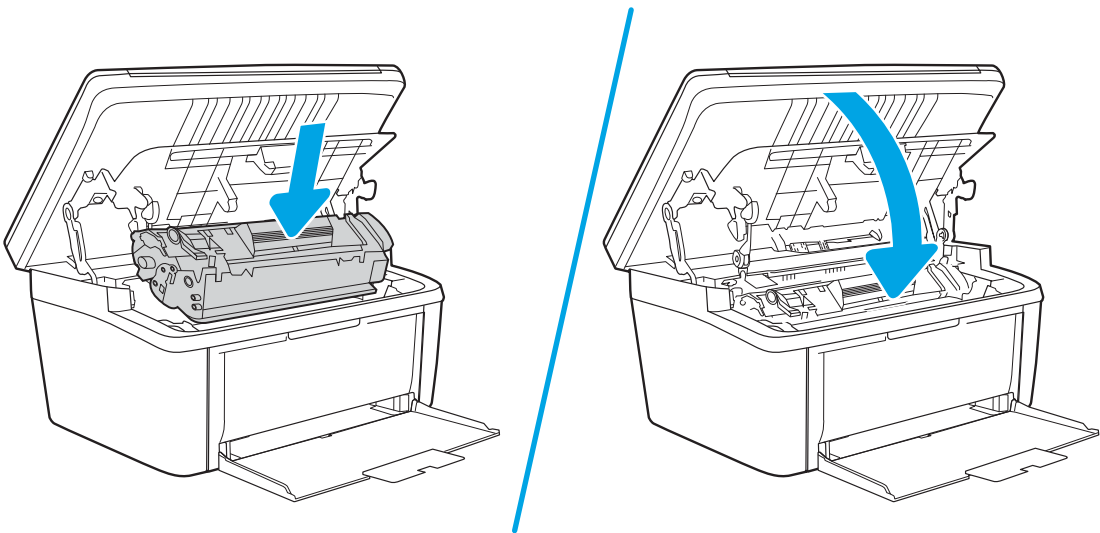
2. Remove the media stack from the input tray.



3. With both hands, grasp the side of the jammed media that is most visible (this includes the middle), and carefully pull it free from the product.

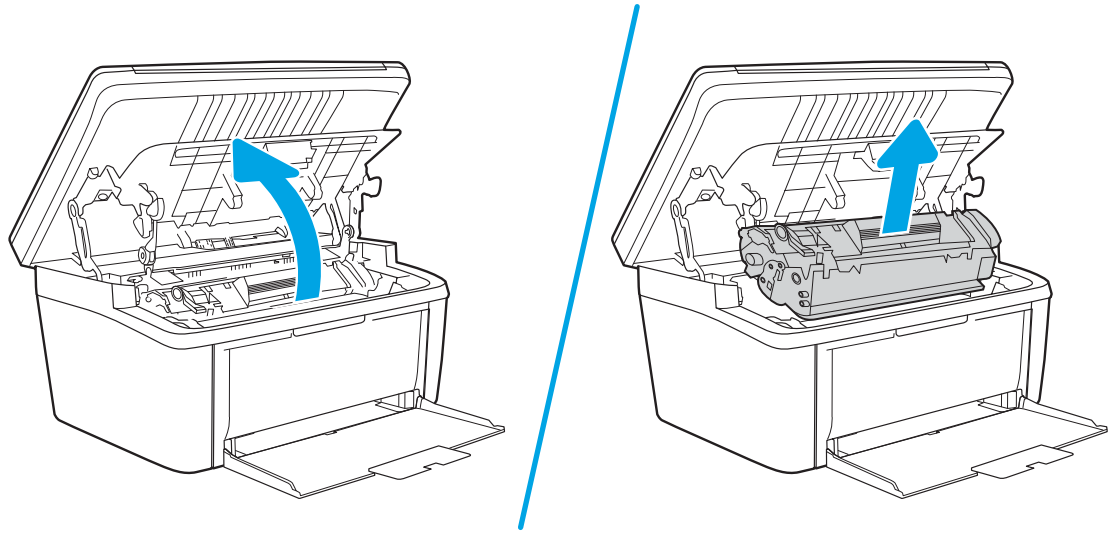


4. Reinstall the print cartridge, and then close the print-cartridge door.



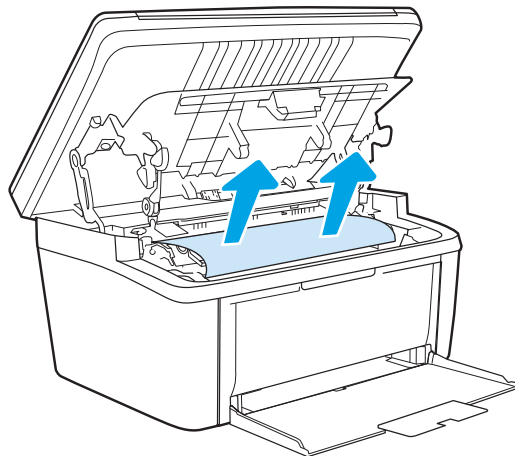
## Clear jams from inside the product

1. Open the print-cartridge door, and then remove the print cartridge.

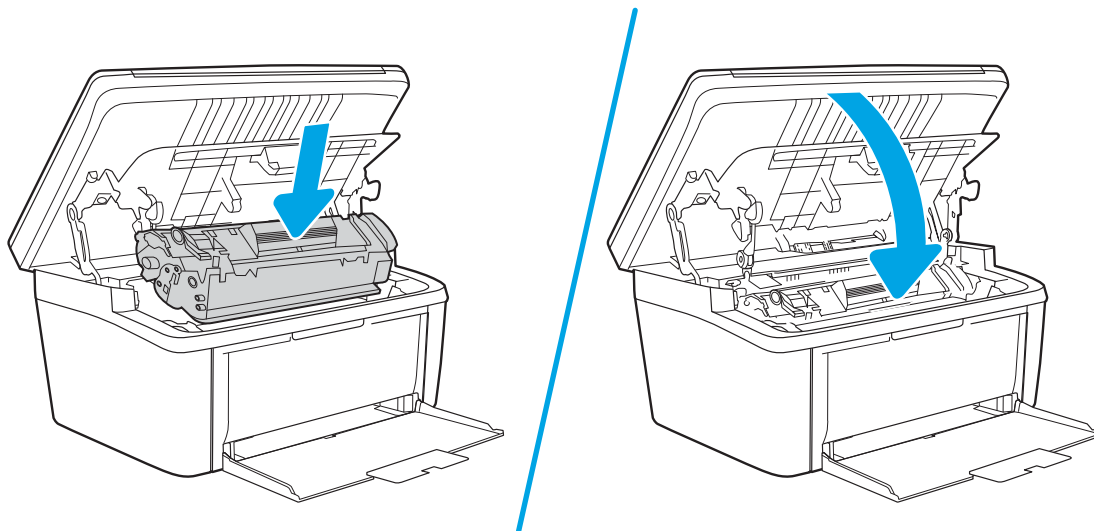


**⚠ CAUTION:** To prevent damage, do not expose the print cartridge to light. Cover it with a piece of paper.

2. If you can see the jammed paper, carefully grasp the jammed paper, and slowly pull it out of the product.



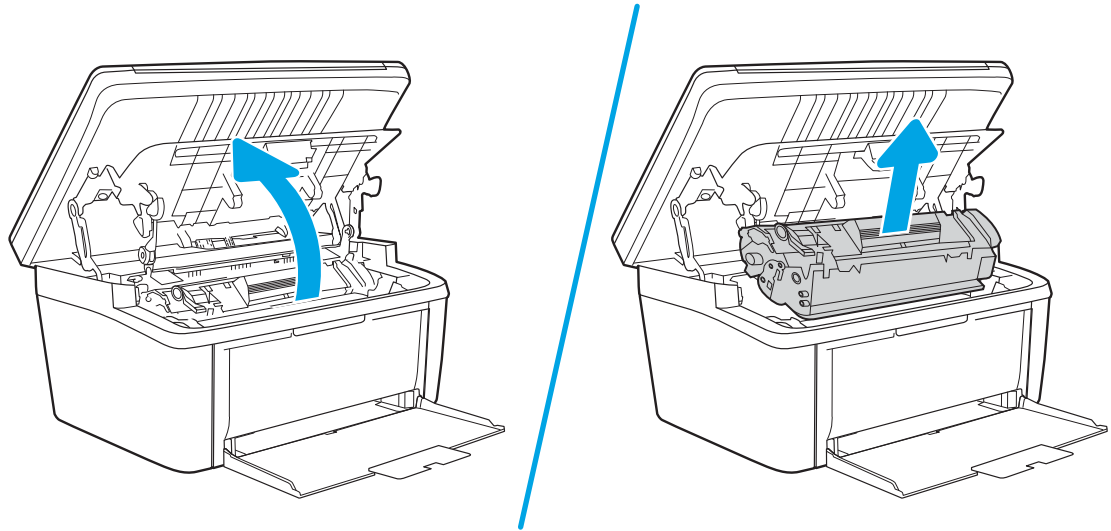
3. Reinstall the print cartridge, and then close the print-cartridge door.



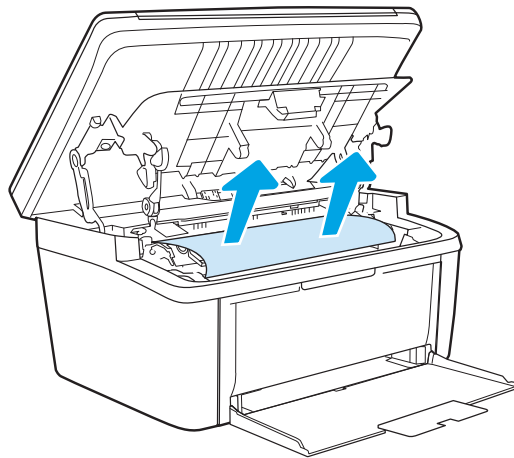
## Clear jams from the output areas

**⚠ CAUTION:** Do not use sharp objects, such as tweezers or needle-nose pliers, to remove jams. Damage caused by sharp objects will not be covered by the warranty.

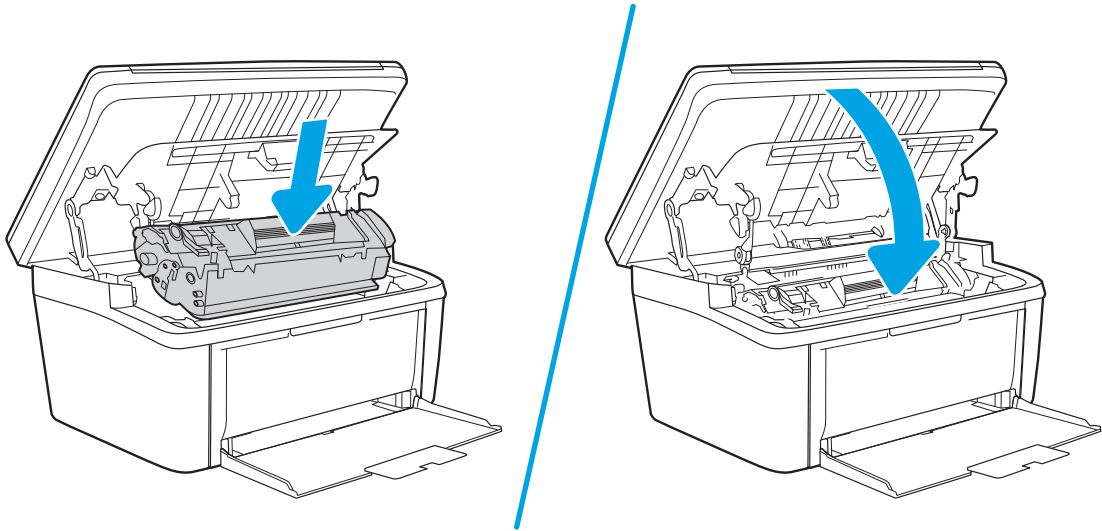
1. Open the print-cartridge door, and then remove the print cartridge.



2. Keep the print cartridge door open, and then with both hands, grasp the side of the jammed media that is most visible (this includes the middle), and carefully pull it free from the product.



3. Reinstall the print cartridge, and then close the print-cartridge door.





# Improve print quality

- [Introduction](#)
- [Update the printer firmware](#)
- [Print from a different software program](#)
- [Check the paper-type setting for the print job](#)
- [Check toner-cartridge status](#)
- [Cartridge cleaning](#)
- [Print a cleaning page](#)
- [Visually inspect the toner cartridge](#)
- [Check paper and the printing environment](#)
- [Adjust Print Density](#)

## Introduction

The following information provides troubleshooting steps to resolve print-quality problems, including the following problems:

- Smears
- Fuzzy print
- Dark print
- Light print
- Streaks
- Missing toner
- Scattered dots of toner
- Loose toner
- Skewed images

To resolve these or other print-quality problems, try the following solutions in the order presented.

For information about resolving specific image defects, see the Resolving print quality problems section of this User Guide.

## Update the printer firmware

Try upgrading the printer firmware. For more information, see the Update the firmware section of this User Guide.

## Print from a different software program

Try printing from a different software program. If the page prints correctly, the problem is with the software program from which you were printing.

## Check the paper-type setting for the print job

Check the paper type setting when printing from a software program and the printed pages have smears, fuzzy or dark print, curled paper, scattered dots of toner, loose toner, or small areas of missing toner.

### Check the paper type setting on the printer

1. Open the tray.
2. Verify that the tray is loaded with the correct type of paper.
3. Close the tray.

### Check the paper type setting (Windows)

1. From the software program, select the **Print** option.
2. Select the printer, and then click the **Properties** or **Preferences** button.
3. Click the **Paper/Quality** tab.
4. From the **Paper Type** drop-down list, click the **More...** option.
5. Expand the list of **Type is:** options.
6. Expand the category of paper types that best describes your paper.
7. Select the option for the type of paper you are using, and click the **OK** button.
8. Click the **OK** button to close the **Document Properties** dialog box. In the **Print** dialog box, click the **OK** button to print the job.

### Check the paper type setting (OS X)




1. Click the **File** menu, and then click the **Print** option.
2. In the **Printer** menu, select the printer.
3. By default, the print driver displays the **Copies & Pages** menu. Open the menus drop-down list, and then click the **Finishing** menu.
4. Select a type from the **Media Type** drop-down list.
5. Click the **Print** button.

## Check toner-cartridge status

Follow these steps to check the estimated life remaining in the toner cartridges and if applicable, the status of other replaceable maintenance parts.

### Step one: Find supplies information on configuration page

Supplies information is included on the configuration page.

1. Press and hold the Start Copy  button until the Ready  light begins blinking.
2. Release the Start Copy  button.

## Step two: Check supplies status

1. Look at the supplies status report to check the percent of life remaining for the toner cartridges and if applicable, the status of other replaceable maintenance parts.

Print quality problems can occur when using a toner cartridge that is at its estimated end of life. The configuration report indicates when a supply level is very low.

Once an HP toner cartridge has reached Very Low, HP's Premium Protection Warranty on that toner cartridge has ended.

The toner cartridge does not need to be replaced now unless the print quality is no longer acceptable. Consider having a replacement available to install when print quality is no longer acceptable.

If you determine that you need to replace a toner cartridge or other replaceable maintenance parts, the configuration report lists the genuine HP part numbers.

2. Check to see if you are using a genuine HP cartridge.

A genuine HP toner cartridge has "HP" on it, or has the HP logo on it. For more information on identifying HP cartridges go to [www.hp.com/go/learnaboutequipment](http://www.hp.com/go/learnaboutequipment).

## Cartridge cleaning

During the printing process, cartridges might be contaminated by paper dust and cause print quality issues such as background issues, vertical dark bands, or repetitive horizontal banding.

Follow these steps to improve the above mentioned print quality issues:

1. Open a web browser, and in the address line type the IP address or host name exactly as it displays on the printer configuration page. Press the **Enter** key on the computer keyboard. The EWS opens.



**NOTE:** If the web browser displays a message indicating that accessing the website might not be safe, select the option to continue to the website. Accessing this website will not harm the computer.

2. Click the **System** tab, and then click **Service**.
3. In the **Cartridge Cleaning Mode** area, click **Start** to begin the cleaning process.

Or use the following procedure to start the Cartridge Cleaning mode:

1. Open the HP Printer Assistant.
  - Windows 10: From the **Start** menu, click **All Apps**, click **HP**, and then select the printer name.
  - Windows 8.1: Click the down arrow in the lower left corner of the **Start** screen, and then select the printer name.
  - Windows 8: Right-click an empty area on the **Start** screen, click **All Apps** on the app bar, and then select the printer name.
  - Windows 7: From the computer desktop, click **Start**, select **All Programs**, click **HP**, click the folder for the printer, and then select the printer name.
2. In the HP Printer Assistant, select **Print**, and then select **HP Device Toolbox**.
3. On the **System** tab, click **Service**.
4. In the **Cartridge Cleaning Mode** area, click **Start** to begin the cleaning process.

## Print a cleaning page

During the printing process paper, toner, and dust particles can accumulate inside the printer and can cause print-quality issues such as toner specks or spatter, smears, streaks, lines, or repeating marks.

Use the following procedure to print a cleaning page.


1. Open the HP Printer Assistant.
  - **Windows 10:** From the **Start** menu, click **All Apps**, click **HP**, and then select the printer name.
  - **Windows 8.1:** Click the down arrow in lower left corner of the **Start** screen, and then select the printer name.
  - **Windows 8:** Right-click an empty area on the **Start** screen, click **All Apps** on the app bar, and then select the printer name.
  - **Windows 7:** From the computer desktop, click **Start**, select **All Programs**, click **HP**, click the folder for the printer, and then select the printer name.
2. In the HP Printer Assistant, select **Print**, and then select **HP Device Toolbox**.
3. On the **System** tab, click **Service**.
4. In the **Fuser Cleaning mode** area, click **Start** to begin the cleaning process.

## Visually inspect the toner cartridge

Follow these steps to inspect the toner cartridge.

1. Remove the toner cartridges from the printer, and verify that the sealing tape has been removed.
2. Check the memory chip for damage.
3. Examine the surface of the green imaging drum.

---

 **CAUTION:** Do not touch the imaging drum. Fingerprints on the imaging drum can cause print-quality problems.

---

4. If you see any scratches, fingerprints, or other damage on the imaging drum, replace the toner cartridge.
5. Reinstall the toner cartridge, and print a few pages to see if the problem has resolved.

## Check paper and the printing environment

### Step one: Use paper that meets HP specifications

Some print-quality problems arise from using paper that does not meet HP specifications.

- Always use a paper type and weight that this printer supports.
- Use paper that is of good quality and free of cuts, nicks, tears, spots, loose particles, dust, wrinkles, voids, staples, and curled or bent edges.
- Use paper that has not been previously printed on.
- Use paper that does not contain metallic material, such as glitter.

- Use paper that is designed for use in laser printers. Do not use paper that is designed only for use in Inkjet printers.
- Use paper that is not too rough. Using smoother paper generally results in better print quality.

## Step two: Check the environment

The environment can directly affect print quality and is a common cause for print-quality or paper-feeding issues. Try the following solutions:

- Move the printer away from drafty locations, such as open windows or doors, or air-conditioning vents.
- Make sure the printer is not exposed to temperatures or humidity outside of printer specifications.
- Do not place the printer in a confined space, such as a cabinet.
- Place the printer on a sturdy, level surface.
- Remove anything that is blocking the vents on the printer. The printer requires good air flow on all sides, including the top.
- Protect the printer from airborne debris, dust, steam, grease, or other elements that can leave residue inside the printer.

## Adjust Print Density




Complete the following steps to adjust the print density.

1. Open the HP Embedded Web Server (EWS):

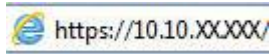
### Direct-connected printers

- a. Open the HP Printer Assistant.
  - **Windows 10:** From the **Start** menu, click **All Apps**, click **HP**, and then select the printer name.
  - **Windows 8.1:** Click the down arrow in lower left corner of the **Start** screen, and then select the printer name.
  - **Windows 8:** Right-click an empty area on the **Start** screen, click **All Apps** on the app bar, and then select the printer name.
  - **Windows 7:** From the computer desktop, click **Start**, select **All Programs**, click **HP**, click the folder for the printer, and then select the printer name.
- b. In the HP Printer Assistant, select **Print**, and then select **HP Device Toolbox**.

### Network-connected printers

- a. Print a configuration page to determine the IP address or host name.
  - i. Press and hold the Start Copy  button until the Ready  light begins blinking.
  - ii. Release the Start Copy  button.

- b. Open a web browser, and in the address line, type the IP address or host name exactly as it displays on the printer configuration page. Press the **Enter** key on the computer keyboard. The EWS opens.



 **NOTE:** If the web browser displays a message indicating that accessing the website might not be safe, select the option to continue to the website. Accessing this website will not harm the computer.

2. Click the **System** tab, and then select **System Setup** from the left navigation pane.
3. Select the correct density settings.
4. Click **Apply** to save the changes.

# Resolving print quality problems

- [Introduction](#)
- [Troubleshoot print quality problems](#)

## Introduction

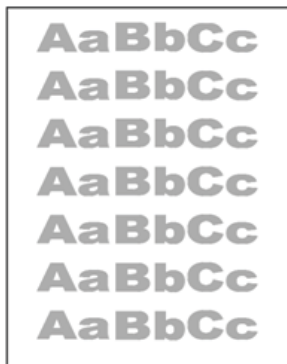
The following information provides troubleshooting steps for solving image defect issues, including the following defects:

- Light print
- Gray background or dark print
- Blank pages
- Black pages
- Dark or light bands
- Dark or light streaks
- Missing toner
- Skewed images
- Colors that do not align
- Curled paper

## Troubleshoot print quality problems

**Table 8-3** Image defects table quick reference

[Table 8-4 Light print on page 81](#)



[Table 8-5 Gray background or dark print on page 82](#)



[Table 8-6 Blank page — No print on page 82](#)



**Table 8-3** Image defects table quick reference (continued)

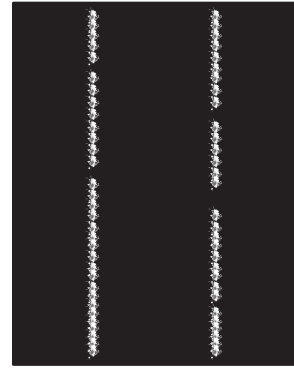
[Table 8-7 Black page on page 83](#)



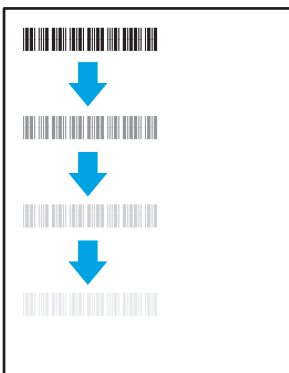
[Table 8-8 Banding defects on page 83](#)



[Table 8-9 Streak defects on page 84](#)



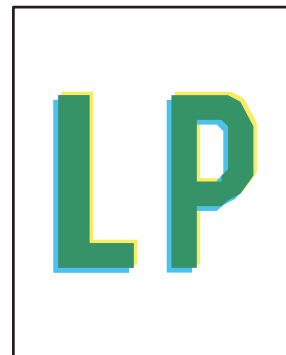
[Table 8-10 Fixing/fuser defects on page 85](#)



[Table 8-11 Image placement defects on page 85](#)



[Table 8-12 Color plane registrations defects \(color models only\) on page 86](#)



[Table 8-13 Output defects on page 86](#)

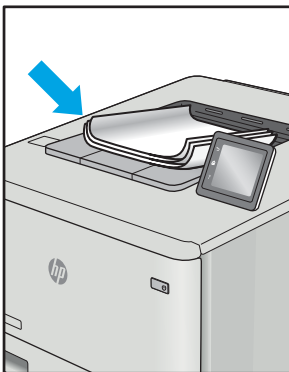



Image defects, no matter the cause, can often be resolved using the same steps. Use the following steps as a starting point for solving image defect issues.




1. Reprint the document. Print quality defects can be intermittent in nature or can go away completely with continued printing.
2. Check the condition of the cartridge. If a cartridge is in a **Very Low** state (it has passed the rated life), replace the cartridge.
3. Make sure that the driver and tray print mode settings match the media that is loaded in the tray. Try using a different ream of media or a different tray. Try using a different print mode.
4. Make sure that the printer is within the supported operating temperature/humidity range.
5. Make sure that the paper type, size, and weight are supported by the printer. See the printer support page at [support.hp.com](http://support.hp.com) for a list of the supported paper sizes and types for the printer.


 **NOTE:** The term “fusing” refers to the part of the printing process where toner is affixed to paper.

The following examples depict letter-size paper that has passed through the printer short-edge first.

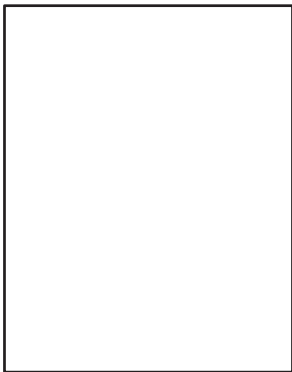
**Table 8-4** Light print

Description	Sample	Possible solutions
<p><b>Light print:</b></p> <p>The printed content on the entire page is light or faded.</p>		<ol style="list-style-type: none"> <li>1. Reprint the document.</li> <li>2. Remove the cartridge, and then shake it to redistribute the toner.</li> <li>3. Make sure that the cartridge is installed correctly.</li> <li>4. Print a configuration report and check for life and usage of the cartridge.</li> <li>5. Replace the cartridge.</li> <li>6. If the problem persists, go to <a href="http://support.hp.com">support.hp.com</a>.</li> </ol>


**Table 8-5** Gray background or dark print

Description	Sample	Possible solutions
<p><b>Gray background or dark print:</b> The image or text is darker than expected.</p>		<ol style="list-style-type: none"> <li>1. Make sure that the paper in the trays has not already been run through the printer.</li> <li>2. Use a different paper type.</li> <li>3. Reprint the document.</li> <li>4. <b>Mono models only:</b> From the printer EWS, go to the <a href="#">Adjust Toner Density</a> menu, and then adjust the toner density to a lower level.</li> <li>5. Make sure that the printer is within the supported operating temperature and humidity range.</li> <li>6. Replace the cartridge.</li> <li>7. If the problem persists, go to <a href="http://support.hp.com">support.hp.com</a>.</li> </ol>


**Table 8-6** Blank page — No print

Description	Sample	Possible solutions
<p><b>Blank page — No print:</b> The page is completely blank and contains no printed content.</p>		<ol style="list-style-type: none"> <li>1. Make sure that the cartridge is genuine HP cartridges.</li> <li>2. Make sure that the cartridge is installed correctly.</li> <li>3. Print with a different cartridge.</li> <li>4. Check the paper type in the paper tray and adjust the printer settings to match. If necessary, select a lighter paper type.</li> <li>5. If the problem persists, go to <a href="http://support.hp.com">support.hp.com</a>.</li> </ol>

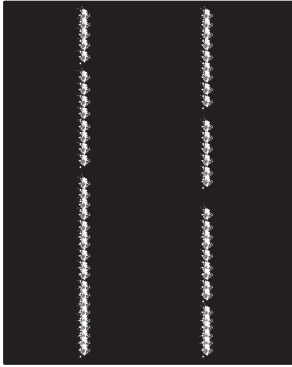
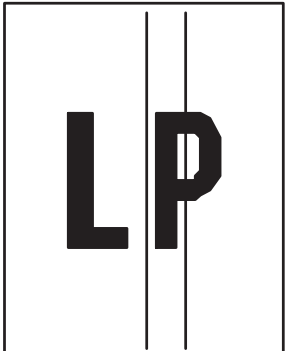
**Table 8-7** Black page

Description	Sample	Possible solutions
<p><b>Black page:</b> The entire printed page is black.</p>		<ol style="list-style-type: none"><li>1. Visually inspect the cartridge to check for damage.</li><li>2. Make sure that the cartridge is installed correctly.</li><li>3. Replace the cartridge</li><li>4. If the problem persists, go to <a href="http://support.hp.com">support.hp.com</a>.</li></ol>

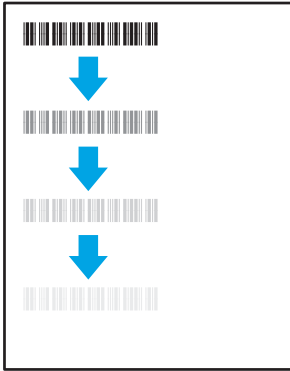
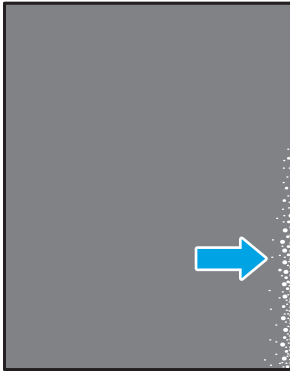
**Table 8-8** Banding defects

Description	Sample	Possible solutions
<p><b>Repetitive wide-pitch banding and Impulse bands:</b> Dark or light lines which repeat down the length of the page. They might be sharp or soft in nature. The defect displays only in areas of fill, not in text or sections with no printed content.</p>		<ol style="list-style-type: none"><li>1. Reprint the document.</li><li>2. Replace the cartridge.</li><li>3. Use a different paper type.</li><li>4. If the problem persists, go to <a href="http://support.hp.com">support.hp.com</a>.</li></ol>


**Table 8-9** Streak defects

Description	Sample	Possible solutions
<p><b>Light vertical streaks:</b></p> <p>Light streaks that usually span the length of the page. The defect displays only in areas of fill, not in text or sections with no printed content.</p>		<ol style="list-style-type: none"> <li>1. Reprint the document.</li> <li>2. Remove the cartridge, and then shake it to redistribute the toner.</li> <li>3. If the problem persists, go to <a href="http://support.hp.com">support.hp.com</a>.</li> </ol> <p><b>NOTE:</b> Both light and dark vertical streaks can occur when the printing environment is outside the specified range for temperature or humidity. Refer to your printer's environmental specifications for allowable temperature and humidity levels.</p>
<p><b>Dark vertical streaks and ITB cleaning streaks (color models only):</b></p> <p>Dark lines which occur down the length of the page. The defect might occur anywhere on the page, in areas of fill or in sections with no printed content.</p>		<ol style="list-style-type: none"> <li>1. Reprint the document.</li> <li>2. Remove the cartridge, and then shake it to redistribute the toner.</li> <li>3. Print a cleaning page.</li> <li>4. Check the toner level in the cartridge.</li> <li>5. If the problem persists, go to <a href="http://support.hp.com">support.hp.com</a>.</li> </ol>


**Table 8-10 Fixing/fuser defects**

Description	Fixing/fuser	Possible solutions
<p><b>Hot fuser offset (shadow):</b></p> <p>Slight shadows, or offsets, of the image repeated down the page. The repeated image might fade with each recurrence.</p>		<ol style="list-style-type: none"> <li>1. Reprint the document.</li> <li>2. Check the paper type in the paper tray and adjust the printer settings to match. If necessary, select a lighter paper type.</li> <li>3. If the problem persists, go to <a href="http://support.hp.com">support.hp.com</a>.</li> </ol>
<p><b>Poor fusing:</b></p> <p>Toner rubs off along either edge of page. This defect is more common at the edges of high-coverage jobs and on light media types but can occur anywhere on the page.</p>		<ol style="list-style-type: none"> <li>1. Reprint the document.</li> <li>2. Check the paper type in the paper tray and adjust the printer settings to match. If necessary, select a heavier paper type.</li> <li>3. If the problem persists, go to <a href="http://support.hp.com">support.hp.com</a>.</li> </ol>

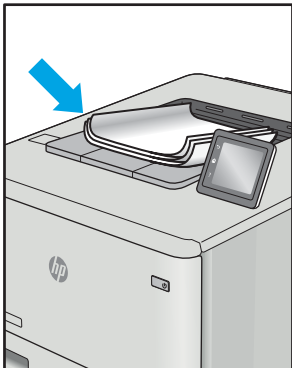
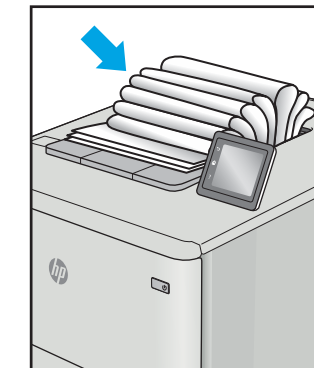
**Table 8-11 Image placement defects**

Description	Sample	Possible solutions
<p><b>Margins and skew:</b></p> <p>The image is not centered, or is skewed on the page. The defect occurs when the paper is not positioned properly as it is pulled from the tray and moves through the paper path.</p>		<ol style="list-style-type: none"> <li>1. Reprint the document.</li> <li>2. Remove the paper and then reload the tray. Make sure that all the paper edges are even on all sides.</li> <li>3. Make sure that the top of the paper stack is below the tray full indicator. Do not overfill the tray.</li> <li>4. Make sure that the paper guides are adjusted to the correct size for the paper. Do not adjust the paper guides tightly against the paper stack. Adjust them to the indentations or markings in the tray.</li> <li>5. If the problem persists, go to <a href="http://support.hp.com">support.hp.com</a>.</li> </ol>

**Table 8-12 Color plane registrations defects (color models only)**

Description	Sample	Possible solutions
<p><b>Color plane registrations:</b></p> <p>One or more color of the planes is not aligned with the other color planes. The primary error will typically occur with yellow.</p>		<ol style="list-style-type: none"> <li>1. Reprint the document.</li> <li>2. From the printer control panel, calibrate the printer.</li> <li>3. If a cartridge has reached a <b>Very Low</b> state or the printed output is severely faded, replace the cartridge.</li> <li>4. From the printer control panel use the <a href="#">Restore Calibration</a> feature to reset the printer's calibration settings to the factory defaults.</li> <li>5. If the problem persists, go to <a href="http://support.hp.com">support.hp.com</a>.</li> </ol>

**Table 8-13 Output defects**

Description	Sample	Possible solutions
<p><b>Output curl:</b></p> <p>Printed paper has curled edges. The curled edge can be along the short or long side of the paper. Two types of curl are possible:</p> <ul style="list-style-type: none"> <li>• <b>Positive curl:</b> The paper curls toward the printed side. The defect occurs in dry environments or when printing high coverage pages.</li> <li>• <b>Negative curl:</b> The paper curls away from the printed side. The defect occurs in high-humidity environments or when printing low coverage pages.</li> </ul>		<ol style="list-style-type: none"> <li>1. Reprint the document.</li> <li>2. <b>Positive curl:</b> From the printer EWS, select a heavier paper type. The heavier paper type creates a higher temperature for printing.  <b>Negative curl:</b> From the printer EWS, select a lighter paper type. The lighter paper type creates a lower temperature for printing. Try storing the paper in a dry environment prior or use freshly opened paper.</li> <li>3. Print in duplex mode.</li> <li>4. If the problem persists, go to <a href="http://support.hp.com">support.hp.com</a>.</li> </ol>
<p><b>Output stacking:</b></p> <p>The paper does not stack well in the output tray. The stack might be uneven, skewed, or the pages might be pushed out of the tray and onto the floor. Any of the following conditions can cause this defect:</p> <ul style="list-style-type: none"> <li>• Extreme paper curl</li> <li>• The paper in the tray is wrinkled or deformed</li> <li>• The paper is a non-standard paper type, such as envelopes</li> <li>• The output tray is too full</li> </ul>		<ol style="list-style-type: none"> <li>1. Reprint the document.</li> <li>2. Extend the output bin extension.</li> <li>3. If the defect is caused by extreme paper curl, complete the troubleshooting steps for Output curl.</li> <li>4. Use a different paper type.</li> <li>5. Use freshly opened paper.</li> <li>6. Remove the paper from the output tray before the tray gets too full.</li> <li>7. If the problem persists, go to <a href="http://support.hp.com">support.hp.com</a>.</li> </ol>

# Improve copy and scan image quality

## Introduction

If the printer is having image quality problems, first make sure you are using high-quality originals. If the problem still exists, try the following solutions in the order presented to resolve the issue.

- [Check the scanner glass for dirt and smudges](#)
- [Check the paper settings](#)
- [Optimize for text or pictures](#)
- [Edge-to-edge copying](#)


If the issue is not resolved, see “Improve print quality” for further solutions.

## Check the scanner glass for dirt and smudges

Over time, specks of debris might collect on the scanner glass and white plastic backing, which can affect performance. Use the following procedure to clean the scanner.

1. Press the power button to turn the printer off, and then disconnect the power cable from the electrical outlet.
2. Open the scanner lid.
3. Clean the scanner glass and the white plastic backing underneath the scanner lid with a soft cloth or sponge that has been moistened with nonabrasive glass cleaner.

---

 **CAUTION:** Do not use abrasives, acetone, benzene, ammonia, ethyl alcohol, or carbon tetrachloride on any part of the printer; these can damage the printer. Do not place liquids directly on the glass or platen. They might seep and damage the printer.

---

4. Dry the glass and white plastic parts with a chamois or a cellulose sponge to prevent spotting.
5. Connect the power cable to an outlet, and then press the power button to turn the printer on.

## Check the paper settings

1. Open the HP Embedded Web Server (EWS):
  - a. Open the HP Printer Assistant.
    - **Windows 10:** From the **Start** menu, click **All Apps**, click **HP**, and then select the printer name.
    - **Windows 8.1:** Click the down arrow in lower left corner of the **Start** screen, and then select the printer name.

- **Windows 8:** Right-click an empty area on the **Start** screen, click **All Apps** on the app bar, and then select the printer name.
  - **Windows 7:** From the computer desktop, click **Start**, select **All Programs**, click **HP**, click the folder for the printer, and then select the printer name.
- b. In the HP Printer Assistant, select **Print**, and then select **HP Device Toolbox**.
2. On the **Systems** tab, click **Paper Setup**.
  3. Change the necessary settings, and then click **Apply**.



## Optimize for text or pictures

1. Open the HP Embedded Web Server (EWS):
  - a. Open the HP Printer Assistant.
    - **Windows 10:** From the **Start** menu, click **All Apps**, click **HP**, and then select the printer name.
    - **Windows 8.1:** Click the down arrow in lower left corner of the **Start** screen, and then select the printer name.
    - **Windows 8:** Right-click an empty area on the **Start** screen, click **All Apps** on the app bar, and then select the printer name.
    - **Windows 7:** From the computer desktop, click **Start**, select **All Programs**, click **HP**, click the folder for the printer, and then select the printer name.
  - b. In the HP Printer Assistant, select **Print**, and then select **HP Device Toolbox**.
2. On the **Copy** tab, select the **Optimize** drop-down list.
3. Select the setting you want to use.
  - **Mixed:** Use this setting for documents that contain a mixture of text and graphics.
  - **Text:** Use this setting for documents that contain mostly text.
  - **Picture:** Use this setting for documents that contain mostly graphics.
4. Change the necessary settings, and then click **Apply**.

## Edge-to-edge copying

The printer cannot print fully edge-to-edge. There is a 4 mm (1/6 in) unprintable border around the page.

Considerations for printing or scanning documents with cropped edges:

- When the original is smaller than the output size, move the original 4 mm (1/6 in) away from the corner indicated by the icon on the scanner. Recopy or scan in this position.
- When the original is the size of the printed output that you want, use the [Reduce/Enlarge](#) feature to reduce the image so the copy is not cropped.

# Solve wireless network problems

- [Introduction](#)
- [Wireless connectivity checklist](#)
- [The printer does not print after the wireless configuration completes](#)
- [The printer does not print, and the computer has a third-party firewall installed](#)
- [The wireless connection does not work after moving the wireless router or printer](#)
- [Cannot connect more computers to the wireless printer](#)
- [The wireless printer loses communication when connected to a VPN](#)
- [The network does not appear in the wireless networks list](#)
- [The wireless network is not functioning](#)
- [Perform a wireless network diagnostic test](#)
- [Reduce interference on a wireless network](#)

## Introduction

Use the troubleshooting information to help resolve issues.






---

**NOTE:** To determine whether Wi-Fi Direct printing is enabled on your printer, print a configuration page from the printer control panel

---

## Wireless connectivity checklist

- Verify that the printer and the wireless router are turned on and have power. Also make sure that the wireless radio in the printer is turned on.
- Verify that the service set identifier (SSID) is correct. Print a configuration page to determine the SSID:
  - a. Press and hold the Start Copy  button until the Ready  light begins blinking.
  - b. Release the Start Copy  button.

If you are not sure the SSID is correct, run the wireless setup again

- With secured networks, verify that the security information is correct. If the security information is incorrect, run the wireless setup again.
- If the wireless network is working correctly, try accessing other computers on the wireless network. If the network has Internet access, try connecting to the Internet over a wireless connection.
- Verify that the encryption method (AES or TKIP) is the same for the printer as it is for the wireless access point (on networks using WPA security).
- Verify that the printer is within the range of the wireless network. For most networks, the printer must be within 30 m (100 ft) of the wireless access point (wireless router).

- Verify that obstacles do not block the wireless signal. Remove any large metal objects between the access point and the printer. Make sure poles, walls, or support columns containing metal or concrete do not separate the printer and wireless access point.
- Verify that the printer is located away from electronic devices that might interfere with the wireless signal. Many devices can interfere with the wireless signal including motors, cordless phones, security system cameras, other wireless networks, and some Bluetooth devices.
- Verify that the print driver is installed on the computer.
- Verify that you have selected the correct printer port.
- Verify that the computer and printer connect to the same wireless network.
- For OS X, verify that the wireless router supports Bonjour.

### The printer does not print after the wireless configuration completes

1. Make sure that the printer is turned on and in the ready state.
2. Turn off any third-party firewalls on your computer.
3. Make sure that the wireless network is working correctly.
4. Make sure that your computer is working correctly. If necessary, restart the computer.
5. Verify that you can open the printer HP Embedded Web Server from a computer on the network.

### The printer does not print, and the computer has a third-party firewall installed

1. Update the firewall with the most recent update available from the manufacturer.
2. If programs request firewall access when you install the printer or try to print, make sure you allow the programs to run.
3. Temporarily turn off the firewall, and then install the wireless printer on the computer. Enable the firewall when you have completed the wireless installation.

### The wireless connection does not work after moving the wireless router or printer

1. Make sure that the router or printer connects to the same network that your computer connects to.
2. Print a configuration page.
3. Compare the service set identifier (SSID) on the configuration page to the SSID in the printer configuration for the computer.
4. If the numbers are not the same, the devices are not connecting to the same network. Reconfigure the wireless setup for the printer.

### Cannot connect more computers to the wireless printer

1. Make sure that the other computers are within the wireless range and that no obstacles block the signal. For most networks, the wireless range is within 30 m (100 ft) of the wireless access point.
2. Make sure that the printer is turned on and in the ready state.
3. Make sure there are not more than 5 concurrent Wi-Fi Direct users.

4. Turn off any third-party firewalls on your computer.
5. Make sure that the wireless network is working correctly.
6. Make sure that your computer is working correctly. If necessary, restart the computer.




## The wireless printer loses communication when connected to a VPN

- Typically, you cannot connect to a VPN and other networks at the same time.

## The network does not appear in the wireless networks list

- Make sure the wireless router is turned on and has power.
- The network might be hidden. However, you can still connect to a hidden network.




## The wireless network is not functioning


1. To verify if the network has lost communication, try connecting other devices to the network.
2. Test network communication by pinging the network.
  - a. Open a command-line prompt on your computer.
    - For Windows, click **Start**, click **Run**, type `cmd`, and then press **Enter**.
    - For OS X, go to **Applications**, then **Utilities**, and open **Terminal**.
  - b. Type `ping` followed by the router IP address.
  - c. If the window displays round-trip times, the network is working.
3. Make sure that the router or printer connects to the same network that the computer connects to.
  - a. Print a configuration page.
    - a. Press and hold the Start Copy  button until the Ready  light begins blinking.
    - b. Release the Start Copy .
  - b. Compare the service set identifier (SSID) on the configuration report to the SSID in the printer configuration for the computer.
  - c. If the numbers are not the same, the devices are not connecting to the same network. Reconfigure the wireless setup for the printer.


## Perform a wireless network diagnostic test

From the printer control panel, you can run a diagnostic test that provides information about the wireless network settings.

1. Open the HP Embedded Web Server (EWS):
  - a. Print a configuration page to determine the IP address or host name.

- i. Press and hold the Start Copy  button until the Ready  light begins blinking.
  - ii. Release the Start Copy  button.
- b. Open a web browser, and in the address line, type the IP address or host name exactly as it displays on the printer configuration page. Press the **Enter** key on the computer keyboard. The EWS opens.

 <https://10.10.XX.XXX/>

 **NOTE:** If the displays a message indicating that accessing the website might not be safe, select the option to continue to the website. Accessing this website will not harm the computer.

2. Select the **Networking** tab.
3. On the **Wireless Configuration** page, verify that the On option is selected.
4. Click the **Print Test Report** button to print a test page that shows test results.

## Reduce interference on a wireless network

The following tips can reduce interference in a wireless network:

- Keep the wireless devices away from large metal objects, such as filing cabinets, and other electromagnetic devices, such as microwaves and cordless telephones. These objects can disrupt radio signals.
- Keep the wireless devices away from large masonry structures and other building structures. These objects can absorb radio waves and lower signal strength.
- Position the wireless router in a central location in line of sight with the wireless printers on the network.



# Index

## A

- accessories
  - ordering 16
  - part numbers 16
- acoustic specifications 8
- AirPrint 29
- Android devices
  - printing from 30

## B

- bin, output
  - jams, clearing 71
- bins, output
  - locating 3
- browser requirements
  - HP Embedded Web Server 41

## C

- checklist
  - wireless connectivity 90
- cleaning
  - glass 87
  - paper path 76
- clearing jams
  - locations 64
- control panel
  - LED light patterns 56
  - locating 3
- copy identification card 33
- copying
  - edge-to-edge 89
  - identification card 33
  - multiple copies 32
  - optimizing for text or pictures 89
  - setting paper size and type 87
  - single copies 32
- covers, locating 3
- customer support
  - online 54

## D

- defaults, restoring 60
- dimensions, printer 8
- double-sided printing
  - Mac 25
  - Windows 23
- drivers, supported 6
- duplex printing
  - Mac 25
- duplex printing (double-sided)
  - Windows 23
- duplexing
  - manually (Mac) 25
  - manually (Windows) 23

## E

- economy settings 49
- electrical specifications 8
- Embedded Web Server (EWS)
  - assigning passwords 47
  - features 41
- envelope
  - orientation 13
- envelopes, loading 13
- Explorer, versions supported
  - HP Embedded Web Server 41

## F

- factory-set defaults, restoring 60

## G

- glass, cleaning 87

## H

- HP Customer Care 54
- HP Device Toolbox, using 41
- HP Easy Scan Software (OS X) 37
- HP Embedded Web Server (EWS)
  - features 41

- HP EWS, using 41
- HP Scan software (Windows) 36
- HP Utility 43
- HP Utility for Mac
  - Bonjour 43
  - features 43
- HP Utility, Mac 43

## I

- image quality
  - check toner-cartridge status 74
- image quality issues
  - examples and solutions 79
- interface ports
  - locating 3
- Internet Explorer, versions supported
  - HP Embedded Web Server 41

## J

- jams
  - locations 64
  - output-bin, clearing 71
  - tray, clearing 67

## L

- label
  - orientation 14
- labels
  - printing on 14
- labels, loading 14

## M

- Macintosh
  - HP Utility 43
- manual duplex
  - Mac 25
  - Windows 23
- memory
  - included 6

- mobile printing
  - Android devices 30
- mobile printing solutions 6
- mobile printing, software supported 7
- multiple pages per sheet
  - printing (Mac) 25
  - printing (Windows) 23

## N

- network installation 40
- network port
  - locating 3
- networks
  - installing the printer 40
  - supported 6
- number of copies, changing 32

## O

- on/off button, locating 3
- online support 54
- operating systems (OS)
  - supported 6
- operating systems, supported 6
- ordering
  - supplies and accessories 16
- OS (operating system)
  - supported 6
- output bin
  - locating 3

## P

- pages per minute 6
- pages per sheet
  - selecting (Mac) 25
  - selecting (Windows) 23
- paper
  - selecting 76
- paper jams. *See* jams
- paper pickup problems
  - solving 63
- paper type
  - selecting (Windows) 24
- paper types
  - selecting (Mac) 26
- paper, ordering 16
- part numbers 16
  - accessories 16
  - supplies 16
- power
  - consumption 8

- power connection
  - locating 3
- power switch, locating 3
- power-down delay
  - setting 51
- print drivers, supported 6
- print on both sides
  - Mac 25
  - manually, Windows 23
  - Windows 23
- product and serial number label
  - locating 3

## R

- restoring factory-set defaults 60

## S

- scanner
  - glass cleaning 87
- scanning
  - from HP Easy Scan Software (OS X) 37
  - from HP Scan software (Windows) 36
- serial number label
  - locating 3
- settings
  - factory-set defaults, restoring 60
- shut down after delay
  - setting 50
- single-sheet priority feed slot
  - loading envelopes 13
  - loading labels 14
- sleep delay
  - disabling 49
  - enabling 49
- software
  - HP Utility 43
- specifications
  - electrical and acoustic 8
- status
  - control panel lights 56
  - HP Utility, Mac 43
- supplies
  - low threshold settings 61
  - ordering 16
  - part numbers 16
  - status, viewing with HP Utility for Mac 43
  - using when low 61

- support
  - online 54
- system requirements
  - HP Embedded Web Server 41

## T

- technical support
  - online 54
- toner cartridge
  - low threshold settings 61
  - using when low 61
- toner cartridges
  - part numbers 16
- tray
  - jams, clearing 67
- Tray 1
  - loading envelopes 13
  - loading labels 14
- trays
  - capacity 6
  - included 6
  - loading 12
  - locating 3
- troubleshooting
  - check toner-cartridge status 74
  - LED, errors 56
  - LED, light patterns 56
  - paper feed problems 63
  - wireless network 90

## U

- USB port
  - locating 3

## W

- web browser requirements
  - HP Embedded Web Server 41
- Web sites
  - customer support 54
- weight, printer 8
- Wi-Fi Direct printing 7, 27
- wireless network
  - troubleshooting 90
- wireless network interference 93