



**HP OfficeJet 3830 All-in-One series**



---

# Table of contents

<b>1 HP OfficeJet 3830 series Help</b> .....	<b>1</b>
<b>2 Get started</b> .....	<b>3</b>
Printer parts .....	4
Control panel and status lights .....	5
Load media .....	7
Load original .....	11
Paper basics .....	13
Open the HP printer software (Windows) .....	15
Sleep mode .....	16
Quiet Mode .....	17
Auto-Off .....	19
<b>3 Print</b> .....	<b>21</b>
Print from your computer .....	22
Print Quick Forms .....	28
Print from your mobile device .....	29
Print with AirPrint .....	30
Tips for print success .....	31
<b>4 Use Web Services</b> .....	<b>35</b>
What are Web Services? .....	36
Set up Web Services .....	37
Print with HP ePrint .....	38
Use HP Printables .....	39
Use the HP Connected website .....	40
Remove Web Services .....	41
<b>5 Copy and scan</b> .....	<b>43</b>
Copy .....	44
Scan using the printer control panel .....	46

Scan using the HP printer software .....	47
Scan using Webscan .....	51
Tips for copy and scan success .....	52
<b>6 Fax .....</b>	<b>53</b>
Send a fax .....	54
Receive a fax .....	57
Set up phone book contacts .....	61
Change fax settings .....	64
Fax and digital phone services .....	68
Fax on Voice over Internet Protocol .....	69
Use reports .....	70
<b>7 Manage ink cartridges .....</b>	<b>75</b>
Check estimated ink levels .....	76
Order ink supplies .....	77
Choose right ink cartridges .....	78
Replace ink cartridges .....	79
Use single-cartridge mode .....	82
Cartridge warranty information .....	83
Tips for working with ink cartridges .....	84
<b>8 Connect your printer .....</b>	<b>85</b>
Connect your printer to a wireless network with a router .....	86
Connect wirelessly to the printer without a router .....	87
Wireless settings .....	90
Connect your printer to your computer with a USB cable (non-network connection) .....	92
Change from a USB connection to a wireless network .....	93
Advanced printer management tools (for networked printers) .....	94
Tips for setting up and using a networked printer .....	96
<b>9 Solve a problem .....</b>	<b>97</b>
Jams and paper-feed issues .....	98
Ink cartridge issues .....	104
Printing issues .....	107
Copy issues .....	116
Scan issues .....	117
Fax issues .....	118
Network and connection issues .....	126
Printer hardware issues .....	128

Maintain the document feeder .....	129
HP support .....	130
<b>Appendix A Technical information .....</b>	<b>133</b>
Hewlett-Packard Company notices .....	134
Specifications .....	135
Environmental product stewardship program .....	138
Regulatory notices .....	146
<b>Appendix B Additional fax setup .....</b>	<b>157</b>
Set up faxing (parallel phone systems) .....	158
Test fax setup .....	178
<b>Index .....</b>	<b>179</b>



---

# 1 HP OfficeJet 3830 series Help

Learn how to use your HP OfficeJet 3830 series.

- [Printer parts on page 4](#)
- [Control panel and status lights on page 5](#)
- [Load media on page 7](#)
- [Print on page 21](#)
- [Copy on page 44](#)
- [Scan to a computer on page 47](#)
- [Check estimated ink levels on page 76](#)
- [Replace ink cartridges on page 79](#)
- [Clear a paper jam on page 98](#)





---

## 2 Get started

- [Printer parts](#)
- [Control panel and status lights](#)
- [Load media](#)
- [Load original](#)
- [Paper basics](#)
- [Open the HP printer software \(Windows\)](#)
- [Sleep mode](#)
- [Quiet Mode](#)
- [Auto-Off](#)

## Printer parts

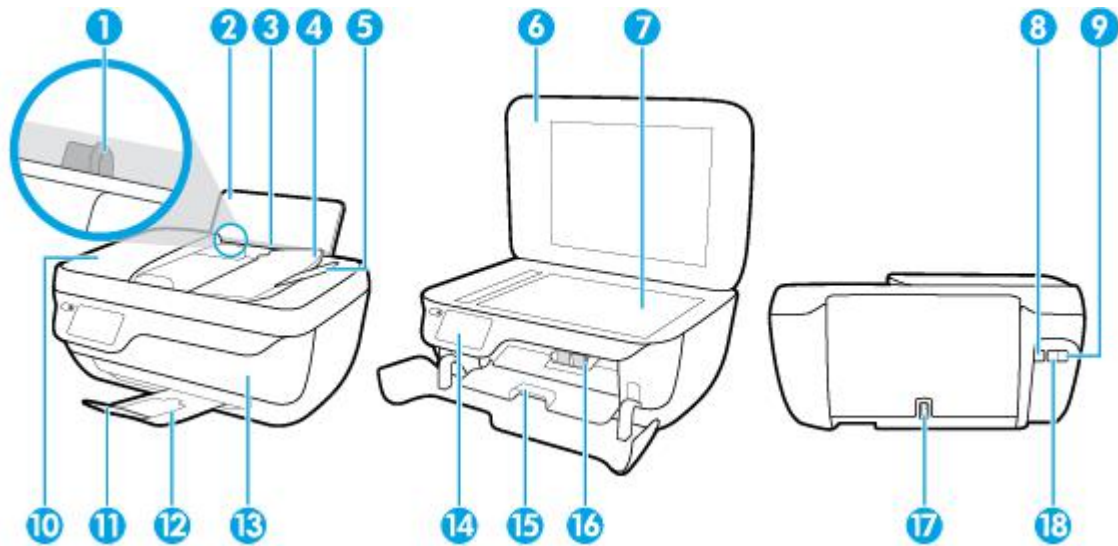

1	Paper-width guide
2	Input tray
3	Input tray shield
4	Document feeder tray
5	Document feeder tray extender
6	Scanner lid
7	Scanner glass
8	USB port
9	Fax port (2-EXT)
10	Document feeder
11	Output tray extender (also referred to as the tray extender)
12	Output tray
13	Front door
14	Control panel
15	Cartridge access door
16	Ink cartridges
17	Power connection
18	Fax port (1-LINE)

# Control panel and status lights

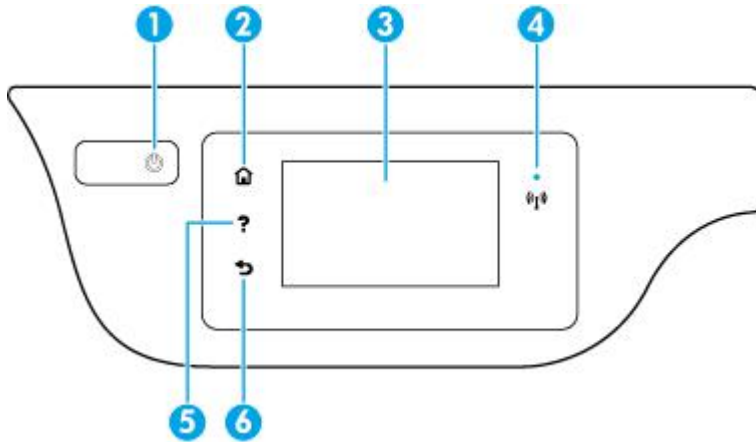

- [Overview of buttons and lights](#)
- [Control panel display icons](#)

## Overview of buttons and lights



Label	Name and Description
1	<b>Power</b> button: Turns the printer on or off.
2	<b>Home</b> button: Returns to the Home screen, the screen that is displayed when you first turn on the printer.
3	Control panel display: Touch the screen to select menu options, or scroll through the menu items.
4	Wireless light: Indicates the status of the printer wireless connection. <ul style="list-style-type: none"><li>• Solid blue light indicates that wireless connection has been established and you can print.</li><li>• Slow blinking light indicates that wireless is on, but the printer is not connected to a network. Make sure your printer is within the range of wireless signal.</li><li>• Fast blinking light indicates wireless error. Refer to the message on the printer display.</li><li>• If wireless is turned off, the wireless light is off and the display screen shows <b>Wireless Off</b>.</li></ul>
5	<b>Help</b> button: Opens the Help menu for the current operation.
6	<b>Back</b> button: Returns to the previous screen.

## Control panel display icons

Icon	Purpose
	<b>Copy</b> : Opens the <b>Copy</b> menu where you can select a copy type or change copy settings.
	<b>Scan</b> : Displays a screen where you can select a destination for your scan.
	<b>Fax</b> : Displays a screen where you can send a fax, or change fax settings

Icon	Purpose
	<b>HP Printables:</b> Provides a quick and easy way to access and print information from the web, such as coupons, coloring pages, puzzles, and more.
	<b>Quick Forms :</b> Opens the <b>Quick Forms</b> menu where you can select a form to print.
	<b>Setup :</b> Opens the <b>Setup</b> menu where you can change preferences and use tools to perform maintenance functions.
	<b>Help :</b> Opens the <b>Help</b> menu where you can view How to Videos, printer feature information, and tips.
	ePrint icon: Opens the <b>Web Services Summary</b> menu, where you can check ePrint status details, change ePrint settings, or print an Info page.
	Wi-Fi Direct icon: Opens the <b>Wi-Fi Direct Details</b> menu where you can turn on Wi-Fi Direct, turn off Wi-Fi Direct, and display the Wi-Fi Direct name and password.
	Wireless icon: Opens the <b>Wireless</b> menu where you can check wireless status and change wireless settings. You can also print a wireless test report, helping diagnose network connection issues.
	Fax Status icon: Displays status information for the Auto Answer function, fax logs, and the fax sound volume.
	<p>Ink icon: Shows estimated ink levels by cartridge. Displays a warning symbol if the ink level is less than the minimum expected ink level.</p> <p><b>NOTE:</b> Ink level warnings and indicators provide estimates for planning purposes only. When you receive a low-ink warning message, consider having a replacement cartridge available to avoid possible printing delays. You do not need to replace cartridges until the print quality becomes unacceptable.</p>

## Load media

Select a paper size to continue.

### To load full-size paper

1. Pull out the input tray.



2. Slide the paper-width guide to the left.

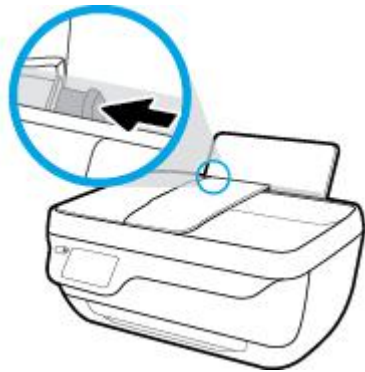

3. Insert a stack of paper into the input tray with the short edge down and the print side up, and slide the stack of paper down until it stops.

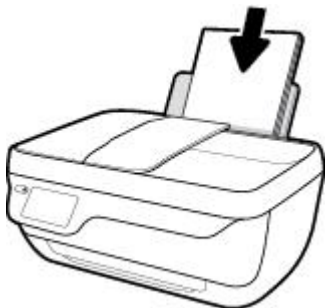

4. Slide the paper-width guide to the right until it stops at the edge of the paper.

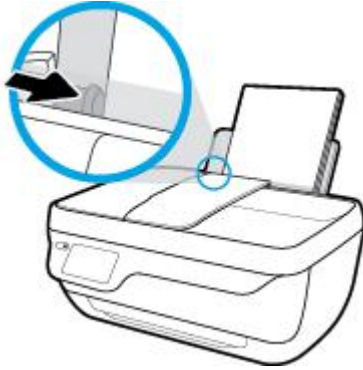

5. Pull out the output tray and the tray extender.



#### To load small-size paper

1. Pull out the input tray.



2. Slide the paper-width guide to the left.



3. Insert a stack of photo paper into the far-right side of the input tray with the short edge down and the print side up, and slide the stack of paper down until it stops.



4. Slide the paper-width guide to the right until it stops at the edge of the paper.

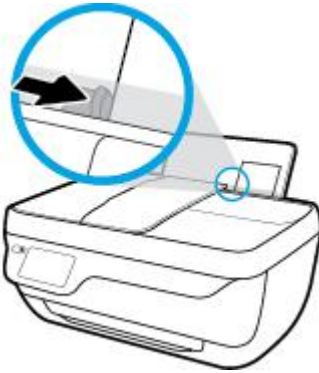

5. Pull out the output tray and the tray extender.



### To load envelopes

1. Pull out the input tray.



2. Slide the paper-width guide to the left.

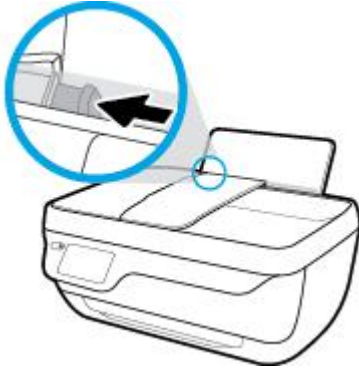

3. Insert one or more envelopes into the far-right side of the input tray and slide the stack of envelopes down until it stops.

The side to be printed on should face up. The flap should be on the left side and facing down.



4. Slide the paper-width guide to the right against the stack of envelopes until it stops.

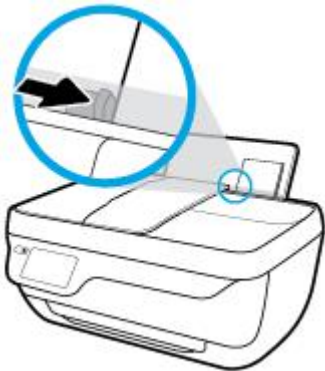

5. Pull out the output tray and the tray extender.





# Load original

## To load an original in the document feeder

 **NOTE:** Load only plain paper in the document feeder. Do not load photos or other types of thick paper in the document feeder; this might cause a paper jam.

---

1. Open the document feed tray and tray extender.



2. Slide the paper-width guides of the document feeder tray outwards.



3. Load the original print-side up, head first, in the document feeder.

 **NOTE:** Load the plain paper original only. Photos or other types of thick paper might cause a paper jam.

---



4. Slide the paper-width guides inward until they stop at the edge of paper.



## To load an original on the scanner glass

1. Lift the scanner lid.

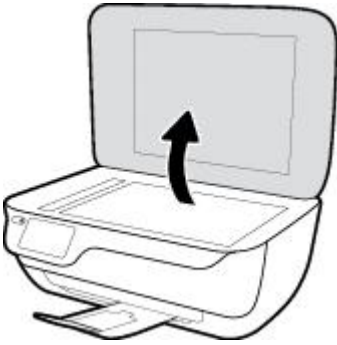

2. Load the original print-side down on the right corner of the scanner glass.



3. Close the scanner lid.



## Paper basics

The printer is designed to work well with most types of office paper. It is best to test a variety of print paper types before buying large quantities. Use HP paper for optimum print quality. Visit the HP website at [www.hp.com](http://www.hp.com) for more information about HP paper.



HP recommends plain papers with the ColorLok logo for printing everyday documents. All papers with the ColorLok logo are independently tested to meet high standards of reliability and print quality, and produce documents with crisp, vivid color, bolder blacks, and that dry faster than ordinary plain papers. Look for papers with the ColorLok logo in a variety of weights and sizes from major paper manufacturers.

This section contains the following topics:

- [Recommended papers for printing](#)
- [Order HP paper supplies](#)

## Recommended papers for printing

If you want the best print quality, HP recommends using HP papers that are specifically designed for the type of project you are printing.

Depending on your country/region, some of these papers might not be available.

### Photo printing

- **HP Premium Plus Photo Paper**

HP Premium Plus Photo Paper is HP's highest-quality photo paper for your best photos. With HP Premium Plus Photo Paper, you can print beautiful photos that are instant-dry so you can share them right off the printer. It is available in several sizes, including A4, 8.5 x 11 inches, 4 x 6 inches (10 x 15 cm), 5 x 7 inches (13 x 18 cm), and in two finishes - glossy or soft gloss (semi-gloss). Ideal for framing, displaying, or gifting your best photos and special photo projects. HP Premium Plus Photo Paper delivers exceptional results with professional quality and durability.

- **HP Advanced Photo Paper**

This glossy photo paper features an instant-dry finish for easy handling without smudging. It resists water, smears, fingerprints, and humidity. Your prints have a look and feel comparable to a store-processed photo. It is available in several sizes, including A4, 8.5 x 11 inches, 10 x 15 cm (4 x 6 inches), 13 x 18 cm (5 x 7 inches). It is acid-free for longer lasting documents.

- **HP Everyday Photo Paper**

Print colorful, everyday snapshots at a low cost, using paper designed for casual photo printing. This affordable photo paper dries quickly for easy handling. Get sharp, crisp images when you use this paper with any inkjet printer. It is available in glossy finish in several sizes, including A4, 8.5 x 11 inches, 5 x 7 inches, and 4 x 6 inches (10 x 15 cm). It is acid-free for longer lasting documents.

- **HP Photo Value Packs**

HP Photo Value Packs conveniently package original HP ink cartridges and HP Advanced Photo Paper to save you time and take the guesswork out of printing affordable, lab-quality photos with your HP

printer. Original HP inks and HP Advanced Photo Paper have been designed to work together so your photos are long lasting and vivid, print after print. Great for printing out an entire vacation's worth of photos or multiple prints to share.

### Business documents

- **HP Premium Presentation Paper 120g Matte or HP Professional Paper 120 Matt**

This paper is a heavy two-sided matte paper perfect for presentation, proposals, reports, and newsletters. It is heavyweight for an impressive look and feel.

- **HP Brochure Paper 180g Glossy or HP Professional Paper 180 Glossy**

These papers are glossy-coated on both sides for two-sided use. They are the perfect choice for near-photographic reproductions and business graphics for report covers, special presentations, brochures, mailers, and calendars.

- **HP Brochure Paper 180g Matte or HP Professional Paper 180 Matte**

These papers are matte-coated on both sides for two-sided use. They are the perfect choice for near-photographic reproductions and business graphics for report covers, special presentations, brochures, mailers, and calendars.

### Everyday printing

All the papers listed for everyday printing feature ColorLok Technology for less smearing, bolder blacks, and vivid colors.

- **HP Bright White Inkjet Paper**

HP Bright White Inkjet Paper delivers high-contrast colors and sharp text. It is opaque enough for two-sided color usage with no show-through, which makes it ideal for newsletters, reports, and flyers.

- **HP Printing Paper**

HP Printing Paper is a high-quality multifunction paper. It produces documents that look and feel more substantial than documents printed on standard multipurpose or copy paper. It is acid-free for longer lasting documents.

- **HP Office Paper**

HP Office Paper is a high-quality multifunction paper. It is suitable for copies, drafts, memos, and other everyday documents. It is acid-free for longer lasting documents.

- **HP Office Recycled Paper**

HP Office Recycled Paper is a high-quality multifunction paper made with 30% recycled fiber.

### Order HP paper supplies

The printer is designed to work well with most types of office paper. Use HP paper for optimum print quality.

To order HP papers and other supplies, go to [www.hp.com](http://www.hp.com). At this time, some portions of the HP website are available in English only.

HP recommends plain papers with the ColorLok logo for printing and copying of everyday documents. All papers with the ColorLok logo are independently tested to meet high standards of reliability and print quality, and produce documents with crisp, vivid color, bolder blacks and shorter dry-time than ordinary plain papers. Look for papers with the ColorLok logo in a variety of weights and sizes from major paper manufacturers.

## Open the HP printer software (Windows)

After installing the HP printer software, double-click the printer icon on the desktop or do one of the following to open the printer software:

- **Windows 8.1:** Click the down arrow in lower left corner of the Start screen, and then select the printer name.
- **Windows 8:** Right-click an empty area on the Start screen, click **All Apps** on the app bar, and then select the printer name.
- **Windows 7, Windows Vista, and Windows XP:** From the computer desktop, click **Start**, select **All Programs**, click **HP**, click the folder for the printer, and then select the icon with the printer's name.

## Sleep mode

Power usage is reduced while in Sleep mode.

After initial setup of printer, the printer will enter Sleep mode after 5 minutes of inactivity.

The **Power** button light is dimmed in Sleep mode.

### To change the time to Sleep mode

1. From the Home screen, touch **Setup** .
2. Touch **Power Handling**.
3. Touch **Sleep Mode**, and then touch the desired option.

# Quiet Mode

Quiet Mode slows down printing to reduce overall noise without affecting print quality. Quiet Mode only works for printing with **Normal** print quality on plain paper. To reduce printing noise, turn on Quiet Mode. To print at normal speed, turn Quiet Mode off. Quiet mode is off by default.

 **NOTE:** In Quiet Mode, if you print on plain paper with the **Draft** or **Best** print quality, or if you print photos or envelopes, the printer works in the same way as when Quiet Mode is off.

You can create a schedule by selecting the time when the printer prints in Quiet Mode. For example, you can schedule the printer to be in Quiet Mode from 10 p.m. to 8 a.m. everyday. Quiet Mode is off by default.

## Turn Quiet Mode on or off

### To turn Quiet Mode on or off from the printer control panel

1. From the Home screen, touch **Setup** .
2. Touch **Preferences** , and then touch **Quiet Mode**.
3. Touch **On** or **Off** next to **Quiet Mode**.

### To turn Quiet Mode on or off from the printer software (Windows)

1. Open the HP printer software. For more information, see [Open the HP printer software \(Windows\) on page 15](#).
2. Click the **Quiet Mode** tab.
3. Click **On** or **Off**.
4. Click **Save Settings**.

### To turn Quiet Mode on or off from the Embedded Web Server (EWS)

1. Open the EWS. For more information, see [Open the Embedded Web Server on page 94](#).
2. Click the **Settings** tab.
3. In the **Preferences** section, select **Quiet Mode**, and then select **On** or **Off**.
4. Click **Apply**.

## Create a schedule for Quiet Mode

### To create a schedule for Quiet Mode from the printer control panel

1. From the Home screen, touch **Setup** .
2. Touch **Preferences** , and then touch **Quiet Mode**.
3. Touch **Off** next to **Quiet Mode** to turn it on, and then touch **OK** to confirm.
4. Touch **Off** next to **Schedule**, and then change start time and end time of the schedule.

### To turn Quiet Mode on or off from the printer software (Windows)

1. Open the HP printer software. For more information, see [Open the HP printer software \(Windows\) on page 15](#).
2. Click the **Quiet Mode** tab.
3. Click **On** in the **Quiet Mode** area.
4. Specify the start time and stop time in the **Schedule Quiet Mode** area.
5. Click **Save Settings**.

### To create a schedule for Quiet Mode from the Embedded Web Server (EWS)

1. Open the EWS. For more information, see [Open the Embedded Web Server on page 94](#).
2. Click the **Settings** tab.
3. In the **Preferences** section, select **Quiet Mode**, and then select **On** in the **Quiet Mode** area.
4. Specify the start time and end time in the **Schedule Quiet Mode** area.
5. Click **Apply**.



## Auto-Off

This feature turns the printer off after 2 hours of inactivity to help reduce energy use. **Auto-Off turns the printer off completely, so you must use the Power button to turn the printer back on.** If your printer supports this energy saving feature, Auto-Off is automatically enabled or disabled depending on printer capabilities and connection options. Even when Auto-Off is disabled, the printer enters Sleep mode after 5 minutes of inactivity to help reduce energy use.

- Auto-Off is enabled when the printer is turned on, if the printer does not have network or fax capability, or is not using these capabilities.
- Auto-Off is disabled when a printer's wireless or Wi-Fi Direct capability is turned on or when a printer with fax, USB, or Ethernet network capability establishes a fax, USB, or Ethernet network connection.



---

# 3 Print

- [Print from your computer](#)
- [Print Quick Forms](#)
- [Print from your mobile device](#)
- [Print with AirPrint](#)
- [Tips for print success](#)

# Print from your computer

- [Print documents](#)
- [Print photos](#)
- [Print envelopes](#)
- [Print using the maximum dpi](#)

## Print documents

Before printing documents, make sure you have paper loaded in the input tray and the output tray is pulled out. For more information about loading paper, see [Load media on page 7](#).

### To print a document (Windows)

1. From your software, select **Print**.
2. Make sure your printer is selected.
3. Click the button that opens the **Properties** dialog box.

Depending on your software application, this button might be called **Properties**, **Options**, **Printer Setup**, **Printer Properties**, **Printer**, or **Preferences**.

4. Select the appropriate options.
  - On the **Layout** tab, select **Portrait** or **Landscape** orientation.
  - On the **Paper/Quality** tab, select the appropriate paper type from the **Media** drop-down list in the **Tray Selection** area, select the appropriate print quality in the **Quality Settings** area, and then select the appropriate color in the **Color** area.
  - Click **Advanced** to select the appropriate paper size from the **Paper Size** drop-down list.
5. Click **OK** to close the **Properties** dialog box.
6. Click **Print** or **OK** to begin printing.

### To print documents (OS X)

1. From the **File** menu in your software, choose **Print**.
2. Make sure your printer is selected.
3. Specify the page properties.

If you do not see options on the Print dialog, click **Show Details**.



**NOTE:** The following options are available for a USB connected printer. Locations for the options can vary from one application to another.

- Choose the paper size.



---

**NOTE:** If you change the **Paper Size** ensure that you have loaded the correct paper and set the paper size on the printer control panel to match.

---

- Select the orientation.
  - Enter the scaling percentage.
4. Click **Print**.

#### To print on both sides of the page (Windows)

1. From your software, select **Print**.
2. Make sure your printer is selected.
3. Click the button that opens the **Properties** dialog box.

Depending on your software application, this button might be called **Properties, Options, Printer Setup, Printer Properties, Printer, or Preferences**.

4. Select the appropriate options.
  - On the **Layout** tab, select **Portrait** or **Landscape** orientation.
  - On the **Paper/Quality** tab, select the appropriate paper type from the **Media** drop-down list in the **Tray Selection** area, select the appropriate print quality in the **Quality Settings** area, and then select the appropriate color in the **Color** area.
  - Click **Advanced** to select the appropriate paper size from the **Paper Size** drop-down list.
5. On the **Layout** tab, select an appropriate option from the **Print on Both Sides Manually** drop-down list.
6. After you print the first side, follow the on-screen instructions to reload the paper with the blank side up and top of the page down, and then click **Continue**.
7. Click **OK** to print.

#### To print on both sides of the page (OS X)

1. From the **File** menu in your software, choose **Print**.
2. In the Print dialog, choose **Paper Handling** from the pop-up menu and set **Page Order** to **Normal**.
3. Set **Pages to Print** to **Odd only**.
4. Click **Print**.
5. After all of the odd numbered pages have printed, remove the document from the output tray.
6. Reload the document so that the end that came out of the printer is now going into the printer and the blank side of the document is facing toward the front of the printer.
7. In the Print dialog, return to the **Paper Handling** pop-up menu and set the page order to **Normal** and the pages to print to **Even Only**.
8. Click **Print**.

## Print photos

Before printing photos, make sure you have photo paper loaded in the input tray and the output tray is open. For more information about loading paper, see [Load media on page 7](#).

### To print a photo on photo paper (Windows)

1. From your software, select **Print**.
2. Make sure your printer is selected.
3. Click the button that opens the **Properties** dialog box.

Depending on your software application, this button might be called **Properties**, **Options**, **Printer Setup**, **Printer Properties**, **Printer**, or **Preferences**.

4. Select the appropriate options.
  - On the **Layout** tab, select **Portrait** or **Landscape** orientation.
  - On the **Paper/Quality** tab, select the appropriate paper type from the **Media** drop-down list in the **Tray Selection** area, select the appropriate print quality in the **Quality Settings** area, and then select the appropriate color in the **Color** area.
  - Click **Advanced** to select the appropriate photo size from the **Paper Size** drop-down list.
5. Click **OK** to return to the **Properties** dialog box.
6. Click **OK**, and then click **Print** or **OK** in the **Print** dialog box.

---

 **NOTE:** After the printing is finished, remove unused photo paper from the input tray. Store the photo paper so it does not start to curl, which could reduce the quality of your printout.

---

### To print a photo from the computer (OS X)

1. From the **File** menu in your software, choose **Print**.
2. Make sure your printer is selected.
3. Set the print options.

If you do not see options on the Print dialog, click **Show Details**.

---

 **NOTE:** The following options are available for a USB connected printer. Locations for the options can vary from one application to another.

---

- a. Choose the appropriate paper size in the **Paper Size** pop-up menu.

---

 **NOTE:** If you change the **Paper Size** ensure that you have loaded the correct paper and set the paper size on the printer control panel to match.

---

- b. Select an **Orientation**.
- c. From the pop-up menu, choose **Paper Type/Quality**, and then choose the following settings:

- **Paper Type:** The appropriate photo paper type
  - **Quality: Best or Maximum dpi**
  - Click the **Color Options** disclosure triangle, and then choose the appropriate **Photo Fix** option.
    - **Off:** applies no changes to the image.
    - **Basic:** automatically focuses the image; moderately adjusts image sharpness.
4. Select any other print settings you want, and then click **Print**.

## Print envelopes

Before printing envelopes, make sure you have envelopes loaded in the input tray and the output tray is open. You can load one or more envelopes into the input tray. Do not use shiny or embossed envelopes or envelopes that have clasps or windows. For more information about loading envelopes, see [Load media on page 7](#).

---

 **NOTE:** For specific details on how to format text for printing on envelopes, consult the help files in your word application.

---

### To print an envelope (Windows)

1. From your software, select **Print**.
2. Make sure your printer is selected.
3. Click the button that opens the **Properties** dialog box.
 

Depending on your software application, this button might be called **Properties**, **Options**, **Printer Setup**, **Printer Properties**, **Printer**, or **Preferences**.
4. Select the appropriate options.
  - On the **Layout** tab, select **Portrait** or **Landscape** orientation.
  - On the **Paper/Quality** tab, select the appropriate paper type from the **Media** drop-down list in the **Tray Selection** area, select the appropriate print quality in the **Quality Settings** area, and then select the appropriate color in the **Color** area.
  - Click **Advanced** to select the appropriate envelope size from the **Paper Size** drop-down list.
5. Click **OK**, and then click **Print** or **OK** in the **Print** dialog box.

### To print envelopes (OS X)

1. From the **File** menu in your software, choose **Print**.
2. Make sure your printer is selected.
3. Set the print options.
 

If you do not see options on the Print dialog, click **Show Details**.

---

 **NOTE:** The following options are available for a USB connected printer. Locations for the options can vary from one application to another.

---

- a. Select the appropriate envelope size from the **Paper Size** pop-up menu.



---

**NOTE:** If you change the **Paper Size** ensure that you have loaded the correct paper.

---

- b. From the pop-up menu, choose **Paper Type/Quality**, and verify the paper type setting is set to **Plain Paper**.
4. Click **Print**.

## Print using the maximum dpi

Use maximum dots per inch (dpi) to print high-quality, sharp images on photo paper.

Printing in maximum dpi takes longer than printing with other settings and requires a large amount of disk space.

### To print in maximum dpi mode (Windows)

1. From your software, select **Print**.
2. Make sure your printer is selected.
3. Click the button that opens the **Properties** dialog box.

Depending on your software application, this button might be called **Properties**, **Options**, **Printer Setup**, **Printer Properties**, **Printer**, or **Preferences**.

4. Click the **Paper/Quality** tab.
5. From the **Media** drop-down list, select an appropriate paper type.
6. Click the **Advanced** button.
7. In the **Printer Features** area, select **Yes** from the **Print in Max DPI** drop-down list.
8. Select the appropriate paper size from the **Paper Size** drop-down list.
9. Click **OK** to close the advanced options.
10. Confirm **Orientation** on the **Layout** tab, and then click **OK** to print.

### To print using maximum dpi (OS X)

1. From the **File** menu in your software, choose **Print**.
2. Make sure your printer is selected.
3. Set the print options.

If you do not see options on the Print dialog, click **Show Details**.



---

**NOTE:** The following options are available for a USB connected printer. Locations for the options can vary from one application to another.

---

- a. Choose the appropriate paper size in the **Paper Size** pop-up menu.



---

**NOTE:** If you change the **Paper Size** ensure that you have loaded the correct paper and set the paper size on the printer control panel to match.

---

- b. From the pop-up menu, choose **Paper Type/Quality**, and then choose the following settings:



- **Paper Type:** The appropriate paper type
  - **Quality: Maximum dpi**
4. Select any other print settings that you want, and then click **Print**.

# Print Quick Forms

Use HP Quick Forms to print fun and useful pages.

## To print Quick Forms

1. On the Home screen from your printer display, touch **Quick Forms** .
2. Select one of the Quick Form options.
3. Touch one of the subcategories of your selection, and then follow the on-screen instruction to select other settings.
4. Specify the number of copies you want to print, and then touch **Print**.

## Print from your mobile device

With HP mobile printing technology, you can print from your smartphone or tablet to your printer easily.

If you are at home or office, to use the printing capabilities already on your smartphone or tablet to print:

1. Make sure your mobile device and printer are on the same network.
2. Select the photo or document you want to print and choose your printer.
3. Confirm print settings and print.

If you want to print without accessing the network, see [Connect wirelessly to the printer without a router on page 87](#) for more information.

If you are on the road, you can print a document by sending an email with the HP ePrint app to your HP ePrint enabled printer. See [Print with HP ePrint on page 38](#) for more information.

For more information, visit the HP Mobile Printing website ( [www.hp.com/go/mobileprinting](http://www.hp.com/go/mobileprinting) ).

## Print with AirPrint

Printing using Apple's AirPrint is supported for iPad (iOS 4.2), iPhone (3GS or later), iPod touch (third generation or later), and Mac (OS X 10.7 or later).

To use AirPrint, ensure the following:

- The printer and the Apple device must be connected to the same network as your AirPrint enabled device. For more information about using AirPrint and about which HP products are compatible with AirPrint, go to [www.hp.com/go/mobileprinting](http://www.hp.com/go/mobileprinting).
- Load paper that matches the paper settings of the printer.

# Tips for print success

To print successfully, the HP cartridges should be functioning properly with sufficient ink, the paper should be loaded correctly, and the printer should have the appropriate settings. Print settings do not apply to copying or scanning.

## Ink tips

- Use Original HP ink cartridges.
- Install both the black and tri-color cartridges correctly.  
For more information, see [Replace ink cartridges on page 79](#).
- Check the estimated ink levels in the ink cartridges to make sure there is sufficient ink.  
For more information, see [Check estimated ink levels on page 76](#).
- If the print quality is not acceptable, see [Printing issues on page 107](#) for more information.

## Paper loading tips

- Load a stack of paper (not just one page). All of the paper in the stack should be the same size and type to avoid a paper jam.
- Load paper with side to be printed on facing up.
- Ensure that paper loaded in the input tray lays flat, and the edges are not bent or torn.
- Adjust the paper-width guide in the input tray to fit snugly against all paper. Make sure the paper-width guide does not bend the paper in the input tray.  
For more information, see [Load media on page 7](#).

## Printer settings tips (Windows)

- To change default print settings, open the HP printer software, click **Print, Scan & Fax**, and then click **Set Preferences**. For information how to open the printer software, see [Open the HP printer software \(Windows\) on page 15](#).
  - To select the number of pages to print per sheet, on the **Layout** tab, select the appropriate option from the **Pages per Sheet** drop-down list.
  - To view more printing settings, on the **Layout** or **Paper/Quality** tab, click the **Advanced** button to open the **Advanced Options** dialog box.
    - **Print in Grayscale:** Allows you to print a black and white document using the black ink only. Select **Black Ink Only**, and then click **OK**. It also allows you to print a high quality black and white image. Select **High Quality Grayscale**, and then click **OK**.
    - **Pages per Sheet Layout:** Helps you specify the order of the pages if you print the document with more than two pages per sheet.
- 
-  **NOTE:** The preview on the **Layout** tab cannot reflect what you select from the **Pages per Sheet Layout** drop-down list.
- 
- **HP Real Life Technologies:** This feature smooths and sharpens images and graphics for improved print quality.

- **Booklet:** Allows you to print a multiple-page document as a booklet. It places two pages on each side of a sheet that can then be folded into a booklet in half size of the paper. Select a binding method from the drop-down list, and then click **OK**.
  - **Booklet-LeftBinding:** The binding side after folded into a booklet appears at the left side. Select the option if your reading habit is from left to right.
  - **Booklet-RightBinding:** The binding side after folded into a booklet appears at the right side. Select the option if your reading habit is from right to left.



---

**NOTE:** The preview on the **Layout** tab cannot reflect what you select from the **Booklet** drop-down list.

---

- **Pages to Print:** Allows you to print the odd pages only, print the even pages only, or print all pages.
- **Borderless Printing:** Select this feature to print photos without border. Not all paper types support this feature. You will see an alert icon beside the option if the selected paper type in the **Media** drop-down list does not support it.
- **Page Borders:** Allows you to add borders to the pages if you print the document with two or more pages per sheet.



---

**NOTE:** The preview on the **Layout** tab cannot reflect what you select from the **Page Borders** drop-down list.

---

- You can use printing shortcut to save time setting printing preferences. A printing shortcut stores the setting values that are appropriate for a particular kind of job, so that you can set all the options with a single click. To use it, go to the **Printing Shortcut** tab, select one printing shortcut, and then click **OK**.

To add a new printing shortcut, after making settings on the **Layout** or **Paper/Quality** tab, click the **Printing Shortcut** tab, click **Save As** and enter a name, and then click **OK**.

To delete a printing shortcut, select it, and then click **Delete**.



---

**NOTE:** You cannot delete the default printing shortcuts.

---

### Printer settings tips (OS X)

- On the Print dialog, use the **Paper Size** pop-up menu to select the size of paper loaded in the printer.
- On the Print dialog, choose the **Paper Type/Quality** pop-up menu and select the appropriate paper type and quality.
- To print a black and white document using only black ink, choose the **Paper Type/Quality** from the pop-up menu and choose **Grayscale** from the Color pop-up menu.

## Notes

- Original HP ink cartridges are designed and tested with HP printers and papers to help you easily produce great results, time after time.



---

**NOTE:** HP cannot guarantee the quality or reliability of non-HP supplies. Product service or repairs required as a result of using a non-HP supply will not be covered under warranty.

If you believe you purchased Original HP ink cartridges, go to [www.hp.com/go/anticounterfeit](http://www.hp.com/go/anticounterfeit).

---

- Ink level warnings and indicators provide estimates for planning purposes only.



---

**NOTE:** When you receive a low-ink warning message, consider having a replacement cartridge available to avoid possible printing delays. You do not need to replace the cartridges until print quality becomes unacceptable.

---

- You can print your document on both sides of the paper manually.





---

## 4 Use Web Services

- [What are Web Services?](#)
- [Set up Web Services](#)
- [Print with HP ePrint](#)
- [Use HP Printables](#)
- [Use the HP Connected website](#)
- [Remove Web Services](#)

# What are Web Services?

## HP ePrint

- HP ePrint is a free service from HP that allows you to print to your HP ePrint-enabled printer anytime, from any location. It's as simple as sending an email to the email address assigned to your printer when you enable Web Services on the printer. No special drivers or software are needed. If you can send an email, you can print from anywhere, using HP ePrint.

Once you have signed up for an account on HP Connected ( [www.hpconnected.com](http://www.hpconnected.com) ), you can sign in to view your HP ePrint job status, manage your HP ePrint printer queue, control who can use your printer's HP ePrint email address to print, and get help for HP ePrint.

## HP Printables

- HP Printables allow you to easily locate and print preformatted web content, directly from your printer. You can also scan and store your documents digitally on the Web.

HP Printables provide a wide range of content, from store coupons to family activities, news, travel, sports, cooking, photos, and many more. You can even view and print your online images from popular photo sites.

Certain HP Printables also allow you to schedule the delivery of app content to your printer.

Preformatted content designed specifically for your printer means no cut-off text and pictures and no extra pages with only one line of text. On some printers, you can also choose paper and print quality settings on the print preview screen.

# Set up Web Services

Before you set up Web Services, make sure your printer is connected to the Internet using a wireless connection.

To set up Web Services, use one of the following methods.

## To set up Web Services using the printer control panel

1. From the Home screen, touch  (HP ePrint)
2. Touch **Set Up**.
3. Touch **Accept** to accept the HP Connected terms of use and enable Web Services.
4. In the **Printer Update Options** screen, choose the option which allows the printer to automatically install updates.

---

 **NOTE:** If a printer update is available, the printer will download and install the update, and then restart. You will have to repeat the instructions from step 1 to set up HP ePrint.

 **NOTE:** If prompted for proxy settings and if your network uses proxy settings, follow the on-screen instructions to set up a proxy server. If you do not have the proxy details, contact your network administrator or the person who set up the network.

---

5. When the printer is connected to the server, the printer prints an information page. Follow the instructions on the information page to finish the setup.

## To set up Web Services using the Embedded Web Server (EWS)

1. Open the EWS. For more information, see [Open the Embedded Web Server on page 94](#).
2. Click the **Web Services** tab.
3. In the **Web Services Settings** section, click **Setup**, click **Continue**, and follow the on-screen instructions to accept the terms of use.
4. If prompted, choose to allow the printer to check for and install printer updates.

---

 **NOTE:** When updates are available, they are automatically downloaded and installed, and then the printer restarts.

 **NOTE:** If prompted for proxy settings and if your network uses proxy settings, follow the on-screen instructions to set up a proxy server. If you do not have the proxy details, contact your network administrator or the person who set up the network.

---

5. When the printer is connected to the server, the printer prints an information page. Follow the instructions on the information page to finish the setup.

# Print with HP ePrint

HP HP ePrint allows you to print to your HP ePrint-enabled printer anytime, from any location.

Before you can use HP ePrint, make sure the printer is connected to an active network providing Internet access.

## To print a document using HP ePrint

1. Make sure Web Services have been set up successfully.

For more information, see [Set up Web Services on page 37](#).

2. Touch  (HP ePrint) on the Home screen, and then find the HP ePrint email address from the **Web Services Summary** menu.
3. Email your document to the printer.

- a. On your computer or mobile device, open your email application.



---

**NOTE:** For information about using the email application on your computer or mobile device, see the documentation provided with the application.

---

- b. Create a new email and attach the document to print.
- c. Send the email to the printer email address.

The printer prints the attached document.



---

**NOTE:** Enter only the HP ePrint email address in the "To" field. Do not enter any additional email addresses in the other fields. The HP ePrint server does not accept email print jobs if there are multiple addresses in the "To" field or any address in the "Cc" field."



**NOTE:** The email will be printed once it is received. As with any email, there is no guarantee when or whether it will be received. You can check the print status on HP Connected ([www.hpconnected.com](http://www.hpconnected.com)).



**NOTE:** Documents printed with HP ePrint may appear different from the original. Style, formatting, and text flow may differ from the original document. For documents that need to be printed with a higher quality (such as legal documents), we recommend that you print from the software application on your computer, where you will have more control over what your printout looks like.

---

 [Click here to go online for more information.](#)

## Use HP Printables

Print pages from the web, without using a computer, by setting up HP Printables, a free service from HP. You can print coloring pages, calendars, puzzles, recipes, maps, and more, depending on the apps available in your country/region.

Go to the HP Connected website for more information and specific terms and conditions:  
[www.hpconnected.com](http://www.hpconnected.com).

## Use the HP Connected website

Use HP's free HP Connected website to set up increased security for HP ePrint, and specify the email addresses that are allowed to send email to your printer. You can also get product updates, more apps, and other free services.

Go to the HP Connected website for more information and specific terms and conditions:

[www.hpconnected.com](http://www.hpconnected.com) .

## Remove Web Services

Use the following instructions to remove Web Services.

1. From the Home screen, touch **Setup** , and then touch **Web Services**.
2. Touch **Remove Web Services**.





---

# 5 Copy and scan

- [Copy](#)
- [Scan using the printer control panel](#)
- [Scan using the HP printer software](#)
- [Scan using Webscan](#)
- [Tips for copy and scan success](#)

# Copy

The **Copy** menu on the printer display allows you to easily start a black or color copy and select number of copies.

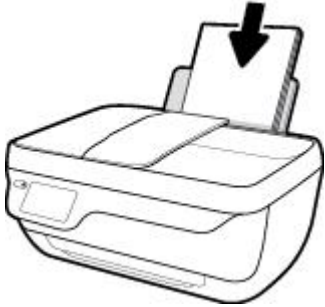

## To make a black or color copy

1. Load paper in the input tray.



2. Load the original print side up into the document feeder, or load the original print side down on the right front corner of the scanner glass.

For more information about loading the original, see [Load original on page 11](#).

3. From the Home screen, touch **Copy**.
4. Specify number of copies and settings.
  - Flick to the desired number of copies or use  (Keypad) to enter the number of copies.
  - Touch  (Settings) to customize the copy job.
5. Touch **Start Black** or **Start Color** to start the copy job.

## Copy Settings

You can customize copy jobs using the following settings in the **Copy** menu.

- **Tray and Paper:** Make sure you have loaded paper in the input tray. Plain paper will print in plain paper normal print quality. Photo paper will print in photo paper best quality.
- **Resize:** Controls the size of the image or document to be copied.
  - **Actual:** Makes a copy that is the same as the size of the original, but the margins of the copied image may be clipped.
  - **Fit to Page:** Makes a copy that is centered with a white border around the edges. The resized image is either enlarged or reduced to fit the size of the selected output paper.



**NOTE:** The scanner glass must be clean to make sure the **Fit to Page** feature works properly.

- **Custom:** Allows you to increase the size of the image by selecting values greater than 100% or reduce the image size by selecting values less than 100%.

- **Lighter / Darker:** Adjusts the copy settings to make copies lighter or darker.
- **ID Card Copy:** Allows you to copy both sides of ID card.



---

**NOTE:** After two minutes of inactivity, the copy options will automatically return to the default settings of A4 or 8.5 x 11 inches plain paper (depending on region).

---

# Scan using the printer control panel

## To scan an original from the printer control panel

1. Load the original print side up into the document feeder, or load the original print side down on the right front corner of the scanner glass.

For more information, see [Load original on page 11](#).

2. Touch **Scan**.
3. Touch a computer that you want to scan to.
4. Choose the type of scan you want.
5. Touch **OK**.

# Scan using the HP printer software

- [Scan to a computer](#)
- [Create a new scan shortcut \(Windows\)](#)
- [Change scan settings \(Windows\)](#)

## Scan to a computer

Before scanning to a computer, make sure you have already installed the HP recommended printer software. The printer and computer must be connected and turned on.

### To scan a document or photo to a file (Windows)

1. Load the original print side up into the document feeder, or load the original print side down on the right front corner of the scanner glass.
2. Double-click the printer icon on the desktop or do one of the following to open the printer software:
  - **Windows 8.1:** Click the down arrow in lower left corner of the Start screen, and then select the printer name.
  - **Windows 8:** Right-click an empty area on the Start screen, click **All Apps** on the app bar, and then select the printer name.
  - **Windows 7, Windows Vista, and Windows XP:** From the computer desktop, click **Start**, select **All Programs**, click **HP**, click the folder for the printer, and then select the icon with the printer's name.
3. In the printer software, click **Scan a Document or Photo**.
4. Select the type of scan you want and then click **Scan**.
  - Choose **Save as PDF** to save the document (or photo) as a PDF file.
  - Choose **Save as JPEG** to save the photo (or document) as an image file.



**NOTE:** Click the **More** link at the top right corner of the Scan dialog to review and modify settings for any scan.

For more information, see [Change scan settings \(Windows\) on page 49](#).

If **Show Viewer After Scan** is selected, you can make adjustments to the scanned image in the preview screen.

### To scan a document or photo to email (Windows)

1. Load the original print side up into the document feeder, or load the original print side down on the right front corner of the scanner glass.
2. Double-click the printer icon on the desktop or do one of the following to open the printer software:

- **Windows 8.1:** Click the down arrow in lower left corner of the Start screen, and then select the printer name.
  - **Windows 8:** Right-click an empty area on the Start screen, click **All Apps** on the app bar, and then select the printer name.
  - **Windows 7, Windows Vista, and Windows XP:** From the computer desktop, click **Start**, select **All Programs**, click **HP**, click the folder for the printer, and then select the icon with the printer's name.
3. In the printer software, click **Scan a Document or Photo** .
  4. Select the type of scan you want and then click **Scan** .

Choose **Email as PDF** or **Email as JPEG** to open your email software with the scanned file as an attachment.



**NOTE:** Click the **More** link at the top right corner of the Scan dialog to review and modify settings for any scan.

For more information, see [Change scan settings \(Windows\) on page 49](#).

If **Show Viewer After Scan** is selected, you can make adjustments to the scanned image in the preview screen.

### To scan an original from HP printer software (OS X)

1. Open HP Scan.  
HP Scan is located in the **Applications/Hewlett-Packard** folder at the top level of the hard disk.
2. Click **Scan** .
3. Choose the type of scan profile you want and follow the on-screen instructions.

### Create a new scan shortcut (Windows)

You can create your own scan shortcut to make scanning easier. For example, you might want to regularly scan and save photos in PNG format, rather than JPEG.

1. Load the original print side up into the document feeder, or load the original print side down on the right front corner of the scanner glass.
2. Double-click the printer icon on the desktop or do one of the following to open the printer software:
  - **Windows 8.1:** Click the down arrow in lower left corner of the Start screen, and then select the printer name.
  - **Windows 8:** Right-click an empty area on the Start screen, click **All Apps** on the app bar, and then select the printer name.
  - **Windows 7, Windows Vista, and Windows XP:** From the computer desktop, click **Start**, select **All Programs**, click **HP**, click the folder for the printer, and then select the icon with the printer's name.
3. In the printer software, click **Scan a Document or Photo** .
4. Click **Create New Scan Shortcut** .

5. Enter a descriptive name, choose an existing shortcut on which to base your new shortcut, and then click **Create** .

For example, if you are creating a new shortcut for photos, choose either **Save as JPEG** or **Email as JPEG** . This makes available the options for working with graphics when scanning.

6. Change the settings for your new shortcut to meet your needs, and then click the save icon to the right of the shortcut.



**NOTE:** Click the **More** link at the top right corner of the Scan dialog to review and modify settings for any scan.

For more information, see [Change scan settings \(Windows\) on page 49](#).

## Change scan settings (Windows)

You can modify any of the scan settings either for a singular use or save the changes to use permanently. These settings include options such as page size and orientation, scan resolution, contrast, and the folder location for saved scans.

1. Load the original print side up into the document feeder, or load the original print side down on the right front corner of the scanner glass.
2. Double-click the printer icon on the desktop or do one of the following to open the printer software:
  - **Windows 8.1:** Click the down arrow in lower left corner of the Start screen, and then select the printer name.
  - **Windows 8:** Right-click an empty area on the Start screen, click **All Apps** on the app bar, and then select the printer name.
  - **Windows 7, Windows Vista, and Windows XP:** From the computer desktop, click **Start**, select **All Programs**, click **HP**, click the folder for the printer, and then select the icon with the printer's name.
3. In the printer software, click **Scan a Document or Photo** .
4. Click the **More** link in the top right corner of the HP Scan dialog.

The detailed settings pane appears on the right. The left column summarizes the current settings for each section. The right column allows you to change the settings in the highlighted section.

5. Click each section at the left of the detailed settings pane to review the settings in that section.

You can review and change most settings using drop-down menus.

Some settings allow greater flexibility by displaying a new pane. These are indicated by a + (plus sign) at the right of the setting. You must either accept or cancel any changes on this pane to return to the detailed settings pane.

6. When you have finished changing settings, do one of the following.
  - Click **Scan** . You are prompted to save or reject the changes to the shortcut after the scan is finished.
  - Click the save icon to the right of the shortcut, and then click **Scan** .

[Go online to learn more about using the HP Scan software.](#) Learn how to:

- customize scan settings, such as image file type, scan resolution, and contrast levels.
- scan to network folders and cloud drives.
- preview and adjust images before scanning.



# Scan using Webscan

Webscan is a feature of the Embedded Web Server (EWS) that lets you scan photos and documents from your printer to your computer using a web browser.

This feature is available even if you did not install the printer software on your computer.



**NOTE:** By default, Webscan is off. You can enable this feature from the EWS.

If you are unable to open Webscan in the EWS, your network administrator might have turned it off. For more information, contact your network administrator or the person who set up your network.

## To enable Webscan

1. Open the embedded web server. For more information, see [Open the Embedded Web Server on page 94](#).
2. Click the **Settings** tab.
3. In the **Security** section, click **Administrator Settings**.
4. Select **Webscan** to enable Webscan.
5. Click **Apply**.

## To scan using Webscan

Scanning using Webscan offers basic scan options. For additional scan options or functionality, scan from the HP printer software.

1. Load the original print side up into the document feeder, or load the original print side down on the right front corner of the scanner glass.  
  
For more information, see [Load original on page 11](#).
2. Open the embedded web server. For more information, see [Open the Embedded Web Server on page 94](#).
3. Click the **Scan** tab.
4. Click **Webscan** in the left pane, change any settings, and then click **Start Scan**.

## Tips for copy and scan success

Use the following tips to copy and scan successfully.

- Keep the glass and the back of the lid clean. The scanner interprets anything it detects on the glass as part of the image.
- Load your original, print side down, on the right front corner of the glass.
- To make a large copy of a small original, scan the original into the computer, resize the image in the scanning software, and then print a copy of the enlarged image.
- If you want to adjust scan size, output type, scan resolution, or file type, and so on, start scan from the printer software.
- To avoid incorrect or missing scanned text, make sure the brightness is set appropriately in the software.
- If you want to scan a document with several pages into one file instead of multiple files, start the scan with the printer software instead of selecting **Scan** from the printer display.

---

## 6 Fax

You can use the printer to send and receive faxes, including color faxes. You can schedule faxes to be sent at a later time and set up phone book contacts to send faxes quickly and easily to frequently used numbers. From the printer control panel, you can also set a number of fax options, such as resolution and the contrast between lightness and darkness on the faxes you send.



**NOTE:** Before you begin faxing, make sure you have set up the printer correctly for faxing. You can verify the fax is set up correctly by running the fax setup test from the printer control panel.

- [Send a fax](#)
- [Receive a fax](#)
- [Set up phone book contacts](#)
- [Change fax settings](#)
- [Fax and digital phone services](#)
- [Fax on Voice over Internet Protocol](#)
- [Use reports](#)

## Send a fax

You can send a fax in a variety of ways, depending on your situation or need.

- [Send a standard fax from the printer control panel](#)
- [Send a standard fax from the computer](#)
- [Send a fax from a phone](#)
- [Send a fax using monitor dialing](#)
- [Send a fax in Error Correction Mode](#)

### Send a standard fax from the printer control panel

You can easily send a single- or multiple-page black-and-white or color fax by using the printer control panel.



**NOTE:** If you need printed confirmation that your faxes were successfully sent, fax confirmation must be enabled.

#### To send a standard fax from the printer control panel

1. Load the original print side up into the document feeder, or load the original print side down on the right front corner of the scanner glass.

For more information about loading the original, see [Load original on page 11](#).

2. From the Home screen, touch **Fax**.
3. Touch **Send Now**.
4. Touch **Enter Fax Number**. Use the keypad to enter the fax number, and then click **OK**.

**TIP:** To add a pause in the fax number you are entering, touch \* repeatedly, until a dash (-) appears on the display.

5. Touch **Black** or **Color**.

If the printer detects an original loaded in the document feeder, it sends the document to the number you entered.

**TIP:** If the recipient reports issues with the quality of the fax, try changing the resolution or contrast of your fax.

### Send a standard fax from the computer

You can fax a document directly from your computer without printing it first.

To use this feature, make sure you have installed the HP printer software on your computer, the printer is connected to a working telephone line, and the fax function is set up and functioning correctly.

#### To send a standard fax from the computer (Windows)

1. Open the document on your computer that you want to fax.
2. On the **File** menu in your software application, click **Print**.

3. From the **Name** list, select the printer that has “**fax**” in the name.
4. To change settings (such as selecting to send the document as a black fax or a color fax), click the button that opens the **Properties** dialog box. Depending on your software application, this button might be called **Properties**, **Options**, **Printer Setup**, **Printer**, or **Preferences**.
5. After you have changed any settings, click **OK**.
6. Click **Print** or **OK**.
7. Enter the fax number and other information for the recipient, change any further settings for the fax, and then click **Send Fax**. The printer begins dialing the fax number and faxing the document.

#### To send a standard fax from the computer (OS X)

1. Open the document on your computer that you want to fax.
2. From the **File** menu in your software, click **Print**.
3. Select the printer that has “**(Fax)**” in the name.
4. Enter a fax number or a name from your Contacts that already has a fax number entry.
5. When you have finished filling out the fax information, click **Fax**.

## Send a fax from a phone

You can send a fax using your telephone extension. This allows you to talk with the intended recipient before sending the fax.

#### To send a fax from an extension phone

1. Load the original print side up into the document feeder, or load the original print side down on the right front corner of the scanner glass.

For more information about loading the original, see [Load original on page 11](#).

2. Dial the number by using the keypad on the phone that is connected to the printer.

If the recipient answers the telephone, inform the recipient that they should receive the fax on their fax machine after they hear fax tones. If a fax machine answers the call, you will hear fax tones from the receiving fax machine.

3. From the Home screen, touch **Fax**.
4. Touch **Send Fax**.
5. When you are ready to send the fax, touch **Black** or **Color**.

The telephone is silent while the fax is transmitting. If you want to speak to the recipient after, remain on the line until the transmission is complete. If you were finished talking to the recipient, you can hang up the telephone as soon as the fax begins transmitting.

## Send a fax using monitor dialing

When you send a fax using monitor dialing, you can hear the dial tones, telephone prompts, or other sounds through the speakers on the printer. This enables you to respond to prompts while dialing, as well as control the pace of your dialing.

---

 **TIP:** If you are using a calling card and do not enter your PIN fast enough, the printer might start sending fax tones too soon and cause your PIN not to be recognized by the calling card service. If this is the case, create a phone book contact to store the PIN for your calling card.

 **NOTE:** Make sure the volume is turned on to hear a dial tone.

---



### To send a fax using monitor dialing from the printer control panel

1. Load the original print side up into the document feeder, or load the original print side down on the right front corner of the scanner glass.

For more information about loading the original, see [Load original on page 11](#).

2. From the Home screen, touch **Fax**.
3. Touch **Send Now**.
4. Touch **Black** or **Color**.
5. When you hear the dial tone, click **Enter Fax Number**, and then use the keypad to enter the number.
6. Follow any prompts that might occur.

---

 **TIP:** If you are using a calling card to send a fax and you have your calling card PIN stored as a phone book contact, when prompted to enter your PIN, touch  (Phone Book) to select the phone book contact where you have your PIN stored.

---

Your fax is sent when the receiving fax machine answers.

## Send a fax in Error Correction Mode

**Error Correction Mode (ECM)** prevents loss of data due to poor phone lines by detecting errors that occur during transmission and automatically requesting retransmission of the erroneous portion. Phone charges are unaffected, or might even be reduced, on good phone lines. On poor phone lines, ECM increases sending time and phone charges, but sends the data much more reliably. The default setting is **On**. Turn ECM off only if it increases phone charges substantially, and if you can accept poorer quality in exchange for reduced charges.

If you turn ECM off:

- The quality and transmission speed of faxes you send and receive are affected.
- The **Speed** is automatically set to **Medium**.
- You can no longer send or receive faxes in color.

### To change the ECM setting from the control panel

1. From the Home screen, touch **Fax**.
2. Touch **Setup**.
3. Touch **Preferences**.
4. Scroll to **Error Correction Mode** and touch it to turn the feature on or off.

## Receive a fax

You can receive faxes automatically or manually. If you turn off the **Auto Answer** option, you must receive faxes manually. If you turn on the **Auto Answer** option (the default setting), the printer automatically answers incoming calls and receives faxes after the number of rings that are specified by the **Rings to Answer** setting. (The default **Rings to Answer** setting is five rings.)

If you receive a Legal-size or larger fax and the printer is not currently set to use Legal-size paper, the printer reduces the fax so that it fits on the paper that is loaded. If you have disabled the **Auto Reduction** feature, the printer prints the fax on two pages.



---

**NOTE:** If you are copying a document when a fax arrives, the fax is stored in the printer memory until the copying finishes.

---

- [Receive a fax manually](#)
- [Set up backup fax](#)
- [Reprint received faxes from memory](#)
- [Forward faxes to another number](#)
- [Set automatic reduction for incoming faxes](#)
- [Block unwanted fax numbers](#)

## Receive a fax manually

When you are on the phone, the person you are speaking with can send you a fax while you are still connected. You can pick up the handset to talk or listen for fax tones.

You can receive faxes manually from a phone that is directly connected to the printer (on the 2-EXT port).

### To receive a fax manually

1. Make sure the printer is turned on and you have paper loaded in the input tray.
2. Remove any originals from the document feeder tray.
3. Set the **Rings to Answer** setting to a high number to allow you to answer the incoming call before the printer answers. Or, turn off the **Auto Answer** setting so that the printer does not automatically answer incoming calls.
4. If you are currently on the phone with the sender, ask the sender to start sending the fax.
5. Do the following when you hear fax tones from a sending fax machine.
  - a. From the Home screen, touch **Fax**, touch **Send and Receive**, and then touch **Receive Now**.
  - b. After the printer begins to receive the fax, you can hang up the phone or remain on the line. The phone line is silent during fax transmission.

## Set up backup fax

Depending on your preference and security requirements, you can set up the printer to store all the faxes it receives, only the faxes it receives while the printer is in an error condition, or none of the faxes it receives.

## To set backup fax from the printer control panel

1. From the Home screen, touch **Fax** .
2. Touch **Setup** .
3. Touch **Preferences** .
4. Touch **Backup Fax Reception**.
5. Touch the required setting.

---

<b>On</b>	<p>The default setting. When <b>Backup fax</b> is <b>On</b>, the printer stores received faxes in memory. This enables you to reprint the most recently printed faxes if they are still saved in memory.</p> <p><b>NOTE:</b> When printer memory is low, it overwrites the oldest, printed faxes as it receives new faxes. If the memory becomes full of unprinted faxes, the printer stops answering incoming fax calls.</p> <p><b>NOTE:</b> The received faxes are stored in the volatile memory. If the printer is turned off and then on, the received faxes will no longer be available for reprinting.</p> <p><b>NOTE:</b> If you receive a fax that is too large, such as a very detailed color photo, it might not be stored in memory due to memory limitations.</p>
<b>On Error Only</b>	<p>Causes the printer to store faxes in memory only if an error condition exists that prevents the printer from printing the faxes (for example, if the printer runs out of paper). The printer continues to store incoming faxes as long as there is memory available. (If the memory becomes full, the printer stops answering incoming fax calls.) When the error condition is resolved, the faxes stored in memory print automatically, and then they are deleted from memory.</p>
<b>Off</b>	<p>Faxes are never stored in memory. For example, you might want to turn off <b>Backup fax</b> for security purposes. If an error condition occurs that prevents the printer from printing (for example, the printer runs out of paper), the printer stops answering incoming fax calls.</p>

---

## Reprint received faxes from memory

The received faxes are stored in the volatile memory. If the printer is turned off and then on, the received faxes will no longer be available for reprinting.



**NOTE:** After the memory becomes full, the printer cannot receive the new fax until you print or delete the faxes from memory. You might also want to delete the faxes in memory for security or privacy purposes.

## To reprint faxes in memory from the printer control panel

1. Make sure you have paper loaded in the input tray. For more information, see [Load media on page 7](#).
2. From the Home screen, touch **Fax** .
3. Touch **Reprint**.

The faxes are displayed in the reverse order from which they were received with the most recently received fax printed first, and so on.

4. Select the fax you want to print, and then touch **Print**.

## Forward faxes to another number

You can set up the printer to forward your faxes to another fax number. All faxes are forwarded in black and white, regardless of how they were originally sent.



HP recommends that you verify the number you are forwarding to is a working fax line. Send a test fax to make sure the fax machine is able to receive your forwarded faxes.

### To forward faxes from the printer control panel

1. From the Home screen, touch **Fax** .
2. Touch **Setup** .
3. Touch **Preferences** .
4. Touch **Fax Forwarding**.
5. Touch **On (Print and Forward)** to print and forward the fax, or select **On (Forward)** to forward the fax.



**NOTE:** If the printer is not able to forward the fax to the designated fax machine (for example, if it is not turned on), the printer prints the fax. If you set up the printer to print error reports for received faxes, it also prints an error report.

6. At the prompt, enter the number of the fax machine intended to receive the forwarded faxes, and then touch **Done** . Enter the required information for each of the following prompts: start date, start time, end date, and end time. Then touch **Done** .
7. Fax forwarding is activated. Touch **OK** to confirm.

If the printer loses power when fax forwarding is set up, it saves the fax forwarding setting and phone number. When the power is restored to the printer, the fax forwarding setting is still **On**.



**NOTE:** You can cancel fax forwarding by selecting **Off** from the **Fax Forwarding** menu.

## Set automatic reduction for incoming faxes

The **Auto Reduction** setting determines what the printer does if it receives a fax that is too large for the loaded paper size. This setting is turned on by default, so the image of the incoming fax is reduced to fit on one page, if possible. If this feature is turned off, information that does not fit on the first page is printed on a second page. **Auto Reduction** is useful when you receive a Legal-size fax and Letter-size paper is loaded in the input tray.

### To set automatic reduction from the printer control panel

1. From the Home screen, touch **Fax** .
2. Touch **Setup** .
3. Touch **Preferences** .
4. Touch **Auto Reduction** to turn on or off.

## Block unwanted fax numbers

If you subscribe to a caller ID service through your phone provider, you can block specific fax numbers so the printer does not receive faxes from those numbers. When an incoming fax call is received, the printer compares the number to the list of junk fax numbers to determine if the call should be blocked. If the number matches a number in the blocked fax numbers list, the fax is not received. (The maximum number of fax numbers you can block varies by model.)



---

**NOTE:** This feature is not supported in all countries/regions. If it is not supported in your country/region, **Junk Fax Blocking** does not appear in the **Preferences** menu.



**NOTE:** If no phone numbers are added in the Caller ID list, it is assumed that you are not subscribed to a Caller ID service.

---

You can block specific fax numbers by adding them to the junk fax list, and unblock these numbers by removing them from the junk fax list.

### To add a number to the junk fax list

1. From the Home screen, touch **Fax** .
2. Touch **Setup** .
3. Touch **Preferences** .
4. Touch **Junk Fax Blocking** .
5. Touch **+** (Plus Sign).
6. Do one of the following.
  - Touch  (Received Call History), select the fax number to be blocked, and then touch **Add**.
  - Manually enter a fax number to block, and touch **Add**.



---

**NOTE:** Make sure you enter the fax number as it appears on the control panel display, and not the fax number that appears on the fax header of the received fax, as these numbers can be different.

---

### To remove numbers from the junk fax list

If you no longer want to block a fax number, you can remove it from the junk fax list.

1. From the Home screen, touch **Fax** .
2. Touch **Setup** .
3. Touch **Preferences** .
4. Touch **Junk Fax Blocking** .
5. Touch the number you want to remove, touch **Remove**, and then touch **OK** .

# Set up phone book contacts

You can set up frequently used fax numbers as phone book contacts. This allows you quickly dial those numbers using the printer control panel.

---

 **TIP:** In addition to creating and managing phone book contacts from the printer control panel, you can also use tools available on your computer, such as the HP printer software and the printer EWS.

---

- [Set up and change phone book contacts](#)
- [Set up and change group phone book contacts](#)
- [Delete phone book contacts](#)

## Set up and change phone book contacts

You can store fax numbers as phone book contacts.

### To set up phone book contacts

1. From the Home screen, touch **Fax** .
2. Touch **Send Now**.
3. Touch  (Phone Book).
4. Touch **Contacts**.
5. Touch **+** (Plus Sign) to add a contact.
6. Touch **Name**, enter the name of the contact, and then touch **Done** .
7. Touch **Fax Number**, enter the fax number for the contact, and then touch **OK** .



---

 **NOTE:** Be sure to include any pauses or other required numbers, such as an area code, an access code for numbers outside a PBX system (usually a 9 or 0), or a long-distance prefix.

---

8. Touch **Add**.

### To change phone book contacts

1. From the Home screen, touch **Fax** .
2. Touch **Send Now**.
3. Touch  (Phone Book).
4. Touch **Contacts**.
5. Touch  (Edit) to edit a contact.
6. Touch the contact that you want to edit.
7. Touch **Name**, edit the name of the contact, and then touch **Done** .
8. Touch **Number**, edit the fax number for the contact, and then touch **OK** .



---

**NOTE:** Be sure to include any pauses or other required numbers, such as an area code, an access code for numbers outside a PBX system (usually a 9 or 0), or a long-distance prefix.

---

9. Touch **Done** .

## Set up and change group phone book contacts

You can store groups of fax numbers as group phone book contacts.

### To set up group phone book contacts





---

**NOTE:** Before you can create a group phone book contact, you must have already created at least one phone book contact.

---



1. From the Home screen, touch **Fax** .
2. Touch **Send Now**.
3. Touch  (Phone Book).
4. Touch **Group Contacts**.
5. Touch **+** (Plus Sign) to add a group.
6. Touch **Name** and then enter the name of the group, and then touch **Done** .
7. Touch **Number**, select the phone book contacts you want to include in this group, and then touch **Select**.
8. Touch **Create**.

### To change group phone book contacts

1. From the Home screen, touch **Fax** .
2. Touch **Send Now**.
3. Touch  (Phone Book).
4. Touch **Group Contacts**.
5. Touch  (Edit) to edit a group.
6. Touch the group phone book contact that you want to edit.
7. Touch **Name** and then edit the name of the group phone book contact, and then touch **Done** .
8. Touch **Number of Members**.
9. Deselect the phone book contacts you want to delete from this group, or touch **+** (Plus Sign) to add a contact to the group.
10. Touch **Done** .

## Delete phone book contacts

You can delete phone book contacts or group phone book contacts.

1. From the Home screen, touch **Fax** .
2. Touch **Send Now**.
3. Touch  (Phone Book).
4. Touch **Contacts** or **Group Contacts**.
5. Touch  (Edit).
6. Touch the name of the contact you want to delete.
7. Touch **Delete**.
8. Touch **Yes** to confirm and then touch **OK** .

## Change fax settings

After completing the steps in the getting started guide that came with the printer, use the following steps to change the initial settings or to configure other options for faxing.

- [Configure the fax header](#)
- [Set the answer mode \(Auto answer\)](#)
- [Set the number of rings before answering](#)
- [Change the answer ring pattern for distinctive ring](#)
- [Set the dial type](#)
- [Set the redial options](#)
- [Set the fax speed](#)
- [Set the fax sound volume](#)

### Configure the fax header

The fax header prints your name and fax number on the top of every fax you send. HP recommends that you set up the fax header by using the HP printer software. You can also set up the fax header from the printer control panel, as described here.



---

**NOTE:** In some countries/regions, the fax header information is a legal requirement.

---

#### To set or change the fax header

1. From the Home screen, touch **Fax** .
2. Touch **Setup** , and then touch **Preferences** .
3. Touch **Fax Header**.
4. Enter your personal or company name, and then touch **Done** .
5. Enter your fax number, and then touch **OK** .

### Set the answer mode (Auto answer)

The answer mode determines whether the printer answers incoming calls.

- Turn on the **Auto Answer** setting if you want the printer to answer faxes **automatically**. The printer answers all incoming calls and faxes.
- Turn off the **Auto Answer** setting if you want to receive faxes **manually**. You must be available to respond in person to the incoming fax call or else the printer does not receive faxes.

#### To set the answer mode

1. From the Home screen, touch **Fax** .
2. Touch **Setup** , and then touch **Preferences** .
3. Touch **Auto Answer** to turn it on or off.

You may also access this feature by touching  (Fax Status) on the Home screen.

## Set the number of rings before answering

If you turn on the **Auto Answer** setting, you can specify how many rings occur before incoming calls are automatically answered.

The **Rings to Answer** setting is important if you have an answering machine on the same phone line as the printer, because you want the answering machine to answer the phone before the printer does. The number of rings to answer for the printer should be greater than the number of rings to answer for the answering machine.

For example, set your answering machine to a low number of rings and the printer to answer in the maximum number of rings. (The maximum number of rings varies by country/region.) In this setup, the answering machine answers the call and the printer monitors the line. If the printer detects fax tones, it receives the fax. If the call is a voice call, the answering machine records the incoming message.

### To set the number of rings before answering

1. From the Home screen, touch **Fax** .
2. Touch **Setup** , and then touch **Preferences** .
3. Touch **Rings to Answer** .
4. Specify the number of rings.
5. Touch **Done** to accept the setting.

## Change the answer ring pattern for distinctive ring

Many phone companies offer a distinctive ring feature that allows you to have several phone numbers on one phone line. When you subscribe to this service, each number is assigned a different ring pattern. You can set up the printer to answer incoming calls that have a specific ring pattern.

If you connect the printer to a line with distinctive ring, have your telephone company assign one ring pattern to voice calls and another ring pattern to fax calls. HP recommends that you request double or triple rings for a fax number. When the printer detects the specified ring pattern, it answers the call and receives the fax.

---

 **TIP:** You can also use the Ring Pattern Detection feature in the **Distinctive Ring** menu to set distinctive ring. With this feature, the printer recognizes and records the ring pattern of an incoming call and, based on this call, automatically determines the distinctive ring pattern assigned by your telephone company to fax calls.

---

If you do not have a distinctive ring service, use the default ring pattern, which is **All Standard Rings** .

---

 **NOTE:** The printer cannot receive faxes when the main phone number is off the hook.

---

### To change the answer ring pattern for distinctive ring

1. Verify that the printer is set to answer fax calls automatically.
2. From the Home screen, touch **Fax** .
3. Touch **Setup** , and then select **Preferences** .
4. Touch **Distinctive Ring** .

5. A message appears stating that this setting should not be changed unless you have multiple numbers on the same telephone line. Touch **Yes** to continue.
6. Do one of the following:
  - Touch the ring pattern assigned by your telephone company to fax calls.
  - Touch **Ring Pattern Detection**, and then follow the instructions on the printer control panel display.

---

 **NOTE:** If the Ring Pattern Detection feature cannot detect the ring pattern or if you cancel the feature before it finishes, the ring pattern is automatically set to the default, which is **All Standard Rings** .

 **NOTE:** If you are using a PBX phone system that has different ring patterns for internal and external calls, you must call the fax number from an external number.

---

## Set the dial type

Use this procedure to set tone-dialing or pulse-dialing mode. The factory-set default is **Tone**. Do not change the setting unless you know that your phone line cannot use tone dialing.

---

 **NOTE:** The pulse-dialing option is not available in all countries/regions.

---

### To set the dial type

1. From the Home screen, touch **Fax** .
2. Touch **Setup** , and then touch **Preferences** .
3. Touch **Dial Type**.
4. Touch to select **Tone** or **Pulse**.

## Set the redial options

If the printer was unable to send a fax because the receiving fax machine did not answer or was busy, the printer attempts to redial based on the settings for the redial options. Use the following procedure to turn the options on or off.

- **Busy redial:** If this option is turned on, the printer redials automatically if it receives a busy signal. The default is **On**.
- **No answer redial:** If this option is turned on, the printer redials automatically if the receiving fax machine does not answer. The default is **Off** .
- **Connection problem redial:** If this option is turned on, the printer redials automatically if there has been a problem connecting with the receiving fax machine. Connection problem redial works only for sending faxes from memory. The default is **On**.

### To set the redial options

1. From the Home screen, touch **Fax** .
2. Touch **Setup** , and then touch **Preferences** .
3. Touch **Auto Redial** .
4. Touch **Busy Redial** , **No Answer Redial** , or **Connection Problem Redial** to turn it on or off.



## Set the fax speed

You can set the fax speed used to communicate between your printer and other fax machines when sending and receiving faxes.

If you use one of the following, setting the fax speed to a slower speed might be required:

- An Internet phone service
- A PBX (private branch exchange) system
- Fax on Voice over Internet Protocol (VoIP)
- An integrated services digital network (ISDN) service

If you experience problems sending and receiving faxes, try using a slower **Speed**. The following table provides the available fax speed settings.

Fax speed setting	Fax speed
<b>Fast</b>	33600 bps
<b>Medium</b>	14400 bps
<b>Slow</b>	9600 bps

### To set the fax speed

1. From the Home screen, touch **Fax**.
2. Touch **Setup**, and then touch **Preferences**.
3. Touch **Speed**.
4. Touch to select an option.

## Set the fax sound volume

You can change the volume of fax sounds.

### To set the fax sound volume

1. From the Home screen, touch **Fax**.
2. Touch **Setup**, and then touch **Preferences**.
3. Touch **Volume**.
4. Touch to select **Soft**, **Loud**, or **Off**.

## Fax and digital phone services

Many telephone companies provide their customers with digital phone services, such as the following:

- DSL: A Digital subscriber line (DSL) service through your telephone company. (DSL might be called ADSL in your country/region.)
- PBX: A private branch exchange (PBX) phone system.
- ISDN: An integrated services digital network (ISDN) system.
- VoIP: A low-cost phone service that allows you to send and receive faxes with your printer by using the Internet. This method is called Fax on Voice over Internet Protocol (VoIP).

For more information, see [Fax on Voice over Internet Protocol on page 69](#).

HP printers are designed specifically for use with traditional analog phone services. If you are in a digital phone environment (such as DSL/ADSL, PBX, or ISDN), you might need to use digital-to-analog filters or converters when setting up the printer for faxing.



---

**NOTE:** HP does not guarantee that the printer will be compatible with all digital service lines or providers, in all digital environments, or with all digital-to-analog converters. It is always recommended that you discuss with the telephone company directly for the correct setup options based on their line services provided.

---

# Fax on Voice over Internet Protocol

You might be able to subscribe to a low cost phone service that allows you to send and receive faxes with your printer by using the Internet. This method is called Fax on Voice over Internet Protocol (VoIP).

The following are indications you probably use a VoIP service.

- Dial a special access code along with the fax number.
- Have an IP converter box that connects to the Internet and provides analog phone ports for the fax connection.

---

 **NOTE:** You can only send and receive faxes by connecting a phone cord to the port labeled "1-LINE" on the printer. This means that your connection to the Internet must be done either through a converter box (which supplies regular analog phone jacks for fax connections) or your telephone company.

 **TIP:** Support for traditional fax transmission over any Internet protocol telephone systems are often limited. If you experience problems faxing, try using a slower fax speed or disabling the fax error-correction mode (ECM). However, if you turn off ECM, you cannot send and receive color faxes.

For more information about changing the fax speed, see [Set the fax speed on page 67](#). For more information about using ECM, see [Send a fax in Error Correction Mode on page 56](#).

---

If you have questions about Internet faxing, contact your Internet faxing services support department or your local service provider for further assistance.

## Use reports

You can set up the printer to print error reports and confirmation reports automatically for each fax you send and receive. You can also manually print system reports as required; these reports provide useful system information about the printer.

By default, the printer is set to print a report only if there is a problem sending or receiving a fax. A confirmation message that indicates whether a fax was successfully sent appears briefly on the control panel display after each transaction.

---

 **NOTE:** If the reports are not legible, you can check the estimated ink levels from the control panel or the HP software. For more information, see [Check estimated ink levels on page 76](#).

 **NOTE:** Ink level alerts and indicators provide estimates for planning purposes only. When you receive a low-ink alert, consider having a replacement cartridge available to avoid possible printing delays. You do not need to replace the ink cartridges until the print quality becomes unacceptable.

 **NOTE:** Ensure that the ink cartridges are in good conditions and installed properly. For more information, see [Manage ink cartridges on page 75](#).

---

This section contains the following topics:

- [Print fax confirmation reports](#)
- [Print fax error reports](#)
- [Print and view the fax log](#)
- [Clear the fax log](#)
- [Print the details of the last fax transaction](#)
- [Print a Caller ID Report](#)
- [View the Call History](#)

## Print fax confirmation reports

You can print a confirmation report for every fax you send or receive. The default setting is **Off**. When in the default setting, a confirmation message appears briefly on the control panel after each fax is sent or received.

### To enable fax confirmation

1. From the Home screen, touch **Fax**.
2. Touch **Setup**.
3. Touch **Reports** and touch **Fax Confirmation**.
4. Touch to select one of the following options.

---

<b>Off</b>	Does not print a fax confirmation report when you send and receive faxes successfully. This is the default setting.
<b>On (Fax Send)</b>	Prints a fax confirmation report for every fax you send.

---

<b>On (Fax Receive)</b>	Prints a fax confirmation report for every fax you receive.
<b>On (Fax Send and Fax Receive)</b>	Prints a fax confirmation report for every fax you send and receive.

### To include an image of the fax on the confirmation report

1. From the Home screen, touch **Fax** .
2. Touch **Setup** .
3. Touch **Reports** and touch **Fax Confirmation** .
4. Touch **On (Fax Send)** or **On (Fax Send and Fax Receive)** .
5. Touch **Fax Confirmation with Image**.

## Print fax error reports

You can configure the printer so that it automatically prints a report when there is an error during transmission or reception.

### To set the printer to print fax error reports automatically

1. From the Home screen, touch **Fax** .
2. Touch **Setup** .
3. Touch **Reports** and touch **Fax Error Report**.
4. Touch to select one of the following.

<b>On (Fax Send)</b>	Prints whenever a transmission error occurs. This is the default setting.
<b>On (Fax Receive)</b>	Prints whenever a receiving error occurs.
<b>On (Fax Send and Fax Receive)</b>	Prints whenever a fax error occurs.
<b>Off</b>	Does not print any fax error reports.

## Print and view the fax log

You can print a log of faxes that have been received and sent by the printer.

### To print the fax log from the printer control panel

1. From the Home screen, touch **Fax** .
2. Touch **Setup** , and then touch **Reports** .
3. Touch **Print Fax Reports** .
4. Touch **Last 30 Transaction Fax Logs**.
5. Touch **Print** to begin printing.

## Clear the fax log

Clearing the fax log also deletes all faxes stored in memory.

### To clear the fax log

1. From the Home screen, touch **Fax** .
2. Touch **Setup** , and then touch **Tools**.
3. Touch **Clear Fax Logs**.

## Print the details of the last fax transaction

The Last Fax Transaction report prints the details of the latest fax transaction to occur. Details include the fax number, number of pages, and the fax status.

### To print the Last Fax Transaction report

1. From the Home screen, touch **Fax** .
2. Touch **Setup** , and then touch **Reports** .
3. Touch **Print Fax Reports** .
4. Touch **Last Transaction Log**.
5. Touch **Print** to begin printing.

## Print a Caller ID Report

You can print a list of Caller ID fax numbers.

### To print a Caller ID History Report

1. From the Home screen, touch **Fax** .
2. Touch **Setup** , and then touch **Reports** .
3. Touch **Print Fax Reports** .
4. Touch **Caller ID Report**.
5. Touch **Print** to begin printing.

## View the Call History

You can view a list of all the calls placed from the printer.

---

 **NOTE:** You cannot print the call history.

---

### To view the call history

1. From the Home screen, touch **Fax** .
2. Touch **Send Now**.

3. Touch  (Phone Book).
4. Touch **Call History**





---

# 7 Manage ink cartridges

This section contains the following topics:

- [Check estimated ink levels](#)
- [Order ink supplies](#)
- [Choose right ink cartridges](#)
- [Replace ink cartridges](#)
- [Use single-cartridge mode](#)
- [Cartridge warranty information](#)
- [Tips for working with ink cartridges](#)

## Check estimated ink levels

You can easily check the ink supply level to determine how soon you might need to replace an ink cartridge. The ink supply level shows an estimate of the amount of ink remaining in the ink cartridges.

### To check the ink levels from the printer control panel

- From the Home screen, touch  (Ink) to display the estimated ink levels.

### To check the ink levels from the HP printer software (Windows)

1. Open the HP printer software. For more information, see [Open the HP printer software \(Windows\) on page 15](#).
2. In the printer software, click the **Estimated Ink Levels** tab.

### To check the ink levels from the HP printer software (OS X)

1. Open HP Utility.  
HP Utility is located in the **Hewlett-Packard** folder in the **Applications** folder at the top level of the hard disk.
2. Select the HP OfficeJet 3830 series from the list of devices at the left of the window.
3. Click **Supplies Status**.  
The estimated ink levels appear.
4. Click **All Settings** to return to the **Information and Support** pane.

---

 **NOTE:** If you have installed a refilled or remanufactured ink cartridge, or an ink cartridge that has been used in another printer, the ink level indicator might be inaccurate or unavailable.

 **NOTE:** Ink level warnings and indicators provide estimates for planning purposes only. When you receive a low-ink warning message, consider having a replacement ink cartridge available to avoid possible printing delays. You do not have to replace the ink cartridges until the print quality is unacceptable.

 **NOTE:** Ink from the ink cartridges is used in the printing process in a number of different ways, including in the initialization process, which prepares the printer and cartridges for printing, and in printhead servicing, which keeps print nozzles clear and ink flowing smoothly. In addition, some residual ink is left in the ink cartridge after it is used. For more information, see [www.hp.com/go/inkusage](http://www.hp.com/go/inkusage).

---

# Order ink supplies

Before ordering cartridges, locate the correct cartridge number.

## To locate the cartridge number on the printer

- The cartridge number is located inside the front door.

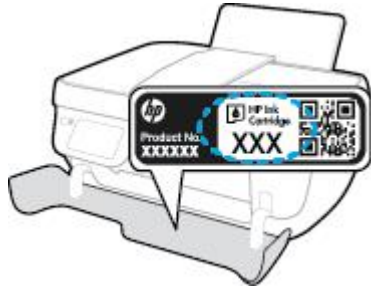

## To locate the cartridge number from the printer software (Windows)

1. Open the HP printer software. For more information, see [Open the HP printer software \(Windows\) on page 15](#).
2. In the printer software, click **Shop**, click **Shop For Supplies Online**, and then follow the on-screen instructions.

## To find the print cartridge reorder numbers (OS X)

1. Open HP Utility.

---

 **NOTE:** HP Utility is located in the **Hewlett-Packard** folder in the **Applications** folder at the top level of the hard disk.

---

2. Click **Supplies Info**.

The print cartridge ordering numbers appear.

3. Click **All Settings** to return to the **Information and Support** pane.

To order original HP supplies for the HP OfficeJet 3830 series, go to [www.hp.com/buy/supplies](http://www.hp.com/buy/supplies). If prompted, choose your country/region, follow the prompts to select your product, and then click one of the shopping links on the page.

---

 **NOTE:** Ordering ink cartridges online is not supported in all countries/regions. If it is not available in your country/region, you may still view supplies information and print a list for reference when shopping at a local HP reseller.

---

## Choose right ink cartridges

HP recommends that you use Original HP ink cartridges. Original HP ink cartridges are designed and tested with HP printers to help you easily produce great results, time after time.

# Replace ink cartridges

## To replace the ink cartridges

1. Check that power is on.
2. Close the output tray extender, and then rotate the output tray clockwise to stow it in the printer.



3. Remove the ink cartridge.
  - a. Open the front door of the printer.



- b. Open the cartridge access door and wait for the print carriage to move to the center of the printer.

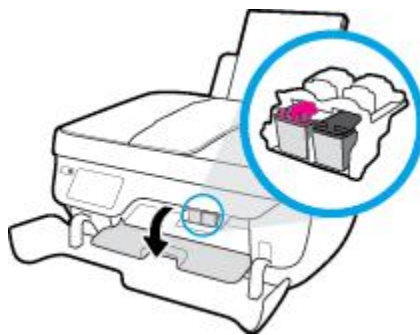

- c. Press down to release the ink cartridge, and then remove it from the slot.



4. Insert a new ink cartridge.
  - a. Remove the ink cartridge from the packaging.

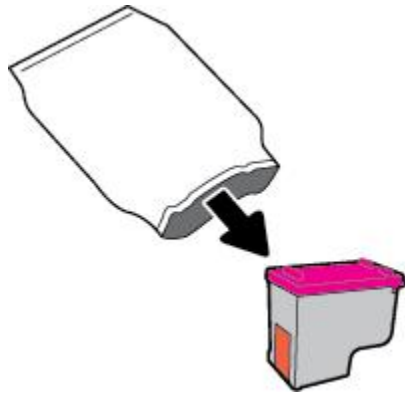

- b. Remove the plastic tape using the pull tab.

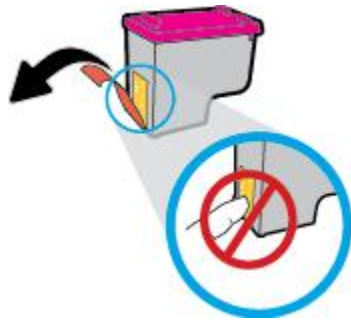

---

 **NOTE:** Do not touch the electrical contacts on the ink cartridge.

---

- c. Slide the ink cartridge into the slot until it clicks into place.

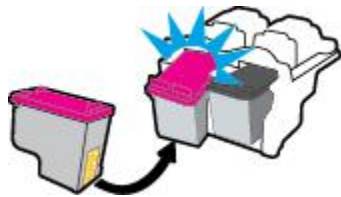

- d. Close the cartridge access door.



---

 **NOTE:** The HP printer software prompts you to align the ink cartridges when you print a document after installing the new ink cartridge.

---

- e. Close the front door of the printer.



- 5. Pull out the output tray and the tray extender.



## Use single-cartridge mode

Use the single-cartridge mode to operate the printer with only one ink cartridge. The single-cartridge mode is initiated when an ink cartridge is removed from the ink cartridge carriage.



**NOTE:** When the printer operates in single-cartridge mode, a message is displayed on the printer display. If the message is displayed and two ink cartridges are installed in the printer, verify that the protective piece of plastic tape has been removed from each ink cartridge. When the plastic tape covers the ink cartridge contacts, the printer cannot detect that the ink cartridge is installed. If there is no plastic tape on the cartridges, try cleaning the cartridge contacts. For information about cleaning ink cartridge contacts, see [ink cartridge issues on page 104](#).

### To exit the single-cartridge mode

- Install both the black and tri-color ink cartridges in the printer.



## Cartridge warranty information

The HP cartridge warranty is applicable when the cartridge is used in its designated HP printing device. This warranty does not cover HP ink cartridges that have been refilled, remanufactured, refurbished, misused, or tampered with.

During the warranty period the cartridge is covered as long as the HP ink is not depleted and the end of warranty date has not been reached. The end of warranty date, in YYYY/MM/DD format, may be found on the cartridge as indicated:

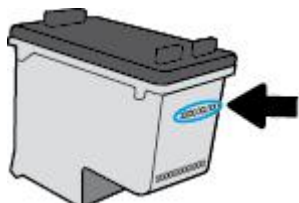

For a copy of the HP Limited Warranty Statement, see the printed documentation that came with the printer.

## Tips for working with ink cartridges

Use the following tips to work with ink cartridges:

- To protect the ink cartridges from drying out, always turn the printer off using the **Power** button, and wait until the **Power** button light goes out.
- Do not open or untape ink cartridges until you are ready to install them. Leaving tape on the ink cartridges reduces ink evaporation.
- Insert the ink cartridges into the correct slots. Match the color and icon of each ink cartridge to the color and icon for each slot. Make sure the ink cartridges snap into place.
- After you insert new ink cartridges, align the printer for best print quality. See [Printing issues on page 107](#) for more information.
- When the Estimated Ink Levels in the printer software shows one or both ink cartridges in a low state, consider getting replacement cartridges to avoid possible printing delays. You do not need to replace the ink cartridges until print quality becomes unacceptable. See [Replace ink cartridges on page 79](#) for more information.
- If you remove an ink cartridge from the printer for any reason, try to replace it again as soon as possible. Outside of the printer, if unprotected, ink cartridges begin to dry out.

---

## 8 Connect your printer

- [Connect your printer to a wireless network with a router](#)
- [Connect wirelessly to the printer without a router](#)
- [Wireless settings](#)
- [Connect your printer to your computer with a USB cable \(non-network connection\)](#)
- [Change from a USB connection to a wireless network](#)
- [Advanced printer management tools \(for networked printers\)](#)
- [Tips for setting up and using a networked printer](#)

## Connect your printer to a wireless network with a router

To connect the printer to an integrated wireless WLAN 802.11 network, you will need the following:

- A wireless 802.11b/g/n network that includes a wireless router or access point.



**NOTE:** The printer only supports connections using 2.4GHz.

- A computer connected to the wireless network that you intend to connect the printer to.
- Network name (SSID).
- WEP key or WPA Passphrase (if needed).

### To connect the printer

1. From the Home screen on the printer control panel, touch (Wireless).
2. Touch **Settings**.
3. Touch **Wireless Setup Wizard** or **Wi-Fi Protected Setup**.
4. Follow the on-screen instructions to complete the setup.

### To connect a new printer (Windows)

1. Open the printer software. For more information, see [Open the HP printer software \(Windows\) on page 15](#).
2. In the printer software, click **Utilities**.
3. Select **Printer Setup & Software**.
4. Select **Connect a new printer**. Follow the onscreen instructions.

### To connect a new printer (OS X)

1. Open **System Preferences**.
2. Depending on your operating system, click **Print & Fax**, **Print & Scan**, or **Printers & Scanners** in the **Hardware** section.
3. Click + below the list of printers at the left.
4. Select the new printer from the list.

# Connect wirelessly to the printer without a router

With Wi-Fi Direct, you can print wirelessly from a computer, smart phone, tablet, or other wireless-capable device—without connecting to an existing wireless network.

## Guidelines for using Wi-Fi Direct

- Make sure your computer or mobile device has the necessary software.
  - If you are using a computer, make sure you have installed the HP printer software.  
If you have not installed the HP printer software on the computer, connect to Wi-Fi Direct first and then install the printer software. Select **Wireless** when prompted by the printer software for a connection type.
  - If you are using a mobile device, make sure you have installed a compatible printing app. For more information about mobile printing, visit [www.hp.com/global/us/en/eprint/mobile\\_printing\\_apps.html](http://www.hp.com/global/us/en/eprint/mobile_printing_apps.html).
- Make sure Wi-Fi Direct for your printer is turned on.
- Up to five computers and mobile devices can use the same Wi-Fi Direct connection.
- Wi-Fi Direct can be used while the printer is also connected either to a computer using a USB cable or to a network using a wireless connection.
- Wi-Fi Direct cannot be used to connect a computer, mobile device, or printer to the Internet.

## To turn on Wi-Fi Direct

1. From the printer control panel, touch  (Wi-Fi Direct).
2. Touch **Settings**, and then **Wi-Fi Direct** to turn it on.
3. Press the **Back** button, and then find the Wi-Fi Direct name and password from the **Wi-Fi Direct Details** menu.

---

 **TIP:** You can also turn on Wi-Fi Direct from the EWS. For more information about using the EWS, see [Open the Embedded Web Server on page 94](#).

---

## To print from a wireless-capable mobile device that supports Wi-Fi Direct

Make sure you have installed the latest version of HP Print Service Plugin on your mobile device. You can download this plugin from the Google Play application store.

1. Make sure you have turned on Wi-Fi Direct on the printer.
2. Turn on Wi-Fi Direct on your mobile device. For more information, see the documentation provided with the mobile device.
3. From your mobile device, select a document from a print enabled application, and then select the option to print the document.

The list of available printers appears.

4. From the list of available printers, choose the Wi-Fi Direct name shown such as DIRECT-\*\*-HP OfficeJet 3830 (where \*\* are the unique characters to identify your printer), and then follow the on-screen instructions on the printer and your mobile device.

## To print from a wireless-capable mobile device that does not support Wi-Fi Direct

Make sure you have installed a compatible printing app on your mobile device. For more information, visit [www.hp.com/global/us/en/eprint/mobile\\_printing\\_apps.html](http://www.hp.com/global/us/en/eprint/mobile_printing_apps.html).

1. Make sure you have turned on Wi-Fi Direct on the printer.
2. Turn on the Wi-Fi connection on your mobile device. For more information, see the documentation provided with the mobile device.



---

**NOTE:** If your mobile device does not support Wi-Fi, you are not able to use Wi-Fi Direct.

---

3. From the mobile device, connect to a new network. Use the process you normally use to connect to a new wireless network or hotspot. Choose the Wi-Fi Direct name from the list of wireless networks shown such as DIRECT-\*\*-HP OfficeJet 3830 (where \*\* are the unique characters to identify your printer).

Enter the Wi-Fi Direct password when prompted.

4. Print your document.

## To print from a wireless-capable computer (Windows)

1. Make sure you have turned on Wi-Fi Direct on the printer.
2. Turn on the computer's Wi-Fi connection. For more information, see the documentation provided with the computer.



---

**NOTE:** If your computer does not support Wi-Fi, you are not able to use Wi-Fi Direct.

---

3. From the computer, connect to a new network. Use the process you normally use to connect to a new wireless network or hotspot. Choose the Wi-Fi Direct name from the list of wireless networks shown such as DIRECT-\*\*-HP OfficeJet 3830 (where \*\* are the unique characters to identify your printer and XXXX is the printer model located on the printer).

Enter the Wi-Fi Direct password when prompted.

4. Proceed to step 5 if the printer has been installed and connected to the computer over a wireless network. If the printer has been installed and connected to your computer with a USB cable, follow the steps below to install the printer software using the HP Wi-Fi Direct connection.
  - a. Depending on your operating system, do one of the following:
    - **Windows 8.1:** Click the down arrow in lower left corner of the Start screen, select the printer name, and then click **Utilities**.
    - **Windows 8:** Right-click an empty area on the Start screen, click **All Apps** on the app bar, select the printer name, and then click **Utilities**.
    - **Windows 7, Windows Vista, and Windows XP:** From the computer desktop, click **Start**, select **All Programs**, click **HP**, click the folder of your printer.
  - b. Click **Printer Setup & Software**, and then select **Connect a new printer**.
  - c. When the **Connection Options** software screen appears, select **Wireless**.  
Select your HP printer software name from the list of detected printers.
  - d. Follow the on-screen instructions.
5. Print your document.

## To print from a wireless-capable computer (OS X)

1. Make sure you have turned on Wi-Fi Direct on the printer.
2. Turn on Wi-Fi on the computer.

For more information, see the documentation provided by Apple.

3. Click the Wi-Fi icon and choose the Wi-Fi Direct name, such as DIRECT-\*\*-HP OfficeJet 3830 (where \*\* are the unique characters to identify your printer and XXXX is the printer model located on the printer).

If Wi-Fi Direct is turned on with security, enter the password when prompted.

4. Add the printer.
  - a. Open **System Preferences** .
  - b. Depending on your operating system, click **Print & Fax** , **Print & Scan** , or **Printers & Scanners** in the **Hardware** section.
  - c. Click + below the list of printers at the left.
  - d. Select the printer from the list of detected printers (the word “Bonjour” is listed the right column beside the printer name), and click **Add**.

# Wireless settings

From the printer control panel, you can set up and manage your printer wireless connection and perform a variety of network management tasks.

**⚠ CAUTION:** Network settings are provided for your convenience. However, unless you are an advanced user, you should not change some of these settings (such as the link speed, IP settings, default gateway, and firewall settings).

## To turn on or off the wireless capability of the printer

The blue Wireless light on the printer control panel is lit when the wireless capability of the printer is on.

1. From the printer control panel, touch  (Wireless).
2. Touch **Settings**.
3. Touch **Wireless** to turn it on or off.

## To view wireless details

1. From the Home screen, touch  (Wireless), and then touch **Settings**.
2. Touch **View Wireless Details**.

## To print the wireless test report

The wireless test report provides information about the printer status, hardware (MAC) address, and IP address. If the printer is connected to a network, the test report displays details about the network settings.

1. From the printer control panel, touch  (Wireless).
2. Touch **Settings**, and then touch **Print Reports**.
3. Touch **Wireless Test Report**.

## To print the network configuration page

1. From the printer control panel, touch  (Wireless).
2. Touch **Settings**, touch **Print Reports**, and then touch **Network Configuration Page**.

## To change wireless settings

1. From the Home screen, touch  (Wireless), and then touch **Settings**.
2. Touch **Advanced Settings**.
3. Select the item you want to change.
4. Follow the on-screen instructions.



### To restore network settings to default settings

1. From the Home screen, touch  (Wireless), and then touch **Settings** .
2. Touch **Restore Network Settings**.
3. Follow the on-screen instructions.

# Connect your printer to your computer with a USB cable (non-network connection)

The printer supports a rear USB 2.0 High Speed port for connection to a computer.

## To connect the printer with the USB cable

1. Visit [123.hp.com](http://123.hp.com) to download and install the printer software.



---

**NOTE:** Do not connect the USB cable to the printer until you are prompted to do so.

---

2. Follow the onscreen instructions. When you are prompted, connect the printer to the computer by selecting **USB** on the **Connection Options** screen.
3. Follow the onscreen instructions.

If the printer software has been installed, the printer will operate as a plug-and-play device.

## Change from a USB connection to a wireless network

If you first set up your printer and installed the software with a USB cable, directly connecting the printer to your computer, you can easily change to a wireless network connection. You will need a wireless 802.11b/g/n network that includes a wireless router or access point.



**NOTE:** The printer only supports connections using 2.4GHz.

---

Before changing from a USB connection to a wireless network, make sure that:

- The printer is connected to your computer with the USB cable until you are prompted to disconnect the cable.
- The computer is connected to the wireless network that you intend to install the printer on.

### Change from a USB connection to a wireless network (Windows)

1. Open the HP printer software. For more information, see [Open the HP printer software \(Windows\) on page 15](#).
2. In the printer software, click **Utilities**.
3. Click **Printer Setup & Software**.
4. Select **Convert a USB connected printer to wireless**. Follow the on-screen instructions.

### To change from a USB connection to a wireless network (OS X)

1. Connect the printer to your wireless network.
2. Use **HP Setup Assistant** in **Applications/Hewlett-Packard/Device Utilities** to change the software connection to wireless for this printer.

## Advanced printer management tools (for networked printers)

When the printer is connected to a network, you can use the Embedded Web Server (EWS) to view status information, change settings, and manage the printer from your computer.

 **NOTE:** You can open and use the EWS without being connected to the Internet. However, some features are not available.

 **NOTE:** To view or change some settings, you might need a password.

- [Open the Embedded Web Server](#)
- [About cookies](#)

### Open the Embedded Web Server

You can use one of the following ways to open the Embedded Web Server.

#### To open the Embedded Web Server through a network

 **NOTE:** The printer must be on a network and must have an IP address.

1. From the Home screen, touch **Wireless** to display the IP address of the printer.
2. In a supported web browser on your computer, type the IP address or hostname assigned to the printer.  
  
For example, if the IP address is 192.168.0.12, type the following address into a Web browser: `http://192.168.0.12`.

#### To open the Embedded Web Server from the HP printer software (Windows)

1. Open the printer software. For more information, see [Open the HP printer software \(Windows\) on page 15](#).
2. Click **Print, Scan & Fax**, and then click **Printer Home Page (EWS)**.

#### To open the Embedded Web Server using Wi-Fi Direct

1. From the Home screen, touch  (Wi-Fi Direct).
2. If the display shows that Wi-Fi Direct is **Off**, touch **Settings**, and then touch **Wi-Fi Direct** to switch it on.
3. From your wireless computer, turn wireless on, search for and connect to the Wi-Fi Direct name, for example: `DIRECT-**-HP OfficeJet 3830` (where \*\* are the unique characters to identify your printer). Enter the Wi-Fi Direct password when prompted.
4. In a supported Web browser on your computer, type the following address: `http://192.168.223.1`.

### About cookies

The Embedded Web Server (EWS) places very small text files (cookies) on your hard drive when you are browsing. These files let the EWS recognize your computer the next time you visit. For example, if you have configured the EWS language, a cookie helps remember which language you have selected so that the next time you access the EWS, the pages are displayed in that language. Some cookies (such as the cookie that stores customer-specific preferences) are stored on the computer until you clear them manually.

You can configure your browser to accept all cookies, or you can configure it to alert you every time a cookie is offered, which allows you to decide which cookies to accept or refuse. You can also use your browser to remove unwanted cookies.

Depending on your printer, if you disable cookies, you also disable one or more of the following features:

- Using some setup wizards
- Remembering the EWS browser language setting
- Personalizing the EWS Home page

For information about how to change your privacy and cookie settings and how to view or delete cookies, see the documentation available with your Web browser.

## Tips for setting up and using a networked printer

Use the following tips to set up and use a networked printer:

- When setting up the wireless networked printer, make sure your wireless router is powered on. The printer searches for wireless routers, then lists the detected network names on the display.
- To check the wireless connection on the printer, touch the  (Wireless) on the Home screen to open the Wireless menu. If it shows **Wireless Off** or **Not Connected**, touch **Settings**, and then touch **Wireless Setup Wizard**. Follow the on-screen instructions to set up your printer wireless connection.
- If your computer is connected to a Virtual Private Network (VPN), you need to disconnect from the VPN before you can access any other device on your network, including the printer.
- Learn more about configuring your network and the printer for wireless printing. [Click here to go online for more information.](#)
- Learn how to find your network security settings. [Click here to go online for more information.](#)
- Learn about the HP Print and Scan Doctor. [Click here to go online for more information.](#)



---

**NOTE:** This utility is only available for Windows operation system.

---

- Learn how to change from a USB to wireless connection. [Click here to go online for more information.](#)
- Learn how to work with your firewall and anti-virus programs during printer setup. [Click here to go online for more information.](#)

---

# 9 Solve a problem

This section contains the following topics:

- [Jams and paper-feed issues](#)
- [Ink cartridge issues](#)
- [Printing issues](#)
- [Copy issues](#)
- [Scan issues](#)
- [Fax issues](#)
- [Network and connection issues](#)
- [Printer hardware issues](#)
- [Maintain the document feeder](#)
- [HP support](#)

# Jams and paper-feed issues

What do you want to do?

## Clear a paper jam

<a href="#">Solve paper jam issues.</a>	Use an HP online troubleshooting wizard Instructions for clearing paper jams and resolving issues with paper or the paper feed.
---	--

 **NOTE:** The HP online troubleshooting wizards may not be available in all languages.

## Read general instructions in the Help for clearing paper jams

Paper jams can occur in several locations.

### To clear a paper jam from the input tray

1. Pull the paper gently out of the input tray.



2. Make sure there is no foreign object in the paper path, and then reload paper.

 **NOTE:** The input tray shield can prevent foreign debris from falling into the paper path and causing serious paper jams. Do not take down the input tray shield.

3. Touch **OK** on the printer control panel display to continue the current job.

### To clear a paper jam from the output tray

1. Pull the paper gently out of the output tray.



2. Touch **OK** on the printer control panel display to continue the current job.



### To clear a paper jam from the cartridge access area

1. Press the **Power** button to turn off the printer.
2. Close the output tray extender, and then rotate the output tray clockwise to stow it in the printer.



3. Open the front door of the printer.



4. Open the cartridge access door.
5. If the print carriage is in the center of the printer, slide it to the right.

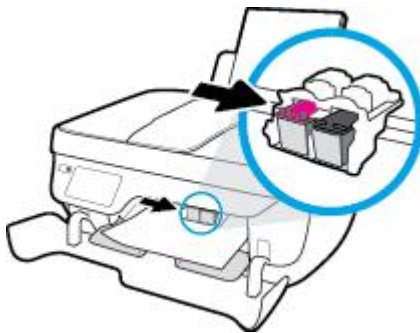

6. Remove the jammed paper.



7. Close the cartridge access door, and then close the front door.
8. Pull out the output tray and the tray extender.



9. Press the **Power** button to turn on the printer.

### To clear a paper jam inside of the printer

1. Press the **Power** button to turn off the printer.
2. Turn the printer over, locate the cleanout door on the bottom of the printer, and then pull both tabs on the cleanout door to open it.

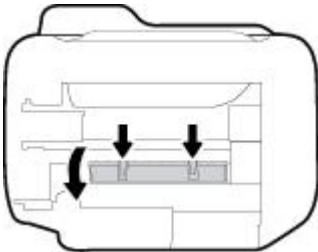

3. Remove the jammed paper.

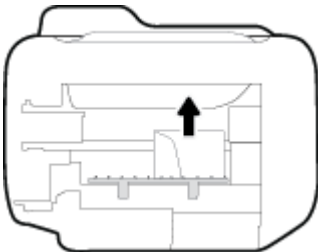

4. Close the cleanout door. Gently push the door towards the printer until both latches snap into place.

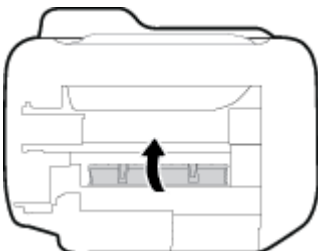

5. Turn the printer over, and then press the **Power** button to turn on the printer.

### To clear a jam in the document feeder

1. Lift the cover of the document feeder.



2. Lift the tab located on the front edge of the document feeder.



3. Gently pull the paper out of the rollers.

**⚠ CAUTION:** If the paper tears when you are removing it from the rollers, check the rollers and wheels for torn pieces of paper that might remain inside the printer. If you do not remove all the pieces of paper from the printer, more paper jams are likely to occur.



4. Close the cover of the document feeder, pressing down firmly until it snaps into place.
5. Touch **OK** on the printer control panel display to continue the current job.

## Clear a print carriage jam

[Resolve a print carriage jam.](#)

Use an HP online troubleshooting wizard

If something is blocking the print carriage or it does not move easily, get step-by-step instructions.



**NOTE:** The HP online troubleshooting wizards may not be available in all languages.

## Read general instructions in the Help for clearing a print carriage jams

1. Remove any objects, such as paper, that are blocking the print carriage.



**NOTE:** Do not use any tools or other devices to remove jammed paper. Always use caution when removing jammed paper from inside the printer

2. To get help from the print display, touch **Help** from the Home screen, touch **How to Videos**, and then touch **Clear Carriage Jam**.

## Learn how to avoid paper jams

To help avoid paper jams, follow these guidelines.

- Do not overfill the input tray.
- Remove printed papers from the output tray frequently.
- Ensure that paper loaded in the input tray lays flat, and the edges are not bent or torn.
- Do not combine different paper types and paper sizes in the input tray; the entire stack of paper in the input tray must be the same size and type.
- Adjust the paper-width guide in the input tray to fit snugly against all paper. Make sure the paper-width guide does not bend the paper in the input tray.
- Do not force paper too far down in the input tray.
- Do not add paper while the printer is printing. If the printer is about to run out of paper, wait until the out of paper message appears before adding paper.

## Solve paper-feed problems

What kind of problem are you having?

- **Paper is not picked up from the input tray**
  - Make sure paper is loaded in the input tray. For more information, see [Load media on page 7](#).
  - Adjust the paper-width guide in the input tray to fit snugly against all paper. Make sure the paper-width guide does not bend the paper in the input tray.
  - Make sure paper in the input tray is not curled. Uncurl paper by bending it in the opposite direction of the curl.
- **Pages are skewing**

- Make sure the paper is loaded in the far-right side of the input tray and the paper-width guide is fit against the left side of the paper.
- Load paper into the printer only when it is not printing.
- **Multiple pages are being picked up**
  - Adjust the paper-width guide in the input tray to fit snugly against all paper. Make sure the paper-width guide does not bend the paper in the input tray.
  - Make sure the input tray is not overloaded with paper.
  - Make sure the pieces of the loaded paper are not sticking together.
  - Use HP paper for optimum performance and efficiency.

# Ink cartridge issues

## Fix ink cartridge problems

If an error occurs after a cartridge is installed, or if a message indicates a cartridge problem, try removing the ink cartridges, verifying the protective piece of plastic tape has been removed from each ink cartridge, and then reinserting the ink cartridges. If this does not work, clean the cartridge contacts. If the problem is still not resolved, replace the ink cartridges. For information about replacing ink cartridges, see [Replace ink cartridges on page 79](#).

### To clean cartridge contacts

**CAUTION:** The cleaning procedure should take only a few minutes. Make sure that the ink cartridges are reinstalled in the printer as soon as possible. It is not recommended to leave the ink cartridges outside of the printer longer than 30 minutes. This could result in damage to the printhead or the ink cartridges.

1. Check that power is on.
2. Close the output tray extender, and then rotate the output tray clockwise to stow it in the printer.



3. Open the front door of the printer.



4. Open the cartridge access door and wait for the print carriage to move to the center of the printer.

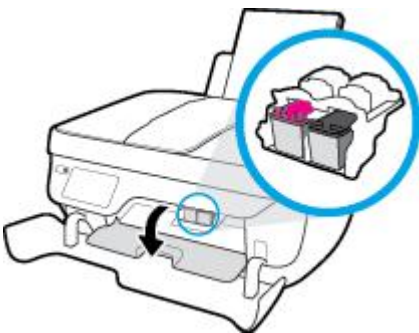

5. Remove the ink cartridge indicated in the error message.

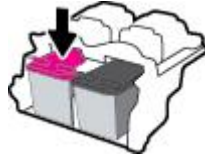

6. Clean the cartridge contacts and printer contacts.

- a. Hold the ink cartridge by its sides with the bottom pointing up and locate the electrical contacts on the ink cartridge.

The electrical contacts are the small gold-colored dots on the ink cartridge.

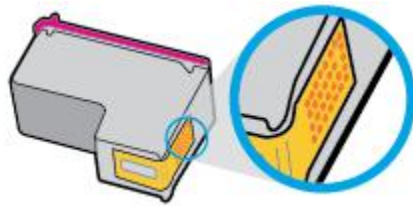

- b. Wipe only the contacts with a dry swab or lint-free cloth.

---

**⚠ CAUTION:** Be careful to wipe only the contacts, and do not smear any of the ink or other debris elsewhere on the ink cartridge.

---

- c. On the inside of the printer, locate the contacts for the cartridge.

The printer contacts are the set of gold-colored bumps positioned to meet the contacts on the ink cartridge.

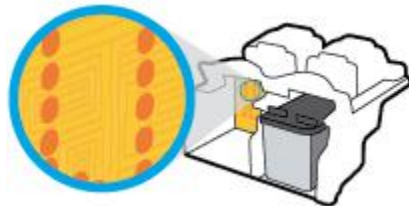

- d. Use a dry swab or lint-free cloth to wipe the contacts.

7. Reinstall the ink cartridge.
8. Close the cartridge access door, and then close the front door.
9. Check if the error message has gone away. If you still receive the error message, turn the printer off, and then on.

---

**📝 NOTE:** If one ink cartridge is causing problems, you can remove it and use the single-cartridge mode to operate the printer with only one ink cartridge.

---

## Fix ink cartridge incompatible issues

The ink cartridge is not compatible with your printer. This error can occur if you install an HP Instant Ink cartridge into a printer that has not been enrolled in the HP Instant Ink program. It can also occur if the HP Instant Ink cartridge was previously used in a different printer enrolled in the HP Instant Ink program.



# Printing issues

What do you want to do?

## Fix problems with page not printing (unable to print)

<a href="#">HP Print and Scan Doctor</a>	The HP Print and Scan Doctor is a utility that will try to diagnose and fix the issue automatically. <b>NOTE:</b> This utility is only available for Windows operation system.
<a href="#">Troubleshoot problems with print jobs not printing.</a>	Use an HP online troubleshooting wizard Get step-by-step instructions if the printer is not responding or printing.



**NOTE:** The HP Print and Scan Doctor and the HP online troubleshooting wizards may not be available in all languages.

## Read general instructions in the Help for unable to print issues

### To resolve print issues (Windows)

Make sure that the printer is turned on and that there is paper in the input tray. If you are still unable to print, try the following in order:

1. Check for error messages from the printer display and resolve them by following the on-screen instructions.
2. If your computer is connected to the printer with a USB cable, disconnect and reconnect the USB cable. If your computer is connected to the printer with a wireless connection, confirm that the connection is working.
3. Verify that the printer is not paused or offline.

### To verify that the printer is not paused or offline

- a. Depending on your operating system, do one of the following:
  - **Windows 8.1 and Windows 8:** Point to or tap the upper-right corner of the screen to open the Charms bar, click the **Settings** icon, click or tap **Control Panel**, and then click or tap **View devices and printers**.
  - **Windows 7:** From the Windows **Start** menu, click **Devices and Printers**.
  - **Windows Vista:** From the Windows **Start** menu, click **Control Panel**, and then click **Printers**.
  - **Windows XP:** From the Windows **Start** menu, click **Control Panel**, and then click **Printers and Faxes**.
- b. Either double-click the icon for your printer, or right-click the icon for your printer and select **See what's printing** to open the print queue.
- c. On the **Printer** menu, make sure there are no check marks next to **Pause Printing** or **Use Printer Offline**.
- d. If you make any changes, try to print again.

4. Verify that the printer is set as the default printer.

#### To verify that the printer is set as the default printer

- a. Depending on your operating system, do one of the following:
    - **Windows 8.1 and Windows 8:** Point to or tap the upper-right corner of the screen to open the Charms bar, click the **Settings** icon, click or tap **Control Panel**, and then click or tap **View devices and printers**.
    - **Windows 7:** From the Windows **Start** menu, click **Devices and Printers**.
    - **Windows Vista:** From the Windows **Start** menu, click **Control Panel**, and then click **Printers**.
    - **Windows XP:** From the Windows **Start** menu, click **Control Panel**, and then click **Printers and Faxes**.
  - b. Make sure the correct printer is set as the default printer.

The default printer has a check mark in a black or green circle next to it.
  - c. If the wrong printer is set as the default printer, right-click the correct printer and select **Set as Default Printer**.
  - d. Try using your printer again.
5. Restart the print spooler.

#### To restart the print spooler

- a. Depending on your operating system, do one of the following:
  - Windows 8.1 and Windows 8**
    - i. Point to or tap the upper-right corner of the screen to open the Charms bar, and then click the **Settings** icon.
    - ii. Click or tap **Control Panel**, and then click or tap **System and Security**.
    - iii. Click or tap **Administrative Tools**, and then double-click or double-tap **Services**.
    - iv. Right-click or touch and hold **Print Spooler**, and then click **Properties**.
    - v. On the **General** tab, next to **Startup type**, make sure that **Automatic** is selected.
    - vi. If the service is not already running, under **Service status**, click or tap **Start**, and then click or tap **OK**.

#### Windows 7

- i. From the Windows **Start** menu, click **Control Panel**, **System and Security**, and then **Administrative Tools**.
- ii. Double-click **Services**.
- iii. Right-click the **Print Spooler**, and then click **Properties**.
- iv. On the **General** tab, next to **Startup type**, make sure that **Automatic** is selected.
- v. If the service is not already running, under **Service status**, click **Start**, and then click **OK**.

## Windows Vista

- i. From the Windows **Start** menu, click **Control Panel, System and Maintenance, Administrative Tools**.
- ii. Double-click **Services**.
- iii. Right-click the **Print Spooler service**, and then click **Properties**.
- iv. On the **General** tab, next to **Startup type**, make sure that **Automatic** is selected.
- v. If the service is not already running, under **Service status**, click **Start**, and then click **OK**.

## Windows XP

- i. From the Windows **Start** menu, right click **My Computer**.
  - ii. Click **Manage**, and then click **Services and Applications**.
  - iii. Double-click **Services**, and then select **Print Spooler**.
  - iv. Right-click **Print Spooler**, and click **Restart** to restart the service.
- b. Make sure the correct printer is set as the default printer.
- The default printer has a check mark in a black or green circle next to it.
- c. If the wrong printer is set as the default printer, right-click the correct printer and select **Set as Default Printer**.
- d. Try using your printer again.
6. Restart the computer.
7. Clear the print queue.

## To clear the print queue

- a. Depending on your operating system, do one of the following:
  - **Windows 8.1 and Windows 8:** Point to or tap the upper-right corner of the screen to open the Charms bar, click the **Settings** icon, click or tap **Control Panel**, and then click or tap **View devices and printers**.
  - **Windows 7:** From the Windows **Start** menu, click **Devices and Printers**.
  - **Windows Vista:** From the Windows **Start** menu, click **Control Panel**, and then click **Printers**.
  - **Windows XP:** From the Windows **Start** menu, click **Control Panel**, and then click **Printers and Faxes**.
- b. Double-click the icon for your printer to open the print queue.
- c. On the **Printer** menu, click **Cancel all documents** or **Purge Print Document**, and then click **Yes** to confirm.
- d. If there are still documents in the queue, restart the computer and try printing again after the computer has restarted.
- e. Check the print queue again to make sure it is clear, and then try to print again.

## To resolve print issues (OS X)

1. Check for error messages and resolve.
2. Disconnect and reconnect the USB cable.
3. Verify that the product is not paused or offline.

### To verify that the product is not paused or offline

- a. In **System Preferences**, click **Print & Fax**.
- b. Click the **Open Print Queue** button.
- c. Click a print job to select it.

Use the following buttons to manage the print job:

- **Delete:** Cancel the selected print job.
  - **Hold:** Pause the selected print job.
  - **Resume:** Continue a paused print job.
  - **Pause Printer:** Pause all print jobs in the print queue.
- d. If you made any changes, try to print again.
4. Restart the computer.

## Fix print quality issues

---

[Step-by-step instructions for resolving most print quality issues.](#)

[Troubleshoot print quality issues online](#)

---

## Read general instructions in the Help for resolving print quality issues



**NOTE:** To protect the cartridges from drying out, always turn the printer off using the **Power** button, and wait until the **Power** button light goes out.

---

## To improve print quality (Windows)

1. Make sure you are using Original HP ink cartridges and HP recommended papers.
2. Check the printer software to make sure you have selected the appropriate paper type from the **Media** drop-down list and print quality in the **Quality Settings** area.

In the printer software, click **Print, Scan & Fax** and then click **Set Preferences** to access the print properties.

3. Check the estimated ink levels to determine if the ink cartridges are low on ink.

For more information, see [Check estimated ink levels on page 76](#). If the ink cartridges are low on ink consider replacing them.

4. Check the paper type.

For best print quality, use high quality HP paper, or papers that adhere to the ColorLok standard. For more information, see [Paper basics on page 13](#).

Always make sure the paper you are printing on is flat. For best results when printing images, use HP Advanced Photo Paper.

Store specialty paper in its original packaging inside a resealable plastic bag on a flat surface in a cool, dry place. When you are ready to print, remove only the paper you plan to use immediately. When you have finished printing, return any unused photo paper to the plastic bag. This prevents the photo paper from curling.

5. Align the ink cartridges.

**To align the cartridges from the printer software**

- a. Load letter or A4 unused plain white paper into the input tray.
- b. Open the printer software. For more information, see [Open the HP printer software \(Windows\) on page 15](#).
- c. In the printer software, click **Print, Scan & Fax**, and then click **Maintain Your Printer** to access the printer toolbox.

The printer toolbox appears.

- d. Click **Align Ink Cartridges** on the **Device Services** tab.

The printer prints an alignment sheet.

- e. Load the cartridge alignment sheet print side down on the right front corner of the scanner glass.

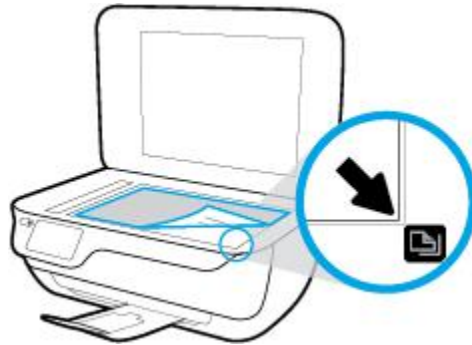

- f. Follow the instructions on the printer display to align the cartridges. Recycle or discard the cartridge alignment sheet.

**To align the cartridges from the printer display**

- a. Load Letter or A4 unused plain white paper into the input tray.
- b. From the Home screen, touch **Setup**.
- c. Touch **Tools**, touch **Align Printer**, and then follow the on-screen instructions.

6. Print a diagnostics page if the ink cartridges are not low on ink.

**To print a diagnostics page from the printer software**

- a. Load letter or A4 unused plain white paper into the input tray.
- b. Open the printer software. For more information, see [Open the HP printer software \(Windows\) on page 15](#).

- c. In the printer software, click **Print, Scan & Fax**, and then click **Maintain Your Printer** to access the printer toolbox.
- d. Click **Print Diagnostic Information** on the **Device Reports** tab to print a diagnostics page. Review the blue, magenta, yellow, and black boxes on the diagnostics page.

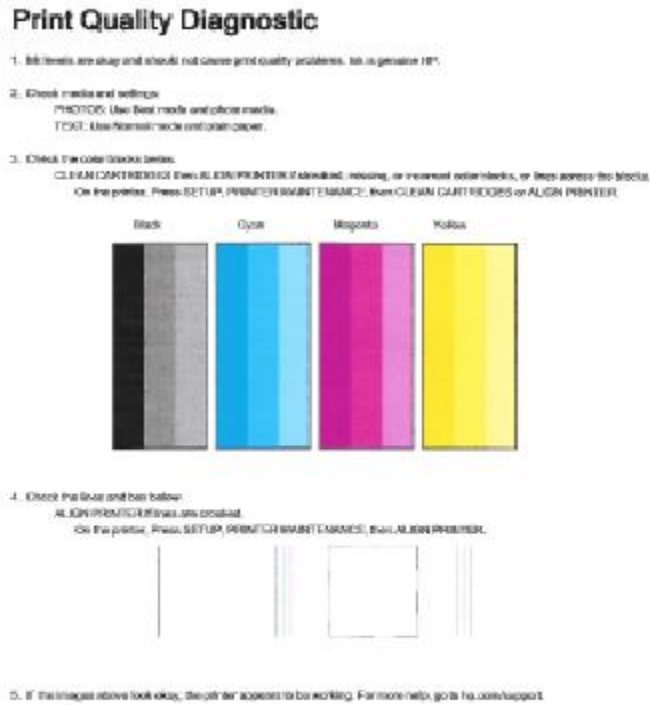

### To print a diagnostics page from the printer display

- a. Load letter or A4 unused plain white paper into the paper tray.
  - b. From the printer control panel, touch **Setup**.
  - c. Touch **Tools**.
  - d. Touch **Print Quality Report**.
7. Do one of the following to clean the ink cartridges, if the diagnostic page shows streaks or missing portions of the color and black boxes.

### To clean the cartridges from the printer software

- a. Load letter or A4 unused plain white paper into the input tray.
- b. Open the printer software. For more information, see [Open the HP printer software \(Windows\) on page 15](#).

- c. In the printer software, click **Print, Scan & Fax** , and then click **Maintain Your Printer** to access the **Printer Toolbox**.
- d. Click **Clean Printer** on the **Device Services** tab. Follow the on-screen instructions.

#### To clean the cartridges from the printer display

- a. Load Letter or A4 unused plain white paper into the input tray.
- b. From the Home screen, touch **Setup** .
- c. Touch **Tools** , touch **Clean Cartridges**, and then follow the on-screen instructions.

If cleaning the printhead does not solve the problem, contact HP support. Go to [www.hp.com/support](http://www.hp.com/support) . This website provides information and utilities that can help you correct many common printer problems. If prompted, select your country/region, and then click **All HP Contacts** for information on calling for technical support.

#### To improve print quality (OS X)

1. Make sure you are using original HP cartridges.
2. Make sure you have selected the appropriate paper type and print quality in the **Print** dialog.
3. Check the estimated ink levels to determine if the cartridges are low on ink.

Consider replacing the print cartridges if they are low on ink.

4. Check the paper type.

For best print quality, use high quality HP paper, or papers that adhere to the ColorLok® standard. For more information, see [Paper basics on page 13](#).

Always make sure the paper you are printing on is flat. For best results when printing images, use HP Advanced Photo Paper.

Store specialty paper in its original packaging inside a resealable plastic bag on a flat surface in a cool, dry place. When you are ready to print, remove only the paper you plan to use immediately. When you have finished printing, return any unused photo paper to the plastic bag. This prevents the photo paper from curling.

5. Align the printer cartridges.

#### To align print cartridges from the software

- a. Load Letter or A4 plain, white paper in the paper tray.
- b. Open HP Utility.



---

**NOTE:** HP Utility is located in the **Hewlett-Packard** folder in the **Applications** folder at the top level of the hard disk.

---

- c. Select the HP OfficeJet 3830 series from the list of devices at the left of the window.
- d. Click **Align**.
- e. Click **Align** and follow the on-screen instructions.
- f. Click **All Settings** to return to the **Information and Support** pane.

6. Print a test page.

#### To print a test page

- a. Load Letter or A4 plain, white paper in the paper tray.
- b. Open HP Utility.



---

**NOTE:** HP Utility is located in the **Hewlett-Packard** folder in the **Applications** folder at the top level of the hard disk.

---

- c. Select the HP OfficeJet 3830 series from the list of devices at the left of the window.
- d. Click **Test Page**.
- e. Click the **Print Test Page** button, and follow the on-screen instructions.

Check the test page for jagged lines in the text or streaks in the text and colored boxes. If you are seeing jagged lines, or streaks, or no ink in portions of the boxes, then automatically clean the cartridges.

7. If the diagnostic page shows streaks or missing portions of the text or colored boxes, clean the print cartridges automatically.

#### To automatically clean the print head

- a. Load Letter or A4 plain, white paper in the paper tray.
- b. Open HP Utility.



---

**NOTE:** HP Utility is located in the **Hewlett-Packard** folder in the **Applications** folder at the top level of the hard disk.

---

- c. Select the HP OfficeJet 3830 series from the list of devices at the left of the window.
- d. Click **Clean Printheads**.
- e. Click **Clean**, and follow the on-screen instructions.



---

**CAUTION:** Clean the print head only when necessary. Unnecessary cleaning wastes ink and shortens the life of the print head.

---



---

**NOTE:** If print quality still seems poor after you complete cleaning, try aligning the printer. If print quality problems persist after cleaning and aligning, contact HP support.

---

- f. Click **All Settings** to return to the **Information and Support** pane.

### Fix ink smears on printouts

If a printout shows smears of ink, for subsequent prints, try using the Clean Page Smear function from the printer display. This process takes several minutes to complete. Full-size plain paper needs to be loaded and will be moved back and forth during the cleaning. Mechanical noises are normal at this time.

1. Load Letter or A4 unused plain white paper into the input tray.
2. From the Home screen, touch **Setup**.
3. Touch **Tools**, touch **Clean Page Smears**, and then follow the on-screen instructions.





---

**NOTE:** You can also do the same from the HP printer software or Embedded Web Server (EWS). To access the software or EWS, see [Open the HP printer software \(Windows\) on page 15](#) or [Open the Embedded Web Server on page 94](#).

---

## Copy issues

---

[Troubleshoot copy problems.](#)

Use an HP online troubleshooting wizard

Get step-by-step instructions if the printer does not create a copy, or if your printouts are low quality.

---



**NOTE:** The HP online troubleshooting wizards may not be available in all languages.

---

[Tips for copy and scan success on page 52](#)

## Scan issues

<a href="#">HP Print and Scan Doctor</a>	The HP Print and Scan Doctor is a utility that will try to diagnose and fix the issue automatically. <b>NOTE:</b> This utility is only available for Windows operation system.
<a href="#">Solve scan problems</a>	Use an HP online troubleshooting wizard  Get step-by-step instructions if you cannot create a scan or if your scans are low quality.



**NOTE:** The HP Print and Scan Doctor and the HP online troubleshooting wizards may not be available in all languages.

[Tips for copy and scan success on page 52](#)

## Fax issues

Run the fax test report first to see if there is a problem with your fax setup. If the test passes and you are still having problems faxing, check the fax settings listed in the report to verify that the settings are correct.

### Run the fax test

You can test your fax setup to check the status of the printer and to make sure it is set up correctly for faxing. Perform this test only after you have completed fax setup on the printer. The test does the following:

- Tests the fax hardware
- Verifies that the correct type of phone cord is connected to the printer
- Checks that the phone cord is plugged into the correct port
- Checks for a dial tone
- Tests the status of your phone line connection
- Checks for an active phone line

#### To test fax setup via the printer control panel

1. Set up the printer for faxing according to your particular home or office setup instructions.
2. Make sure the ink cartridges are installed and that full-size paper is loaded in the input tray before starting the test.
3. On the **Fax** screen, touch **Setup** , touch **Tools** , touch **Test Fax** , and then follow the on-screen instructions.

The printer displays the status of the test on the display and prints a report.

4. Review the report.
  - If the fax test failed, review the solutions below.
  - If the fax test passed and you are still having problems faxing, verify that the fax settings listed in the report are correct. You can also use HP's online troubleshooting wizard.

### What to do if the fax test failed

If you ran a fax test and the test failed, review the report for basic information about the error. For more detailed information, check the report to see which part of the test failed, and then review the appropriate topic in this section for solutions to try.

### The "Fax Hardware Test" failed

- Turn the printer off by pressing **Power** button located on the printer control panel and then unplug the power cord from the back of the printer. After a few seconds, plug the power cord in again, and then turn the power on. Run the test again. If the test fails again, continue reviewing the troubleshooting information in this section.
- Try to send or receive a test fax. If you can send or receive a fax successfully, there might not be a problem.
- If you are running the test from the **Fax Setup Wizard** (Windows) or **HP Utility** (OS X), make sure the printer is not busy completing another task, such as receiving a fax or making a copy. Check the display for a message indicating that the printer is busy. If it is busy, wait until it is finished and in the idle state before running the test.
- If you are using a phone splitter, this can cause faxing problems. (A splitter is a two-cord connector that plugs into a telephone wall jack.) Try removing the splitter and connecting the printer directly to the telephone wall jack.

After you resolve any problems found, run the fax test again to make sure it passes and the printer is ready for faxing. If the **Fax Hardware Test** continues to fail and you experience problems faxing, contact HP support. Go to [www.hp.com/support](http://www.hp.com/support). This website provides information and utilities that can help you correct many common printer problems. If prompted, select your country/region, and then click **All HP Contacts** for information on calling for technical support.

### The "Fax Connected to Active Telephone Wall Jack" test failed

- Check the connection between the telephone wall jack and the printer to make sure the phone cord is secure.
- Connect one end of the phone cord to your telephone wall jack, then connect the other end to the port labeled 1-LINE on the back of the printer.
- If you are using a phone splitter, this can cause faxing problems. (A splitter is a two-cord connector that plugs into a telephone wall jack.) Try removing the splitter and connecting the printer directly to the telephone wall jack.
- Try connecting a working phone and phone cord to the telephone wall jack that you are using for the printer and check for a dial tone. If you do not hear a dial tone, contact your telephone company and have them check the line.
- Try to send or receive a test fax. If you can send or receive a fax successfully, there might not be a problem.

After you resolve any problems found, run the fax test again to make sure it passes and the printer is ready for faxing.

### The "Phone Cord Connected to Correct Port on Fax" test failed

If you are using a phone splitter, this can cause faxing problems. (A splitter is a two-cord connector that plugs into a telephone wall jack.) Try removing the splitter and connecting the printer directly to the telephone wall jack.

#### Plug the phone cord into the correct port

1. Connect one end of the phone cord to your telephone wall jack, then connect the other end to the port labeled 1-LINE on the back of the printer.

 **NOTE:** If you use the 2-EXT port to connect to the telephone wall jack, you cannot send or receive faxes. The 2-EXT port should only be used to connect other equipment, such as an answering machine.

**Figure 9-1** Back view of the printer

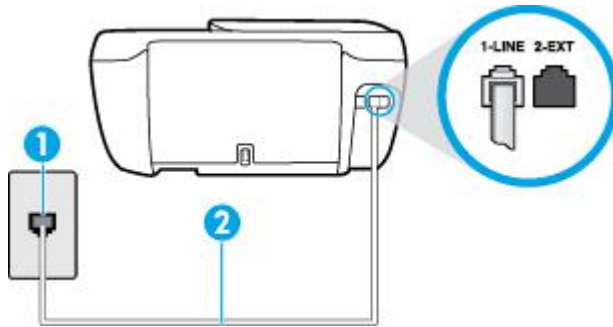

- |   |   |
|---|---|
| 1 | Telephone wall jack   |
| 2 | Use the phone cord supplied in the box with the printer to connect to the "1-LINE" port |

2. After you have connected the phone cord to the port labeled 1-LINE, run the fax test again to make sure it passes and the printer is ready for faxing.
3. Try to send or receive a test fax.

#### The "Using Correct Type of Phone Cord with Fax" test failed

- Connect one end of the phone cord to your telephone wall jack, then connect the other end to the port labeled 1-LINE on the back of the printer.

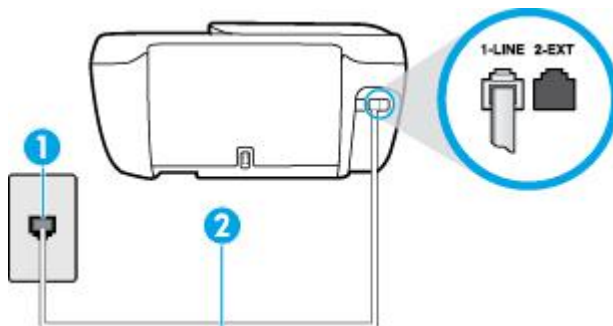

- |   |   |
|---|---|
| 1 | Telephone wall jack   |
| 2 | Use the phone cord supplied in the box with the printer to connect to the "1-LINE" port |

- Check the connection between the telephone wall jack and the printer to make sure the phone cord is secure.
- If you are using a phone splitter, this can cause faxing problems. (A splitter is a two-cord connector that plugs into a telephone wall jack.) Try removing the splitter and connecting the printer directly to the telephone wall jack.

### The "Dial Tone Detection" test failed

- Other equipment, which uses the same phone line as the printer, might be causing the test to fail. To find out if other equipment is causing a problem, disconnect everything from the phone line, and then run the test again. If the **Dial Tone Detection Test** passes without the other equipment, then one or more pieces of the equipment is causing problems; try adding them back one at a time and rerunning the test each time, until you identify which piece of equipment is causing the problem.
- Try connecting a working phone and phone cord to the telephone wall jack that you are using for the printer and check for a dial tone. If you do not hear a dial tone, contact your telephone company and have them check the line.
- Connect one end of the phone cord to your telephone wall jack, then connect the other end to the port labeled 1-LINE on the back of the printer.
- If you are using a phone splitter, this can cause faxing problems. (A splitter is a two-cord connector that plugs into a telephone wall jack.) Try removing the splitter and connecting the printer directly to the telephone wall jack.
- If your telephone system is not using a standard dial tone, such as some private branch exchange (PBX) systems, this might cause the test to fail. This does not cause a problem sending or receiving faxes. Try sending or receiving a test fax.
- Check to make sure the country/region setting is set appropriately for your country/region. If the country/region setting is not set or is set incorrectly, the test might fail and you might have problems sending and receiving faxes.
- Make sure you connect the printer to an analog phone line or you cannot send or receive faxes. To check if your phone line is digital, connect a regular analog phone to the line and listen for a dial tone. If you do not hear a normal sounding dial tone, it might be a phone line set up for digital phones. Connect the printer to an analog phone line and try sending or receiving a fax.

After you resolve any problems found, run the fax test again to make sure it passes and the printer is ready for faxing. If the **Dial Tone Detection** test continues to fail, contact your telephone company and have them check the phone line.

### The "Fax Line Condition" test failed

- Make sure you connect the printer to an analog phone line or you cannot send or receive faxes. To check if your phone line is digital, connect a regular analog phone to the line and listen for a dial tone. If you do not hear a normal sounding dial tone, it might be a phone line set up for digital phones. Connect the printer to an analog phone line and try sending or receiving a fax.
- Check the connection between the telephone wall jack and the printer to make sure the phone cord is secure.
- Connect one end of the phone cord to your telephone wall jack, then connect the other end to the port labeled 1-LINE on the back of the printer.
- Other equipment, which uses the same phone line as the printer, might be causing the test to fail. To find out if other equipment is causing a problem, disconnect everything from the phone line, and then run the test again.

- If the **Fax Line Condition Test** passes without the other equipment, then one or more pieces of the equipment is causing problems; try adding them back one at a time and rerunning the test each time, until you identify which piece of equipment is causing the problem.
- If the **Fax Line Condition Test** fails without the other equipment, connect the printer to a working phone line and continue reviewing the troubleshooting information in this section.
- If you are using a phone splitter, this can cause faxing problems. (A splitter is a two-cord connector that plugs into a telephone wall jack.) Try removing the splitter and connecting the printer directly to the telephone wall jack.

After you resolve any problems found, run the fax test again to make sure it passes and the printer is ready for faxing. If the **Fax Line Condition** test continues to fail and you experience problems faxing, contact your telephone company and have them check the phone line.

## Troubleshoot fax problems

<a href="#">Troubleshoot fax problems.</a>	Use an HP online troubleshooting wizard
	Resolve problems sending or receiving a fax or faxing to your computer.



**NOTE:** The HP online troubleshooting wizards may not be available in all languages.

## Read general instructions in the Help for specific fax problems

What kind of fax problem are you having?

### The display always shows Phone Off Hook

- HP recommends using a 2-wire phone cord.
- Other equipment that uses the same phone line as the printer might be in use. Make sure extension phones (phones on the same phone line, but not connected to the printer) or other equipment are not in use or off the hook. For example, you cannot use the printer for faxing if an extension phone is off the hook, or if you are using a computer dial-up modem to send email or access the Internet.

### The printer is having problems sending and receiving faxes

- Make sure the **Power** button light of the printer is on. If the light is off and the printer display is blank, make sure the power cord is firmly connected to the printer and plugged into a power outlet, and then press the **Power** button to turn on the printer.

After turning on the printer, HP recommends you wait five minutes before sending or receiving a fax. The printer cannot send or receive faxes while it is initializing after being turned on.



- Make sure you used the phone cord supplied in the box with the printer to connect to the telephone wall jack. One end of the phone cord should be connected to the port labeled 1-LINE on the back of the printer and the other end to your telephone wall jack, as shown in the illustration.

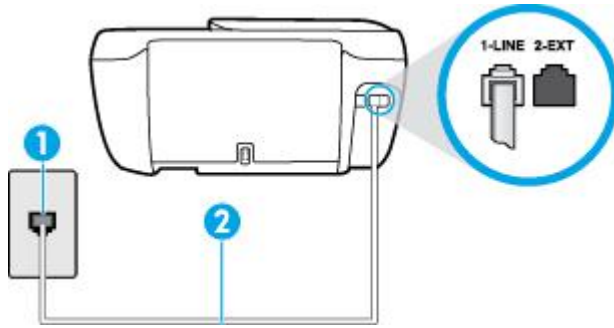

1	Telephone wall jack
2	Use the phone cord supplied in the box with the printer to connect to the "1-LINE" port

- Try connecting a working phone and phone cord to the telephone wall jack that you are using for the printer and check for a dial tone. If you do not hear a dial tone, call your local telephone company for service.
- Other equipment, which uses the same phone line as the printer, might be in use. For example, you cannot use the printer for faxing if an extension phone is off the hook, or if you are using a computer dial-up modem to send an email or access the Internet.
- Check to see if another process has caused an error. Check the display or your computer for an error message providing information about the problem and how to solve it. If there is an error, the printer cannot send or receive a fax until the error condition is resolved.
- The phone line connection might be noisy. Phone lines with poor sound quality (noise) can cause faxing problems. Check the sound quality of the phone line by plugging a phone into the telephone wall jack and listening for static or other noise. If you hear noise, turn **Error Correction Mode (ECM)** off and try faxing again. For information about changing ECM, see [Send a fax in Error Correction Mode on page 56](#). If the problem persists, contact your telephone company.
- If you are using a digital subscriber line (DSL) service, make sure that you have a DSL filter connected or you cannot fax successfully.
- Make sure the printer is not connected to a telephone wall jack that is set up for digital phones. To check if your phone line is digital, connect a regular analog phone to the line and listen for a dial tone. If you do not hear a normal sounding dial tone, it might be a phone line set up for digital phones.
- If you are using either a private branch exchange (PBX) or an integrated services digital network (ISDN) converter/terminal adapter, make sure the printer is connected to the correct port and the terminal adapter is set to the correct switch type for your country/region, if possible.
- If the printer shares the same phone line with a DSL service, the DSL modem might not be grounded correctly. If the DSL modem is not grounded correctly, it can create noise on the phone line. Phone lines with poor sound quality (noise) can cause faxing problems. You can check the sound quality of the phone line by plugging a phone into the telephone wall jack and listening for static or other noise. If you hear noise, turn off your DSL modem and completely remove power for at least 15 minutes. Turn the DSL modem back on and listen to the dial tone again.

 **NOTE:** You might notice static on the phone line again in the future. If the printer stops sending and receiving faxes, repeat this process.

If the phone line is still noisy, contact your telephone company. For information on turning your DSL modem off, contact your DSL provider for support.

- If you are using a phone splitter, this can cause faxing problems. (A splitter is a two-cord connector that plugs into a telephone wall jack.) Try removing the splitter and connecting the printer directly to the telephone wall jack.

### The printer cannot receive faxes, but can send faxes

- If you are not using a distinctive ring service, check to make sure that the **Distinctive Ring** feature on the printer is set to **All Standard Rings**. For more information, see [Change the answer ring pattern for distinctive ring on page 65](#).
- If **Auto Answer** is set to **Off**, you need to receive faxes manually; otherwise, the printer cannot receive the fax. For information on receiving faxes manually, see [Receive a fax manually on page 57](#).
- If you have a voice mail service at the same phone number you use for fax calls, you must receive faxes manually, not automatically. This means that you must be available to respond in person to incoming fax calls.
- If you have a computer dial-up modem on the same phone line with the printer, check to make sure that the software that came with your modem is not set to receive faxes automatically. Modems that are set up to receive faxes automatically take over the phone line to receive all incoming faxes, which prevents the printer from receiving fax calls.
- If you have an answering machine on the same phone line with the printer, you might have one of the following problems:
  - Your answering machine might not be set up correctly with the printer.
  - Your outgoing message might be too long or too loud to allow the printer to detect fax tones, and the sending fax machine might disconnect.
  - Your answering machine might not have enough quiet time after your outgoing message to allow the printer to detect fax tones. This problem is most common with digital answering machines.

The following actions might help solve these problems:

- When you have an answering machine on the same phone line you use for fax calls, try connecting the answering machine directly to the printer.
- Make sure the printer is set to receive faxes automatically. For information on setting up the printer to receive faxes automatically, see [Receive a fax on page 57](#).
- Make sure the **Rings to Answer** setting is set to a greater number of rings than the answering machine. For more information, see [Set the number of rings before answering on page 65](#).
- Disconnect the answering machine and then try receiving a fax. If faxing is successful without the answering machine, the answering machine might be causing the problem.
- Reconnect the answering machine and record your outgoing message again. Record a message that is approximately 10 seconds in duration. Speak slowly and at a low volume when recording your message. Leave at least 5 seconds of silence at the end of the voice message. There should be no background noise when recording this silent time. Try to receive a fax again.



**NOTE:** Some digital answering machines might not retain the recorded silence at the end of your outgoing message. Play back your outgoing message to check.

- If the printer shares the same phone line with other types of phone equipment, such as an answering machine, a computer dial-up modem, or a multi-port switch box, the fax signal level might be reduced. The signal level can also be reduced if you use a splitter or connect extra cables to extend the length of your phone. A reduced fax signal can cause problems during fax reception.

To find out if other equipment is causing a problem, disconnect everything except the printer from the phone line, and then try to receive a fax. If you can receive faxes successfully without the other equipment, one or more pieces of the other equipment is causing problems; try adding them back one at a time and receiving a fax each time, until you identify which equipment is causing the problem.

- If you have a special ring pattern for your fax phone number (using a distinctive ring service through your telephone company), make sure that the **Distinctive Ring** feature on the printer is set to match. For more information, see [Change the answer ring pattern for distinctive ring on page 65](#).

## The printer cannot send faxes, but can receive faxes

- The printer might be dialing too fast or too soon. You might need to insert some pauses in the number sequence. For example, if you need to access an outside line before dialing the phone number, insert a pause following the access number. If your number is 95555555, and 9 accesses an outside line, you might insert pauses as follows: 9-555-5555. To enter a pause in the fax number you are typing, touch the \* repeatedly, until a dash (-) appears on the display.

You can also send the fax using monitor dialing. This enables you to listen to the phone line as you dial. You can set the pace of your dialing and respond to prompts as you dial. For more information, see [Send a fax using monitor dialing on page 55](#).

- The number you entered when sending the fax is not in the proper format or the receiving fax machine is having problems. To check this, try calling the fax number from a telephone and listen for fax tones. If you cannot hear fax tones, the receiving fax machine might not be turned on or connected, or a voice mail service could be interfering with the recipient's phone line. You can also ask the recipient to check the receiving fax machine for any problems.

## Fax tones are recorded on my answering machine

- When you have an answering machine on the same phone line you use for fax calls, try connecting the answering machine directly to the printer, [click here to go online for more information](#). If you do not connect the answering machine as recommended, fax tones might be recorded on your answering machine.
- Make sure the printer is set to receive faxes automatically and that the **Rings to Answer** setting is correct. The number of rings to answer for the printer should be greater than the number of rings to answer for the answering machine. If the answering machine and the printer are set to the same number of rings to answer, both devices answer the call and fax tones are recorded on the answering machine.
- Set your answering machine to a low number of rings and the printer to answer in the maximum number of rings supported. (The maximum number of rings varies by country/region.) In this setup, the answering machine answers the call and the printer monitors the line. If the printer detects fax tones, the printer receives the fax. If the call is a voice call, the answering machine records the incoming message. For more information, see [Set the number of rings before answering on page 65](#).

# Network and connection issues

What do you want to do?

## Fix wireless connection

Choose one of the following troubleshooting options.

<a href="#">HP Print and Scan Doctor</a>	The HP Print and Scan Doctor is a utility that will try to diagnose and fix the issue automatically. <b>NOTE:</b> This utility is only available for Windows operation system.
Use an HP online troubleshooting wizard	<ul style="list-style-type: none"><li>• <a href="#">Troubleshoot your wireless problem</a>, whether your printer has never been connected or it was connected and is no longer working.</li><li>• <a href="#">Troubleshoot a firewall or antivirus issue</a>, if you suspect that it is preventing your computer from connecting to the printer.</li></ul>

 **NOTE:** The HP Print and Scan Doctor and the HP online troubleshooting wizards may not be available in all languages.

## Read general instructions in the Help for wireless troubleshooting

Check the network configuration or print the wireless test report to assist in diagnosing network connection issues.

1. From the Home screen, touch  (Wireless) and then touch **Settings**.
2. Touch **Print Reports**, and then touch **Network Configuration Page** or **Wireless Test Report**.

## Find network settings for wireless connection

Choose one of the following troubleshooting options.

<a href="#">HP Print and Scan Doctor</a>	The HP Print and Scan Doctor is a utility that can tell you the network name (SSID) and password (network key). <b>NOTE:</b> This utility is only available for Windows operation system.
<a href="#">Use an HP online troubleshooting wizard</a>	Learn how to find your network name (SSID) and wireless password.

 **NOTE:** The HP Print and Scan Doctor and the HP online troubleshooting wizards may not be available in all languages.

## Fix Wi-Fi Direct connection

<a href="#">Use an HP online troubleshooting wizard</a>	Troubleshoot your Wi-Fi Direct problem or learn how to configure Wi-Fi Direct.
---	--

 **NOTE:** The HP online troubleshooting wizards may not be available in all languages.

## Read general instructions in the Help for Wi-Fi Direct troubleshooting

1. Check the printer to confirm that Wi-Fi Direct is turned on:
  - ▲ From the printer control panel, touch  (Wi-Fi Direct) to open the **Wi-Fi Direct Details** menu. If the menu shows Wi-Fi Direct is off, touch Settings, and then touch **Wi-Fi Direct** to switch it on.
2. From your wireless computer or mobile device, turn on the Wi-Fi connection, and then search for and connect to the Wi-Fi Direct name of your printer.
3. Enter the Wi-Fi Direct password when prompted.
4. If you are using a mobile device, make sure you have installed a compatible printing app. For more information about mobile printing, visit [www.hp.com/global/us/en/eprint/mobile\\_printing\\_apps.html](http://www.hp.com/global/us/en/eprint/mobile_printing_apps.html).

## Fix USB to wireless connection change

<a href="#">Use an HP online troubleshooting wizard</a>	Convert a USB connection to wireless or Wi-Fi Direct.
---	---

# Printer hardware issues

## Close cartridge access door

- ▲ Cartridge door must be closed to begin printing.



## The printer shuts down unexpectedly

- Check the power and power connections.
- Make sure the printer's power cord is connected firmly to a functioning power outlet.

## Resolve printer failure

- Turn the printer off, then on. If that does not resolve the problem, contact HP.

## Maintain the document feeder

If the document feeder picks up multiple pages or if it does not pick up plain paper, you can clean the rollers and separator pad.

To clean the rollers or separator pad

**⚠ WARNING!** Before cleaning the printer, turn the printer off by pressing the **Power** button (🔌) and unplug the power cord from the electrical socket.

1. Remove all originals from the document feeder tray.
2. Lift the document feeder cover.



This provides easy access to the rollers (1) and separator pad (2).

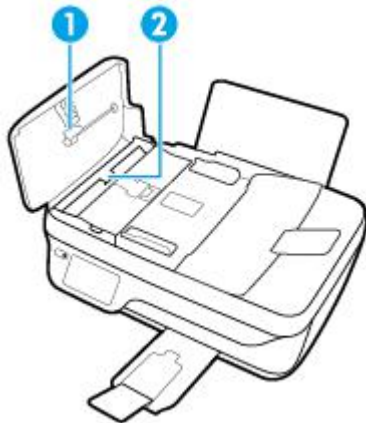

3. Lightly dampen a clean lint-free cloth with distilled water, then squeeze any excess liquid from the cloth.
4. Use the damp cloth to wipe any residue off the rollers or separator pad.

**📝 NOTE:** If the residue does not come off using distilled water, try using isopropyl (rubbing) alcohol.

5. Close the cover of the document feeder.

## HP support

For the latest product updates and support information, visit the [HP OfficeJet 3830 series support website at www.hp.com/support](http://www.hp.com/support). HP online support provides a variety of options for help with your printer:



**Drivers & downloads:** Download software drivers and updates, as well as product manuals and documentation that came in the box with your printer.



**HP support forums:** Visit HP Support Forums for answers to common questions and issues. You can view questions posted by other HP customers, or sign in and post your own questions and comments.



**Troubleshooting:** Use HP online tools to detect your printer and find recommended solutions.

---

## Contact HP

If you need help from an HP technical support representative to solve a problem, visit the [Contact Support website](#). The following contact options are available at no cost for in-warranty customers (HP agent-assisted support for out-of-warranty customers may require a fee):



Chat with an HP support agent online.



Call an HP support agent.

---

When contacting HP support, be prepared to provide the following information:

- Product name (Located on the printer, such as HP OfficeJet 3830)
- Product number (located inside the front door)



- Serial number (located on the back or bottom of the printer)



## Register printer

By taking just a few quick minutes to register, you can enjoy quicker service, more efficient support, and product support alerts. If you did not register your printer while installing the software, you can register now at <http://www.register.hp.com>.

## Additional warranty options

Extended service plans are available for the HP OfficeJet 3830 series at additional costs. Go to [www.hp.com/support](http://www.hp.com/support), select your country/region and language, then explore the extended warranty options available for your printer.



---

# A Technical information

The technical specifications and international regulatory information for the HP OfficeJet 3830 series are provided in this section.

For additional specifications, see the printed documentation that came with the HP OfficeJet 3830 series.

This section contains the following topics:

- [Hewlett-Packard Company notices](#)
- [Specifications](#)
- [Environmental product stewardship program](#)
- [Regulatory notices](#)

## Hewlett-Packard Company notices

The information contained herein is subject to change without notice.

All rights reserved. Reproduction, adaptation, or translation of this material is prohibited without prior written permission of Hewlett-Packard, except as allowed under the copyright laws. The only warranties for HP products and services are set forth in the express warranty statements accompanying such products and services. Nothing herein should be construed as constituting an additional warranty. HP shall not be liable for technical or editorial errors or omissions contained herein.

© Copyright 2018 HP Development Company, L.P.

Microsoft®, Windows®, Windows® XP, Windows Vista®, Windows® 7, Windows® 8, and Windows® 8.1 are U.S. registered trademarks of Microsoft Corporation.

# Specifications

Technical specifications for the HP OfficeJet 3830 series are provided in this section. For more product specifications, see the Product Data Sheet at [www.hp.com/support](http://www.hp.com/support).

## System requirements

- For information about software and system requirements or future operating system releases and support, visit the HP online support website at [www.hp.com/support](http://www.hp.com/support).

## Environmental specifications

- Recommended operating temperature range: 15°C to 30°C (59°F to 86°F)
- Allowable operating temperature range: 5°C to 40°C (41°F to 104°F)
- Humidity: 15% to 80% RH non-condensing; 28°C maximum dewpoint
- Nonoperating (Storage) temperature range: -40°C to 60°C (-40°F to 140°F)
- In the presence of high electromagnetic fields, it is possible the output from the HP OfficeJet 3830 series may be slightly distorted
- HP recommends using a USB cable less than or equal to 3 m (10 feet) in length to minimize injected noise due to potential high electromagnetic fields

## Input tray capacity

- Plain paper sheets (80 g/m<sup>2</sup> [20lb]): Up to 60
- Envelopes: Up to 5
- Index cards: Up to 20
- Photo paper sheets: Up to 20

## Output tray capacity

- Plain paper sheets (80 g/m<sup>2</sup> [20lb]): Up to 25
- Envelopes: Up to 5
- Index cards: Up to 10
- Photo paper sheets: Up to 10

## Document feeder tray capacity

- Plain paper sheets (80 g/m<sup>2</sup> [20lb]): Up to 35

## Paper size

- For a complete list of supported media sizes, see the printer software.

## Paper weights

- Plain Paper: 64 to 90 g/m<sup>2</sup> (16 to 24 lb)
- Envelopes: 75 to 90 g/m<sup>2</sup> (20 to 24 lb)

- Cards: Up to 200 g/m<sup>2</sup> (110-lb index maximum)
- Photo Paper: Up to 280 g/m<sup>2</sup> (75 lb)

### Print specifications

- Print speeds vary according to the complexity of the document
- Method: drop-on-demand thermal inkjet
- Language: PCL3 GUI

### Copy specifications

- Digital image processing
- Copy speeds vary according to the complexity of the document and model

### Scan specifications

- Resolution: up to 1200 x 1200 ppi optical  
For more information about ppi resolution, see the scanner software.
- Color: 24-bit color, 8-bit grayscale (256 levels of gray)
- Maximum scan size from glass: 21.6 x 29.7 cm (8.5 x 11.7 inches)

### Fax specifications

- Send/Receive black and white faxes or color faxes.
- Up to 99 speed dials.
- Up to 99-page memory (based on ITU-T Test Image #1 at standard resolution). More complicated pages or higher resolution faxes take longer and use more memory.
- Manual fax send and receive.
- Automatic busy redial up to five times (varies by model).
- Automatic no-answer redial one time or two times (varies by model).
- Confirmation and activity reports.
- CCITT/ITU Group 3 fax with Error Correction Mode.
- 33.6 Kbps transmission.
- 4 seconds per page speed at 33.6 Kbps (based on ITU-T Test Image #1 at standard resolution). More complicated pages or higher resolution faxes take longer and use more memory.
- Ring detect with automatic fax/answering machine switching.

	Fine (dpi)	Standard (dpi)
Black	208 x 196	208 x 98
Color	208 x 200	208 x 200

### **Cartridge yield**

- Visit [www.hp.com/go/learnaboutsupplies](http://www.hp.com/go/learnaboutsupplies) for more information on estimated cartridge yields.

### **Acoustic information**

- If you have Internet access, you can access acoustic information from the [HP website](#).

## Environmental product stewardship program

Hewlett-Packard is committed to providing quality products in an environmentally sound manner. Design for recycling has been incorporated into this product. The number of materials has been kept to a minimum while ensuring proper functionality and reliability. Dissimilar materials have been designed to separate easily. Fasteners and other connections are easy to locate, access, and remove using common tools. High priority parts have been designed to access quickly for efficient disassembly and repair.

For more information, visit HP's Commitment to the Environment Web site at:

[www.hp.com/hpinfo/globalcitizenship/environment](http://www.hp.com/hpinfo/globalcitizenship/environment)

- [Eco-Tips](#)
- [European Union Commission Regulation 1275/2008](#)
- [Paper use](#)
- [Plastics](#)
- [Material safety data sheets](#)
- [Recycling program](#)
- [HP inkjet supplies recycling program](#)
- [Power consumption](#)
- [Disposal of waste equipment by users](#)
- [Chemical substances](#)
- [Battery disposal in Taiwan](#)
- [Battery notice for Brazil](#)
- [California Perchlorate Material Notice](#)
- [EU Battery Directive](#)
- [Declaration of the Presence Condition of the Restricted Substances Marking \(Taiwan\)](#)
- [The Table of Hazardous Substances/Elements and their Content \(China\)](#)
- [Restriction of hazardous substance \(Ukraine\)](#)
- [Restriction of hazardous substance \(India\)](#)
- [EPEAT](#)
- [China SEPA Eco Label User Information](#)
- [China Energy Label for Printer, Fax and Copier](#)

### Eco-Tips

HP is committed to helping customers reduce their environmental footprint. Please visit the HP Environmental Programs and Initiatives website for more information on HP's environmental initiatives.

[www.hp.com/hpinfo/globalcitizenship/environment/](http://www.hp.com/hpinfo/globalcitizenship/environment/)



## European Union Commission Regulation 1275/2008

For product power data, including the power consumption of the product in networked standby if all wired network ports are connected and all wireless network ports are activated, please refer to section P14 'Additional Information' of the product IT ECO Declaration at [www.hp.com/hpinfo/globalcitizenship/environment/productdata/itecodesktop-pc.html](http://www.hp.com/hpinfo/globalcitizenship/environment/productdata/itecodesktop-pc.html).

## Paper use

This product is suited for the use of recycled paper according to DIN 19309 and EN 12281:2002.

## Plastics

Plastic parts over 25 grams are marked according to international standards that enhance the ability to identify plastics for recycling purposes at the end of product life.

## Material safety data sheets

Material safety data sheets (MSDS) can be obtained from the HP website at:

[www.hp.com/go/msds](http://www.hp.com/go/msds)

## Recycling program

HP offers an increasing number of product return and recycling programs in many countries/regions, and partners with some of the largest electronic recycling centers throughout the world. HP conserves resources by reselling some of its most popular products. For more information regarding recycling of HP products, please visit:

[www.hp.com/hpinfo/globalcitizenship/environment/recycle/](http://www.hp.com/hpinfo/globalcitizenship/environment/recycle/)

## HP inkjet supplies recycling program

HP is committed to protecting the environment. The HP Inkjet Supplies Recycling Program is available in many countries/regions, and lets you recycle used print cartridges and ink cartridges free of charge. For more information, go to the following website:

[www.hp.com/hpinfo/globalcitizenship/environment/recycle/](http://www.hp.com/hpinfo/globalcitizenship/environment/recycle/)

## Power consumption

Hewlett-Packard printing and imaging equipment marked with the ENERGY STAR® logo is certified by the U.S. Environmental Protection Agency. The following mark will appear on ENERGY STAR certified imaging products:



Additional ENERGY STAR certified imaging product model information is listed at: [www.hp.com/go/energystar](http://www.hp.com/go/energystar)

## Disposal of waste equipment by users



This symbol means do not dispose of your product with your other household waste. Instead, you should protect human health and the environment by handing over your waste equipment to a designated collection point for the recycling of waste electrical and electronic equipment. For more information, please contact your household waste disposal service, or go to <http://www.hp.com/recycle>.

## Chemical substances

HP is committed to providing our customers with information about the chemical substances in our products as needed to comply with legal requirements such as REACH (*Regulation EC No 1907/2006 of the European Parliament and the Council*). A chemical information report for this product can be found at: [www.hp.com/go/reach](http://www.hp.com/go/reach).

## Battery disposal in Taiwan



廢電池請回收

## Battery notice for Brazil

A bateria deste equipamento não foi projetada para ser removida pelo cliente.

## California Perchlorate Material Notice

### California Perchlorate Material Notice

Perchlorate material - special handling may apply. See:  
<http://www.dtsc.ca.gov/hazardouswaste/perchlorate/>

This product's real-time clock battery or coin cell battery may contain perchlorate and may require special handling when recycled or disposed of in California.

# EU Battery Directive



<b>English</b>	<b>European Union Battery Directive</b> This product contains a battery that is used to maintain data integrity of real time clock or product settings and is designed to last the life of the product. Any attempt to service or replace this battery should be performed by a qualified service technician.
<b>French</b>	<b>Directive sur les batteries de l'Union Européenne</b> Ce produit contient une batterie qui permet de maintenir l'intégrité des données pour les paramètres du produit ou l'horloge en temps réel et qui a été conçue pour durer aussi longtemps que le produit. Toute tentative de réparation ou de remplacement de cette batterie doit être effectuée par un technicien qualifié.
<b>Dutch</b>	<b>Batterij-Richtlijn der Europese Unie</b> Dit product bevat een batterij die wordt gebruikt voor een juiste tijdsaanduiding van de klok en het behoud van de productinstellingen. Bovendien is deze ontworpen om gedurende de levensduur van het product mee te gaan. Het onderhoud of de vervanging van deze batterij moet door een gekwalificeerde onderhoudstechnicus worden uitgevoerd.
<b>Italiano</b>	<b>Direttiva dell'Unione Europea relativa alla raccolta, al trattamento e allo smaltimento di batterie e accumulatori</b> Questo prodotto contiene una batteria utilizzata per preservare l'integrità dei dati dell'orologio in tempo reale o delle impostazioni del prodotto e la sua durata si intende pari a quella del prodotto. Eventuali interventi di riparazione o sostituzione della batteria devono essere eseguiti da un tecnico dell'assistenza qualificato.
<b>Español</b>	<b>Directiva sobre baterías de la Unión Europea</b> Este producto contiene una batería que se utiliza para conservar la integridad de los datos del reloj de tiempo real o la configuración del producto y está diseñada para durar toda la vida útil del producto. El mantenimiento o la sustitución de dicha batería deberá realizarla un técnico de mantenimiento cualificado.
<b>Česky</b>	<b>Směrnice Evropské unie pro nakládání s bateriemi</b> Tento výrobek obsahuje baterii, která slouží k uchování správných dat hodin reálného času nebo nastavení výrobku. Baterie je navržena tak, aby vydržela celou životnost výrobku. Jakýkoliv pokus o opravu nebo výměnu baterie by měl provést kvalifikovaný servisní technik.
<b>Dansk</b>	<b>EU's batteridirektiv</b> Produktet indeholder et batteri, som bruges til at vedligeholde dataintegriteten for realtidsur- eller produktindstillinger og er beregnet til at holde i hele produktets levetid. Service på batteriet eller udskiftning bør foretages af en uddannet servicetekniker.
<b>Nederlands</b>	<b>Richtlijn batterijen voor de Europese Unie</b> Dit product bevat een batterij die wordt gebruikt voor een juiste tijdsaanduiding van de klok en het behoud van de productinstellingen. Bovendien is deze ontworpen om gedurende de levensduur van het product mee te gaan. Het onderhoud of de vervanging van deze batterij moet door een gekwalificeerde onderhoudstechnicus worden uitgevoerd.
<b>Enfi</b>	<b>Euroopa Liidu aku direktiiv</b> Toode sisaldab akut, mida kasutatakse reaalaja kella andmeühitsuse või toote sätete säilitamiseks. Aku on valmistatud kestma terve toote kasutusaja. Akut tohib hooldada või vahetada ainult kvalifitseeritud hooldustehnik.
<b>Sveoni</b>	<b>Euroopan unionin paristodirektiivi</b> Tämä laite sisältää pariston, jota käytetään reaalitajaisen kellon tietojen ja laitteen asetusten säilyttämiseen. Pariston on suunniteltu kestävä laitteen koko käyttöajan ajan. Pariston mahdollinen korjaus tai vaihto on jätettävä pätevään huoltohenkilön tehtäväksi.
<b>Ελληνικά</b>	<b>Οδηγία της Ευρωπαϊκής Ένωσης για τις ηλεκτρικές σήλες</b> Αυτό το προϊόν περιλαμβάνει μια μπαταρία, η οποία χρησιμοποιείται για τη διατήρηση της ακριβείας των δεδομένων ρολογιού πραγματικού χρόνου ή των ρυθμιστικών προϊόντων και έχει σχεδιαστεί έτσι ώστε να διαρκεί όσο και το προϊόν. Τυχόν απόπειρες επιδιόρθωσης ή αντικατάστασης αυτής της μπαταρίας θα πρέπει να πραγματοποιούνται από κατάλληλα εκπαιδευμένο τεχνικό.
<b>Magyar</b>	<b>Az Európai unió telepek és akkumulátorok direktívája</b> A termék tartalmaz egy elemet, melynek feladata az, hogy biztosítsa a valós idejű óra vagy a termék beállításainak adatintegritását. Az elem úgy van tervezve, hogy végig járjon a termék használatá során. Az elem bármilyen javítását vagy cseréjét csak képzett szakember végezheti el.
<b>Latviski</b>	<b>Eiropas Savienības Bateriju direktīva</b> Produktam ir baterija, ko izmanto reālā laikā pulksteņa vai produkta iestatījumu datu integritātes saglabāšanai, un tā ir paredzēta visam produkta dzīves ciklam. Jebkura apkope vai baterijas nomaiņa ir jāveic atbilstoši kvalificētam darbiniekam.
<b>Liuksemburģiski</b>	<b>Europos Sąjungos baterijų ir akumuliatorių direktyva</b> Šiame gaminyje yra baterija, kuri naudojama, kad būtų galima prižiūrėti realaus laiko laikrodžio veikimą arba gaminio nuostatas; ji skirta veikti visą gaminio eksploatavimo laiką. Bet kokius šios baterijos aptarnavimo arba keitimo darbus turi atlikti kvalifikuotas aptarnavimo technikas.
<b>Polski</b>	<b>Dyrektywa Unii Europejskiej w sprawie baterii i akumulatorów</b> Produkt zawiera baterię wykorzystywaną do zachowania integralności danych zegara czasu rzeczywistego lub ustawień produktu, która podtrzymuje działanie produktu. Przegląd lub wymiana baterii powinny być wykonywane wyłącznie przez uprawnionego technika serwisu.
<b>Português</b>	<b>Directiva sobre baterias da União Europeia</b> Este produto contém uma bateria que é usada para manter a integridade dos dados do relógio em tempo real ou das configurações do produto e é projetada para ter a mesma duração que este. Qualquer tentativa de consertar ou substituir essa bateria deve ser realizada por um técnico qualificado.
<b>Slovenščina</b>	<b>Smernica Evropskeje unije pre zaobchádzanie s batériami</b> Tento výrobok obsahuje batériu, ktorá slúži na uchovanie správnych údajov hodín reálneho času alebo nastavení výrobku. Batéria je skonštruovaná tak, aby vydržala celú životnosť výrobku. Akýkoľvek pokus o opravu alebo výmenu batérie by mal vykonať kvalifikovaný servisný technik.
<b>Slovenščina</b>	<b>Direktiva Evropske unije o baterijah in akumulatorjih</b> V tem izdelku je baterija, ki zagotavlja natančnost podatkov ure v realnem času ali nastavitev izdelka v celotni življenjski dobi izdelka. Kakršno koli popravilo ali zamenjavo te baterije lahko izvede le pooblaščen tehnik.
<b>Svenska</b>	<b>EU:s batteridirektiv</b> Produkten innehåller ett batteri som används för att upprätthålla data i realtidsklockan och produktinställningarna. Batteriet ska räkna produktens hela livslängd. Endast kvalificerade servicetekniker får utföra service på batteriet och byta ut det.
<b>Български</b>	<b>Директива за батерии на Европейския съюз</b> Този продукт съдържа батерия, която се използва за поддържане на целостта на данните на часовника в реално време или настройките за продукта, създадена на издръжливост през целия живот на продукта. Сервизът или заманата на батерията трябва да се извършва от квалифициран техник.
<b>Banlnd</b>	<b>Directiva Uniunii Europene referitoare la baterii</b> Acest produs conține o baterie care este utilizată pentru a menține integritatea datelor ceasului de timp real sau setările produsului și care este proiectată să funcționeze pe întreaga durată de viață a produsului. Orice lucrare de service sau de înlocuire a acestei baterii trebuie efectuată de un tehnician de service calificat.

## Declaration of the Presence Condition of the Restricted Substances Marking (Taiwan)

### 限用物質含有情況標示聲明書

#### Declaration of the Presence Condition of the Restricted Substances Marking

單元 Unit	限用物質及其化學符號					
	Restricted substances and its chemical symbols					
	鉛 Lead (Pb)	汞 Mercury (Hg)	鎘 Cadmium (Cd)	六價鉻 Hexavalent chromium (Cr <sup>+6</sup> )	多溴聯苯 Polybrominated biphenyls (PBB)	多溴二苯醚 Polybrominate d diphenyl ethers (PBDE)
外殼和紙匣 (External Casings and Trays)	0	0	0	0	0	0
電線 (Cables)	0	0	0	0	0	0
印刷電路板 (Printed Circuit Boards)	—	0	0	0	0	0
列印引擎(Print Engine)	—	0	0	0	0	0
列印機組件 (Print Assembly)	—	0	0	0	0	0
噴墨印表機墨水匣 (Print Supplies)	0	0	0	0	0	0
列印機配件 (Print Accessory)	—	0	0	0	0	0

備考 1. “超出 0.1 wt %” 及 “超出 0.01 wt %” 係指限用物質之百分比含量超出百分比含量基準值。

Note 1: “Exceeding 0.1 wt %” and “exceeding 0.01 wt %” indicate that the percentage content of the restricted substance exceeds the reference percentage value of presence condition.

備考 2. “0” 係指該項限用物質之百分比含量未超出百分比含量基準值。

Note 2: “0” indicates that the percentage content of the restricted substance does not exceed the percentage of reference value of presence.

備考 3. “—” 係指該項限用物質為排除項目。

Note 3: The “—” indicates that the restricted substance corresponds to the exemption.

若要存取產品的最新使用指南或手冊，請前往 [www.support.hp.com](http://www.support.hp.com)。選取搜尋您的產品，然後依照畫面上的指示繼續執行。

To access the latest user guides or manuals for your product, go to [www.support.hp.com](http://www.support.hp.com). Select **Find your product**, and then follow the onscreen instructions.

## The Table of Hazardous Substances/Elements and their Content (China)

<b>产品中有毒物质或元素的名称及含量</b> 根据中国《电子信息产品污染控制管理办法》						
部件名称	有毒有害物质或元素					
	铅 (Pb)	汞 (Hg)	镉 (Cd)	六价铬 (Cr(VI))	多溴联苯 (PBB)	多溴二苯醚 (PBDE)
外壳和托盘	0	0	0	0	0	0
电线	0	0	0	0	0	0
印刷电路板	X	0	0	0	0	0
打印系统	X	0	0	0	0	0
显示器	X	0	0	0	0	0
喷墨打印机墨盒	0	0	0	0	0	0
驱动光盘	X	0	0	0	0	0
扫描仪	X	X	0	0	0	0
网络配件	X	0	0	0	0	0
电池板	X	0	0	0	0	0
自动双面打印系统	0	0	0	0	0	0
外部电源	X	0	0	0	0	0

本表格依据SJ/T 11364 的规定编制。  
 0: 表示该有害物质在该部件所有均质材料中的含量均在GB/T 26572 规定的限量要求以下。  
 X: 表示该有害物质至少在该部件的某一均质材料中的含量超出GB/T 26572 规定的限量要求。

此表中所有名称中含“X”的部件均符合欧盟 RoHS 立法。

注: 环保使用期限的参考标识取决于产品正常工作的温度和湿度等条件。

## Restriction of hazardous substance (Ukraine)

### Технічний регламент щодо обмеження використання небезпечних речовин (Україна)

Обладнання відповідає вимогам Технічного регламенту щодо обмеження використання деяких небезпечних речовин в електричному та електронному обладнанні, затвердженого постановою Кабінету Міністрів України від 3 грудня 2008 № 1057

## Restriction of hazardous substance (India)

### Restriction of hazardous substances (India)

This product complies with the "India E-waste (Management and Handling) Rule 2011" and prohibits use of lead, mercury, hexavalent chromium, polybrominated biphenyls or polybrominated diphenyl ethers in concentrations exceeding 0.1 weight % and 0.01 weight % for cadmium, except for the exemptions set in Schedule 2 of the Rule.

## EPEAT

### EPEAT

Most HP products are designed to meet EPEAT. EPEAT is a comprehensive environmental rating that helps identify greener electronics equipment. For more information on EPEAT go to [www.epeat.net](http://www.epeat.net). For information on HP's EPEAT registered products go to [www.hp.com/hpinfo/globalcitizenship/environment/pdf/epeat\\_printers.pdf](http://www.hp.com/hpinfo/globalcitizenship/environment/pdf/epeat_printers.pdf).

## China SEPA Eco Label User Information

### 中国环境标识认证产品用户说明

噪声大于63.0Db(A)的办公设备不宜放置于办公室内，请在独立的隔离区域使用。

如需长时间使用本产品或打印大量文件，请确保在通风良好的房间内使用。

如您需要确认本产品处于零能耗状态，请按下电源关闭按钮，并将插头从电源插座断开。

您可以使用再生纸，以减少资源耗费。

## 复印机、打印机和传真机能源效率标识 实施规则

依据“复印机、打印机和传真机能源效率标识实施规则”，该打印机具有中国能效标识。标识上显示的能效等级和操作模式值根据“复印机、打印机和传真机能效限定值及能效等级”标准（“GB 21521”）来确定和计算。

### 1. 能效等级

产品能效等级分为3级，其中1级能效最高。能效限定值根据产品类型和打印速度由标准确定。能效等级则根据基本功耗水平以及网络接口和内存等附加组件和功能的功率因子之和来计算。

### 2. 能效信息

#### 喷墨打印机

- 操作模式功率

睡眠状态的能耗按照 GB 21521 标准来衡量和计算。该数据以瓦特 (W) 表示。

- 待机功率

待机状态是产品连接到电网电源上功率最低的状态。该状态可以延续无限长时间，且使用者无法改变此状态下产品的功率。对于“成像设备”产品，“待机”状态通常相当于“关闭”状态，但也可能相当于“准备”状态或“睡眠”状态。该数据以瓦特 (W) 表示。

- 睡眠状态预设延迟时间

出厂前由制造商设置的时间决定了该产品在完成主功能后进入低耗模式（例如睡眠、自动关机）的时间。该数据以分钟表示。

- 附加功能功率因子之和

网络接口和内存等附加功能的功率因子之和。该数据以瓦特 (W) 表示。

标识上显示的能耗数据是根据典型配置测量得出的数据，此类配置包含登记备案的打印机依据复印机、打印机和传真机能源效率标识实施规则所选的所有配置。因此，该特定产品型号的实际能耗可能与标识上显示的数据有所不同。

要了解规范的更多详情，请参考最新版的 GB 21521 标准。

## Regulatory notices

The HP OfficeJet 3830 series meets product requirements from regulatory agencies in your country/region.

This section contains the following topics:

- [Regulatory model identification number](#)
- [FCC statement](#)
- [Notice to users in Korea](#)
- [VCCI \(Class B\) compliance statement for users in Japan](#)
- [Notice to users in Japan about the power cord](#)
- [Noise emission statement for Germany](#)
- [Visual display workplaces statement for Germany](#)
- [European Union Regulatory Notice](#)
- [Declaration of conformity](#)
- [Regulatory wireless statements](#)
- [Notice to users of the U.S. telephone network: FCC requirements](#)
- [Notice to users of the Canadian telephone network](#)
- [Notice to users of the German telephone network](#)
- [Australia wired fax statement](#)

### Regulatory model identification number

For regulatory identification purposes, your product is assigned a Regulatory Model Number. The Regulatory Model Number for your product is SNPRH-1502. This regulatory number should not be confused with the marketing name (HP OfficeJet 3830 All-in-One Printer, etc.) or product numbers (F5R95A, F5R95B, etc.).



## FCC statement

### FCC statement

The United States Federal Communications Commission (in 47 CFR 15.105) has specified that the following notice be brought to the attention of users of this product.

This equipment has been tested and found to comply with the limits for a Class B digital device, pursuant to Part 15 of the FCC Rules. These limits are designed to provide reasonable protection against harmful interference in a residential installation. This equipment generates, uses and can radiate radio frequency energy and, if not installed and used in accordance with the instructions, may cause harmful interference to radio communications. However, there is no guarantee that interference will not occur in a particular installation. If this equipment does cause harmful interference to radio or television reception, which can be determined by turning the equipment off and on, the user is encouraged to try to correct the interference by one or more of the following measures:

- Reorient or relocate the receiving antenna.
- Increase the separation between the equipment and the receiver.
- Connect the equipment into an outlet on a circuit different from that to which the receiver is connected.
- Consult the dealer or an experienced radio/TV technician for help.

For further information, contact:

Manager of Corporate Product Regulations  
Hewlett-Packard Company  
3000 Hanover Street  
Palo Alto, Ca 94304  
(650) 857-1501

Modifications (part 15.21)

The FCC requires the user to be notified that any changes or modifications made to this device that are not expressly approved by HP may void the user's authority to operate the equipment.

This device complies with Part 15 of the FCC Rules. Operation is subject to the following two conditions: (1) this device may not cause harmful interference, and (2) this device must accept any interference received, including interference that may cause undesired operation.

## Notice to users in Korea

B 급 기기 (가정용 방송통신기기)	이 기기는 가정용(B급)으로 전자파적합등록을 한 기기로서 주로 가정에서 사용하는 것을 목적으로 하며, 모든 지역에서 사용할 수 있습니다.
------------------------	--

## VCCI (Class B) compliance statement for users in Japan

この装置は、クラスB情報技術装置です。この装置は、家庭環境で使用することを目的としていますが、この装置がラジオやテレビジョン受信機に近接して使用されると、受信障害を引き起こすことがあります。取扱説明書に従って正しい取り扱いをして下さい。

VCCI-B

## Notice to users in Japan about the power cord

製品には、同梱された電源コードをお使い下さい。  
同梱された電源コードは、他の製品では使用出来ません。

## Noise emission statement for Germany

### Geräuschemission

LpA < 70 dB am Arbeitsplatz im Normalbetrieb nach DIN 45635 T. 19

## Visual display workplaces statement for Germany

### GS-Erklärung (Deutschland)

Das Gerät ist nicht für die Benutzung im unmittelbaren Gesichtsfeld am Bildschirmarbeitsplatz vorgesehen. Um störende Reflexionen am Bildschirmarbeitsplatz zu vermeiden, darf dieses Produkt nicht im unmittelbaren Gesichtsfeld platziert werden.

## European Union Regulatory Notice



Products bearing the CE marking comply with one or more of the following EU Directives as may be applicable: Low Voltage Directive 2006/95/EC, EMC Directive 2004/108/EC, Ecodesign Directive 2009/125/EC, R&TTE Directive 1999/5/EC, RoHS Directive 2011/65/EU. Compliance with these directives is assessed using applicable European Harmonised Standards. The full Declaration of Conformity can be found at the following website: [www.hp.com/go/certificates](http://www.hp.com/go/certificates) (Search with the product model name or its Regulatory Model Number (RMN), which may be found on the regulatory label.)

The point of contact for regulatory matters is:

Hewlett-Packard GmbH, Dept./MS: HQ-TRE, Herrenberger Strasse 140, 71034 Boeblingen, GERMANY

## Products with wireless functionality

### EMF

- This product meets international guidelines (ICNIRP) for exposure to radio frequency radiation.

If it incorporates a radio transmitting and receiving device that in normal use, a separation distance of 20 cm ensures that radio frequency exposure levels comply with EU requirements.

### Wireless functionality in Europe

- This product is designed for use without restrictions in all EU countries plus Iceland, Liechtenstein, Norway and Switzerland.

## European telephone network declaration (Modem/Fax)

HP products with FAX capability comply with the requirements of the R&TTE Directive 1999/5/EC (Annex II) and carry the CE marking accordingly. However, due to differences between the individual PSTNs provided in different countries/regions, the approval does not, of itself, give an unconditional assurance of successful operation on every PSTN network termination point. In the event of problems, you should contact your equipment supplier in the first instance.

## Declaration of conformity



### DECLARATION OF CONFORMITY

according to ISO/IEC 17050-1 and EN 17050-1

**DoC #: SNPRH-1502-R2**

**Supplier's Name:** Hewlett-Packard Company  
**Supplier's Address:** 20, Jia Feng Road Waigaoqiao Free Trade Zone Pudong, Shanghai, PRC 200131  
**declares, that the product**  
**Product Name and Model:** HP OfficeJet 3830 All-in-One Printer series  
HP DeskJet Ink Advantage 3830 All-in-One Printer series  
**Regulatory Model Number:** <sup>1)</sup> SNPRH-1502  
**Radio Module:** SDGOB-1392  
**Product Options:** All  
**Confirms to the following Product Specifications and Regulations:**

#### EMC:

CISPR 22:2008 Class B  
EN 55022:2010 Class B  
EN 55024:2010  
EN 61000-3-2:2006 +A1:2009 +A2:2009  
EN 61000-3-3:2008  
FCC CFR 47 Part 15 Class B  
ICES-003, Issue 5 Class B

#### Safety:

EN 60950-1:2006 +A11:2009 +A1:2010 +A12:2011  
IEC 60950-1:2005 +A1:2009  
EN 62479:2010

#### Telecom:

EN 300 328 v1.8.1  
EN 301 489-1 v1.9.2  
EN 301 489-17 v2.2.1  
IEC 62311: 2007 / EN 62311:2008  
ETSI ES 203 021:2006  
FCC Rules and Regulation 47 CFR Part 68, TIA-968-B, TIA-1096-A  
CS-03, Part 1, Issue 9, Amendment 4, December 2010

#### Energy Use:

Regulation (EC) No. 1275/2008  
ENERGY STAR® Qualified Imaging Equipment Operational Mode (OM) Test Procedure  
EN 50564:2011  
IEC 62301:2005

#### RoHS:

EN 50581:2012

The product herewith complies with the requirements of the Low Voltage Directive 2006/95/EC, the EMC Directive 2004/108/EC, the R&TTE Directive 1999/5/EC, the Ecodesign Directive 2009/125/EC, the RoHS Directive 2011/65/EU and carries the **CE** marking accordingly.

This device complies with part 15 of the FCC Rules. Operation is subject to the following two conditions:

(1) This device may not cause harmful interference, and (2) this device must accept any interference received, including interference that may cause undesired operation.

#### Additional Information:

1) This product is assigned a Regulatory Model Number which stays with the regulatory aspects of the design. The Regulatory Model Number is the main product identifier in the regulatory documentation and test reports, this number should not be confused with the marketing name or the product numbers.

2014 24<sup>th</sup> June

Shen HongBo

ICS Product Hardware Quality Engineering, Manager

#### Local contact for regulatory topics only:

EU: Hewlett-Packard GmbH, HQ-TRE, Herrenberger Strasse 140, 71034 Boeblingen, Germany  
U.S.: Hewlett-Packard, 3000 Hanover St., Palo Alto, CA 94304, U.S.A. 650-857-1501

[www.hp.eu/certificates](http://www.hp.eu/certificates)

## Regulatory wireless statements

This section contains the following regulatory information pertaining to wireless products:

- [Exposure to radio frequency radiation](#)
- [Notice to users in Brazil](#)
- [Notice to users in Canada](#)
- [Notice to users in Mexico](#)
- [Notice to users in Taiwan](#)
- [Notice to users in Japan](#)
- [Notice to users in Korea](#)

### Exposure to radio frequency radiation

#### Exposure to radio frequency radiation



**Caution** The radiated output power of this device is far below the FCC radio frequency exposure limits. Nevertheless, the device shall be used in such a manner that the potential for human contact during normal operation is minimized. This product and any attached external antenna, if supported, shall be placed in such a manner to minimize the potential for human contact during normal operation. In order to avoid the possibility of exceeding the FCC radio frequency exposure limits, human proximity to the antenna shall not be less than 20 cm (8 inches) during normal operation.

### Notice to users in Brazil

#### Aviso aos usuários no Brasil

Este equipamento opera em caráter secundário, isto é, não tem direito à proteção contra interferência prejudicial, mesmo de estações do mesmo tipo, e não pode causar interferência a sistemas operando em caráter primário.

## Notice to users in Canada

### **Notice to users in Canada/Note à l'attention des utilisateurs canadiens**

Under Industry Canada regulations, this radio transmitter may only operate using an antenna of a type and maximum (or lesser) gain approved for the transmitter by Industry Canada. To reduce potential radio interference to other users, the antenna type and its gain should be so chosen that the equivalent isotropically radiated power (e.i.r.p.) is not more than that necessary for successful communication.

This device complies with Industry Canada licence-exempt RSS standard(s). Operation is subject to the following two conditions: (1) this device may not cause interference, and (2) this device must accept any interference, including interference that may cause undesired operation of the device.

**WARNING!** Exposure to Radio Frequency Radiation The radiated output power of this device is below the Industry Canada radio frequency exposure limits. Nevertheless, the device should be used in such a manner that the potential for human contact is minimized during normal operation.

To avoid the possibility of exceeding the Industry Canada radio frequency exposure limits, human proximity to the antennas should not be less than 20 cm (8 inches).

Conformément au Règlement d'Industrie Canada, cet émetteur radioélectrique ne peut fonctionner qu'avec une antenne d'un type et d'un gain maximum (ou moindre) approuvé par Industrie Canada. Afin de réduire le brouillage radioélectrique potentiel pour d'autres utilisateurs, le type d'antenne et son gain doivent être choisis de manière à ce que la puissance isotrope rayonnée équivalente (p.i.r.e.) ne dépasse pas celle nécessaire à une communication réussie.

Cet appareil est conforme aux normes RSS exemptes de licence d'Industrie Canada. Son fonctionnement dépend des deux conditions suivantes : (1) cet appareil ne doit pas provoquer d'interférences nuisibles et (2) doit accepter toutes interférences reçues, y compris des interférences pouvant provoquer un fonctionnement non souhaité de l'appareil.

**AVERTISSEMENT** relatif à l'exposition aux radiofréquences. La puissance de rayonnement de cet appareil se trouve sous les limites d'exposition de radiofréquences d'Industrie Canada. Néanmoins, cet appareil doit être utilisé de telle sorte qu'il soit mis en contact le moins possible avec le corps humain.

Afin d'éviter le dépassement éventuel des limites d'exposition aux radiofréquences d'Industrie Canada, il est recommandé de maintenir une distance de plus de 20 cm entre les antennes et l'utilisateur.

## Notice to users in Mexico

### **Aviso para los usuarios de México**

La operación de este equipo está sujeta a las siguientes dos condiciones: (1) es posible que este equipo o dispositivo no cause interferencia perjudicial y (2) este equipo o dispositivo debe aceptar cualquier interferencia, incluyendo la que pueda causar su operación no deseada.

Para saber el modelo de la tarjeta inalámbrica utilizada, revise la etiqueta regulatoria de la impresora.

## Notice to users in Taiwan

### 低功率電波輻射性電機管理辦法

#### 第十二條

經型式認證合格之低功率射頻電機，非經許可，公司、商號或使用者均不得擅自變更頻率、加大功率或變更設計之特性及功能。

#### 第十四條

低功率射頻電機之使用不得影響飛航安全及干擾合法通信；經發現有干擾現象時，應立即停用，並改善至無干擾時方得繼續使用。

前項合法通信，指依電信法規定作業之無線電通信。低功率射頻電機須忍受合法通信或工業、科學及醫藥用電波輻射性電機設備之干擾。

## Notice to users in Japan

この機器は技術基準適合証明又は工事設計認証を受けた無線設備を搭載しています。

## Notice to users in Korea

해당 무선설비는 전파혼신 가능성이 있으므로 인명안전과 관련된 서비스는 할 수 없음

## Notice to users of the U.S. telephone network: FCC requirements

### Notice to users of the U.S Telephone network: FCC requirements

This equipment complies with Part 68 of the FCC rules and the requirements adopted by the ACTA. On the rear (or bottom) of this equipment is a label that contains, among other information, a product identifier in the format US:AAAEQ##TXXXX. If requested, this number must be provided to the telephone company.

Applicable connector jack Universal Service Order Codes ("USOC") for the Equipment is: RJ-11C.

A plug and jack used to connect this equipment to the premises wiring and telephone network must comply with the applicable FCC Part 68 rules and requirements adopted by the ACTA. A compliant telephone cord and modular plug is provided with this product. It is designed to be connected to a compatible modular jack that is also compliant. See installation instructions for details.

The REN is used to determine the number of devices that may be connected to a telephone line. Excessive RENs on a telephone line may result in the devices not ringing in response to an incoming call. In most but not all areas, the sum of RENs should not exceed five (5.0). To be certain of the number of devices that may be connected to a line, as determined by the total RENs, contact the local telephone company. For products approved after July 23, 2001, the REN for this product is part of the product identifier that has the format US:AAAEQ##TXXXX. The digits represented by ## are the REN without a decimal point (e.g., 00 is a REN of 0.0).

If this equipment causes harm to the telephone network, the telephone company will notify you in advance that temporary discontinuance of service may be required. But if advance notice isn't practical, the telephone company will notify the customer as soon as possible. Also, you will be advised of your right to file a complaint with the FCC if you believe it is necessary.

The telephone company may make changes in its facilities, equipment, operations or procedures that could affect the operation of the equipment. If this happens the telephone company will provide advance notice in order for you to make necessary modifications to maintain uninterrupted service.

If trouble is experienced with this equipment, please contact the manufacturer, or look elsewhere in this manual, for repair or warranty information. If the equipment is causing harm to the telephone network, the telephone company may request that you disconnect the equipment until the problem is resolved.

Connection to party line service is subject to state tariffs. Contact the state public utility commission, public service commission or corporation commission for information.

If your home has specially wired alarm equipment connected to the telephone line, ensure the installation of this equipment does not disable your alarm equipment. If you have questions about what will disable alarm equipment, consult your telephone company or a qualified installer.

WHEN PROGRAMMING EMERGENCY NUMBERS AND/OR MAKING TEST CALLS TO EMERGENCY NUMBERS:

- 1) Remain on the line and briefly explain to the dispatcher the reason for the call.
- 2) Perform such activities in the off-peak hours, such as early morning or late evenings.



**Note** The FCC hearing aid compatibility rules for telephones are not applicable to this equipment.

The Telephone Consumer Protection Act of 1991 makes it unlawful for any person to use a computer or other electronic device, including FAX machines, to send any message unless such message clearly contains in a margin at the top or bottom of each transmitted page or on the first page of the transmission, the date and time it is sent and an identification of the business or other entity, or other individual sending the message and the telephone number of the sending machine or such business, other entity, or individual. (The telephone number provided may not be a 900 number or any other number for which charges exceed local or long-distance transmission charges.)

In order to program this information into your FAX machine, you should complete the steps described in the software.



## Notice to users of the Canadian telephone network

### Note à l'attention des utilisateurs du réseau téléphonique Canadien/notice to users of the Canadian telephone network

Cet appareil est conforme aux spécifications techniques des équipements terminaux d'Industrie Canada. Le numéro d'enregistrement atteste de la conformité de l'appareil. L'abréviation IC qui précède le numéro d'enregistrement indique que l'enregistrement a été effectué dans le cadre d'une Déclaration de conformité stipulant que les spécifications techniques d'Industrie Canada ont été respectées. Néanmoins, cette abréviation ne signifie en aucun cas que l'appareil a été validé par Industrie Canada.

Pour leur propre sécurité, les utilisateurs doivent s'assurer que les prises électriques reliées à la terre de la source d'alimentation, des lignes téléphoniques et du circuit métallique d'alimentation en eau sont, le cas échéant, branchées les unes aux autres. Cette précaution est particulièrement importante dans les zones rurales.



**Remarque** Le numéro REN (Ringer Equivalence Number) attribué à chaque appareil terminal fournit une indication sur le nombre maximal de terminaux qui peuvent être connectés à une interface téléphonique. La terminaison d'une interface peut se composer de n'importe quelle combinaison d'appareils, à condition que le total des numéros REN ne dépasse pas 5.

Basé sur les résultats de tests FCC Partie 68, le numéro REN de ce produit est 0.1.

This equipment meets the applicable Industry Canada Terminal Equipment Technical Specifications. This is confirmed by the registration number. The abbreviation IC before the registration number signifies that registration was performed based on a Declaration of Conformity indicating that Industry Canada technical specifications were met. It does not imply that Industry Canada approved the equipment. Users should ensure for their own protection that the electrical ground connections of the power utility, telephone lines and internal metallic water pipe system, if present, are connected together. This precaution might be particularly important in rural areas.



**Note** The Ringer Equivalence Number (REN) assigned to each terminal device provides an indication of the maximum number of terminals allowed to be connected to a telephone interface. The termination on an interface might consist of any combination of devices subject only to the requirement that the sum of the Ringer Equivalence Numbers of all the devices does not exceed 5.

The REN for this product is 0.1, based on FCC Part 68 test results.

## Notice to users of the German telephone network

### **Hinweis für Benutzer des deutschen Telefonnetzes**

Dieses HP-Fax ist nur für den Anschluss eines analogen Public Switched Telephone Network (PSTN) gedacht. Schließen Sie den TAE N-Telefonstecker, der im Lieferumfang des HP All-in-One enthalten ist, an die Wandsteckdose (TAE 6) Code N an. Dieses HP-Fax kann als einzelnes Gerät und/oder in Verbindung (mit seriellen Anschluss) mit anderen zugelassenen Endgeräten verwendet werden.

## Australia wired fax statement

In Australia, the HP device must be connected to Telecommunication Network through a line cord which meets the requirements of the Technical Standard AS/ACIF S008.

---

## B Additional fax setup

In this section, you learn how to set up the printer so that faxing works successfully with equipment and services you might already have on the same phone line.

---

 **TIP:** You can also use the Fax Setup Wizard (Windows) or HP Utility (OS X) to help you quickly set up some important fax settings such as the answer mode and fax header information. You can access these tools through the HP printer software. After you run these tools, follow the procedures in this section to complete your fax setup.

---

This section contains the following topics:

- [Set up faxing \(parallel phone systems\)](#)
- [Test fax setup](#)

## Set up faxing (parallel phone systems)

Before you begin setting up the printer for faxing, determine which kind of phone system your country/region uses. The instructions for fax setup differ depending on whether you have a serial- or parallel-type phone system.

- If you do not see your country/region listed in the table, you probably have a serial-type phone system. In a serial-type phone system, the connector type on your shared telephone equipment (modems, phones, and answering machines) does not allow a physical connection to the "2-EXT" port on the printer. Instead, all equipment must be connected at the telephone wall jack.



**NOTE:** You might need to connect the phone cord to your country/region adapter.

- If your country/region is listed in the table, you probably have a parallel-type telephone system. In a parallel-type phone system, you are able to connect shared telephone equipment to the phone line by using the "2-EXT" port on the back of the printer.



**NOTE:** If you have a parallel-type phone system, HP recommends you connect a 2-wire phone cord to the telephone wall jack.

**Table B-1 Countries/regions with a parallel-type phone system**

Argentina	Australia	Brazil
Canada	Chile	China
Colombia	Greece	India
Indonesia	Ireland	Japan
Korea	Latin America	Malaysia
Mexico	Philippines	Poland
Portugal	Russia	Saudi Arabia
Singapore	Spain	Taiwan
Thailand	USA	Venezuela
Vietnam		

If you are unsure which kind of telephone system you have (serial or parallel), check with your telephone company.

This section contains the following topics:

- [Select the correct fax setup for your home or office](#)
- [Case A: Separate fax line \(no voice calls received\)](#)
- [Case B: Set up the printer with DSL](#)
- [Case C: Set up the printer with a PBX phone system or an ISDN line](#)
- [Case D: Fax with a distinctive ring service on the same line](#)
- [Case E: Shared voice/fax line](#)
- [Case F: Shared voice/fax line with voice mail](#)

- [Case G: Fax line shared with computer modem \(no voice calls received\)](#)
- [Case H: Shared voice/fax line with computer modem](#)
- [Case I: Shared voice/fax line with answering machine](#)
- [Case J: Shared voice/fax line with computer modem and answering machine](#)
- [Case K: Shared voice/fax line with computer dial-up modem and voice mail](#)

## Select the correct fax setup for your home or office

To fax successfully, you need to know what types of equipment and services (if any) share the same phone line with the printer. This is important because you might need to connect some of your existing office equipment directly to the printer, and you might also need to change some fax settings before you can fax successfully.

1. Determine if your telephone system is serial or parallel.

For more information, see [Set up faxing \(parallel phone systems\) on page 158](#).

2. Select the combination of equipment and services sharing your fax line.

- DSL: A Digital subscriber line (DSL) service through your telephone company. (DSL might be called ADSL in your country/region.)
- PBX: A private branch exchange (PBX) phone system.
- ISDN: An integrated services digital network (ISDN) system.
- Distinctive ring service: A distinctive ring service through your telephone company provides multiple telephone numbers with different ring patterns.
- Voice calls: Voice calls are received at the same phone number you use for fax calls on the printer.
- Computer dial-up modem: A computer dial-up modem is on the same phone line as the printer. If you answer Yes to any of the following questions, you are using a computer dial-up modem:
  - Do you send and receive faxes directly to and from your computer software applications through a dial-up connection?
  - Do you send and receive email messages on your computer through a dial-up connection?
  - Do you access the Internet from your computer through a dial-up connection?
- Answering machine: An answering machine that answers voice calls at the same phone number you use for fax calls on the printer.
- Voice mail service: A voice mail subscription through your telephone company at the same number you use for fax calls on the printer.

3. From the following table, select the combination of equipment and services applicable to your home or office setting. Then look up the recommended fax setup. Step-by-step instructions are included for each case in the sections that follow.



**NOTE:** You might need to connect the phone cord to your country/region adapter.

Other equipment or services sharing your fax line							Recommended fax setup
DSL	PBX	Distinctive ring service	Voice calls	Computer dial-up modem	Answering machine	Voice mail service	
							<a href="#">Case A: Separate fax line (no voice calls received) on page 160</a>
✓							<a href="#">Case B: Set up the printer with DSL on page 161</a>
	✓						<a href="#">Case C: Set up the printer with a PBX phone system or an ISDN line on page 162</a>
		✓					<a href="#">Case D: Fax with a distinctive ring service on the same line on page 163</a>
			✓				<a href="#">Case E: Shared voice/fax line on page 164</a>
			✓			✓	<a href="#">Case F: Shared voice/fax line with voice mail on page 165</a>
				✓			<a href="#">Case G: Fax line shared with computer modem (no voice calls received) on page 166</a>
			✓	✓			<a href="#">Case H: Shared voice/fax line with computer modem on page 168</a>
			✓		✓		<a href="#">Case I: Shared voice/fax line with answering machine on page 171</a>
			✓	✓	✓		<a href="#">Case J: Shared voice/fax line with computer modem and answering machine on page 173</a>
			✓	✓		✓	<a href="#">Case K: Shared voice/fax line with computer dial-up modem and voice mail on page 176</a>

## Case A: Separate fax line (no voice calls received)

If you have a separate phone line on which you receive no voice calls, and you have no other equipment connected on this phone line, set up the printer as described in this section.

**Figure B-1** Back view of the printer

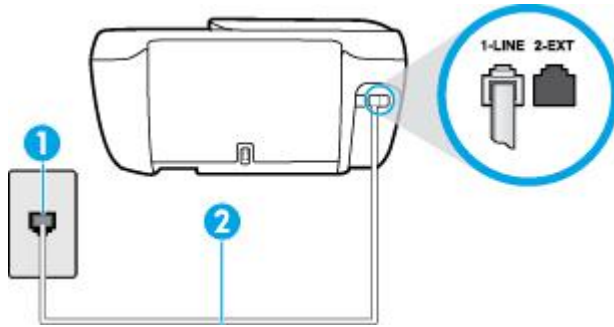

---

1	Telephone wall jack
2	Connect the phone cord to the port labelled 1-LINE on the back of the printer. You might need to connect the phone cord to your country/region adapter.

---

### To set up the printer with a separate fax line

1. Connect one end of the phone cord to your telephone wall jack, then connect the other end to the port labeled 1-LINE on the back of the printer.

 **NOTE:** You might need to connect the phone cord to your country/region adapter.

---

2. Turn on the **Auto Answer** setting.
3. (Optional) Change the **Rings to Answer** setting to the lowest setting (two rings).
4. Run a fax test.

When the phone rings, the printer answers automatically after the number of rings you set in the **Rings to Answer** setting. The printer begins emitting fax reception tones to the sending fax machine and receives the fax.

### Case B: Set up the printer with DSL

If you have a DSL service through your telephone company, and do not connect any equipment to the printer, use the instructions in this section to connect a DSL filter between the telephone wall jack and the printer. The DSL filter removes the digital signal that can interfere with the printer, so the printer can communicate correctly with the phone line. (DSL might be called ADSL in your country/region.)

 **NOTE:** If you have a DSL line and you do not connect the DSL filter, you cannot send and receive faxes with the printer.

---

**Figure B-2** Back view of the printer

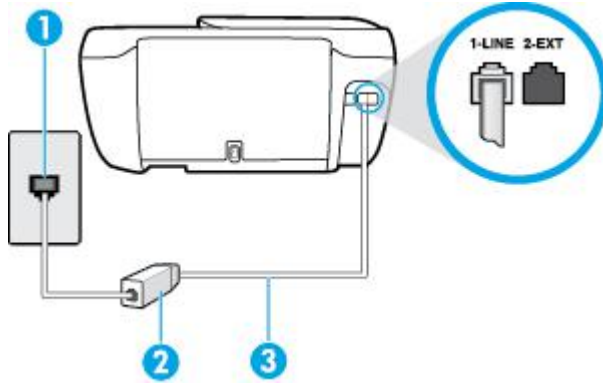

1	Telephone wall jack
2	DSL (or ADSL) filter and cord supplied by your DSL provider
3	Connect the phone cord to the port labelled 1-LINE on the back of the printer. You might need to connect the phone cord to your country/region adapter.

### To set up the printer with DSL

1. Obtain a DSL filter from your DSL provider.
2. Connect one end of the phone cord to the DSL filter, and then connect the other end to the port labeled 1-LINE on the back of the printer.

 **NOTE:** You might need to connect the phone cord to your country/region adapter.

You might need to obtain additional phone cords for this setup.

3. Connect an additional phone cord from the DSL filter to the telephone wall jack.
4. Run a fax test.

If you encounter problems setting up the printer with optional equipment, contact your local service provider or vendor for further assistance.

### Case C: Set up the printer with a PBX phone system or an ISDN line

If you are using either a PBX phone system or an ISDN converter/terminal adapter, make sure you do the following:

- If you are using either a PBX or an ISDN converter/terminal adaptor, connect the printer to the port that is designated for fax and phone use. Also, make sure that the terminal adapter is set to the correct switch type for your country/region, if possible.



---

 **NOTE:** Some ISDN systems allow you to configure the ports for specific phone equipment. For example, you might have assigned one port for telephone and Group 3 fax and another port for multiple purposes. If you have problems when connected to the fax/phone port of your ISDN converter, try using the port designated for multiple purposes; it might be labeled "multi-combi" or something similar.

---

- If you are using a PBX phone system, set the call waiting tone to "off."

---

 **NOTE:** Many digital PBX systems include a call-waiting tone that is set to "on" by default. The call waiting tone interferes with any fax transmission, and you cannot send or receive faxes with the printer. Refer to the documentation that came with your PBX phone system for instructions on how to turn off the call-waiting tone.

---

- If you are using a PBX phone system, dial the number for an outside line before dialing the fax number.
- You might need to connect the phone cord to your country/region adapter.

If you encounter problems setting up the printer with optional equipment, contact your local service provider or vendor for further assistance.

## Case D: Fax with a distinctive ring service on the same line

If you subscribe to a distinctive ring service (through your telephone company) that allows you to have multiple phone numbers on one phone line, each with a different ring pattern, set up the printer as described in this section.

**Figure B-3** Back view of the printer

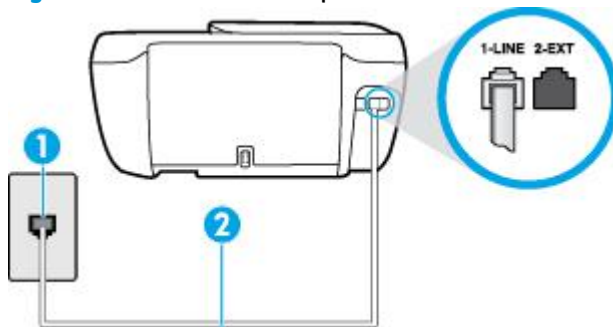

---

1	Telephone wall jack
---	---------------------

---

2	Connect the phone cord to the port labelled 1-LINE on the back of the printer.
---	--

You might need to connect the phone cord to your country/region adapter.

---

### To set up the printer with a distinctive ring service

1. Connect one end of the phone cord to your telephone wall jack, then connect the other end to the port labeled 1-LINE on the back of the printer.

---

 **NOTE:** You might need to connect the phone cord to your country/region adapter.

---

2. Turn on the **Auto Answer** setting.
3. Change the **Distinctive Ring** setting to match the pattern that the telephone company assigned to your fax number.

 **NOTE:** By default, the printer is set to answer all ring patterns. If you do not set the **Distinctive Ring** to match the ring pattern assigned to your fax number, the printer might answer both voice calls and fax calls or it might not answer at all.

 **TIP:** You can also use the Ring Pattern Detection feature in the printer control panel to set distinctive ring. With this feature, the printer recognizes and records the ring pattern of an incoming call and, based on this call, automatically determines the distinctive ring pattern assigned by your telephone company to fax calls. For more information, see [Change the answer ring pattern for distinctive ring on page 65](#).

4. (Optional) Change the **Rings to Answer** setting to the lowest setting (two rings).
5. Run a fax test.

The printer automatically answers incoming calls that have the ring pattern you selected ( **Distinctive Ring** setting) after the number of rings you selected ( **Rings to Answer** setting). The printer begins emitting fax reception tones to the sending fax machine and receives the fax.

If you encounter problems setting up the printer with optional equipment, contact your local service provider or vendor for further assistance.

## Case E: Shared voice/fax line

If you receive both voice calls and fax calls at the same phone number, and you have no other office equipment (or voice mail) on this phone line, set up the printer as described in this section.

**Figure B-4** Back view of the printer

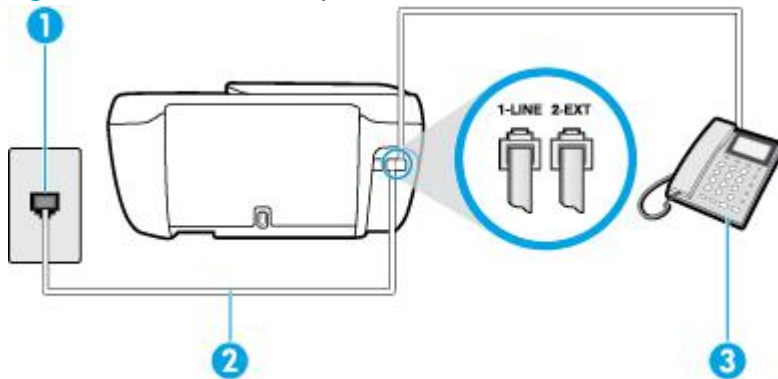

1	Telephone wall jack
2	Connect the phone cord to the port labelled 1-LINE on the back of the printer. You might need to connect the phone cord to your country/region adapter.
3	Telephone (optional)

### To set up the printer with a shared voice/fax line

1. Connect one end of the phone cord to your telephone wall jack, then connect the other end to the port labeled 1-LINE on the back of the printer.

 **NOTE:** You might need to connect the phone cord to your country/region adapter.

2. Do one of the following:

- If you have a parallel-type phone system, remove the white plug from the port labeled 2-EXT on the back of the printer, and then connect a phone to this port.
  - If you have a serial-type phone system, you might plug your phone directly on top of the printer cable which has a wall plug attached to it.
3. Now you need to decide how you want the printer to answer calls, automatically or manually:
- If you set up the printer to answer calls **automatically**, it answers all incoming calls and receives faxes. The printer cannot distinguish between fax and voice calls in this case; if you suspect the call is a voice call, you need to answer it before the printer answers the call. To set up the printer to answer calls automatically, turn on the **Auto Answer** setting.
  - If you set up the printer to answer faxes **manually**, you must be available to respond in person to incoming fax calls or the printer cannot receive faxes. To set up the printer to answer calls manually, turn off the **Auto Answer** setting.
4. Run a fax test.

If you pick up the phone before the printer answers the call and hear fax tones from a sending fax machine, you need to answer the fax call manually.

If you encounter problems setting up the printer with optional equipment, contact your local service provider or vendor for further assistance.

## Case F: Shared voice/fax line with voice mail

If you receive both voice calls and fax calls at the same phone number, and you also subscribe to a voice mail service through your telephone company, set up the printer as described in this section.

 **NOTE:** You cannot receive faxes automatically if you have a voice mail service at the same phone number you use for fax calls. You must receive faxes manually; this means you must be available to respond in person to incoming fax calls. If you want to receive faxes automatically instead, contact your telephone company to subscribe to a distinctive ring service, or to obtain a separate phone line for faxing.

**Figure B-5** Back view of the printer

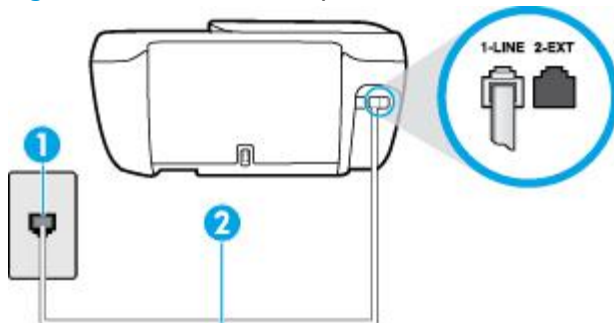

1	Telephone wall jack
2	Connect the phone cord to the port labelled 1-LINE on the back of the printer. You might need to connect the phone cord to your country/region adapter.

## To set up the printer with voice mail

1. Connect one end of the phone cord to your telephone wall jack, then connect the other end to the port labeled 1-LINE on the back of the printer.

 **NOTE:** You might need to connect the phone cord to your country/region adapter.

2. Turn off the **Auto Answer** setting.
3. Run a fax test.

You must be available to respond in person to incoming fax calls, or the printer cannot receive faxes. You must initiate the manual fax before voicemail picks up the line.

If you encounter problems setting up the printer with optional equipment, contact your local service provider or vendor for further assistance.

## Case G: Fax line shared with computer modem (no voice calls received)

If you have a fax line on which you receive no voice calls, and you also have a computer modem connected on this line, set up the printer as described in this section.

 **NOTE:** If you have a computer dial-up modem, your computer dial-up modem shares the phone line with the printer. You cannot use both your modem and the printer simultaneously. For example, you cannot use the printer for faxing while you are using your computer dial-up modem to send an email or access the Internet.

- [Set up the printer with a computer dial-up modem](#)
- [Set up the printer with a computer DSL/ADSL modem](#)

## Set up the printer with a computer dial-up modem

If you are using the same phone line for sending faxes and for a computer dial-up modem, follow these directions for setting up the printer.

**Figure B-6** Back view of the printer

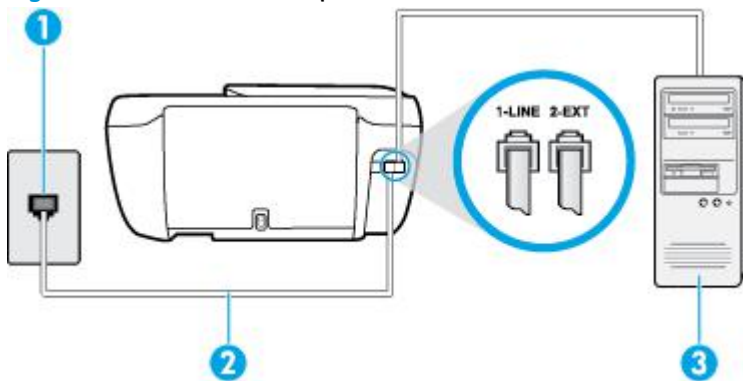

1	Telephone wall jack
2	Connect the phone cord to the port labelled 1-LINE on the back of the printer. You might need to connect the phone cord to your country/region adapter.
3	Computer with modem

## To set up the printer with a computer dial-up modem

1. Remove the white plug from the port labeled 2-EXT on the back of the printer.
2. Find the phone cord that connects from the back of your computer (your computer dial-up modem) to a telephone wall jack. Disconnect the cord from the telephone wall jack and plug it into the port labeled 2-EXT on the back of the printer.
3. Connect one end of the phone cord to your telephone wall jack, then connect the other end to the port labeled 1-LINE on the back of the printer.

 **NOTE:** You might need to connect the phone cord to your country/region adapter.

4. If your modem software is set to receive faxes to your computer automatically, turn off that setting.

 **NOTE:** If you do not turn off the automatic fax reception setting in your modem software, the printer cannot receive faxes.

5. Turn on the **Auto Answer** setting.
6. (Optional) Change the **Rings to Answer** setting to the lowest setting (two rings).
7. Run a fax test.

When the phone rings, the printer automatically answers after the number of rings you set in the **Rings to Answer** setting. The printer begins emitting fax reception tones to the sending fax machine and receives the fax.

If you encounter problems setting up the printer with optional equipment, contact your local service provider or vendor for further assistance.

## Set up the printer with a computer DSL/ADSL modem

If you have a DSL line and use that phone line to send faxes, follow these instructions to set up your fax.

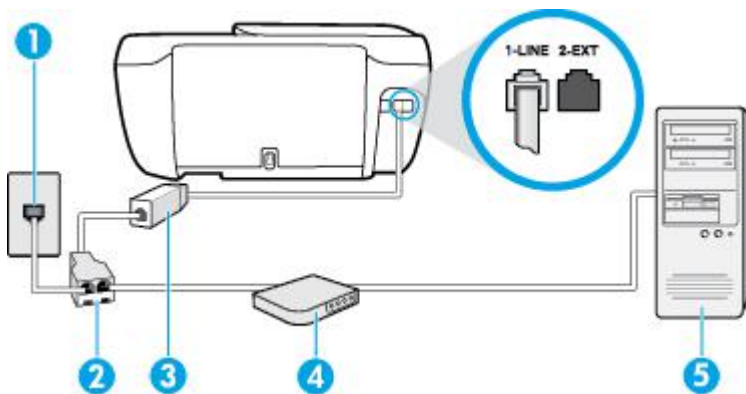

1 Telephone wall jack

2 Parallel splitter

3 DSL/ADSL filter

Connect one end of the phone cord to the 1-LINE port on the back of the printer. Connect the other end of the cord to the DSL/ADSL filter.

You might need to connect the phone cord to your country/region adapter.

---

4	Computer DSL/ADSL modem
5	Computer

---

 **NOTE:** You need to purchase a parallel splitter. A parallel splitter has one RJ-11 port on the front and two RJ-11 ports on the back. Do not use a 2-line phone splitter, a serial splitter, or a parallel splitter which has two RJ-11 ports on the front and a plug on the back.

---

**Figure B-7** Example of a parallel splitter



### To set up the printer with a computer DSL/ADSL modem

1. Obtain a DSL filter from your DSL provider.
2. Connect one end of the phone cord to the DSL filter, and then connect the other end to the port labeled 1-LINE on the back of the printer.

 **NOTE:** You might need to connect the phone cord to your country/region adapter.

---

3. Connect the DSL filter to the parallel splitter.
4. Connect the DSL modem to the parallel splitter.
5. Connect the parallel splitter to the wall jack.
6. Run a fax test.

When the phone rings, the printer automatically answers after the number of rings you set in the **Rings to Answer** setting. The printer begins emitting fax reception tones to the sending fax machine and receives the fax.

If you encounter problems setting up the printer with optional equipment, contact your local service provider or vendor for further assistance.

## Case H: Shared voice/fax line with computer modem

There are two different ways to set up the printer with your computer based on the number of phone ports on your computer. Before you begin, check your computer to see if it has one or two phone ports.

 **NOTE:** If your computer has only one phone port, you need to purchase a parallel splitter (also called a coupler), as shown in the illustration. (A parallel splitter has one RJ-11 port on the front and two RJ-11 ports on the back. Do not use a two-line phone splitter, a serial splitter, or a parallel splitter which has two RJ-11 ports on the front and a plug on the back.)

---

- [Shared voice/fax with computer dial-up modem](#)
- [Shared voice/fax with computer DSL/ADSL modem](#)

### Shared voice/fax with computer dial-up modem

If you use your phone line for both fax and telephone calls, use these instructions to set up your fax.

There are two different ways to set up the printer with your computer based on the number of phone ports on your computer. Before you begin, check your computer to see if it has one or two phone ports.

**NOTE:** If your computer has only one phone port, you need to purchase a parallel splitter (also called a coupler), as shown in the illustration. (A parallel splitter has one RJ-11 port on the front and two RJ-11 ports on the back. Do not use a two-line phone splitter, a serial splitter, or a parallel splitter which has two RJ-11 ports on the front and a plug on the back.)

**Figure B-8** Example of a parallel splitter



**Figure B-9** Back view of the printer

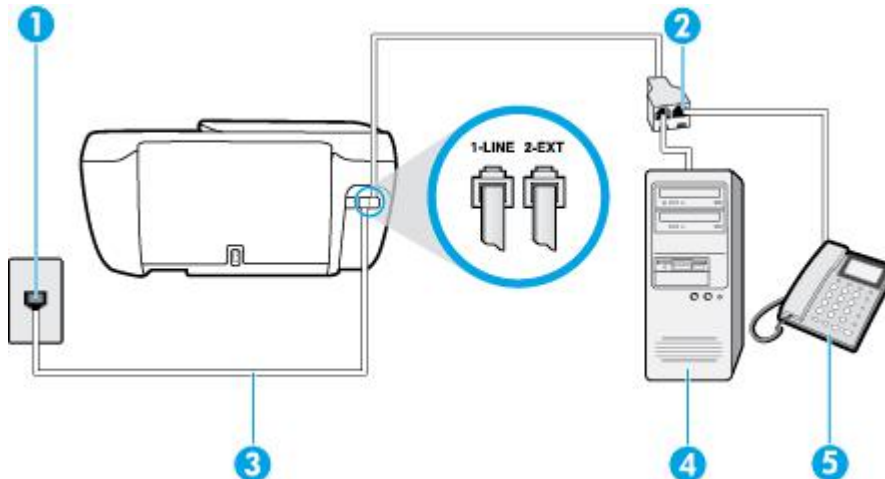

1	Telephone wall jack
2	Parallel splitter
3	Connect the phone cord to the port labelled 1-LINE on the back of the printer.
4	Computer with modem
5	Telephone

### To set up the printer on the same phone line as a computer with two phone ports

1. Remove the white plug from the port labeled 2-EXT on the back of the printer.
2. Find the phone cord that connects from the back of your computer (your computer dial-up modem) to a telephone wall jack. Disconnect the cord from the telephone wall jack and plug it into the port labeled 2-EXT on the back of the printer.
3. Connect a phone to the "OUT" port on the back of your computer dial-up modem.
4. Connect one end of the phone cord to your telephone wall jack, then connect the other end to the port labeled 1-LINE on the back of the printer.

**NOTE:** You might need to connect the phone cord to your country/region adapter.

5. If your modem software is set to receive faxes to your computer automatically, turn off that setting.

 **NOTE:** If you do not turn off the automatic fax reception setting in your modem software, the printer cannot receive faxes.

6. Now you need to decide how you want the printer to answer calls, automatically or manually:
  - If you set up the printer to answer calls **automatically**, it answers all incoming calls and receives faxes. The printer cannot distinguish between fax and voice calls in this case; if you suspect the call is a voice call, you need to answer it before the printer answers the call. To set up the printer to answer calls automatically, turn on the **Auto Answer** setting.
  - If you set up the printer to answer faxes **manually**, you must be available to respond in person to incoming fax calls or the printer cannot receive faxes. To set up the printer to answer calls manually, turn off the **Auto Answer** setting.
7. Run a fax test.

If you pick up the phone before the printer answers the call and hear fax tones from a sending fax machine, you need to answer the fax call manually.

If you use your phone line for voice, fax, and your computer dial-up modem, follow these directions to set up your fax.

If you encounter problems setting up the printer with optional equipment, contact your local service provider or vendor for further assistance.

## Shared voice/fax with computer DSL/ADSL modem

Use these instructions if your computer has a DSL/ADSL modem

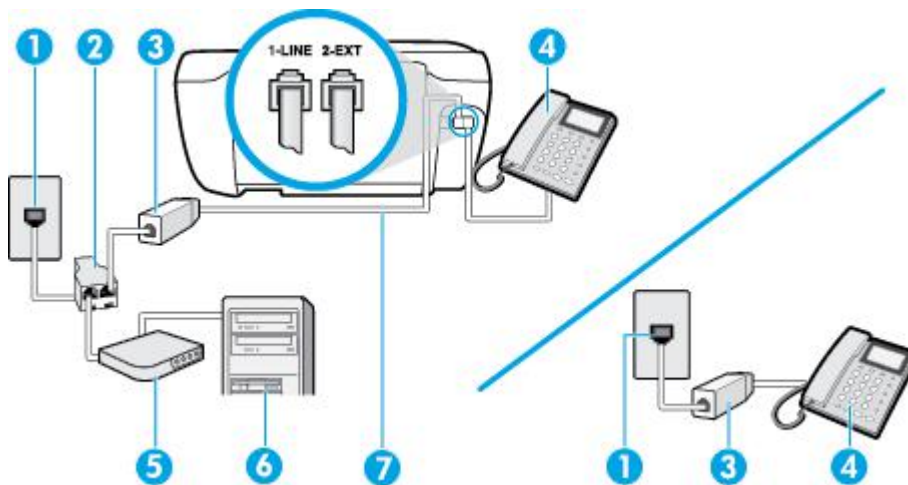

1	Telephone wall jack
2	Parallel splitter
3	DSL/ADSL filter
4	Telephone
5	DSL/ADSL modem



---

6	Computer
7	Connect the phone cord to the port labelled 1-LINE on the back of the printer.  You might need to connect the phone cord to your country/region adapter.

---

 **NOTE:** You need to purchase a parallel splitter. A parallel splitter has one RJ-11 port on the front and two RJ-11 ports on the back. Do not use a 2-line phone splitter, a serial splitter, or a parallel splitter which has two RJ-11 ports on the front and a plug on the back.

**Figure B-10** Example of a parallel splitter



### To set up the printer with a computer DSL/ADSL modem

1. Obtain a DSL filter from your DSL provider.

 **NOTE:** Phones in other parts of the home/office sharing the same phone number with DSL service need to be connected to additional DSL filters to avoid noise when making voice calls.

2. Connect one end of the phone cord to the DSL filter, and then connect the other end to the port labeled 1-LINE on the back of the printer.

 **NOTE:** You might need to connect the phone cord to your country/region adapter.

3. If you have a parallel-type phone system, remove the white plug from the port labeled 2-EXT on the back of the printer, and then connect a phone to this port.
4. Connect the DSL filter to the parallel splitter.
5. Connect the DSL modem to the parallel splitter.
6. Connect the parallel splitter to the wall jack.
7. Run a fax test.

When the phone rings, the printer automatically answers after the number of rings you set in the **Rings to Answer** setting. The printer begins emitting fax reception tones to the sending fax machine and receives the fax.

If you encounter problems setting up the printer with optional equipment, contact your local service provider or vendor for further assistance.

### Case I: Shared voice/fax line with answering machine

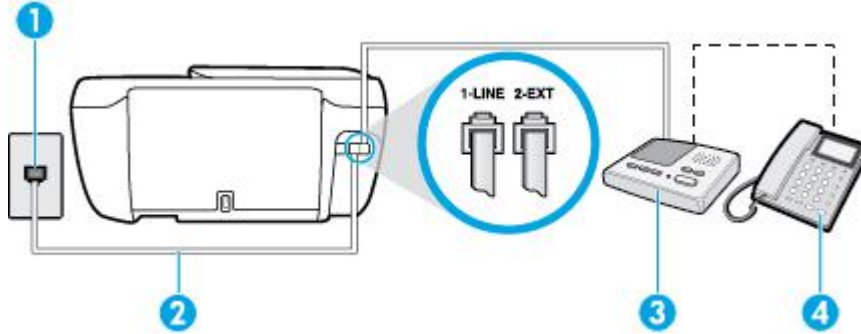

If you receive both voice calls and fax calls at the same phone number, and you also have an answering machine that answers voice calls at this phone number, set up the printer as described in this section.

**Figure B-11** Back view of the printer



1	Telephone wall jack
2	Connect the phone cord to the port labelled 1-LINE on the back of the printer. You might need to connect the phone cord to your country/region adapter.
3	Answering machine
4	Telephone (optional)

### To set up the printer with a shared voice/fax line with answering machine

1. Remove the white plug from the port labeled 2-EXT on the back of the printer.
2. Unplug your answering machine from the telephone wall jack, and connect it to the port labeled 2-EXT on the back of the printer.  
  
 **NOTE:** If you do not connect your answering machine directly to the printer, fax tones from a sending fax machine might be recorded on your answering machine, and you might not receive faxes with the printer.
3. Connect one end of the phone cord to your telephone wall jack, then connect the other end to the port labeled 1-LINE on the back of the printer.  
  
 **NOTE:** You might need to connect the phone cord to your country/region adapter.
4. (Optional) If your answering machine does not have a built-in phone, for convenience you might want to connect a phone to the back of your answering machine at the "OUT" port.  
  
 **NOTE:** If your answering machine does not let you connect an external phone, you can purchase and use a parallel splitter (also known as a coupler) to connect both the answering machine and telephone to the printer. You can use standard phone cords for these connections.
5. Turn on the **Auto Answer** setting.
6. Set your answering machine to answer after a low number of rings.
7. Change the **Rings to Answer** setting on the printer to the maximum number of rings supported by your printer. (The maximum number of rings varies by country/region.)
8. Run a fax test.

When the phone rings, your answering machine answers after the number of rings you have set, and then plays your recorded greeting. The printer monitors the call during this time, "listening" for fax tones. If

incoming fax tones are detected, the printer emits fax reception tones and receives the fax; if there are no fax tones, the printer stops monitoring the line and your answering machine can record a voice message.

If you encounter problems setting up the printer with optional equipment, contact your local service provider or vendor for further assistance.

## Case J: Shared voice/fax line with computer modem and answering machine

If you receive both voice calls and fax calls at the same phone number, and you also have a computer modem and answering machine connected on this phone line, set up the printer as described in this section.

 **NOTE:** Since your computer dial-up modem shares the phone line with the printer, you cannot use both your modem and the printer simultaneously. For example, you cannot use the printer for faxing while you are using your computer dial-up modem to send an email or access the Internet.

- [Shared voice/fax line with computer dial-up modem and answering machine](#)
- [Shared voice/fax line with computer DSL/ADSL modem and answering machine](#)

## Shared voice/fax line with computer dial-up modem and answering machine

There are two different ways to set up the printer with your computer based on the number of phone ports on your computer. Before you begin, check your computer to see if it has one or two phone ports.

 **NOTE:** If your computer has only one phone port, you need to purchase a parallel splitter (also called a coupler), as shown in the illustration. (A parallel splitter has one RJ-11 port on the front and two RJ-11 ports on the back. Do not use a two-line phone splitter, a serial splitter, or a parallel splitter which has two RJ-11 ports on the front and a plug on the back.)

**Figure B-12** Example of a parallel splitter



**Figure B-13** Back view of the printer

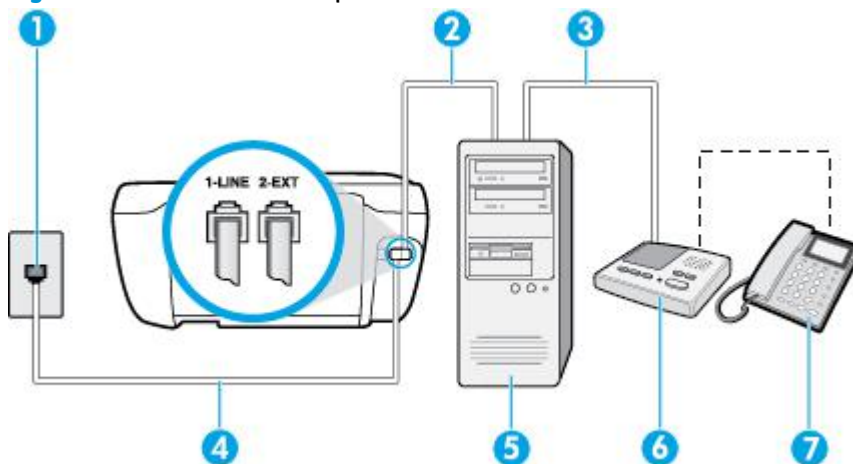

1	Telephone wall jack
2	"IN" phone port on your computer
3	"OUT" phone port on your computer

4	Connect the phone cord to the port labelled 1-LINE on the back of the printer. You might need to connect the phone cord to your country/region adapter.
5	Computer with modem
6	Answering machine
7	Telephone (optional)

### To set up the printer on the same phone line as a computer with two phone ports

1. Remove the white plug from the port labeled 2-EXT on the back of the printer.
2. Find the phone cord that connects from the back of your computer (your computer dial-up modem) to a telephone wall jack. Disconnect the cord from the telephone wall jack and plug it into the port labeled 2-EXT on the back of the printer.
3. Unplug your answering machine from the telephone wall jack, and connect it to the port labeled "OUT" on the back of the computer (the computer dial-up modem).
4. Connect one end of the phone cord to your telephone wall jack, then connect the other end to the port labeled 1-LINE on the back of the printer.



**NOTE:** You might need to connect the phone cord to your country/region adapter.

5. (Optional) If your answering machine does not have a built-in phone, for convenience you might want to connect a phone to the back of your answering machine at the "OUT" port.



**NOTE:** If your answering machine does not let you connect an external phone, you can purchase and use a parallel splitter (also known as a coupler) to connect both the answering machine and telephone to the printer. You can use standard phone cords for these connections.

6. If your modem software is set to receive faxes to your computer automatically, turn off that setting.



**NOTE:** If you do not turn off the automatic fax reception setting in your modem software, the printer cannot receive faxes.

7. Turn on the **Auto Answer** setting.
8. Set your answering machine to answer after a low number of rings.
9. Change the **Rings to Answer** setting on the printer to the maximum number of rings supported by the product. (The maximum number of rings varies by country/region.)
10. Run a fax test.

When the phone rings, your answering machine answers after the number of rings you have set, and then plays your recorded greeting. The printer monitors the call during this time, "listening" for fax tones. If incoming fax tones are detected, the printer emits fax reception tones and receives the fax; if there are no fax tones, the printer stops monitoring the line and your answering machine can record a voice message.

If you encounter problems setting up the printer with optional equipment, contact your local service provider or vendor for further assistance.

## Shared voice/fax line with computer DSL/ADSL modem and answering machine

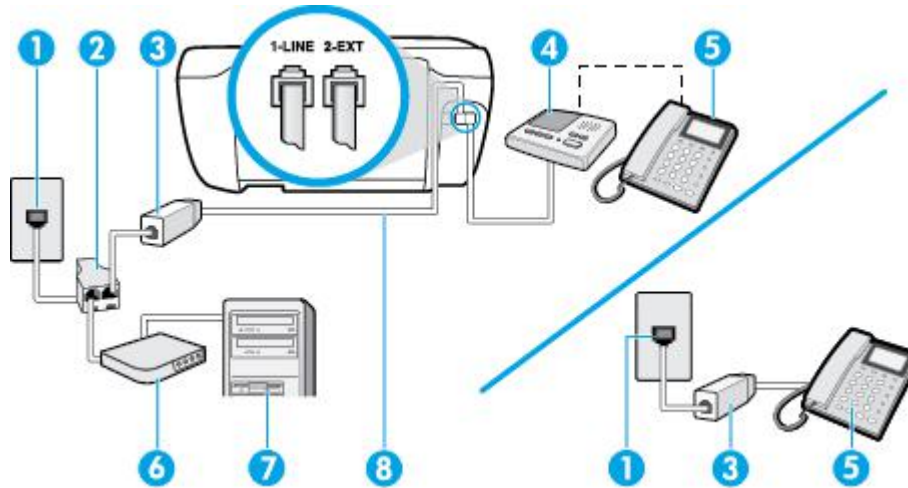

1	Telephone wall jack
2	Parallel splitter
3	DSL/ADSL filter
4	Answering machine
5	Telephone (optional)
6	DSL/ADSL modem
7	Computer
8	Phone cord connected to the 1-LINE port on the back of the printer.

You might need to connect the phone cord to your country/region adapter.

**NOTE:** You need to purchase a parallel splitter. A parallel splitter has one RJ-11 port on the front and two RJ-11 ports on the back. Do not use a 2-line phone splitter, a serial splitter, or a parallel splitter which has two RJ-11 ports on the front and a plug on the back.

**Figure B-14** Example of a parallel splitter



### To set up the printer with a computer DSL/ADSL modem

1. Obtain a DSL/ADSL filter from your DSL/ADSL provider.

**NOTE:** Phones in other parts of the home/office sharing the same phone number with DSL/ADSL service need to be connected to additional DSL/ADSL filters, to avoid noise when making voice calls.

2. Connect one end of the phone cord to the DSL/ADSL filter, and then connect the other end to the port labeled 1-LINE on the back of the printer.

**NOTE:** You might need to connect the phone cord to your country/region adapter.

3. Connect the DSL/ADSL filter to the splitter.

4. Unplug the answering machine from the telephone wall jack, and connect it to the port labeled 2-EXT on the back of the printer.

---

 **NOTE:** If you do not connect your answering machine directly to the printer, fax tones from a sending fax machine might be recorded on your answering machine, and you might not receive faxes with the printer.

---

5. Connect the DSL modem to the parallel splitter.
6. Connect the parallel splitter to the wall jack.
7. Set your answering machine to answer after a low number of rings.
8. Change your **Rings to Answer** setting on the printer to the maximum number of rings supported by the printer.

---

 **NOTE:** The maximum number of rings varies by country/region.

---

9. Run a fax test.

When the phone rings, your answering machine answers after the number of rings you have set, and then play your recorded greeting. The printer monitors the call during this time, “listening” for fax tones. If incoming fax tones are detected, the printer emits fax reception tones and receive the fax; if there are no fax tones, the printer stops monitoring the line and your answering machine can record a voice message.

If you use the same phone line for telephone, fax, and have a computer DSL modem, follow these instructions to set up your fax.

If you encounter problems setting up the printer with optional equipment, contact your local service provider or vendor for further assistance.

## Case K: Shared voice/fax line with computer dial-up modem and voice mail

If you receive both voice calls and fax calls at the same phone number, use a computer dial-up modem on the same phone line, and subscribe to a voice mail service through your telephone company, set up the printer as described in this section.

---

 **NOTE:** You cannot receive faxes automatically if you have a voice mail service at the same phone number you use for fax calls. You must receive faxes manually; this means you must be available to respond in person to incoming fax calls. If you want to receive faxes automatically instead, contact your telephone company to subscribe to a distinctive ring service, or to obtain a separate phone line for faxing.

---

Since your computer dial-up modem shares the phone line with the printer, you cannot use both your modem and the printer simultaneously. For example, you cannot use the printer for faxing if you are using your computer dial-up modem to send an email or access the Internet.

There are two different ways to set up the printer with your computer based on the number of phone ports on your computer. Before you begin, check your computer to see if it has one or two phone ports.

- If your computer has only one phone port, you need to purchase a parallel splitter (also called a coupler), as shown in the illustration. (A parallel splitter has one RJ-11 port on the front and two RJ-11 ports on the back. Do not use a two-line phone splitter, a serial splitter, or a parallel splitter which has two RJ-11 ports on the front and a plug on the back.)

**Figure B-15** Example of a parallel splitter



- If your computer has two phone ports, set up the printer as follows:

**Figure B-16** Back view of the printer

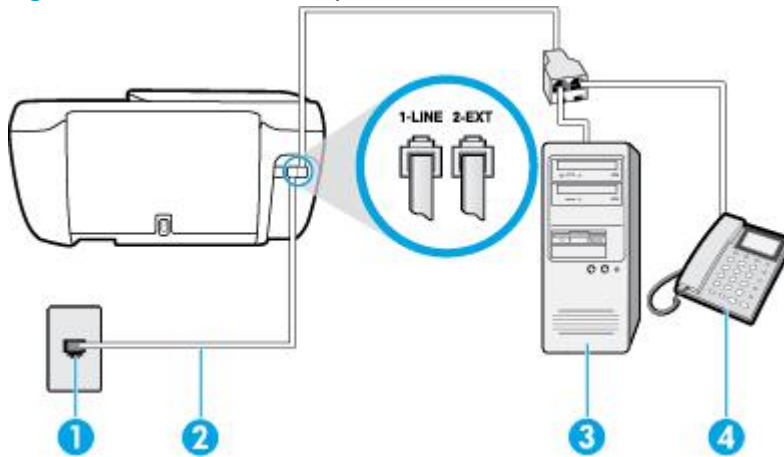

1	Telephone wall jack
2	Use the phone cord supplied in the box with the printer to connect to the 1-LINE port You might need to connect the phone cord to your country/region adapter.
3	Computer with modem
4	Telephone

#### To set up the printer on the same phone line as a computer with two phone ports

1. Remove the white plug from the port labeled 2-EXT on the back of the printer.
2. Find the phone cord that connects from the back of your computer (your computer dial-up modem) to a telephone wall jack. Disconnect the cord from the telephone wall jack and plug it into the port labeled 2-EXT on the back of the printer.
3. Connect a phone to the "OUT" port on the back of your computer dial-up modem.
4. Connect one end of the phone cord to your telephone wall jack, then connect the other end to the port labeled 1-LINE on the back of the printer.

 **NOTE:** You might need to connect the phone cord to your country/region adapter.

5. If your modem software is set to receive faxes to your computer automatically, turn off that setting.

 **NOTE:** If you do not turn off the automatic fax reception setting in your modem software, the printer cannot receive faxes.

6. Turn off the **Auto Answer** setting.
7. Run a fax test.

You must be available to respond in person to incoming fax calls, or the printer cannot receive faxes.

If you encounter problems setting up the printer with optional equipment, contact your local service provider or vendor for further assistance.

## Test fax setup

You can test your fax setup to check the status of the printer and to make sure it is set up correctly for faxing. Perform this test after you have completed setting up the printer for faxing. The test does the following:

- Tests the fax hardware
- Verifies the correct type of phone cord is connected to the printer
- Checks that the phone cord is plugged into the correct port
- Checks for a dial tone
- Checks for an active phone line
- Tests the status of your phone line connection

The printer prints a report with the results of the test. If the test fails, review the report for information on how to fix the problem and rerun the test.

### To test fax setup via the printer control panel

1. Set up the printer for faxing according to your particular home or office setup instructions.
2. Make sure the ink cartridges are installed, and that full-size paper is loaded in the input tray before starting the test.
3. From the printer control panel, touch **Fax**.
4. Touch **Setup**.
5. Touch **Tools**, and then touch **Test Fax**.

The printer displays the status of the test on the display and prints a report.

6. Review the report.
  - If the test passes and you are still having problems faxing, check the fax settings listed in the report to verify the settings are correct. A blank or incorrect fax setting can cause problems faxing.
  - If the test fails, review the report for more information on how to fix any problems found.



---

# Index

## A

- ADSL, fax setup with
  - parallel phone systems 161
- answer ring pattern
  - change 65
  - parallel phone systems 163
- answering machine
  - fax tones recorded 125
  - set up with fax (parallel phone systems) 171
  - set up with fax and modem 173
- automatic fax reduction 59

## B

- backup fax 57
- baud rate 67
- black and white pages
  - fax 53
- blocked fax numbers
  - set up 59
- buttons, control panel 5

## C

- carriage
  - clear carriage jams 102
- clear
  - fax logs 72
- computer modem
  - shared with fax (parallel phone systems) 166
  - shared with fax and answering machine (parallel phone systems) 173
  - shared with fax and voice line (parallel phone systems) 168
  - shared with fax and voice mail (parallel phone systems) 176
- confirmation reports, fax 70

- control panel
  - buttons 5
  - features 5
  - lights 5
  - status icons 5
- copy
  - specifications 136
- correct port test, fax 119
- customer support
  - warranty 131

## D

- dial tone test, failure 121
- dial type, setting 66
- dial-up modem
  - shared with fax (parallel phone systems) 166
  - shared with fax and answering machine (parallel phone systems) 173
  - shared with fax and voice line (parallel phone systems) 168
  - shared with fax and voice mail (parallel phone systems) 176
- distinctive ringing
  - change 65
  - parallel phone systems 163
- DSL, fax setup with
  - parallel phone systems 161

## E

- ECM. *See* error correction mode
- Embedded Web Server
  - opening 94
- embedded web server
  - Webscan 51

## environment

- Environmental product
  - stewardship program 138
- environmental specifications 135
- error correction mode 56
- error reports, fax 71

## F

- fax
  - answer mode 64
  - answering machine and modem, shared with (parallel phone systems) 173
  - answering machine
    - troubleshoot 125
  - answering machine, set up (parallel phone systems) 171
  - auto answer 64
  - backup fax 57
  - blocking numbers 59
  - confirmation reports 70
  - dial tone test, failed 121
  - dial type, setting 66
  - distinctive ringing setup (parallel phone systems) 163
  - distinctive ringing, change pattern 65
  - DSL, set up (parallel phone systems) 161
  - error correction mode 56
  - error reports 71
  - fax specifications 136
  - forwarding 58
  - header 64
  - Internet Protocol, over 69
  - ISDN line, set up (parallel phone systems) 162
  - line condition test, failed 121

- log, clear 72
  - log, print 71
  - manual receive 57
  - modem and answering machine, shared with (parallel phone systems) 173
  - modem and voice line, shared with (parallel phone systems) 168
  - modem and voice mail, shared with (parallel phone systems) 176
  - modem, shared with (parallel phone systems) 166
  - monitor dialing 55
  - parallel phone systems 158
  - PBX system, set up (parallel phone systems) 162
  - phone cord connection test, failed 119
  - phone cord type test, failed 120
  - print last transaction details 72
  - receive 57
  - receive, troubleshoot 122, 124
  - redial options 66
  - reduction 59
  - reports 70
  - reprint 58
  - rings to answer 65
  - send 54
  - send, troubleshoot 122, 125
  - separate line setup (parallel phone systems) 160
  - settings, change 64
  - setup types 159
  - shared phone line setup (parallel phone systems) 164
  - sound volume 67
  - speed 67
  - test failed 118
  - test setup 178
  - troubleshoot 118
  - voice mail, set up (parallel phone systems) 165
  - wall jack test, failed 119
  - Fax screen 5
  - forwarding faxes 58
- H**
- hardware, fax setup test 119
- header, fax 64
  - Help button 6
- I**
- Internet Protocol fax, using 69
  - ISDN line, set up with fax parallel phone systems 162
- J**
- jams clear 98
  - junk fax mode 59
- L**
- lights, control panel 5
  - line condition test, fax 121
  - log, fax print 71
- M**
- manual faxing receive 57 send 55
  - memory reprint faxes 58 save faxes 57
  - modem shared with fax (parallel phone systems) 166 shared with fax and answering machine (parallel phone systems) 173 shared with fax and voice line (parallel phone systems) 168 shared with fax and voice mail (parallel phone systems) 176
  - monitor dialing 55
  - multi-feeds, troubleshoot 103
- N**
- network connection wireless connection 86
- O**
- operating systems supported 135
- P**
- paper clear jams 98 HP, order 14 skewed pages 102 troubleshoot feeding 102
  - paper-feed problems, troubleshoot 102
  - parallel phone systems answering machine setup 171 countries/regions with 158 distinctive ringing setup 163 DSL setup 161 ISDN setup 162 modem and answering machine setup 173 modem and voice mail setup 176 modem setup 166 modem shared with voice line setup 168 PBX setup 162 separate line setup 160 setup types 159 shared line setup 164
  - PBX system, set up with fax parallel phone systems 162
  - phone book change contact 61 change group contacts 62 delete contacts 62 send fax 54 set up 61 set up group contacts 62
  - phone cord connected to correct port test failed 119 correct type test failed 120
  - phone line, answer ring pattern 65
  - phone, fax from receive 57 send, 55
  - power troubleshoot 128
  - print fax logs 71 fax reports 70 faxes 58 last fax details 72 specifications 136 troubleshoot 128
  - printer control panel send faxes 54

printer software (Windows)  
opening 15  
pulse dialing 66

## R

receive faxes  
auto answer mode 64  
automatically 57  
blocking numbers 59  
forwarding 58  
manually 57  
rings to answer 65  
troubleshoot 122, 124  
recycle  
ink cartridges 139  
redial options, setting 66  
reduce fax 59  
regulatory notices 146  
regulatory notices 146  
regulatory model identification  
number 146  
wireless statements 151  
reports  
confirmation, fax 70  
error, fax 71  
fax test failed 118  
reprint  
faxes from memory 58  
rings to answer 65

## S

save  
faxes in memory 57  
scan  
from Webscan 51  
scan specifications 136  
send faxes  
basic fax 54  
from a phone 55  
monitor dialing 55  
troubleshoot 122, 125  
serial phone systems  
countries/regions with 158  
setup types 159  
settings  
speed, fax 67  
volume, fax 67  
setup  
answering machine (parallel  
phone systems) 171

answering machine and modem  
(parallel phone systems) 173  
computer modem (parallel phone  
systems) 166  
computer modem and answering  
machine (parallel phone  
systems) 173  
computer modem and voice line  
(parallel phone systems) 168  
computer modem and voice mail  
(parallel phone systems) 176  
distinctive ringing 65  
distinctive ringing (parallel phone  
systems) 163  
DSL (parallel phone systems)  
161  
fax scenarios 159  
fax, with parallel phone  
systems 158  
ISDN line (parallel phone  
systems) 162  
PBX system (parallel phone  
systems) 162  
separate fax line (parallel phone  
systems) 160  
shared phone line (parallel phone  
systems) 164  
test fax 178  
voice mail (parallel phone  
systems) 165  
voice mail and computer modem  
(parallel phone systems) 176  
skew, troubleshoot  
print 102  
software  
Webscan 51  
specifications  
system requirements 135  
status icons 5  
subscriber identification code 64  
system requirements 135

## T

technical information  
copy specifications 136  
environmental specifications  
135  
fax specifications 136  
print specifications 136  
scan specifications 136

telephone line, answer ring pattern  
65  
telephone wall jack, fax 119  
telephone, fax from  
receive 57  
send 55  
tests, fax  
dial tone, failed 121  
failed 118  
fax line condition 121  
fax phone cord type test failed  
120  
hardware, failed 119  
port connection, failed 119  
setup 178  
telephone wall jack 119  
tone dialing 66  
trays  
clear paper jams 98  
troubleshoot feeding 102  
troubleshoot  
answering machines 125  
fax 118  
fax dial tone test failed 121  
fax hardware test failed 119  
fax line test failed 121  
fax phone cord connection test  
failed 119  
fax phone cord type test failed  
120  
fax tests 118  
fax wall jack test, failed 119  
multiple pages are picked 103  
paper not picked up from tray  
102  
paper-feed problems 102  
power 128  
print 128  
receive faxes 122, 124  
send faxes 122, 125  
skewed pages 102  
V  
voice mail  
set up with fax (parallel phone  
systems) 165  
set up with fax and computer  
modem (parallel phone  
systems) 176  
VoIP 69

volume  
    fax sounds 67

**W**

wall jack test, fax 119  
warranty 131  
Webscan 51  
Windows  
    system requirements 135