



**HP Officejet 6800**

**User Guide**

**Copyright information**

© 2014 Copyright Hewlett-Packard Development Company, L.P.

Edition 1, 7/2014

**Hewlett-Packard Company notices**

The information contained in this document is subject to change without notice.

All rights reserved. Reproduction, adaptation, or translation of this material is prohibited without prior written permission of Hewlett-Packard, except as allowed under copyright laws.

The only warranties for HP products and services are set forth in the express warranty statements accompanying such products and services. Nothing herein should be construed as constituting an additional warranty. HP shall not be liable for technical or editorial errors or omissions contained herein.

**Acknowledgements**

Microsoft, Windows, Windows XP, Windows Vista, Windows 7, Windows 8, and Windows 8.1 are U.S. registered trademarks of Microsoft Corporation.

ENERGY STAR and the ENERGY STAR mark are registered U.S. marks.

Mac, OS X, and AirPrint are trademarks of Apple Inc., registered in the U.S. and other countries.

## Safety information



Always follow basic safety precautions when using this product to reduce risk of injury from fire or electric shock.

1. Read and understand all instructions in the documentation that comes with the printer.
2. Observe all warnings and instructions marked on the product.
3. Unplug this product from wall outlets before cleaning.
4. Do not install or use this product near water, or when you are wet.
5. Install the product securely on a stable surface.
6. Install the product in a protected location where no one can step on or trip over the line cord, and the line cord cannot be damaged.
7. If the product does not operate normally, see [Solve a problem](#).
8. There are no user-serviceable parts inside. Refer servicing to qualified service personnel.



---

# Table of contents

<b>1 How do I?</b> .....	<b>1</b>
<b>2 Get started</b> .....	<b>2</b>
Accessibility .....	2
HP EcoSolutions (HP and the Environment) .....	3
Manage Power .....	3
Optimize Printing Supplies .....	3
Understand the printer parts .....	4
Front view .....	4
Printing supplies area .....	5
Back view .....	5
Use the printer control panel .....	6
Overview of buttons and lights .....	6
Control panel display icons .....	6
Change printer settings .....	7
Paper basics .....	8
Recommended papers for printing .....	8
Order HP paper supplies .....	10
Tips for selecting and using paper .....	10
Load paper .....	11
Load an original on the scanner glass .....	16
Load an original in the document feeder .....	17
Insert a USB flash drive .....	18
Update the printer .....	18
Open the HP printer software (Windows) .....	19
Turn the printer off .....	19
<b>3 Print</b> .....	<b>20</b>
Print documents .....	20
Print brochures .....	21
Print on envelopes .....	22
Print photos .....	23
Print on special and custom-size paper .....	25
Print on both sides (duplexing) .....	27
Print using the maximum dpi .....	28
Tips for print success .....	29

Print with AirPrint™ .....	32
<b>4 Copy and scan .....</b>	<b>33</b>
Copy .....	33
Scan .....	33
Scan to a computer .....	34
Scan to a memory device .....	35
Scan to Email .....	36
Set up Scan to Email .....	36
Use Scan to Email .....	36
Change account settings .....	37
Scan using Webscan .....	37
Scanning documents as editable text .....	38
Scan documents as editable text .....	38
Guidelines for scanning documents as editable text .....	39
<b>5 Fax .....</b>	<b>41</b>
Send a fax .....	41
Send a standard fax .....	41
Send a standard fax from the computer .....	42
Send a fax from a phone .....	43
Send a fax using monitor dialing .....	43
Send a fax from memory .....	44
Send a fax to multiple recipients .....	44
Send a fax in Error Correction Mode .....	45
Receive a fax .....	45
Receive a fax manually .....	46
Set up backup fax .....	46
Reprint received faxes from memory .....	47
Forward faxes to another number .....	47
Set automatic reduction for incoming faxes .....	48
Block unwanted fax numbers .....	48
Receive faxes using HP Digital Fax .....	49
HP Digital Fax requirements .....	50
Activate HP Digital Fax .....	50
Modify HP Digital Fax settings .....	50
Set up phone book contacts .....	51
Set up and change phone book contacts .....	51
Set up and change group phone book contacts .....	52
Delete phone book contacts .....	53
Print a list of phone book contacts .....	53

Change fax settings .....	53
Configure the fax header .....	53
Set the answer mode (Auto answer) .....	54
Set the number of rings before answering .....	54
Change the answer ring pattern for distinctive ring .....	55
Set the dial type .....	55
Set the redial options .....	56
Set the fax speed .....	56
Set the fax sound volume .....	57
Fax and digital phone services .....	57
Fax over Internet Protocol .....	57
Use reports .....	58
Print fax confirmation reports .....	58
Print fax error reports .....	59
Print and view the fax log .....	59
Clear the fax log .....	60
Print the details of the last fax transaction .....	60
Print a Caller ID Report .....	60
View the Call History .....	60
<b>6 Web Services .....</b>	<b>61</b>
What are Web Services? .....	61
Set up Web Services .....	61
Use Web Services .....	63
HP ePrint .....	63
HP Printables .....	64
Remove Web Services .....	64
<b>7 Work with ink cartridges .....</b>	<b>65</b>
Information on ink cartridges and the printhead .....	65
Check the estimated ink levels .....	65
Replace the ink cartridges .....	66
Order ink cartridges .....	67
Store printing supplies .....	68
Anonymous usage information storage .....	68
Ink cartridge warranty information .....	69
<b>8 Network setup .....</b>	<b>70</b>
Set up the printer for wireless communication .....	70
Before you begin .....	70

Set up the printer on your wireless network .....	71
Change the connection type .....	71
Test the wireless connection .....	72
Turn on or off the wireless capability of the printer .....	72
Change network settings .....	73
Use HP wireless direct .....	74
<b>9 Printer management tools .....</b>	<b>77</b>
Toolbox (Windows) .....	77
HP Utility (OS X) .....	77
Embedded web server .....	77
About cookies .....	78
Open the embedded web server .....	78
Control panel lock .....	78
Embedded web server cannot be opened .....	79
<b>10 Solve a problem .....</b>	<b>80</b>
HP support .....	80
Register printer .....	80
Support process .....	81
Obtain electronic support .....	81
HP support by phone .....	81
Before you call .....	81
Phone support period .....	82
Support phone numbers .....	82
After the phone support period .....	82
Get help from the printer control panel .....	82
Understand printer reports .....	82
Printer status report .....	83
Network configuration page .....	84
Print quality report .....	86
Wireless test report .....	88
Web access report .....	88
Solve printer problems .....	88
Solve printing problems .....	89
Solve copy problems .....	92
Solve scan problems .....	93
Solve fax problems .....	96
The fax test failed .....	96
The display always shows Phone Off Hook .....	100
The printer is having problems sending and receiving faxes .....	100



The printer cannot receive faxes, but can send faxes .....	102
The printer cannot send faxes, but can receive faxes .....	103
Fax tones are recorded on my answering machine .....	103
The phone cord that came with my printer is not long enough .....	104
The computer cannot receive faxes (HP Digital Fax) .....	104
Solve problems using Web Services .....	104
Solve network problems .....	105
General network troubleshooting .....	105
Unable to connect the printer wirelessly .....	106
Maintain the printer .....	108
Clean the scanner glass .....	108
Clean the exterior .....	109
Clean the document feeder .....	109
Maintain the printhead and ink cartridges .....	111
Clear paper jams .....	111
Clear the print carriage .....	119
Restore defaults and settings .....	119

**Appendix A Technical information ..... 121**

Specifications .....	121
Regulatory information .....	124
Regulatory Model Number .....	125
FCC statement .....	125
Notice to users in Korea .....	126
VCCI (Class B) compliance statement for users in Japan .....	126
Notice to users in Japan about the power cord .....	126
Noise emission statement for Germany .....	126
Visual display workplaces statement for Germany .....	126
Notice to users of the U.S. telephone network: FCC requirements .....	127
Notice to users of the Canadian telephone network .....	128
Notice to users in the European Economic Area .....	128
Notice to users of the German telephone network .....	129
Australia wired fax statement .....	129
European Union Regulatory Notice .....	129
Products with external AC Adapters .....	129
Products with wireless functionality .....	129
European telephone network declaration (Modem/Fax) .....	129
Declaration of conformity .....	131
Regulatory information for wireless products .....	132
Exposure to radio frequency radiation .....	132
Notice to users in Brazil .....	132

Notice to users in Canada .....	133
Notice to users in Taiwan .....	133
Notice to users in Mexico .....	134
Wireless notice to users in Japan .....	134
Environmental product stewardship program .....	134
Paper use .....	135
Plastics .....	135
Material safety data sheets .....	135
Recycling program .....	135
HP inkjet supplies recycling program .....	135
Disposal of waste equipment by users .....	135
Power consumption .....	135
Chemical substances .....	136
Battery disposal in the Taiwan .....	136
Battery notice for Brazil .....	136
California Perchlorate Material Notice .....	136
Declaration of the Presence Condition of the Restricted Substances Marking (Taiwan) .....	137
Toxic and hazardous substance table (China) .....	138
Restriction of hazardous substance (Ukraine) .....	138
Restriction of hazardous substance (India) .....	138
EPEAT .....	138
China SEPA Ecolabel User Information .....	139
<b>Appendix B Additional fax setup .....</b>	<b>140</b>
Set up faxing (parallel phone systems) .....	140
Select the correct fax setup for your home or office .....	141
Case A: Separate fax line (no voice calls received) .....	143
Case B: Set up the printer with DSL .....	144
Case C: Set up the printer with a PBX phone system or an ISDN line .....	145
Case D: Fax with a distinctive ring service on the same line .....	145
Case E: Shared voice/fax line .....	147
Case F: Shared voice/fax line with voice mail .....	148
Case G: Fax line shared with computer modem (no voice calls received) .....	149
Set up the printer with a computer dial-up modem .....	149
Set up the printer with a computer DSL/ADSL modem .....	150
Case H: Shared voice/fax line with computer modem .....	152
Shared voice/fax with computer dial-up modem .....	152
Shared voice/fax with computer DSL/ADSL modem .....	154
Case I: Shared voice/fax line with answering machine .....	155
Case J: Shared voice/fax line with computer modem and answering machine .....	157
Shared voice/fax line with computer dial-up modem and answering machine .....	157

Shared voice/fax line with computer DSL/ADSL modem and answering machine .....	159
Case K: Shared voice/fax line with computer dial-up modem and voice mail .....	161
Test fax setup .....	163
<b>Index .....</b>	<b>170</b>



---

# 1 How do I?

- [Get started](#)
- [Print](#)
- [Copy and scan](#)
- [Fax](#)
- [Web Services](#)
- [Work with ink cartridges](#)
- [Solve a problem](#)

---

## 2 Get started

This guide provides details about how to use the printer and how to resolve problems.

- [Accessibility](#)
- [HP EcoSolutions \(HP and the Environment\)](#)
- [Understand the printer parts](#)
- [Use the printer control panel](#)
- [Paper basics](#)
- [Load paper](#)
- [Load an original on the scanner glass](#)
- [Load an original in the document feeder](#)
- [Insert a USB flash drive](#)
- [Update the printer](#)
- [Open the HP printer software \(Windows\)](#)
- [Turn the printer off](#)

### Accessibility

The printer provides a number of features that make it accessible for people with disabilities.

#### Visual

The HP software provided with the printer is accessible for users with visual impairments or low vision by using your operating system's accessibility options and features. The software also supports most assistive technology such as screen readers, Braille readers, and voice-to-text applications. For users who are color blind, colored buttons and tabs used in the HP software have simple text or icon labels that convey the appropriate action.

#### Mobility

For users with mobility impairments, the HP software functions can be executed through keyboard commands. The HP software also supports Windows accessibility options such as StickyKeys, ToggleKeys, FilterKeys, and MouseKeys. The printer doors, buttons, paper trays, and paper-width guides can be operated by users with limited strength and reach.

#### Support

For more details about the accessibility of this printer and HP's commitment to product accessibility, visit HP's website at [www.hp.com/accessibility](http://www.hp.com/accessibility).

For accessibility information for Mac OS X, visit the Apple website at [www.apple.com/accessibility](http://www.apple.com/accessibility).

# HP EcoSolutions (HP and the Environment)

Hewlett-Packard is committed to helping you optimize your environmental footprint and empowering you to print responsibly—at home or in the office.

For more detailed information about environmental guidelines that HP follows during the manufacturing process, see [Environmental product stewardship program](#). For more information about HP's environmental initiatives, visit [www.hp.com/ecosolutions](http://www.hp.com/ecosolutions).

- [Manage Power](#)
- [Optimize Printing Supplies](#)

## Manage Power

To conserve electricity, the printer comes with the following features:

### Sleep mode

Power usage is reduced while in Sleep mode. The printer goes into low-power mode after 5 minutes of inactivity.

To change the period of inactivity before the printer goes to sleep:

1. From the printer control panel display, touch **eco**.
2. Touch **Sleep Mode**, and then touch the desired option.



### Schedule On and Off

Use this feature to automatically the printer on or off on selected days. For example, you can schedule the printer to turn on at 8 a.m. and turn off at 8 p.m. from Monday to Friday. In this way, you will save energy during the night and weekends.

To schedule the day and time for On and Off:

1. From the printer control panel display, touch **eco**.
2. Touch **Schedule Printer On/Off**.
3. Touch the desired option, and follow the on-screen messages to set the day and time to turn the printer off and on.

---

 **CAUTION:** Always turn the printer off properly, using either **Schedule Off** or  (the Power button).

If you improperly turn the printer off, the print carriage might not return to the correct position, causing problems with the ink cartridges and print quality issues.

---

## Optimize Printing Supplies

To optimize printing supplies such as ink and paper, try the following:

- Recycle used original HP ink cartridges through HP Planet Partners. For more information, visit [www.hp.com/recycle](http://www.hp.com/recycle).
- Optimize paper usage by printing on both sides of the paper.
- Save ink and paper when printing web content with HP Smart Print. For more information, visit [www.hp.com/go/smartprint](http://www.hp.com/go/smartprint).

- Change the print quality in the printer driver to a draft setting. The draft setting uses less ink.
- Do not clean the printhead unnecessarily. Doing so wastes ink and shortens the life of the cartridges.

## Understand the printer parts

This section contains the following topics:

- [Front view](#)
- [Printing supplies area](#)
- [Back view](#)

### Front view

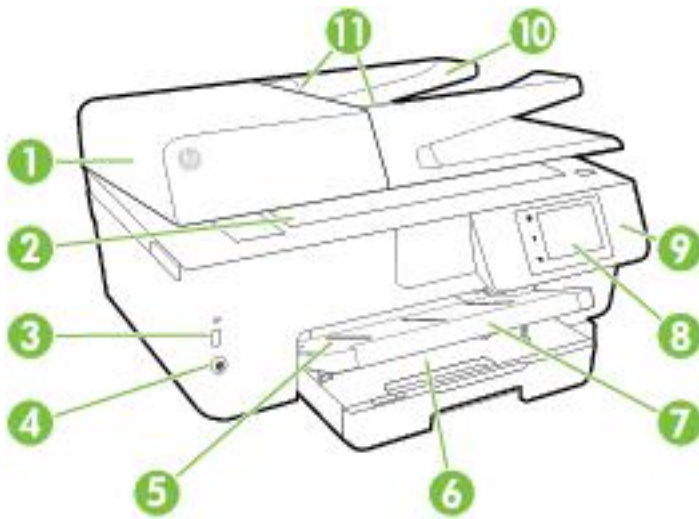

1	Document feeder
2	Scanner glass
3	Front universal serial bus (USB) port
4	Power button
5	Output tray
6	Input tray
7	Output tray extender
8	Control panel display
9	Control panel
10	Document feeder tray
11	Document feeder paper-width guides



## Printing supplies area



- 
- |   |                |
|---|----------------|
| 1 | Printhead      |
| 2 | Ink cartridges |
- 

 **NOTE:** Ink cartridges should be kept in the printer to prevent possible print quality issues or printhead damage. Avoid removing supplies for extended periods of time. Do not turn the printer off when a cartridge is missing.

---

## Back view

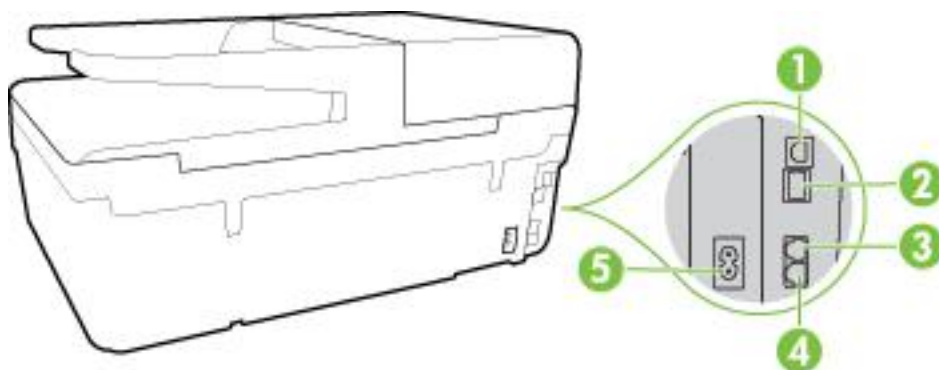

- 
- |   |                                      |
|---|--------------------------------------|
| 1 | Rear universal serial bus (USB) port |
| 2 | Ethernet network port                |
| 3 | Fax port (2-EXT)                     |
| 4 | Fax port (1-LINE)                    |
| 5 | Power input                          |
-

# Use the printer control panel

This section contains the following topics:

- [Overview of buttons and lights](#)
- [Control panel display icons](#)
- [Change printer settings](#)



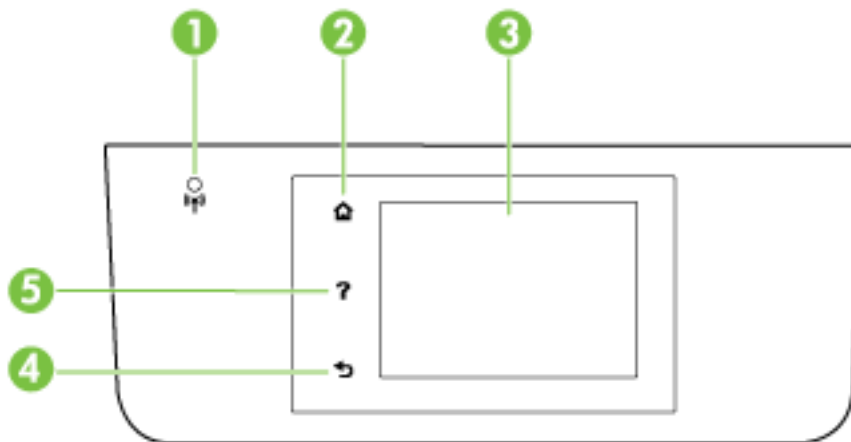

## Overview of buttons and lights













The following diagram and related table provides a quick reference to the printer control panel features.



Label	Name and Description
1	Wireless light: Indicates the status of the printer's wireless connection.
2	Home button: Returns to the home screen from any other screen.
3	Control panel display: Touch the screen to select menu options, or scroll through the menu items. For information about the icons that appear on the display, see <a href="#">Control panel display icons</a> .
4	Back button: Returns to the previous menu.
5	Help button: Opens the Help menu.

## Control panel display icons

Icon	Purpose
	Displays a screen where you can make copies or select other options.
	Shows that an Ethernet network connection exists and also provides easy access to the network status screen.
	From the HP wireless direct menu you can turn on HP wireless direct (with and without security), turn HP wireless direct off, and display the HP wireless direct name and password (if HP wireless direct is turned on with security).
	Shows that HP ePrint is turned on. For more information, see <a href="#">HP ePrint</a> .

Icon	Purpose
	Displays a screen where you can send a fax, or change fax settings.
	Displays a screen where you can make a scan.
	Displays a screen where you can use a number of HP printables, which are apps for your printer.
	Displays the Photo screen for printing photos and creating passport photos.
	Displays the Setup screen for generating reports, and changing fax and other maintenance settings.
	The screen shows How To videos, printer feature information, and tips.
	Displays wireless status and menu options. For more information, see <a href="#">Set up the printer for wireless communication</a> .  <b>NOTE:</b>  (Ethernet) and  (Wireless) will not be displayed at the same time. Showing the Ethernet icon or the wireless icon depends on the way your printer is connected to the network. If the network connection of the printer has not been set up, by default, the printer control panel display shows  (Wireless).
eco	Displays a screen where you can configure some of the printer's environmental features.
	Displays status information for the Auto Answer function, fax logs, and the fax sound volume.
	Displays a screen where you can see information about the ink cartridges, including fill levels.  <b>NOTE:</b> Ink level warnings and indicators provide estimates for planning purposes only. When you receive a low-ink warning message, consider having a replacement cartridge available to avoid possible printing delays. You do not need to replace cartridges until the print quality becomes unacceptable.

## Change printer settings

Use the control panel to change the printer function and settings, print reports, or get help for the printer.

 **TIP:** If the printer is connected to a computer, you can also change the printer settings using HP software tools available on your computer, such as the HP printer software, HP Utility (OS X), or the embedded web server (EWS).



For more information about these tools, see [Printer management tools](#).

### To change settings for a function

The Home screen of the control panel display shows the available functions for the printer.

1. From the control panel display, touch and slide your finger across the screen and then touch the icon to select the desired function.
2. After selecting a function, touch and scroll through the available settings, and then touch the setting you want to change.
3. Follow the prompts on the control panel display to change the settings.

---

 **NOTE:** Touch  (Home) to return to the Home screen.



---

### To change the printer settings

To change the printer settings or print reports, use the options available on the **Setup Menu** screen:

1. From the printer control panel display, touch **Setup** .
2. Touch and scroll through the screens.
3. Touch the screen items to select screens or options.

---

 **NOTE:** Touch  (Home) to return to the Home screen.

---

## Paper basics

The printer is designed to work well with most types of office paper. It is best to test a variety of print paper types before buying large quantities. Use HP paper for optimum print quality. Visit the HP website at [www.hp.com](http://www.hp.com) for more information about HP paper.



HP recommends plain papers with the ColorLok logo for printing everyday documents. All papers with the ColorLok logo are independently tested to meet high standards of reliability and print quality, and produce documents with crisp, vivid color, bolder blacks, and that dry faster than ordinary plain papers. Look for papers with the ColorLok logo in a variety of weights and sizes from major paper manufacturers.

This section contains the following topics:

- [Recommended papers for printing](#)
- [Order HP paper supplies](#)
- [Tips for selecting and using paper](#)

### Recommended papers for printing

If you want the best print quality, HP recommends using HP papers that are specifically designed for the type of project you are printing.

Depending on your country/region, some of these papers might not be available.

## Photo printing

- **HP Premium Plus Photo Paper**

HP Premium Plus Photo Paper is HP's highest-quality photo paper for your best photos. With HP Premium Plus Photo Paper, you can print beautiful photos that are instant-dry so you can share them right off the printer. It is available in several sizes, including A4, 8.5 x 11 inches, 4 x 6 inches (10 x 15 cm), 5 x 7 inches (13 x 18 cm), and 11 x 17 inches (A3), and in two finishes - glossy or soft gloss (semi-gloss). Ideal for framing, displaying, or gifting your best photos and special photo projects. HP Premium Plus Photo Paper delivers exceptional results with professional quality and durability.

- **HP Advanced Photo Paper**

This thick photo paper features an instant-dry finish for easy handling without smudging. It resists water, smears, fingerprints, and humidity. Your prints have a look and feel comparable to a store-processed photo. It is available in several sizes, including A4, 8.5 x 11 inches, 10 x 15 cm (4 x 6 inches), 13 x 18 cm (5 x 7 inches), and two finishes – glossy or soft-gloss (satin matte). It is acid-free for longer lasting documents.

- **HP Everyday Photo Paper**

Print colorful, everyday snapshots at a low cost, using paper designed for casual photo printing. This affordable photo paper dries quickly for easy handling. Get sharp, crisp images when you use this paper with any inkjet printer. It is available in glossy finish in several sizes, including A4, 8.5 x 11 inches, and 10 x 15 cm (4 x 6 inches). It is acid-free for longer lasting documents.

- **HP Photo Value Packs**

HP Photo Value Packs conveniently package original HP ink cartridges and HP Advanced Photo Paper to save you time and take the guesswork out of printing affordable, lab-quality photos with your HP printer. Original HP inks and HP Advanced Photo Paper have been designed to work together so your photos are long lasting and vivid, print after print. Great for printing out an entire vacation's worth of photos or multiple prints to share.

## Business documents

- **HP Premium Presentation Paper 120g Matte**

This paper is a heavy two-sided matte paper perfect for presentation, proposals, reports, and newsletters. It is heavyweight for an impressive look and feel.

- **HP Brochure Paper 180g Glossy or HP Professional Paper 180 Glossy**

These papers are glossy-coated on both sides for two-sided use. They are the perfect choice for near-photographic reproductions and business graphics for report covers, special presentations, brochures, mailers, and calendars.

- **HP Brochure Paper 180g Matte or HP Professional Paper 180 Matt**

These papers are matte-coated on both sides for two-sided use. They are the perfect choice for near-photographic reproductions and business graphics for report covers, special presentations, brochures, mailers, and calendars.

## Everyday printing

All the papers listed for everyday printing feature ColorLok Technology for less smearing, bolder blacks, and vivid colors.

- **HP Bright White Inkjet Paper**

HP Bright White Inkjet Paper delivers high-contrast colors and sharp text. It is opaque enough for two-sided color usage with no show-through, which makes it ideal for newsletters, reports, and flyers.

- **HP Printing Paper**

HP Printing Paper is a high-quality multifunction paper. It produces documents that look and feel more substantial than documents printed on standard multipurpose or copy paper. It is acid-free for longer lasting documents.

- **HP Office Paper**

HP Office Paper is a high-quality multifunction paper. It is suitable for copies, drafts, memos, and other everyday documents. It is acid-free for longer lasting documents.

- **HP Office Recycled Paper**

HP Office Recycled Paper is a high-quality multifunction paper made with 30% recycled fiber.

## Order HP paper supplies

The printer is designed to work well with most types of office paper. Use HP paper for optimum print quality.

To order HP papers and other supplies, go to [www.hp.com](http://www.hp.com). At this time, some portions of the HP website are available in English only.

HP recommends plain papers with the ColorLok logo for printing and copying of everyday documents. All papers with the ColorLok logo are independently tested to meet high standards of reliability and print quality, and produce documents with crisp, vivid color, bolder blacks and dry faster than ordinary plain papers. Look for papers with the ColorLok logo in a variety of weights and sizes from major paper manufacturers.

## Tips for selecting and using paper

For the best results, observe the following guidelines.

- Load only one type of paper at a time into a tray or document feeder.
- When loading the tray and document feeder, make sure the paper is loaded correctly.
- Do not overload the tray or document feeder.
- To prevent jams, poor print quality, and other printing problems, avoid loading the following paper in the tray or document feeder:
  - Multipart forms
  - Media that is damaged, curled, or wrinkled
  - Media with cutouts or perforations
  - Media that is heavily textured, embossed, or does not accept ink well
  - Media that is too lightweight or stretches easily
  - Media that contains staples or clips

For more information on loading paper, see [Load paper](#) or [Load an original in the document feeder](#).

# Load paper

## To load standard paper

1. Lift the output tray.

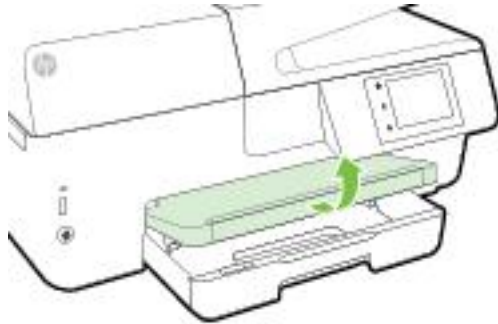

2. Pull out the input tray to extend it.



---

**NOTE:** To load legal-size paper, slide the grey button (on the front left of the input tray) to the right, and lower the front of the tray.

---

3. Slide the paper-width guides out as far as possible.

4. Insert the paper print-side down in the center of the tray.

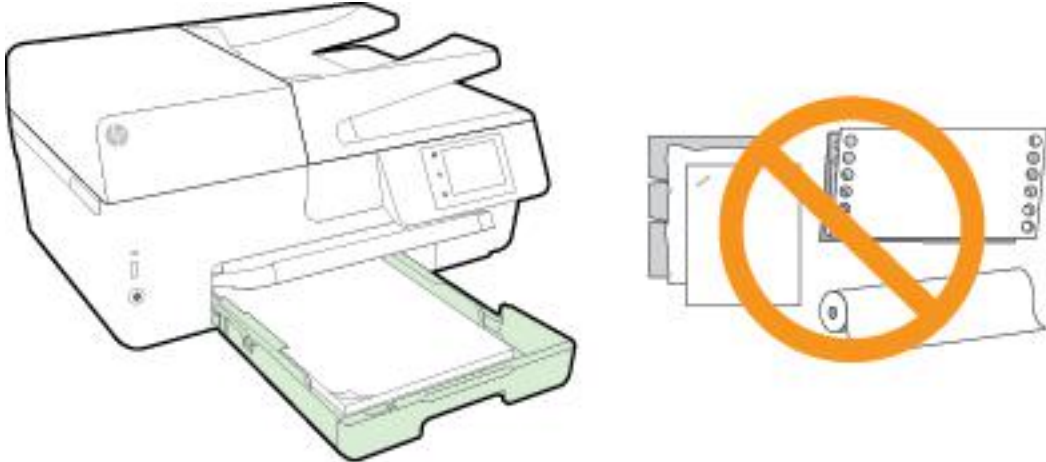

Ensure that the stack of paper is aligned with the appropriate paper size lines on the bottom of the input tray, and does not exceed the stack height marking on the side of the tray.

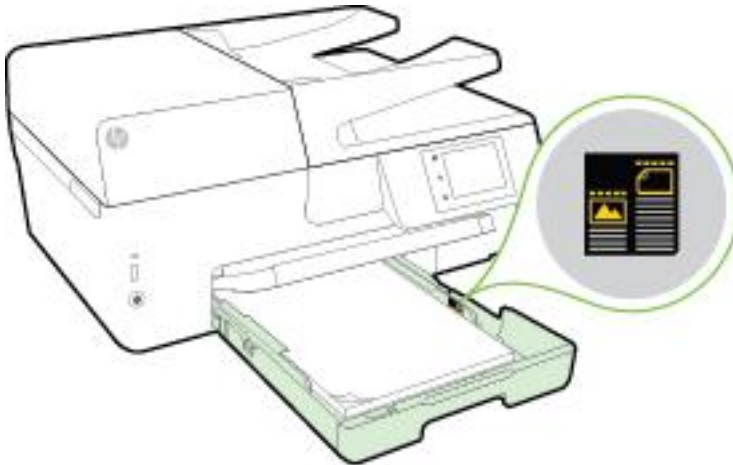

---

 **NOTE:** Do not load paper while the printer is printing.

5. Slide the paper-width guides in the tray until they touch the edge of the stack of paper, and then close the tray.

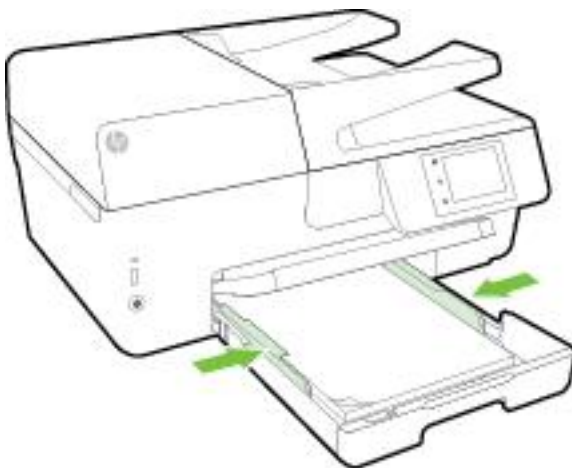



6. A message appears on the control panel display prompting you to change the paper setting if you have changed the media type, or retain the setting if you have replaced what was previously loaded.
7. Pull out the output tray extension.



### To load an envelope

1. Lift the output tray.

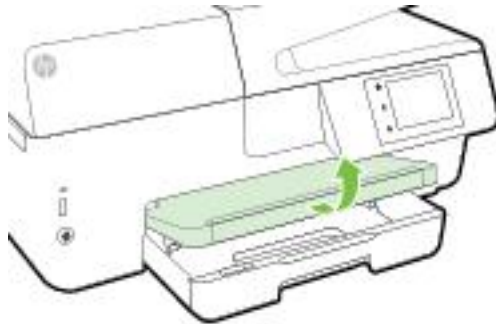

2. Pull out the input tray to extend it.



3. Insert the envelopes with the side you want to print on down, and load according to the graphic.

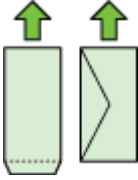

Ensure that the stack of paper is aligned with the appropriate paper size lines on the bottom of the input tray, and does not exceed the stack height marking on the side of the tray.

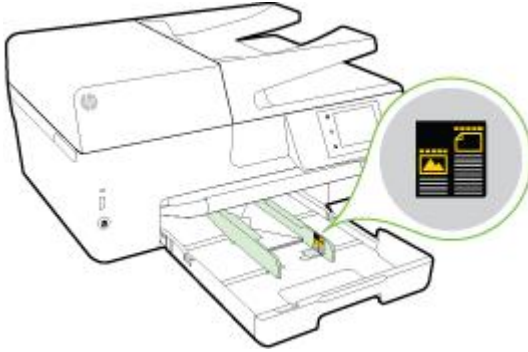

---

 **NOTE:** Do not load envelopes while the printer is printing.

---

4. Slide the paper-width guides in the tray until they touch the edge of the stack of envelopes, and then reinsert the tray.

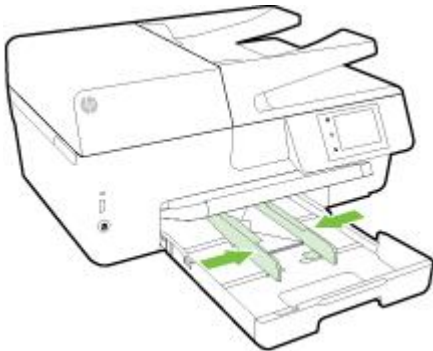

5. A message appears on the control panel display prompting you to change the paper setting if you have changed the media type, or retain the setting if you have replaced what was previously loaded.
6. Pull out the output tray extension.

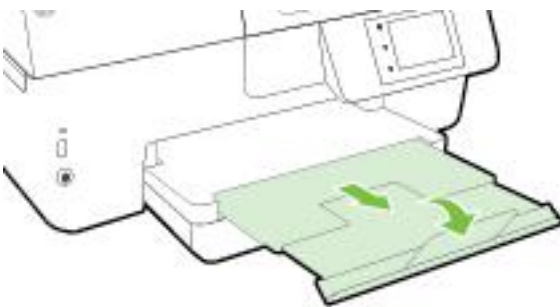

## To load cards and photo paper

1. Lift the output tray.

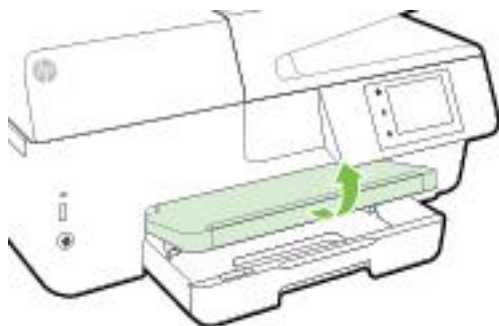

2. Pull out the input tray to extend it.



3. Insert the paper print-side down in the center of the tray.

Ensure that the stack of paper is aligned with the appropriate paper size lines on the bottom of the input tray, and does not exceed the stack height marking on the side of the tray.



 **NOTE:** Do not load paper while the printer is printing.

4. Slide the paper-width guides in the tray until they touch the edge of the stack of paper, and then close the tray.

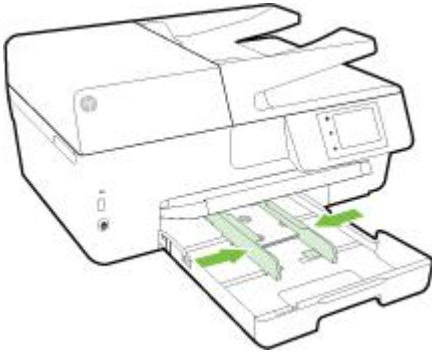

5. A message appears on the control panel display prompting you to change the paper setting if you have changed the media type, or retain the setting if you have replaced what was previously loaded.
6. Pull out the output tray extension.

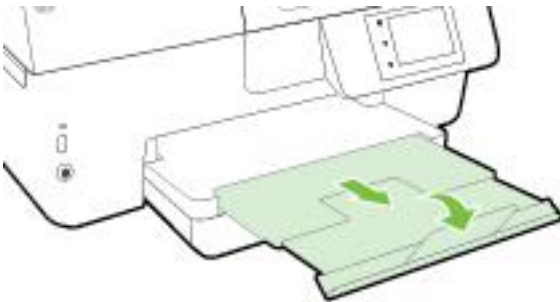

## Load an original on the scanner glass

You can copy, scan, or fax originals by loading them on the scanner glass.

---

 **NOTE:** Many of the special features do not work correctly if the scanner glass and lid backing are not clean. For more information, see [Maintain the printer](#).

---

 **NOTE:** Remove all originals from the document feeder tray before lifting the lid on the printer.

---

### To load an original on the scanner glass

1. Lift the scanner lid.

2. Load your original print-side down as shown in the following illustration.

---

 **TIP:** For more help on loading an original, refer to the engraved guides along the edge of the scanner glass.

---



3. Close the lid.

## Load an original in the document feeder

You can copy, scan, or fax a document by placing it in the document feeder.

The document feeder tray holds a maximum of 35 sheets of plain A4-, Letter-, or legal-size paper.

---

 **CAUTION:** Do not load photos in the document feeder; this might cause damage to your photos. Use only paper that is supported by the document feeder.

For more information, see [Tips for selecting and using paper](#).

 **NOTE:** Some features, such as the **Fit to Page** copy feature, do not work when you load your originals in the document feeder. For those features to work, load your originals on the scanner glass.

---

### To load an original in the document feeder

1. Load your original print-side up into the document feeder.
  - a. If you are loading an original printed in portrait orientation, place the pages so that the top edge of the document goes in first. If you are loading an original printed in landscape orientation, place the pages so that the left edge of the document goes in first.
  - b. Slide the paper into the document feeder until you hear a tone or see a message on the printer control panel display indicating that the loaded pages were detected.

---

 **TIP:** For more help on loading originals in the document feeder, refer to the diagram engraved in the document feeder tray.

---



2. Slide the paper-width guides inward until they stop at the left and right edges of the paper.

## Insert a USB flash drive

You can insert a USB flash drive into the port on the front of the printer. You can transfer files from the USB flash drive to your computer or scan files to the USB flash drive from the printer.

---

**CAUTION:** Do not remove the flash drive from the printer USB port while it is being accessed by the printer. This can damage the files on the USB flash drive. You can safely remove a USB flash drive only when the USB port light is not blinking.

---

The printer does not support encrypted USB flash drives.

## Update the printer

HP is always working to improve the performance of its printers and bring you the latest features.

By default, if the printer is connected to a network and Web Services has been enabled, the printer automatically checks for updates.

### To update the printer using the printer control panel

1. From the printer control panel display, touch **Setup** .
2. Touch **Printer Maintenance** .
3. Touch **Update the Printer** .

## To enable the printer to automatically check for updates

---

 **NOTE:** The default setting of **Auto Update** is **On** .

---

1. From the printer control panel display, touch  (HP ePrint).
2. Touch **OK** .
3. Touch **Settings** , and then touch **Update the Printer** .
4. Touch **Auto Update** and then touch **On** .

## To update the printer using the embedded web server

1. Open the EWS.  
For more information, see [Embedded web server](#).
2. Click the **Tools** tab.
3. In the **Printer Updates** section, click **Firmware Updates**, and then follow the on-screen instructions.

---

 **NOTE:** If a printer update is available, the printer downloads and installs the update, and then restarts.

 **NOTE:** If prompted for proxy settings and if your network uses proxy settings, follow the on-screen instructions to set up a proxy server. If you do not have the details, contact your network administrator or the person who set up the network.

---

## Open the HP printer software (Windows)

After installing the HP printer software, depending on your operating system, do one of the following:

- **Windows 8.1:** Click the down arrow in lower left corner of the Start screen, and then select the printer name.
- **Windows 8:** Right-click an empty area on the Start screen, click **All Apps** on the app bar, and then select the printer name.
- **Windows 7, Windows Vista, and Windows XP:** From the computer desktop, click **Start**, select **All Programs**, click **HP**, click the folder for the printer, and then select the icon with the printer's name.

## Turn the printer off

Turn the printer off by pressing  (the Power button) located on the front left side of the printer. The power light flashes while the printer shuts down. Wait until the power light turns off before unplugging the power cord or turning off a power strip.

---

 **CAUTION:** If you improperly turn the printer off, the print carriage might not return to the correct position, causing problems with the ink cartridges and print quality.

**CAUTION:** Never turn off the printer when ink cartridges are missing. HP recommends that you replace any missing cartridges as soon as possible to avoid print quality issues, possible extra ink usage from the remaining ink cartridges, or damage to the ink system.

---

---

## 3 Print

Most print settings are automatically handled by the software application. Change the settings manually only when you want to change print quality, print on specific types of paper, or use special features.

For more information about selecting the best print paper for your documents, see [Paper basics](#).

---

 **TIP:** This printer includes HP ePrint, a free service from HP that allows you to print documents on your HP ePrint-enabled printer anytime, from any location, without any additional software or printer drivers. For more information, see [HP ePrint](#).

**TIP:** You can use this printer to print documents and photos on your mobile device (such as a smartphone or tablet). For more information, visit the HP Mobile Printing website ( [www.hp.com/go/mobileprinting](http://www.hp.com/go/mobileprinting) ). (At this time, this website might not be available in all languages.)

---

- [Print documents](#)
- [Print brochures](#)
- [Print on envelopes](#)
- [Print photos](#)
- [Print on special and custom-size paper](#)
- [Print on both sides \(duplexing\)](#)
- [Print using the maximum dpi](#)
- [Tips for print success](#)
- [Print with AirPrint™](#)

### Print documents

#### To print documents (Windows)

1. Load paper in the tray. For more information, see [Load paper](#).
2. From your software, select **Print**.
3. Make sure your printer is selected.
4. Click the button that opens the **Properties** dialog box.

Depending on your software application, this button might be called **Properties**, **Options**, **Printer Setup**, **Printer Properties**, **Printer**, or **Preferences**.

---

 **NOTE:** To set print settings for all print jobs, make the changes in the HP software provided with the printer. For more information on the HP software, see [Printer management tools](#).

---

5. Select the appropriate options.



- On the **Layout** tab, select **Portrait** or **Landscape** orientation.
- On the **Paper/Quality** tab, select the appropriate paper type from the **Media** drop-down list in the **Tray Selection** area, and then select the appropriate print quality in the **Quality Settings** area.
- Click the **Advanced** button, in the **Paper/Output** area, select the appropriate paper size from the **Paper Size** drop-down list.



**NOTE:** If you change the **Paper Size** ensure that you have loaded the correct paper and set the paper size on the printer control panel to match.

For more printing options, see [Tips for print success](#).

6. Click **OK** to close the **Properties** dialog box.
7. Click **Print** or **OK** to begin printing.

### To print documents (OS X)

1. Load paper in the tray. For more information, see [Load paper](#).
2. From the **File** menu in your software, choose **Print**.
3. Make sure your printer is selected.
4. Specify the page properties.

If you do not see options on the Print dialog, click **Show Details**.



**NOTE:** The following options are available for your printer. Locations for the options can vary from one application to another.

- Choose the paper size.



**NOTE:** If you change the **Paper Size** ensure that you have loaded the correct paper and set the paper size on the printer control panel to match.

- Select the orientation.
  - Enter the scaling percentage.
5. Click **Print**.

## Print brochures

### To print brochures (Windows)

1. Load paper in the tray. For more information, see [Load paper](#).
2. On the **File** menu in your software application, click **Print**.
3. Make sure the printer you want to use is selected.
4. To change settings, click the button that opens the **Properties** dialog box.

Depending on your software application, this button might be called **Properties**, **Options**, **Printer Setup**, **Printer**, or **Preferences**.



**NOTE:** To set print settings for all print jobs, make the changes in the HP software provided with the printer. For more information on the HP software, see [Printer management tools](#).

5. Select the appropriate options.

- On the **Layout** tab, select **Portrait** or **Landscape** orientation.
- On the **Paper/Quality** tab, select the appropriate paper type from the **Media** drop-down list in the **Tray Selection** area, and then select the appropriate print quality in the **Quality Settings** area.
- Click the **Advanced** button, in the **Paper/Output** area, select the appropriate paper size from the **Paper Size** drop-down list.



---

**NOTE:** If you change the **Paper Size** ensure that you have loaded the correct paper and set the paper size on the printer control panel to match.

---

For more printing options, see [Tips for print success](#).

6. Click **OK**.
7. Click **Print** or **OK** to begin printing.

### To print brochures (OS X)

1. Load paper in the tray. For more information, see [Load paper](#).
2. From the **File** menu in your software application, click **Print**.
3. Make sure your printer is selected.

If you do not see options on the Print dialog, click **Show Details**.

4. Select a paper size from the pop-up menu.

If the **Paper Size** pop-up menu is not in the **Print** dialog, click the **Page Setup** button. When you are done selecting the paper size, click **OK** to close **Page Setup** and return to the **Print** dialog.



---

**NOTE:** If you change the **Paper Size** ensure that you have loaded the correct paper and set the paper size on the printer control panel to match.

---

5. Click **Paper Type/Quality** from the pop-up menu, and then select the following settings:
  - **Paper Type:** The appropriate brochure paper type
  - **Quality:** **Normal** or **Best**
6. Select any other print settings that you want, and then click **Print** to begin printing.

## Print on envelopes

Avoid envelopes with the following characteristics:

- Very slick finish
- Self-stick adhesives, clasps, or windows
- Thick, irregular, or curled edges
- Areas that are wrinkled, torn, or otherwise damaged

Make sure the folds of envelopes you load in the printer are sharply creased.



---

**NOTE:** For more information about printing on envelopes, see the documentation available with the software program you are using.

---

## To print envelopes (Windows)

1. Load envelopes in the tray. For more information, see [Load paper](#).
2. On the **File** menu in your software, click **Print**.
3. Make sure your printer is selected.
4. Click the button that opens the **Properties** dialog box.

Depending on your software application, this button might be called **Properties, Options, Printer Setup, Printer Properties, Printer,** or **Preferences**.



---

**NOTE:** To set print settings for all print jobs, make the changes in the HP software provided with the printer. For more information on the HP software, see [Printer management tools](#).

---

5. Select the appropriate options.
  - On the **Layout** tab, select **Portrait** or **Landscape** orientation.
  - On the **Paper/Quality** tab, select the appropriate paper type from the **Media** drop-down list in the **Tray Selection** area, and then select the appropriate print quality in the **Quality Settings** area.
  - Click the **Advanced** button, in the **Paper/Output** area, select the appropriate paper size from the **Paper Size** drop-down list.



---

**NOTE:** If you change the **Paper Size**, ensure that you load the correct paper into the printer, and set the paper size on the printer control panel to match.

---

For more printing options, see [Tips for print success](#).

6. Click **OK**, and then click **Print** or **OK** in the **Print** dialog box.

## To print envelopes (OS X)

1. Load envelopes print-side down in the tray. For more information, see [Load paper](#).
2. From the **File** menu in your software, choose **Print**.
3. Make sure your printer is selected.
4. Set the print options.

If you do not see options on the Print dialog, click **Show Details**.



---

**NOTE:** The following options are available for your printer. Locations for the options can vary from one application to another.

---

- a. Select the appropriate envelope size from the **Paper Size** pop-up menu.



---

**NOTE:** If you change the **Paper Size** ensure that you have loaded the correct paper and set the paper size on the printer control panel to match.

---

- b. From the pop-up menu, choose **Paper Type/Quality**, and verify the paper type setting is set to **Plain Paper**.

5. Click **Print**.

## Print photos

Do not leave unused photo paper in the input tray. The paper might start to curl, which could impair the quality of your printout. Photo paper should be flat before printing.



---

**TIP:** You can use this printer to print documents and photos on your mobile device (such as a smartphone or tablet). For more information, visit the HP Mobile Printing website ( [www.hp.com/go/mobileprinting](http://www.hp.com/go/mobileprinting) ). (At this time, this website might not be available in all languages.)

---

### To print a photo from the computer (Windows)

1. Load paper in the tray. For more information, see [Load paper](#).
2. From your software, select **Print**.
3. Make sure your printer is selected.
4. Click the button that opens the **Properties** dialog box.

Depending on your software application, this button might be called **Properties**, **Options**, **Printer Setup**, **Printer Properties**, **Printer**, or **Preferences**.

5. Select the appropriate options.
  - On the **Layout** tab, select **Portrait** or **Landscape** orientation.
  - On the **Paper/Quality** tab, select the appropriate paper type from the **Media** drop-down list in the **Tray Selection** area, and then select the appropriate print quality in the **Quality Settings** area.
  - Click the **Advanced** button, in the **Paper/Output** area, select the appropriate paper size from the **Paper Size** drop-down list.



---

**NOTE:** If you change the **Paper Size**, ensure that you have loaded the correct paper and set the paper size on the printer control panel to match.

---

For more printing options, see [Tips for print success](#).



---

**NOTE:** For maximum dpi resolution, go to **Paper/Quality** tab, select **Photo Paper** from the **Media** drop-down list, and then click the **Advanced** button and select **Yes** from the **Print in Max DPI** drop-down list. If you want to print max DPI in grayscale, select **High Quality Grayscale** from the **Print in Grayscale** drop-down list.

---

6. Click **OK** to return to the **Properties** dialog box.
7. Click **OK**, and then click **Print** or **OK** in the **Print** dialog box.



---

**NOTE:** After the printing is finished, remove unused photo paper from the input tray. Store the photo paper so it does not start to curl, which could reduce the quality of your printout.

---

### To print a photo from the computer (OS X)

1. Load paper in the tray. For more information, see [Load paper](#).
2. From the **File** menu in your software, choose **Print**.
3. Make sure your printer is selected.
4. Set the print options.

If you do not see options on the Print dialog, click **Show Details**.



---

**NOTE:** The following options are available for your printer. Locations for the options can vary from one application to another.

---

- a. Choose the appropriate paper size in the **Paper Size** pop-up menu.



---

**NOTE:** If you change the **Paper Size** ensure that you have loaded the correct paper and set the paper size on the printer control panel to match.

---

- b. Select an **Orientation**.
- c. From the pop-up menu, choose **Paper Type/Quality**, and then choose the following settings:
  - **Paper Type:** The appropriate photo paper type
  - **Quality: Best or Maximum dpi**
  - Click the **Color Options** disclosure triangle, and then choose the appropriate **Photo Fix** option.
    - **Off:** applies no changes to the image.
    - **Basic:** automatically focuses the image; moderately adjusts image sharpness.
5. Select any other print settings you want, and then click **Print**.

### To print photos from a USB flash drive

You can connect a USB flash drive (such as a keychain drive) to the USB port on the front of the printer.



For more information about using memory devices, see [Insert a USB flash drive](#).



---

**CAUTION:** Do not remove the flash drive from the printer USB port while it is being accessed by the printer. This can damage the files on the USB flash drive. You can safely remove a USB flash drive only when the USB port light is not blinking.

---

1. Insert a USB flash drive into the front USB port.
2. From the control panel display, touch **Print Photos**.
3. From the control panel display, touch **View and Print** to display photos.
4. On the printer display, select a photo that you want to print and touch **Continue**.
5. Scroll up or down to specify the number of photos to print.
6. Touch  (**Edit**) to select options to edit the selected photos. You can rotate, crop a photo, or turn **Photo Fix** or **Red Eye Removal** on and off.
7. Touch **Done** and touch **Continue** to preview the selected photo. If you wish to adjust layout or paper type, touch  (**Settings**), and then touch your selection. You can also save any new settings as defaults.
8. Touch **Print** to begin printing.

## Print on special and custom-size paper

If your application supports custom-size paper, set the size in the application before printing the document. If not, set the size in the printer driver. You might need to reformat existing documents to print them correctly on custom-size paper.

### To set up custom sizes (Windows)

1. Depending on your operating system, do one of the following:

- **Windows 8.1 and Windows 8:** Point to or tap the upper-right corner of the screen to open the Charms bar, click the **Settings** icon, click or tap **Control Panel**, and then click or tap **View devices and printers**. Click or tap the printer name, and click or tap **Print server properties**.
  - **Windows 7:** From the Windows **Start** menu, click **Devices and Printers**. Select the printer name, and select **Print server properties**.
  - **Windows Vista:** From the Windows **Start** menu, click **Control Panel**, and then click **Printers**. Right-click an empty area in the **Printers** window, and select **Server Properties**.
  - **Windows XP:** From the Windows **Start** menu, click **Control Panel**, and then click **Printers and Faxes**. From the **File** menu, click **Server Properties**.
2. Select the **Create a new form** check box.
  3. Enter the name of the custom size paper.
  4. Enter the dimensions of the custom size in the **Form description (measurements)** section.
  5. Click **Save Form**, and then click **Close**.

### To print on special or custom-size paper (Windows)



**NOTE:** Before you can print on custom-size paper, you must set up the custom size in the Print Server Properties.

1. Load the appropriate paper in the tray. For more information, see [Load paper](#).
2. From the **File** menu in your software application, click **Print**.
3. Make sure your printer is selected.
4. Click the button that opens the **Properties** dialog box.

Depending on your software application, this button might be called **Properties**, **Options**, **Printer Setup**, **Printer Properties**, **Printer**, or **Preferences**.



**NOTE:** To set print settings for all print jobs, make the changes in the HP software provided with the printer. For more information on the HP software, see [Printer management tools](#).

5. On the **Layout** tab or **Paper/Quality** tab, click the **Advanced** button.
6. In the **Paper/Output** area, select the custom size from the **Paper Size** drop-down list.



**NOTE:** If you change the **Paper Size** ensure that you have loaded the correct paper and set the paper size on the printer control panel to match.

7. Select any other print settings that you want, and then click **OK**.
8. Click **Print** or **OK** to begin printing.

### To set up custom sizes (OS X)

1. Depending on your operating system, do one of the following:

- From the **File** menu in your software application, click **Page Setup**, and then make sure the printer you want to use is selected in the **Format For** pop-up menu.
  - From the **File** menu in your software application, click **Print**, and then make sure the printer you want to use is selected.
2. Select **Manage Custom Sizes** in the **Paper Size** pop-up menu.



---

**NOTE:** If you do not see these options in the **Print** dialog, click the disclosure triangle next to the **Printer** pop-up menu or click **Show Details**.

---

3. Click the **+** on the left side of the screen, double-click **Untitled**, and type a name for the new custom size.
4. In the **Width** and **Height** boxes, type the dimensions, and then set the margins, if you want to customize them.
5. Click **OK**.

### To print on special or custom-size paper (OS X)

Before you can print on custom-size paper, you must set up the custom size in the the HP software.

1. Load the appropriate paper in the tray. For more information, see [Load paper](#).
2. From the **File** menu in your software application, click **Print**.
3. Make sure your printer is selected.

If you do not see options on the Print dialog, click **Show Details**.

4. Select a paper size from the pop-up menu.

If the **Paper Size** pop-up menu is not in the **Print** dialog, click the **Page Setup** button. When you are done selecting the paper size, click **OK** to close **Page Setup** and return to the **Print** dialog.



---

**NOTE:** If you change the **Paper Size** ensure that you have loaded the correct paper and set the paper size on the printer control panel to match.

---

5. Click **Paper Handling** from the pop-up menu.
6. Under **Destination Paper Size**, click **Scale to fit paper size**.
7. Select any other print settings that you want, and then click **Print** to begin printing.



---

**NOTE:** Software and system requirements can be found in the Readme file, which is available on the HP printer software CD provided with your printer.

---

## Print on both sides (duplexing)

You can print on both sides of a sheet of paper automatically by using the automatic two-sided printing mechanism (duplexer).

### To print on both sides of the page (Windows)

1. From your software, select **Print**.
2. Make sure your printer is selected.

3. Click the button that opens the **Properties** dialog box.

Depending on your software application, this button might be called **Properties, Options, Printer Setup, Printer Properties, Printer,** or **Preferences.**



---

**NOTE:** To set print settings for all print jobs, make the changes in the HP software provided with the printer. For more information on the HP software, see [Printer management tools](#).

---

4. Select the appropriate options.

- On the **Layout** tab, select **Portrait** or **Landscape** orientation, and select **Flip on Long Edge** or **Flip on Short Edge** from the **Print on Both Sides** drop-down list.
- On the **Paper/Quality** tab, select the appropriate paper type from the **Media** drop-down list in the **Tray Selection** area, and then select the appropriate print quality in the **Quality Settings** area.
- Click the **Advanced** button, in the **Paper/Output** area, select the appropriate paper size from the **Paper Size** drop-down list.



---

**NOTE:** If you change the **Paper Size** ensure that you have loaded the correct paper and set the paper size on the printer control panel to match.

---

For more printing options, see [Tips for print success](#).

5. Click **OK** to print.

### To print on both sides of the paper (OS X)

1. From the **File** menu in your software, choose **Print**.
2. In the Print dialog, choose **Layout** from the pop-up menu.
3. Choose the type of binding you want for your two-sided pages, and then click **Print**.

## Print using the maximum dpi

Use the maximum dots per inch (dpi) mode to print high-quality, sharp images on photo paper.

Printing in maximum dpi takes longer than printing with other settings and requires a large amount of memory.

### To print in maximum dpi mode (Windows)

1. From your software, select **Print**.
2. Make sure your printer is selected.
3. Click the button that opens the **Properties** dialog box.

Depending on your software application, this button might be called **Properties, Options, Printer Setup, Printer Properties, Printer,** or **Preferences.**



---

**NOTE:** To set print settings for all print jobs, make the changes in the HP software provided with the printer. For more information on the HP software, see [Printer management tools](#).

---

4. Click the **Paper/Quality** tab.
5. From the **Media** drop-down list, select an appropriate paper type.
6. Click the **Advanced** button.
7. In the **Printer Features** area, select **Yes** from the **Print in Max DPI** drop-down list.



8. Select the appropriate paper size from the **Paper Size** drop-down list.

---

 **NOTE:** If you change the **Paper Size** ensure that you have loaded the correct paper and set the paper size on the printer control panel to match.

---

9. Click **OK** to close the advanced options.
10. Confirm **Orientation** on the **Layout** tab, and then click **OK** to print.

### To print using maximum dpi (OS X)

1. From the **File** menu in your software, choose **Print**.
2. Make sure your printer is selected.
3. Set the print options.

If you do not see options on the Print dialog, click **Show Details**.

---

 **NOTE:** The following options are available for your printer. Locations for the options can vary from one application to another.

---

- a. Choose the appropriate paper size in the **Paper Size** pop-up menu.

---

 **NOTE:** If you change the **Paper Size** ensure that you have loaded the correct paper and set the paper size on the printer control panel to match.

---

- b. From the pop-up menu, choose **Paper Type/Quality**, and then choose the following settings:
  - **Paper Type:** The appropriate paper type
  - **Quality: Maximum dpi**

4. Select any other print settings that you want, and then click **Print**.

## Tips for print success

Software settings selected in the print driver only apply to printing, they do not apply to copying or scanning.

You can print your document on both sides of the paper. For more information, see [Print on both sides \(duplexing\)](#).

### Ink tips

- If the print quality is not acceptable, see [Solve printing problems](#) for more information.
- Use Original HP ink cartridges.

Original HP ink cartridges are designed and tested with HP printers and papers to help you easily produce great results, time after time.

---

 **NOTE:** HP cannot guarantee the quality or reliability of non-HP supplies. Product service or repairs required as a result of using a non-HP supply will not be covered under warranty.

---

If you believe you purchased Original HP ink cartridges, go to [www.hp.com/go/anticounterfeit](http://www.hp.com/go/anticounterfeit).

---

- Install both the black and color cartridges correctly.  
For more information, see [Replace the ink cartridges](#).
- Check the estimated ink levels in the cartridges to make sure there is sufficient ink.  
Ink level warnings and indicators provide estimates for planning purposes only.

For more information, see [Check the estimated ink levels](#).



**NOTE:** When you receive a low-ink warning message, consider having a replacement cartridge available to avoid possible printing delays. You do not need to replace the cartridges until print quality becomes unacceptable.

- Always turn off the printer with  (the Power button) to allow the printer to protect the nozzles.

### Paper loading tips

For more information, also see [Load paper](#).

- Ensure the paper is loaded in the tray properly, and matches the currently set paper size for the printer. Upon closing the tray you should be prompted to confirm or set the paper size. For more information, see [Load paper](#).
- Load a stack of paper (not just one page). All the paper in the stack should be of the same size and type to avoid a paper jam.
- Load paper with the print-side down.
- Ensure that paper loaded in the input tray lays flat and the edges are not bent or torn.
- Adjust the paper-width guides in the input tray to fit snugly against all paper. Make sure the guides do not bend the paper in the tray.

### Printer settings tips (Windows)

- To change default print settings, click **Print, Scan & Fax**, and then click **Set Preferences** in the HP printer software.

Depending on your operating system, do one of the following to open the printer software:

- **Windows 8.1:** Click the down arrow in lower left corner of the Start screen, and then select the printer name.
- **Windows 8:** Right-click an empty area on the Start screen, click **All Apps** on the app bar, and then select the printer name.
- **Windows 7, Windows Vista, and Windows XP:** From the computer desktop, click **Start**, select **All Programs**, click **HP**, click the folder for the printer, and then select the icon with the printer's name.
- To select the number of pages to print per sheet, on the **Layout** tab of the printer driver, select the appropriate option from the **Pages per Sheet** drop-down list.
- If you want to change the page orientation, set it in your application interface.
- To view more printing settings, on the **Layout** or **Paper/Quality** tab of the printer driver, click the **Advanced** button to open the **Advanced Options** dialog box.



**NOTE:** The preview on the **Layout** tab cannot reflect what you select from the **Pages per Sheet Layout**, the **Booklet**, or the **Page Borders** drop-down lists.

- **Print in Grayscale:** Allows you to print a black and white document using the black ink only. Select **Black Ink Only**, and then click the **OK** button.
- **Pages per Sheet Layout:** Helps you specify the order of the pages if you print document in more than two pages per sheet.
- **Borderless Printing:** Select this feature to print photos without border. Not all paper types support this feature. You will see an alert icon beside the option if the selected paper type in the **Media** drop-down list does not support it.

- **Preserve Layout:** This feature only works with the duplex printing. If the image is larger than the printable area, select this feature to scale the page content to be within the smaller margins so that extra pages are not created.
- **HP Real Life Technologies:** This feature smooths and sharpens images and graphics for improved print quality.
- **Booklet:** Allows you to print a multiple-page document as a booklet. It places two pages on each side of a sheet that can then be folded into a booklet in half size of the paper. Select a binding method from the drop-down list, and then click **OK**.
  - **Booklet-LeftBinding:** The binding side after folded into a booklet appears at the left side. Select the option if your reading habit is from left to right.
  - **Booklet-RightBinding:** The binding side after folded into a booklet appears at the right side. Select the option if your reading habit is from right to left.
- **Page Borders:** Allows you to add the borders to the pages if you print the document with two or more pages per sheet.
- You can use printing shortcut to save time setting printing preferences. A printing shortcut stores the setting values that are appropriate for a particular kind of job, so that you can set all the options with a single click. To use it, go to the **Printing Shortcut** tab, select one printing shortcut, and then click **OK**.

To add a new printing shortcut, after making settings on the **Layout** or **Paper/Quality** tab, click the **Printing Shortcut** tab, click **Save As** and enter a name, and then click **OK**.

To delete a printing shortcut, select it, and then click **Delete**.



**NOTE:** You cannot delete the default printing shortcuts.

---

### Printer settings tips (OS X)

- On the Print dialog, use the **Paper Size** pop-up menu to select the size of paper loaded in the printer.
- On the Print dialog, choose the **Paper Type/Quality** pop-up menu and select the appropriate paper type and quality.
- To print a black and white document using only black ink, choose the **Paper Type/Quality** from the pop-up menu. Then click the Color Options disclosure triangle and choose **Grayscale** from the Color pop-up menu and select **Black Print Cartridge Only**.

### Notes

- Original HP ink cartridges are designed and tested with HP printers and papers to help you easily produce great results, time after time.



**NOTE:** HP cannot guarantee the quality or reliability of non-HP supplies. Product service or repairs required as a result of using a non-HP supply will not be covered under warranty.

If you believe you purchased Original HP ink cartridges, go to [www.hp.com/go/anticounterfeit](http://www.hp.com/go/anticounterfeit).

---

- Ink level warnings and indicators provide estimates for planning purposes only.



**NOTE:** When you receive a low-ink warning message, consider having a replacement cartridge available to avoid possible printing delays. You do not need to replace the cartridges until print quality becomes unacceptable.

---

## Print with AirPrint™

Printing using Apple's AirPrint is supported for iOS 4.2 and Mac OS X 10.7 or later. Use AirPrint to print wirelessly to the printer from an iPad (iOS 4.2), iPhone (3GS or later), or iPod touch (third generation or later) in the following mobile applications:

- Mail
- Photos
- Safari
- Supported third-party applications, for example Evernote

To use AirPrint, ensure the following:

- The printer must be connected to the same network as your AirPrint enabled device. For more information about using AirPrint and about which HP products are compatible with AirPrint, go to [www.hp.com/go/mobileprinting](http://www.hp.com/go/mobileprinting) .
- Load paper that matches the paper settings of the printer (see [Load paper](#) for more information). Accurately setting the paper size for the paper that is loaded, enables a mobile device to know what paper size it is printing.

---

## 4 Copy and scan



- [Copy](#)
- [Scan](#)

### Copy

#### To copy documents

1. Make sure you have paper loaded in the main tray. For more information, see [Load paper](#).
2. Place your original print-side down on the scanner glass or print-side up in the document feeder.  
For more information, see [Load an original on the scanner glass](#) or [Load an original in the document feeder](#).
3. From the printer control panel display, touch **Copy**.
4. Scroll up or down to select the number of copies.

---

 **TIP:** To save these settings as defaults for future jobs, from the printer control panel display, touch **Copy**, touch  (**Copy Settings**), and then touch **Save Current Settings**.

---
5. Touch **Black** or **Color** to start the copy job.

#### Copy settings

You can customize copy jobs using the various settings available from the printer control panel.

In the **Copy** menu, touch  (**Copy Settings**) and change the desired settings.

- Two-Sided
- ID Card Copy
- Quality
- Lighter/Darker
- Resize
- Collate
- Margin Shift
- Enhancements
- Save Current Settings
- Restore Settings

### Scan

You can scan documents, photos, and other paper types, and send them to a variety of destinations, such as a computer or an email recipient.

When scanning documents with the HP printer software, you can scan to a format that can be searched and edited.

When scanning a borderless original, use the scanner glass and not the document feeder.



**NOTE:** Some scan functions are only available after you have installed the HP printer software.



**TIP:** If you have problems scanning documents, see [Solve scan problems](#).

- [Scan to a computer](#)
- [Scan to a memory device](#)
- [Scan to Email](#)
- [Scan using Webscan](#)
- [Scanning documents as editable text](#)

## Scan to a computer

Before scanning to a computer, make sure you have already installed the HP recommended printer software. The printer and computer must be connected and turned on.

In addition, on Windows computers, the printer software must be running prior to scanning.

You can use the HP printer software to scan documents into editable text. For more information, see [Scanning documents as editable text](#).

### To enable the scan to a computer feature (Windows)

The scan to a computer feature is enabled by default from the factory. Follow these instructions if the feature has been disabled, and you wish to enable it again (either using an Ethernet cable or wireless connection).

1. Open the HP printer software.
2. Go to the **Scan** section.
3. Select **Manage Scan to Computer**.
4. Click **Enable**.

### To enable the scan to a computer feature (OS X)

The scan to a computer feature is enabled by default from the factory. Follow these instructions if the feature has been disabled, and you wish to enable it again.

1. Open HP Utility.
2. Under **Scan Settings**, click **Scan to Computer**.
3. Ensure that **Enable Scan to Computer** is selected.

### To scan an original from the printer control panel

1. Load your original print-side down on the scanner glass or print-side up in the document feeder.  
For more information, see [Load an original on the scanner glass](#) or [Load an original in the document feeder](#).
2. Touch **Scan**, and then select **Computer**.
3. Touch a computer that you want to scan to.

4. Choose the type of scan profile you want.
5. Touch **Start Scan**.

#### To scan an original from HP printer software (Windows)

1. Load your original print-side down on the scanner glass or print-side up in the document feeder.  
For more information, see [Load an original on the scanner glass](#) or [Load an original in the document feeder](#).
  2. Depending on your operating system, do one of the following:
    - **Windows 8.1:** Click the down arrow in lower left corner of the Start screen, and then select the printer name.
    - **Windows 8:** Right-click an empty area on the Start screen, click **All Apps** on the app bar, and then select the printer name.
    - **Windows 7, Windows Vista, and Windows XP:** From the computer desktop, click **Start**, select **All Programs**, click **HP**, click the folder for the printer, and then select the icon with the printer's name.
  3. Click the **Print, Scan & Fax** icon, and then select **Scan a Document or Photo**.
  4. Select the type of scan that you want from the shortcut menu and then click **Scan**.
- 
-  **NOTE:** If **Show Scan Preview** is selected, you will be able to make adjustments to the scanned image in the preview screen.
- 
5. Select **Save** if you want to keep the application open for another scan, or select **Done** to exit the application.

After the scan is saved, Windows Explorer will open the directory where the scan was saved.

#### To scan an original from HP printer software (OS X)

1. Open HP Scan.  
HP Scan is located in the **Applications/Hewlett-Packard** folder at the top level of the hard disk.
2. Click **Scan**.
3. Choose the type of scan profile you want and follow the on-screen instructions.

## Scan to a memory device

You can scan directly to a USB flash drive from the printer control panel without using a computer or the HP printer software provided with the printer.

---

 **NOTE:** You can also use the HP printer software to scan documents into editable text. For more information, see [Scanning documents as editable text](#).

---

#### To scan an original to a memory device from the printer control panel

1. Load your original print-side down on the scanner glass or print-side up in the document feeder.  
For more information, see [Load an original on the scanner glass](#) or [Load an original in the document feeder](#).
2. Insert a USB flash drive. For more information, see [Insert a USB flash drive](#).
3. Touch **Scan**, and then select **Memory Device**.

4. Make changes to scan options, if needed.
5. Touch **Start Scan**.

## Scan to Email

The Scan-to-Email App is an application that allows you to quickly scan and email photos or documents to the specified recipients directly from your HP e-All-in-One printer. You can set up your email addresses, log in to your accounts with the given PIN codes, and then scan and email your documents.

This section contains the following topics:

- [Set up Scan to Email](#)
- [Use Scan to Email](#)
- [Change account settings](#)

### Set up Scan to Email

#### To set up Scan to Email

1. Enable Web Services on the printer. For more information, see [Set up Web Services](#).
2. Touch **Scan**, and then touch **Email**.
3. On the **Welcome** screen, touch **Continue**.
4. Touch in the **Email:** box to enter your email address, and then touch **Done**.
5. Touch **Continue**.
6. A PIN will be sent to the email address you entered. Touch **Continue**.
7. Touch the **PIN** to enter your PIN and then touch **Done**.
8. Touch **Store Email** or **Auto-login**, depending upon how you want the printer to store your login information.
9. Select your scan type by touching **Photo** or **Document**.
10. For photos, select the scan settings, and touch **Continue**.  
For documents, continue with the next step.
11. Verify the email information, and touch **Continue**.
12. Touch **Scan to Email**.
13. Touch **OK** when the scan completes, and then touch **Yes** to send another email, or **No** to finish.

### Use Scan to Email

#### To use Scan to Email

1. Load your original print-side down on the scanner glass or print-side up in the document feeder. For more information, see [Load an original on the scanner glass](#) or [Load an original in the document feeder](#).
2. Touch **Scan**, and then touch **Email**.
3. On the control panel display, select the account that you want to use, and touch **Continue**.



**NOTE:** Select **My account is not listed** if you do not have an account. You will be prompted to enter your email address and receive a PIN.



4. If prompted, enter the PIN.
5. Select your scan type by touching **Photo** or **Document**.
6. For photos, select the scan settings, and touch **Continue**.  
For documents, continue with the next step.
7. To add or remove recipients, touch **Modify Recipient(s)**, and when finished touch **Done**.
8. Verify the email information and touch **Continue**.
9. Touch **Scan to Email**.
10. Touch **OK** when the scan completes, and then touch **Yes** to send another email, or **No** to finish.

## Change account settings

### To change account settings

1. Touch **Scan**, and then touch **Email**.
2. On the control panel display, select the account that you want to change, and touch **Modify**.
3. Select which setting you want to modify, and follow the onscreen prompts..
  - Auto-login
  - Store Email
  - Remove from list
  - Change PIN
  - Delete Account

## Scan using Webscan

Webscan is a feature of the embedded web server that lets you scan photos and documents from your printer to your computer using a web browser.

This feature is available even if you did not install the printer software on your computer.

For more information, see [Embedded web server](#).



**NOTE:** By default, Webscan is off. You can enable this feature from the EWS.

If you are unable to open Webscan in the EWS, your network administrator might have turned it off. For more information, contact your network administrator or the person who set up your network.

---

### To enable Webscan

1. Open the embedded web server. For more information, see [Embedded web server](#).
2. Click the **Settings** tab.
3. In the **Security** section, click **Administrator Settings**.
4. Select **Webscan** to enable Webscan.
5. Click **Apply** and then click **OK**.

## To scan using Webscan

Scanning using Webscan offers basic scan options. For additional scan options or functionality, scan from the HP printer software.

1. Load your original print-side down on the scanner glass or print-side up in the document feeder.  
For more information, see [Load an original on the scanner glass](#) or [Load an original in the document feeder](#).
2. Open the embedded web server. For more information, see [Embedded web server](#).
3. Click the **Scan** tab.
4. Click **Webscan** in the left pane, change any settings, and then click **Start Scan**.

---

 **TIP:** To scan documents as editable text, you must install the HP software included with the printer. For more information, see [Scanning documents as editable text](#).

---

## Scanning documents as editable text

When scanning documents, you can use the HP software to scan documents into a format that you can search, copy, paste, and edit. This allows you to edit letters, newspaper clippings, and many other documents.

- [Scan documents as editable text](#)
- [Guidelines for scanning documents as editable text](#)

## Scan documents as editable text

Use the following guidelines for scanning documents as editable text.

### To scan documents as editable text (Windows)

1. Load your original print-side down on the scanner glass or print-side up in the document feeder.  
For more information, see [Load an original on the scanner glass](#) or [Load an original in the document feeder](#).
2. Depending on your operating system, do one of the following:
  - **Windows 8.1:** Click the down arrow in lower left corner of the Start screen, and then select the printer name.
  - **Windows 8:** Right-click an empty area on the Start screen, click **All Apps** on the app bar, and then select the printer name.
  - **Windows 7, Windows Vista, and Windows XP:** From the computer desktop, click **Start**, select **All Programs**, click **HP**, click the folder for the printer, and then select the icon with the printer's name.
3. Click the **Print, Scan & Fax** icon, and then select **Scan a Document or Photo**.
4. Select the type of editable text you want to use in the scan:

---

I want to...	Follow these steps
Extract just the text, without any of the formatting of the original	Select the <b>Save as Editable Text (OCR)</b> shortcut from the list, and then select <b>Text (.txt)</b> from the <b>File Type</b> drop-down menu.

---

Extract the text, as well as some of the formatting of the original	Select the <b>Save as Editable Text (OCR)</b> shortcut from the list, and then select <b>Rich Text (.rtf)</b> from the <b>File Type</b> drop-down menu.
Extract the text and make it searchable in PDF readers	Select the <b>Save as PDF</b> shortcut from the list, and then select <b>Searchable PDF (.pdf)</b> from the <b>File Type</b> drop-down menu.

5. Click **Scan** and follow the on-screen instructions.

### To scan documents as editable text (OS X)

1. Load your original print-side down on the scanner glass or print-side up in the document feeder.  
For more information, see [Load an original on the scanner glass](#) or [Load an original in the document feeder](#).
2. Open HP Scan.  
HP Scan is located in the **Applications/Hewlett-Packard** folder at the top level of the hard disk.
3. Click the **Scan** button. A dialog appears requesting confirmation of your scanning device and the scan settings preset.
4. Follow the on-screen instructions to complete the scan.
5. When all of the pages have been scanned, select **Save** from the **File** menu. The Save dialog appears.
6. Select the type of editable text.

I want to...	Follow these steps
Extract just the text, without any of the formatting of the original	Select <b>TXT</b> from the <b>Format</b> pop-up menu.
Extract the text, as well as some of the formatting of the original	Select <b>RTF</b> from the <b>Format</b> pop-up menu.
Extract the text and make it searchable in PDF readers	Select <b>Searchable PDF</b> from the <b>Format</b> pop-up menu.

7. Click **Save**.

### Guidelines for scanning documents as editable text

To ensure that the software can convert your documents successfully, do the following:

- **Make sure the scanner glass or document feeder window is clean.**  
When the printer scans the document, smudges or dust on the scanner glass or document feeder window can be scanned, as well, and can prevent the software from converting the document to editable text.
- **Make sure the document is loaded correctly.**  
Make sure the original is properly loaded and that the document is not skewed. For more information, see [Load an original on the scanner glass](#) or [Load an original in the document feeder](#).
- **Make sure the text on the document is clear.**  
To successfully convert the document to editable text, the original must be clear and of high quality. The following conditions can cause the software to not convert the document successfully:

- The text on the original is faint or wrinkled.
- The text is too small.
- The structure of the document is too complex.
- The text is tightly spaced. For example, if the text that the software converts has missing or combined characters, "rn" might appear as "m."
- The text is on a colored background. Colored backgrounds can cause images in the foreground to blend too much.

- **Choose the correct profile.**

Be sure to select a shortcut or preset that allows scanning as editable text. These options use scan settings designed to maximize the quality of your OCR scan.

**Windows:** Use the **Editable Text (OCR)** or **Save as PDF** shortcuts.

**OS X:** Use the **Documents** preset.

- **Save your file in the correct format.**

If you want to extract just the text from the document, without any of the formatting of the original, select a plain text format, such as **Text (.txt)** or **TXT**.

If you want to extract the text, as well as some of the formatting of the original, select Rich Text Format, such as **Rich Text (.rtf)** or **RTF**, or searchable PDF format, such as **Searchable PDF (.pdf)** or **Searchable PDF**.

---

# 5 Fax

You can use the printer to send and receive faxes, including color faxes. You can schedule faxes to be sent at a later time and set up phone book contacts to send faxes quickly and easily to frequently used numbers. From the printer control panel, you can also set a number of fax options, such as resolution and the contrast between lightness and darkness on the faxes you send.

---

 **NOTE:** Before you begin faxing, make sure you have set up the printer correctly for faxing. You can verify the fax is set up correctly by running the fax setup test from the printer control panel.

Learn more about fax setup and test, [click here to go online for more information](#).

---

- [Send a fax](#)
- [Receive a fax](#)
- [Set up phone book contacts](#)
- [Change fax settings](#)
- [Fax and digital phone services](#)
- [Fax over Internet Protocol](#)
- [Use reports](#)

## Send a fax

You can send a fax in a variety of ways, depending on your situation or need.

- [Send a standard fax](#)
- [Send a standard fax from the computer](#)
- [Send a fax from a phone](#)
- [Send a fax using monitor dialing](#)
- [Send a fax from memory](#)
- [Send a fax to multiple recipients](#)
- [Send a fax in Error Correction Mode](#)

## Send a standard fax

You can easily send a single- or multiple-page black-and-white or color fax by using the printer control panel.

---

 **NOTE:** If you need printed confirmation that your faxes were successfully sent, fax confirmation must be enabled.

---

## To send a standard fax from the printer control panel

1. Load your original print-side down on the scanner glass or print-side up in the document feeder.  
For more information, see [Load an original on the scanner glass](#) or [Load an original in the document feeder](#).
2. From the printer control panel display, touch **Fax** .
3. Touch **Send Now**.
4. Enter the fax number by using the keypad.

---

 **TIP:** To add a pause in the fax number you are entering, touch \* repeatedly, until a dash (-) appears on the display.

---

5. Touch **Black** or **Color** .

If the printer detects an original loaded in the document feeder, it sends the document to the number you entered.

---

 **TIP:** If the recipient reports issues with the quality of the fax, try changing the resolution or contrast of your fax.

---

## Send a standard fax from the computer

You can fax a document directly from your computer without printing it first.

To use this feature, make sure you have installed the HP printer software on your computer, the printer is connected to a working telephone line, and the fax function is set up and functioning correctly.

### To send a standard fax from the computer (Windows)

1. Open the document on your computer that you want to fax.
2. On the **File** menu in your software application, click **Print**.
3. From the **Name** list, select the printer that has “**fax**” in the name.
4. To change settings (such as selecting to send the document as a black fax or a color fax), click the button that opens the **Properties** dialog box. Depending on your software application, this button might be called **Properties**, **Options**, **Printer Setup**, **Printer**, or **Preferences**.
5. After you have changed any settings, click **OK**.
6. Click **Print** or **OK**.
7. Enter the fax number and other information for the recipient, change any further settings for the fax, and then click **Send Fax**. The printer begins dialing the fax number and faxing the document.

### To send a standard fax from the computer (OS X)

1. Open the document on your computer that you want to fax.
2. From the **File** menu in your software, click **Print**.
3. Select the printer that has “**(Fax)**” in the name.
4. Enter a fax number or a name from your Contacts that already has a fax number entry.
5. When you have finished filling out the fax information, click **Fax**.

## Send a fax from a phone

You can send a fax using your telephone extension. This allows you to talk with the intended recipient before sending the fax.

### To send a fax from an extension phone

1. Load your original print-side down on the scanner glass or print-side up in the document feeder.

For more information, see [Load an original on the scanner glass](#) or [Load an original in the document feeder](#).

2. Dial the number by using the keypad on the phone that is connected to the printer.

If the recipient answers the telephone, inform the recipient that they should receive the fax on their fax machine after they hear fax tones. If a fax machine answers the call, you will hear fax tones from the receiving fax machine.

3. From the printer control panel display, touch **Fax**.
4. Touch **Send and Receive**.
5. Touch **Send Fax**.
6. If the original is loaded on the scanner glass, touch **Use Glass**.
7. When you are ready to send the fax, touch **Black** or **Color**.



---

**NOTE:** If prompted, select **Send Fax**.

The telephone is silent while the fax is transmitting. If you want to speak to the recipient after, remain on the line until the transmission is complete. If you were finished talking to the recipient, you can hang up the telephone as soon as the fax begins transmitting.

## Send a fax using monitor dialing

When you send a fax using monitor dialing, you can hear the dial tones, telephone prompts, or other sounds through the speakers on the printer. This enables you to respond to prompts while dialing, as well as control the pace of your dialing.



---

**TIP:** If you are using a calling card and do not enter your PIN fast enough, the printer might start sending fax tones too soon and cause your PIN not to be recognized by the calling card service. If this is the case, you can create a phone book contact to store the PIN for your calling card. For more information, see [Set up phone book contacts](#).



---

**NOTE:** Make sure the volume is turned on to hear a dial tone.

### To send a fax using monitor dialing from the printer control panel



1. Load your original print-side down on the scanner glass or print-side up in the document feeder.

For additional information, see [Load an original on the scanner glass](#) or [Load an original in the document feeder](#).

2. From the printer control panel display, touch **Fax**.
3. Touch **Send New Fax**.
4. Touch **Black** or **Color**.

5. When you hear the dial tone, enter the number by using the keypad on the printer control panel.
6. Follow any prompts that might occur.

---

 **TIP:** If you are using a calling card to send a fax and you have your calling card PIN stored as a phone book contact, when prompted to enter your PIN, touch  (Phone book) to select the phone book contact where you have your PIN stored.

---

Your fax is sent when the receiving fax machine answers.

## Send a fax from memory

You can scan a black-and-white fax into memory and then send the fax from memory. This feature is useful if the fax number you are trying to reach is busy or temporarily unavailable. The printer scans the originals into memory and sends them once it is able to connect to the receiving fax machine. After the printer scans the pages into memory, you can immediately remove the originals from the document feeder tray or scanner glass.

---

 **NOTE:** You can only send a black-and-white fax from memory.

---

### To send a fax from memory

1. Ensure that **San and Fax Method** is turned on.
  - a. From the printer control panel display, touch **Setup**.
  - b. Touch **Fax Setup**, and then touch **Preferences**.
  - c. Set **Scan and Fax Method** to on.
2. Load your original print-side up in the document feeder.

For additional information, see [Load an original in the document feeder](#).
3. From the printer control panel display, touch **Fax**.
4. Touch **Send Now**.
5. If the original is loaded on the scanner glass, touch **Use Glass**.

---

 **NOTE:** If you select **Use Glass**, the printer follows the method for sending a standard fax. For more information on sending a standard fax, see [Send a standard fax](#)

---

6. Enter the fax number by using the keypad, touch  (Phone book) to select a phone book contact or to select a previously dialed or received number.
7. Touch **Black**.

The printer scans the originals into memory and sends the fax when the receiving fax machine is available.

## Send a fax to multiple recipients



You can send a fax to multiple recipients by creating a group phone book contact made up of two or more individual recipients.



## To send a fax to multiple recipients using group phone book

1. Load your original print-side down on the scanner glass or print-side up in the document feeder.

For additional information, see [Load an original on the scanner glass](#) or [Load an original in the document feeder](#).

2. From the printer control panel display, touch **Fax** .
3. Touch **Send Now**.
4. If the original is loaded on the scanner glass, touch **Use Glass**.
5. Touch  (Phone book).
6. Touch  (**Group Phone Book Contact**).
7. Touch the name of the group phone book contact.
8. Touch **Send Fax** .

If the printer detects an original loaded in the document feeder, it sends the document to each number in the Group Phone Book contact.

---

 **TIP:** If the recipient reports issues with the quality of the fax, try changing the resolution or contrast of your fax.

---

## Send a fax in Error Correction Mode

**Error Correction Mode (ECM)** prevents loss of data due to poor phone lines by detecting errors that occur during transmission and automatically requesting retransmission of the erroneous portion. Phone charges are unaffected, or might even be reduced, on good phone lines. On poor phone lines, ECM increases sending time and phone charges, but sends the data much more reliably. The default setting is **On** . Turn ECM off only if it increases phone charges substantially, and if you can accept poorer quality in exchange for reduced charges.

If you turn ECM off:

- The quality and transmission speed of faxes you send and receive are affected.
- The **Fax Speed** is automatically set to **Medium** .
- You can no longer send or receive faxes in color.

## To change the ECM setting from the control panel

1. From the printer control panel display, touch **Setup** .
2. Touch **Fax Setup** .
3. Touch **Preferences** .
4. Touch **Error Correction Mode** to turn on or off.
5. Select **On** or **Off** .

## Receive a fax

You can receive faxes automatically or manually. If you turn off the **Auto Answer** option, you must receive faxes manually. If you turn on the **Auto Answer** option (the default setting), the printer automatically answers incoming calls and receives faxes after the number of rings that are specified by the **Rings to Answer** setting. (The default **Rings to Answer** setting is five rings.)

If you receive a Legal-size or larger fax and the printer is not currently set to use Legal-size paper, the printer reduces the fax so that it fits on the paper that is loaded. If you have disabled the **Automatic Reduction** feature, the printer prints the fax on two pages.



---

**NOTE:** If you are copying a document when a fax arrives, the fax is stored in the printer memory until the copying finishes.

---

- [Receive a fax manually](#)
- [Set up backup fax](#)
- [Reprint received faxes from memory](#)
- [Forward faxes to another number](#)
- [Set automatic reduction for incoming faxes](#)
- [Block unwanted fax numbers](#)
- [Receive faxes using HP Digital Fax](#)

## Receive a fax manually

When you are on the phone, the person you are speaking with can send you a fax while you are still connected. You can pick up the handset to talk or listen for fax tones.

You can receive faxes manually from a phone that is directly connected to the printer (on the 2-EXT port).

### To receive a fax manually

1. Make sure the printer is turned on and you have paper loaded in the main tray.
2. Remove any originals from the document feeder tray.
3. Set the **Rings to Answer** setting to a high number to allow you to answer the incoming call before the printer answers. Or, turn off the **Auto Answer** setting so that the printer does not automatically answer incoming calls.
4. If you are currently on the phone with the sender, instruct the sender to press **Start** on their fax machine.
5. When you hear fax tones from a sending fax machine, do the following:
  - a. From the printer control panel display, touch **Fax**, touch **Send and Receive**, and then touch **Receive Now**.
  - b. After the printer begins to receive the fax, you can hang up the phone or remain on the line. The phone line is silent during fax transmission.

## Set up backup fax

Depending on your preference and security requirements, you can set up the printer to store all the faxes it receives, only the faxes it receives while the printer is in an error condition, or none of the faxes it receives.

### To set backup fax from the printer control panel

1. From the printer control panel display, touch **Setup**.
2. Touch **Fax Setup**.
3. Touch **Preferences**.
4. Touch **Backup Fax Reception**.

5. Touch the required setting.

---

<b>On</b>	The default setting. When <b>Backup fax</b> is <b>On</b> , the printer stores all received faxes in memory. This enables you to reprint up to 30 of the most recently printed faxes if they are still saved in memory.  <b>NOTE:</b> When printer memory is low, it overwrites the oldest, printed faxes as it receives new faxes. If the memory becomes full of unprinted faxes, the printer stops answering incoming fax calls.  <b>NOTE:</b> If you receive a fax that is too large, such as a very detailed color photo, it might not be stored in memory due to memory limitations.
<b>On Error Only</b>	Causes the printer to store faxes in memory only if an error condition exists that prevents the printer from printing the faxes (for example, if the printer runs out of paper). The printer continues to store incoming faxes as long as there is memory available. (If the memory becomes full, the printer stops answering incoming fax calls.) When the error condition is resolved, the faxes stored in memory print automatically, and then they are deleted from memory.
<b>Off</b>	Faxes are never stored in memory. For example, you might want to turn off <b>Backup fax</b> for security purposes. If an error condition occurs that prevents the printer from printing (for example, the printer runs out of paper), the printer stops answering incoming fax calls.

---

## Reprint received faxes from memory

The received faxes that are not printed out are stored in memory.



**NOTE:** After the memory becomes full, the printer cannot receive the new fax until you print or delete the faxes from memory. You might also want to delete the faxes in memory for security or privacy purposes.

Depending on the sizes of the faxes in memory, you can reprint up to 30 of the most recently printed faxes, if they are still in memory. For example, you might need to reprint your faxes if you lost the copy of your last printout.

### To reprint faxes in memory from the printer control panel

1. Make sure you have paper loaded in the main tray. For more information, see [Load paper](#).
2. From the printer control panel display, touch **Fax**.
3. Touch **Reprint**.

The faxes are printed in the reverse order from which they were received with the most recently received fax printed first, and so on.

4. If you want to stop reprinting the faxes in memory, touch  (Cancel).

## Forward faxes to another number

You can set up the printer to forward your faxes to another fax number. All faxes are forwarded in black and white, regardless of how they were originally sent.

HP recommends that you verify the number you are forwarding to is a working fax line. Send a test fax to make sure the fax machine is able to receive your forwarded faxes.

### To forward faxes from the printer control panel

1. From the printer control panel display, touch **Setup**.
2. Touch **Fax Setup**.
3. Touch **Preferences**.

4. Touch **Fax Forwarding**.
5. Touch **On (Print and Forward)** to print and forward the fax, or select **On (Forward)** to forward the fax.

---

 **NOTE:** If the printer is not able to forward the fax to the designated fax machine (for example, if it is not turned on), the printer prints the fax. If you set up the printer to print error reports for received faxes, it also prints an error report.

---

6. At the prompt, enter the number of the fax machine intended to receive the forwarded faxes, and then touch **Done** . Enter the required information for each of the following prompts: start date, start time, end date, and end time.
7. Fax forwarding is activated. Touch **OK** to confirm.

If the printer loses power when fax forwarding is set up, it saves the fax forwarding setting and phone number. When the power is restored to the printer, the fax forwarding setting is still **On** .

---

 **NOTE:** You can cancel fax forwarding by selecting **Off** from the **Fax Forwarding** menu.

---

## Set automatic reduction for incoming faxes

The **Automatic Reduction** setting determines what the printer does if it receives a fax that is too large for the loaded paper size. This setting is turned on by default, so the image of the incoming fax is reduced to fit on one page, if possible. If this feature is turned off, information that does not fit on the first page is printed on a second page. **Automatic Reduction** is useful when you receive a Legal-size fax and Letter-size paper is loaded in the main tray.

### To set automatic reduction from the printer control panel

1. From the printer control panel display, touch **Setup** .
2. Touch **Fax Setup** .
3. Touch **Preferences** .
4. Touch **Automatic Reduction** to turn on or off.

## Block unwanted fax numbers

If you subscribe to a caller ID service through your phone provider, you can block specific fax numbers so the printer does not receive faxes received from those numbers. When an incoming fax call is received, the printer compares the number to the list of junk fax numbers to determine if the call should be blocked. If the number matches a number in the blocked fax numbers list, the fax is not received. (The maximum number of fax numbers you can block varies by model.)

---

 **NOTE:** This feature is not supported in all countries/regions. If it is not supported in your country/region, **Junk Fax Blocking** does not appear in the **Preferences** menu.

 **NOTE:** If no phone numbers are added in the Caller ID list, it is assumed that you are not subscribed to a Caller ID service.

---

You can block specific fax numbers by adding them to the junk fax list, unblock these numbers by removing them from the junk fax list, and print a list of blocked junk fax numbers.

### To add a number to the junk fax list

1. From the printer control panel display, touch **Setup** .
2. Touch **Fax Setup** .

3. Touch **Preferences** .
4. Touch **Junk Fax Blocking** .
5. Touch **+** (Plus Sign).
6. Do one of the following.
  - To select a fax number to block from the call history list, touch  (Call history).
  - Manually enter a fax number to block, and touch **Add**.

---

 **NOTE:** Make sure you enter the fax number as it appears on the control panel display, and not the fax number that appears on the fax header of the received fax, as these numbers can be different.

---

### To remove numbers from the junk fax list

If you no longer want to block a fax number, you can remove it from the junk fax list.

1. From the printer control panel display, touch **Setup** .
2. Touch **Fax Setup** .
3. Touch **Preferences** .
4. Touch **Junk Fax Blocking** .
5. Touch the number you want to remove, and then touch **Remove**.

### To print a junk fax list

1. From the printer control panel display, touch **Setup** .
2. Touch **Fax Setup** , and then touch **Reports** .
3. Touch **Print Fax Reports** .
4. Touch **Junk Fax Report**.
5. Touch **Print** to begin printing.

## Receive faxes using HP Digital Fax

You can use HP Digital Fax to automatically receive faxes and save them directly to your computer. This saves paper and ink.

Received faxes are saved as TIFF (Tagged Image File Format) or PDF (Portable Document Format).

The files are named in the following method: XXXX\_YYYYYYYY\_ZZZZZZ.tif, where X is the sender's information, Y is the date, and Z is the time that the fax was received.

---

 **NOTE:** Fax to Computer is available for receiving black-and-white faxes only. Color faxes will be printed.

---

- [HP Digital Fax requirements](#)
- [Activate HP Digital Fax](#)
- [Modify HP Digital Fax settings](#)

## HP Digital Fax requirements

- The destination folder of the computer must be available at all times. The destination computer must also be awake, faxes will not be saved if the computer is asleep or in hibernate mode.
- Paper must be loaded in the input tray. For more information, see [Load paper](#).

## Activate HP Digital Fax

### To set up HP Digital Fax (Windows)

1. Open the HP printer software. For more information, see [Open the HP printer software \(Windows\)](#).
2. Click **Print, Scan & Fax** and click **Digital Fax Setup Wizard**.
3. Follow the on-screen instructions.

### To set up HP Digital Fax (OS X)

1. Open HP Utility. For more information, see [HP Utility \(OS X\)](#).
2. Select the printer.
3. Click **Digital Fax Archive** in the Fax Settings section.

## Modify HP Digital Fax settings

You can turn off HP Digital Fax and disable printing faxes from the printer control panel.

### To modify settings from the printer control panel

1. From the printer control panel display, touch **Setup**.
2. Touch **Fax Setup**.
3. Touch **Preferences**, and then touch **HP Digital Fax**.
4. Select the setting that you want to change. You can change the following settings:
  - **Fax Printing:** Choose this option to print faxes as they are received. If you turn off printing, color faxes will still print.
  - **Turn Off HP Digital Fax:** Choose this option to turn off HP Digital Fax.



---

**NOTE:** Use the HP printer software on your computer to turn on HP Digital Fax.

### To modify settings from the HP printer software (Windows)

1. Open the HP printer software. For more information, see [Open the HP printer software \(Windows\)](#).
2. Click **Print, Scan & Fax** and click **Digital Fax Setup Wizard**.
3. Follow the on-screen instructions.

### To modify settings from the HP printer software (OS X)

1. Open HP Utility. For more information, see [HP Utility \(OS X\)](#).
2. Select the printer.
3. Click **Digital Fax Archive** in the Fax Settings section.

## Turn off HP Digital Fax

1. From the printer control panel display, touch **Setup** .
2. Touch **Fax Setup** .
3. Touch **Preferences** and then touch **HP Digital Fax**.
4. Touch **Turn Off HP Digital Fax**.
5. Touch **Yes**.

## Set up phone book contacts

You can set up frequently used fax numbers as phone book contacts. This lets you quickly dial those numbers using the printer control panel.

---

 **TIP:** In addition to creating and managing phone book contacts from the printer control panel, you can also use tools available on your computer, such as the HP software included with the printer and the printer EWS. For more information, see [Printer management tools](#).



---

- [Set up and change phone book contacts](#)
- [Set up and change group phone book contacts](#)
- [Delete phone book contacts](#)
- [Print a list of phone book contacts](#)

## Set up and change phone book contacts

You can store fax numbers as phone book contacts.

### To set up phone book contacts

1. From the printer control panel display, touch **Fax** .
2. Touch **Send Now**.
3. Touch  (Phone book).
4. Touch  (**Phone Book Contact**).
5. Touch  (**Plus Sign**) to add a contact.
6. Touch **Name** and then type the name of the phone book contact, and then touch **Done** .
7. Touch **Fax Number** and type the fax number for the phone book contact, and then touch **Done** .

---



 **NOTE:** Be sure to include any pauses or other required numbers, such as an area code, an access code for numbers outside a PBX system (usually a 9 or 0), or a long-distance prefix.

---

8. Touch **Add**.

### To change phone book contacts

1. From the printer control panel display, touch **Fax** .
2. Touch **Send Now**.
3. Touch  (Phone book).

4. Touch  (**Phone Book Contact**).
5. Touch  (**Edit**) to edit a contact.
6. Touch the phone book contact that you want to edit.
7. Touch **Name** and then edit the name of the Phone Book contact, and then touch **Done** .
8. Touch **Fax Number** and edit the fax number for the phone book contact, and then touch **Done** .



---

**NOTE:** Be sure to include any pauses or other required numbers, such as an area code, an access code for numbers outside a PBX system (usually a 9 or 0), or a long-distance prefix.

---

9. Touch **Done** .

## Set up and change group phone book contacts

You can store groups of fax numbers as group phone book contacts.



### To set up group phone book contacts







---

**NOTE:** Before you can create a group phone book contact, you must have already created at least one phone book contact.

---

1. From the printer control panel display, touch **Fax** .
2. Touch **Send Now**.
3. Touch  (Phone book).
4. Touch  (**Group Phone Book Contact**).
5. Touch  (**Plus Sign**) to add a group.
6. Touch **Name** and then type the name of the group, and then touch **Done** .
7. Touch **Number of Members**, select the phone book contacts you want to include in this group, and then touch **Select**.
8. Touch **Create**.



### To change group phone book contacts

1. From the printer control panel display, touch **Fax** .
2. Touch **Send Now**.
3. Touch  (Phone book).
4. Touch  (**Group Phone Book Contact**).
5. Touch  (**Edit**) to edit a group.
6. Touch the group phone book contact that you want to edit.
7. Touch **Name** and then edit the name of the group phone book contact, and then touch **Done** .
8. Touch **Number of Members**.
9. Select the phone book contacts you want to delete from this group, or touch  (**Plus Sign**) to add a contact to the group.
10. Touch **Done** .



## Delete phone book contacts

You can delete phone book contacts or group phone book contacts.

1. From the printer control panel display, touch **Fax** .
2. Touch **Send Now**.
3. Touch  (Phone book).
4. Touch  (**Phone Book Contact**).
5. Touch  (**Edit**).
6. Touch the name of the phone book contact you want to delete.
7. Touch **Delete**.
8. Touch **Yes** to confirm.

## Print a list of phone book contacts

You can print a list of your phone book contacts.

1. Load paper in the tray. For more information, see [Load paper](#).
2. From the printer control panel, touch **Setup** .
3. Touch **Fax Setup** , and then touch **Reports** .
4. Touch **Print Phone Book**.

## Change fax settings

After completing the steps in the getting started guide that came with the printer, use the following steps to change the initial settings or to configure other options for faxing.

- [Configure the fax header](#)
- [Set the answer mode \(Auto answer\)](#)
- [Set the number of rings before answering](#)
- [Change the answer ring pattern for distinctive ring](#)
- [Set the dial type](#)
- [Set the redial options](#)
- [Set the fax speed](#)
- [Set the fax sound volume](#)

## Configure the fax header

The fax header prints your name and fax number on the top of every fax you send. HP recommends that you set up the fax header by using the HP software provided with the printer. You can also set up the fax header from the printer control panel, as described here.



---

**NOTE:** In some countries/regions, the fax header information is a legal requirement.

---

### To set or change the fax header

1. From the printer control panel display, touch **Setup** .
2. Touch **Fax Setup** , and then touch **Preferences** .
3. Touch **Fax Header**.
4. Enter your personal or company name, and then touch **Done** .
5. Enter your fax number, and then touch **Done** .

### Set the answer mode (Auto answer)

The answer mode determines whether the printer answers incoming calls.

- Turn on the **Auto Answer** setting if you want the printer to answer faxes **automatically**. The printer answers all incoming calls and faxes.
- Turn off the **Auto Answer** setting if you want to receive faxes **manually**. You must be available to respond in person to the incoming fax call or else the printer does not receive faxes.

### To set the answer mode

1. From the printer control panel display, touch **Setup** .
2. Touch **Fax Setup** , and then touch **Preferences** .
3. Touch **Auto Answer** to turn it on or off.

You may also access this feature by pressing  (the **Fax Status** button) on the Home screen.

### Set the number of rings before answering

If you turn on the **Auto Answer** setting, you can specify how many rings occur before incoming calls are automatically answered.

The **Rings to Answer** setting is important if you have an answering machine on the same phone line as the printer, because you want the answering machine to answer the phone before the printer does. The number of rings to answer for the printer should be greater than the number of rings to answer for the answering machine.

For example, set your answering machine to a low number of rings and the printer to answer in the maximum number of rings. (The maximum number of rings varies by country/region.) In this setup, the answering machine answers the call and the printer monitors the line. If the printer detects fax tones, it receives the fax. If the call is a voice call, the answering machine records the incoming message.

### To set the number of rings before answering

1. From the printer control panel display, touch **Setup** .
2. Touch **Fax Setup** , and then touch **Preferences** .
3. Touch **Rings to Answer** .
4. Touch the number of rings.
5. Touch **Done** to accept the setting.

## Change the answer ring pattern for distinctive ring

Many phone companies offer a distinctive ring feature that allows you to have several phone numbers on one phone line. When you subscribe to this service, each number is assigned a different ring pattern. You can set up the printer to answer incoming calls that have a specific ring pattern.

If you connect the printer to a line with distinctive ring, have your telephone company assign one ring pattern to voice calls and another ring pattern to fax calls. HP recommends that you request double or triple rings for a fax number. When the printer detects the specified ring pattern, it answers the call and receives the fax.

---

 **TIP:** You can also use the Ring Pattern Detection feature in the printer control panel to set distinctive ring. With this feature, the printer recognizes and records the ring pattern of an incoming call and, based on this call, automatically determines the distinctive ring pattern assigned by your telephone company to fax calls.

---

If you do not have a distinctive ring service, use the default ring pattern, which is **All Rings** .

---

 **NOTE:** The printer cannot receive faxes when the main phone number is off the hook.

---

### To change the answer ring pattern for distinctive ring

1. Verify that the printer is set to answer fax calls automatically.
2. From the printer control panel display, touch **Setup** .
3. Touch **Fax Setup** , and then select **Preferences** .
4. Touch **Distinctive Ring** .
5. A message appears stating that this setting should not be changed unless you have multiple numbers on the same telephone line. Touch **Yes** to continue.
6. Do one of the following:
  - Touch the ring pattern assigned by your telephone company to fax calls.
  - Touch **Ring Pattern Detection**, and then follow the instructions on the printer control panel.

---

 **NOTE:** If the Ring Pattern Detection feature cannot detect the ring pattern or if you cancel the feature before it finishes, the ring pattern is automatically set to the default, which is **All Rings** .

 **NOTE:** If you are using a PBX phone system that has different ring patterns for internal and external calls, you must call the fax number from an external number.

---

## Set the dial type

Use this procedure to set tone-dialing or pulse-dialing mode. The factory-set default is **Tone**. Do not change the setting unless you know that your phone line cannot use tone dialing.

---

 **NOTE:** The pulse-dialing option is not available in all countries/regions.

---

### To set the dial type

1. From the printer control panel display, touch **Setup** .
2. Touch **Fax Setup** , and then touch **Preferences** .
3. Touch **Dial Type**.
4. Touch to select **Tone Dialing** or **Pulse Dialing**.

## Set the redial options

If the printer was unable to send a fax because the receiving fax machine did not answer or was busy, the printer attempts to redial based on the settings for the redial options. Use the following procedure to turn the options on or off.

- **Busy redial:** If this option is turned on, the printer redials automatically if it receives a busy signal. The default is **On**.
- **No answer redial:** If this option is turned on, the printer redials automatically if the receiving fax machine does not answer. The default is **Off**.
- **Connection problem redial:** If this option is turned on, the printer redials automatically if there has been a problem connecting with the receiving fax machine. Connection problem redial works only for sending faxes from memory. The default is **On**.

### To set the redial options

1. From the printer control panel display, touch **Setup**.
2. Touch **Fax Setup**, and then touch **Preferences**.
3. Touch **Auto Redial**.
4. Touch **Busy Redial**, or **No Answer Redial**, or **Connection Problem Redial**, and then select the appropriate options.

## Set the fax speed

You can set the fax speed used to communicate between your printer and other fax machines when sending and receiving faxes.

If you use one of the following, setting the fax speed to a slower speed might be required:

- An Internet phone service
- A PBX (private branch exchange) system
- Fax over Internet Protocol (FoIP)
- An integrated services digital network (ISDN) service

If you experience problems sending and receiving faxes, try using a slower **Fax Speed**. The following table provides the available fax speed settings.

Fax speed setting	Fax speed
<b>Fast</b>	v.34 (33600 baud)
<b>Medium</b>	v.17 (14400 baud)
<b>Slow</b>	v.29 (9600 baud)

### To set the fax speed

1. From the printer control panel display, touch **Setup**.
2. Touch **Fax Setup**, and then touch **Preferences**.
3. Touch **Fax Speed**.
4. Touch to select an option.

## Set the fax sound volume

You can change the volume of fax sounds.

### To set the fax sound volume

1. From the printer control panel display, touch **Setup** .
2. Touch **Fax Setup** , and then touch **Preferences** .
3. Touch **Volume**.
4. Touch to select **Soft**, **Loud**, or **Off** .

## Fax and digital phone services

Many telephone companies provide their customers with digital phone services, such as the following:

- DSL: A Digital subscriber line (DSL) service through your telephone company. (DSL might be called ADSL in your country/region.)
- PBX: A private branch exchange (PBX) phone system.
- ISDN: An integrated services digital network (ISDN) system.
- FoIP: A low-cost phone service that allows you to send and receive faxes with your printer by using the Internet. This method is called Fax over Internet Protocol (FoIP).

For more information, see [Fax over Internet Protocol](#).

HP printers are designed specifically for use with traditional analog phone services. If you are in a digital phone environment (such as DSL/ADSL, PBX, or ISDN), you might need to use digital-to-analog filters or converters when setting up the printer for faxing.



---

**NOTE:** HP does not guarantee that the printer will be compatible with all digital service lines or providers, in all digital environments, or with all digital-to-analog converters. It is always recommended that you discuss with the telephone company directly for the correct setup options based on their line services provided.

---

## Fax over Internet Protocol

You might be able to subscribe to a low cost phone service that allows you to send and receive faxes with your printer by using the Internet. This method is called Fax over Internet Protocol (FoIP).

You probably use a FoIP service (provided by your telephone company) when you:

- Dial a special access code along with the fax number.
- Have an IP converter box that connects to the Internet and provides analog phone ports for the fax connection.



---

**NOTE:** You can only send and receive faxes by connecting a phone cord to the port labeled "1-LINE" on the printer. This means that your connection to the Internet must be done either through a converter box (which supplies regular analog phone jacks for fax connections) or your telephone company.

---



**TIP:** Support for traditional fax transmission over any Internet protocol telephone systems are often limited. If you experience problems faxing, try using a slower fax speed or disabling the fax error-correction mode (ECM). However, if you turn off ECM, you cannot send and receive color faxes.

For more information about changing the fax speed, see [Set the fax speed](#). For more information about using ECM, see [Send a fax in Error Correction Mode](#).



---

If you have questions about Internet faxing, contact your Internet faxing services support department or your local service provider for further assistance.

## Use reports

You can set up the printer to print error reports and confirmation reports automatically for each fax you send and receive. You can also manually print system reports as required; these reports provide useful system information about the printer.

By default, the printer is set to print a report only if there is a problem sending or receiving a fax. A confirmation message that indicates whether a fax was successfully sent appears briefly on the control panel display after each transaction.

- 
-  **NOTE:** If the reports are not legible, you can check the estimated ink levels from the control panel or the HP software. For more information, see [Check the estimated ink levels](#).
-  **NOTE:** Ink level alerts and indicators provide estimates for planning purposes only. When you receive a low-ink alert, consider having a replacement cartridge available to avoid possible printing delays. You do not need to replace the ink cartridges until the print quality becomes unacceptable.
-  **NOTE:** Ensure that the printheads and ink cartridges are in good conditions and installed properly. For more information, see [Work with ink cartridges](#).
- 

This section contains the following topics:

- [Print fax confirmation reports](#)
- [Print fax error reports](#)
- [Print and view the fax log](#)
- [Clear the fax log](#)
- [Print the details of the last fax transaction](#)
- [Print a Caller ID Report](#)
- [View the Call History](#)

## Print fax confirmation reports

You can print a confirmation report either when a fax is sent, or when any fax is sent or received. The default setting is **On (Fax Send)**. When turned off, a confirmation message appears briefly on the control panel after each fax is sent or received.

- 
-  **NOTE:** You can include an image of the first page of the fax on the Fax Sent Confirmation report if you select **On (Fax Send)** or **On (Fax Send and Fax Receive)**, and if you scan the fax to send from memory or use the **Scan and Fax** option.
- 

### To enable fax confirmation

1. From the printer control panel display, touch **Setup**.
2. Touch **Fax Setup**.
3. Touch **Reports** and touch **Fax Confirmation**.
4. Touch to select one of the following options.

<b>Off</b>	Does not print a fax confirmation report when you send and receive faxes successfully. This is the default setting.
<b>On (Fax Send)</b>	Prints a fax confirmation report for every fax you send.
<b>On (Fax Receive)</b>	Prints a fax confirmation report for every fax you receive.
<b>On (Fax Send and Fax Receive)</b>	Prints a fax confirmation report for every fax you send and receive.

### To include an image of the fax on the report

1. From the printer control panel display, touch **Setup** .
2. Touch **Fax Setup** .
3. Touch **Reports** and touch **Fax Confirmation** .
4. Touch **On (Fax Send)** or **On (Fax Send and Fax Receive)** .
5. Touch **Fax confirmation with image**.

## Print fax error reports

You can configure the printer so that it automatically prints a report when there is an error during transmission or reception.

### To set the printer to print fax error reports automatically

1. From the printer control panel display, touch **Setup** .
2. Touch **Fax Setup** .
3. Touch **Reports** and touch **Fax Error Report**.
4. Touch to select one of the following.

<b>On (Fax Send and Fax Receive)</b>	Prints whenever a fax error occurs.
<b>Off</b>	Does not print any fax error reports.
<b>On (Fax Send)</b>	Prints whenever a transmission error occurs. This is the default setting.
<b>On (Fax Receive)</b>	Prints whenever a receiving error occurs.

## Print and view the fax log

You can print a log of faxes that have been received and sent by the printer.

### To print the fax log from the printer control panel

1. From the printer control panel display, touch **Setup** .
2. Touch **Fax Setup** , and then touch **Reports** .
3. Touch **Print Fax Reports** .
4. Touch **Print Last 30 Transactions** .
5. Touch **Print** to begin printing.

## Clear the fax log

Clearing the fax log also deletes all faxes stored in memory.

### To clear the fax log

1. From the printer control panel display, touch **Setup** .
2. Touch **Fax Setup** , and then touch **Tools**.
3. Touch **Clear Fax Log**.

## Print the details of the last fax transaction

The Last Fax Transaction report prints the details of the last fax transaction to occur. Details include the fax number, number of pages, and the fax status.

### To print the Last Fax Transaction report

1. From the printer control panel display, touch **Setup** .
2. Touch **Fax Setup** , and then touch **Reports** .
3. Touch **Print Fax Reports** .
4. Touch **Last Transaction**.
5. Touch **Print** to begin printing.

## Print a Caller ID Report

You can print a list of Caller ID fax numbers.

### To print a Caller ID History Report

1. From the printer control panel display, touch **Setup** .
2. Touch **Fax Setup** , and then touch **Reports** .
3. Touch **Print Fax Reports** .
4. Touch **Caller ID Report**.
5. Touch **Print** to begin printing.

## View the Call History

You can view a list of all the calls placed from the printer.



---

**NOTE:** You cannot print the call history.

---

### To view the call history

1. From the printer control panel display, touch **Fax** .
2. Touch **Send New Fax**.
3. Touch (Phone book).
4. Touch (Call history).



---

# 6 Web Services

The printer offers innovative, web-enabled solutions that can help you quickly access the Internet, obtain documents, and print them faster and with less hassle—and all without using a computer.

---

 **NOTE:** To use these web features, the printer must be connected to the Internet (either using an Ethernet cable or wireless connection). You cannot use these web features if the printer is connected using a USB cable.

---

This section contains the following topics:

- [What are Web Services?](#)
- [Set up Web Services](#)
- [Use Web Services](#)
- [Remove Web Services](#)

## What are Web Services?

### HP ePrint

- HP ePrint is a free service from HP that allows you to print to your HP ePrint-enabled printer anytime, from any location. It's as simple as sending an email to the email address assigned to your printer when you enable Web Services on the printer. No special drivers or software are needed. If you can send an email, you can print from anywhere, using HP ePrint.

Once you have signed up for an account on HP Connected ( [www.hpconnected.com](http://www.hpconnected.com) ), you can sign in to view your HP ePrint job status, manage your HP ePrint printer queue, control who can use your printer's HP ePrint email address to print, and get help for HP ePrint.

### HP Printables

- HP Printables allow you to easily locate and print preformatted web content, directly from your printer. You can also scan and store your documents digitally on the Web.

HP Printables provide a wide range of content, from store coupons to family activities, news, travel, sports, cooking, photos, and many more. You can even view and print your online images from popular photo sites.

Certain HP Printables also allow you to schedule the delivery of app content to your printer.

Preformatted content designed specifically for your printer means no cut-off text and pictures and no extra pages with only one line of text. On some printers, you can also choose paper and print quality settings on the print preview screen.

## Set up Web Services

Before you set up Web Services, make sure your printer is connected to the Internet using either an Ethernet or wireless connection.

To set up Web Services, use one of the following methods.

### To set up Web Services using the printer control panel

1. From the printer control panel display, touch **Setup** .
2. Touch **Web Services Setup** .
3. Touch **Accept** to accept the Web Services terms of use and enable Web Services.
4. In the **Auto Update** screen, touch **Yes** to allow the printer to automatically check for and install product updates.

---

 **NOTE:** If a printer update is available, the printer will download and install the update, and then restart. You will have to repeat the instructions from step 1 to set up HP ePrint.

 **NOTE:** If prompted for proxy settings and if your network uses proxy settings, follow the on-screen instructions to set up a proxy server. If you do not have the proxy details, contact your network administrator or the person who set up the network.

---

5. When the printer is connected to the server, the printer prints an information page. Follow the instructions on the information page to finish the setup.

### To set up Web Services using the embedded web server

1. Open the EWS. For more information, see [Embedded web server](#).
2. Click the **Web Services** tab.
3. In the **Web Services Settings** section, click **Setup** , click **Continue**, and follow the on-screen instructions to accept the terms of use.
4. If prompted, choose to allow the printer to check for and install printer updates.

---

 **NOTE:** If a printer update is available, the printer downloads and installs the update, and then restarts. Repeat the instructions from step 1 to set up HP ePrint.

 **NOTE:** If prompted for proxy settings and if your network uses proxy settings, follow the on-screen instructions to set up a proxy server. If you do not have the proxy details, contact your network administrator or the person who set up the network.

---

5. When the printer is connected to the server, the printer prints an information page. Follow the instructions on the information page to finish the setup.

### To set up Web Services using the HP printer software (Windows)

1. Open the HP printer software. For more information, see [Open the HP printer software \(Windows\)](#).
2. In the window that appears, double-click **Print, Scan & Fax** and then select **Connect your printer to the web** under Print. The printer's home page (embedded web server) opens.
3. Click the **Web Services** tab.
4. In the **Web Services Settings** section, click **Setup** , click **Continue**, and follow the on-screen instructions to accept the terms of use.
5. If prompted, choose to allow the printer to check for and install printer updates.

---

 **NOTE:** If a printer update is available, the printer will download and install the update, and then restart. You will have to repeat the instructions from step 1 to set up HP ePrint.

 **NOTE:** If prompted for proxy settings and if your network uses proxy settings, follow the on-screen instructions to set up a proxy server. If you do not have the details, contact your network administrator or the person who set up the network.

---

6. When the printer is connected to the server, the printer prints an information page. Follow the instructions on the information page to finish the setup.

## Use Web Services

The following section describes how to use and configure Web Services.

- [HP ePrint](#)
- [HP Printables](#)

### HP ePrint

To use HP ePrint, do the following:

- Be sure you have an Internet- and email-capable computer or mobile device.
- Enable Web Services on the printer. For more information, see [Set up Web Services](#).

 **TIP:** For more information about managing and configuring HP ePrint settings and to learn about the latest features, visit HP Connected at [www.hpconnected.com](http://www.hpconnected.com).

---

#### To print documents using HP ePrint

1. On your computer or mobile device, open your email application.
2. Create a new email message, and then attach the file that you want to print.
3. Enter the printer's email address in the "To" line of the email message, and then select the option to send the email message.

 **NOTE:** Do not enter any additional email addresses in either the "To" or "Cc" fields. The HP ePrint server does not accept print jobs if there are multiple email addresses.

---

#### To find the printer's email address



1. Make sure you have created an ePrint account.

To sign up for an account on HP Connected, visit [www.hpconnected.com](http://www.hpconnected.com).

2. From the printer control panel display, touch  (HP ePrint).

To customize the email address, touch **Print Info**. The printer prints an information page that contains the printer code and instructions on how to customize the email address.

#### To turn off HP ePrint

1. From the printer control panel, touch  (HP ePrint), and then touch  (**Web Services Settings**).
2. Touch **ePrint**, and then touch **Off**.

 **NOTE:** To remove all Web Services, see [Remove Web Services](#).

---

## HP Printables

HP Printables allow you to easily locate and print preformatted web content, directly from your printer.

### To use HP Printables



1. From the printer control panel, touch  (**HP Printables**).
2. Touch the HP Printables you want to use.

For more information about individual HP Printables, visit [www.hpconnected.com](http://www.hpconnected.com).

### To manage HP Printables

- You can manage your HP Printables with HP Connected. You can add, configure, or remove HP Printables, and set the order in which they appear on your printer control panel display.

### Turn off HP Printables

1. From the printer control panel, touch  (HP ePrint), and then touch  (**Web Services Settings**).
2. Touch **HP Printables**, and then touch **Off**.



---

 **NOTE:** To remove all Web Services, see [Remove Web Services](#).

---

## Remove Web Services

To remove Web Services, complete the following steps:

1. From the printer control panel display, touch  (HP ePrint), and then touch  (**Web Services Settings**).
2. Touch **Remove Web Services**.

---



# 7 Work with ink cartridges

This section contains the following topics:

- [Information on ink cartridges and the printhead](#)
- [Check the estimated ink levels](#)
- [Replace the ink cartridges](#)
- [Order ink cartridges](#)
- [Store printing supplies](#)
- [Anonymous usage information storage](#)
- [Ink cartridge warranty information](#)

## Information on ink cartridges and the printhead

The following tips help maintain HP ink cartridges and ensure consistent print quality.

- The instructions in this user guide are for replacing ink cartridges, and are not intended for first time installation. For the first time installation, follow the instructions in the setup poster provided with the printer.
- When you turn the printer off, always use the  (Power) button. This allows the printer to cap the printhead and protect it from damage. For more information, see [Turn the printer off](#).
- Do not clean the printhead unnecessarily. This wastes ink and shortens the life of the cartridges.
- Handle ink cartridges carefully. Dropping, jarring, or rough handling during installation can cause temporary printing problems.
- If you are transporting the printer, do the following to prevent ink leaking from the printer or other damage from occurring to the printer:
  - Make sure you turn off the printer by pressing the  (Power) button. Wait until all sounds of internal motion stop before unplugging the printer. For more information, see [Turn the printer off](#).
  - The printer must be transported sitting flat; it should not be placed on its side, back, front, or top.

---

 **CAUTION:** HP recommends that you replace any missing cartridges as soon as possible to avoid print quality issues and possible extra ink usage or damage to the ink system. Never turn off the printer when ink cartridges are missing.

---

## Check the estimated ink levels

You can check the estimated ink levels from the printer software or from the printer control panel. For information about using the printer software, see [Printer management tools](#). You can also print the printer status report to view this information (see [Printer status report](#)).

### To check the estimated ink levels from the printer control panel

- ▲ From the printer control panel  (Home) screen, touch  (**Ink Information**).

---

 **NOTE:** Ink level alerts and indicators provide estimates for planning purposes only. When you receive a low-ink alert, consider having a replacement cartridge available to avoid possible printing delays. You do not have to replace the cartridges until the print quality becomes unacceptable.

 **NOTE:** If you have installed a refilled or remanufactured cartridge, or a cartridge that has been used in another printer, the ink level indicator might be inaccurate or unavailable.

 **NOTE:** Ink from the cartridges is used in the printing process in a number of different ways, including in the initialization process, which prepares the printer and cartridges for printing, and in printhead servicing, which keeps print nozzles clear and ink flowing smoothly. In addition, some residual ink is left in the cartridge after it is used. For more information, see [www.hp.com/go/inkusage](http://www.hp.com/go/inkusage).

---

## Replace the ink cartridges

If you do not already have replacement ink cartridges for the printer, see [Order ink cartridges](#). Not all cartridges are available in all countries/regions.

 **CAUTION:** HP recommends that you replace any missing cartridges as soon as possible to avoid print quality issues and possible extra ink usage or damage to the ink system. Never turn off the printer when ink cartridges are missing.

---

For information on recycling used ink supplies, see [HP inkjet supplies recycling program](#).

### To replace the ink cartridges

1. Make sure the printer is turned on.
2. Open the ink cartridge access door.

 **NOTE:** Wait until the print carriage stops moving before proceeding.

---

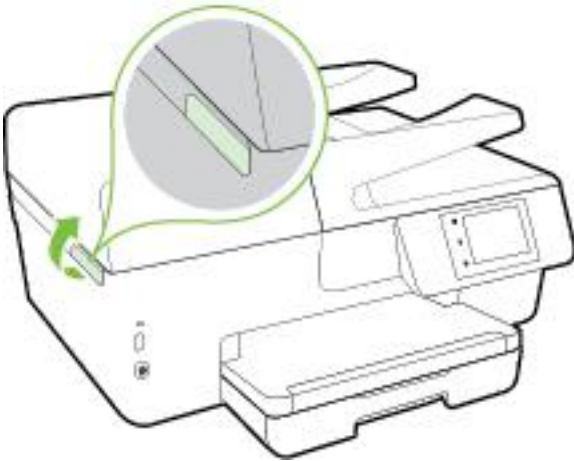

3. Press the front of the ink cartridge to release it, and then remove it from the slot.



4. Remove the new ink cartridge from its packaging.

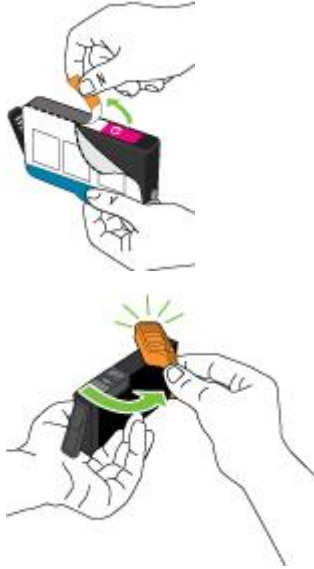

5. Using the color-coded letters for help, slide the ink cartridge into the empty slot until it clicks securely into the slot.



Make sure that you insert the ink cartridge into the slot that has the same colored letter as the color you are installing.



6. Repeat steps 3 through 5 for each ink cartridge you are replacing.
7. Close the ink cartridge access door.

## Order ink cartridges

To order ink cartridges, go to [www.hp.com](http://www.hp.com) . (At this time, some portions of the HP website are available in English only.) Ordering cartridges online is not supported in all countries/regions. However, many countries have information on ordering by telephone, locating a local store and printing a shopping list. In addition, you can visit the [www.hp.com/buy/supplies](http://www.hp.com/buy/supplies) page to obtain information about purchasing HP products in your country.

Use only the replacement cartridges that have the same cartridge number as the ink cartridge you are replacing. You can find the cartridge number in the following places:

- In the embedded web server, by clicking the **Tools** tab, and then, under **Product Information** clicking **Ink Gauge**. For more information, see [Embedded web server](#).
- On the printer status report (see [Printer status report](#)).
- On the label of the ink cartridge you are replacing.
- On a sticker inside the printer. Open the ink cartridge access door to locate the sticker.
- In the printer software, click **Shop**, and then click **Shop For Supplies Online**.



---

**NOTE:** The **Setup** ink cartridge that comes with the printer is not available for separate purchase.

---

## Store printing supplies

- Keep all ink cartridges in the original sealed packages until they are needed.
- Ink cartridges can be left in the printer for extended periods of time. However, to assure optimal ink cartridge health, be sure to turn off the printer properly. For more information, see [Turn the printer off](#).
- Store ink cartridges at room temperature (15-35° C or 59-95° F).

## Anonymous usage information storage

The HP cartridges used with this printer contain a memory chip that assists in the operation of the printer. In addition, this memory chip stores a limited set of anonymous information about the usage of the printer, which might include the following: the number of pages printed using the cartridge, the page coverage, frequency of printing, and the printing modes used.

This information helps HP design future printers to meet our customers' printing needs. The data collected from the cartridge memory chip does not contain information that can be used to identify a customer or user of the cartridge or their printer.

HP collects a sampling of the memory chips from cartridges returned to HP's free return and recycling program (HP Planet Partners: [www.hp.com/recycle](http://www.hp.com/recycle)). The memory chips from this sampling are read and studied in order to improve future HP printers. HP partners who assist in recycling this cartridge might have access to this data, as well.

Any third party possessing the cartridge might have access to the anonymous information on the memory chip. If you prefer to not allow access to this information, you can render the chip inoperable. However, after you render the memory chip inoperable, the cartridge cannot be used in an HP printer.

If you are concerned about providing this anonymous information, you can make this information inaccessible by turning off the memory chip's ability to collect the printer's usage information.

### To disable the usage information function

1. From the printer control panel, touch **Setup**.
2. Select **Preferences**, and then touch **Store Anonymous Usage Information**.
3. Touch **Off** to disable the collection of usage information.



---

**NOTE:** To turn the usage information function on, restore the factory defaults. For more information about how to restore the defaults, see [Restore defaults and settings](#).



**NOTE:** You can continue to use the cartridge in the HP printer if you turn off the memory chip's ability to collect the printer's usage information.

---



## Ink cartridge warranty information

The HP cartridge warranty is applicable when the product is used in its designated HP printing device. This warranty does not cover HP ink products that have been refilled, remanufactured, refurbished, misused, or tampered with.

During the warranty period the product is covered as long as the HP ink is not depleted and the end of warranty date has not been reached. The end of warranty date, in YYYY-MM format, may be found on the product as indicated:

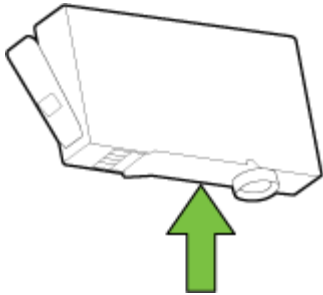

---

# 8 Network setup

Additional advanced settings are available from the printer's home page (embedded web server or EWS). For more information, see [Embedded web server](#).

This section contains the following topics:

- [Set up the printer for wireless communication](#)
- [Change network settings](#)
- [Use HP wireless direct](#)

## Set up the printer for wireless communication

- [Before you begin](#)
- [Set up the printer on your wireless network](#)
- [Change the connection type](#)
- [Test the wireless connection](#)
- [Turn on or off the wireless capability of the printer](#)



**NOTE:** If you encounter problems connecting the printer, see [Unable to connect the printer wirelessly](#).



**TIP:** For more information about setting up and using the printer wirelessly, visit the HP Wireless Printing Center ( [www.hp.com/go/wirelessprinting](http://www.hp.com/go/wirelessprinting) ).

---

### Before you begin

Ensure the following:

- The printer is not connected to the network using an Ethernet cable.
- The wireless network is set up and working properly.
- The printer and the computers that use the printer are on the same network (subnet).

While connecting the printer, you might be prompted to enter the wireless network name (SSID) and a wireless password.

- The wireless network name is the name of your wireless network.
- The wireless password prevents other people from connecting to your wireless network without your permission. Depending on the level of security required, your wireless network might use either a WPA passphrase or WEP key.

If you have not changed the network name or the security passkey since setting up your wireless network, you can sometimes find them on the back or side of the wireless router.

If you cannot find the network name or the security password or cannot remember this information, see the documentation provided with your computer or with the wireless router. If you still cannot find this information, contact your network administrator or the person who set up the wireless network.

## Set up the printer on your wireless network

Use the Wireless Setup Wizard from the printer control panel display to set up wireless communication.



---

**NOTE:** Before you proceed, go through the list at [Before you begin](#).

---

1. From the printer control panel, touch **Setup** .
2. Touch **Network Setup**.
3. Touch **Wireless Settings**.
4. Touch **Wireless Setup Wizard** .
5. Follow the display instructions to complete the setup.

If you are already using the printer with a different type of connection, such as a USB connection, follow the instructions in [Change the connection type](#) to set up the printer on your wireless network.

## Change the connection type

After you have installed the HP printer software and connected the printer to your computer or to a network, you can use the software to change the connection type (for example, from a USB connection to a wireless connection).



---

**NOTE:** Connecting an Ethernet cable turns off the wireless capability of the printer.

---

### To change from an Ethernet connection to a wireless connection (Windows)

1. Remove the Ethernet cable from the printer.
2. Run the Wireless Setup Wizard to make the wireless connection. For more information, see [Set up the printer on your wireless network](#).

Open the printer software after the installation. For more information, see [Open the HP printer software \(Windows\)](#).

### To change from a USB connection to a wireless network (Windows)

Before you proceed, go through the list at [Before you begin](#).

1. Depending on your operating system, do one of the following:
  - **Windows 8.1:** Click the down arrow in lower left corner of the Start screen, select the printer name, and then click **Utilities**.
  - **Windows 8:** Right-click an empty area on the Start screen, click **All Apps** on the app bar, select the printer name, and then click **Utilities**.
  - **Windows 7, Windows Vista, and Windows XP:** From the computer desktop, click **Start**, select **All Programs**, click **HP**, click the folder of your printer.
2. Click **Printer Setup & Software**.
3. Select **Convert a USB connected printer to wireless**. Follow the onscreen instructions.

### To change from a USB or Ethernet connection to a wireless connection (OS X)

Before you proceed, go through the list at [Before you begin](#).

1. Connect the printer to your wireless network.
2. Open **System Preferences** .

3. Depending on your operating system, click **Print & Fax** , **Print & Scan** , or **Printers & Scanners** in the **Hardware** section.
4. Select your printer in the left pane and click - at the bottom of the list. Do the same for the fax entry, if there is one for the current connection.
5. Open HP Utility.  
HP Utility is located in the **Hewlett-Packard** folder in the **Applications** folder at the top level of the hard disk.
6. Choose **Devices > HP Auto Wireless Connect** and follow the prompts.



Learn more about how to change from a USB to wireless connection. [Click here to go online for more information.](#) At this time, this website might not be available in all languages.

### To change from a wireless connection to a USB or Ethernet connection (Windows)

- Connect the USB or Ethernet cable to the printer.

### To change from a wireless connection to a USB or Ethernet connection (OS X)



Add the printer to the print queue.

1. Open **System Preferences** .
2. Depending on your operating system, click **Print & Fax** , **Print & Scan** , or **Printers & Scanners** in the **Hardware** section.
3. Click + below the list of printers at the left.
4. Select the printer from the list of detected printers, and click **Add**.

## Test the wireless connection

Print the wireless test report for information about the printer wireless connection. The wireless test report provides information about the printer status, hardware (MAC) address, and IP address. If the printer is connected to a network, the test report displays details about the network settings.

To print the wireless test report

1. From the printer control panel, touch  (the **Wireless** button), and then touch  (the **Settings** button).
2. Touch **Print Reports**
3. Touch **Wireless Test Report**.

## Turn on or off the wireless capability of the printer

The blue Wireless light on the printer control panel is lit when the wireless capability of the printer is on.



**NOTE:** Connecting an Ethernet cable to the printer automatically turns off the wireless capability and the Wireless light.

1. From the printer control panel, touch **Setup** and then touch **Network Setup**.
2. Touch **Wireless Settings**.
3. Touch **Wireless** to turn it on or off.

# Change network settings

From the printer control panel, you can set up and manage your printer's wireless connection and perform a variety of network management tasks. This includes viewing and changing network settings, restoring network defaults, and turning the wireless function on or off.



---

**CAUTION:** Network settings are provided for your convenience. However, unless you are an advanced user, you should not change some of these settings (such as the link speed, IP settings, default gateway, and firewall settings).

---

## To print network settings

Use one of the following ways:

- From the printer control panel, touch  (Wireless) or  (Ethernet). The network status screen is displayed. Select **Print Details** to print the network configuration page.
- Print the network configuration page. For more information, see [Network configuration page](#).

## To set the link speed

You can change the speed at which data is transmitted over the network. The default is **Automatic**.

1. From the printer control panel, touch **Setup** and then touch **Network Setup**.
2. Touch **Ethernet Settings**.
3. Select **Advanced Settings**.
4. Touch **Link Speed**.
5. Touch the appropriate option that matches your network hardware.

## To change IP settings

The default IP setting for the IP settings is **Automatic**, which sets the IP settings automatically. If you are an advanced user and want to use different settings (such as the IP address, subnet mask, or the default gateway), you can change them manually.

---

**CAUTION:** Be careful when manually assigning an IP address. If you enter an invalid IP address during the installation, your network components cannot connect with the printer.

---

1. From the printer control panel, touch **Setup** and then touch **Network Setup**.
2. Touch **Ethernet Settings** or **Wireless Settings**.
3. Touch **Advanced Settings**.
4. Touch **IP Settings**.
5. A message appears warning that changing the IP address removes the printer from the network. Touch **OK** to continue.
6. **Automatic** is selected by default. To change the settings manually, touch **Manual**, and then enter the appropriate information for the following settings:
  - **IP Address**
  - **Subnet Mask**

- **Default Gateway**
  - **DNS Address**
7. Enter your changes, and then touch **Done** .
  8. Touch **OK** .

## Use HP wireless direct

With HP wireless direct, you can print wirelessly from a computer, smart phone, tablet, or other wireless-capable device—without connecting to an existing wireless network.

### Guidelines when using HP wireless direct

- Make sure your computer or mobile device has the necessary software.  
If you are using a computer, make sure you have installed the printer software provided with the printer.
- If you have not installed the HP printer software on the computer, connect to HP wireless direct first and then install the printer software. Select **Wireless** when prompted by the printer software for a connection type.
- If you are using a mobile device, make sure you have installed a compatible printing app. For more information about mobile printing, visit [www.hp.com/global/us/en/eprint/mobile\\_printing\\_apps.html](http://www.hp.com/global/us/en/eprint/mobile_printing_apps.html).
- Make sure HP wireless direct is turned on in the printer and, if necessary, security is enabled.
- Up to five computers and mobile devices can use the same HP wireless direct connection.
- HP wireless direct can be used while the printer is also connected either to a computer using a USB cable or to a network using a wireless connection.
- HP wireless direct cannot be used to connect a computer, mobile device, or printer to the Internet.

### To turn on HP wireless direct

1. From the printer control panel, touch  (HP wireless direct).
2. Touch **On** for **HP Wireless Direct**.

---

 **TIP:** If you would like to use HP wireless direct with greater security and if the computer or mobile device supports WPA2 encryption, touch **Security** to enable or disable security. With security enabled, only users with the password can connect wirelessly to the printer. Without enabling security, anyone with a wireless device within the wireless range of the printer can connect to the printer.

---

3. Touch **HP Wireless Direct Name** to display the HP wireless direct name.
4. If you have enabled security, touch **Security Password** to display the HP wireless direct password.

---

 **TIP:** You can also turn on HP wireless direct from the EWS. For more information about using the EWS, see [Embedded web server](#).

---

## To print from a wireless-capable mobile device

Make sure you have installed a compatible printing app on your mobile device. For more information, visit [www.hp.com/global/us/en/eprint/mobile\\_printing\\_apps.html](http://www.hp.com/global/us/en/eprint/mobile_printing_apps.html).

1. Make sure you have turned on HP wireless direct on the printer.
2. Turn on the Wi-Fi connection on your mobile device. For more information, see the documentation provided with the mobile device.



---

**NOTE:** If your mobile device does not support Wi-Fi, you are not able to use HP wireless direct.

---

3. From the mobile device, connect to a new network. Use the process you normally use to connect to a new wireless network or hotspot. Choose the HP wireless direct name from the list of wireless networks shown such as **HP-Print-\*\*-Officejet XXXX** (where \*\* are the unique characters to identify your printer and XXXX is the printer model located on the printer).

If HP wireless direct is turned on with security, enter the password when prompted.

4. Print your document.

## To print from a wireless-capable computer (Windows)

1. Make sure you have turned on HP wireless direct on the printer.
2. Turn on the computer's Wi-Fi connection. For more information, see the documentation provided with the computer.



---

**NOTE:** If your computer does not support Wi-Fi, you are not able to use HP wireless direct.

---

3. From the computer, connect to a new network. Use the process you normally use to connect to a new wireless network or hotspot. Choose the HP wireless direct name from the list of wireless networks shown such as **HP-Print-\*\*-Officejet XXXX** (where \*\* are the unique characters to identify your printer and XXXX is the printer model located on the printer).

If HP wireless direct is turned on with security, enter the password when prompted.

4. Proceed to step 5 if the printer has been installed and connected to the computer over a wireless network. If the printer has been installed and connected to your computer with a USB cable, follow the steps below to install the printer software using the HP HP wireless direct connection.
  - a. Depending on your operating system, do one of the following:
    - **Windows 8.1:** Click the down arrow in lower left corner of the Start screen, select the printer name, and then click **Utilities**.
    - **Windows 8:** Right-click an empty area on the Start screen, click **All Apps** on the app bar, select the printer name, and then click **Utilities**.
    - **Windows 7, Windows Vista, and Windows XP:** From the computer desktop, click **Start**, select **All Programs**, click **HP**, click the folder of your printer.
  - b. Click **Printer Setup & Software**, and then select **Connect a new printer**.
  - c. When the **Connection Options** software screen appears, select **Wireless**.  
Select your HP printer software from the list of detected printers.
  - d. Follow the on-screen instructions.
5. Print your document.

## To print from a wireless-capable computer (OS X)

1. Make sure you have turned on HP wireless direct on the printer.
2. Turn on Wi-Fi on the computer.

For more information, see the documentation provided by Apple.

3. Click the Wi-Fi icon and choose the HP wireless direct name, such as **HP-Print-\*\*-Officejet XXXX** (where \*\* are the unique characters to identify your printer and XXXX is the printer model located on the printer).

If HP wireless direct is turned on with security, enter the password when prompted.

4. Add the printer.
  - a. Open **System Preferences** .
  - b. Depending on your operating system, click **Print & Fax** , **Print & Scan** , or **Printers & Scanners** in the **Hardware** section.
  - c. Click + below the list of printers at the left.
  - d. Select the printer from the list of detected printers (the word “Bonjour” is listed the right column beside the printer name), and click **Add**.



[Click here](#) for online troubleshooting for HP wireless direct, or for more help with setting up HP wireless direct. At this time, this website might not be available in all languages.



---

# 9 Printer management tools

This section contains the following topics:

- [Toolbox \(Windows\)](#)
- [HP Utility \(OS X\)](#)
- [Embedded web server](#)

## Toolbox (Windows)

The Toolbox provides maintenance information about the printer.



**NOTE:** The Toolbox can be installed from the HP Software CD if the computer meets the system requirements. System requirements can be found in the Readme file, which is available on the HP printer software CD provided with your printer.

---

### To open the Toolbox

1. Open the HP printer software. For more information, see [Open the HP printer software \(Windows\)](#).
2. Click **Print, Scan & Fax**.
3. Click **Maintain Your Printer**.

## HP Utility (OS X)

HP Utility contains tools to configure print settings, calibrate the printer, order supplies online, and find website support information.



**NOTE:** The features available in HP Utility vary depending on the selected printer.

Ink level warnings and indicators provide estimates for planning purposes only. When you receive a low-ink warning message, consider having a replacement cartridge available to avoid possible printing delays. You do not need to replace cartridges until the print quality becomes unacceptable.

---

Double-click HP Utility in the **Hewlett-Packard** folder in the **Applications** folder at the top level of the hard disk.

## Embedded web server

When the printer is connected to a network, you can use the printer's embedded web server (EWS) to view status information, change settings, and manage it from your computer.



**NOTE:** To view or change some settings, you might need a password.



**NOTE:** You can open and use the embedded web server without being connected to the Internet. However, some features are not available.

---

- [About cookies](#)
- [Open the embedded web server](#)

- [Control panel lock](#)
- [Embedded web server cannot be opened](#)

## About cookies

The embedded Web server (EWS) places very small text files (cookies) on your hard drive when you are browsing. These files let the EWS recognize your computer the next time you visit. For example, if you have configured the EWS language, a cookie helps remember which language you have selected so that the next time you access the EWS, the pages are displayed in that language. Some cookies (such as the cookie that stores customer-specific preferences) are stored on the computer until you clear them manually.

You can configure your browser to accept all cookies, or you can configure it to alert you every time a cookie is offered, which allows you to decide which cookies to accept or refuse. You can also use your browser to remove unwanted cookies.

Depending on your printer, if you disable cookies, you also disable one or more of the following features:

- Using some setup wizards
- Remembering the EWS browser language setting
- Personalizing the EWS Home page

For information about how to change your privacy and cookie settings and how to view or delete cookies, see the documentation available with your Web browser.

## Open the embedded web server

You can access the embedded web server through either a network or HP wireless direct.

### To open the embedded web server through a network

1. Find out the IP address or hostname of the printer from the network configuration page.  
For more information, see [Network configuration page](#).
2. In a supported web browser on your computer, type the IP address or hostname assigned to the printer.  
For example, if the IP address is 123.123.123.123, type the following address into the web browser:  
`http://123.123.123.123`

### To open the embedded web server through HP wireless direct

1. Touch  (HP wireless direct) from the printer control panel display.
2. If the display shows that HP wireless direct is **Off**, touch **HP Wireless Direct** to turn it on.
3. From your wireless computer, turn wireless on, search for and connect to the HP wireless direct name. If you have HP wireless direct security on, enter the HP wireless direct password when prompted.
4. In a supported web browser on your computer, type the following address: `http://192.168.223.1`.

## Control panel lock

To prevent unauthorized use of certain features on the printer control panel, you can lock the features from the embedded web server (EWS).

Once the control panel lock is turned on, certain features will not be accessible from the control panel. The setting for control panel lock itself can also be secured by setting an administrator password in EWS. The password must be entered when accessing the setting for turning on or off the control panel lock.

## Embedded web server cannot be opened

### Check your network setup

- Make sure you are not using a phone cord or a crossover cable to connect the printer to the network.
- Make sure the network cable is securely connected to the printer.
- Make sure the network hub, switch, or router is turned on and working correctly.

### Check the computer

- Make sure the computer that you are using is connected to the network.



**NOTE:** You may also access the EWS if the printer's HP wireless direct is turned on, and you know the printer's IP address.

---

### Check your web browser

- Make sure the web browser meets the minimum system requirements. For more information, see system requirements in the printer's Readme file found on the HP printer software CD.
- If your web browser uses any proxy settings to connect to the Internet, try turning off these settings. For more information, see the documentation available with your web browser.
- Make sure JavaScript and cookies are enabled in your web browser. For more information, see the documentation available with your web browser.

### Check the printer IP address

- To check the IP address of the printer, obtain the IP address by printing a network configuration page. From the printer control panel display, touch **Setup**, touch **Reports**, and then touch **Network Configuration Report**.
- Ping the printer using the IP address from the command prompt (Windows) or from Network Utility (OS X).



**NOTE:** OS X Lion and OS X Mountain Lion: Network Utility is located in the **Utilities** folder in the **Applications** folder at the top level of the hard disk.

OS X Mavericks: Open **Finder**, hold down the Option key and choose **System Information** from the **Apple** () menu. Choose **Window > Network Utility**.

---

For example, if the IP address is 123.123.123.123, type the following at the command prompt (Windows):

```
C:\>ping 123.123.123.123
```

Or

In Network Utility (OS X), click the **Ping** tab, type the 123.123.123.123 in the box, and then click **Ping**.

If a reply appears, the IP address is correct. If a time-out response appears, the IP address is incorrect.



**TIP:** If you are using a computer running Windows, you can visit the HP online support website at [www.hp.com/support](http://www.hp.com/support). This website provides information and utilities that can help you correct many common printer problems.

---

---

# 10 Solve a problem

The information in this section suggests solutions to common problems. If your printer is not operating correctly and these suggestions did not solve your problem, try using one of the support services listed in [HP support](#) to obtain assistance.

This section contains the following topics:

- [HP support](#)
- [Get help from the printer control panel](#)
- [Understand printer reports](#)
- [Solve printer problems](#)
- [Solve printing problems](#)
- [Solve copy problems](#)
- [Solve scan problems](#)
- [Solve fax problems](#)
- [Solve problems using Web Services](#)
- [Solve network problems](#)
- [Maintain the printer](#)
- [Clear paper jams](#)
- [Clear the print carriage](#)
- [Restore defaults and settings](#)

## HP support

- [Register printer](#)
- [Support process](#)
- [Obtain electronic support](#)
- [HP support by phone](#)

## Register printer

By taking just a few quick minutes to register, you can enjoy quicker service, more efficient support, and product support alerts. If you did not register your printer while installing the software, you can register now at <http://www.register.hp.com>.

## Support process

If you have a problem, follow these steps:

1. Check the documentation that came with the printer.
2. Visit the HP online support website at [www.hp.com/support](http://www.hp.com/support).

HP online support is available to all HP customers. It is the fastest source for up-to-date product information and expert assistance, and includes the following features:

- Fast access to qualified online support specialists
  - Software and driver updates for the printer
  - Valuable troubleshooting information for common problems
  - Proactive printer updates, support alerts, and HP newsgrams that are available when you register the printer
3. Call HP support. For more information, see [HP support by phone](#).

Support options and availability vary by printer, country/region, and language.

## Obtain electronic support

To find support and warranty information, go to the HP website at [www.hp.com/support](http://www.hp.com/support). This website provides information and utilities that can help you correct many common printer problems. If prompted, select your country/region, and then click **All HP Contacts** for information about calling for technical support.

This website also offers technical support, drivers, supplies, ordering information and other options such as:

- Access online support pages.
- Send HP an email message for answers to your questions.
- Connect with an HP technician by using online chat.
- Check for HP software updates.

You can also obtain support from the HP software for Windows or OS X, which provide easy, step-by-step solutions to common printing problems. For more information, see [Printer management tools](#).

Support options and availability vary by printer, country/region, and language.

## HP support by phone

Phone support options and availability vary by printer, country/region, and language.

This section contains the following topics:

- [Before you call](#)
- [Phone support period](#)
- [Support phone numbers](#)
- [After the phone support period](#)

## Before you call

Call HP support while you are in front of the printer and a computer it is connected to. Be prepared to provide the following information:

- Model number
- Serial number (located on the back or bottom of the printer)
- Messages that appear when the situation occurs
- Answers to these questions:
  - Has this situation happened before?
  - Can you re-create it?
  - Did you add any new hardware or software to your computer at about the time that this situation began?
  - Did anything else occur prior to this situation (such as a thunderstorm or moving the printer)?

If you need to call HP, it is often useful to print the printer status report before calling.

## Phone support period

One year of phone support is available in North America, Asia Pacific, and Latin America (including Mexico). To determine the duration of phone support in Europe, the Middle East, and Africa, go to [www.hp.com/support](http://www.hp.com/support). Standard phone company charges apply.

## Support phone numbers

For the most current HP list of telephone support numbers and call costs information, see [www.hp.com/support](http://www.hp.com/support).

## After the phone support period

After the phone support period, help is available from HP at an additional cost. Help may also be available at the HP online support website: [www.hp.com/support](http://www.hp.com/support). Contact your HP dealer or call the support phone number for your country/region to learn more about support options.

## Get help from the printer control panel

You can use the printer's help topics to learn more about the printer, and some help topics include animations that guide you through procedures, such as clearing jams.

To open the help topics from the printer control panel, touch “ (Help) from the Home screen.

## Understand printer reports

You can print the following reports to help troubleshoot problems with the printer.

- [Printer status report](#)
- [Network configuration page](#)
- [Print quality report](#)
- [Wireless test report](#)
- [Web access report](#)

## Printer status report

Use the printer status report to view current printer information and ink cartridge status. Also use the printer status report to help you troubleshoot problems with the printer.

The printer status report also contains a log of recent events.

If you need to call HP, it is often useful to print the printer status report before calling.

### To print the Printer Status Report

1. From the printer control panel, touch **Setup**.
2. Touch **Reports** and then touch **Printer Status Report**.



1. **Product Information:** Shows printer information (such as the printer name, model number, serial number, and firmware version number), and the accessories that are installed (such as the automatic two-sided printing accessory or duplexer).
2. **Print Usage Information:** Shows summary information about pages printed from the printer.
3. **Ink Delivery System Information:** Shows the estimated ink levels (represented in graphical form as gauges) and the part numbers and warranty expiration dates for the ink cartridges.

**NOTE:** Ink level warnings and indicators provide estimates for planning purposes only. When you receive a low-ink warning message, consider having a replacement cartridge available to avoid possible printing delays. You do not need to replace cartridges until the print quality becomes unacceptable.

4. **Additional Assistance:** Provides information about where you can go to get more information about the printer, as well as information about how to set up a Fax Test and how to run a Wireless Network Test.

## Network configuration page

If the printer is connected to a network, you can print a network configuration page to view the network settings for the printer and a list of networks detected by your printer. The last page of the report includes a list of all detectable wireless networks in the area, along with signal strength and the channels being used. This might help you select a channel for your network which is not heavily used by other networks (which will improve network performance).

You can use the network configuration page to help troubleshoot network connectivity problems. If you need to call HP, it is often useful to print this page before calling.

### To print the network configuration page

1. From the printer control panel, touch **Setup** .
2. Touch **Reports** and then touch **Network Configuration Report**.



## HP Network Configuration Page

Model : HP Officejet 6820 e-All-in-One

1	<b>General Information</b>			
	Network Status		Ready	
	Active Connection Type		Wireless	
	URL(s) for Embedded Web Server		http://dchppc19	
			http://192.168.0.21	
	Firmware Revision		PNL2CA1339AR	
	Hostname		dchppc19	
Serial Number		TH36110955		
Internet		Connected		
2	<b>802.3 Wired</b>			
	Hardware Address (MAC)		74:46:a0:ce:5c:1a	
	Link Configuration		None	
3	<b>802.11 Wireless</b>			
	Hardware Address (MAC)		74:46:a0:ce:53:16	
	Status		Connected	
	Communication Mode		Infrastructure	
	Network Name (SSID)		myqwest8935	
	Access Point HW Address		40:4a:03:dc:42:f5	
	Signal Quality (1 – 5)		5	
	Channel		1	
	Authentication Type		WPA-PSK	
	Encryption		Automatic (AES or TKIP)	
	<b>IPv4</b>			
	IP Address		192.168.0.21	
	Subnet Mask		255.255.255.0	
	Default Gateway		192.168.0.1	
	Configuration Source		DHCP	
	Primary DNS Server		192.168.0.1	
	Secondary DNS Server		206.171.3.25	
	Total Packets Transmitted		261	
	Total Packets Received		214	
<b>IPv6</b>				
Primary DNS Server		::		
Secondary DNS Server		::		
Address	Prefix Length	Configured By		
FE80::7646:ADFF:FECE:5316	64	Self		

### Wireless Direct

You cannot use the device's wireless function because it has been disabled. For more information, contact your network administrator or the person who set up the device.

- 1. General Information:** Shows information about the current status and active connection type of the network, and other information, such as the URL of the embedded web server.
- 2. 802.3 Wired:** Shows information about the active Ethernet network connection, such as the IP address, subnet mask, default gateway, as well as the hardware address of the printer.
- 3. 802.11 Wireless:** Shows information about your wireless network connection, such as the host name, IP address, subnet mask, default gateway, and server. It also indicates the network name (SSID), the relative signal strengths and the channels being used. You can check the network list to view if your own network signal strength is good and change the wireless communication setup using Wireless Setup Wizard. For more information, see [Change the connection type](#).

4. **HP wireless direct:** Shows information about your HP wireless direct connection, such as the network name (SSID), IP address, subnet mask, default gateway, and server.
5. **Miscellaneous:** Shows information about more advanced network settings.
  - **Port 9100:** The printer supports raw IP printing through TCP Port 9100. This HP-proprietary TCP/IP port on the printer is the default port for printing. It is accessed by HP software (for example, the HP Standard Port).
  - **Bonjour:** Bonjour services (which use mDNS, or Multicast Domain Name System) are typically used on small networks for IP address and name resolution (through UDP port 5353), where a conventional DNS server is not used.
  - **SLP:** Service Location Protocol (SLP) is an Internet standard network protocol that provides a framework to allow networking applications to discover the existence, location, and configuration of networked services in enterprise networks. This protocol simplifies discovery and use of network resources such as printers, web servers, fax machines, video cameras, files systems, backup devices (tape drives), databases, directories, mail servers, calendars.
  - **Microsoft Web Services:** Enable or disable the Microsoft Web Services Dynamic Discovery (WS Discovery) protocols or Microsoft Web Services for Devices (WSD) Print services supported on the printer. Disable unused print services to prevent access through those services.



---

**NOTE:** For more information about WS Discovery and WSD Print, visit [www.microsoft.com](http://www.microsoft.com).

---

- **IPP:** Internet Printing Protocol (IPP) is a standard network protocol for remote printing. Unlike other remote IP-based protocols, IPP supports access control, authentication, and encryption, allowing for more secure printing.
- **Proxy Settings:** Shows information about proxy address, port, and the status of authentication. You can change the proxy settings from EWS.

To change the proxy settings, click **Network** from EWS, click **Proxy Settings**, and select the appropriate options.

## Print quality report

Print quality problems can have many causes—software settings, a poor image file, or the printing system itself. If you are unhappy with the quality of your prints, a Print Quality Diagnostic page can help you determine if the printing system is working correctly.

### To print a print quality report

1. From the printer control panel, touch **Setup** .
2. Touch **Reports** .
3. Touch **Print Quality Report**.

HP Officejet ~~8600~~ ~~in-Color Series~~  
Print Quality Diagnostic Page

---

**Printer Information**

Product model number: B6T06A  
Product serial number: TH36110955  
Service ID: 23265  
Firmware Version: PNL2CA1339AR  
Pages printed: Tray 1=5, Total=5, Auto-duplex unit=0  
Ink cartridge level\*: K=100, Y=90, M=90, C=90  
\*Estimates only. Actual ink levels may vary.

**Test Pattern 1**

If the lines are not straight and connected, align the printheads.



**Test Pattern 2**

If you see thin white lines across any of the colored blocks, clean the printheads.

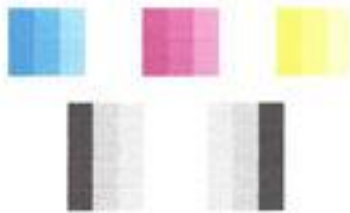

**Test Pattern 3**

If you see dark lines or white gaps where the arrows are pointing, align printhead.

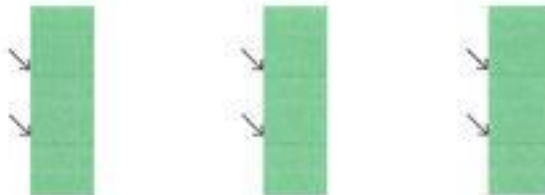

If defects are seen on the page, follow the steps below:

1. If the Print Quality report shows faded, partial, streaked, or missing color bars or patterns, check for depleted ink cartridges, and replace the ink cartridge that corresponds to the defective color bar or color pattern. If there is no depleted ink cartridge, remove and reinstall all ink cartridges to make sure they are properly installed.

Do not remove the depleted cartridge until you have a new ink cartridge available to replace. For information about how to install new cartridges, see [Replace the ink cartridges](#).



2. If the lines in Test Pattern 1 are not straight and connected, align the printer. For more information, see [Maintain the printhead and ink cartridges](#).
3. If you see white lines across any of the color blocks in Test Pattern 2, clean the printhead. For more information, see [Maintain the printhead and ink cartridges](#).

4. If you see white or dark lines where the arrows are pointing in Test Pattern 3, align the printhead. For more information, see [Maintain the printhead and ink cartridges](#).
5. If none of the previous steps have helped, contact HP support to replace the printhead. For more information, see [HP support](#).

## Wireless test report

Print the wireless test report for information about the printer wireless connection. The wireless test report provides information about the printer status, hardware (MAC) address, and IP address. If the printer is connected to a network, the test report displays details about the network settings.

### To print the wireless test report

1. From the printer control panel, touch  (the Wireless button), and then touch  (the **Settings** button).
2. Touch **Print Reports**.
3. Touch **Wireless Test Report**.

## Web access report

Print the web access report to help identify internet connectivity issues which can affect Web Services.

### To print the web access report

1. From the printer control panel, touch **Setup**.
2. Touch **Reports**.
3. Touch **Web Access Report**.

## Solve printer problems

---

 **TIP:** (Windows) Run the [HP Print and Scan Doctor](#) to diagnose and automatically fix printing, scanning, and copying issues. The application is only available in some languages.

---

### The printer shuts down unexpectedly

- Check the power and power connections.
- Make sure the printer's power cord is connected firmly to a functioning power outlet.

### Printhead alignment fails

- If the alignment process fails, make sure you have loaded unused, plain white paper into the input tray. If you have colored paper loaded in the input tray when you align the ink cartridges, the alignment fails.
- If the alignment process fails repeatedly, you may need to clean the printhead, or you might have a defective sensor. To clean the printhead, see [Maintain the printhead and ink cartridges](#).
- If cleaning the printhead does not solve the problem, contact HP support. Go to [www.hp.com/support](http://www.hp.com/support). This website provides information and utilities that can help you correct many common printer problems. If prompted, select your country/region, and then click **All HP Contacts** for information on calling for technical support.

## Paper-feed problems

- **Paper is not picked up from a tray**
  - Make sure paper is loaded in the tray. For more information, see [Load paper](#). Fan the paper before loading.
  - Make sure the paper-width guides are set to the correct markings in the tray for the paper size you are loading. Also make sure the paper guides are snug, but not tight, against the stack.
  - Ensure that the stack of paper is aligned with the appropriate paper size lines on the bottom of the input tray, and does not exceed the stack height marking on the side of the tray.
  - Ensure that the stack of paper is aligned with the appropriate paper size lines on the bottom of the input tray, and does not exceed the stack height marking on the side of the tray.
  - Make sure paper in the tray is not curled. Uncurl paper by bending it in the opposite direction of the curl.
- **Pages are skewing**
  - Make sure the paper loaded in the input tray is aligned to the paper-width guides. If needed, pull out the input tray from the printer and reload the paper correctly, making sure that the paper guides are aligned correctly.
  - Load paper into the printer only when it is not printing.
- **Multiple pages are being picked up**
  - Make sure the paper-width guides are set to the correct markings in the tray for the paper size you are loading. Also make sure the paper-width guides are snug, but not tight, against the stack.
  - Ensure that the stack of paper is aligned with the appropriate paper size lines on the bottom of the input tray, and does not exceed the stack height marking on the side of the tray.
  - Make sure the tray is not overloaded with paper.
  - Ensure that the stack of paper is aligned with the appropriate paper size lines on the bottom of the input tray, and does not exceed the stack height marking on the side of the tray.
  - Use HP paper for optimum performance and efficiency.

## Solve printing problems

---

 **TIP:** (Windows) Run the [HP Print and Scan Doctor](#) to diagnose and automatically fix printing, scanning, and copying issues. The application is only available in some languages.

---

### The printer is not responding (nothing prints)

- **There are print jobs stuck in the print queue**

Open the print queue, cancel all documents, and then reboot the computer. Try to print after the computer reboots. Refer to the Help system for the operating system for more information.
- **Check the HP software installation**

If the printer is turned off when printing, an alert message should appear on your computer screen; otherwise, the HP software provided with the printer might not be installed correctly. To resolve this, uninstall the HP software completely, and then reinstall the HP software.
- **Check the cable connections**

Make sure both ends of the USB cable or Ethernet cable are secure.

If the printer is connected to a network, check the following:

- Check the Link light on the back of the printer above the power input.
- Make sure you are not using a phone cord to connect the printer.

- **Check the printer's wireless connection**

If the printer is connected to the network with a wireless connection, check that the blue Wireless light is on and not blinking. A blinking light indicates there is connection problem between the printer and the network. You can print a Wireless Test Report to help diagnose any issues.

- **Check any personal firewall software installed on the computer**

The personal software firewall is a security program that protects a computer from intrusion. However, the firewall might block communication between the computer and the printer. If there is a problem communicating with the printer, try temporarily disabling the firewall. If the problem persists, the firewall is not the source of the communication problem. Re-enable the firewall.



Use this troubleshooter to help you get your printer on the network if you have a firewall or antivirus protection that is causing a problem. [Click here to go online for more information](#). At this time, this website might not be available in all languages.

- **Restart the printer and the computer**

If the printer is still not responding, turn off the printer and the computer, and turn them back on.



If the above solutions do not resolve the problem, [click here for more online troubleshooting](#).

### Something on the page is missing or incorrect

- Try the solutions in **Print quality is not acceptable**
- **Check the printer location and length of USB cable**

High electromagnetic fields (such as those generated by USB cables) can sometimes cause slight distortions to printouts. Move the printer away from the source of the electromagnetic fields. Also, it is recommended that you use a USB cable that is less than 3 meters (9.8 feet) long to minimize the effects of these electromagnetic fields.

### Print quality is not acceptable

1. Make sure you are using genuine HP ink cartridges. Genuine HP ink cartridges are designed and tested with HP printers to help you easily produce great results, time after time.

---

 **NOTE:** HP cannot guarantee the quality or reliability of non-HP supplies. Printer service or repairs required as a result of using a non-HP supply are not covered under warranty.

If you believe you purchased genuine HP ink cartridges, go to:

[www.hp.com/go/anticounterfeit](http://www.hp.com/go/anticounterfeit)

---

2. Check the ink levels. The ink cartridges might have insufficient ink.

 **NOTE:** Ink level alerts and indicators provide estimates for planning purposes only. When you receive a low-ink alert, consider having a replacement cartridge available to avoid possible printing delays. You do not need to replace the ink cartridges until the print quality becomes unacceptable.

 **CAUTION:** While ink cartridges are not damaged when left outside of the printer, the printhead does need to have all cartridges installed at all times after the printer is set up and in use. Leaving one or more cartridge slots empty for an extended period may lead to print quality problems and possibly damage the printhead. If you have recently left a cartridge out of the printer for an extended period, or if you have had a recent paper jam, and have noticed poor print quality, clean the printhead. For more information, see [Maintain the printhead and ink cartridges](#).

---

For more information, see [Check the estimated ink levels](#).

3. Check the paper loaded in the input tray. Make sure the paper is loaded correctly and that it is not wrinkled or too thick.

- Load paper with the print side facing down. For example, if you are loading glossy photo paper, load the paper with the glossy side down.
- Make sure the paper lays flat in the input tray and is not wrinkled. If the paper is too close to the printhead during printing, the ink might be smeared. This can happen if the paper is raised, wrinkled, or very thick, such as a mailing envelope.

For more information, see [Load paper](#).

4. Check the paper type.

HP recommends that you use HP papers or any other paper type with ColorLok technology that is appropriate for the printer. All papers with the ColorLok logo are independently tested to meet high standards of reliability and print quality, and produce documents with crisp, vivid color, bolder blacks and dry faster than ordinary plain papers. For more information, see [Paper basics](#).

Always make sure the paper you are printing on is flat. For best results when printing images, use HP Advanced Photo Paper.

Store specialty paper in its original packaging inside a resealable plastic bag on a flat surface in a cool, dry place. When you are ready to print, remove only the paper you plan to use immediately. When you have finished printing, return any unused photo paper to the plastic bag. This prevents the photo paper from curling.

5. Check the print settings by clicking the button that opens the **Properties** dialog box. (Depending on your software application, this button might be called **Properties**, **Options**, **Printer Setup**, **Printer Properties**, **Printer**, or **Preferences**.)

- Check the print settings in the printer driver to see if the color settings are incorrect.  
For example, check to see if the document is set to print in grayscale. Or, check to see if advanced color settings such as saturation, brightness, or color tone, are set to modify the appearance of colors.
- Check the print quality setting and make sure it matches the type of paper loaded in the printer.

You might need to choose a lower print quality setting if colors are running into each other. Or, choose a higher setting if you are printing a high-quality photo, and then make sure photo paper such as HP Advanced Photo Paper is loaded in the input tray.

---

 **NOTE:** On some computer screens, colors might appear differently than they do when printed on paper. In this case, there is nothing wrong with the printer, print settings, or ink cartridges. No further troubleshooting is required.

---

6. Print and evaluate a print quality report. To print this report, see [Print quality report](#).



Use this document to help resolve print quality issues. [Click here to go online for more information.](#)

At this time, this website might not be available in all languages.

## Solve copy problems

---

 **TIP:** (Windows) Run the [HP Print and Scan Doctor](#) to diagnose and automatically fix printing, scanning, and copying issues. The application is only available in some languages.

---

### Copies are blank or faded

- The contrast setting might be set too light. From the printer control panel display, touch **Copy**, touch  (**Copy Settings**), touch **Lighter/Darker**, and then use the arrows to create darker copies.
- The quality setting of **Fast** (which produces draft-quality copies) might be responsible for the missing or faded documents. Change to the **Normal** or **Best** setting.

### Size is reduced

- The reduce/enlarge or other copy feature might have been set from the printer control panel to reduce the scanned image. Check the settings for the copy job to make sure that they are for normal size.
- A dirty scanner glass might reduce the scanned image. Clean the scanner glass or lid backing. For more information, see [Maintain the printer](#).
- This incoming page size may be larger than the original currently loaded.

### Copy quality is poor

- **Check the printer**
  - The scanner lid might not be closed correctly.
  - The scanner glass or lid backing might need cleaning. For more information, see [Maintain the printer](#).
  - If the printer has a document feeder, it might need cleaning. For more information, see [Maintain the printer](#).
- **Unwanted lines**

The scanner glass, lid backing, or frame might need cleaning. For more information, see [Maintain the printer](#).
- **Copy is slanted or skewed**

If you are using the document feeder, check the following:



- Make sure that the document feeder input tray is not too full.
- Make sure that the document feeder width adjusters are snug against the sides of the paper.

For more information, see [Load an original in the document feeder](#).

- **Horizontal grainy or white bands in light-gray to medium-gray areas**

The default enhancement setting might not be suitable for the job. Check the setting and change it to enhance text or photographs, if needed. For more information, see [Copy](#).



Get online troubleshooting and learn more about how to solve copy issues. [Click here to go online for more information](#). At this time, this website might not be available in all languages.

## Solve scan problems

---

 **TIP:** (Windows) Run the [HP Print and Scan Doctor](#) to diagnose and automatically fix printing, scanning, and copying issues. The application is only available in some languages.

---

### Scanner did nothing

- **Check the original**

Make sure that the original is loaded correctly. For more information, see [Load an original on the scanner glass](#) or [Load an original in the document feeder](#).

- **Check the printer**

The printer might be coming out of Sleep mode after a period of inactivity, which delays processing a short while.

- **Check the HP software**

Make sure that the HP software provided with the printer is installed correctly.

- **Windows:** Open the HP printer software. For more information, see [Open the HP printer software \(Windows\)](#). In the window that appears, select **Print, Scan & Fax** or **Print & Scan**, and then select **Scan a Document or Photo** under **Scan**.

- **OS X:** Open HP Utility. For more information, see [HP Utility \(OS X\)](#). Under **Scan Settings**, select **Scan to Computer**, and ensure that **Enable Scan to Computer** is selected.

### Scan takes too long

- Scanning with higher scan resolution takes longer and results in larger file sizes. Lower the resolution to scan more quickly.
- If you sent a print or copy job before you tried to scan, the scan starts if the scanner is not busy. However, the printing and scanning processes share memory, which means that the scan might be slower.

### Part of the document did not scan or text is missing

- **Check the original**

- Make sure that you loaded the original correctly.

For more information, see [Load an original on the scanner glass](#) or [Load an original in the document feeder](#).

- If you scanned the document from the document feeder, try scanning the document directly from the scanner glass.

For more information, see [Load an original on the scanner glass](#).

- Colored backgrounds can cause images in the foreground to blend into the background. Try adjusting the settings before you scan the original, or try enhancing the image after you scan the original.

- **Check the settings**

- Make sure that the paper size loaded in the input tray is large enough for the original that you are scanning.
- If you are using the HP printer software, the default settings in the printer software might be set to automatically perform a specific task other than the one that you are attempting. See the on-screen Help for the printer software for instructions about changing the properties.

### **Text cannot be edited**

- **Make sure that the OCR (optical character recognition) program has been installed:**

Depending on your operating system, do one of the following:

- **Windows 8.1:** Click the down arrow in lower left corner of the Start screen, select the printer name, and then click **Utilities**. Select **Printer Setup & Software**. Click **Add more software**, click **Customize Software Selections**, and make sure the OCR option is selected.
- **Windows 8:** Right-click an empty area on the Start screen, click **All Apps** on the app bar, select the printer name, and then click **Utilities**. Select **Printer Setup & Software**. Click **Add more software**, click **Customize Software Selections**, and make sure the OCR option is selected.
- **Windows 7, Windows Vista, and Windows XP:** From the computer desktop, click **Start**, select **All Programs**, click **HP**, select your printer name, and then select **Printer Setup & Software**. Click **Add more software**, click **Customize Software Selections**, and make sure the OCR option is selected.

When you scan the original, make sure that you select a document type in the software that creates editable text. If text is classified as a graphic, it is not converted to text.

If you are using a separate OCR program, the OCR program might be linked to a word-processing program that does not perform OCR tasks. For more information, see the documentation provided with the OCR program.

Make sure you have selected an OCR language that corresponds to the language used for the document you are scanning. For more information, see the documentation provided with the OCR program.

- **Check the originals**

- Make sure that you loaded the original correctly.

For more information, see [Load an original on the scanner glass](#) or [Load an original in the document feeder](#).

- Make sure the document is not skewed.
- The software might not recognize text that is tightly spaced. For example, if the text that the software converts has missing or combined characters, "rn" might appear as "m."

- The accuracy of the software depends on the image quality, text size, and structure of the original and the quality of the scan itself. Make sure that your original has good image quality.
- Colored backgrounds can cause images in the foreground to blend too much.

### Scanned image quality is poor

- **Text or images on the back of a two-sided original appear in the scan**

Two-sided originals can "bleed" text or images from the back side to the scan if the originals are printed on paper that is too thin or too transparent.

- **Unwanted lines**

Ink, glue, correction fluid, or an unwanted substance might be on the scanner glass. Try cleaning the scanner glass.

For more information, see [Maintain the printer](#).

- **The scanned image is skewed (crooked)**

The original might have been loaded incorrectly. Be sure to use the paper-width guides when you load the originals into the document feeder. For more information, see [Load an original in the document feeder](#).

For best results, use the scanner glass for scanning rather than the document feeder. For more information, see [Load an original on the scanner glass](#).

- **The scanned image shows blots, lines, vertical white stripes, or other defects**

- If the scanner glass is dirty, the image produced does not have optimum clarity.

See [Maintain the printer](#) for cleaning instructions.

- The defects might be on the original and are not a result of the scanning process.

- **Size is reduced**

The HP printer software settings might be set to reduce the scanned image.

See the HP printer software Help for more information about changing the settings.

### Unable to scan to email

- **The email profile has not been set up correctly**

Make sure the valid outgoing SMTP server settings have been specified in the HP software. For more information about the SMTP server settings, see the documentation provided by your email service provider.

- **Email messages are sent to some recipients but not to others when sending to multiple recipients**

The email addresses might not be correct or might not be recognized by the email server. Make sure that the email addresses for all email recipients have been entered correctly in the HP software. Check your email Inbox for any delivery notification failure messages from the email server.

- **Sending large email messages**

Some email servers have been configured to reject email messages larger than a pre-determined size. To determine if your email server has a maximum file-size limit, see the documentation provided by your email service provider. If the email server does have such a limit, change the maximum email attachment size for the outgoing email profile to a value smaller than that of the email server.



For online troubleshooting and to learn more about how to solve scan issues. [Click here to go online for more information.](#) At this time, this website might not be available in all languages.

## Solve fax problems

This section contains fax setup troubleshooting information for the printer. If the printer is not set up correctly for faxing, you might experience problems when sending faxes, receiving faxes, or both.

If you are having faxing problems, you can print a fax test report to check the status of the printer. The test fails if the printer is not set up correctly for faxing. Perform this test after you have completed setting up the printer for faxing.

If the test fails, review the report for information on how to fix any problems found. Learn more information about running fax test, [click here to go online for more information.](#)



If you are having problems faxing [click here for online troubleshooting](#) to resolve the problem. At this time, this website might not be available in all languages.

For further assistance, visit the HP online support site [www.hp.com/support](http://www.hp.com/support).

- [The fax test failed](#)
- [The display always shows Phone Off Hook](#)
- [The printer is having problems sending and receiving faxes](#)
- [The printer cannot receive faxes, but can send faxes](#)
- [The printer cannot send faxes, but can receive faxes](#)
- [Fax tones are recorded on my answering machine](#)
- [The phone cord that came with my printer is not long enough](#)
- [The computer cannot receive faxes \(HP Digital Fax\)](#)

### The fax test failed

If you ran a fax test and the test failed, review the report for basic information about the error. For more detailed information, check the report to see which part of the test failed, and then review the appropriate topic in this section for solutions to try.

#### The "Fax Hardware Test" failed

- Turn the printer off by pressing  (the Power button) located on the printer control panel and then unplug the power cord from the back of the printer. After a few seconds, plug the power cord in again, and then turn the power on. Run the test again. If the test fails again, continue reviewing the troubleshooting information in this section.
- Try to send or receive a test fax. If you can send or receive a fax successfully, there might not be a problem.
- If you are running the test from the **Fax Setup Wizard** (Windows) or **HP Utility** (OS X), make sure the printer is not busy completing another task, such as receiving a fax or making a copy. Check the display for a message indicating that the printer is busy. If it is busy, wait until it is finished and in the idle state before running the test.

- Make sure you use the phone cord that came with the printer. If you do not use the supplied phone cord to connect from the telephone wall jack to the printer, you might not be able to send or receive faxes. After you plug in the phone cord that came with the printer, run the fax test again.
- If you are using a phone splitter, this can cause faxing problems. (A splitter is a two-cord connector that plugs into a telephone wall jack.) Try removing the splitter and connecting the printer directly to the telephone wall jack.

After you resolve any problems found, run the fax test again to make sure it passes and the printer is ready for faxing. If the **Fax Hardware Test** continues to fail and you experience problems faxing, contact HP support. Go to [www.hp.com/support](http://www.hp.com/support). This website provides information and utilities that can help you correct many common printer problems. If prompted, select your country/region, and then click **All HP Contacts** for information on calling for technical support.

### The "Fax Connected to Active Telephone Wall Jack" test failed

- Check the connection between the telephone wall jack and the printer to make sure the phone cord is secure.
- Make sure you use the phone cord that came with the printer. If you do not use the supplied phone cord to connect from the telephone wall jack to the printer, you might not be able to send or receive faxes. After you plug in the phone cord that came with the printer, run the fax test again.
- Make sure you have correctly connected the printer to the telephone wall jack. Using the phone cord supplied in the box with the printer, connect one end to your telephone wall jack, then connect the other end to the port labeled 1-LINE on the back of the printer.

Learn more about fax setup and test, [click here to go online for more information](#).

- If you are using a phone splitter, this can cause faxing problems. (A splitter is a two-cord connector that plugs into a telephone wall jack.) Try removing the splitter and connecting the printer directly to the telephone wall jack.
- Try connecting a working phone and phone cord to the telephone wall jack that you are using for the printer and check for a dial tone. If you do not hear a dial tone, contact your telephone company and have them check the line.
- Try to send or receive a test fax. If you can send or receive a fax successfully, there might not be a problem.

After you resolve any problems found, run the fax test again to make sure it passes and the printer is ready for faxing.

### The "Phone Cord Connected to Correct Port on Fax" test failed

Make sure you use the phone cord that came with the printer. If you do not use the supplied phone cord to connect from the telephone wall jack to the printer, you might not be able to send or receive faxes. After you plug in the phone cord that came with the printer, run the fax test again.

If you are using a phone splitter, this can cause faxing problems. (A splitter is a two-cord connector that plugs into a telephone wall jack.) Try removing the splitter and connecting the printer directly to the telephone wall jack.

#### Plug the phone cord into the correct port

1. Using the phone cord supplied in the box with the printer, connect one end to your telephone wall jack, then connect the other end to the port labeled 1-LINE on the back of the printer.



**NOTE:** If you use the 2-EXT port to connect to the telephone wall jack, you cannot send or receive faxes. The 2-EXT port should only be used to connect other equipment, such as an answering machine.

**Figure 10-1** Back view of the printer

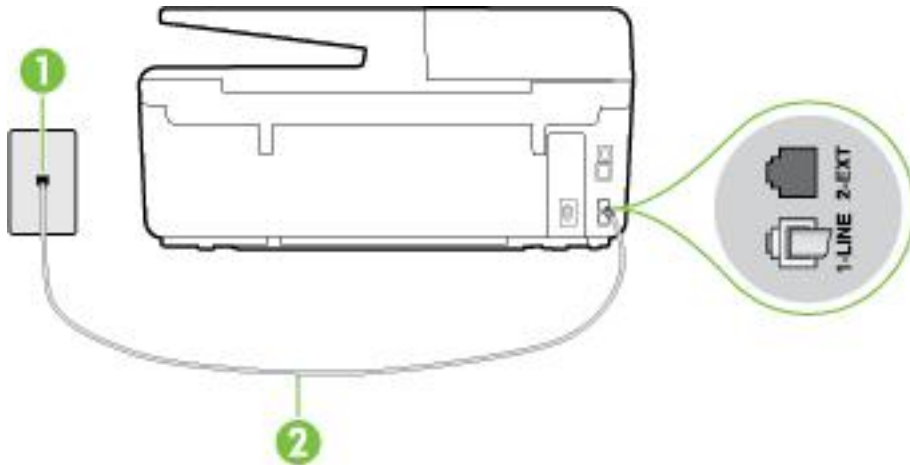

1	Telephone wall jack
2	Use the phone cord supplied in the box with the printer to connect to the "1-LINE" port

2. After you have connected the phone cord to the port labeled 1-LINE, run the fax test again to make sure it passes and the printer is ready for faxing.
3. Try to send or receive a test fax.

**The "Using Correct Type of Phone Cord with Fax" test failed**

- Make sure you used the phone cord supplied in the box with the printer to connect to the telephone wall jack. One end of the phone cord should be connected to the port labeled 1-LINE on the back of the printer, and the other end to your telephone wall jack, as shown in the illustration.

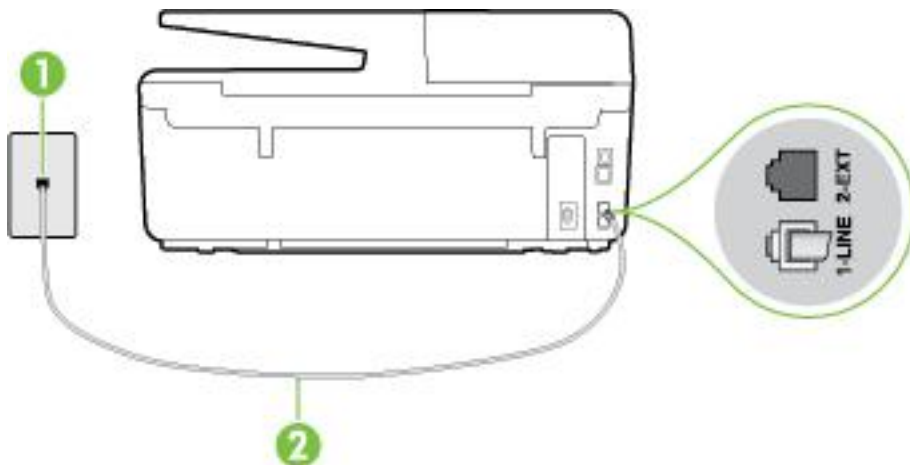

1	Telephone wall jack
2	Use the phone cord supplied in the box with the printer to connect to the "1-LINE" port

If the phone cord that came with the printer is not long enough, you can use a longer 2-wire phone cord to extend the length. You can purchase the cord at an electronics store that carries phone accessories.

- Check the connection between the telephone wall jack and the printer to make sure the phone cord is secure.

- Make sure you use the phone cord that came with the printer. If you do not use the supplied phone cord to connect from the telephone wall jack to the printer, you might not be able to send or receive faxes. After you plug in the phone cord that came with the printer, run the fax test again.
- If you are using a phone splitter, this can cause faxing problems. (A splitter is a two-cord connector that plugs into a telephone wall jack.) Try removing the splitter and connecting the printer directly to the telephone wall jack.

### **The "Dial Tone Detection" test failed**

- Other equipment, which uses the same phone line as the printer, might be causing the test to fail. To find out if other equipment is causing a problem, disconnect everything from the phone line, and then run the test again. If the **Dial Tone Detection Test** passes without the other equipment, then one or more pieces of the equipment is causing problems; try adding them back one at a time and rerunning the test each time, until you identify which piece of equipment is causing the problem.
- Try connecting a working phone and phone cord to the telephone wall jack that you are using for the printer and check for a dial tone. If you do not hear a dial tone, contact your telephone company and have them check the line.
- Make sure you have correctly connected the printer to the telephone wall jack. Using the phone cord supplied in the box with the printer, connect one end to your telephone wall jack, then connect the other end to the port labeled 1-LINE on the back of the printer.
- If you are using a phone splitter, this can cause faxing problems. (A splitter is a two-cord connector that plugs into a telephone wall jack.) Try removing the splitter and connecting the printer directly to the telephone wall jack.
- If your telephone system is not using a standard dial tone, such as some private branch exchange (PBX) systems, this might cause the test to fail. This does not cause a problem sending or receiving faxes. Try sending or receiving a test fax.
- Check to make sure the country/region setting is set appropriately for your country/region. If the country/region setting is not set or is set incorrectly, the test might fail and you might have problems sending and receiving faxes.
- Make sure you connect the printer to an analog phone line or you cannot send or receive faxes. To check if your phone line is digital, connect a regular analog phone to the line and listen for a dial tone. If you do not hear a normal sounding dial tone, it might be a phone line set up for digital phones. Connect the printer to an analog phone line and try sending or receiving a fax.
- Make sure you use the phone cord that came with the printer. If you do not use the supplied phone cord to connect from the telephone wall jack to the printer, you might not be able to send or receive faxes. After you plug in the phone cord that came with the printer, run the fax test again.

After you resolve any problems found, run the fax test again to make sure it passes and the printer is ready for faxing. If the **Dial Tone Detection** test continues to fail, contact your telephone company and have them check the phone line.

### **The "Fax Line Condition" test failed**

- Make sure you connect the printer to an analog phone line or you cannot send or receive faxes. To check if your phone line is digital, connect a regular analog phone to the line and listen for a dial tone. If you do not hear a normal sounding dial tone, it might be a phone line set up for digital phones. Connect the printer to an analog phone line and try sending or receiving a fax.
- Check the connection between the telephone wall jack and the printer to make sure the phone cord is secure.



- Make sure you have correctly connected the printer to the telephone wall jack. Using the phone cord supplied in the box with the printer, connect one end to your telephone wall jack, then connect the other end to the port labeled 1-LINE on the back of the printer.
- Other equipment, which uses the same phone line as the printer, might be causing the test to fail. To find out if other equipment is causing a problem, disconnect everything from the phone line, and then run the test again.
  - If the **Fax Line Condition Test** passes without the other equipment, then one or more pieces of the equipment is causing problems; try adding them back one at a time and rerunning the test each time, until you identify which piece of equipment is causing the problem.
  - If the **Fax Line Condition Test** fails without the other equipment, connect the printer to a working phone line and continue reviewing the troubleshooting information in this section.
- If you are using a phone splitter, this can cause faxing problems. (A splitter is a two-cord connector that plugs into a telephone wall jack.) Try removing the splitter and connecting the printer directly to the telephone wall jack.
- Make sure you use the phone cord that came with the printer. If you do not use the supplied phone cord to connect from the telephone wall jack to the printer, you might not be able to send or receive faxes. After you plug in the phone cord that came with the printer, run the fax test again.

After you resolve any problems found, run the fax test again to make sure it passes and the printer is ready for faxing. If the **Fax Line Condition** test continues to fail and you experience problems faxing, contact your telephone company and have them check the phone line.

## The display always shows Phone Off Hook

- You are using the wrong type of phone cord. Make sure you are using the 2-wire phone cord that came with the printer to connect the printer to your phone line. If the phone cord that came with the printer is not long enough, you can use a longer phone cord to extend the length. You can purchase the cord at an electronics store that carries phone accessories.
- Other equipment that uses the same phone line as the printer might be in use. Make sure extension phones (phones on the same phone line, but not connected to the printer) or other equipment are not in use or off the hook. For example, you cannot use the printer for faxing if an extension phone is off the hook, or if you are using a computer dial-up modem to send email or access the Internet.

## The printer is having problems sending and receiving faxes

- Make sure the printer is turned on. Look at the display on the printer. If the display is blank and  (the Power button) light is not lit, the printer is turned off. Make sure the power cord is firmly connected to the printer and plugged into a power outlet. Press  (the Power button) to turn on the printer.

After turning on the printer, HP recommends you wait five minutes before sending or receiving a fax. The printer cannot send or receive faxes while it is initializing after being turned on.

- If HP Digital Fax has been enabled, you might not be able to send or receive faxes if the fax memory is full (limited by printer memory).



- Make sure you used the phone cord supplied in the box with the printer to connect to the telephone wall jack. One end of the phone cord should be connected to the port labeled 1-LINE on the back of the printer and the other end to your telephone wall jack, as shown in the illustration.

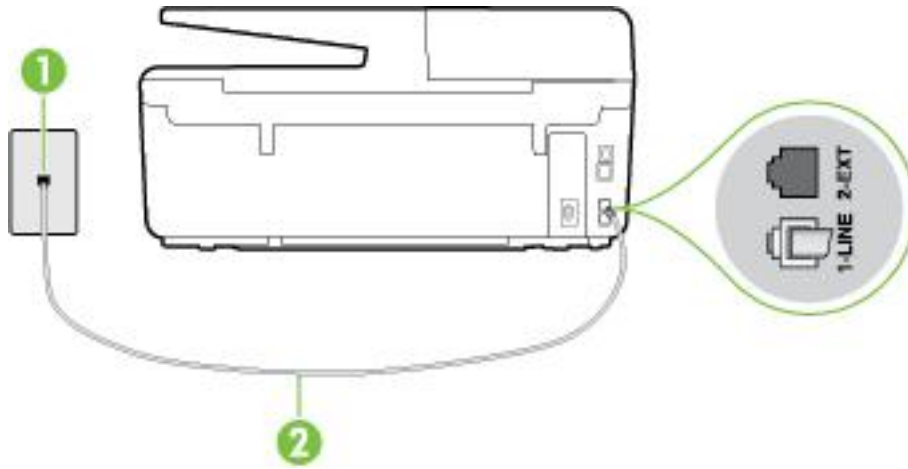

1	Telephone wall jack
2	Use the phone cord supplied in the box with the printer to connect to the "1-LINE" port

- If the phone cord that came with the printer is not long enough, you can use a longer 2-wire phone cord to extend the length. You can purchase the cord at an electronics store that carries phone accessories.
- Try connecting a working phone and phone cord to the telephone wall jack that you are using for the printer and check for a dial tone. If you do not hear a dial tone, call your local telephone company for service.
  - Other equipment, which uses the same phone line as the printer, might be in use. For example, you cannot use the printer for faxing if an extension phone is off the hook, or if you are using a computer dial-up modem to send an email or access the Internet.
  - Check to see if another process has caused an error. Check the display or your computer for an error message providing information about the problem and how to solve it. If there is an error, the printer cannot send or receive a fax until the error condition is resolved.
  - The phone line connection might be noisy. Phone lines with poor sound quality (noise) can cause faxing problems. Check the sound quality of the phone line by plugging a phone into the telephone wall jack and listening for static or other noise. If you hear noise, turn **Error Correction Mode (ECM)** off and try faxing again. For information about changing ECM, see [Send a fax in Error Correction Mode](#). If the problem persists, contact your telephone company.
  - If you are using a digital subscriber line (DSL) service, make sure that you have a DSL filter connected or you cannot fax successfully. [Click here to go online for more information](#).
  - Make sure the printer is not connected to a telephone wall jack that is set up for digital phones. To check if your phone line is digital, connect a regular analog phone to the line and listen for a dial tone. If you do not hear a normal sounding dial tone, it might be a phone line set up for digital phones.
  - If you are using either a private branch exchange (PBX) or an integrated services digital network (ISDN) converter/terminal adapter, make sure the printer is connected to the correct port and the terminal adapter is set to the correct switch type for your country/region, if possible. [Click here to go online for more information](#).

- If the printer shares the same phone line with a DSL service, the DSL modem might not be grounded correctly. If the DSL modem is not grounded correctly, it can create noise on the phone line. Phone lines with poor sound quality (noise) can cause faxing problems. You can check the sound quality of the phone line by plugging a phone into the telephone wall jack and listening for static or other noise. If you hear noise, turn off your DSL modem and completely remove power for at least 15 minutes. Turn the DSL modem back on and listen to the dial tone again.



---

**NOTE:** You might notice static on the phone line again in the future. If the printer stops sending and receiving faxes, repeat this process.

---

If the phone line is still noisy, contact your telephone company. For information on turning your DSL modem off, contact your DSL provider for support.

- If you are using a phone splitter, this can cause faxing problems. (A splitter is a two-cord connector that plugs into a telephone wall jack.) Try removing the splitter and connecting the printer directly to the telephone wall jack.

## The printer cannot receive faxes, but can send faxes

- If you are not using a distinctive ring service, check to make sure that the **Distinctive Ring** feature on the printer is set to **All Rings**. For more information, see [Change the answer ring pattern for distinctive ring](#).
- If **Auto Answer** is set to **Off**, you need to receive faxes manually; otherwise, the printer cannot receive the fax. For information on receiving faxes manually, see [Receive a fax manually](#).
- If you have a voice mail service at the same phone number you use for fax calls, you must receive faxes manually, not automatically. This means that you must be available to respond in person to incoming fax calls. Learn more about setting up the printer when you have a voice mail service, [click here to go online for more information](#). For information on receiving faxes manually, see [Receive a fax manually](#).
- If you have a computer dial-up modem on the same phone line with the printer, check to make sure that the software that came with your modem is not set to receive faxes automatically. Modems that are set up to receive faxes automatically take over the phone line to receive all incoming faxes, which prevents the printer from receiving fax calls.
- If you have an answering machine on the same phone line with the printer, you might have one of the following problems:
  - Your answering machine might not be set up correctly with the printer.
  - Your outgoing message might be too long or too loud to allow the printer to detect fax tones, and the sending fax machine might disconnect.
  - Your answering machine might not have enough quiet time after your outgoing message to allow the printer to detect fax tones. This problem is most common with digital answering machines.

The following actions might help solve these problems:

- When you have an answering machine on the same phone line you use for fax calls, try connecting the answering machine directly to the printer, [click here to go online for more information](#).
- Make sure the printer is set to receive faxes automatically. For information on setting up the printer to receive faxes automatically, see [Receive a fax](#).
- Make sure the **Rings to Answer** setting is set to a greater number of rings than the answering machine. For more information, see [Set the number of rings before answering](#).

- Disconnect the answering machine and then try receiving a fax. If faxing is successful without the answering machine, the answering machine might be causing the problem.
- Reconnect the answering machine and record your outgoing message again. Record a message that is approximately 10 seconds in duration. Speak slowly and at a low volume when recording your message. Leave at least 5 seconds of silence at the end of the voice message. There should be no background noise when recording this silent time. Try to receive a fax again.



**NOTE:** Some digital answering machines might not retain the recorded silence at the end of your outgoing message. Play back your outgoing message to check.

- If the printer shares the same phone line with other types of phone equipment, such as an answering machine, a computer dial-up modem, or a multi-port switch box, the fax signal level might be reduced. The signal level can also be reduced if you use a splitter or connect extra cables to extend the length of your phone. A reduced fax signal can cause problems during fax reception.  
  
To find out if other equipment is causing a problem, disconnect everything except the printer from the phone line, and then try to receive a fax. If you can receive faxes successfully without the other equipment, one or more pieces of the other equipment is causing problems; try adding them back one at a time and receiving a fax each time, until you identify which equipment is causing the problem.
- If you have a special ring pattern for your fax phone number (using a distinctive ring service through your telephone company), make sure that the **Distinctive Ring** feature on the printer is set to match. For more information, see [Change the answer ring pattern for distinctive ring](#).

## The printer cannot send faxes, but can receive faxes

- The printer might be dialing too fast or too soon. You might need to insert some pauses in the number sequence. For example, if you need to access an outside line before dialing the phone number, insert a pause following the access number. If your number is 95555555, and 9 accesses an outside line, you might insert pauses as follows: 9-555-5555. To enter a pause in the fax number you are typing, touch the \* repeatedly, until a dash (-) appears on the display.  
  
You can also send the fax using monitor dialing. This enables you to listen to the phone line as you dial. You can set the pace of your dialing and respond to prompts as you dial. For more information, see [Send a fax using monitor dialing](#).
- The number you entered when sending the fax is not in the proper format or the receiving fax machine is having problems. To check this, try calling the fax number from a telephone and listen for fax tones. If you cannot hear fax tones, the receiving fax machine might not be turned on or connected, or a voice mail service could be interfering with the recipient's phone line. You can also ask the recipient to check the receiving fax machine for any problems.

## Fax tones are recorded on my answering machine

- When you have an answering machine on the same phone line you use for fax calls, try connecting the answering machine directly to the printer, [click here to go online for more information](#). If you do not connect the answering machine as recommended, fax tones might be recorded on your answering machine.
- Make sure the printer is set to receive faxes automatically and that the **Rings to Answer** setting is correct. The number of rings to answer for the printer should be greater than the number of rings to answer for the answering machine. If the answering machine and the printer are set to the same number of rings to answer, both devices answer the call and fax tones are recorded on the answering machine.
- Set your answering machine to a low number of rings and the printer to answer in the maximum number of rings supported. (The maximum number of rings varies by country/region.) In this setup, the

answering machine answers the call and the printer monitors the line. If the printer detects fax tones, the printer receives the fax. If the call is a voice call, the answering machine records the incoming message. For more information, see [Set the number of rings before answering](#).

## The phone cord that came with my printer is not long enough

If the phone cord that came with the printer is not long enough, you can use a longer 2-wire phone cord to extend the length. You can purchase the cord at an electronics store that carries phone accessories.

---

 **TIP:** If you have a 2 wire phone adaptor, you may use it with a 4-wire phone cord to extend the length.

---

### To extend your phone cord

1. Using the phone cord supplied in the box with the printer, connect to the port labeled 1-LINE on the back of the printer.
2. Connect another phone cord and the open port on the coupler and to the telephone wall jack.

## The computer cannot receive faxes (HP Digital Fax)

- The computer selected to receive faxes is turned off. Make sure the computer selected to receive faxes is switched on at all times.
- Different computers are configured for setup and receiving faxes and one of them may be switched off. If the computer receiving faxes is different from the one used for setup, both computers should be switched on at all times.
- HP Digital Fax is not activated or the computer is not configured to receive faxes. Activate HP Digital Fax and make sure the computer is configured to receive faxes.

## Solve problems using Web Services

If you are having problems using Web Services, such as HP ePrint and HP Printables, check the following:

- Make sure the printer is connected to the Internet using an Ethernet or wireless connection.



---

**NOTE:** You cannot use these web features if the printer is connected using a USB cable.

---

- Make sure the latest product updates have been installed on the printer. For more information, see [Update the printer](#).
- Make sure Web Services is enabled on the printer. For more information, see [Set up Web Services](#).
- Make sure the network hub, switch, or router is turned on and working correctly.
- If you are connecting the printer using an Ethernet cable, make sure you are not using a phone cord or a crossover cable to connect the printer to the network, and that the Ethernet cable is securely connected to the printer. For more information, see [General network troubleshooting](#).
- If you are connecting the printer using a wireless connection, make sure the wireless network is functioning properly. For more information, see [Unable to connect the printer wirelessly](#).
- If you are using HP ePrint, check the following:

- Make sure the printer's email address is correct.
- Make sure that the printer's email address is the only address listed in the "To" line of the email message. If other email addresses are listed in the "To" line, the attachments you are sending might not print.
- Make sure you are sending documents that meet the HP ePrint requirements. For more information, visit HP Connected at [www.hpconnected.com](http://www.hpconnected.com) .
- If your network uses proxy settings when connecting to the Internet, make sure the proxy settings you are entering are valid:
  - Check the settings being used by the web browser you are using (such as Internet Explorer, Firefox, or Safari).
  - Check with the IT administrator or person who set up your firewall.

If the proxy settings used by your firewall have changed, you must update these settings in either the printer control panel or the embedded web server. If these settings are not updated, you will not be able to use Web Services.

For more information, see [Set up Web Services](#).

---

 **TIP:** For additional help on setting up and using Web Services, visit HP Connected at [www.hpconnected.com](http://www.hpconnected.com) .

---

## Solve network problems

This section provides solutions to common problems on connecting or using the printer on a network.

- [General network troubleshooting](#)
- [Unable to connect the printer wirelessly](#)

For more information about network problems, check the following:

- Use this troubleshooter to help find your network security settings. [Click here to go online for more information](#). At this time, this website might not be available in all languages.
- Use this troubleshooter that helps you to convert a USB connection to a wireless one. [Click here to go online for more information](#). At this time, this website might not be available in all languages.
- Use this troubleshooter to help you connect to HP wireless direct, or to help you troubleshoot HP wireless direct issues, such as not being able to connect to HP wireless direct, not being able to print when using HP wireless direct, or you cannot connect to the Internet. [Click here to go online for more information](#). At this time, this website might not be available in all languages.
- Use this troubleshooter to help you get your printer onto your network, or it was on your network and now it is not. [Click here to go online for more information](#). At this time, this website might not be available in all languages.
- Use this troubleshooter to help you get your printer on the network if you have a firewall or antivirus protection that is causing a problem. [Click here to go online for more information](#). At this time, this website might not be available in all languages.

### General network troubleshooting

During software installation if the software cannot find the printer on the network you will be prompted to enter the printer's IP address which is found on the network configuration page. For more information, see [Network configuration page](#).

---

**TIP:** You can visit the HP online support website at [www.hp.com/support](http://www.hp.com/support) for information and utilities that can help you correct many common printer problems.

(Windows) Run the **HP Print and Scan Doctor** to diagnose and automatically fix printing, scanning, and copying issues. The application is only available in some languages.

---

Ensure the following:

- If using a wireless connection, make sure the Wireless light is on. For more information, see [Turn on or off the wireless capability of the printer](#).
- If using an Ethernet connection, be sure to connect the Ethernet cable when prompted to do so during the software installation, and check that the Link light near the connector on the back of the printer gets turned on.
- All cable connections to the computer and the printer are secure.
- The network is operational and the network hub, switch, or router is turned on.
- (Windows) All applications, including virus protection programs, spyware protection programs, and firewalls, are closed or temporarily disabled.

## Unable to connect the printer wirelessly

Make sure you have already set up the printer wireless capabilities by completing the wireless connection setup.

For more information about the wireless connection setup, see [Set up the printer for wireless communication](#).

---



**NOTE:** If your printer supports Ethernet networking, make sure that an Ethernet cable is not connected to the printer. Connecting an Ethernet cable turns off the printer wireless capability.

---

**Table 10-1 Understand the behaviors of the Wireless (802.11) light on the printer**

Light description/Light pattern	Explanation
The Wireless light is off.	The wireless capability of the printer is turned off.
	
The Wireless light is on but blinking.	The wireless capability of the printer is turned on and the printer is not connected to a network.

**Table 10-1 Understand the behaviors of the Wireless (802.11) light on the printer (continued)**

Light description/Light pattern	Explanation
	The wireless capability of the printer is turned on and the printer is connected to a network.
	The wireless capability of the printer is turned on and the printer is connected to a network.

Try the following steps to connect the printer wirelessly.

1. Make sure the Wireless (802.11) light is turned on. If the blue wireless light on the printer control panel is not lit, the wireless capability of the printer might be turned off.

**To turn on the wireless capability of the printer**

- a. Touch  (the Wireless button) from the printer control panel, and then touch **Settings**.
- b. Touch **Wireless Settings**.
- c. Slide the button to turn on the printer wireless capability.

If the blue wireless light is blinking, it means the printer is not connected to a network. Run the Wireless Setup Wizard from the printer control panel display to set up wireless communication. For more information, see [Set up the printer on your wireless network](#).

2. Make sure the computer is connected to the wireless network  
If you cannot connect the computer to the network, there might be a hardware issue with the router or computer.
3. Verify that the printer's IP address has not been altered. If the printer's IP address has changed since it was first installed, you need to run the Update IP utility to print again. The Update IP address utility was installed by the software.
  - a. Open the printer software. For more information, see [Open the HP printer software \(Windows\)](#).
  - b. Select the **Update IP address** utility.

If the test fails, review the test report for information on how to fix the problem and run the test again.

4. Run the wireless test to make sure the wireless connection is working properly.
  - a. Make sure the printer is turned on and paper is loaded in the tray.
  - b. From the printer control panel display, touch **Setup** .
  - c. Touch **Network Setup** .
  - d. Touch **Print Reports** .
  - e. Touch **Wireless Test Report**.

If the test fails, review the test report for information on how to fix the problem and run the test again.

5. Restart components of the wireless network.
  - a. Turn off the router and the printer.
  - b. Turn the router and the printer back on in this order: router first and then printer.

Sometimes, turning off devices and then turning them back on helps resolve network communication issues. If you still cannot connect, turn off the router, the printer, and the computer, and then turn them back on in this order: router first, then printer, and then computer.



Use this troubleshooter to help you get your printer onto your network, or it was on your network and now it is not. [Click here to go online for more information](#). At this time, this website might not be available in all languages.

If you still have problems, visit the HP Wireless Printing Center ( [www.hp.com/go/wirelessprinting](http://www.hp.com/go/wirelessprinting) ). (At this time, this website might not be available in all languages.) The website contains the latest information about setting up and using the printer on a wireless network, and resolving issues on wireless connection and security software.

If the wireless connection cannot be made, the printer can also be connected to the network using an Ethernet cable.

## Maintain the printer

This section provides instructions for keeping the printer in top working condition. Perform these maintenance procedures as necessary.

- [Clean the scanner glass](#)
- [Clean the exterior](#)
- [Clean the document feeder](#)
- [Maintain the printhead and ink cartridges](#)

### Clean the scanner glass

Dust or dirt on the scanner glass, scanner lid backing, or scanner frame can slow down performance, degrade the quality of scans, and affect the accuracy of special features such as fitting copies to a certain page size.

To clean the scanner glass

---

**⚠ WARNING!** Before cleaning the printer, turn the printer off by pressing  (the Power button) and unplug the power cord from the electrical socket.

---

1. Lift the scanner lid.



2. Clean the scanner glass and lid backing by using a soft, lint-free cloth that has been sprayed with a mild glass cleaner.

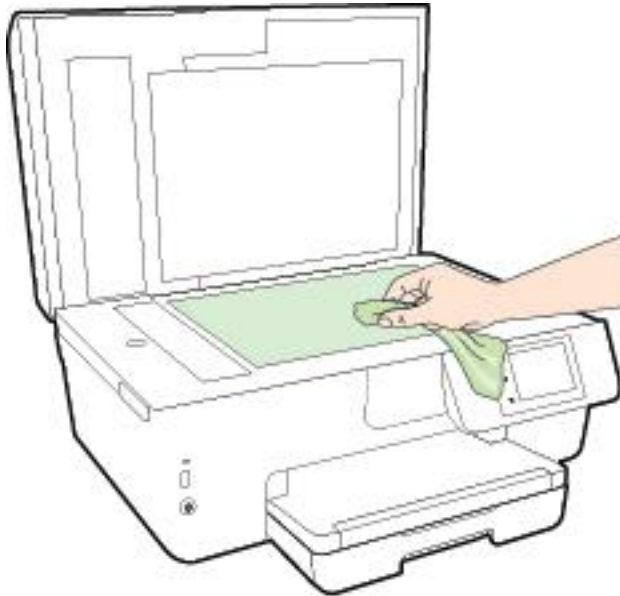

---

**CAUTION:** Use only glass cleaner to clean the scanner glass. Avoid cleaners that contain abrasives, acetone, benzene, and carbon tetrachloride, all of which can damage the scanner glass. Avoid isopropyl alcohol because it can leave streaks on the scanner glass.

**CAUTION:** Do not spray the glass cleaner directly on the scanner glass. If too much glass cleaner is applied, the cleaner could leak under the scanner glass and damage the scanner.

---

3. Close the scanner lid, and turn on the printer.

## Clean the exterior

---

**WARNING!** Before cleaning the printer, turn the printer off by pressing  (the Power button) and unplug the power cord from the electrical socket.

---

Use a soft, damp, lint-free cloth to wipe dust, smudges, and stains off of the case. Keep fluids away from the interior of the printer, as well as from the printer control panel.

## Clean the document feeder

If the document feeder picks up multiple pages or if it does not pick up plain paper, you can clean the rollers and separator pad.

To clean the rollers or separator pad

---

**WARNING!** Before cleaning the printer, turn the printer off by pressing  (the Power button) and unplug the power cord from the electrical socket.

---

1. Remove all originals from the document feeder tray.

2. Lift the document feeder cover.

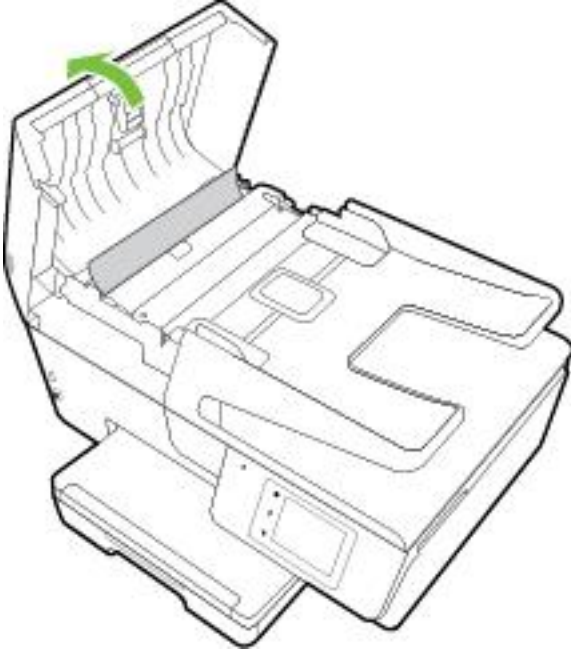

This provides easy access to the rollers (1) and separator pad (2).

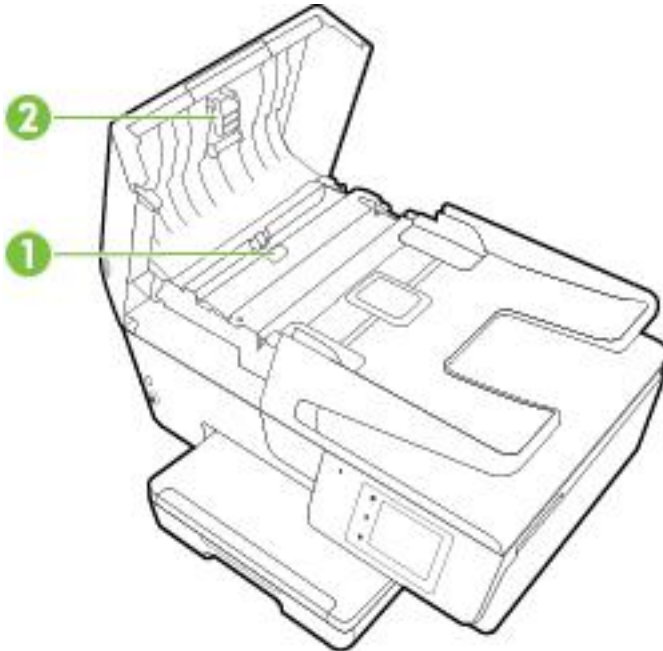

1	Rollers
2	Separator pad

3. Lightly dampen a clean lint-free cloth with distilled water, then squeeze any excess liquid from the cloth.
4. Use the damp cloth to wipe any residue off the rollers or separator pad.



**NOTE:** If the residue does not come off using distilled water, try using isopropyl (rubbing) alcohol.

5. Close the cover of the document feeder.

## Maintain the printhead and ink cartridges

If you are experiencing problems with printing, you might have a problem with the printhead. You should perform the procedures in the following sections only when directed to do so for resolving print quality issues. For more information, see [Print quality report](#).

Performing the aligning and cleaning procedures unnecessarily can waste ink and shorten the life of the cartridges.

- Clean the printhead if your printed output is streaked or has any incorrect or missing colors.

There are three stages of cleaning. Each stage lasts about two minutes, uses one sheet of paper, and uses an increasing amount of ink. After each stage, review the quality of the printed page. You should only initiate the next phase of cleaning if the print quality is poor.

If print quality still seems poor after you complete all stages of cleaning, try aligning the printer. If print quality problems persist after cleaning and aligning, contact HP support. For more information, see [HP support](#).

- Align the printer when the printer status page shows streaking or white lines through any of the blocks of color, or if you are having print quality issues with your printouts.

The printer automatically aligns the printhead during the initial setup.

- Clean ink smears when your printed output has smearing on the back. Ink may have built up in some areas of the printer and needs to be removed.



**NOTE:** Cleaning uses ink, so clean the printhead only when necessary. The cleaning process takes a few minutes. Some noise might be generated in the process.

Turning the printer off improperly can cause print quality problems. For more information, see [Turn the printer off](#).

---

### To clean or align the printheads, or clean ink smears

1. Load Letter or A4 unused plain white paper into the input tray. For more information, see [Load paper](#).
2. From the printer control panel display, touch **Setup**.
3. Touch **Printer Maintenance**, select the desired option, and then follow the on-screen instructions.



**NOTE:** You can also do the same from the HP printer software or embedded web server (EWS). To access the software or EWS, see [Open the HP printer software \(Windows\)](#) or [Open the embedded web server](#).

---

## Clear paper jams

Paper jams can occur either inside the printer or in the document feeder.



**CAUTION:** To prevent possible damage to the printhead, clear paper jams as soon as possible.

---

### To clear a paper jam



**CAUTION:** Avoid pulling jammed paper from the front of the printer. Instead follow the steps below to clear the jam. Pulling out jammed paper from the front of the printer might cause the paper to tear and leave torn pieces inside the printer; this could result in more jams later.

---

1. Open the ink cartridge access door.

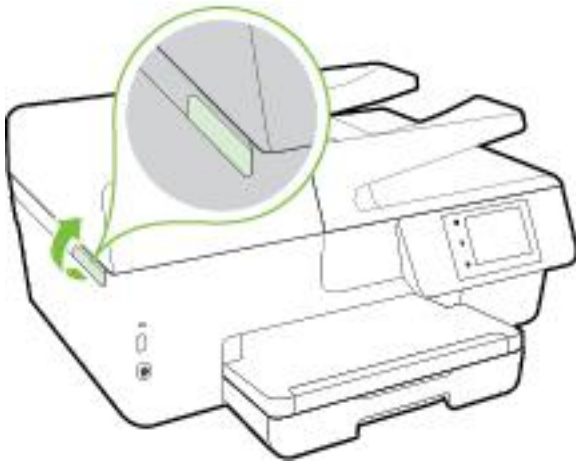

2. Check the paper path inside the printer.
  - a. Lift the handle of the paper path cover and remove the cover.

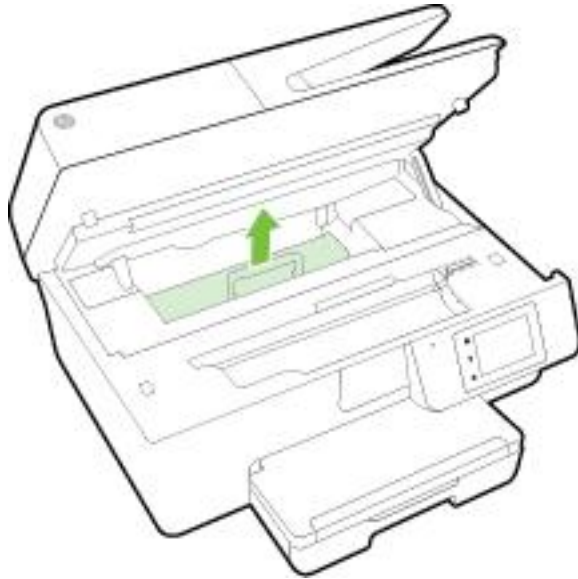

- b. Locate any jammed paper inside the printer, grasp it with both hands and pull it towards you.

---

**⚠ CAUTION:** If the paper tears when you are removing it from the rollers, check the rollers and wheels for torn pieces of paper that might be remaining inside the printer.

If you do not remove all the pieces of paper from the printer, more paper jams are likely to occur.

---



- c. Reinsert the paper path cover until it snaps into place.

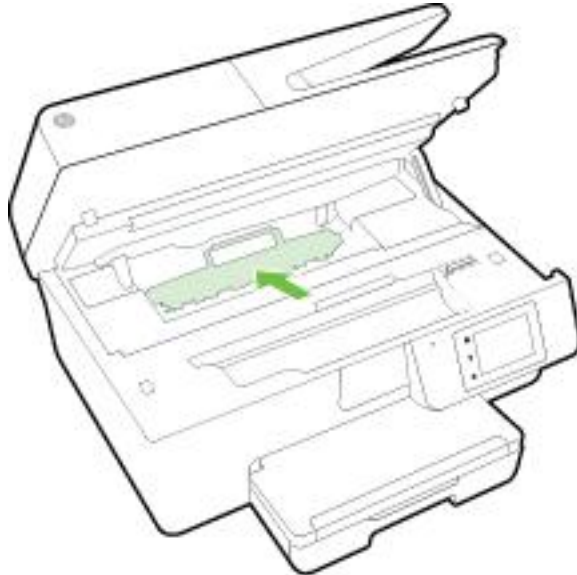

3. If the problem is not resolved, check the print carriage area inside the printer.

---

**⚠ CAUTION:** During the process, avoid touching the cable attached to the print carriage.

---



- a. If there is any jammed paper, move the print carriage to the far right of the printer, grasp the jammed paper with both hands, and then pull it towards you.

---

**⚠ CAUTION:** If the paper tears when you are removing it from the rollers, check the rollers and wheels for torn pieces of paper that might be remaining inside the printer.

If you do not remove all the pieces of paper from the printer, more paper jams are likely to occur.

---

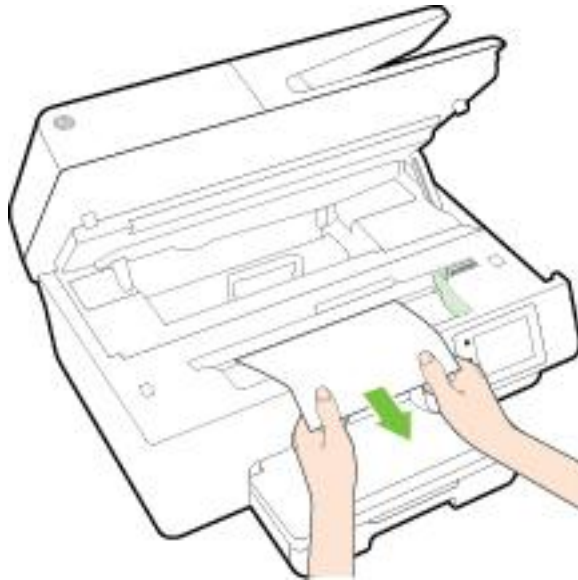

- b.** Move the carriage to the far left of the printer, and do the same as in the previous step to remove any torn pieces of paper.

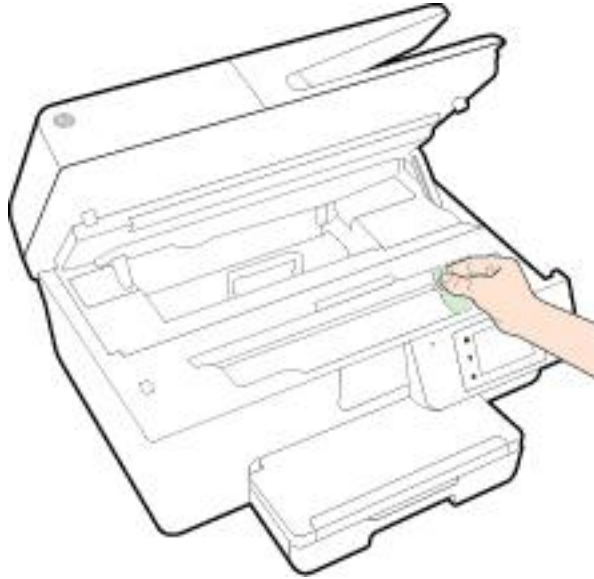

- 4.** Close the ink cartridge access door.
- 5.** If the problem is still not resolved, check the tray area.
  - a.** Lift the output tray.

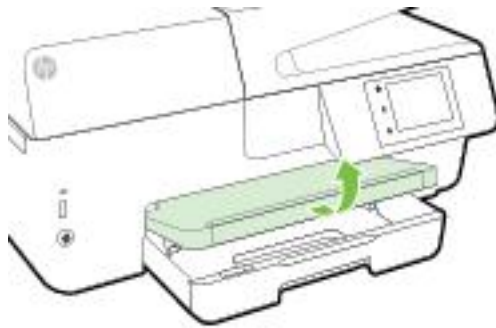

- b.** Pull out the input tray to extend it.



- c. Press down the buttons on both sides of the input tray, and pull to remove the input tray.



- d. Check the gap in the printer where the input tray was. If there is any jammed paper, reach into the gap, grasp the paper with both hands and pull it towards you.

**⚠ CAUTION:** If the paper tears when you are removing it from the rollers, check the rollers and wheels for torn pieces of paper that might be remaining inside the printer.

If you do not remove all of the pieces of paper from the printer, more paper jams are likely to occur.

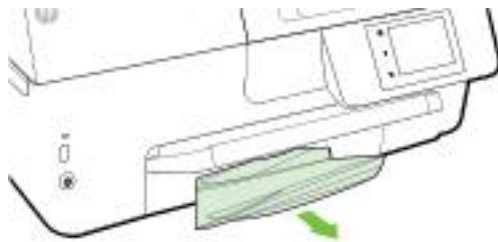

- e. Insert the input tray, load paper, and lower the output tray.

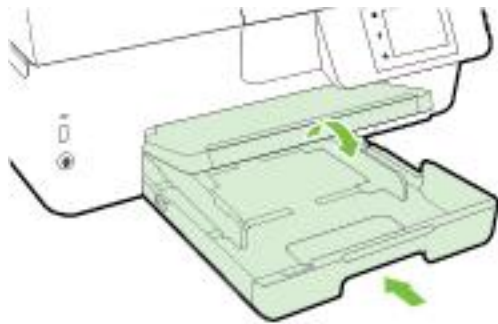

[Click here](#) to use the HP online troubleshooter to resolve a paper jam.



If the print carriage cannot move, [click here](#) to use the HP online troubleshooter to resolve a print carriage jam. At this time, this website might not be available in all languages.

### To clear a paper jam in the document feeder

1. Lift the cover of the document feeder.



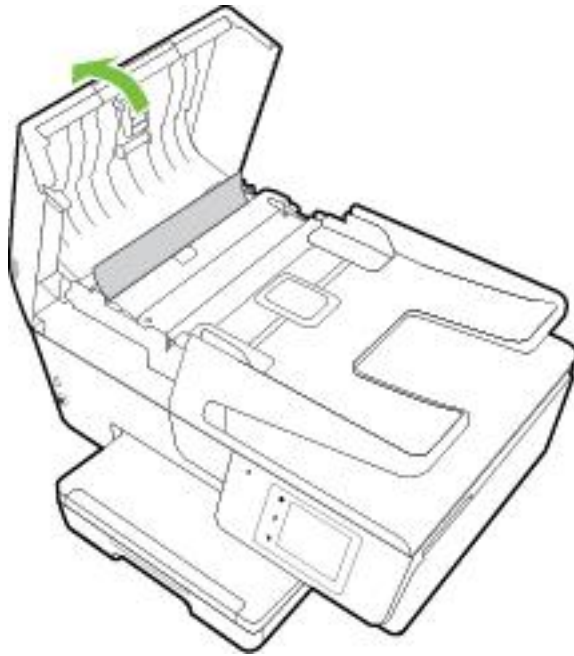

2. Lift the green tab located on the front edge of the document feeder.

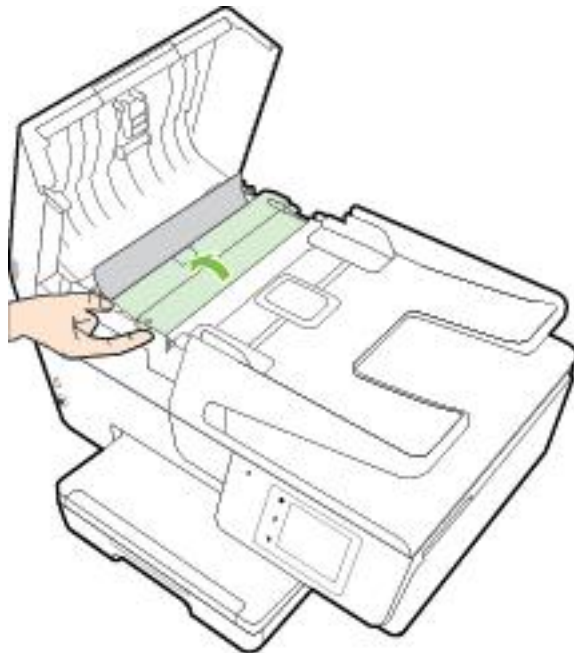

3. Gently pull the jammed paper out of the rollers.

---

**⚠ CAUTION:** If the paper tears when you are removing it from the rollers, check the rollers and wheels for torn pieces of paper that might remain inside the printer.

If you do not remove all the pieces of paper from the printer, more paper jams are likely to occur.

---

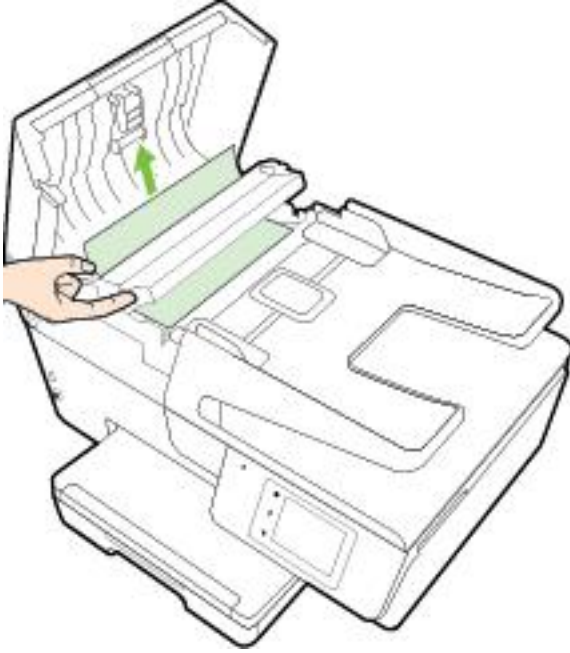

4. Close the document feeder cover, pressing down firmly until it snaps into place.



If the above solutions do not resolve the problem, [click here for more online troubleshooting.](#)

### To avoid paper jams

To help avoid paper jams, follow these guidelines.

- Remove printed papers from the output tray frequently.
- Make sure that you are printing with paper that is not wrinkled, folded, or damaged.
- Prevent curled or wrinkled paper by storing all unused paper flat in a resealable bag.
- Do not use paper that is too thick or too thin for the printer.
- Make sure that the trays are loaded correctly and are not too full. For more information, see [Load paper](#).
- Ensure that paper loaded in the input tray lays flat and the edges are not bent or torn.
- Do not place too much paper in the document feeder tray. For information on the maximum number of sheets allowed in the document feeder, see [Specifications](#).
- Do not combine different paper types and paper sizes in the input tray; the entire stack of paper in the input tray must be the same size and type.
- Adjust the paper-width guides in the input tray to fit snugly against all paper. Make sure the paper-width guides do not bend the paper in the input tray.
- Do not force paper too far inside the input tray.

- If you are printing on both sides of a page, do not print highly saturated images on light weight paper.
- Use paper types that are recommended for the printer. For more information, see [Recommended papers for printing](#).
- If the printer is about to run out of paper, allow the printer to run out of paper first, and then add paper. Do not load paper when the printer is printing.
- Make sure that the printer is clean. For more information, see [Maintain the printer](#).

## Clear the print carriage

Remove any objects, such as paper, that are blocking the print carriage.

See [Clear paper jams](#) for more information.



---

**NOTE:** Do not use any tools or other devices to remove jammed paper. Always use caution when removing jammed paper from inside the printer.

---



If the print carriage cannot move, [click here](#) to use the HP online troubleshooter to resolve a print carriage jam. At this time, this website might not be available in all languages.

## Restore defaults and settings

If you disable some functions or change some settings and want to change them back, you can restore the printer to the original factory settings or network settings.

### To restore the printer to the original factory settings

1. From the printer control panel display, touch **Setup**.
2. Touch **Printer Maintenance**.
3. Touch **Restore**.
4. Touch **Restore Settings**.
5. Select which function you would like to restore to the original factory settings:
  - Copy
  - Scan
  - Fax
  - Photo
  - Network
  - Web Services
  - Printer SetupTouch **Restore**.
6. A message appears stating that the settings will be restored.  
Touch **Yes**.

### To restore the printer to the original factory defaults

1. From the printer control panel, touch **Setup** .
2. Touch **Printer Maintenance** .
3. Touch **Restore**.
4. Touch **Restore Factory Defaults**.  
A message appears stating that the factory defaults will be restored.
5. A message appears stating that the network defaults have been restored.  
Touch **Restore**.

### To restore the printer to the original network settings

1. From the printer control panel, touch **Setup** .
2. Touch **Network Setup**.
3. Touch **Restore Network Settings**.
4. A message appears stating that the network defaults will be restored.  
Touch **Yes**.
5. Print the network configuration page and verify that the network settings have been reset.  
For more information, see [Network configuration page](#).



**NOTE:** Previously configured wireless settings are removed when you reset the printer network settings.



**TIP:** You can visit the HP online support website at [www.hp.com/support](http://www.hp.com/support) for information and utilities that can help you correct many common printer problems.

(Windows) Run the [HP Print and Scan Doctor](#) to diagnose and automatically fix printing, scanning, and copying issues. The application is only available in some languages.

---

---

# A Technical information

This section contains the following topics:

- [Specifications](#)
- [Regulatory information](#)
- [Environmental product stewardship program](#)

## Specifications

For more information, visit [www.hp.com/support](http://www.hp.com/support) . Select your country or region. Click **Product Support & Troubleshooting**. Enter the name shown on the front of the printer, and then select **Search**. Click **Product information**, and then click **Product specifications**.

### System requirements

- Software and system requirements can be found in the Readme file, which is available on the HP printer software CD provided with your printer.
- For information about future operating system releases and support, visit the HP online support website at [www.hp.com/support](http://www.hp.com/support) .

### Environmental specifications

- Operating temperature: 5° to 40° C (41° to 104° F)
- Operating humidity: 15 to 80% RH non-condensing
- Recommended operating conditions: 15° to 32° C (59° to 90° F)
- Recommended relative humidity: 20 to 80% noncondensing

### Input tray capacity

- Plain paper sheets (60 to 105 g/m<sup>2</sup> [16 to 28 lb]): Up to 225
- Envelopes: Up to 30
- Index cards: Up to 80
- Photo paper sheets: Up to 100

### Output tray capacity

- Plain paper sheets (60 to 105 g/m<sup>2</sup> [16 to 28 lb]): Up to 60

### Document feeder capacity

- Plain paper sheets (60 to 105 g/m<sup>2</sup> [16 to 28 lb]): Up to 35

## Paper size and weights

For the list of supported paper sizes, see the HP printer software.

- Plain paper: 60 to 105 g/m<sup>2</sup> (16 to 28 lb)
- Envelopes: 75 to 90 g/m<sup>2</sup> (20 to 24 lb)
- Cards: Up to 200 g/m<sup>2</sup> (110-lb index maximum)
- Photo paper: 250 g/m<sup>2</sup> (66 lb)

## Print specifications

- Print speeds vary according to the complexity of the document and printer model
- Method: drop-on-demand thermal officejet
- Language: PCL3 GUI
- Print resolution:

<b>Draft mode</b>	— Color Input/Black Render: 300x300dpi
	— Output (Black/Color): Automatic
<b>Normal mode</b>	— Color Input/Black Render: 600x600dpi
	— Output (Black/Color): Automatic
<b>Plain-Best mode</b>	— Color Input/Black Render: 600x600dpi
	— Output (Black/Color): Automatic
<b>Photo-Best mode</b>	— Color Input/Black Render: 600x600dpi
	— Output (Black/Color): Automatic
<b>Max DPI mode</b>	— Color Input/Black Render: 1200x1200dpi
	— Output: Automatic (Black/Color), 4800x1200 optimized dpi (Photo Paper, Color)

To print in maximum dpi mode, see [Print using the maximum dpi](#).

- Set minimum margins:

The document margins must match (or exceed) these margin settings in portrait orientation.

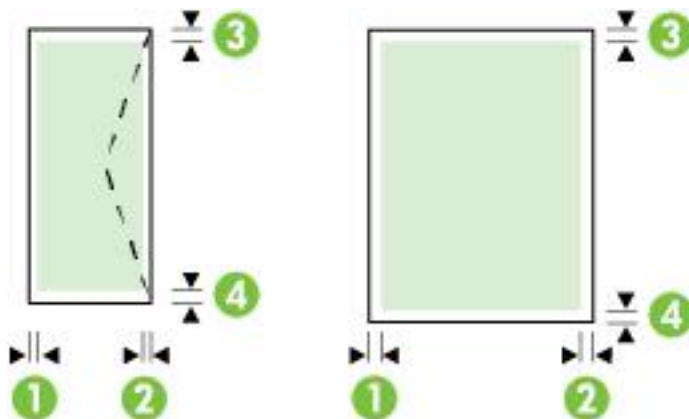

<b>Media</b>	<b>(1) Left margin</b>	<b>(2) Right margin</b>	<b>(3) Top margin</b>	<b>(4) Bottom margin</b>
U.S. Letter	3 mm (0.12 inch)	3 mm (0.12 inch)	3 mm (0.12 inch)	3 mm (0.12 inch)
U.S. Legal				
A4				
U.S. Executive				
B5				
A5				
Cards				
Custom-sized media				
Photo media				
Envelopes	3 mm (0.12 inch)	3 mm (0.12 inch)	16.5 mm (0.65 inch)	16.5 mm (0.65 inch)

### Copy specifications

- Digital image processing
- Copy speeds vary according to the complexity of the document and printer model
- Up to 99 copies from original
- Digital zoom: from 25 to 400%
- Fit to page, copy preview

### Scan specifications

- Resolution: Up to 1200 x 1200 ppi optical  
For more information about scan resolution, see the HP printer software.
- Color: 24-bit color, 8-bit grayscale (256 levels of gray)
- Maximum scan size:
  - Scanner glass: 216 x 297 mm (8.5 x 11.7 inches)
  - Document feeder: 216 x 356 mm (8.5 x 14 inches)

### Fax specifications

- Walk-up black-and-white and color fax capability.
- Manual fax send and receive.
- Automatic busy redial up to five times (varies by country/region).
- Automatic no-answer redial up to two times (varies by country/region).
- Automatic communication problem redial up to five times (varies by country/region).
- Confirmation and activity reports.
- CCITT/ITU Group 3 fax with Error Correction Mode.
- Up to 33.6 Kbps transmission.

- 4 seconds per page speed at 33.6 Kbps (based on ITU-T Test Image #1 at standard resolution). More complicated pages or higher resolution takes longer and uses more memory.
- Ring detect with automatic fax/answering machine switching.
- Fax resolution:

	Photo (dpi)	Very Fine (dpi)	Fine (dpi)	Standard (dpi)
Black	203 x 196 (8-bit grayscale)	300 x 300	203 x 196	203 x 98
Color	200 x 200	200 x 200	200 x 200	200 x 200

- Fax to PC specifications
  - Supported file types: TIFF and PDF
  - Supported fax types: black-and-white faxes

### Cartridge yield

- Visit [www.hp.com/go/learnaboutsupplies](http://www.hp.com/go/learnaboutsupplies) for more information on estimated cartridge yields.

### Acoustic emission specifications

- Sound pressure (bystander position)
  - LpAm 55 (dBA) (mono Draft print)
- Sound power
  - LwAd 6.9 (BA)

## Regulatory information

The printer meets product requirements from regulatory agencies in your country/region.

This section contains the following topics:

- [Regulatory Model Number](#)
- [FCC statement](#)
- [Notice to users in Korea](#)
- [VCCI \(Class B\) compliance statement for users in Japan](#)
- [Notice to users in Japan about the power cord](#)
- [Noise emission statement for Germany](#)
- [Visual display workplaces statement for Germany](#)
- [Notice to users of the U.S. telephone network: FCC requirements](#)
- [Notice to users of the Canadian telephone network](#)
- [Notice to users in the European Economic Area](#)
- [Notice to users of the German telephone network](#)
- [Australia wired fax statement](#)
- [European Union Regulatory Notice](#)



- [Products with external AC Adapters](#)
- [Products with wireless functionality](#)
- [European telephone network declaration \(Modem/Fax\)](#)
- [Declaration of conformity](#)
- [Regulatory information for wireless products](#)
  - [Exposure to radio frequency radiation](#)
  - [Notice to users in Brazil](#)
  - [Notice to users in Canada](#)
  - [Notice to users in Taiwan](#)
  - [Notice to users in Mexico](#)
  - [Wireless notice to users in Japan](#)

## Regulatory Model Number

For regulatory identification purposes, your product is assigned a Regulatory Model Number. The Regulatory Model Number for your product is SNPRC-1402-01. This regulatory number should not be confused with the marketing name (HP Officejet 6800 e-All-in-One) or product number (E3E02A).

## FCC statement

### FCC statement

The United States Federal Communications Commission (in 47 CFR 15.105) has specified that the following notice be brought to the attention of users of this product.

This equipment has been tested and found to comply with the limits for a Class B digital device, pursuant to Part 15 of the FCC Rules. These limits are designed to provide reasonable protection against harmful interference in a residential installation. This equipment generates, uses and can radiate radio frequency energy and, if not installed and used in accordance with the instructions, may cause harmful interference to radio communications. However, there is no guarantee that interference will not occur in a particular installation. If this equipment does cause harmful interference to radio or television reception, which can be determined by turning the equipment off and on, the user is encouraged to try to correct the interference by one or more of the following measures:

- Reorient or relocate the receiving antenna.
- Increase the separation between the equipment and the receiver.
- Connect the equipment into an outlet on a circuit different from that to which the receiver is connected.
- Consult the dealer or an experienced radio/TV technician for help.

For further information, contact:

Manager of Corporate Product Regulations  
 Hewlett-Packard Company  
 3000 Hanover Street  
 Palo Alto, Ca 94304  
 (650) 857-1501

Modifications (part 15.21)

The FCC requires the user to be notified that any changes or modifications made to this device that are not expressly approved by HP may void the user's authority to operate the equipment.

This device complies with Part 15 of the FCC Rules. Operation is subject to the following two conditions: (1) this device may not cause harmful interference, and (2) this device must accept any interference received, including interference that may cause undesired operation.

## Notice to users in Korea

B 급 기기 (가정용 방송통신기기)	이 기기는 가정용(B급)으로 전자파적합등록을 한 기기로서 주로 가정에서 사용하는 것을 목적으로 하며, 모든 지역에서 사용할 수 있습니다.
------------------------	--

## VCCI (Class B) compliance statement for users in Japan

この装置は、クラスB情報技術装置です。この装置は、家庭環境で使用することを目的としていますが、この装置がラジオやテレビジョン受信機に近接して使用されると、受信障害を引き起こすことがあります。取扱説明書に従って正しい取り扱いをして下さい。  VCCI-B
--

## Notice to users in Japan about the power cord

製品には、同梱された電源コードをお使い下さい。 同梱された電源コードは、他の製品では使用出来ません。
---

## Noise emission statement for Germany

<b>Geräuschemission</b> LpA < 70 dB am Arbeitsplatz im Normalbetrieb nach DIN 45635 T. 19
--

## Visual display workplaces statement for Germany

<b>GS-Erklärung (Deutschland)</b> Das Gerät ist nicht für die Benutzung im unmittelbaren Gesichtsfeld am Bildschirmarbeitsplatz vorgesehen. Um störende Reflexionen am Bildschirmarbeitsplatz zu vermeiden, darf dieses Produkt nicht im unmittelbaren Gesichtsfeld platziert werden.
--

## Notice to users of the U.S. telephone network: FCC requirements

### Notice to users of the U.S Telephone network: FCC requirements

This equipment complies with Part 68 of the FCC rules and the requirements adopted by the ACTA. On the rear (or bottom) of this equipment is a label that contains, among other information, a product identifier in the format US:AAAEQ##TXXXX. If requested, this number must be provided to the telephone company.

Applicable connector jack Universal Service Order Codes ("USOC") for the Equipment is: RJ-11C.

A plug and jack used to connect this equipment to the premises wiring and telephone network must comply with the applicable FCC Part 68 rules and requirements adopted by the ACTA. A compliant telephone cord and modular plug is provided with this product. It is designed to be connected to a compatible modular jack that is also compliant. See installation instructions for details.

The REN is used to determine the number of devices that may be connected to a telephone line. Excessive RENs on a telephone line may result in the devices not ringing in response to an incoming call. In most but not all areas, the sum of RENs should not exceed five (5.0). To be certain of the number of devices that may be connected to a line, as determined by the total RENs, contact the local telephone company. For products approved after July 23, 2001, the REN for this product is part of the product identifier that has the format US:AAAEQ##TXXXX. The digits represented by ## are the REN without a decimal point (e.g., 00 is a REN of 0.0).

If this equipment causes harm to the telephone network, the telephone company will notify you in advance that temporary discontinuance of service may be required. But if advance notice isn't practical, the telephone company will notify the customer as soon as possible. Also, you will be advised of your right to file a complaint with the FCC if you believe it is necessary.

The telephone company may make changes in its facilities, equipment, operations or procedures that could affect the operation of the equipment. If this happens the telephone company will provide advance notice in order for you to make necessary modifications to maintain uninterrupted service.

If trouble is experienced with this equipment, please contact the manufacturer, or look elsewhere in this manual, for repair or warranty information. If the equipment is causing harm to the telephone network, the telephone company may request that you disconnect the equipment until the problem is resolved.

Connection to party line service is subject to state tariffs. Contact the state public utility commission, public service commission or corporation commission for information.

If your home has specially wired alarm equipment connected to the telephone line, ensure the installation of this equipment does not disable your alarm equipment. If you have questions about what will disable alarm equipment, consult your telephone company or a qualified installer.

WHEN PROGRAMMING EMERGENCY NUMBERS AND/OR MAKING TEST CALLS TO EMERGENCY NUMBERS:

- 1) Remain on the line and briefly explain to the dispatcher the reason for the call.
- 2) Perform such activities in the off-peak hours, such as early morning or late evenings.



**Note** The FCC hearing aid compatibility rules for telephones are not applicable to this equipment.

The Telephone Consumer Protection Act of 1991 makes it unlawful for any person to use a computer or other electronic device, including FAX machines, to send any message unless such message clearly contains in a margin at the top or bottom of each transmitted page or on the first page of the transmission, the date and time it is sent and an identification of the business or other entity, or other individual sending the message and the telephone number of the sending machine or such business, other entity, or individual. (The telephone number provided may not be a 900 number or any other number for which charges exceed local or long-distance transmission charges.)

In order to program this information into your FAX machine, you should complete the steps described in the software.

## Notice to users of the Canadian telephone network

### **Note à l'attention des utilisateurs du réseau téléphonique canadien/Notice to users of the Canadian telephone network**

Cet appareil est conforme aux spécifications techniques des équipements terminaux d'Industrie Canada. Le numéro d'enregistrement atteste de la conformité de l'appareil. L'abréviation IC qui précède le numéro d'enregistrement indique que l'enregistrement a été effectué dans le cadre d'une Déclaration de conformité stipulant que les spécifications techniques d'Industrie Canada ont été respectées. Néanmoins, cette abréviation ne signifie en aucun cas que l'appareil a été validé par Industrie Canada.

Pour leur propre sécurité, les utilisateurs doivent s'assurer que les prises électriques reliées à la terre de la source d'alimentation, des lignes téléphoniques et du circuit métallique d'alimentation en eau sont, le cas échéant, branchées les unes aux autres. Cette précaution est particulièrement importante dans les zones rurales.



**Remarque** Le numéro REN (Ringer Equivalence Number) attribué à chaque appareil terminal fournit une indication sur le nombre maximal de terminaux qui peuvent être connectés à une interface téléphonique. La terminaison d'une interface peut se composer de n'importe quelle combinaison d'appareils, à condition que le total des numéros REN ne dépasse pas 5.

Basé sur les résultats de tests FCC Partie 68, le numéro REN de ce produit est 0.0B.

This equipment meets the applicable Industry Canada Terminal Equipment Technical Specifications. This is confirmed by the registration number. The abbreviation IC before the registration number signifies that registration was performed based on a Declaration of Conformity indicating that Industry Canada technical specifications were met. It does not imply that Industry Canada approved the equipment.

Users should ensure for their own protection that the electrical ground connections of the power utility, telephone lines and internal metallic water pipe system, if present, are connected together. This precaution might be particularly important in rural areas.



**Note** The REN (Ringer Equivalence Number) assigned to each terminal device provides an indication of the maximum number of terminals allowed to be connected to a telephone interface. The termination on an interface might consist of any combination of devices subject only to the requirement that the sum of the Ringer Equivalence Numbers of all the devices does not exceed 5.

The REN for this product is 0.0B, based on FCC Part 68 test results.

## Notice to users in the European Economic Area

### **Notice to users in the European Economic Area**

This product is designed to be connected to the analog Switched Telecommunication Networks (PSTN) of the European Economic Area (EEA) countries/regions.

Network compatibility depends on customer selected settings, which must be reset to use the equipment on a telephone network in a country/region other than where the product was purchased. Contact the vendor or Hewlett-Packard Company if additional product support is necessary.

This equipment has been certified by the manufacturer in accordance with Directive 1999/5/EC (annex II) for Pan-European single-terminal connection to the public switched telephone network (PSTN). However, due to differences between the individual PSTNs provided in different countries, the approval does not, of itself, give an unconditional assurance of successful operation on every PSTN network termination point.

In the event of problems, you should contact your equipment supplier in the first instance.

This equipment is designed for DTMF tone dialing and loop disconnect dialing. In the unlikely event of problems with loop disconnect dialing, it is recommended to use this equipment only with the DTMF tone dial setting.

## Notice to users of the German telephone network

### Hinweis für Benutzer des deutschen Telefonnetzwerks

Dieses HP-Fax ist nur für den Anschluss eines analogen Public Switched Telephone Network (PSTN) gedacht. Schließen Sie den TAE N-Telefonstecker, der im Lieferumfang des HP All-in-One enthalten ist, an die Wandsteckdose (TAE 6) Code N an. Dieses HP-Fax kann als einzelnes Gerät und/oder in Verbindung (mit serielltem Anschluss) mit anderen zugelassenen Endgeräten verwendet werden.

## Australia wired fax statement

In Australia, the HP device must be connected to Telecommunication Network through a line cord which meets the requirements of the Technical Standard AS/ACIF S008.

## European Union Regulatory Notice



Products bearing the CE marking comply with one or more of the following EU Directives as may be applicable: Low Voltage Directive 2006/95/EC, EMC Directive 2004/108/EC, Ecodesign Directive 2009/125/EC, R&TTE Directive 1999/5/EC, RoHS Directive 2011/65/EU. Compliance with these directives is assessed using applicable European Harmonised Standards. The full Declaration of Conformity can be found at the following website: [www.hp.com/go/certificates](http://www.hp.com/go/certificates) (Search with the product model name or its Regulatory Model Number (RMN), which may be found on the regulatory label.)

The point of contact for regulatory matters is:

Hewlett-Packard GmbH, Dept./MS: HQ-TRE, Herrenberger Strasse 140, 71034 Boeblingen, GERMANY

### Products with external AC Adapters

CE compliance of this product is valid only if powered with the correct CE-marked AC adapter provided by HP.

### Products with wireless functionality

#### EMF

- This product meets international guidelines (ICNIRP) for exposure to radio frequency radiation. If it incorporates a radio transmitting and receiving device then in normal use, a separation distance of 20 cm ensures that radio frequency exposure levels comply with EU requirements.

#### Wireless functionality in Europe

- This product is designed for use without restrictions in all EU countries plus Iceland, Liechtenstein, Norway and Switzerland.

### European telephone network declaration (Modem/Fax)

HP products with FAX capability comply with the requirements of the R&TTE Directive 1999/5/EC (Annex II) and carry the CE marking accordingly. However, due to differences between the individual PSTNs provided in

different countries/regions, the approval does not, of itself, give an unconditional assurance of successful operation on every PSTN network termination point. In the event of problems, you should contact your equipment supplier in the first instance.

# Declaration of conformity



## DECLARATION OF CONFORMITY

according to ISO/IEC 17050-1 and EN 17050-1

DoC #: SNPRC-1402-01-A

**Supplier's Name:** Hewlett-Packard Company  
**Supplier's Address:** 138 Depot Road, #04-01, Singapore 109683

**declares, that the product**  
**Product Name and Model:** HP Officejet Pro 6830 e-All-in-One Printer, HP Officejet 6815 e-All-in-One Printer, HP Officejet 6820 e-All-in-One Printer, HP Officejet 6822 e-All-in-One Printer, HP Officejet 6823 e-All-in-One Printer, HP Officejet 6825 e-All-in-One Printer

**Regulatory Model Number:** <sup>1)</sup> SNPRC-1402-01  
**Product Options:** All  
**Power Adapter:** Internal, A9T80-60008 & A9T80-60009 [See 3 under Additional Information]  
**Radio Module Number:** SDGOB-1292 [See 4 under Additional Information]

### conforms to the following Product Specifications and Regulations:

**EMC:** CISPR 22:2008 / EN55022:2010 Class B  
EN 55024:2010  
EN 61000-3-2:2006+A1:2009+A2:2009  
EN 61000-3-3:2008  
FCC CFR 47, Part 15 / ICES-003, Issue 5

**Safety:** IEC 60950-1:2005 (2nd Edition)+A1:2009 / EN 60950-1:2006+A11:2009+A1:2010+A12:2011  
EN 62479:2010

**Telecom:** EN 301 489-1 V1.9.2:2011 / EN 301 489-17 V2.1.1:2009  
EN 300 328 V1.7.1 : 2006  
FCC Rules and Regulations 47 CFR Part 68  
TIA-968-B Telecommunications – Telephone Terminal Equipment Technical Requirements for Connection of Terminal Equipment to the Telephone Network (Sep 2009)  
ES 203 021-2/-3 V2.1.2  
CS-03, Part I, Issue 9, Amendment 4, December 2010  
EN 62311:2008

**Energy:** Regulation (EC) No. 1275/2008  
ENERGY STAR® Qualified Imaging Equipment Operational Mode (OM) Test Procedure  
Regulation (EC) No. 278/2009  
Test Method for Calculating the Energy Efficiency of Single-Voltage External Ac-Dc and Ac-Ac Power Supplies (August 11, 2004)

**RoHS:** EN 50581:2012

This device complies with part 15 of the FCC Rules. Operation is subject to the following two conditions:

(1) This device may not cause harmful interference, and (2) this device must accept any interference received, including interference that may cause undesired operation.

The product herewith complies with the requirements of the Low Voltage Directive 2006/95/EC, the EMC Directive 2004/108/EC, the R&TTE Directive 1999/5/EC, the Ecodesign Directive 2009/125/EC, the RoHS Directive 2011/95/EU and carries the **CE** marking accordingly.

### Additional Information:

- 1) This product is assigned a Regulatory Model Number which stays with the regulatory aspects of the design. The Regulatory Model Number is the main product identifier in the regulatory documentation and test reports, this number should not be confused with the marketing name or the product numbers.
- 2) The product was tested in a typical configuration.
- 3) The internal power adapter A9T80-60009 is for India and China market only.
- 4) WIFI module operates only in 2.4GHz band within this product.

Singapore  
25 October 2013

### Local contact for regulatory topics only:

EMEA: Hewlett-Packard GmbH, HQ-TRE, Herrenberger Strasse 140, 71034 Boeblingen, Germany  
U.S.: Hewlett-Packard, 3000 Hanover St., Palo Alto 94304, U.S.A. 650-857-1501

[www.hp.eu/certificates](http://www.hp.eu/certificates)

## Regulatory information for wireless products

This section contains the following regulatory information pertaining to wireless products:

- [Exposure to radio frequency radiation](#)
- [Notice to users in Brazil](#)
- [Notice to users in Canada](#)
- [Notice to users in Taiwan](#)
- [Notice to users in Mexico](#)
- [Wireless notice to users in Japan](#)

### Exposure to radio frequency radiation

#### Exposure to radio frequency radiation



**Caution** The radiated output power of this device is far below the FCC radio frequency exposure limits. Nevertheless, the device shall be used in such a manner that the potential for human contact during normal operation is minimized. This product and any attached external antenna, if supported, shall be placed in such a manner to minimize the potential for human contact during normal operation. In order to avoid the possibility of exceeding the FCC radio frequency exposure limits, human proximity to the antenna shall not be less than 20 cm (8 inches) during normal operation.

### Notice to users in Brazil

#### Aviso aos usuários no Brasil

Este equipamento opera em caráter secundário, isto é, não tem direito à proteção contra interferência prejudicial, mesmo de estações do mesmo tipo, e não pode causar interferência a sistemas operando em caráter primário.



## Notice to users in Canada

### Notice to users in Canada/Note à l'attention des utilisateurs canadiens

Under Industry Canada regulations, this radio transmitter may only operate using an antenna of a type and maximum (or lesser) gain approved for the transmitter by Industry Canada. To reduce potential radio interference to other users, the antenna type and its gain should be so chosen that the equivalent isotropically radiated power (e.i.r.p.) is not more than that necessary for successful communication.

This device complies with Industry Canada licence-exempt RSS standard(s). Operation is subject to the following two conditions: (1) this device may not cause interference, and (2) this device must accept any interference, including interference that may cause undesired operation of the device.

**WARNING!** Exposure to Radio Frequency Radiation The radiated output power of this device is below the Industry Canada radio frequency exposure limits. Nevertheless, the device should be used in such a manner that the potential for human contact is minimized during normal operation.

To avoid the possibility of exceeding the Industry Canada radio frequency exposure limits, human proximity to the antennas should not be less than 20 cm (8 inches).

Conformément au Règlement d'Industrie Canada, cet émetteur radioélectrique ne peut fonctionner qu'avec une antenne d'un type et d'un gain maximum (ou moindre) approuvé par Industrie Canada. Afin de réduire le brouillage radioélectrique potentiel pour d'autres utilisateurs, le type d'antenne et son gain doivent être choisis de manière à ce que la puissance isotrope rayonnée équivalente (p.i.r.e.) ne dépasse pas celle nécessaire à une communication réussie.

Cet appareil est conforme aux normes RSS exemptes de licence d'Industrie Canada. Son fonctionnement dépend des deux conditions suivantes : (1) cet appareil ne doit pas provoquer d'interférences nuisibles et (2) doit accepter toutes interférences reçues, y compris des interférences pouvant provoquer un fonctionnement non souhaité de l'appareil.

**AVERTISSEMENT** relatif à l'exposition aux radiofréquences. La puissance de rayonnement de cet appareil se trouve sous les limites d'exposition de radiofréquences d'Industrie Canada. Néanmoins, cet appareil doit être utilisé de telle sorte qu'il soit mis en contact le moins possible avec le corps humain.

Afin d'éviter le dépassement éventuel des limites d'exposition aux radiofréquences d'Industrie Canada, il est recommandé de maintenir une distance de plus de 20 cm entre les antennes et l'utilisateur.

## Notice to users in Taiwan

### 低功率電波輻射性電機管理辦法

#### 第十二條

經型式認證合格之低功率射頻電機，非經許可，公司、商號或使用者均不得擅自變更頻率、加大功率或變更設計之特性及功能。

#### 第十四條

低功率射頻電機之使用不得影響飛航安全及干擾合法通信；經發現有干擾現象時，應立即停用，並改善至無干擾時方得繼續使用。

前項合法通信，指依電信法規定作業之無線電通信。低功率射頻電機須忍受合法通信或工業、科學及醫藥用電波輻射性電機設備之干擾。

## Notice to users in Mexico

### **Aviso para los usuarios de México**

La operación de este equipo está sujeta a las siguientes dos condiciones: (1) es posible que este equipo o dispositivo no cause interferencia perjudicial y (2) este equipo o dispositivo debe aceptar cualquier interferencia, incluyendo la que pueda causar su operación no deseada.

Para saber el modelo de la tarjeta inalámbrica utilizada, revise la etiqueta regulatoria de la impresora.

## Wireless notice to users in Japan

この機器は技術基準適合証明又は工事設計認証を受けた無線設備を搭載しています。

## Environmental product stewardship program

Hewlett-Packard is committed to providing quality products in an environmentally sustainable manner:

- Design for recycling has been incorporated into this product.
- The number of materials has been kept to a minimum while ensuring proper functionality and reliability.
- Dissimilar materials have been designed to separate easily.
- Fasteners and other connections are easy to locate, access, and remove using common tools.
- High priority parts have been designed to access quickly for efficient disassembly and repair.

For more information, visit [www.hp.com/ecosolutions](http://www.hp.com/ecosolutions)

This section contains the following topics:

- [Paper use](#)
- [Plastics](#)
- [Material safety data sheets](#)
- [Recycling program](#)
- [HP inkjet supplies recycling program](#)
- [Disposal of waste equipment by users](#)
- [Power consumption](#)
- [Chemical substances](#)
- [Battery disposal in the Taiwan](#)
- [Battery notice for Brazil](#)
- [California Perchlorate Material Notice](#)
- [Declaration of the Presence Condition of the Restricted Substances Marking \(Taiwan\)](#)
- [Toxic and hazardous substance table \(China\)](#)
- [Restriction of hazardous substance \(Ukraine\)](#)
- [Restriction of hazardous substance \(India\)](#)

- [EPEAT](#)
- [China SEPA Ecolabel User Information](#)

## Paper use

This product is suited for the use of recycled paper according to DIN 19309 and EN 12281:2002.

## Plastics

Plastic parts over 25 grams are marked according to international standards that enhance the ability to identify plastics for recycling purposes at the end of product life.

## Material safety data sheets

Material safety data sheets (MSDS) can be obtained from the HP website at:

[www.hp.com/go/msds](http://www.hp.com/go/msds)

## Recycling program

HP offers an increasing number of product return and recycling programs in many countries/regions, and partners with some of the largest electronic recycling centers throughout the world. HP conserves resources by reselling some of its most popular products. For more information regarding recycling of HP products, please visit:

[www.hp.com/recycle](http://www.hp.com/recycle)

## HP inkjet supplies recycling program

HP is committed to protecting the environment. The HP Inkjet Supplies Recycling Program is available in many countries/regions, and lets you recycle used print cartridges and ink cartridges free of charge. For more information, go to the following website:

[www.hp.com/hpinfo/globalcitizenship/environment/recycle/](http://www.hp.com/hpinfo/globalcitizenship/environment/recycle/)

## Disposal of waste equipment by users



This symbol means do not dispose of your product with your other household waste. Instead, you should protect human health and the environment by handing over your waste equipment to a designated collection point for the recycling of waste electrical and electronic equipment. For more information, please contact your household waste disposal service, or go to <http://www.hp.com/recycle>.

## Power consumption

Hewlett-Packard printing and imaging equipment marked with the ENERGY STAR® logo is qualified to the U.S. Environmental Protection Agency's ENERGY STAR specifications for imaging equipment. The following mark will appear on ENERGY STAR qualified imaging products:



Additional ENERGY STAR qualified imaging product model information is listed at: [www.hp.com/go/energystar](http://www.hp.com/go/energystar)

## Chemical substances

HP is committed to providing our customers with information about the chemical substances in our products as needed to comply with legal requirements such as REACH (*Regulation EC No 1907/2006 of the European Parliament and the Council*). A chemical information report for this product can be found at: [www.hp.com/go/reach](http://www.hp.com/go/reach).

## Battery disposal in the Taiwan



廢電池請回收

## Battery notice for Brazil

A bateria deste equipamento não foi projetada para ser removida pelo cliente.

## California Perchlorate Material Notice

### California Perchlorate Material Notice

Perchlorate material - special handling may apply. See:  
<http://www.dtsc.ca.gov/hazardouswaste/perchlorate/>

This product's real-time clock battery or coin cell battery may contain perchlorate and may require special handling when recycled or disposed of in California.

# Declaration of the Presence Condition of the Restricted Substances Marking (Taiwan)

限用物質含有情況標示聲明書

Declaration of the Presence Condition of the Restricted Substances Marking

單元 Unit	限用物質及其化學符號					
	Restricted substances and its chemical symbols					
	鉛 Lead (Pb)	汞 Mercury (Hg)	鎘 Cadmium (Cd)	六價鉻 Hexavalent chromium (Cr <sup>+6</sup> )	多溴聯苯 Polybrominated biphenyls (PBB)	多溴二苯醚 Polybrominated diphenyl ethers (PBDE)
外殼和紙匣 (External Casings and Trays)	0	0	0	0	0	0
電線 (Cables)	0	0	0	0	0	0
印刷電路板 (Printed Circuit Boards)	—	0	0	0	0	0
列印引擎(Print Engine)	—	0	0	0	0	0
列印機組件 (Print Assembly)	—	0	0	0	0	0
噴墨印表機墨水匣 (Print Supplies)	0	0	0	0	0	0
列印機配件 (Print Accessory)	—	0	0	0	0	0

備考 1. “超出 0.1 wt %” 及 “超出 0.01 wt %” 係指限用物質之百分比含量超出百分比含量基準值。

Note 1: “Exceeding 0.1 wt %” and “exceeding 0.01 wt %” indicate that the percentage content of the restricted substance exceeds the reference percentage value of presence condition.

備考 2. “0” 係指該項限用物質之百分比含量未超出百分比含量基準值。

Note 2: “0” indicates that the percentage content of the restricted substance does not exceed the percentage of reference value of presence.

備考 3. “—” 係指該項限用物質為排除項目。

Note 3: The “—” indicates that the restricted substance corresponds to the exemption.

若要存取產品的最新使用指南或手冊，請前往 [www.support.hp.com](http://www.support.hp.com)。選取搜尋您的產品，然後依照畫面上的指示繼續執行。

To access the latest user guides or manuals for your product, go to [www.support.hp.com](http://www.support.hp.com). Select **Find your product**, and then follow the onscreen instructions.

## Toxic and hazardous substance table (China)

有毒有害物质表						
根据中国《电子信息产品污染控制管理办法》						
零件描述	有毒有害物质和元素					
	铅	汞	镉	六价铬	多溴联苯	多溴联苯醚
外壳和托盒*	0	0	0	0	0	0
电缆*	0	0	0	0	0	0
印刷电路板*	X	0	0	0	0	0
打印系统*	X	0	0	0	0	0
显示器*	X	0	0	0	0	0
喷墨打印机墨盒*	0	0	0	0	0	0
驱动光盘*	X	0	0	0	0	0
扫描仪*	X	X	0	0	0	0
网络配件*	X	0	0	0	0	0
电池板*	X	0	0	0	0	0
自动双面打印系统*	X	0	0	0	0	0
外部电源*	X	0	0	0	0	0

0: 指此零件的所有均一材质中包含的这种有毒有害物质, 含量低于SJ/T11363-2006 的限制  
X: 指此零件使用的均一材质中至少有一种包含的这种有毒有害物质, 含量高于SJ/T11363-2006 的限制  
注: 环保使用期限的参考标识取决于产品正常工作的温度和湿度等条件  
\*以上只适用于使用这些零件的产品

## Restriction of hazardous substance (Ukraine)

### Технічний регламент щодо обмеження використання небезпечних речовин (Україна)

Обладнання відповідає вимогам Технічного регламенту щодо обмеження використання деяких небезпечних речовин в електричному та електронному обладнанні, затвердженого постановою Кабінету Міністрів України від 3 грудня 2008 № 1057

## Restriction of hazardous substance (India)

### Restriction of hazardous substances (India)

This product complies with the "India E-waste (Management and Handling) Rule 2011" and prohibits use of lead, mercury, hexavalent chromium, polybrominated biphenyls or polybrominated diphenyl ethers in concentrations exceeding 0.1 weight % and 0.01 weight % for cadmium, except for the exemptions set in Schedule 2 of the Rule.

## EPEAT

### EPEAT

Most HP products are designed to meet EPEAT. EPEAT is a comprehensive environmental rating that helps identify greener electronics equipment. For more information on EPEAT go to [www.epeat.net](http://www.epeat.net). For information on HP's EPEAT registered products go to [www.hp.com/hpinfo/globalcitizenship/environment/pdf/epeat\\_printers.pdf](http://www.hp.com/hpinfo/globalcitizenship/environment/pdf/epeat_printers.pdf).

## China SEPA Ecolabel User Information

### 中国环境标识认证产品用户说明

噪声大于63.0Db(A)的办公设备不宜放置于办公室内，请在独立的隔离区域使用。

如需长时间使用本产品或打印大量文件，请确保在通风良好的房间内使用。

如您需要确认本产品处于零能耗状态，请按下电源关闭按钮，并将插头从电源插座断开。

您可以使用再生纸，以减少资源耗费。

## B Additional fax setup

After completing all the steps in the getting started guide, use the instructions in this section to complete your fax setup. Keep your getting started guide for later use.

In this section, you learn how to set up the printer so that faxing works successfully with equipment and services you might already have on the same phone line.

 **TIP:** You can also use the Fax Setup Wizard (Windows) or HP Utility (OS X) to help you quickly set up some important fax settings such as the answer mode and fax header information. You can access these tools through the HP software you installed with the printer. After you run these tools, follow the procedures in this section to complete your fax setup.

This section contains the following topics:

- [Set up faxing \(parallel phone systems\)](#)
- [Test fax setup](#)

### Set up faxing (parallel phone systems)

Before you begin setting up the printer for faxing, determine which kind of phone system your country/region uses. The instructions for fax setup differ depending on whether you have a serial- or parallel-type phone system.

- If you do not see your country/region listed in the table, you probably have a serial-type phone system. In a serial-type phone system, the connector type on your shared telephone equipment (modems, phones, and answering machines) does not allow a physical connection to the "2-EXT" port on the printer. Instead, all equipment must be connected at the telephone wall jack.

 **NOTE:** In some countries/regions that use serial-type phone systems, the phone cord that came with the printer might have an additional wall plug attached to it. This enables you to connect other telecom devices to the wall jack where you plug in the printer.

You might need to connect the supplied phone cord to the adapter provided for your country/region.

- If your country/region is listed in the table, you probably have a parallel-type telephone system. In a parallel-type phone system, you are able to connect shared telephone equipment to the phone line by using the "2-EXT" port on the back of the printer.

 **NOTE:** If you have a parallel-type phone system, HP recommends you use the 2-wire phone cord supplied with the printer to connect it to the telephone wall jack.

**Table B-1 Countries/regions with a parallel-type phone system**

Argentina	Australia	Brazil
Canada	Chile	China
Colombia	Greece	India
Indonesia	Ireland	Japan
Korea	Latin America	Malaysia
Mexico	Philippines	Poland



**Table B-1 Countries/regions with a parallel-type phone system (continued)**

Portugal	Russia	Saudi Arabia
Singapore	Spain	Taiwan
Thailand	USA	Venezuela
Vietnam		

If you are unsure which kind of telephone system you have (serial or parallel), check with your telephone company.

This section contains the following topics:

- [Select the correct fax setup for your home or office](#)
- [Case A: Separate fax line \(no voice calls received\)](#)
- [Case B: Set up the printer with DSL](#)
- [Case C: Set up the printer with a PBX phone system or an ISDN line](#)
- [Case D: Fax with a distinctive ring service on the same line](#)
- [Case E: Shared voice/fax line](#)
- [Case F: Shared voice/fax line with voice mail](#)
- [Case G: Fax line shared with computer modem \(no voice calls received\)](#)
- [Case H: Shared voice/fax line with computer modem](#)
- [Case I: Shared voice/fax line with answering machine](#)
- [Case J: Shared voice/fax line with computer modem and answering machine](#)
- [Case K: Shared voice/fax line with computer dial-up modem and voice mail](#)

## Select the correct fax setup for your home or office

To fax successfully, you need to know what types of equipment and services (if any) share the same phone line with the printer. This is important because you might need to connect some of your existing office equipment directly to the printer, and you might also need to change some fax settings before you can fax successfully.

1. Determine if your telephone system is serial or parallel.  
For more information, see [Set up faxing \(parallel phone systems\)](#).
2. Select the combination of equipment and services sharing your fax line.
  - DSL: A Digital subscriber line (DSL) service through your telephone company. (DSL might be called ADSL in your country/region.)
  - PBX: A private branch exchange (PBX) phone system.
  - ISDN: An integrated services digital network (ISDN) system.
  - Distinctive ring service: A distinctive ring service through your telephone company provides multiple telephone numbers with different ring patterns.
  - Voice calls: Voice calls are received at the same phone number you use for fax calls on the printer.

- **Computer dial-up modem:** A computer dial-up modem is on the same phone line as the printer. If you answer Yes to any of the following questions, you are using a computer dial-up modem:
    - Do you send and receive faxes directly to and from your computer software applications through a dial-up connection?
    - Do you send and receive email messages on your computer through a dial-up connection?
    - Do you access the Internet from your computer through a dial-up connection?
  - **Answering machine:** An answering machine that answers voice calls at the same phone number you use for fax calls on the printer.
  - **Voice mail service:** A voice mail subscription through your telephone company at the same number you use for fax calls on the printer.
3. From the following table, select the combination of equipment and services applicable to your home or office setting. Then look up the recommended fax setup. Step-by-step instructions are included for each case in the sections that follow.

 **NOTE:** If your home or office setup is not described in this section, set up the printer as you would a regular analog phone. Make sure you use the phone cord supplied in the box to connect one end to your telephone wall jack and the other end to the port labeled 1-LINE on the back of the printer. If you use another phone cord, you might experience problems sending and receiving faxes.

You might need to connect the supplied phone cord to the adapter provided for your country/region.

Other equipment or services sharing your fax line							Recommended fax setup
DSL	PBX	Distinctive ring service	Voice calls	Computer dial-up modem	Answering machine	Voice mail service	
							Case A: <u>Separate fax line (no voice calls received)</u>
✓							Case B: <u>Set up the printer with DSL</u>
	✓						Case C: <u>Set up the printer with a PBX phone system or an ISDN line</u>
		✓					Case D: <u>Fax with a distinctive ring service on the same line</u>
			✓				Case E: <u>Shared voice/fax line</u>
			✓			✓	Case F: <u>Shared voice/fax line with voice mail</u>
				✓			Case G: <u>Fax line shared with computer modem (no voice calls received)</u>
			✓	✓			Case H: <u>Shared voice/fax line with computer modem</u>
			✓		✓		Case I: <u>Shared voice/fax line with answering machine</u>

Other equipment or services sharing your fax line							Recommended fax setup
DSL	PBX	Distinctive ring service	Voice calls	Computer dial-up modem	Answering machine	Voice mail service	
			✓	✓	✓		Case J: Shared voice/fax line with computer modem and answering machine
			✓	✓		✓	Case K: Shared voice/fax line with computer dial-up modem and voice mail

## Case A: Separate fax line (no voice calls received)

If you have a separate phone line on which you receive no voice calls, and you have no other equipment connected on this phone line, set up the printer as described in this section.

**Figure B-1** Back view of the printer

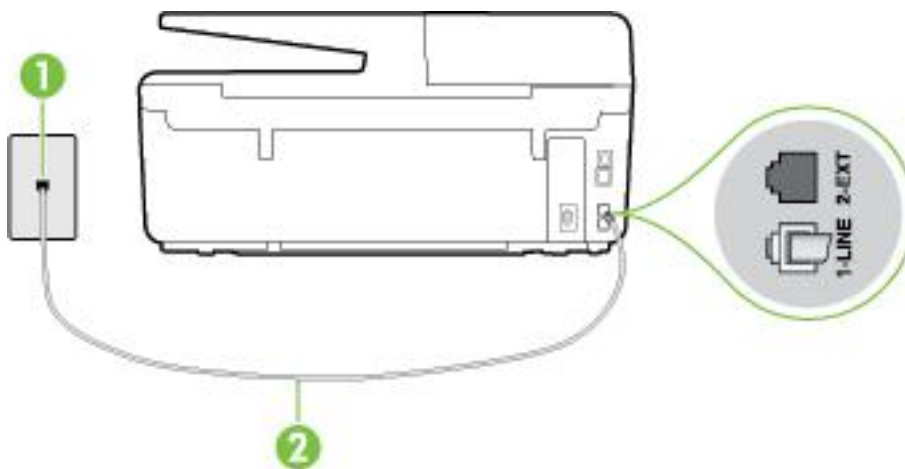

1	Telephone wall jack
2	Use the phone cord supplied in the box with the printer to connect to the 1-LINE port. You might need to connect the supplied phone cord to the adapter provided for your country/region.

### To set up the printer with a separate fax line

- Using the phone cord supplied in the box with the printer, connect one end to your telephone wall jack, then connect the other end to the port labeled 1-LINE on the back of the printer.



**NOTE:** You might need to connect the supplied phone cord to the adapter provided for your country/region.

If you do not use the supplied cord to connect from the telephone wall jack to the printer, you might not be able to fax successfully. This special phone cord is different from the phone cords you might already have in your home or office.

- Turn on the **Auto Answer** setting.
- (Optional) Change the **Rings to Answer** setting to the lowest setting (two rings).
- Run a fax test.

When the phone rings, the printer answers automatically after the number of rings you set in the **Rings to Answer** setting. The printer begins emitting fax reception tones to the sending fax machine and receives the fax.

## Case B: Set up the printer with DSL

If you have a DSL service through your telephone company, and do not connect any equipment to the printer, use the instructions in this section to connect a DSL filter between the telephone wall jack and the printer. The DSL filter removes the digital signal that can interfere with the printer, so the printer can communicate correctly with the phone line. (DSL might be called ADSL in your country/region.)

 **NOTE:** If you have a DSL line and you do not connect the DSL filter, you cannot send and receive faxes with the printer.

**Figure B-2** Back view of the printer

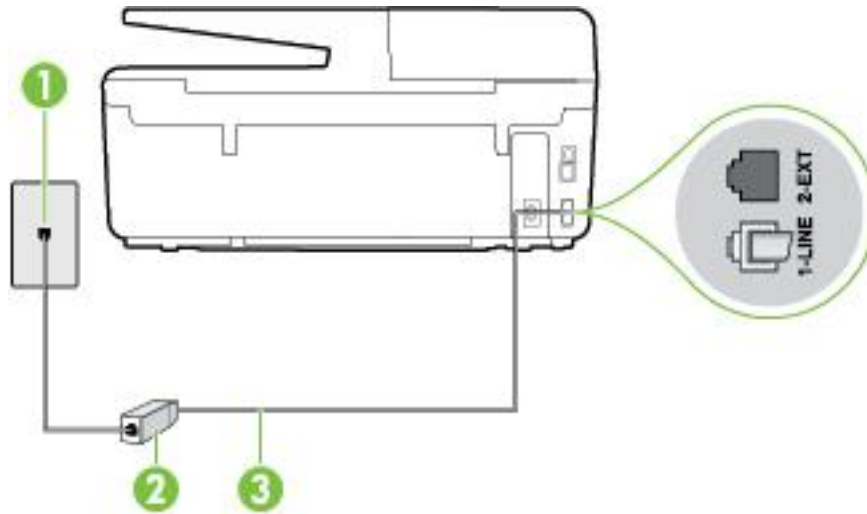

1	Telephone wall jack
2	DSL (or ADSL) filter and cord supplied by your DSL provider
3	Use the phone cord supplied in the box with the printer to connect to the 1-LINE port. You might need to connect the supplied phone cord to the adapter provided for your country/region.

### To set up the printer with DSL

1. Obtain a DSL filter from your DSL provider.
2. Using the phone cord supplied in the box with the printer, connect one end to the open port on the DSL filter, and then connect the other end to the port labeled 1-LINE on the back of the printer.

 **NOTE:** You might need to connect the supplied phone cord to the adapter provided for your country/region.

If you do not use the supplied cord to connect from the DSL filter to the printer, you might not be able to fax successfully. This special phone cord is different from the phone cords you might already have in your home or office.

As only one phone cord is supplied, you might need to obtain additional phone cords for this setup.

3. Connect an additional phone cord from the DSL filter to the telephone wall jack.
4. Run a fax test.

If you encounter problems setting up the printer with optional equipment, contact your local service provider or vendor for further assistance.

## Case C: Set up the printer with a PBX phone system or an ISDN line

If you are using either a PBX phone system or an ISDN converter/terminal adapter, make sure you do the following:

- If you are using either a PBX or an ISDN converter/terminal adaptor, connect the printer to the port that is designated for fax and phone use. Also, make sure that the terminal adapter is set to the correct switch type for your country/region, if possible.



**NOTE:** Some ISDN systems allow you to configure the ports for specific phone equipment. For example, you might have assigned one port for telephone and Group 3 fax and another port for multiple purposes. If you have problems when connected to the fax/phone port of your ISDN converter, try using the port designated for multiple purposes; it might be labeled "multi-combi" or something similar.

---

- If you are using a PBX phone system, set the call waiting tone to "off."



**NOTE:** Many digital PBX systems include a call-waiting tone that is set to "on" by default. The call waiting tone interferes with any fax transmission, and you cannot send or receive faxes with the printer. Refer to the documentation that came with your PBX phone system for instructions on how to turn off the call-waiting tone.

---

- If you are using a PBX phone system, dial the number for an outside line before dialing the fax number.
- Make sure you use the supplied cord to connect from the telephone wall jack to the printer. If you do not, you might not be able to fax successfully. This special phone cord is different from the phone cords you might already have in your home or office. If the supplied phone cord is too short, you can purchase a longer 2-wire phone cord from your local electronics store and extend it.

You might need to connect the supplied phone cord to the adapter provided for your country/region.

If you encounter problems setting up the printer with optional equipment, contact your local service provider or vendor for further assistance.

## Case D: Fax with a distinctive ring service on the same line

If you subscribe to a distinctive ring service (through your telephone company) that allows you to have multiple phone numbers on one phone line, each with a different ring pattern, set up the printer as described in this section.

**Figure B-3** Back view of the printer

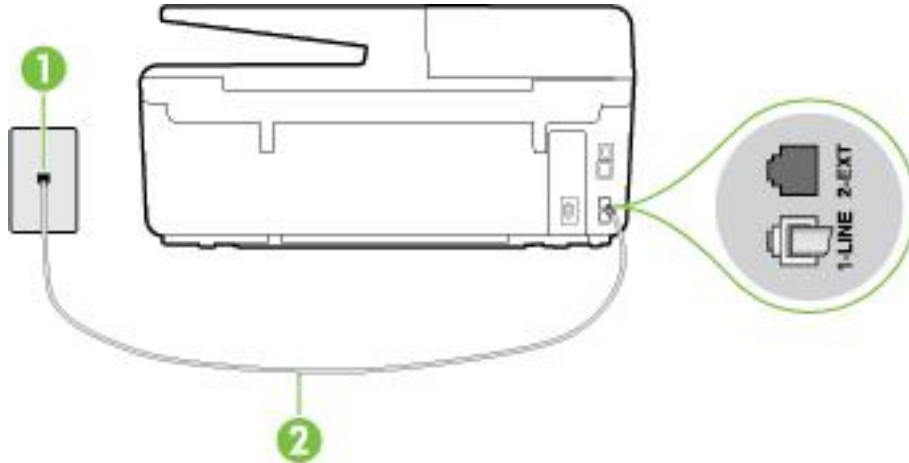

1	Telephone wall jack
2	Use the phone cord supplied in the box with the printer to connect to the 1-LINE port. You might need to connect the supplied phone cord to the adapter provided for your country/region.

### To set up the printer with a distinctive ring service

1. Using the phone cord supplied in the box with the printer, connect one end to your telephone wall jack, then connect the other end to the port labeled 1-LINE on the back of the printer.

 **NOTE:** You might need to connect the supplied phone cord to the adapter provided for your country/region.

If you do not use the supplied cord to connect from the telephone wall jack to the printer, you might not be able to fax successfully. This special phone cord is different from the phone cords you might already have in your home or office.

2. Turn on the **Auto Answer** setting.
3. Change the **Distinctive Ring** setting to match the pattern that the telephone company assigned to your fax number.

 **NOTE:** By default, the printer is set to answer all ring patterns. If you do not set the **Distinctive Ring** to match the ring pattern assigned to your fax number, the printer might answer both voice calls and fax calls or it might not answer at all.

 **TIP:** You can also use the Ring Pattern Detection feature in the printer control panel to set distinctive ring. With this feature, the printer recognizes and records the ring pattern of an incoming call and, based on this call, automatically determines the distinctive ring pattern assigned by your telephone company to fax calls. For more information, see [Change the answer ring pattern for distinctive ring](#).

4. (Optional) Change the **Rings to Answer** setting to the lowest setting (two rings).
5. Run a fax test.

The printer automatically answers incoming calls that have the ring pattern you selected ( **Distinctive Ring** setting) after the number of rings you selected ( **Rings to Answer** setting). The printer begins emitting fax reception tones to the sending fax machine and receives the fax.

If you encounter problems setting up the printer with optional equipment, contact your local service provider or vendor for further assistance.

## Case E: Shared voice/fax line

If you receive both voice calls and fax calls at the same phone number, and you have no other office equipment (or voice mail) on this phone line, set up the printer as described in this section.

**Figure B-4** Back view of the printer

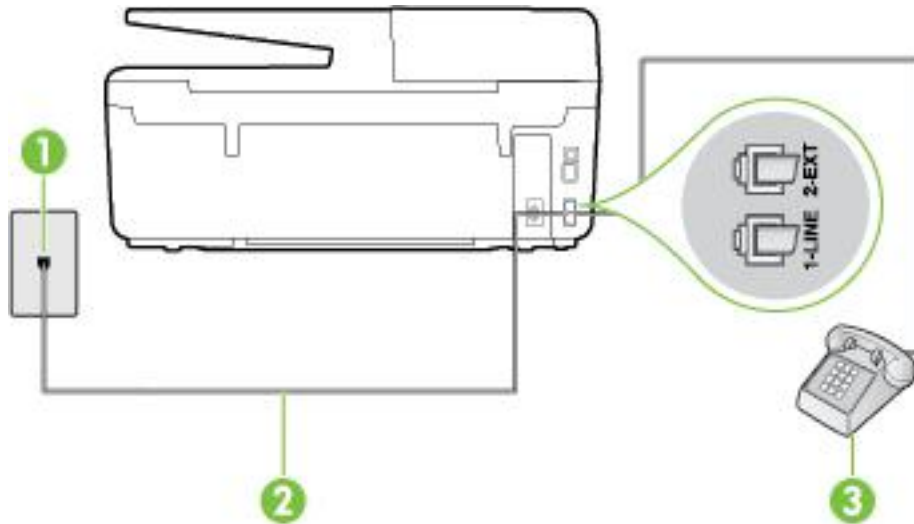

1	Telephone wall jack
2	Use the phone cord supplied in the box with the printer to connect to the 1-LINE port. You might need to connect the supplied phone cord to the adapter provided for your country/region.
3	Telephone (optional)

### To set up the printer with a shared voice/fax line

1. Using the phone cord supplied in the box with the printer, connect one end to your telephone wall jack, then connect the other end to the port labeled 1-LINE on the back of the printer.



**NOTE:** You might need to connect the supplied phone cord to the adapter provided for your country/region.

If you do not use the supplied cord to connect from the telephone wall jack to the printer, you might not be able to fax successfully. This special phone cord is different from the phone cords you might already have in your home or office.

2. Do one of the following:
  - If you have a parallel-type phone system, remove the white plug from the port labeled 2-EXT on the back of the printer, and then connect a phone to this port.
  - If you have a serial-type phone system, you might plug your phone directly on top of the printer cable which has a wall plug attached to it.
3. Now you need to decide how you want the printer to answer calls, automatically or manually:
  - If you set up the printer to answer calls **automatically**, it answers all incoming calls and receives faxes. The printer cannot distinguish between fax and voice calls in this case; if you suspect the call

is a voice call, you need to answer it before the printer answers the call. To set up the printer to answer calls automatically, turn on the **Auto Answer** setting.

- If you set up the printer to answer faxes **manually**, you must be available to respond in person to incoming fax calls or the printer cannot receive faxes. To set up the printer to answer calls manually, turn off the **Auto Answer** setting.

#### 4. Run a fax test.

If you pick up the phone before the printer answers the call and hear fax tones from a sending fax machine, you need to answer the fax call manually.

If you encounter problems setting up the printer with optional equipment, contact your local service provider or vendor for further assistance.

## Case F: Shared voice/fax line with voice mail

If you receive both voice calls and fax calls at the same phone number, and you also subscribe to a voice mail service through your telephone company, set up the printer as described in this section.

**NOTE:** You cannot receive faxes automatically if you have a voice mail service at the same phone number you use for fax calls. You must receive faxes manually; this means you must be available to respond in person to incoming fax calls. If you want to receive faxes automatically instead, contact your telephone company to subscribe to a distinctive ring service, or to obtain a separate phone line for faxing.

**Figure B-5** Back view of the printer

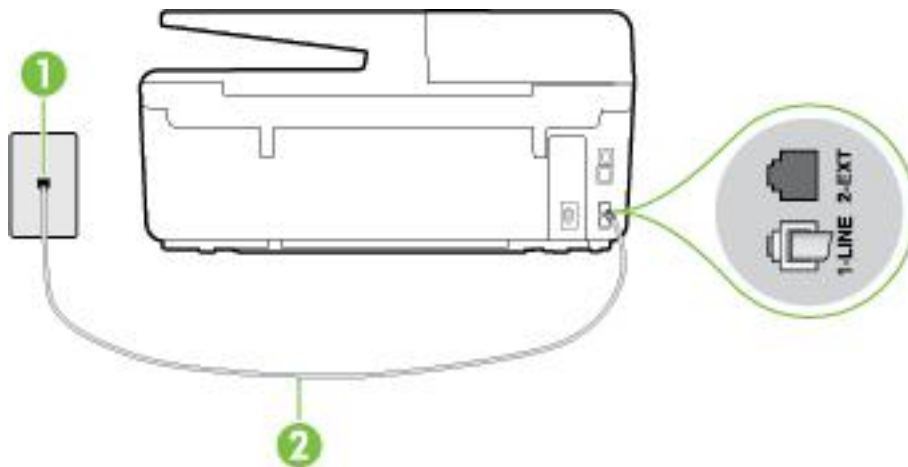

1	Telephone wall jack
2	Use the phone cord supplied in the box with the printer to connect to the 1-LINE port. You might need to connect the supplied phone cord to the adapter provided for your country/region.

### To set up the printer with voice mail

1. Using the phone cord supplied in the box with the printer, connect one end to your telephone wall jack, then connect the other end to the port labeled 1-LINE on the back of the printer.

You might need to connect the supplied phone cord to the adapter provided for your country/region.



---

 **NOTE:** You might need to connect the supplied phone cord to the adapter provided for your country/region.

If you do not use the supplied cord to connect from the telephone wall jack to the printer, you might not be able to fax successfully. This special phone cord is different from the phone cords you might already have in your home or office.

---

2. Turn off the **Auto Answer** setting.
3. Run a fax test.

You must be available to respond in person to incoming fax calls, or the printer cannot receive faxes. You must initiate the manual fax before voicemail picks up the line.

If you encounter problems setting up the printer with optional equipment, contact your local service provider or vendor for further assistance.

## Case G: Fax line shared with computer modem (no voice calls received)

If you have a fax line on which you receive no voice calls, and you also have a computer modem connected on this line, set up the printer as described in this section.

---

 **NOTE:** If you have a computer dial-up modem, your computer dial-up modem shares the phone line with the printer. You cannot use both your modem and the printer simultaneously. For example, you cannot use the printer for faxing while you are using your computer dial-up modem to send an email or access the Internet.

---

- [Set up the printer with a computer dial-up modem](#)
- [Set up the printer with a computer DSL/ADSL modem](#)

## Set up the printer with a computer dial-up modem

If you are using the same phone line for sending faxes and for a computer dial-up modem, follow these directions for setting up the printer.

**Figure B-6** Back view of the printer

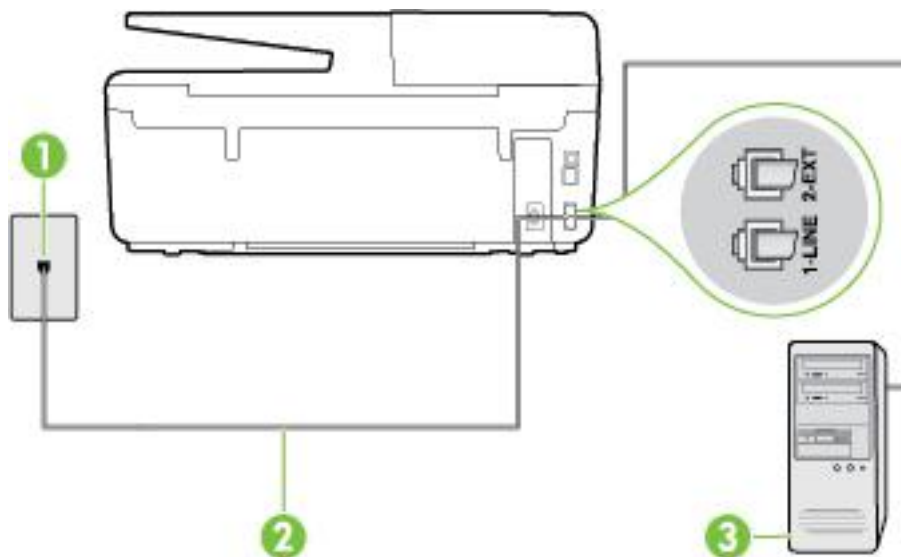

---

1 Telephone wall jack

---

2 Use the phone cord supplied in the box with the printer to connect to the 1-LINE port.

---

You might need to connect the supplied phone cord to the adapter provided for your country/region.

---

3

Computer with modem

---

### To set up the printer with a computer dial-up modem

1. Remove the white plug from the port labeled 2-EXT on the back of the printer.
2. Find the phone cord that connects from the back of your computer (your computer dial-up modem) to a telephone wall jack. Disconnect the cord from the telephone wall jack and plug it into the port labeled 2-EXT on the back of the printer.
3. Using the phone cord supplied in the box with the printer, connect one end to your telephone wall jack, then connect the other end to the port labeled 1-LINE on the back of the printer.



**NOTE:** You might need to connect the supplied phone cord to the adapter provided for your country/region.

If you do not use the supplied cord to connect from the telephone wall jack to the printer, you might not be able to fax successfully. This special phone cord is different from the phone cords you might already have in your home or office.

---

4. If your modem software is set to receive faxes to your computer automatically, turn off that setting.



**NOTE:** If you do not turn off the automatic fax reception setting in your modem software, the printer cannot receive faxes.

---

5. Turn on the **Auto Answer** setting.
6. (Optional) Change the **Rings to Answer** setting to the lowest setting (two rings).
7. Run a fax test.

When the phone rings, the printer automatically answers after the number of rings you set in the **Rings to Answer** setting. The printer begins emitting fax reception tones to the sending fax machine and receives the fax.

If you encounter problems setting up the printer with optional equipment, contact your local service provider or vendor for further assistance.

### Set up the printer with a computer DSL/ADSL modem

If you have a DSL line and use that phone line to send faxes, follow these instructions to set up your fax.

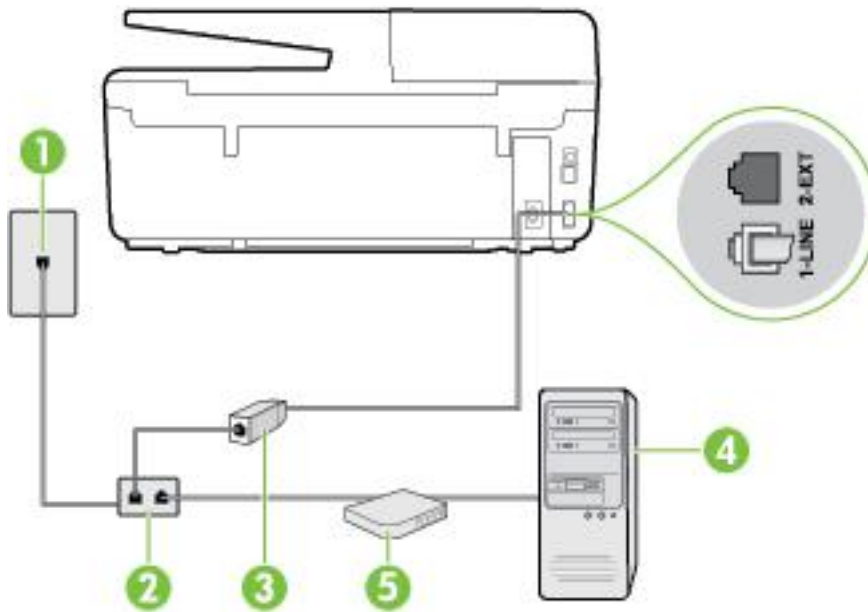

1	Telephone wall jack
2	Parallel splitter
3	DSL/ADSL filter
4	Computer
5	Computer DSL/ADSL modem

**NOTE:** You need to purchase a parallel splitter. A parallel splitter has one RJ-11 port on the front and two RJ-11 ports on the back. Do not use a 2-line phone splitter, a serial splitter, or a parallel splitter which has two RJ-11 ports on the front and a plug on the back.

**Figure B-7** Example of a parallel splitter



### To set up the printer with a computer DSL/ADSL modem

1. Obtain a DSL filter from your DSL provider.
2. Using the phone cord provided in the box with the printer, connect one end to the DSL filter, and then connect the other end to the port labeled 1-LINE on the back of the printer.

**NOTE:** You might need to connect the supplied phone cord to the adapter provided for your country/region.

If you do not use the supplied cord to connect from the DSL filter to the back of the printer, you might not be able to fax successfully. This special phone cord is different from the phone cords you might already have in your home or office.

3. Connect the DSL filter to the parallel splitter.
4. Connect the DSL modem to the parallel splitter.
5. Connect the parallel splitter to the wall jack.
6. Run a fax test.

When the phone rings, the printer automatically answers after the number of rings you set in the **Rings to Answer** setting. The printer begins emitting fax reception tones to the sending fax machine and receives the fax.

If you encounter problems setting up the printer with optional equipment, contact your local service provider or vendor for further assistance.

## Case H: Shared voice/fax line with computer modem

There are two different ways to set up the printer with your computer based on the number of phone ports on your computer. Before you begin, check your computer to see if it has one or two phone ports.

---

 **NOTE:** If your computer has only one phone port, you need to purchase a parallel splitter (also called a coupler), as shown in the illustration. (A parallel splitter has one RJ-11 port on the front and two RJ-11 ports on the back. Do not use a two-line phone splitter, a serial splitter, or a parallel splitter which has two RJ-11 ports on the front and a plug on the back.)

---

- [Shared voice/fax with computer dial-up modem](#)
- [Shared voice/fax with computer DSL/ADSL modem](#)

### Shared voice/fax with computer dial-up modem

If you use your phone line for both fax and telephone calls, use these instructions to set up your fax.

There are two different ways to set up the printer with your computer based on the number of phone ports on your computer. Before you begin, check your computer to see if it has one or two phone ports.

---

 **NOTE:** If your computer has only one phone port, you need to purchase a parallel splitter (also called a coupler), as shown in the illustration. (A parallel splitter has one RJ-11 port on the front and two RJ-11 ports on the back. Do not use a two-line phone splitter, a serial splitter, or a parallel splitter which has two RJ-11 ports on the front and a plug on the back.)

---

**Figure B-8** Example of a parallel splitter



**Figure B-9** Back view of the printer

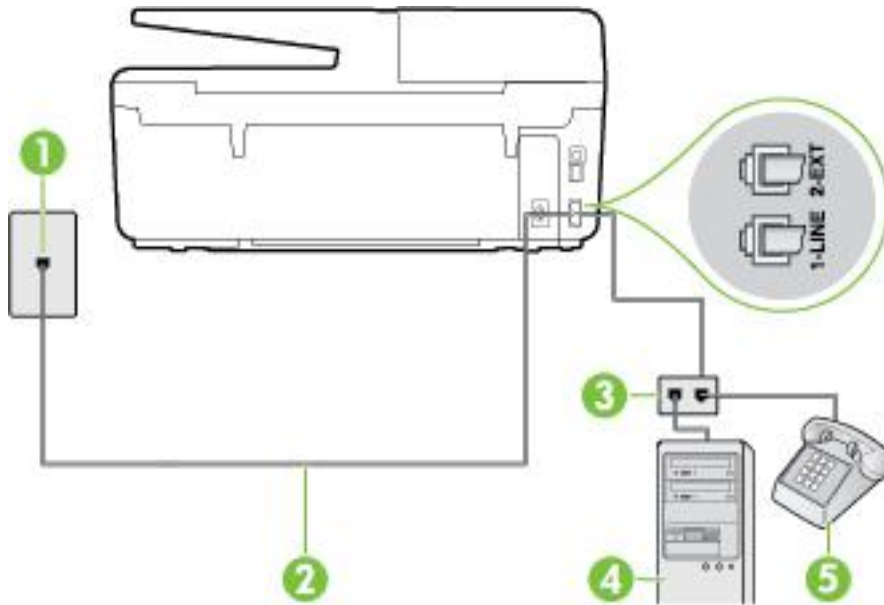

1	Telephone wall jack
2	Use the phone cord supplied in the box with the printer to connect to the 1-LINE port.
3	Parallel splitter
4	Computer with modem
5	Telephone

### To set up the printer on the same phone line as a computer with two phone ports

1. Remove the white plug from the port labeled 2-EXT on the back of the printer.
2. Find the phone cord that connects from the back of your computer (your computer dial-up modem) to a telephone wall jack. Disconnect the cord from the telephone wall jack and plug it into the port labeled 2-EXT on the back of the printer.
3. Connect a phone to the "OUT" port on the back of your computer dial-up modem.
4. Using the phone cord supplied in the box with the printer, connect one end to your telephone wall jack, then connect the other end to the port labeled 1-LINE on the back of the printer.

 **NOTE:** You might need to connect the supplied phone cord to the adapter provided for your country/region.

If you do not use the supplied cord to connect from the telephone wall jack to the printer, you might not be able to fax successfully. This special phone cord is different from the phone cords you might already have in your home or office.

5. If your modem software is set to receive faxes to your computer automatically, turn off that setting.

 **NOTE:** If you do not turn off the automatic fax reception setting in your modem software, the printer cannot receive faxes.

6. Now you need to decide how you want the printer to answer calls, automatically or manually:

- If you set up the printer to answer calls **automatically**, it answers all incoming calls and receives faxes. The printer cannot distinguish between fax and voice calls in this case; if you suspect the call is a voice call, you need to answer it before the printer answers the call. To set up the printer to answer calls automatically, turn on the **Auto Answer** setting.
- If you set up the printer to answer faxes **manually**, you must be available to respond in person to incoming fax calls or the printer cannot receive faxes. To set up the printer to answer calls manually, turn off the **Auto Answer** setting.

**7. Run a fax test.**

If you pick up the phone before the printer answers the call and hear fax tones from a sending fax machine, you need to answer the fax call manually.

If you use your phone line for voice, fax, and your computer dial-up modem, follow these directions to set up your fax.

If you encounter problems setting up the printer with optional equipment, contact your local service provider or vendor for further assistance.

**Shared voice/fax with computer DSL/ADSL modem**

Use these instructions if your computer has a DSL/ADSL modem

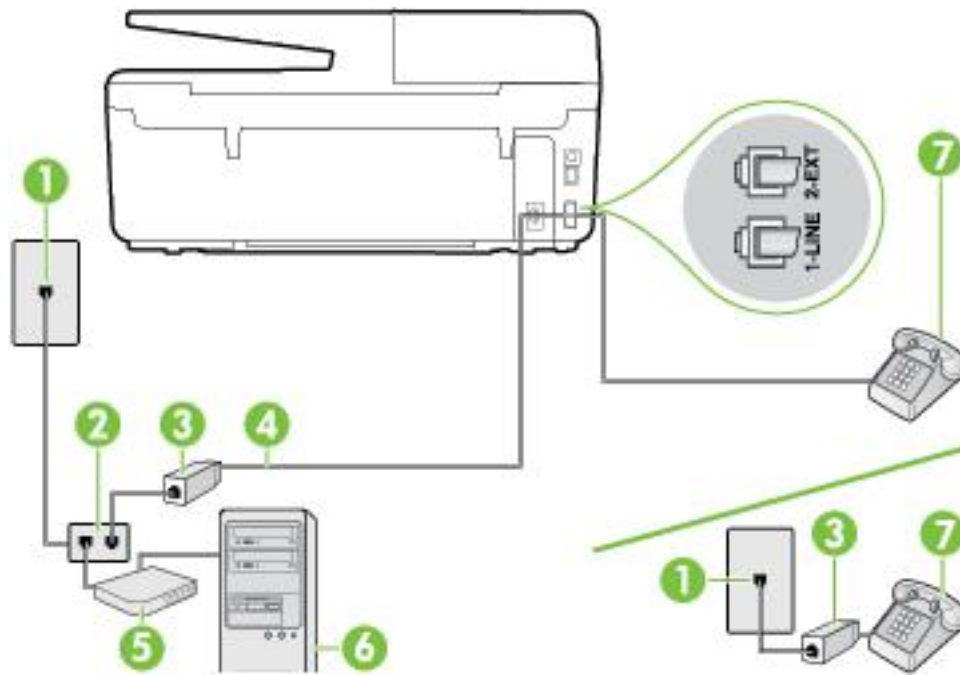

1	Telephone wall jack
2	Parallel splitter
3	DSL/ADSL filter
4	Use the phone cord provided to connect to the 1-LINE port on the back of the printer. You might need to connect the supplied phone cord to the adapter provided for your country/region.
5	DSL/ADSL modem
6	Computer
7	Telephone

---

 **NOTE:** You need to purchase a parallel splitter. A parallel splitter has one RJ-11 port on the front and two RJ-11 ports on the back. Do not use a 2-line phone splitter, a serial splitter, or a parallel splitter which has two RJ-11 ports on the front and a plug on the back.

---

**Figure B-10** Example of a parallel splitter



### To set up the printer with a computer DSL/ADSL modem

1. Obtain a DSL filter from your DSL provider.

---

 **NOTE:** Phones in other parts of the home/office sharing the same phone number with DSL service need to be connected to additional DSL filters to avoid noise when making voice calls.

---

2. Using the phone cord supplied in the box with the printers, connect one end to the DSL filter, then connect the other end to the port labeled 1-LINE on the back of the printer.

---

 **NOTE:** You might need to connect the supplied phone cord to the adapter provided for your country/region.

---

If you do not use the supplied cord to connect from the DSL filter to the printer, you might not be able to fax successfully. This special phone cord is different from phone cords you might already have in your home or office.

---

3. If you have a parallel-type phone system, remove the white plug from the port labeled 2-EXT on the back of the printer, and then connect a phone to this port.
4. Connect the DSL filter to the parallel splitter.
5. Connect the DSL modem to the parallel splitter.
6. Connect the parallel splitter to the wall jack.
7. Run a fax test.

When the phone rings, the printer automatically answers after the number of rings you set in the **Rings to Answer** setting. The printer begins emitting fax reception tones to the sending fax machine and receives the fax.

If you encounter problems setting up the printer with optional equipment, contact your local service provider or vendor for further assistance.

### Case I: Shared voice/fax line with answering machine

If you receive both voice calls and fax calls at the same phone number, and you also have an answering machine that answers voice calls at this phone number, set up the printer as described in this section.

**Figure B-11** Back view of the printer

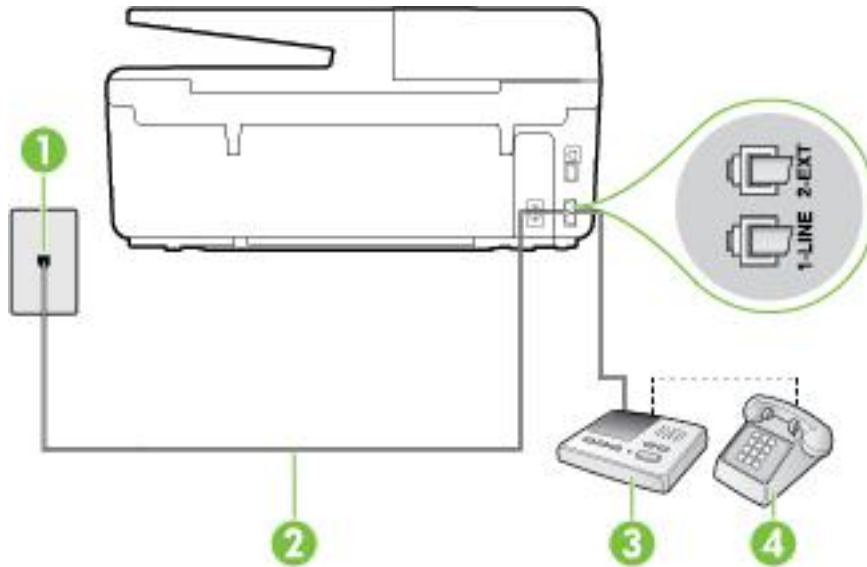

1	Telephone wall jack
2	Use the phone cord provided to connect to the 1-LINE port on the back of the printer You might need to connect the supplied phone cord to the adapter provided for your country/region.
3	Answering machine
4	Telephone (optional)

**To set up the printer with a shared voice/fax line with answering machine**

1. Remove the white plug from the port labeled 2-EXT on the back of the printer.
2. Unplug your answering machine from the telephone wall jack, and connect it to the port labeled 2-EXT on the back of the printer.

 **NOTE:** If you do not connect your answering machine directly to the printer, fax tones from a sending fax machine might be recorded on your answering machine, and you might not receive faxes with the printer.

3. Using the phone cord supplied in the box with the printer, connect one end to your telephone wall jack, then connect the other end to the port labeled 1-LINE on the back of the printer.

 **NOTE:** You might need to connect the supplied phone cord to the adapter provided for your country/region.

If you do not use the supplied cord to connect from the telephone wall jack to the printer, you might not be able to fax successfully. This special phone cord is different from the phone cords you might already have in your home or office.

4. (Optional) If your answering machine does not have a built-in phone, for convenience you might want to connect a phone to the back of your answering machine at the "OUT" port.

 **NOTE:** If your answering machine does not let you connect an external phone, you can purchase and use a parallel splitter (also known as a coupler) to connect both the answering machine and telephone to the printer. You can use standard phone cords for these connections.



5. Turn on the **Auto Answer** setting.
6. Set your answering machine to answer after a low number of rings.
7. Change the **Rings to Answer** setting on the printer to the maximum number of rings supported by your printer. (The maximum number of rings varies by country/region.)
8. Run a fax test.

When the phone rings, your answering machine answers after the number of rings you have set, and then plays your recorded greeting. The printer monitors the call during this time, "listening" for fax tones. If incoming fax tones are detected, the printer emits fax reception tones and receives the fax; if there are no fax tones, the printer stops monitoring the line and your answering machine can record a voice message.

If you encounter problems setting up the printer with optional equipment, contact your local service provider or vendor for further assistance.

## Case J: Shared voice/fax line with computer modem and answering machine

If you receive both voice calls and fax calls at the same phone number, and you also have a computer modem and answering machine connected on this phone line, set up the printer as described in this section.

---

 **NOTE:** Since your computer dial-up modem shares the phone line with the printer, you cannot use both your modem and the printer simultaneously. For example, you cannot use the printer for faxing while you are using your computer dial-up modem to send an email or access the Internet.

---

- [Shared voice/fax line with computer dial-up modem and answering machine](#)
- [Shared voice/fax line with computer DSL/ADSL modem and answering machine](#)

## Shared voice/fax line with computer dial-up modem and answering machine

There are two different ways to set up the printer with your computer based on the number of phone ports on your computer. Before you begin, check your computer to see if it has one or two phone ports.

---

 **NOTE:** If your computer has only one phone port, you need to purchase a parallel splitter (also called a coupler), as shown in the illustration. (A parallel splitter has one RJ-11 port on the front and two RJ-11 ports on the back. Do not use a two-line phone splitter, a serial splitter, or a parallel splitter which has two RJ-11 ports on the front and a plug on the back.)

---

**Figure B-12** Example of a parallel splitter



**Figure B-13** Back view of the printer

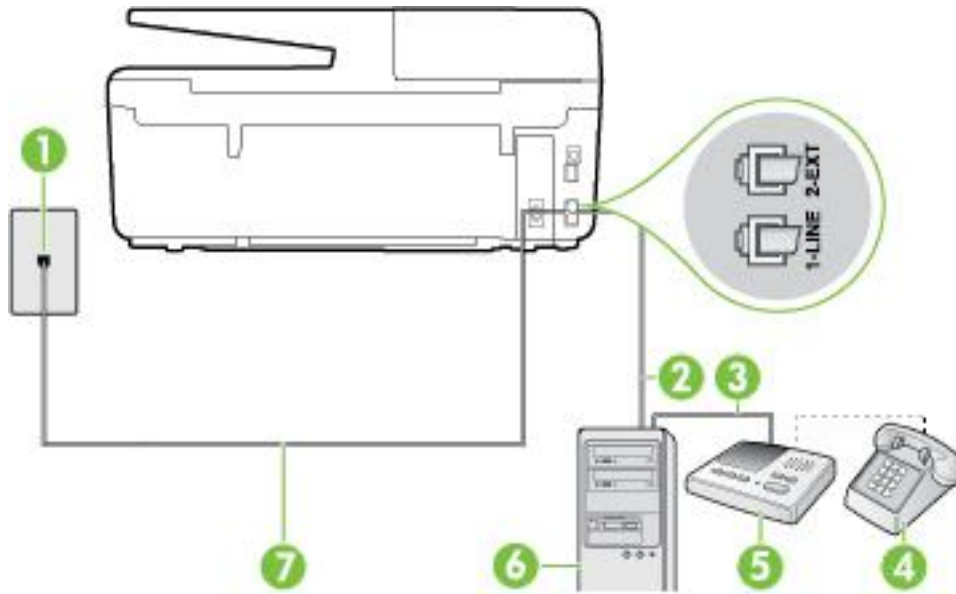

1	Telephone wall jack
2	"IN" phone port on your computer
3	"OUT" phone port on your computer
4	Telephone (optional)
5	Answering machine
6	Computer with modem
7	Use the phone cord supplied in the box with the printer to connect to the 1-LINE port. You might need to connect the supplied phone cord to the adapter provided for your country/region.

**To set up the printer on the same phone line as a computer with two phone ports**

1. Remove the white plug from the port labeled 2-EXT on the back of the printer.
2. Find the phone cord that connects from the back of your computer (your computer dial-up modem) to a telephone wall jack. Disconnect the cord from the telephone wall jack and plug it into the port labeled 2-EXT on the back of the printer.
3. Unplug your answering machine from the telephone wall jack, and connect it to the port labeled "OUT" on the back of the computer (the computer dial-up modem).
4. Using the phone cord supplied in the box with the printer, connect one end to your telephone wall jack, then connect the other end to the port labeled 1-LINE on the back of the printer.

 **NOTE:** You might need to connect the supplied phone cord to the adapter provided for your country/region.

If you do not use the supplied cord to connect from the telephone wall jack to the printer, you might not be able to fax successfully. This special phone cord is different from the phone cords you might already have in your home or office.

- (Optional) If your answering machine does not have a built-in phone, for convenience you might want to connect a phone to the back of your answering machine at the "OUT" port.

**NOTE:** If your answering machine does not let you connect an external phone, you can purchase and use a parallel splitter (also known as a coupler) to connect both the answering machine and telephone to the printer. You can use standard phone cords for these connections.

- If your modem software is set to receive faxes to your computer automatically, turn off that setting.

**NOTE:** If you do not turn off the automatic fax reception setting in your modem software, the printer cannot receive faxes.

- Turn on the **Auto Answer** setting.
- Set your answering machine to answer after a low number of rings.
- Change the **Rings to Answer** setting on the printer to the maximum number of rings supported by the product. (The maximum number of rings varies by country/region.)
- Run a fax test.

When the phone rings, your answering machine answers after the number of rings you have set, and then plays your recorded greeting. The printer monitors the call during this time, "listening" for fax tones. If incoming fax tones are detected, the printer emits fax reception tones and receives the fax; if there are no fax tones, the printer stops monitoring the line and your answering machine can record a voice message.

If you encounter problems setting up the printer with optional equipment, contact your local service provider or vendor for further assistance.

### Shared voice/fax line with computer DSL/ADSL modem and answering machine

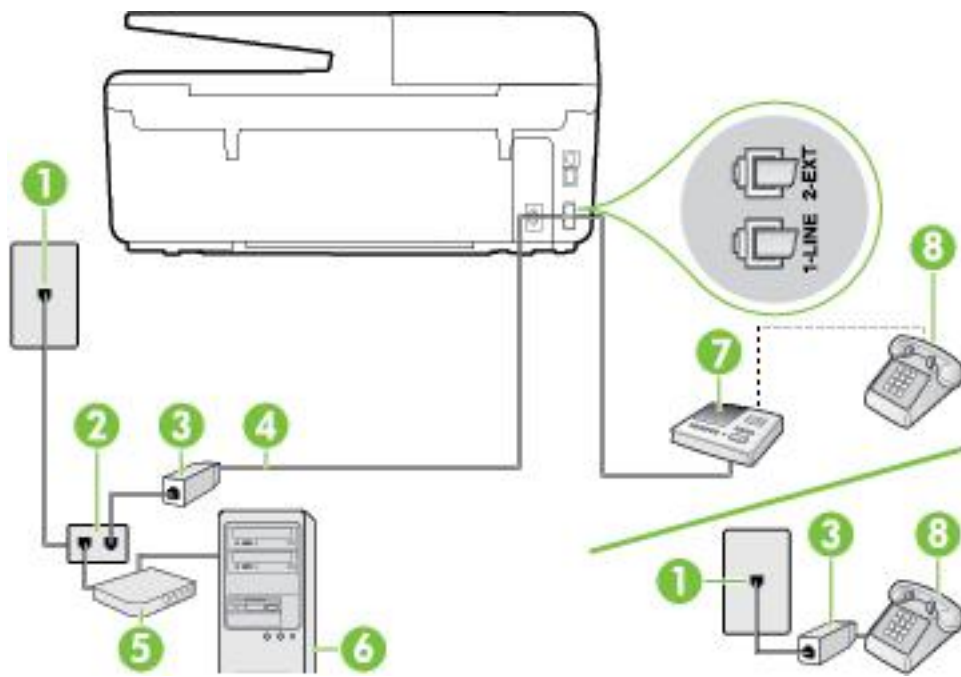

1	Telephone wall jack
2	Parallel splitter
3	DSL/ADSL filter

4	Phone cord provided with the printer connected to the 1-LINE port on the back of the printer You might need to connect the supplied phone cord to the adapter provided for your country/region.
5	DSL/ADSL modem
6	Computer
7	Answering machine
8	Telephone (optional)

 **NOTE:** You need to purchase a parallel splitter. A parallel splitter has one RJ-11 port on the front and two RJ-11 ports on the back. Do not use a 2-line phone splitter, a serial splitter, or a parallel splitter which has two RJ-11 ports on the front and a plug on the back.

**Figure B-14** Example of a parallel splitter



### To set up the printer with a computer DSL/ADSL modem

1. Obtain a DSL/ADSL filter from your DSL/ADSL provider.

 **NOTE:** Phones in other parts of the home/office sharing the same phone number with DSL/ADSL service need to be connected to additional DSL/ADSL filters, to avoid noise when making voice calls.

2. Using the phone cord supplied in the box with the printer, connect one end to the DSL/ADSL filter, then connect the other end to the port labeled 1-LINE on the back of the printer.

 **NOTE:** You might need to connect the supplied phone cord to the adapter provided for your country/region.

If you do not use the supplied cord to connect from the DSL/ADSL filter to the printer, you might not be able to fax successfully. This special phone cord is different from the phone cords you might already have in your home or office.

3. Connect the DSL/ADSL filter to the splitter.
4. Unplug the answering machine from the telephone wall jack, and connect it to the port labeled 2-EXT on the back of the printer.

 **NOTE:** If you do not connect your answering machine directly to the printer, fax tones from a sending fax machine might be recorded on your answering machine, and you might not receive faxes with the printer.

5. Connect the DSL modem to the parallel splitter.
6. Connect the parallel splitter to the wall jack.
7. Set your answering machine to answer after a low number of rings.
8. Change your **Rings to Answer** setting on the printer to the maximum number of rings supported by the printer.

 **NOTE:** The maximum number of rings varies by country/region.

9. Run a fax test.

When the phone rings, your answering machine answers after the number of rings you have set, and then play your recorded greeting. The printer monitors the call during this time, “listening” for fax tones. If incoming fax tones are detected, the printer emits fax reception tones and receive the fax; if there are no fax tones, the printer stops monitoring the line and your answering machine can record a voice message.

If you use the same phone line for telephone, fax, and have a computer DSL modem, follow these instructions to set up your fax.

If you encounter problems setting up the printer with optional equipment, contact your local service provider or vendor for further assistance.

## Case K: Shared voice/fax line with computer dial-up modem and voice mail

If you receive both voice calls and fax calls at the same phone number, use a computer dial-up modem on the same phone line, and subscribe to a voice mail service through your telephone company, set up the printer as described in this section.

---

 **NOTE:** You cannot receive faxes automatically if you have a voice mail service at the same phone number you use for fax calls. You must receive faxes manually; this means you must be available to respond in person to incoming fax calls. If you want to receive faxes automatically instead, contact your telephone company to subscribe to a distinctive ring service, or to obtain a separate phone line for faxing.

---

Since your computer dial-up modem shares the phone line with the printer, you cannot use both your modem and the printer simultaneously. For example, you cannot use the printer for faxing if you are using your computer dial-up modem to send an email or access the Internet.

There are two different ways to set up the printer with your computer based on the number of phone ports on your computer. Before you begin, check your computer to see if it has one or two phone ports.

- If your computer has only one phone port, you need to purchase a parallel splitter (also called a coupler), as shown in the illustration. (A parallel splitter has one RJ-11 port on the front and two RJ-11 ports on the back. Do not use a two-line phone splitter, a serial splitter, or a parallel splitter which has two RJ-11 ports on the front and a plug on the back.)

**Figure B-15** Example of a parallel splitter



- If your computer has two phone ports, set up the printer as follows:

**Figure B-16** Back view of the printer

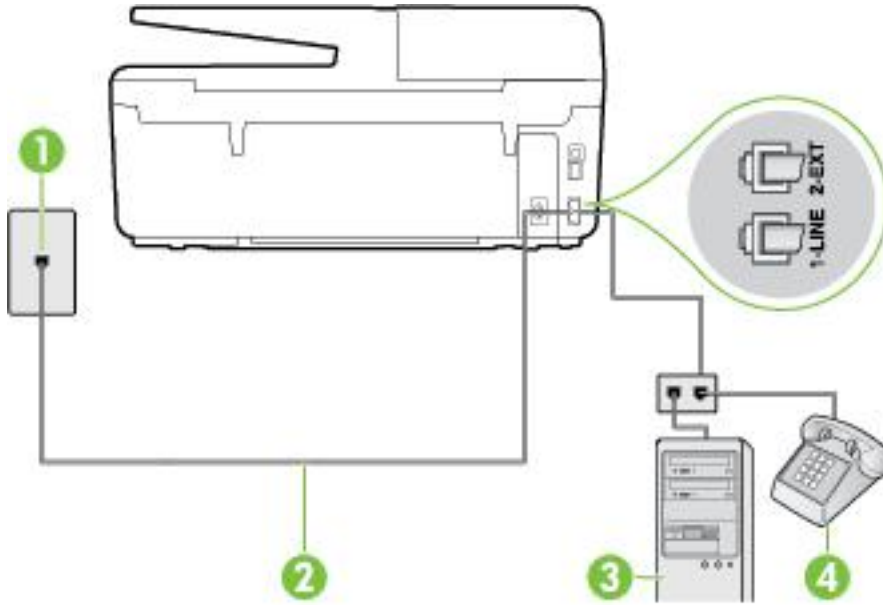

1	Telephone wall jack
2	Use the phone cord supplied in the box with the printer to connect to the 1-LINE port You might need to connect the supplied phone cord to the adapter provided for your country/ region.
3	Computer with modem
4	Telephone

**To set up the printer on the same phone line as a computer with two phone ports**

1. Remove the white plug from the port labeled 2-EXT on the back of the printer.
2. Find the phone cord that connects from the back of your computer (your computer dial-up modem) to a telephone wall jack. Disconnect the cord from the telephone wall jack and plug it into the port labeled 2-EXT on the back of the printer.
3. Connect a phone to the "OUT" port on the back of your computer dial-up modem.
4. Using the phone cord supplied in the box with the printer, connect one end to your telephone wall jack, then connect the other end to the port labeled 1-LINE on the back of the printer.

 **NOTE:** You might need to connect the supplied phone cord to the adapter provided for your country/  
region.

If you do not use the supplied cord to connect from the telephone wall jack to the printer, you might not be able to fax successfully. This special phone cord is different from the phone cords you might already have in your home or office.

5. If your modem software is set to receive faxes to your computer automatically, turn off that setting.

 **NOTE:** If you do not turn off the automatic fax reception setting in your modem software, the printer cannot receive faxes.

6. Turn off the **Auto Answer** setting.
7. Run a fax test.

You must be available to respond in person to incoming fax calls, or the printer cannot receive faxes.

If you encounter problems setting up the printer with optional equipment, contact your local service provider or vendor for further assistance.

## Test fax setup

You can test your fax setup to check the status of the printer and to make sure it is set up correctly for faxing. Perform this test after you have completed setting up the printer for faxing. The test does the following:

- Tests the fax hardware
- Verifies the correct type of phone cord is connected to the printer
- Checks that the phone cord is plugged into the correct port
- Checks for a dial tone
- Checks for an active phone line
- Tests the status of your phone line connection

The printer prints a report with the results of the test. If the test fails, review the report for information on how to fix the problem and rerun the test.

### To test fax setup via the printer control panel

1. Set up the printer for faxing according to your particular home or office setup instructions.
2. Make sure the ink cartridges are installed, and that full-size paper is loaded in the input tray before starting the test.
3. From the printer control panel, touch **Setup**.
4. Touch **Fax Setup**.
5. Touch **Tools**, and then touch **Run Fax Test**.

The printer displays the status of the test on the display and prints a report.

6. Review the report.
  - If the test passes and you are still having problems faxing, check the fax settings listed in the report to verify the settings are correct. A blank or incorrect fax setting can cause problems faxing.
  - If the test fails, review the report for more information on how to fix any problems found.

---

## C Errors (Windows)

- [Low on ink](#)
- [Very low on ink](#)
- [Ink cartridge problem](#)
- [Paper size mismatch](#)
- [Ink cartridge carriage stalled](#)
- [Paper jam or tray problem](#)
- [Out of paper](#)
- [Document failed to print](#)
- [Printer failure](#)
- [Door open](#)
- [Ink cartridge failure](#)
- [Printer supply upgrade problem](#)
- [Counterfeit Cartridge Advisory](#)
- [Use SETUP cartridges](#)
- [Do not use SETUP cartridges](#)
- [Incompatible ink cartridges](#)
- [Problem with Printer Preparation](#)
- [Paper too short](#)
- [Ink cartridge incorrectly installed](#)
- [Problem with SETUP cartridges](#)
- [Problem with printhead](#)
- [Incompatible HP Instant Ink Cartridge](#)
- [Used HP Instant Ink Cartridge](#)
- [Please Connect Printer to HP Connected](#)
- [Cannot Print](#)
- [Output tray closed](#)
- [Paper Jam in Automatic Document Feeder](#)
- [HP Protected Cartridge Installed](#)

### Low on ink

The ink cartridge identified in the message is low on ink.



Ink level warnings and indicators provide estimates for planning purposes only. When you receive a low ink warning message, consider having a replacement cartridge available to avoid possible printing delays. You do not need to replace cartridges until the print quality becomes unacceptable.

For information about replacing ink cartridges, see [Replace the ink cartridges](#). For information about ordering ink cartridges, see [Order ink cartridges](#). For information about recycling used ink supplies, see [HP inkjet supplies recycling program](#).

---

 **NOTE:** Ink from the cartridges is used in the printing process in a number of different ways, including in the initialization process, which prepares the printer and cartridges for printing. In addition, some residual ink is left in the cartridge after it is used. For more information see [www.hp.com/go/inkusage](http://www.hp.com/go/inkusage).

---

## Very low on ink

The ink cartridge identified in the message is very low on ink.

Ink level warnings and indicators provide estimates for planning purposes only. When you receive a very low ink warning message, HP recommends having a replacement cartridge available to avoid possible printing delays. You do not need to replace cartridges until the print quality is unacceptable.

For information about replacing ink cartridges, see [Replace the ink cartridges](#). For information about ordering ink cartridges, see [Order ink cartridges](#). For information about recycling used ink supplies, see [HP inkjet supplies recycling program](#).

---

 **NOTE:** Ink from the cartridges is used in the printing process in a number of different ways, including in the initialization process, which prepares the printer and cartridges for printing. In addition, some residual ink is left in the cartridge after it is used. For more information see [www.hp.com/go/inkusage](http://www.hp.com/go/inkusage).

---

## Ink cartridge problem

The ink cartridge identified in the message is missing, damaged, incompatible, or inserted into the wrong slot in the printer.

---

 **NOTE:** If the cartridge is identified in the message as incompatible, see [Order ink cartridges](#) for information about obtaining cartridges for the printer.

---

To solve this problem, try the following solutions. Solutions are listed in order, with the most likely solution first. If the first solution does not solve the problem, continue trying the remaining solutions until the issue is resolved.

- Solution 1: Turn the printer off and on.
- Solution 2: Install the ink cartridges correctly.

### **Solution 1: Turn the printer off and on**

Turn off the printer, and then turn it on again.

If the problem persists, try the next solution.

### **Solution 2: Install the ink cartridges correctly**

Make sure all of the ink cartridges are properly installed:

1. Make sure the printer is turned on.
2. Open the ink cartridge access door.

---

 **NOTE:** Wait until the print carriage stops moving before proceeding.

---

3. Press the front of the ink cartridge to release it, and then remove it from the slot.
4. Insert the cartridge into the slot. Press firmly on the cartridge to ensure proper contact.
5. Close the ink cartridge access door.

## Paper size mismatch

The paper size or type selected in the printer driver does not match the paper loaded in the printer. Make sure that the correct paper is loaded in the printer, and then print the document again. For more information, see [Load paper](#).



---

**NOTE:** If the paper loaded in the printer is the correct size, change the selected paper size in the printer driver, and then print the document again.

---

## Ink cartridge carriage stalled

Something is blocking the ink cartridge carriage (the part of the printer that holds the ink cartridges).

To clear the obstruction check the printer for jams.

For more information, see [Clear paper jams](#).

## Paper jam or tray problem

Paper has become jammed in the printer.

Before you try to clear the jam, check the following:

- Make sure that you have loaded paper that meets specifications and is not wrinkled, folded, or damaged. For more information, see [Recommended papers for printing](#).
- Make sure that the printer is clean. For more information, see [Maintain the printer](#).
- Make sure that the trays are loaded correctly and are not too full. For more information, see [Load paper](#).

For instructions on clearing jams, as well as more information about how to avoid jams, see [Clear paper jams](#).

## Out of paper

The default tray is empty.

Load more paper, and then touch **OK**.

For more information, see [Load paper](#).



## Document failed to print

The printer could not print the document because a problem occurred in the printing system.

For information about solving printing problems, see [Solve printer problems](#).

## Printer failure

There was a problem with the printer or ink system. Usually, you can resolve such problems by completing the following steps:

1. Press  (the Power button) to turn off the printer.
2. Unplug the power cord, and then plug in the power cord again.
3. Press  (the Power button) to turn on the printer.

If this problem persists, write down the error code provided in the message, and then contact HP support. For more information about contacting HP support, see [HP support](#).

## Door open

Before the printer can print documents, all doors and covers must be closed.

---

 **TIP:** When completely closed, most doors and covers snap into place.

---

If the problem persists after you've securely closed all doors and covers, contact HP support. For more information, see [HP support](#).

## Ink cartridge failure

The cartridges listed in the message are damaged or have failed.

See [Replace the ink cartridges](#).

## Printer supply upgrade problem

The supply upgrade was not successful. The cartridges listed in the message can still be used in this printer. Replace the Supply Upgrade cartridge. For more information, see [Replace the ink cartridges](#).

## Counterfeit Cartridge Advisory

The installed cartridge is not a new, genuine HP cartridge. Contact the store where this cartridge was purchased. To report suspected fraud, visit HP at [www.hp.com/go/anticounterfeit](http://www.hp.com/go/anticounterfeit). To continue using the cartridge, click **Continue**.

## Use SETUP cartridges

When you first setup the printer, you must install the cartridges that shipped in the box with the printer. These cartridges are labeled SETUP, and they calibrate your printer before the first print job. Failure to install the SETUP cartridges during the initial product setup causes an error. If you installed a set of regular cartridges, remove them and install the SETUP cartridges to complete printer setup. After printer setup is complete, the printer can use regular cartridges.

If you still receive error messages and the printer cannot complete ink system initialization, contact HP support. For more information, see [HP support](#).

[Click here to go online for more information](#). At this time, this website might not be available in all languages.

## Do not use SETUP cartridges

SETUP cartridges cannot be used after the printer has been initialized. Remove and install non-SETUP cartridges. For more information, see [Replace the ink cartridges](#).

## Incompatible ink cartridges

The ink cartridge is not compatible with your printer.

Solution: Remove this cartridge immediately and replace with a compatible ink cartridge. For information about how to install new cartridges, see [Replace the ink cartridges](#).

## Problem with Printer Preparation

The printer clock has failed and ink preparation may not be complete. The estimated Ink Level gauge might be inaccurate.

Solution: Check the print quality of your print job. If it is not satisfactory, running the printhead cleaning procedure from the toolbox might improve it.

## Paper too short

The paper loaded is shorter than the minimum requirement. Paper that meets the printer requirements must be loaded. For more information, see [Recommended papers for printing](#) and [Load paper](#).

## Ink cartridge incorrectly installed

The ink cartridge indicated in the message is not installed correctly.

Make sure all of the ink cartridges are properly installed:

1. Make sure the printer is turned on.
2. Open the ink cartridge access door.



---

**NOTE:** Wait until the print carriage stops moving before proceeding.

---

3. Press the front of the ink cartridge to release it, and then remove it from the slot.
4. Insert the cartridge into the slot. Press firmly on the cartridge to ensure proper contact.
5. Close the ink cartridge access door.

## Problem with SETUP cartridges

There is a problem with the SETUP cartridges and the printer cannot complete ink system initialization. Please contact [HP support](#).

## Problem with printhead

There is a problem with the printhead.

Turn off the printer, and then turn it on again.

If the problem persists, contact HP support for service. For more information, see [HP support](#).

## Incompatible HP Instant Ink Cartridge

This cartridge can only be used in a printer that is currently enrolled in HP Instant Ink.

If you believe your printer should accept this cartridge, please contact [www.hp.com/buy/supplies](http://www.hp.com/buy/supplies).

## Used HP Instant Ink Cartridge

The HP Instant Ink cartridge(s) listed on the printer control panel display can only be used in the HP Instant Ink printer that initially installed the cartridge. The cartridge must be replaced.

For information about replacing ink cartridges, see [Replace the ink cartridges](#). For information about ordering ink cartridges, see [Order ink cartridges](#). For information about recycling used ink supplies, see [HP inkjet supplies recycling program](#).

## Please Connect Printer to HP Connected

The printer must be connected to HP Connected, otherwise you will be unable to print soon without further warning. See the printer control panel for instructions on connecting.

## Cannot Print

The printer needs to be connected to HP Connected to update its Instant Ink status.

You will be unable to print until the printer has been connected to update the Instant Ink status. See the printer control panel for instructions on connecting.

## Output tray closed

Open the output tray to continue printing.

## Paper Jam in Automatic Document Feeder

Clear a paper jam in the document feeder. For more information, see [Clear paper jams](#).

## HP Protected Cartridge Installed

The ink cartridge listed on the printer control panel can only be used in the printer that initially protected the cartridge using the HP Cartridge Protection feature. The ink cartridge must be replaced in this printer.

For information about how to install a new ink cartridge, see [Replace the ink cartridges](#).

---

# Index

- A**
  - accessibility 2
  - accessories
    - printer status report 83
  - acoustic emissions 124
  - ADSL, fax setup with
    - parallel phone systems 144
  - after the support period 82
  - align printhead 111
  - answer ring pattern
    - change 55
    - parallel phone systems 145
  - answering machine
    - fax tones recorded 103
    - set up with fax (parallel phone systems) 155
    - set up with fax and modem 157
  - automatic fax reduction 48
- B**
  - backup fax 46
  - baud rate 56
  - black and white pages
    - fax 41
  - blank pages, troubleshoot
    - copy 92
  - blocked fax numbers
    - set up 48
  - both sides, print on 27
  - broadcast faxing
    - send 44
  - buttons, control panel 6
- C**
  - carriage
    - clear carriage jams 119
  - cartridges 67
  - clean
    - document feeder 109
    - exterior 109
    - printhead 111
    - scanner glass 108
  - clear
    - fax logs 60
  - colored text, and OCR 38
  - computer modem
    - shared with fax (parallel phone systems) 149
    - shared with fax and answering machine (parallel phone systems) 157
    - shared with fax and voice line (parallel phone systems) 152
    - shared with fax and voice mail (parallel phone systems) 161
  - confirmation reports, fax 58
  - connectors, locating 5
  - control panel
    - buttons 6
    - lights 6
    - status icons 6
  - Copy 6
  - copy
    - quality 92
    - specifications 123
    - troubleshoot 92
  - correct port test, fax 97
  - customer support
    - electronic 81
- D**
  - diagnostic page 86
  - dial tone test, failure 99
  - dial type, setting 55
  - dial-up modem
    - shared with fax (parallel phone systems) 149
    - shared with fax and answering machine (parallel phone systems) 157
    - shared with fax and voice line (parallel phone systems) 152
    - shared with fax and voice mail (parallel phone systems) 161
  - distinctive ringing
    - change 55
    - parallel phone systems 145
  - document feeder
    - clean 109
  - feeding problems, troubleshoot 109
  - load originals 17
  - double-sided printing 27
  - DSL, fax setup with
    - parallel phone systems 144
- E**
  - ECM. *See* error correction mode
  - edit
    - text in OCR program 38
  - embedded web server
    - about 77
    - opening 78
    - troubleshoot, cannot be opened 79
    - Webscan 37
  - environmental specifications 121
  - environmental sustainability program 134
  - error correction mode 45
  - error reports, fax 59
  - EWS. *See* embedded web server
- F**
  - fax
    - answer mode 54
    - answering machine and modem, shared with (parallel phone systems) 157
    - answering machine
      - troubleshoot 103
    - answering machine, set up (parallel phone systems) 155
    - auto answer 54
    - backup fax 46
    - blocking numbers 48
    - confirmation reports 58
    - dial tone test, failed 99
    - dial type, setting 55
    - distinctive ringing setup (parallel phone systems) 145
    - distinctive ringing, change pattern 55

- DSL, set up (parallel phone systems) 144
- error correction mode 45
- error reports 59
- forwarding 47
- header 53
- Internet Protocol, over 57
- ISDN line, set up (parallel phone systems) 145
- line condition test, failed 99
- log, clear 60
- log, print 59
- manual receive 46
- modem and answering machine, shared with (parallel phone systems) 157
- modem and voice line, shared with (parallel phone systems) 152
- modem and voice mail, shared with (parallel phone systems) 161
- modem, shared with (parallel phone systems) 149
- monitor dialing 43, 44
- parallel phone systems 140
- PBX system, set up (parallel phone systems) 145
- phone cord connection test, failed 97
- phone cord too short 104
- phone cord type test, failed 98
- print last transaction details 60
- receive 45
- receive, troubleshoot 100, 102
- redial options 56
- reduction 48
- reports 58
- reprint 47
- rings to answer 54
- send 41
- send, troubleshoot 100, 103
- separate line setup (parallel phone systems) 143
- settings, change 53
- setup types 141
- shared phone line setup (parallel phone systems) 147
- sound volume 57
- specifications 123

- speed 56
- test failed 96
- test setup 163
- troubleshoot 96
- voice mail, set up (parallel phone systems) 148
- wall jack test, failed 97
- Fax screen 7
- firewalls, troubleshoot 90
- FoIP 57
- forwarding faxes 47

**G**

- glass, scanner
  - clean 108
  - load originals 16
  - locating 4
- grainy or white bands on copies, troubleshoot 93

**H**

- hardware, fax setup test 96
- header, fax 53
- Help button 7
- HP Utility (OS X)
  - opening 77
- humidity specifications 121

**I**

- ink cartridge access door, locating 5
- ink cartridges 5
  - check ink levels 65
  - locating 5
  - part numbers 67, 83
  - replace 66
  - status 83
  - tips 65
  - warranty expiration dates 83
- ink level icons 7
- ink levels, check 65
- Internet Protocol
  - fax, using 57
- IP address
  - checking for printer 79
- IP settings 73
- ISDN line, set up with fax
  - parallel phone systems 145

**J**

- jams
  - clear 111

- paper 118
- paper to avoid 10
- junk fax mode 48

**L**

- lights, control panel 6
- line condition test, fax 99
- lines
  - copies, troubleshoot 92
  - scans, troubleshoot 95
- link speed, setting 73
- log, fax
  - print 59

**M**

- Mac OS 22
- maintain
  - page smear 111
  - printhead 111
- maintenance
  - align printhead 111
  - check ink levels 65
  - clean 109
  - clean printhead 111
  - diagnostic page 86
  - printhead 111
  - replace ink cartridges 66
- manual faxing
  - receive 46
  - send 43
- margins
  - setting, specifications 122
- media
  - duplexing 27
- memory
  - reprint faxes 47
  - save faxes 46
- missing or incorrect information, troubleshoot 90
- model number 83
- modem
  - shared with fax (parallel phone systems) 149
  - shared with fax and answering machine (parallel phone systems) 157
  - shared with fax and voice line (parallel phone systems) 152
  - shared with fax and voice mail (parallel phone systems) 161

monitor dialing 43, 44  
multi-feeds, troubleshoot 89

## N

networks  
connector illustration 5  
firewalls, troubleshoot 90  
IP settings 73  
link speed 73  
settings, change 73  
solve problems 105  
view and print settings 73  
wireless communication setup  
70  
wireless settings 84  
noise information 124

## O

OCR  
edit scanned documents 38  
troubleshoot 94  
operating systems supported 121  
OS X  
HP Utility 77  
output tray  
locating 4

## P

paper  
clear jams 111  
HP, order 10  
jams 118  
load tray 11  
selecting 10  
skewed pages 89  
specifications 122  
troubleshoot feeding 89  
paper-feed problems, troubleshoot  
89  
parallel phone systems  
answering machine setup 155  
countries/regions with 140  
distinctive ringing setup 145  
DSL setup 144  
ISDN setup 145  
modem and answering machine  
setup 157  
modem and voice mail setup  
161  
modem setup 149

modem shared with voice line  
setup 152  
PBX setup 145  
separate line setup 143  
setup types 141  
shared line setup 147  
PBX system, set up with fax  
parallel phone systems 145  
phone book  
change contact 51  
change group contacts 52  
delete contacts 53  
print list 53  
send fax 41  
set up 51  
set up group contacts 52  
phone cord  
connected to correct port test  
failed 97  
correct type test failed 98  
extend 104  
phone line, answer ring pattern 55  
phone support 81  
phone support period  
period for support 82  
phone, fax from  
receive 46  
send, 43  
Photo button 7  
photos  
insert USB flash drive 18  
power  
troubleshoot 88  
power input, locating 5  
print  
diagnostic page 86  
double-sided 27  
fax logs 59  
fax reports 58  
faxes 47  
last fax details 60  
printer status report 83  
troubleshoot 88  
Print brochures  
print 22  
print quality  
clean page smear 111  
print quality report 86  
printer control panel  
locating 4

network settings 73  
send faxes 42  
printer software (Windows)  
about 77  
opening 19, 77  
printer status report  
information on 83  
print 83  
printhead 111  
clean 111  
printhead, align 111  
pulse dialing 55

## Q

quality, troubleshoot  
copy 92  
scan 95

## R

radio interference  
regulatory information 132  
rear access panel  
illustration 5  
receive faxes  
auto answer mode 54  
automatically 45  
blocking numbers 48  
forwarding 47  
manually 46  
rings to answer 54  
troubleshoot 100, 102  
recycle  
ink cartridges 135  
redial options, setting 56  
reduce fax 48  
regulatory information 124, 132  
regulatory model number 125  
replace ink cartridges 66  
reports  
confirmation, fax 58  
diagnostic 86  
error, fax 59  
fax test failed 96  
web access 88  
wireless test 88  
reprint  
faxes from memory 47  
rings to answer 54



**S**

save  
 faxes in memory 46

scan  
 from Webscan 37  
 OCR 38  
 quality 95  
 Scan screen 7  
 scan specifications 123  
 slow 93  
 troubleshoot 93

Scan screen 7

scanner glass  
 clean 108  
 load originals 16  
 locating 4

send faxes  
 basic fax 41  
 from a phone 43  
 memory, from 44  
 monitor dialing 43, 44  
 troubleshoot 100, 103

send scans  
 for OCR 38  
 troubleshoot 93

serial number 83

serial phone systems  
 countries/regions with 140  
 setup types 141

settings  
 network 73  
 speed, fax 56  
 volume, fax 57

setup  
 answering machine (parallel phone systems) 155  
 answering machine and modem (parallel phone systems) 157  
 computer modem (parallel phone systems) 149  
 computer modem and answering machine (parallel phone systems) 157  
 computer modem and voice line (parallel phone systems) 152  
 computer modem and voice mail (parallel phone systems) 161  
 distinctive ringing 55  
 distinctive ringing (parallel phone systems) 145

DSL (parallel phone systems) 144

fax scenarios 141  
 fax, with parallel phone systems 140  
 ISDN line (parallel phone systems) 145  
 PBX system (parallel phone systems) 145  
 separate fax line (parallel phone systems) 143  
 shared phone line (parallel phone systems) 147  
 test fax 163  
 voice mail (parallel phone systems) 148  
 voice mail and computer modem (parallel phone systems) 161

Setup button 7

size

scans, troubleshoot 95  
 troubleshoot copy 92

skew, troubleshoot

copy 92  
 print 89  
 scan 95

software

OCR 38  
 Webscan 37

sound pressure 124

specifications

acoustic emissions 124  
 paper 122  
 physical 121  
 system requirements 121

speed

troubleshoot for scanner 93

status

network configuration page 84  
 printer status report 83

status icons 6

stripes on scans, troubleshoot 95

subscriber identification code 53

supplies

printer status report 83

support 80

support process 81

system requirements 121

**T**

technical information

copy specifications 123  
 fax specifications 123  
 scan specifications 123

telephone line, answer ring pattern 55

telephone wall jack, fax 97

telephone, fax from

receive 46  
 send 43

temperature specifications 121

tests, fax

dial tone, failed 99  
 failed 96  
 fax line condition 99  
 fax phone cord type test failed 98  
 hardware, failed 96  
 port connection, failed 97  
 setup 163  
 telephone wall jack 97

text

cannot be edited after scan, troubleshoot 94  
 missing from scan, troubleshoot 93

tone dialing 55

trays

clear paper jams 111  
 load paper 11  
 locating 4  
 paper-width guides illustration 4

troubleshoot feeding 89

troubleshoot

answering machines 103  
 control panel help system 82  
 copy 92  
 copy quality 92  
 embedded web server 79  
 fax 96  
 fax dial tone test failed 99  
 fax hardware test failed 96  
 fax line test failed 99  
 fax phone cord connection test failed 97  
 fax phone cord type test failed 98  
 fax tests 96

- fax wall jack test, failed 97
- firewalls 90
- jams, paper 118
- missing or incorrect information 90
- multiple pages are picked 89
- network configuration page 84
- nothing prints 89
- paper not picked up from tray 89
- paper-feed problems 89
- power 88
- print 88
- printer status report 83
- printing problem 89
- receive faxes 100, 102
- scan 93
- scan quality 95
- send faxes 100, 103
- skewed copies 92
- skewed pages 89
- troubleshooting
  - solve network problems 105
- two-sided printing 27

## U

- USB connection
  - port, locating 4, 5
- USB flash drive
  - insert 18

## V

- view
  - network settings 73
- voice mail
  - set up with fax (parallel phone systems) 148
  - set up with fax and computer modem (parallel phone systems) 161
- volume
  - fax sounds 57

## W

- wall jack test, fax 97
- web access report 88
- Webscan 37
- websites
  - accessibility information 2
  - customer support 81
  - environmental programs 134

- white bands or stripes, troubleshoot
  - copies 93
  - scans 95
- Windows
  - print brochures 21
  - system requirements 121
- wireless communication
  - regulatory information 132
  - set up 70
- wireless connection icons 7
- wireless test report 88