

User Guide



HP OfficeJet 6950



HP OfficeJet 6950 All-in-One series

User Guide

Copyright information

© Copyright 2018 HP Development Company, L.P.

HP Company notices

The information contained in this document is subject to change without notice.

All rights reserved. Reproduction, adaptation, or translation of this material is prohibited without prior written permission of HP, except as allowed under copyright laws.

The only warranties for HP products and services are set forth in the express warranty statements accompanying such products and services. Nothing herein should be construed as constituting an additional warranty. HP shall not be liable for technical or editorial errors or omissions contained herein.

Acknowledgements

Microsoft and Windows are either registered trademarks or trademarks of Microsoft Corporation in the United States and/or other countries.

ENERGY STAR and the ENERGY STAR mark are registered trademarks owned by the U.S. Environmental Protection Agency.

Mac, OS X, and AirPrint are trademarks of Apple Inc., registered in the U.S. and other countries.

Safety information



Always follow basic safety precautions when using this product to reduce risk of injury from fire or electric shock.

- Read and understand all instructions in the documentation that comes with the printer.
- Observe all warnings and instructions marked on the product.
- Unplug this product from wall outlets before cleaning.
- Do not install or use this product near water, or when you are wet.
- Install the product securely on a stable surface.
- Install the product in a protected location where no one can step on or trip over the line cord, and the line cord cannot be damaged.
- If the product does not operate normally, see [Solve a problem](#).
- There are no user-serviceable parts inside. Refer servicing to qualified service personnel.

Table of contents

1 How do I?	1
2 Get started	2
Accessibility	2
HP EcoSolutions (HP and the Environment)	2
Manage power	3
Quiet Mode	4
Optimize Printing Supplies	5
Understand the printer parts	5
Top and front view	6
Printing supplies area	7
Back view	7
Use the printer control panel	7
Overview of buttons and lights	8
Control panel display icons	8
Change printer settings	9
Paper basics	10
Recommended papers for printing	10
Order HP paper supplies	12
Tips for selecting and using paper	12
Load paper	12
Load an original on the scanner glass	17
Load an original in the document feeder	17
Update the printer	18
Open the HP printer software (Windows)	19
Turn the printer off	19
3 Print	20
Print documents	20
Print brochures	21
Print on envelopes	22
Print photos	23
Print on special and custom-size paper	24
Print on both sides (duplexing)	25
Print with mobile devices	26
Print from mobile devices	26

Access printer features and troubleshooting information from mobile devices	27
Tips for successful printing	27
4 Copy and scan	30
Copy	30
Scan	30
Scan to a computer	31
Scan to email	32
Scan documents as editable text	32
Scan documents as editable text	32
Guidelines for scanning documents as editable text	33
Scan using Webscan	34
Create a new scan shortcut (Windows)	35
Change scan settings (Windows)	35
Tips for copy and scan success	36
5 Fax	37
Send a fax	37
Send a standard fax	37
Send a standard fax from the computer	38
Send a fax from a phone	39
Send a fax using monitor dialing	39
Send a fax using printer memory	40
Send a fax to multiple recipients	40
Send a fax in Error Correction Mode	41
Receive a fax	41
Receive a fax manually	42
Set up backup fax	42
Reprint received faxes from memory	43
Forward faxes to another number	43
Set automatic reduction for incoming faxes	44
Block unwanted fax numbers	44
Receive faxes using HP Digital Fax	45
Set up phone book contacts	46
Create and edit a phone book contact	46
Create and edit a group phone book contact	47
Delete phone book contacts	48
Print a list of phone book contacts	48
Change fax settings	48
Configure the fax header	49
Set the answer mode (Auto answer)	49

Set the number of rings before answering	49
Change the answer ring pattern for distinctive ring	50
Set the dial type	50
Set the redial options	51
Set the fax speed	51
Set the fax sound volume	52
Fax and digital phone services	52
Fax on Voice over Internet Protocol	52
Use reports	53
Print fax confirmation reports	53
Print fax error reports	54
Print and view the fax log	54
Clear the fax log	55
Print the details of the last fax transaction	55
Print a Caller ID Report	55
View the Call History	55
Additional fax setup	56
Set up faxing (parallel phone systems)	56
Select the correct fax setup for your home or office	57
Case A: Separate fax line (no voice calls received)	59
Case B: Set up the printer with DSL	60
Case C: Set up the printer with a PBX phone system or an ISDN line	60
Case D: Fax with a distinctive ring service on the same line	61
Case E: Shared voice/fax line	62
Case F: Shared voice/fax line with voice mail	63
Case G: Fax line shared with computer modem (no voice calls received)	64
Set up the printer with a computer dial-up modem	64
Set up the printer with a computer DSL/ADSL modem	65
Case H: Shared voice/fax line with computer modem	66
Shared voice/fax with computer dial-up modem	66
Shared voice/fax with computer DSL/ADSL modem	68
Case I: Shared voice/fax line with answering machine	69
Case J: Shared voice/fax line with computer modem and answering machine	70
Shared voice/fax line with computer dial-up modem and answering machine	71
Shared voice/fax line with computer DSL/ADSL modem and answering machine	72
Case K: Shared voice/fax line with computer dial-up modem and voice mail	74
Test fax setup	75

6 Web Services	77
What are Web Services?	77
Set up Web Services	77
Print with HP ePrint	78
Remove Web Services	79
7 Work with cartridges	80
Information on cartridges and the printhead	80
Check the estimated ink levels	81
Replace the cartridges	81
Order cartridges	83
Store printing supplies	83
Anonymous usage information storage	84
Ink cartridge warranty information	84
8 Network setup	86
Set up the printer for wireless communication	86
Before you begin	86
Set up the printer on your wireless network	87
Change the connection type	87
Test the wireless connection	88
Turn on or off the wireless capability of the printer	88
Change network settings	88
Use Wi-Fi Direct	89
9 Printer management tools	93
Toolbox (Windows)	93
HP Utility (OS X)	93
Embedded web server	93
About cookies	94
Open the embedded web server	94
Embedded web server cannot be opened	95
10 Solve a problem	96
Jams and paper-feed issues	96
Clear a paper jam	96
Read general instructions in the Help for clearing paper jams	96
Clear a print carriage jam	101
Read general instructions in the Help for clearing a print carriage jams	101
Learn how to avoid paper jams	102

Solve paper-feed problems	102
Printing issues	103
Fix problems with page not printing (unable to print)	103
Read general instructions in the Help for unable to print issues	103
Fix print quality issues	107
Read general instructions in the Help for resolving print quality issues	107
Copy issues	111
Scan issues	111
Fax issues	111
Run the fax test	112
What to do if the fax test failed	112
Troubleshoot fax problems	116
Read general instructions in the Help for specific fax problems	116
The display always shows Phone Off Hook	116
The printer is having problems sending and receiving faxes	116
The printer cannot receive faxes, but can send faxes	118
The printer cannot send faxes, but can receive faxes	119
Fax tones are recorded on my answering machine	119
The computer cannot receive faxes (HP Digital Fax)	119
Network and connection issues	119
Fix wireless connection	120
Find network settings for wireless connection	120
Fix Wi-Fi Direct connection	120
Printer hardware issues	121
Get help from the printer control panel	122
Understand printer reports	122
Printer status report	122
Network configuration page	123
Print quality report	123
Wireless test report	123
Web access test report	123
Solve problems using Web Services	123
Maintain the printer	124
Clean the scanner glass	124
Clean the exterior	125
Clean the document feeder	125
Maintain the printhead and cartridges	126
Restore original factory defaults and settings	127
HP support	127

Appendix A Technical information	129
Specifications	129
Regulatory information	131
Regulatory model identification number	132
FCC statement	132
Notice to users in Korea	133
VCCI (Class B) compliance statement for users in Japan	133
Notice to users in Japan about the power cord	133
Noise emission statement for Germany	133
Visual display workplaces statement for Germany	133
Notice to users of the U.S. telephone network: FCC requirements	134
Notice to users of the Canadian telephone network	135
Notice to users of the German telephone network	136
Australia wired fax statement	136
European Union Regulatory Notice	136
Products with external AC Adapters	136
Products with wireless functionality	136
European telephone network declaration (Modem/Fax)	137
Declaration of conformity	138
Regulatory information for wireless products	139
Exposure to radio frequency radiation	139
Notice to users in Brazil	139
Notice to users in Canada	140
Notice to users in Taiwan	140
Notice to users in Mexico	141
Notice to users in Japan	141
Notice to users in Korea	141
Environmental product stewardship program	141
Eco-Tips	142
European Union Commission Regulation 1275/2008	142
Paper	142
Plastics	142
Material safety data sheets	142
Recycling program	142
HP inkjet supplies recycling program	143
Power consumption	143
Disposal of waste equipment by users	143
Chemical substances	143
Restriction of hazardous substance (Ukraine)	143
Restriction of hazardous substance (India)	144
Restriction on hazardous substances statement (Turkey)	144

China SEPA Eco Label User Information	144
China Energy Label for Printer, Fax and Copier	145
Declaration of the Presence Condition of the Restricted Substances Marking (Taiwan)	146
The Table of Hazardous Substances/Elements and their Content (China)	147
EPEAT	147
Battery disposal in Taiwan	147
California Perchlorate Material Notice	148
EU Battery Directive	149
Battery notice for Brazil	150

Index	157
--------------------	------------

1 How do I?

- [Get started](#)
- [Print](#)
- [Copy and scan](#)
- [Fax](#)
- [Web Services](#)
- [Work with cartridges](#)
- [Network setup](#)
- [Solve a problem](#)

2 Get started

This guide provides details about how to use the printer and how to resolve problems.

- [Accessibility](#)
- [HP EcoSolutions \(HP and the Environment\)](#)
- [Understand the printer parts](#)
- [Use the printer control panel](#)
- [Paper basics](#)
- [Load paper](#)
- [Load an original on the scanner glass](#)
- [Load an original in the document feeder](#)
- [Update the printer](#)
- [Open the HP printer software \(Windows\)](#)
- [Turn the printer off](#)

Accessibility

The printer provides a number of features that make it accessible for people with disabilities.

Visual

The HP software is accessible for users with visual impairments or low vision by using your operating system's accessibility options and features. The software also supports most assistive technology such as screen readers, Braille readers, and voice-to-text applications. For users who are color blind, colored buttons and tabs used in the HP software have simple text or icon labels that convey the appropriate action.

Mobility

For users with mobility impairments, the HP software functions can be executed through keyboard commands. The HP software also supports Windows accessibility options such as StickyKeys, ToggleKeys, FilterKeys, and MouseKeys. The printer doors, buttons, paper trays, and paper-width guides can be operated by users with limited strength and reach.

Support

For more information about accessibility solutions for HP products, visit the HP Accessibility and Aging website (www.hp.com/accessibility).

For accessibility information for OS X, visit the Apple website at www.apple.com/accessibility.

HP EcoSolutions (HP and the Environment)

HP is committed to helping you optimize your environmental footprint and empowering you to print responsibly—at home or in the office.

For more detailed information about environmental guidelines that HP follows during the manufacturing process, see [Environmental product stewardship program](#). For more information about HP's environmental initiatives, visit www.hp.com/ecosolutions.

- [Manage power](#)
- [Quiet Mode](#)
- [Optimize Printing Supplies](#)



Manage power

Use **Sleep Mode**, **Auto-off** and **Schedule Printer On/Off** to conserve electricity.

Sleep mode

Power usage is reduced while in Sleep mode. After initial setup of printer, the printer will enter Sleep mode after five minutes of inactivity.

Use the following instructions to change the period of inactivity before the printer sleeps.

1. On the printer control panel display, from the Home screen, swipe left to see  (**Setup**), and then touch  (**Setup**).



NOTE: If you do not see the Home screen, touch  (Home).

2. Touch **Power Management**, touch **Sleep Mode**, and then touch the desired option.

Auto-off

This feature turns the printer off after 8 hours of inactivity to help reduce energy use. Auto-Off turns the printer off completely, so you must use the Power button to turn the printer back on.



If your printer supports this energy saving feature, Auto-Off is automatically enabled or disabled depending on printer capabilities and connection options. Even when Auto-Off is disabled, the printer enters Sleep mode after 5 minutes of inactivity to help reduce energy use.

- Auto-Off is enabled when the printer is turned on, if the printer does not have network, fax or Wi-Fi Direct capability, or is not using these capabilities.
- Auto-Off is disabled when a printer's wireless or Wi-Fi Direct capability is turned on or when a printer with fax, USB, or Ethernet network capability establishes a fax, USB, or Ethernet network connection.

Schedule On and Off

Use this feature to automatically turn the printer on or off on selected days. For example, you can schedule the printer to turn on at 8 a.m. and turn off at 8 p.m. from Monday to Friday. In this way, you save energy during the night and weekends.

Use the following instructions to schedule the day and time for On and Off.

1. On the printer control panel display, from the Home screen, swipe left to see  (**Setup**), and then touch  (**Setup**).



NOTE: If you do not see the Home screen, touch  (Home).

2. Touch **Schedule Printer On/Off**.
3. Touch **Off** next to **Schedule On** or **Schedule Off** to turn the feature on, and then follow the onscreen instructions to set the day and time to turn on or turn off the printer.



CAUTION: Always turn the printer off properly, using either **Schedule Off** or  (the Power button) located on the front left side of the printer.

If you improperly turn the printer off, the print carriage might not return to the correct position, causing problems with the cartridges and print quality issues.

Never turn off the printer when cartridges are missing. HP recommends that you replace any missing cartridges as soon as possible to avoid print quality issues, possible extra ink usage from the remaining cartridges, or damage to the ink system.

Quiet Mode

Quiet Mode slows down printing to reduce overall noise without affecting print quality. It only works when printing on plain paper. Additionally, Quiet Mode is disabled if you are printing using the best or presentation print quality. To reduce printing noise, turn on Quiet Mode. To print at normal speed, turn Quiet Mode off. Quiet Mode is off by default.



NOTE: Quiet Mode does not work if you print photos or envelopes.

You can create a schedule by selecting the time when the printer prints in Quiet Mode. For example, you can schedule the printer to be in Quiet Mode from 10 p.m. to 8 a.m. everyday.

To turn Quiet Mode on or off from the printer control panel

1. From the Home screen, touch **Setup**.
2. Touch **Preferences**.
3. Touch **Quiet Mode**.
4. Touch **On** or **Off** next to **Quiet Mode**.

To turn Quiet Mode on or off from the printer software (Windows)

1. Open the HP printer software. For more information, see [Open the HP printer software \(Windows\)](#).
2. Click **Quiet Mode**.
3. Select **On** or **Off**.
4. Click **Save Setting**.

To turn Quiet Mode on or off from the printer software (OS X)

1. Open HP Utility. For more information, see [HP Utility \(OS X\)](#).
2. Select the printer.
3. Click **Quiet Mode**.
4. Select **On** or **Off**.
5. Click **Apply Now**.

To turn Quiet Mode on or off from the Embedded Web Server (EWS)

1. Open the EWS. For more information, see [Open the embedded web server](#).
2. Click the **Settings** tab.
3. In the **Preferences** section, select **Quiet Mode**, and then select **On** or **Off**.
4. Click **Apply**.

To turn on Quiet Mode while the printer is printing

- ▲ On the printer control panel display, from the printing screen, touch  (Quiet Mode) to turn on Quiet Mode.



NOTE: Quiet Mode is turned on only after the current page is printed and is only used for the current print job.

To create a schedule for Quiet Mode from the printer control panel

1. From the Home screen, touch **Setup**.
2. Touch **Preferences**.
3. Touch **Quiet Mode**.
4. Touch **Off** next to **Quiet Mode** to turn it on, and then touch **OK** to confirm.
5. Touch **Off** next to **Schedule**, and then change start time and end time of the schedule.

Optimize Printing Supplies

To optimize printing supplies such as ink and paper, try the following:

- Recycle used original HP ink cartridges through HP Planet Partners. For more information, visit www.hp.com/recycle.
- Optimize paper usage by printing on both sides of the paper.
- Change the print quality in the printer driver to a draft setting. The draft setting uses less ink.
- Do not clean the printhead unnecessarily. Doing so wastes ink and shortens the life of the cartridges.

Understand the printer parts

This section contains the following topics:

- [Top and front view](#)
- [Printing supplies area](#)
- [Back view](#)

Top and front view

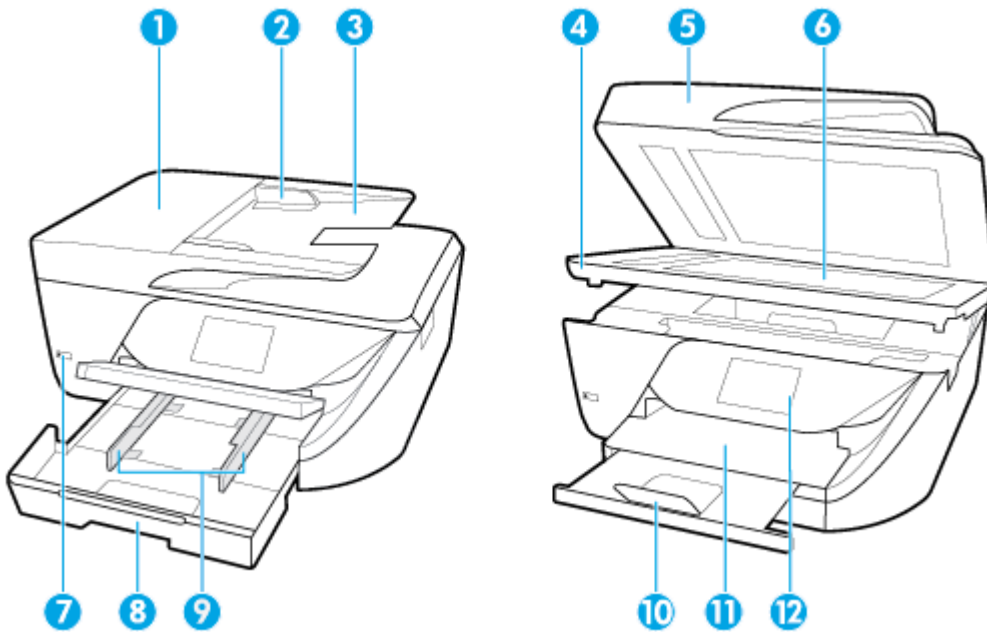

- | | |
|----|---|
| 1 | Document feeder |
| 2 | Document feeder paper-width guides |
| 3 | Document feeder tray |
| 4 | Cartridge access door |
| 5 | Scanner lid |
| 6 | Scanner glass |
| 7 | Power button |
| 8 | Input tray (also referred to as the paper tray) |
| 9 | Paper-width guides |
| 10 | Output tray extender |
| 11 | Output tray |
| 12 | Control panel |

Printing supplies area



- | | |
|---|-----------------------|
| 1 | Cartridges |
| 2 | Print carriage |
| 3 | Cartridge access door |

 **NOTE:** Cartridges should be kept in the printer to prevent possible print quality issues or printhead damage. Avoid removing supplies for extended periods of time. Do not turn the printer off when a cartridge is missing.

Back view

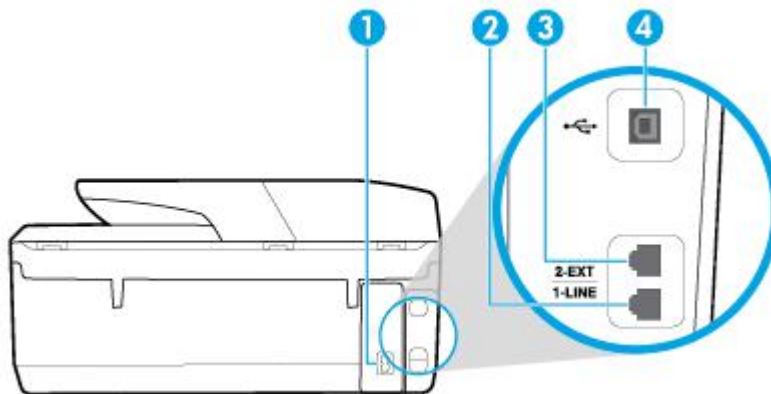

- | | |
|---|--------------------------------------|
| 1 | Power input |
| 2 | Fax port (1-LINE) |
| 3 | Fax port (2-EXT) |
| 4 | Rear universal serial bus (USB) port |

Use the printer control panel

This section contains the following topics:

- [Overview of buttons and lights](#)
- [Control panel display icons](#)
- [Change printer settings](#)

Overview of buttons and lights



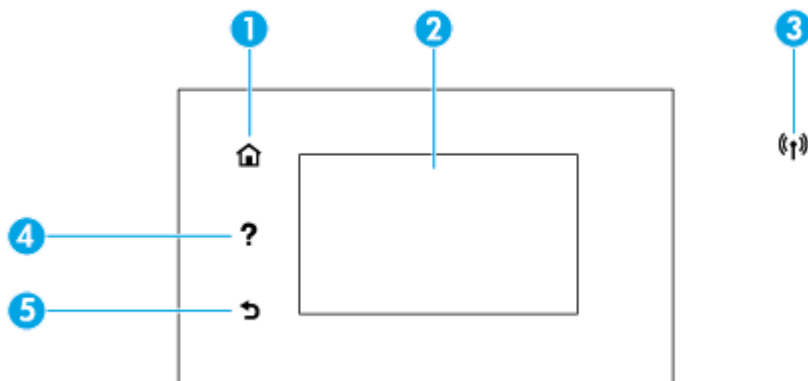





The following diagram and related table provide a quick reference to the printer control panel features.



Label	Name and Description
1	Home button: Returns to the home screen from any other screen.
2	Control panel display: Touch the screen to select menu options, or scroll through the menu items. For information about the icons that appear on the display, see Control panel display icons .
3	Wireless light: Indicates the status of the printer's wireless connection. <ul style="list-style-type: none">• Solid blue light indicates that wireless connection has been established and you can print.• Blinking light indicates wireless error. Refer to the message on the printer display.• If the wireless light is off, wireless is turned off.
4	Help button: Opens the Help menu when on the Home screen, or shows contextual help content if it is available for the current operation when on other screens.
5	Back button: Returns to the previous menu.

Control panel display icons

Icon	Purpose
	Copy: Copy a document or ID card.

Icon	Purpose
	Scan: Scan a document or photo to a computer.
	Fax: Set up fax, send fax, or reprint received fax.
	Setup: Opens the Setup menu where you can change preferences and use tools to perform maintenance functions.
	Help: Opens the Help menu where you can view How To videos, printer feature information, and tips.
	HP ePrint: Displays the Web Services Summary menu, where you can check ePrint status details, change ePrint settings, or view the printer email address. For more information, see Print with HP ePrint .
	Wi-Fi Direct : Displays the status, name, and password for Wi-Fi Direct, and the number of devices connected. You can also change settings and print a guide.
	Wireless: Displays wireless status and menu options. For more information, see Set up the printer for wireless communication .
	Ink: Displays the estimated ink levels. NOTE: Ink level alerts and indicators provide estimates for planning purposes only. When you receive a low-ink alert, consider having a replacement cartridge available to avoid possible printing delays. You do not have to replace the cartridges until prompted to do so.

Change printer settings

Use the control panel to change the printer function and settings, print reports, or get help for the printer.



 **TIP:** If the printer is connected to a computer, you can also change the printer settings using the printer management tools in computer.

For more information about these tools, see [Printer management tools](#).

To change settings for a function



The Home screen of the control panel display shows the available functions for the printer.



1. From the control panel display, on the Home screen, touch the icon of the function that you want to change settings for.
2. After selecting a function, touch  (**Settings**), scroll through the available settings, and then touch the setting you want to change.
3. Follow the prompts on the control panel display to change the settings.

 **TIP:** Touch  (Home) to return to the Home screen.

To change the printer settings

To change the printer settings or print reports, use the options available on the **Setup** menu.

1. From the control panel display, on the Home screen, swipe left to see  (**Setup**), and then touch  (**Setup**).
2. Swipe up and down the screen to see the available options.
3. Touch the option that you want to change settings for.

 **TIP:** Touch  (Home) to return to the Home screen.

Paper basics

The printer is designed to work well with most types of office paper. It is best to test a variety of print paper types before buying large quantities. Use HP paper for optimum print quality. Visit the HP website at www.hp.com for more information about HP paper.



HP recommends plain papers with the ColorLok logo for printing everyday documents. All papers with the ColorLok logo are independently tested to meet high standards of reliability and print quality, and produce documents with crisp, vivid color, bolder blacks, and that dry faster than ordinary plain papers. Look for papers with the ColorLok logo in a variety of weights and sizes from major paper manufacturers.

This section contains the following topics:

- [Recommended papers for printing](#)
- [Order HP paper supplies](#)
- [Tips for selecting and using paper](#)

Recommended papers for printing

If you want the best print quality, HP recommends using HP papers that are specifically designed for the type of project you are printing.

Depending on your country/region, some of these papers might not be available.

Photo printing

- **HP Premium Plus Photo Paper**

HP Premium Plus Photo Paper is HP's highest-quality photo paper for your best photos. With HP Premium Plus Photo Paper, you can print beautiful photos that are instant-dry so you can share them right off the printer. The printer supports several sizes, including A4, 8.5 x 11 inches, 4 x 6 inches (10 x 15 cm), and 5 x 7 inches (13 x 18 cm) in two finishes - glossy or soft gloss (semi-gloss). Ideal for framing, displaying, or gifting your best photos and special photo projects. HP Premium Plus Photo Paper delivers exceptional results with professional quality and durability.

- **HP Advanced Photo Paper**

This glossy photo paper features an instant-dry finish for easy handling without smudging. It resists water, smears, fingerprints, and humidity. Your prints have a look and feel comparable to a store-processed photo. It is available in several sizes, including A4, 8.5 x 11 inches, 10 x 15 cm (4 x 6 inches), 13 x 18 cm (5 x 7 inches). It is acid-free for longer lasting documents.

- **HP Everyday Photo Paper**

Print colorful, everyday snapshots at a low cost, using paper designed for casual photo printing. This affordable photo paper dries quickly for easy handling. Get sharp, crisp images when you use this paper with any inkjet printer. It is available in glossy finish in several sizes, including A4, 8.5 x 11 inches, 5 x 7 inches and 4 x 6 inches (10 x 15 cm). It is acid-free for longer lasting documents.

Business documents

- **HP Premium Presentation Paper 120g Matte or HP Professional Paper 120 Matt**

This paper is a heavy two-sided matte paper perfect for presentation, proposals, reports, and newsletters. It is heavyweight for an impressive look and feel.

- **HP Brochure Paper 180g Glossy or HP Professional Paper 180 Glossy**

These papers are glossy-coated on both sides for two-sided use. They are the perfect choice for near-photographic reproductions and business graphics for report covers, special presentations, brochures, mailers, and calendars.

- **HP Brochure Paper 180g Matte or HP Professional Paper 180 Matt**

These papers are matte-coated on both sides for two-sided use. They are the perfect choice for near-photographic reproductions and business graphics for report covers, special presentations, brochures, mailers, and calendars.

Everyday printing

All the papers listed for everyday printing feature ColorLok Technology for less smearing, bolder blacks, and vivid colors.

- **HP Bright White Inkjet Paper**

HP Bright White Inkjet Paper delivers high-contrast colors and sharp text. It is opaque enough for two-sided color usage with no show-through, which makes it ideal for newsletters, reports, and flyers.

- **HP Printing Paper**

HP Printing Paper is a high-quality multifunction paper. It produces documents that look and feel more substantial than documents printed on standard multipurpose or copy paper. It is acid-free for longer lasting documents.

- **HP Office Paper**

HP Office Paper is a high-quality multifunction paper. It is suitable for copies, drafts, memos, and other everyday documents. It is acid-free for longer lasting documents.

Order HP paper supplies

The printer is designed to work well with most types of office paper. Use HP paper for optimum print quality.

To order HP papers and other supplies, go to www.hp.com. At this time, some portions of the HP website are available in English only.

HP recommends plain papers with the ColorLok logo for printing and copying of everyday documents. All papers with the ColorLok logo are independently tested to meet high standards of reliability and print quality, and produce documents with crisp, vivid color, bolder blacks and shorter dry-time than ordinary plain papers. Look for papers with the ColorLok logo in a variety of weights and sizes from major paper manufacturers.

Tips for selecting and using paper

For the best results, observe the following guidelines.

- Load only one type and one size of paper at a time into a tray or document feeder.
- Make sure the paper is loaded correctly when loading from the input tray or document feeder.
- Do not overload the tray or document feeder.
- To prevent jams, poor print quality, and other printing problems, avoid loading the following paper in the tray or document feeder:
 - Multipart forms
 - Media that is damaged, curled, or wrinkled
 - Media with cutouts or perforations
 - Media that is heavily textured, embossed, or does not accept ink well
 - Media that is too lightweight or stretches easily
 - Media that contains staples or clips

Load paper

To load standard paper

1. Lift the output tray.



2. Pull out the input tray to extend it.



3. Slide the paper-width guides out as far as possible.
4. Insert the paper print-side down in the center of the tray and slide it forward until it stops.

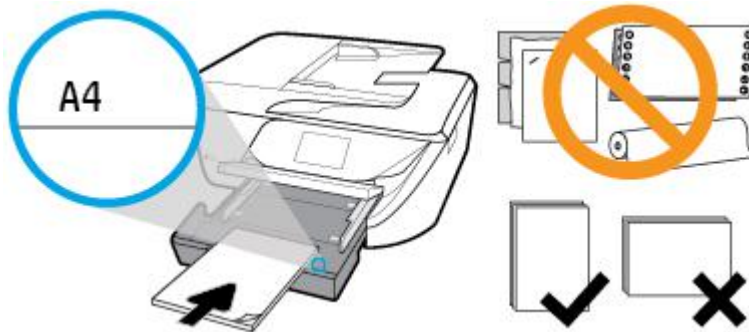

Ensure that the stack of paper is aligned with the appropriate paper size lines on the bottom of the input tray, and does not exceed the stack height marking on the side of the tray.



 **NOTE:** Do not load paper while the printer is printing.

5. Slide the paper-width guides in the tray until they touch the edge of the stack of paper, and then close the tray.



6. A message appears on the control panel display prompting you to change the paper setting if you have changed the media type or size, or retain the setting if you have replaced what was previously loaded.
7. Pull out the output tray extension.

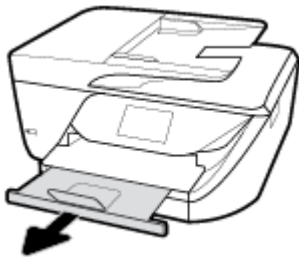

To load cards and photo paper

1. Lift the output tray.



2. Pull out the input tray to extend it.



3. Insert the paper print-side down in the center of the tray and slide it forward until it stops.

Ensure that the stack of paper is aligned with the appropriate paper size lines on the bottom of the input tray, and does not exceed the stack height marking on the side of the tray.



 **NOTE:** Do not load paper while the printer is printing.

4. Slide the paper-width guides in the tray until they touch the edge of the stack of paper, and then close the tray.



5. A message appears on the control panel display prompting you to change the paper setting if you have changed the media type or size, or retain the setting if you have replaced what was previously loaded.
6. Pull out the output tray extension.

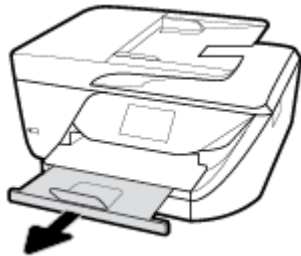

To load an envelope

1. Lift the output tray.

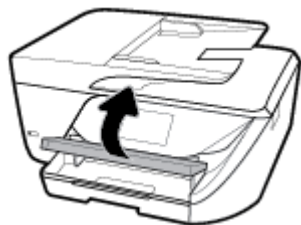

2. Pull out the input tray to extend it.



3. Insert the envelopes with the side you want to print on down, and load according to the graphic.

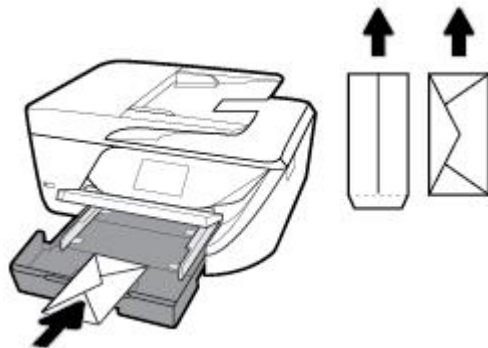

Ensure that the stack of paper is aligned with the appropriate paper size lines on the bottom of the input tray, and does not exceed the stack height marking on the side of the tray.

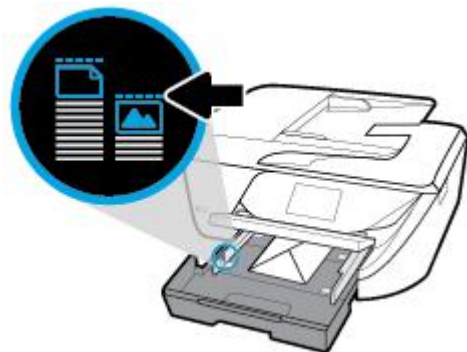

 **NOTE:** Do not load envelopes while the printer is printing.

4. Slide the paper-width guides in the tray until they touch the edge of the stack of envelopes, and then push the tray in to close.



5. A message appears on the control panel display prompting you to change the paper setting if you have changed the media type or size, or retain the setting if you have replaced what was previously loaded.

6. Pull out the output tray extension.

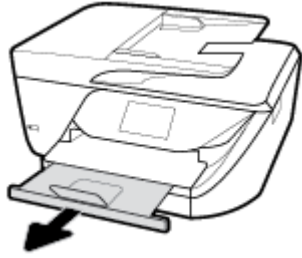

Load an original on the scanner glass

You can copy, scan, or fax originals by loading them on the scanner glass.

 **NOTE:** Many of the special features do not work correctly if the scanner glass and lid backing are not clean. For more information, see [Maintain the printer](#).

 **NOTE:** Remove all originals from the document feeder tray before lifting the lid on the printer.

To load an original on the scanner glass

1. Lift the scanner lid.
2. Load your original print-side down and align it with the marking on the rear left corner of the glass.

 **TIP:** For more help on loading an original, refer to the engraved guides along the edge of the scanner glass.

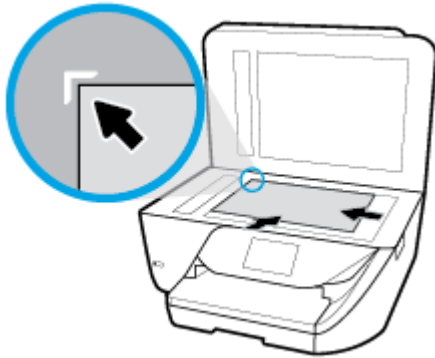

3. Close the lid.

Load an original in the document feeder

You can copy, scan, or fax a document by placing it in the document feeder.

 **CAUTION:** Do not load photos in the document feeder; this might cause damage to your photos. Use only paper that is supported by the document feeder.

 **NOTE:** Some features, such as the **Fit to Page** copy feature, do not work when you load your originals in the document feeder. For those features to work, load your originals on the scanner glass.

To load an original in the document feeder

1. Load your original print-side up into the document feeder.
 - a. If you are loading an original printed in portrait orientation, place the pages so that the top edge of the document goes in first. If you are loading an original printed in landscape orientation, place the pages so that the left edge of the document goes in first.
 - b. Slide the paper into the document feeder until you hear a tone or see a message on the printer control panel display indicating that the loaded pages were detected.

 **TIP:** For more help on loading originals in the document feeder, refer to the diagram engraved in the document feeder tray.

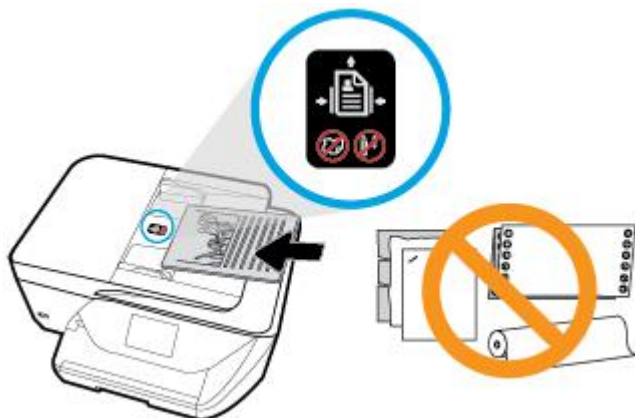



2. Slide the paper-width guides inward until they stop at the left and right edges of the paper.



Update the printer

By default, if the printer is connected to a network and Web Services has been enabled, the printer automatically checks for updates.

To update the printer using the printer control panel

1. On the printer control panel display, from the Home screen, swipe left to see  (**Setup**) and touch  (**Setup**).
2. Touch **Tools**.
3. Touch **Update the Printer**.
4. Touch **Check Now**.

To enable the printer to automatically check for updates

1. On the printer control panel display, from the Home screen, swipe left to see  (**Setup**) and touch  (**Setup**).
2. Touch **Tools**.
3. Touch **Update the Printer**.

4. Touch **Printer Update Options**.
5. Touch **Install Automatically** (recommended) or **Alert When Available**.

To update the printer using the embedded web server

1. Open the EWS.
For more information, see [Embedded web server](#).
2. Click the **Tools** tab.
3. In the **Printer Updates** section, click **Firmware Updates**, and then follow the onscreen instructions.

 **NOTE:** If a printer update is available, the printer downloads and installs the update, and then restarts.

 **NOTE:** If prompted for proxy settings and if your network uses proxy settings, follow the onscreen instructions to set up a proxy server. If you do not have the details, contact your network administrator or the person who set up the network.

Open the HP printer software (Windows)

After installing the HP printer software, depending on your operating system, do one of the following.

- **Windows 10:** From the computer desktop, click **Start**, select **All apps**, click **HP**, and then select the icon with the printer's name.
- **Windows 8.1:** Click the down arrow in lower left corner of the Start screen, and then select the printer name.
- **Windows 8:** Right-click an empty area on the Start screen, click **All Apps** on the app bar, and then select the printer name.
- **Windows 7, Windows Vista, and Windows XP:** From the computer desktop, click **Start**, select **All Programs**, click **HP**, click the folder for the printer, and then select the icon with the printer's name.

Turn the printer off

Press  (the Power button) to turn off the printer. Wait until the power light turns off before unplugging the power cord or turning off a power strip.

 **CAUTION:** If you incorrectly turn the printer off, the print carriage might not return to the correct position, causing problems with the cartridges and print quality issues.

3 Print

Most print settings are automatically handled by the software application. Change the settings manually only when you want to change print quality, print on specific types of paper, or use special features.

 **TIP:** This printer includes **HP ePrint**, a free service from HP that allows you to print documents on your HP ePrint-enabled printer anytime, from any location, without any additional software or printer drivers. For more information, see [Print with HP ePrint](#).

TIP: You can use this printer to print documents and photos on your mobile device (such as a smartphone or tablet). For more information, visit the HP Mobile Printing website (www.hp.com/go/mobileprinting). (At this time, this website might not be available in all languages.)

- [Print documents](#)
- [Print brochures](#)
- [Print on envelopes](#)
- [Print photos](#)
- [Print on special and custom-size paper](#)
- [Print on both sides \(duplexing\)](#)
- [Print with mobile devices](#)
- [Tips for successful printing](#)

Print documents

To print documents (Windows)

1. Load paper in the input tray. For more information, see [Load paper](#).
2. From your software, select **Print**.
3. Make sure your printer is selected.
4. Click the button that opens the **Properties** dialog box.

Depending on your software application, this button might be called **Properties**, **Options**, **Printer Setup**, **Printer Properties**, **Printer**, or **Preferences**.

 **NOTE:** To set print settings for all print jobs, make the changes in the HP software. For more information on the HP software, see [Printer management tools](#).

5. Select the appropriate options on the **Printing Shortcut** tab.

To change other print settings, click the other tabs.

For more printing tips, see [Tips for successful printing](#).

 **NOTE:** If you change the paper size, be sure to load the correct paper in the input tray and set the paper size on the printer control panel.

6. Click **OK** to close the **Properties** dialog box.
7. Click **Print** or **OK** to begin printing.

To print documents (OS X)

1. From the **File** menu in your software, choose **Print**.
2. Make sure your printer is selected.
3. Set the print options.

If you do not see options on the Print dialog, click **Show Details**.

- Choose the appropriate paper size in the **Paper Size** pop-up menu.



NOTE: If you change the paper size, ensure that you have loaded the correct paper.

- Select the orientation.
 - Enter the scaling percentage.
4. Click **Print**.

Print brochures

To print brochures (Windows)

1. Load paper in the input tray. For more information, see [Load paper](#).
2. On the **File** menu in your software application, click **Print**.
3. Make sure your printer is selected.
4. To change settings, click the button that opens the **Properties** dialog box.

Depending on your software application, this button might be called **Properties**, **Options**, **Printer Setup**, **Printer**, or **Preferences**.



NOTE: To set print settings for all print jobs, make the changes in the HP software. For more information on the HP software, see [Printer management tools](#).

5. Select the appropriate options on the **Printing Shortcut** tab.

To change other print settings, click the other tabs.

For more printing tips, see [Tips for successful printing](#).



NOTE: If you change the paper size, be sure to load the correct paper in the input tray and set the paper size on the printer control panel.

6. Click **OK** to close the **Properties** dialog box.
7. Click **Print** or **OK** to begin printing.

To print brochures (OS X)

1. From the **File** menu in your software, choose **Print**.
2. Make sure your printer is selected.
3. Set the print options.

If you do not see options on the Print dialog, click **Show Details**.

- a. Choose the appropriate paper size in the **Paper Size** pop-up menu.



NOTE: If you change the paper size, ensure that you have loaded the correct paper.

- b. From the pop-up menu, choose **Paper Type/Quality**, and then choose the option that provides the best quality or maximum dpi.
4. Click **Print**.

Print on envelopes

Avoid envelopes with the following characteristics:

- Very slick finish
- Self-stick adhesives, clasps, or windows
- Thick, irregular, or curled edges
- Areas that are wrinkled, torn, or otherwise damaged

Make sure the folds of envelopes you load in the printer are sharply creased.



NOTE: For more information about printing on envelopes, see the documentation available with the software program you are using.

To print envelopes (Windows)

1. Load paper in the input tray. For more information, see [Load paper](#).
2. On the **File** menu in your software, click **Print**.
3. Make sure your printer is selected.
4. Click the button that opens the **Properties** dialog box.

Depending on your software application, this button might be called **Properties**, **Options**, **Printer Setup**, **Printer Properties**, **Printer**, or **Preferences**.



NOTE: To set print settings for all print jobs, make the changes in the HP software. For more information on the HP software, see [Printer management tools](#).

5. Select the appropriate options on the **Printing Shortcut** tab.

To change other print settings, click the other tabs.

For more printing tips, see [Tips for successful printing](#).



NOTE: If you change the paper size, be sure to load the correct paper in the input tray and set the paper size on the printer control panel.

6. Click **OK** to close the **Properties** dialog box.
7. Click **Print** or **OK** to begin printing.

To print envelopes (OS X)

1. From the **File** menu in your software, choose **Print**.
2. Make sure your printer is selected.

3. Select the appropriate envelope size from the **Paper Size** pop-up menu.

If you do not see options on the Print dialog, click **Show Details**.

 **NOTE:** If you change the paper size, ensure that you have loaded the correct paper.

4. From the pop-up menu, choose **Paper Type/Quality**, and verify the paper type setting is set to **Plain Paper**.
5. Click **Print**.

Print photos

You can print a photo from your computer.

 **NOTE:** Do not leave unused photo paper in the input tray. The paper might start to curl, which could impair the quality of your printout. Photo paper should be flat before printing.

 **TIP:** You can use this printer to print documents and photos on your mobile device (such as a smartphone or tablet). For more information, visit the HP Mobile Printing website (www.hp.com/go/mobileprinting). (At this time, this website might not be available in all languages.)

To print a photo from the computer (Windows)

1. Load paper in the input tray. For more information, see [Load paper](#).
2. From your software, select **Print**.
3. Make sure your printer is selected.
4. Click the button that opens the **Properties** dialog box.

Depending on your software application, this button might be called **Properties**, **Options**, **Printer Setup**, **Printer Properties**, **Printer**, or **Preferences**.

5. Select the appropriate options on the **Printing Shortcut** tab.

To change other print settings, click the other tabs.

For more printing tips, see [Tips for successful printing](#).

 **NOTE:** If you change the paper size, be sure to load the correct paper in the input tray and set the paper size on the printer control panel.

6. Click **OK** to close the **Properties** dialog box.
7. Click **Print** or **OK** to begin printing.

 **NOTE:** After the printing is finished, remove unused photo paper from the input tray. Store the photo paper so it does not start to curl, which could reduce the quality of your printout.

To print a photo from the computer (OS X)

1. From the **File** menu in your software, choose **Print**.
2. Make sure your printer is selected.
3. Set the print options.

If you do not see options on the Print dialog, click **Show Details**.

- Choose the appropriate paper size in the **Paper Size** pop-up menu.



NOTE: If you change the paper size ensure that you have loaded the correct paper.

- Select the orientation.
4. From the pop-up menu, choose **Paper Type/Quality**, and then choose the following settings:
 - **Paper Type:** The appropriate photo paper type
 - **Quality:** Select the option that provides the best quality or maximum dpi.
 - Click the **Color Options** disclosure triangle, and then choose the appropriate **Photo Fix** option.
 - **Off:** applies no changes to the image.
 - **On:** automatically focuses the image; moderately adjusts image sharpness.
 5. Select any other print settings you want, and then click **Print**.

Print on special and custom-size paper

If your application supports custom-size paper, set the size in the application before printing the document. If not, set the size in the printer driver. You might need to reformat existing documents to print them correctly on custom-size paper.

To set up custom sizes (Windows)

1. Depending on your operating system, do one of the following:
 - **Windows 10:** From the Windows **Start** menu, click **All apps**, select **Windows System**, and then click **Devices**, select **Devices and printers** under **Related settings** menu. Select the printer name, and select **Print server properties**.
 - **Windows 8.1 and Windows 8:** Point to or tap the upper-right corner of the screen to open the Charms bar, click the **Settings** icon, click or tap **Control Panel**, and then click or tap **View devices and printers**. Click or tap the printer name, and click or tap **Print server properties**.
 - **Windows 7:** From the Windows **Start** menu, click **Devices and Printers**. Select the printer name, and select **Print server properties**.
 - **Windows Vista:** From the Windows **Start** menu, click **Control Panel**, and then click **Printers**. Right-click an empty area in the **Printers** window, and select **Server Properties**.
 - **Windows XP:** From the Windows **Start** menu, click **Control Panel**, and then click **Printers and Faxes**. From the **File** menu, click **Server Properties**.
2. Select the **Create a new form** check box.
3. Enter the name of the custom size paper.
4. Enter the dimensions of the custom size in the **Form description (measurements)** section.
5. Click **Save Form**, and then click **Close**.

To print on special or custom-size paper (Windows)



NOTE: Before you can print on custom-size paper, you must set up the custom size in the Print Server Properties.

1. Load the appropriate paper in the input tray. For more information, see [Load paper](#).
2. From the **File** menu in your software application, click **Print**.

3. Make sure your printer is selected.
4. Click the button that opens the **Properties** dialog box.

Depending on your software application, this button might be called **Properties**, **Options**, **Printer Setup**, **Printer Properties**, **Printer**, or **Preferences**.

 **NOTE:** To set print settings for all print jobs, make the changes in the HP software. For more information on the HP software, see [Printer management tools](#).

5. On the **Layout** tab or **Paper/Quality** tab, click the **Advanced** button.
6. In the pop-up window, select the custom size from the **Paper Size** drop-down list. (If you do not see the drop-down list, click **Paper Size** to make it show.)

 **NOTE:** If you change the paper size, be sure to load the correct paper in the input tray and set the paper size on the printer control panel.

7. Click to select any other document options as needed, and then click **OK**.
8. Click **Print** or **OK** to begin printing.

To print on special or custom-size paper (OS X)

Before you can print on custom-size paper, you must set up the custom size in the HP software.

1. Load the appropriate paper in the tray.
2. Create the new custom paper size.
 - a. In the software you want to print from, click **File**, and then click **Print**.
 - b. Make sure your printer is selected.
 - c. Click **Manage Custom Sizes** in the **Paper Size** pop-up menu.
If you do not see options on the Print dialog, click **Show Details**.
 - d. Click **+**, and then select the new item in the list and type a name for the custom paper size.
 - e. Enter the height and width for your custom paper.
 - f. Click **Done** or **OK**, and then click **Save**.
3. Use the created custom paper size to print.
 - a. From the **File** menu in your software application, click **Print**.
 - b. Make sure your printer is selected.
 - c. Choose the custom paper size name you created in the **Paper Size** pop-up menu.
 - d. Select any other print settings you want, and then click **Print**.

Print on both sides (duplexing)

To print on both sides of the page (Windows)

1. Load paper in the input tray. For more information, see [Load paper](#).
2. From your software, select **Print**.
3. Make sure your printer is selected.

4. Click the button that opens the **Properties** dialog box.

Depending on your software application, this button might be called **Properties**, **Options**, **Printer Setup**, **Printer Properties**, **Printer**, or **Preferences**.



NOTE: To set print settings for all print jobs, make the changes in the HP software. For more information on the HP software, see [Printer management tools](#).

5. On the **Printing Shortcut** tab, select a shortcut which supports the **Print On Both Sides** setting. Select an option from the **Print On Both Sides** drop-down list.

To change other print settings, click the other tabs.

For more printing tips, see [Tips for successful printing](#).



NOTE: If you change the paper size, be sure to load the correct paper in the input tray and set the paper size on the printer control panel.

6. Click **OK** to close the **Properties** dialog box.
7. Click **Print** or **OK** to begin printing.

To print on both sides of the paper (OS X)

1. From the **File** menu in your software, choose **Print**.
2. In the Print dialog, choose **Layout** from the pop-up menu.
3. Choose the type of binding you want for your two-sided pages, and then click **Print**.

Print with mobile devices

Print from mobile devices

You can print documents and photos directly from your mobile devices, including iOS, Android, Windows Mobile, Chromebook and Amazon Kindle.

To print from mobile devices

1. Make sure your printer is connected to the same network as your mobile device.
2. Enable printing on your mobile device:
 - **iOS:** Use the **Print** option from the **Share** menu. No setup is required since iOS AirPrint is preinstalled.



NOTE: Devices running iOS 4.2 or later have AirPrint preinstalled.

- **Android:** Download the HP Print Service Plugin (supported by most Android devices) from the Google Play Store and enable it on your device.



NOTE: Devices running Android 4.4 or later are supported by the HP Print Service Plugin. Devices running Android 4.3 or earlier can print using the HP ePrint app, available in the Google Play Store.

- **Windows Mobile:** Tap **Print** from the **Device** menu. No setup is required since the software is preinstalled.



NOTE: If your printer is not listed, you might need to do a one-time setup of the printer using the **Add Printer** wizard.

- **Chromebook:** Download and install the **HP Print for Chrome** app from the Chrome Web Store to enable both Wi-Fi and USB printing.
- **Amazon Kindle Fire HD9 and HDX:** The first time you select **Print** on your device, the HP Print Service Plugin is automatically downloaded to enable mobile printing.

 **NOTE:** For detailed information about enabling printing from your mobile devices, visit www.hp.com/go/mobileprinting. If a local version of this website is not available in your country/region or language, you might be directed to the HP Mobile Printing website in another country/region or language.

3. Make sure the loaded paper matches the paper settings of the printer (see [Load paper](#) for more information). Accurately setting the paper size for the paper that is loaded enables your mobile device to know what paper size it is printing.

Access printer features and troubleshooting information from mobile devices

The HP All-in-One Printer Remote app helps you set up and use your HP printer for printing, scanning, storing, and sharing documents from virtually anywhere. It can also report printer status, perform maintenance tasks, order original HP printing supplies, identify and resolve printer errors, and provide troubleshooting assistance and support from HP.

HP All-in-One Printer Remote is supported on iOS, Android and Windows Mobile. Install it from the App Store or Google Play Store to enhance the capabilities of your printer.

 **NOTE:** Some features might not be available with all printer models. Also, at this time, HP All-in-One Printer Remote might not be available in all languages. For more information, visit <http://www.hp.com/support>.

Tips for successful printing

Software settings selected in the print driver only apply to printing, they do not apply to copying or scanning.

You can print your document on both sides of the paper. For more information, see [Print on both sides \(duplexing\)](#).

Ink tips

- If the print quality is not acceptable, see [Printing issues](#) for more information.
- Use Original HP cartridges.

Original HP cartridges are designed and tested with HP printers and papers to help you easily produce great results, time after time.

 **NOTE:** HP cannot guarantee the quality or reliability of non-HP supplies. Product service or repairs required as a result of using a non-HP supply will not be covered under warranty.

If you believe you purchased Original HP cartridges, go to www.hp.com/go/anticounterfeit.

- Install both the black and color cartridges correctly.
For more information, see [Replace the cartridges](#).
- Check the estimated ink levels in the cartridges to make sure there is sufficient ink.
Ink level warnings and indicators provide estimates for planning purposes only.
For more information, see [Check the estimated ink levels](#).



NOTE: When you receive a low-ink warning message, consider having a replacement cartridge available to avoid possible printing delays. You do not have to replace the cartridges until prompted to do so.

- Always use the Power button to turn off the printer. Turning the printer off improperly can cause print quality problems.

Paper loading tips

For more information, also see [Load paper](#).

- Ensure the paper is loaded in the input tray properly, and set the correct media size and media type. Upon loading paper in input tray, you will be prompted to set the media size and media type.
- Load a stack of paper (not just one page). All the paper in the stack should be of the same size and type to avoid a paper jam.
- Load paper with the print-side down.
- Ensure that paper loaded in the input tray lays flat and the edges are not bent or torn.

Printer settings tips (Windows)

- To change default print settings, click **Print, Scan & Fax**, and then click **Set Preferences** in the HP printer software.

To open the HP printer software, see [Open the HP printer software \(Windows\)](#) for more information.

- To select the number of pages to print per sheet, on the **Layout** tab of the printer driver, select the appropriate option from the **Pages per Sheet** drop-down list.
- If you want to change the page orientation, on the **Layout** tab of the printer driver, select the appropriate option from the **Orientation** area.
- To view more printing settings, on the **Layout** or **Paper/Quality** tab of the printer driver, click the **Advanced** button to open the **Advanced Options** dialog box.



NOTE: The preview on the **Layout** tab cannot reflect what you select from the **Pages per Sheet Layout**, the **Booklet**, or the **Page Borders** drop-down lists.

- **Print in Grayscale:** Allows you to print a black and white document using the black ink only. Select **Black Ink Only**, and then click the **OK** button.
- **Pages per Sheet Layout:** Helps you specify the order of the pages if you print document in more than two pages per sheet.
- **HP Real Life Technologies:** This feature smooths and sharpens images and graphics for improved print quality.
- **Booklet:** Allows you to print a multiple-page document as a booklet. It places two pages on each side of a sheet that can then be folded into a booklet in half size of the paper. Select a binding method from the drop-down list, and then click **OK**.
 - **Booklet-LeftBinding:** The binding side after folded into a booklet appears at the left side. Select the option if your reading habit is from left to right.
 - **Booklet-RightBinding:** The binding side after folded into a booklet appears at the right side. Select the option if your reading habit is from right to left.

- **Borderless Printing:** Select this feature to print photos without border. Not all paper types support this feature. You will see an alert icon beside the option if the selected paper type in the **Media** drop-down list does not support it.
- **Page Borders:** Allows you to add the borders to the pages if you print the document with two or more pages per sheet.
- You can use printing shortcut to save time setting printing preferences. A printing shortcut stores the setting values that are appropriate for a particular kind of job, so that you can set all the options with a single click.

To use it, go to the **Printing Shortcut** tab, select a printing shortcut, and then click **OK**.

To delete a printing shortcut, select it, and then click **Delete**.



NOTE: You cannot delete the default printing shortcuts.

Printer settings tips (OS X)

- On the Print dialog, use the **Paper Size** pop-up menu to select the size of paper loaded in the printer.
- On the Print dialog, choose the **Paper Type/Quality** pop-up menu and select the appropriate paper type and quality.



4 Copy and scan

- [Copy](#)
- [Scan](#)
- [Tips for copy and scan success](#)

Copy

The **Copy** menu on the printer display allows you to easily select number of copies and color or black and white for copying on plain paper. You can also easily access advanced settings, such as changing the paper type and size, adjusting the darkness of the copy, and resizing the copy.

To make a copy

1. Load your original print-side down on the scanner glass.
2. On the printer control panel display, from the Home screen, touch **Copy**.
3. Specify the desired number of copies. Do either of the following to specify the number:
 - Select a number in the spinner. You can swipe left or right in the spinner to increase or decrease the number.
 - Touch the keypad button on the right side of the spinner to enter a specific number.
4. Touch  (**Settings**) to specify paper size, paper type, quality, or other settings.
 - To copy two pages of the original to 2 sides of a sheet, touch the toggle button next to **2-Sided** to set it to **ON**.
 - Touch  (**Back**) to return to the Copy menu.
5. Touch **Start Black** or **Start Color** to start the copy job.

Scan

You can scan documents, photos, and other paper types, and send them to a variety of destinations, such as a computer or an email recipient.

When scanning documents with the HP printer software, you can scan to a format that can be searched and edited.

When scanning a borderless original, use the scanner glass and not the document feeder.

 **NOTE:** Some scan functions are only available after you have installed the HP printer software.

 **TIP:** If you have problems scanning documents, see [Scan issues](#).

- [Scan to a computer](#)
- [Scan to email](#)
- [Scan documents as editable text](#)
- [Scan using Webscan](#)
- [Create a new scan shortcut \(Windows\)](#)
- [Change scan settings \(Windows\)](#)

Scan to a computer

Before scanning to a computer, make sure you have already installed the HP recommended printer software. The printer and computer must be connected and turned on.

In addition, on Windows computers, the printer software must be running prior to scanning.

You can use the HP printer software to scan documents into editable text. For more information, see [Scan documents as editable text](#).

To enable the scan to a computer feature (Windows)

If the printer is connected to the computer with a USB connection, the feature for scanning to computer is enabled by default and cannot be disabled.

If you are using network connection, follow these instructions if the feature has been disabled, and you wish to enable it again.

1. Open the HP printer software. For more information, see [Open the HP printer software \(Windows\)](#).
2. Go to the **Scan** section.
3. Select **Manage Scan to Computer**.
4. Click **Enable**.

To enable the scan to a computer feature (OS X)

The scan to a computer feature is enabled by default from the factory. Follow these instructions if the feature has been disabled, and you wish to enable it again.

1. Open HP Utility.



NOTE: HP Utility is located in the **HP** folder in the **Applications** folder.

2. Under **Scan Settings**, click **Scan to Computer**.
3. Ensure that **Enable Scan to Computer** is selected.

To scan an original from HP printer software (Windows)

1. Load your original print-side down on the scanner glass or print-side up in the document feeder.
2. Open the HP printer software. For more information, see [Open the HP printer software \(Windows\)](#).
3. In the printer software, under **Print, Scan & Fax**, click **Scan**, and then click **Scan a Document or Photo**.
4. Under **Scan Shortcuts**, select the type of scan you want, and then click **Scan**.

 **NOTE:** The initial screen allows you to review and modify basic settings. Click the **More** link at the top right corner of the Scan dialog to review and modify detailed settings.

For more information, see [Change scan settings \(Windows\)](#).

To scan an original from HP printer software (OS X)

1. Open HP Easy Scan.
HP Easy Scan is located in the **Applications** folder.
2. Click **Scan**.
3. Choose the type of scan profile you want and follow the onscreen instructions.

Scan to email

To scan a document or photo to email from HP printer software (Windows)

1. Load your original print-side down on the scanner glass or print-side up in the document feeder.
2. Open the HP printer software. For more information, see [Open the HP printer software \(Windows\)](#).
3. In the printer software, under **Print, Scan & Fax**, click **Scan**, and then click **Scan a Document or Photo**.
4. Under **Scan Shortcuts**, select **Email as PDF** or **Email as JPEG**, and then click **Scan**.

 **NOTE:** The initial screen allows you to review and modify basic settings. Click the **More** link at the top right corner of the Scan dialog to review and modify detailed settings.

For more information, see [Change scan settings \(Windows\)](#).

If **Show Viewer After Scan** is selected, you can make adjustments to the scanned image in the preview screen.

Scan documents as editable text

When scanning documents, you can use the HP software to scan documents into a format that you can search, copy, paste, and edit. This allows you to edit letters, newspaper clippings, and many other documents.

- [Scan documents as editable text](#)
- [Guidelines for scanning documents as editable text](#)

Scan documents as editable text

Use the following guidelines for scanning documents as editable text.

To scan a document to editable text (Windows)

1. Load your original print-side down on the scanner glass or print-side up in the document feeder.
2. Open the HP printer software. For more information, see [Open the HP printer software \(Windows\)](#).
3. In the printer software, under **Print, Scan & Fax**, click **Scan**, and then click **Scan a Document or Photo**.
4. Under **Scan Shortcuts**, select **Save as Editable Text (OCR)** and then click **Scan**.



NOTE: The initial screen allows you to review and modify basic settings. Click the **More** link at the top right corner of the Scan dialog to review and modify detailed settings.

For more information, see [Change scan settings \(Windows\)](#).

If **Show Viewer After Scan** is selected, you can make adjustments to the scanned image in the preview screen.

To scan documents as editable text (OS X)

1. Load your original print-side down on the scanner glass or print-side up in the document feeder.
2. Open HP Scan.
HP Scan is located in the **Applications/HP** folder at the top level of the hard disk.
3. Click the **Scan** button. A dialog appears requesting confirmation of your scanning device and the scan settings preset.
4. Follow the onscreen instructions to complete the scan.
5. When all of the pages have been scanned, select **Save** from the **File** menu. The Save dialog appears.
6. Select the type of editable text.

I want to...	Follow these steps
Extract just the text, without any of the formatting of the original	Select TXT from the Format pop-up menu.
Extract the text, as well as some of the formatting of the original	Select RTF from the Format pop-up menu.
Extract the text and make it searchable in PDF readers	Select Searchable PDF from the Format pop-up menu.

7. Click **Save**.

Guidelines for scanning documents as editable text

Use the following guidelines to ensure the software successfully converts your documents.

- **Make sure the scanner glass or document feeder window is clean..**

Smudges or dust on the scanner glass or document feeder window can prevent the software from converting the document to editable text

- **Make sure the document is loaded correctly.**

Make sure the original is properly loaded and aligned with the marking on the rear left corner of the glass. Make sure that the document is not skewed.

- **Make sure the text on the document is clear.**

To successfully convert the document to editable text, the original must be clear and of high quality.

The following conditions can cause the software to not convert the document successfully:

- The text on the original is faint or wrinkled.
- The text is too small.
- The structure of the document is too complex.

- The text is tightly spaced. For example, if the text that the software converts has missing or combined characters, "rn" might appear as "m."
- The text is on a colored background. Colored backgrounds can cause images in the foreground to blend too much.

- **Choose the correct profile.**

Be sure to select a shortcut or preset that allows scanning as editable text. These options use scan settings designed to maximize the quality of your OCR scan.

Windows: Use the **Editable Text (OCR)** or **Save as PDF** shortcuts.

OS X: Use the **Documents with Text** preset.

- **Save your file in the correct format.**

If you want to extract just the text from the document, without any of the formatting of the original, select a plain text format, such as **Text (.txt)** or **TXT**.

If you want to extract the text, as well as some of the formatting of the original, select Rich Text Format, such as **Rich Text (.rtf)** or **RTF**, or searchable PDF format, such as **Searchable PDF (.pdf)** or **Searchable PDF**.

Scan using Webscan

Webscan is a feature of the embedded web server that lets you scan photos and documents from your printer to your computer using a web browser.

This feature is available even if you did not install the printer software on your computer.

For more information, see [Embedded web server](#).



NOTE: By default, Webscan is off. You can enable this feature from the EWS.

If you are unable to open Webscan in the EWS, your network administrator might have turned it off. For more information, contact your network administrator or the person who set up your network.

To enable Webscan

1. Open the embedded web server. For more information, see [Embedded web server](#).
2. Click the **Settings** tab.
3. In the **Security** section, click **Administrator Settings**.
4. Select **Webscan from EWS** to enable Webscan.
5. Click **Apply**.

To scan using Webscan

Scanning using Webscan offers basic scan options. For additional scan options or functionality, scan from the HP printer software.

1. Load your original print-side down on the scanner glass or print-side up in the document feeder.
2. Open the embedded web server. For more information, see [Embedded web server](#).
3. Click the **Scan** tab.
4. Click **Webscan** in the left pane, change any settings, and then click **Start Scan**.

 **TIP:** To scan documents as editable text, you must install the HP printer software. For more information, see [Scan documents as editable text](#).

Create a new scan shortcut (Windows)

You can create your own scan shortcut to make scanning easier. For example, you might want to regularly scan and save photos in PNG format, rather than JPEG.

1. Load your original print-side down on the scanner glass or print-side up in the document feeder.
2. Open the HP printer software. For more information, see [Open the HP printer software \(Windows\)](#).
3. In the printer software, under **Print, Scan & Fax**, click **Scan**, and then click **Scan a Document or Photo**.
4. Click **Create New Scan Shortcut**.
5. Enter a descriptive name, choose an existing shortcut on which to base your new shortcut, and then click **Create**.

For example, if you are creating a new shortcut for photos, choose either **Save as JPEG** or **Email as JPEG**. This makes available the options for working with graphics when scanning.

6. Change the settings for your new shortcut to meet your needs, and then click the save icon to the right of the shortcut.

 **NOTE:** The initial screen allows you to review and modify basic settings. Click the **More** link at the top right corner of the Scan dialog to review and modify detailed settings.

For more information, see [Change scan settings \(Windows\)](#).

Change scan settings (Windows)

You can modify any of the scan settings either for a singular use or save the changes to use permanently. These settings include options such as page size and orientation, scan resolution, contrast, and the folder location for saved scans.

1. Load your original print-side down on the scanner glass or print-side up in the document feeder.
2. Open the HP printer software. For more information, see [Open the HP printer software \(Windows\)](#).
3. In the printer software, under **Print, Scan & Fax**, click **Scan**, and then click **Scan a Document or Photo**.
4. Click the **More** link in the top right corner of the HP Scan dialog.

The detailed settings pane appears on the right. The left column summarizes the current settings for each section. The right column allows you to change the settings in the highlighted section.

5. Click each section at the left of the detailed settings pane to review the settings in that section.

You can review and change most settings using drop-down menus.

Some settings allow greater flexibility by displaying a new pane. These are indicated by a + (plus sign) at the right of the setting. You must either accept or cancel any changes on this pane to return to the detailed settings pane.

6. When you have finished changing settings, do one of the following.
 - Click **Scan**. You are prompted to save or reject the changes to the shortcut after the scan is finished.
 - Click the save icon to the right of the shortcut. It saves the changes into the shortcut so that you can reuse them next time. Otherwise, the changes only affect the current scan. Then click **Scan**.



Learn more about using the HP Scan software. [Click here to go online for more information](#). At this time, this website might not be available in all languages.

- Customize scan settings, such as image file type, scan resolution, and contrast levels.
- Scan to network folders and cloud drives.
- Preview and adjust images before scanning.

Tips for copy and scan success

Use the following tips to copy and scan successfully.

- Keep the glass and the back of the lid clean. The scanner interprets anything it detects on the glass as part of the image.
- Load your original print-side down on the scanner glass and align it with the marking on the rear left corner of the glass.
- To make a large copy of a small original, scan the original into the computer, resize the image in the scanning software, and then print a copy of the enlarged image.
- If you want to adjust scan size, output type, scan resolution, or file type, and so on, start scan from the printer software.
- To avoid incorrect or missing scanned text, make sure the brightness is set appropriately in the software.
- If you want to scan a document with several pages into one file instead of multiple files, start the scan with the printer software instead of selecting **Scan** from the printer display.

5 Fax

You can use the printer to send and receive faxes, including color faxes. You can schedule faxes to be sent at a later time within 24 hours and set up phone book contacts to send faxes quickly and easily to frequently used numbers. From the printer control panel, you can also set a number of fax options, such as resolution and the contrast between lightness and darkness on the faxes you send.

 **NOTE:** Before you begin faxing, make sure you have set up the printer correctly for faxing. You can verify the fax is set up correctly by running the fax setup test from the printer control panel.

- [Send a fax](#)
- [Receive a fax](#)
- [Set up phone book contacts](#)
- [Change fax settings](#)
- [Fax and digital phone services](#)
- [Fax on Voice over Internet Protocol](#)
- [Use reports](#)
- [Additional fax setup](#)

Send a fax

You can send a fax in a variety of ways, depending on your situation or need.

- [Send a standard fax](#)
- [Send a standard fax from the computer](#)
- [Send a fax from a phone](#)
- [Send a fax using monitor dialing](#)
- [Send a fax using printer memory](#)
- [Send a fax to multiple recipients](#)
- [Send a fax in Error Correction Mode](#)

Send a standard fax

You can easily send a single- or multiple-page black-and-white or color fax by using the printer control panel.

 **NOTE:** Send single-page faxes by placing the original on the glass. Send multiple page faxes using the document feeder.

 **NOTE:** If you need printed confirmation that your faxes were successfully sent, fax confirmation must be enabled.

To send a standard fax from the printer control panel

1. Load your original print-side down on the scanner glass or print-side up in the document feeder.
2. From the printer control panel display, touch **Fax**.
3. Touch **Send Now**.
4. Touch **Enter Fax Number** or touch  (**Phone book**).
5. Enter the fax number using the screen keypad that appears or select a phone book contact or previously dialed or received number.

 **TIP:** To add a pause in the fax number you are entering, touch * repeatedly, until a dash (-) appears on the display.

6. Touch **Black** or **Color**.

 **TIP:** If the recipient reports issues with the quality of the fax, try changing the resolution or contrast of your fax.

Send a standard fax from the computer

You can fax a document directly from your computer without printing it first.

To use this feature, make sure you have installed the HP printer software on your computer, the printer is connected to a working telephone line, and the fax function is set up and functioning correctly.

To send a standard fax from the computer (Windows)

1. Open the document on your computer that you want to fax.
2. On the **File** menu in your software application, click **Print**.
3. From the **Name** list, select the printer that has “**fax**” in the name.
4. To change settings (such as selecting to send the document as a black fax or a color fax), click the button that opens the **Properties** dialog box. Depending on your software application, this button might be called **Properties**, **Options**, **Printer Setup**, **Printer**, or **Preferences**.
5. After you have changed any settings, click **OK**.
6. Click **Print** or **OK**.
7. Enter the fax number and other information for the recipient, change any further settings for the fax, and then click **Send Fax**. The printer begins dialing the fax number and faxing the document.

To send a standard fax from the computer (OS X)

1. Open the document on your computer that you want to fax.
2. From the **File** menu in your software, click **Print**.
3. Select the printer that has “**(Fax)**” in the name.
4. Enter a fax number or a name from your Contacts that already has a fax number entry.
5. When you have finished filling out the fax information, click **Fax**.

Send a fax from a phone

You can send a fax using your telephone extension. This allows you to talk with the intended recipient before sending the fax.

To send a fax from an extension phone

1. Load your original print-side down on the scanner glass or print-side up in the document feeder.

2. Dial the number by using the keypad on the phone that is connected to the printer.

If the recipient answers the telephone, inform the recipient that they should receive the fax on their fax machine after they hear fax tones. If a fax machine answers the call, you will hear fax tones from the receiving fax machine.

3. From the printer control panel display, touch **Fax** .

4. Touch **Send Now**.

5. When you are ready to send the fax, touch **Black** or **Color** .

The telephone is silent while the fax is transmitting. If you want to speak to the recipient later, remain on the line until the transmission is complete. If you were finished talking to the recipient, you can hang up the telephone as soon as the fax begins transmitting.

Send a fax using monitor dialing

When you send a fax using monitor dialing, you can hear the dial tones, telephone prompts, or other sounds through the speakers on the printer. This enables you to respond to prompts while dialing, as well as control the pace of your dialing.

 **TIP:** If you are using a calling card and do not enter your PIN fast enough, the printer might start sending fax tones too soon and cause your PIN not to be recognized by the calling card service. If this is the case, create a phone book contact to store the PIN for your calling card.

 **NOTE:** Make sure the volume is turned on to hear a dial tone.

To send a fax using monitor dialing from the printer control panel

1. Load your original print-side down on the scanner glass or print-side up in the document feeder.

2. From the printer control panel display, touch **Fax** .

3. Touch **Send Now**.



4. Touch **Black** or **Color** .

5. Touch **Enter Fax Number** or touch  (**Phone book**).

6. Enter the fax number using the screen keypad that appears or select a phone book contact or previously dialed or received number.

 **TIP:** To add a pause in the fax number you are entering, touch * repeatedly, until a dash (-) appears on the display.

7. Follow any prompts that might occur.

 **TIP:** If you are using a calling card to send a fax and you have your calling card PIN stored as a phone book contact, when prompted to enter your PIN, touch  (**Phone book**) to select the phone book contact where you have your PIN stored.

Your fax is sent when the receiving fax machine answers.

Send a fax using printer memory

You can scan a black-and-white fax into memory and then send the fax from memory. This feature is useful if the fax number you are trying to reach is busy or temporarily unavailable. The printer scans the originals into memory and sends them once it is able to connect to the receiving fax machine. After the printer scans the pages into memory, you can immediately remove the originals from the document feeder tray or scanner glass.

 **NOTE:** You can only send a black-and-white fax from memory.

To send a fax from memory

1. Ensure that **Scan and Fax Method** is turned on.
 - a. From the printer control panel display, touch **Fax**.
 - b. Touch **Fax Setup**, and then touch **Preferences**.
 - c. Set **Scan and Fax Method** to on.
2. Load your original print-side down on the scanner glass or print-side up in the document feeder.
3. From the printer control panel display, touch **Fax**.
4. Touch **Send Now**.
5. Touch **Enter Fax Number** or touch  (**Phone book**).
6. Enter the fax number using the screen keypad that appears or select a phone book contact or previously dialed or received number.

 **TIP:** To add a pause in the fax number you are entering, touch * repeatedly, until a dash (-) appears on the display.

7. Touch **Black**.

The printer sends the fax when the receiving fax machine is available.

Send a fax to multiple recipients

You can send a fax to multiple recipients by creating a group phone book contact made up of two or more individual recipients.

To send a fax to multiple recipients using group phone book

1. Load your original print-side down on the scanner glass or print-side up in the document feeder.
2. From the printer control panel display, touch **Fax**.
3. Touch **Send Now**.
4. Touch  (**Phone book**).

5. Touch **Group Contacts**.
6. Touch the name of the group phone book contact.
7. Touch **Send Fax**.

 **TIP:** If the recipient reports issues with the quality of the fax, try changing the resolution or contrast of your fax.

Send a fax in Error Correction Mode

Error Correction Mode (ECM) prevents loss of data due to poor phone lines by detecting errors that occur during transmission and automatically requesting retransmission of the erroneous portion. Phone charges are unaffected, or might even be reduced, on good phone lines. On poor phone lines, ECM increases sending time and phone charges, but sends the data much more reliably. The default setting is **On**. Turn ECM off only if it increases phone charges substantially, and if you can accept poorer quality in exchange for reduced charges.

If you turn ECM off:

- The quality and transmission speed of faxes you send and receive are affected.
- The **Speed** is automatically set to **Medium**.
- You can no longer send or receive faxes in color.

To change the ECM setting from the control panel

1. From the printer control panel display, touch **Fax**.
2. Touch **Setup**.
3. Touch **Preferences**.
4. Scroll to **Error Correction Mode** to touch to turn the feature on or off.

Receive a fax

You can receive faxes automatically or manually. If you turn off the **Auto Answer** option, you must receive faxes manually. If you turn on the **Auto Answer** option (the default setting), the printer automatically answers incoming calls and receives faxes after the number of rings that are specified by the **Rings to Answer** setting. (The default **Rings to Answer** setting is five rings.)

If you receive a Legal-size or larger fax and the printer is not currently set to use Legal-size paper, the printer reduces the fax so that it fits on the paper that is loaded. If you have disabled the **Auto Reduction** feature, the printer prints the fax on two pages.

 **NOTE:** If you are copying a document when a fax arrives, the fax is stored in the printer memory until the copying finishes.

- [Receive a fax manually](#)
- [Set up backup fax](#)
- [Reprint received faxes from memory](#)
- [Forward faxes to another number](#)
- [Set automatic reduction for incoming faxes](#)
- [Block unwanted fax numbers](#)

- [Receive faxes using HP Digital Fax](#)

Receive a fax manually

When you are on the phone, the person you are speaking with can send you a fax while you are still connected. You can pick up the handset to talk or listen for fax tones.

You can receive faxes manually from a phone that is directly connected to the printer (on the 2-EXT port).

To receive a fax manually

1. Make sure the printer is turned on and you have paper loaded in the main tray.
2. Remove any originals from the document feeder tray.
3. Set the **Rings to Answer** setting to a high number to allow you to answer the incoming call before the printer answers. Or, turn off the **Auto Answer** setting so that the printer does not automatically answer incoming calls.
4. If you are currently on the phone with the sender, instruct the sender to press **Start** on their fax machine.
5. Do the following when you hear fax tones from a sending fax machine.
 - a. From the printer control panel display, touch **Fax**, touch **Send and Receive**, and then touch **Receive Now**.
 - b. After the printer begins to receive the fax, you can hang up the phone or remain on the line. The phone line is silent during fax transmission.

Set up backup fax

Depending on your preference and security requirements, you can set up the printer to store all the faxes it receives, only the faxes it receives while the printer is in an error condition, or none of the faxes it receives.

To set backup fax from the printer control panel

1. From the printer control panel display, touch **Fax**.
2. Touch **Setup**.
3. Touch **Preferences**.
4. Touch **Backup Fax Reception**.
5. Touch the required setting.

On

The default setting. When **Backup fax** is **On**, the printer stores all received faxes in memory. This enables you to reprint up to 30 of the most recently printed faxes if they are still saved in memory.

NOTE: When printer memory is low, it overwrites the oldest, printed faxes as it receives new faxes. If the memory becomes full of unprinted faxes, the printer stops answering incoming fax calls.

NOTE: If you receive a fax that is too large, such as a very detailed color photo, it might not be stored in memory due to memory limitations.

On Error Only

Causes the printer to store faxes in memory only if an error condition exists that prevents the printer from printing the faxes (for example, if the printer runs out of paper). The printer continues to store incoming faxes as long as there is memory available. (If the memory becomes full, the

printer stops answering incoming fax calls.) When the error condition is resolved, the faxes stored in memory print automatically, and then they are deleted from memory.

Off Faxes are never stored in memory. For example, you might want to turn off **Backup fax** for security purposes. If an error condition occurs that prevents the printer from printing (for example, the printer runs out of paper), the printer stops answering incoming fax calls.

Reprint received faxes from memory

The received faxes that are not printed are stored in memory.

 **NOTE:** After the memory becomes full, the printer cannot receive the new fax until you print or delete the faxes from memory. You might also want to delete the faxes in memory for security or privacy purposes.

You can reprint up to 30 of the most recently printed faxes, if they are still in memory. For example, you might need to reprint your faxes if you lost the copy of your last printout.

To reprint faxes in memory from the printer control panel

1. Make sure you have paper loaded in the main tray. For more information, see [Load paper](#).
2. From the printer control panel display, touch **Fax**.
3. Touch **Reprint**.

The faxes are printed in the reverse order from which they were received with the most recently received fax printed first, and so on.

4. Touch to select a fax, and then touch **Print**.

Forward faxes to another number

You can set up the printer to forward your faxes to another fax number. All faxes are forwarded in black and white, regardless of how they were originally sent.

HP recommends that you verify the number you are forwarding to is a working fax line. Send a test fax to make sure the fax machine is able to receive your forwarded faxes.

To forward faxes from the printer control panel

1. From the printer control panel display, touch **Fax**.
2. Touch **Fax Setup**.
3. Touch **Preferences**.
4. Touch **Fax Forwarding**.
5. Touch **On (Print and Forward)** to print and forward the fax, or select **On (Forward)** to forward the fax.

 **NOTE:** If the printer is not able to forward the fax to the designated fax machine (for example, if it is not turned on), the printer prints the fax. If you set up the printer to print error reports for received faxes, it also prints an error report.

6. At the prompt, enter the number of the fax machine intended to receive the forwarded faxes, and then touch **Done** . Enter the required information for each of the following prompts: start date, start time, end date, and end time.
7. Fax forwarding is activated. Touch **OK** to confirm.

If the printer loses power when fax forwarding is set up, it saves the fax forwarding setting and phone number. When the power is restored to the printer, the fax forwarding setting is still **On** .



NOTE: You can cancel fax forwarding by selecting **Off** from the **Fax Forwarding** menu.

Set automatic reduction for incoming faxes

The **Auto Reduction** setting determines what the printer does if it receives a fax that is too large for the loaded paper size. This setting is turned on by default, so the image of the incoming fax is reduced to fit on one page, if possible. If this feature is turned off, information that does not fit on the first page is printed on a second page. **Auto Reduction** is useful when you receive a fax larger than A4/Letter-size fax and A4/Letter-size paper is loaded in the input tray.

To set automatic reduction from the printer control panel

1. From the printer control panel display, touch **Fax** .
2. Touch **Setup** .
3. Touch **Preferences** .
4. Touch **Auto Reduction** to turn the feature on or off.

Block unwanted fax numbers

If you subscribe to a caller ID service through your phone provider, you can block specific fax numbers so the printer does not receive faxes received from those numbers. When an incoming fax call is received, the printer compares the number to the list of junk fax numbers to determine if the call should be blocked. If the number matches a number in the blocked fax numbers list, the fax is not received. (The maximum number of fax numbers you can block varies by model.)



NOTE: This feature is not supported in all countries/regions. If it is not supported in your country/region, **Junk Fax Blocking** does not appear in the **Preferences** menu.





NOTE: If no phone numbers are added in the Caller ID list, it is assumed that you are not subscribed to a Caller ID service.

You can block specific fax numbers by adding them to the junk fax list, unblock these numbers by removing them from the junk fax list, and print a list of blocked junk fax numbers.

To add a number to the junk fax list

1. From the printer control panel display, touch **Fax** .
2. Touch **Setup** .
3. Touch **Preferences** .
4. Touch **Junk Fax Blocking** .
5. Touch **+** (Plus Sign).
6. Do one of the following.

- To select a fax number to block from the call history list, touch  (**Call history**).
- Manually enter a fax number to block, and touch **Add**.

 **NOTE:** Make sure you enter the fax number as it appears on the control panel display, and not the fax number that appears on the fax header of the received fax, as these numbers can be different.

To remove numbers from the junk fax list

If you no longer want to block a fax number, you can remove it from the junk fax list.

1. From the printer control panel display, touch **Fax** .
2. Touch **Setup** .
3. Touch **Preferences** .
4. Touch **Junk Fax Blocking** .
5. Touch the number you want to remove, and then touch **Remove**.

To print a junk fax list

1. From the printer control panel display, touch **Fax** .
2. Touch **Setup** , and then touch **Reports** .
3. Touch **Print Fax Reports** .
4. Touch **Junk Fax Report**.
5. Touch **Print** to begin printing.

Receive faxes using HP Digital Fax

You can use HP Digital Fax to automatically receive faxes and save them directly to your computer. This saves paper and ink.

Received faxes are saved as TIFF (Tagged Image File Format) or PDF (Portable Document Format).

The files are named in the following method: XXXX_YYYYYYYY_ZZZZZZ.tif, where X is the sender's information, Y is the date, and Z is the time that the fax was received.

 **NOTE:** Fax to Computer is available for receiving black-and-white faxes only. Color faxes will be printed.

HP Digital Fax requirements

- The destination folder of the computer must be available at all times. Faxes will not be saved if the computer is asleep or in hibernate mode.
- Paper must be loaded in the input tray. For more information, see [Load paper](#) .

To set up or modify HP Digital Fax (Windows)

1. Open the HP printer software. For more information, see [Open the HP printer software \(Windows\)](#) .
2. In the printer software, under **Print, Scan & Fax** , click **Fax** , and then click **Digital Fax Setup Wizard** .
3. Follow the onscreen instructions.

To set up or modify HP Digital Fax (OS X)

1. Open HP Utility. For more information, see [HP Utility \(OS X\)](#).
2. Select the printer.
3. Click **Digital Fax Archive** in the Fax Settings section.

To turn off HP Digital Fax

1. From the printer control panel display, touch **Fax**.
2. Touch **Setup**.
3. Touch **Preferences** and then touch **HP Digital Fax**.
4. Touch **Turn Off HP Digital Fax**.
5. Touch **Yes**.

Set up phone book contacts

You can set up frequently used fax numbers as phone book contacts. This lets you quickly dial those numbers using the printer control panel.



 **TIP:** In addition to creating and managing phone book contacts from the printer control panel, you can also use tools available on your computer, such as the HP printer software and the printer EWS. For more information, see [Printer management tools](#).

- [Create and edit a phone book contact](#)
- [Create and edit a group phone book contact](#)
- [Delete phone book contacts](#)
- [Print a list of phone book contacts](#)

Create and edit a phone book contact

You can store fax numbers as phone book contacts.



To set up phone book contacts

1. From the printer control panel display, touch **Fax**.
2. Touch **Send Now**.
3. Touch  (**Phone book**), and then touch **Contacts**.
4. Touch  (**Plus Sign**) to add a contact.
5. Touch **Name**, and then enter the name of the phone book contact, and then touch **Done**.
6. Touch **Fax Number**, and then enter the fax number for the phone book contact, and then touch **Done**.

 **NOTE:** Be sure to include any pauses or other required numbers, such as an area code, an access code for numbers outside a PBX system (usually a 9 or 0), or a long-distance prefix.

7. Touch **Add**.

To change phone book contacts

1. From the printer control panel display, touch **Fax** .
2. Touch **Send Now**.
3. Touch  (**Phone book**).
4. Touch **Contacts**.
5. Touch  (**Edit**) to edit a contact.
6. Touch the phone book contact that you want to edit.
7. Touch **Name** and then edit the name of the Phone Book contact, and then touch **Done** .
8. Touch **Number** and edit the fax number for the phone book contact, and then touch **OK**.

 **NOTE:** Be sure to include any pauses or other required numbers, such as an area code, an access code for numbers outside a PBX system (usually a 9 or 0), or a long-distance prefix.



9. Touch **Done** .

Create and edit a group phone book contact



You can store groups of fax numbers as group phone book contacts.

To set up group phone book contacts

 **NOTE:** Before you can create a group phone book contact, you must have already created at least one phone book contact.

1. From the printer control panel display, touch **Fax** .
2. Touch **Send Now**.
3. Touch  (**Phone book**).
4. Touch **Group Contacts**.
5. Touch  (**Plus Sign**) to add a group.
6. Touch **Name** and then type the name of the group, and then touch **Done** .
7. Touch **Number**, select the phone book contacts you want to include in this group, and then touch **Select**.
8. Touch **Create**.



To change group phone book contacts

1. From the printer control panel display, touch **Fax** .
2. Touch **Send Now**.
3. Touch  (**Phone book**).
4. Touch **Group Contacts**.
5. Touch  (**Edit**) to edit a group.

6. Touch the group phone book contact that you want to edit.
7. Touch **Name** and then edit the name of the group phone book contact, and then touch **Done** .
8. Touch **Number** .
9. Deselect the phone book contacts you want to delete from this group, or touch  (**Plus Sign**) to add a contact to the group.
10. Touch **Done** .

Delete phone book contacts

You can delete phone book contacts or group phone book contacts.

1. From the printer control panel display, touch **Fax** .
2. Touch **Send Now**.
3. Touch  (**Phone book**).
4. Touch **Contacts** or **Group Contacts**.
5. Touch  (**Edit**).
6. Touch the name of the phone book contact or group contact you want to delete.
7. Touch **Delete**.
8. Touch **Yes** to confirm.

Print a list of phone book contacts

You can print a list of your phone book contacts.

1. Load paper in the tray. For more information, see [Load paper](#) .
2. From the printer control panel display, touch **Fax** .
3. Touch **Setup** , and then touch **Reports** .
4. Touch **Print Phone Book**.

Change fax settings

After completing the steps in the getting started guide that came with the printer, use the following steps to change the initial settings or to configure other options for faxing.

- [Configure the fax header](#)
- [Set the answer mode \(Auto answer\)](#)
- [Set the number of rings before answering](#)
- [Change the answer ring pattern for distinctive ring](#)
- [Set the dial type](#)
- [Set the redial options](#)
- [Set the fax speed](#)

- [Set the fax sound volume](#)

Configure the fax header

The fax header prints your name and fax number on the top of every fax you send. HP recommends that you set up the fax header by using the HP printer software. You can also set up the fax header from the printer control panel, as described here.



NOTE: In some countries/regions, the fax header information is a legal requirement.

To set or change the fax header

1. From the printer control panel display, touch **Fax** .
2. Touch **Setup** , and then touch **Preferences** .
3. Touch **Fax Header**.
4. Enter your personal or company name, and then touch **Done** .
5. Enter your fax number, and then touch **Done** .

Set the answer mode (Auto answer)

The answer mode determines whether the printer answers incoming calls.

- Turn on the **Auto Answer** setting if you want the printer to answer faxes **automatically**. The printer answers all incoming calls and faxes.
- Turn off the **Auto Answer** setting if you want to receive faxes **manually**. You must be available to respond in person to the incoming fax call or else the printer does not receive faxes.

To set the answer mode

1. From the printer control panel display, touch **Fax** .
2. Touch **Setup** , and then touch **Preferences** .
3. Touch **Auto Answer** to turn it on or off.

Set the number of rings before answering

If you turn on the **Auto Answer** setting, you can specify how many rings occur before incoming calls are automatically answered.

The **Rings to Answer** setting is important if you have an answering machine on the same phone line as the printer, because you want the answering machine to answer the phone before the printer does. The number of rings to answer for the printer should be greater than the number of rings to answer for the answering machine.

For example, set your answering machine to a low number of rings and the printer to answer in the maximum number of rings. (The maximum number of rings varies by country/region.) In this setup, the answering machine answers the call and the printer monitors the line. If the printer detects fax tones, it receives the fax. If the call is a voice call, the answering machine records the incoming message.

To set the number of rings before answering

1. From the printer control panel display, touch **Fax** .
2. Touch **Setup** , and then touch **Preferences** .

3. Touch **Rings to Answer** .
4. Touch to set the number of rings.
5. Touch **Done** .

Change the answer ring pattern for distinctive ring

Many phone companies offer a distinctive ring feature that allows you to have several phone numbers on one phone line. When you subscribe to this service, each number is assigned a different ring pattern. You can set up the printer to answer incoming calls that have a specific ring pattern.

If you connect the printer to a line with distinctive ring, have your telephone company assign one ring pattern to voice calls and another ring pattern to fax calls. HP recommends that you request double or triple rings for a fax number. When the printer detects the specified ring pattern, it answers the call and receives the fax.

 **TIP:** You can also use the Ring Pattern Detection feature in the printer control panel to set distinctive ring. With this feature, the printer recognizes and records the ring pattern of an incoming call and, based on this call, automatically determines the distinctive ring pattern assigned by your telephone company to fax calls.

If you do not have a distinctive ring service, use the default ring pattern, which is **All Standard Rings** .

 **NOTE:** The printer cannot receive faxes when the main phone number is off the hook.

To change the answer ring pattern for distinctive ring

1. Ensure that the printer is set to answer fax calls automatically.
For more information, see [Set the answer mode \(Auto answer\)](#) .
2. From the printer control panel display, touch **Fax** .
3. Touch **Setup** , and then select **Preferences** .
4. Touch **Distinctive Ring** .
5. A message appears stating that this setting should not be changed unless you have multiple numbers on the same telephone line. Touch **Yes** to continue.
6. Select the ring pattern assigned by your telephone company for fax calls.

If you do not know your assigned ring pattern or it is not in the list, touch **Ring Pattern Detection**, and then follow the onscreen instructions.

 **NOTE:** If the Ring Pattern Detection feature cannot detect the ring pattern or if you cancel the feature before it finishes, the ring pattern is automatically set to the default, which is **All Standard Rings** .

 **NOTE:** If you are using a PBX phone system that has different ring patterns for internal and external calls, you must call the fax number from an external number.

Set the dial type

Use this procedure to set tone-dialing or pulse-dialing mode. The factory-set default is **Tone**. Do not change the setting unless you know that your phone line cannot use tone dialing.

 **NOTE:** The pulse-dialing option is not available in all countries/regions.

To set the dial type

1. From the printer control panel display, touch **Fax** .
2. Touch **Setup** , and then touch **Preferences** .
3. Touch **Dial Type**.
4. Touch to select **Tone** or **Pulse**.

Set the redial options

If the printer was unable to send a fax because the receiving fax machine did not answer or was busy, the printer attempts to redial based on the settings for the redial options. Use the following procedure to turn the options on or off.

- **Busy redial:** If this option is turned on, the printer redials automatically if it receives a busy signal. The default is **On** .
- **No answer redial:** If this option is turned on, the printer redials automatically if the receiving fax machine does not answer. The default is **Off** .
- **Connection problem redial:** If this option is turned on, the printer redials automatically if there has been a problem connecting with the receiving fax machine. Connection problem redial works only for sending faxes from memory. The default is **On** .

To set the redial options

1. From the printer control panel display, touch **Fax** .
2. Touch **Setup** , and then touch **Preferences** .
3. Touch **Auto Redial** .
4. Touch **Busy Redial** , **No Answer Redial** , or **Connection Problem Redial** to switch it on or off.

Set the fax speed

You can set the fax speed used to communicate between your printer and other fax machines when sending and receiving faxes.

If you use one of the following, setting the fax speed to a slower speed might be required:

- An Internet phone service
- A PBX (private branch exchange) system
- Fax on Voice over Internet Protocol (VoIP)
- An integrated services digital network (ISDN) service

If you experience problems sending and receiving faxes, try using a slower **Speed** . The following table provides the available fax speed settings.

Fax speed setting	Fax speed
Fast	v.34 (33600 bps)
Medium	v.17 (14400 bps)
Slow	v.29 (9600 bps)

To set the fax speed

1. From the printer control panel display, touch **Fax** .
2. Touch **Setup** , and then touch **Preferences** .
3. Touch **Speed** .
4. Touch to select an option.

Set the fax sound volume

You can change the volume of fax sounds.

To set the fax sound volume

1. From the printer control panel display, touch **Fax** .
2. Touch **Setup** , and then touch **Preferences** .
3. Touch **Volume**.
4. Touch to select **Soft**, **Loud**, or **Off** .

You may also access this feature by pressing  (the **Fax Status** button) on the Home screen.

Fax and digital phone services

Many telephone companies provide their customers with digital phone services, such as the following:

- DSL: A Digital subscriber line (DSL) service through your telephone company. (DSL might be called ADSL in your country/region.)
- PBX: A private branch exchange (PBX) phone system.
- ISDN: An integrated services digital network (ISDN) system.
- VoIP: A low-cost phone service that allows you to send and receive faxes with your printer by using the Internet. This method is called Fax on Voice over Internet Protocol (VoIP).

For more information, see [Fax on Voice over Internet Protocol](#) .

HP printers are designed specifically for use with traditional analog phone services. If you are in a digital phone environment (such as DSL/ADSL, PBX, or ISDN), you might need to use digital-to-analog filters or converters when setting up the printer for faxing.



NOTE: HP does not guarantee that the printer will be compatible with all digital service lines or providers, in all digital environments, or with all digital-to-analog converters. It is always recommended that you discuss with the telephone company directly for the correct setup options based on their line services provided.

Fax on Voice over Internet Protocol

You might be able to subscribe to a low cost phone service that allows you to send and receive faxes with your printer by using the Internet. This method is called Fax on Voice over Internet Protocol (VoIP).

The following are indications you probably use a VoIP service.

- Dial a special access code along with the fax number.
- Have an IP converter box that connects to the Internet and provides analog phone ports for the fax connection.

 **NOTE:** You can only send and receive faxes by connecting a phone cord to the port labeled "1-LINE" on the printer. This means that your connection to the Internet must be done either through a converter box (which supplies regular analog phone jacks for fax connections) or your telephone company.

 **TIP:** Support for traditional fax transmission over any Internet protocol telephone systems are often limited. If you experience problems faxing, try using a slower fax speed or disabling the fax error-correction mode (ECM). However, if you turn off ECM, you cannot send and receive color faxes.

If you have questions about Internet faxing, contact your Internet faxing services support department or your local service provider for further assistance.

Use reports

You can set up the printer to print error reports and confirmation reports automatically for each fax you send and receive. You can also manually print system reports as required; these reports provide useful system information about the printer.

By default, the printer is set to print a report only if there is a problem sending or receiving a fax. A confirmation message that indicates whether a fax was successfully sent appears briefly on the control panel display after each transaction.

 **NOTE:** If the reports are not legible, you can check the estimated ink levels from the control panel or the HP software. For more information, see [Check the estimated ink levels](#).

 **NOTE:** Ink level alerts and indicators provide estimates for planning purposes only. When you receive a low-ink alert, consider having a replacement cartridge available to avoid possible printing delays. You do not need to replace the cartridges until the print quality becomes unacceptable.

 **NOTE:** Ensure that the printheads and cartridges are in good conditions and installed properly. For more information, see [Work with cartridges](#).

This section contains the following topics:

- [Print fax confirmation reports](#)
- [Print fax error reports](#)
- [Print and view the fax log](#)
- [Clear the fax log](#)
- [Print the details of the last fax transaction](#)
- [Print a Caller ID Report](#)
- [View the Call History](#)

Print fax confirmation reports

You can print a confirmation report either when a fax is sent, or when any fax is sent or received. The default setting is **On (Fax Send)**. When turned off, a confirmation message appears briefly on the control panel after each fax is sent or received.

To enable fax confirmation

1. From the printer control panel display, touch **Fax** .
2. Touch **Setup** .
3. Touch **Reports** and touch **Fax Confirmation** .
4. Touch to select one of the following options.

Off	Does not print a fax confirmation report when you send and receive faxes successfully. This is the default setting.
On (Fax Send)	Prints a fax confirmation report for every fax you send.
On (Fax Receive)	Prints a fax confirmation report for every fax you receive.
On (Fax Send and Fax Receive)	Prints a fax confirmation report for every fax you send and receive.

To include an image of the fax on the report

1. From the printer control panel display, touch **Fax** .
2. Touch **Setup** .
3. Touch **Reports** and touch **Fax Confirmation** .
4. Touch **On (Fax Send)** or **On (Fax Send and Fax Receive)** .
5. Touch **Confirmation with Image**.
6. Touch **OK**.

Print fax error reports

You can configure the printer so that it automatically prints a report when there is an error during transmission or reception.

To set the printer to print fax error reports automatically

1. From the printer control panel display, touch **Fax** .
2. Touch **Setup** .
3. Touch **Reports** and touch **Fax Error Reports**.
4. Touch to select one of the following.

On (Fax Send and Fax Receive)	Prints whenever a fax error occurs.
Off	Does not print any fax error reports.
On (Fax Send)	Prints whenever a transmission error occurs. This is the default setting.
On (Fax Receive)	Prints whenever a receiving error occurs.

Print and view the fax log

You can print a log of faxes that have been received and sent by the printer.

To print the fax log from the printer control panel

1. From the printer control panel display, touch **Fax** .
2. Touch **Setup** , and then touch **Reports** .
3. Touch **Print Fax Reports** .
4. Touch **Last 30 Transactions Fax Logs** .
5. Touch **Print** to begin printing.

Clear the fax log

Clearing the fax log also deletes all faxes stored in memory.

To clear the fax log

1. From the printer control panel display, touch **Fax** .
2. Touch **Setup** , and then touch **Tools**.
3. Touch **Clear Fax Logs**.

Print the details of the last fax transaction

The Last Fax Transaction report prints the details of the last fax transaction to occur. Details include the fax number, number of pages, and the fax status.

To print the Last Fax Transaction report

1. From the printer control panel display, touch **Fax** .
2. Touch **Setup** , and then touch **Reports** .
3. Touch **Print Fax Reports** .
4. Touch **Last Transaction Log**.
5. Touch **Print** to begin printing.

Print a Caller ID Report

You can print a list of Caller ID fax numbers.

To print a Caller ID History Report

1. From the printer control panel display, touch **Fax** .
2. Touch **Setup** , and then touch **Reports** .
3. Touch **Print Fax Reports** .
4. Touch **Caller ID Report**.
5. Touch **Print** to begin printing.



View the Call History

You can view a list of all the calls placed from the printer.



NOTE: You cannot print the call history.

To view the call history

1. From the printer control panel display, touch **Fax**.
2. Touch **Send Now**.
3. Touch  (**Phone book**).
4. Touch  (**Call history**).

Additional fax setup

After completing all the steps in the Getting Started Guide, use the instructions in this section to complete your fax setup. Keep your Getting Started Guide for later use.

In this section, you learn how to set up the printer so that faxing works successfully with equipment and services you might already have on the same phone line.

 **TIP:** You can also use the Fax Setup Wizard (Windows) or HP Utility (OS X) to help you quickly set up some important fax settings such as the answer mode and fax header information. You can access these tools through the HP printer software. After you run these tools, follow the procedures in this section to complete your fax setup.

This section contains the following topics:

- [Set up faxing \(parallel phone systems\)](#)
- [Test fax setup](#)

Set up faxing (parallel phone systems)

Before you begin setting up the printer for faxing, determine which kind of phone system your country/region uses. The instructions for fax setup differ depending on whether you have a serial- or parallel-type phone system.

- If you do not see your country/region listed in the table, you probably have a serial-type phone system. In a serial-type phone system, the connector type on your shared telephone equipment (modems, phones, and answering machines) does not allow a physical connection to the "2-EXT" port on the printer. Instead, all equipment must be connected at the telephone wall jack.

 **NOTE:** You might need to connect the phone cord to your country/region adapter.

- If your country/region is listed in the table, you probably have a parallel-type telephone system. In a parallel-type phone system, you are able to connect shared telephone equipment to the phone line by using the "2-EXT" port on the back of the printer.

 **NOTE:** If you have a parallel-type phone system, HP recommends you connect a 2-wire phone cord to the telephone wall jack.

Table 5-1 Countries/regions with a parallel-type phone system

Argentina	Australia	Brazil
Canada	Chile	China
Colombia	Greece	India
Indonesia	Ireland	Japan

Table 5-1 Countries/regions with a parallel-type phone system (continued)

Korea	Latin America	Malaysia
Mexico	Philippines	Poland
Portugal	Russia	Saudi Arabia
Singapore	Spain	Taiwan
Thailand	USA	Venezuela
Vietnam		

If you are unsure which kind of telephone system you have (serial or parallel), check with your telephone company.

This section contains the following topics:

- [Select the correct fax setup for your home or office](#)
- [Case A: Separate fax line \(no voice calls received\)](#)
- [Case B: Set up the printer with DSL](#)
- [Case C: Set up the printer with a PBX phone system or an ISDN line](#)
- [Case D: Fax with a distinctive ring service on the same line](#)
- [Case E: Shared voice/fax line](#)
- [Case F: Shared voice/fax line with voice mail](#)
- [Case G: Fax line shared with computer modem \(no voice calls received\)](#)
- [Case H: Shared voice/fax line with computer modem](#)
- [Case I: Shared voice/fax line with answering machine](#)
- [Case J: Shared voice/fax line with computer modem and answering machine](#)
- [Case K: Shared voice/fax line with computer dial-up modem and voice mail](#)

Select the correct fax setup for your home or office

To fax successfully, you need to know what types of equipment and services (if any) share the same phone line with the printer. This is important because you might need to connect some of your existing office equipment directly to the printer, and you might also need to change some fax settings before you can fax successfully.

1. Determine if your telephone system is serial or parallel.
For more information, see [Set up faxing \(parallel phone systems\)](#).
 - a. Serial-type telephone system.
 - b. Parallel-type telephone system—Go to step 2.
2. Select the combination of equipment and services sharing your fax line.
 - DSL: A Digital subscriber line (DSL) service through your telephone company. (DSL might be called ADSL in your country/region.)
 - PBX: A private branch exchange (PBX) phone system.

- ISDN: An integrated services digital network (ISDN) system.
 - Distinctive ring service: A distinctive ring service through your telephone company provides multiple telephone numbers with different ring patterns.
 - Voice calls: Voice calls are received at the same phone number you use for fax calls on the printer.
 - Computer dial-up modem: A computer dial-up modem is on the same phone line as the printer. If you answer Yes to any of the following questions, you are using a computer dial-up modem:
 - Do you send and receive faxes directly to and from your computer software applications through a dial-up connection?
 - Do you send and receive email messages on your computer through a dial-up connection?
 - Do you access the Internet from your computer through a dial-up connection?
 - Answering machine: An answering machine that answers voice calls at the same phone number you use for fax calls on the printer.
 - Voice mail service: A voice mail subscription through your telephone company at the same number you use for fax calls on the printer.
3. From the following table, select the combination of equipment and services applicable to your home or office setting. Then look up the recommended fax setup. Step-by-step instructions are included for each case in the sections that follow.



NOTE: You might need to connect the phone cord to your country/region adapter.

Other equipment or services sharing your fax line							Recommended fax setup
DSL	PBX	Distinctive ring service	Voice calls	Computer dial-up modem	Answering machine	Voice mail service	
							Case A: Separate fax line (no voice calls received)
✓							Case B: Set up the printer with DSL
	✓						Case C: Set up the printer with a PBX phone system or an ISDN line
		✓					Case D: Fax with a distinctive ring service on the same line
			✓				Case E: Shared voice/fax line
			✓			✓	Case F: Shared voice/fax line with voice mail
				✓			Case G: Fax line shared with computer modem (no voice calls received)
			✓	✓			Case H: Shared voice/fax line with computer modem

Other equipment or services sharing your fax line							Recommended fax setup
DSL	PBX	Distinctive ring service	Voice calls	Computer dial-up modem	Answering machine	Voice mail service	
			✓		✓		Case I: Shared voice/fax line with answering machine
			✓	✓	✓		Case J: Shared voice/fax line with computer modem and answering machine
			✓	✓		✓	Case K: Shared voice/fax line with computer dial-up modem and voice mail

Case A: Separate fax line (no voice calls received)

If you have a separate phone line on which you receive no voice calls, and you have no other equipment connected on this phone line, set up the printer as described in this section.

Figure 5-1 Back view of the printer

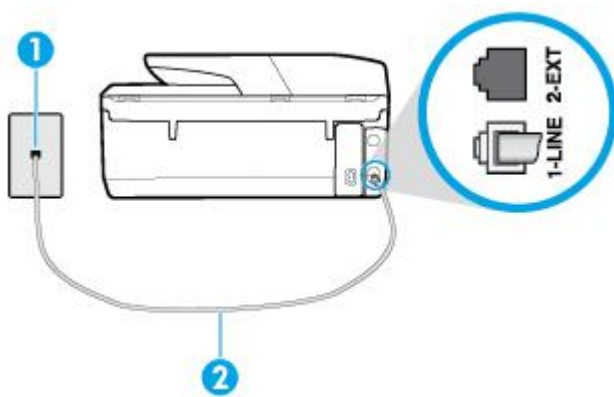

1	Telephone wall jack.
2	Connect the phone cord to the port labelled 1-LINE on the back of the printer. You might need to connect the phone cord to your country/region adapter.

To set up the printer with a separate fax line

1. Connect one end of the phone cord to your telephone wall jack, then connect the other end to the port labeled 1-LINE on the back of the printer.



NOTE: You might need to connect the phone cord to your country/region adapter.

2. Turn on the **Auto Answer** setting.
3. (Optional) Change the **Rings to Answer** setting to the lowest setting (two rings).
4. Run a fax test.

When the phone rings, the printer answers automatically after the number of rings you set in the **Rings to Answer** setting. The printer begins emitting fax reception tones to the sending fax machine and receives the fax.

Case B: Set up the printer with DSL

If you have a DSL service through your telephone company, and do not connect any equipment to the printer, use the instructions in this section to connect a DSL filter between the telephone wall jack and the printer. The DSL filter removes the digital signal that can interfere with the printer, so the printer can communicate correctly with the phone line. (DSL might be called ADSL in your country/region.)

 **NOTE:** If you have a DSL line and you do not connect the DSL filter, you cannot send and receive faxes with the printer.

Figure 5-2 Back view of the printer



1	Telephone wall jack.
2	DSL (or ADSL) filter and cord supplied by your DSL provider.
3	Connect the phone cord to the port labelled 1-LINE on the back of the printer. You might need to connect the phone cord to your country/region adapter.

To set up the printer with DSL

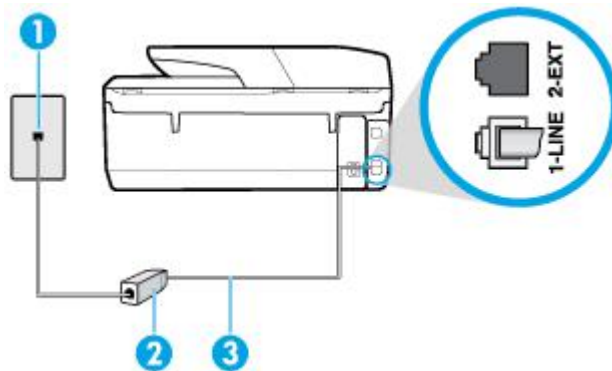
1. Obtain a DSL filter from your DSL provider.
2. Connect one end of the phone cord to the DSL filter, and then connect the other end to the port labeled 1-LINE on the back of the printer.

 **NOTE:** You might need to connect the phone cord to your country/region adapter.

You might need to obtain additional phone cords for this setup.

3. Connect an additional phone cord from the DSL filter to the telephone wall jack.
4. Run a fax test.

If you encounter problems setting up the printer with optional equipment, contact your local service provider or vendor for further assistance.

Case C: Set up the printer with a PBX phone system or an ISDN line

If you are using either a PBX phone system or an ISDN converter/terminal adapter, make sure you do the following:

- If you are using either a PBX or an ISDN converter/terminal adaptor, connect the printer to the port that is designated for fax and phone use. Also, make sure that the terminal adapter is set to the correct switch type for your country/region, if possible.

 **NOTE:** Some ISDN systems allow you to configure the ports for specific phone equipment. For example, you might have assigned one port for telephone and Group 3 fax and another port for multiple purposes. If you have problems when connected to the fax/phone port of your ISDN converter, try using the port designated for multiple purposes; it might be labeled "multi-combi" or something similar.

- If you are using a PBX phone system, set the call waiting tone to "off."

 **NOTE:** Many digital PBX systems include a call-waiting tone that is set to "on" by default. The call waiting tone interferes with any fax transmission, and you cannot send or receive faxes with the printer. Refer to the documentation that came with your PBX phone system for instructions on how to turn off the call-waiting tone.

- If you are using a PBX phone system, dial the number for an outside line before dialing the fax number.
- You might need to connect the phone cord to your country/region adapter.

If you encounter problems setting up the printer with optional equipment, contact your local service provider or vendor for further assistance.

Case D: Fax with a distinctive ring service on the same line

If you subscribe to a distinctive ring service (through your telephone company) that allows you to have multiple phone numbers on one phone line, each with a different ring pattern, set up the printer as described in this section.

Figure 5-3 Back view of the printer

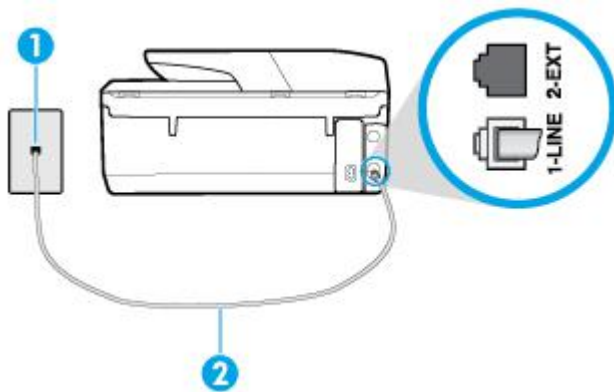

1	Telephone wall jack.
2	Connect the phone cord to the port labelled 1-LINE on the back of the printer. You might need to connect the phone cord to your country/region adapter.

To set up the printer with a distinctive ring service

1. Connect one end of the phone cord to your telephone wall jack, then connect the other end to the port labeled 1-LINE on the back of the printer.

 **NOTE:** You might need to connect the phone cord to your country/region adapter.

2. Turn on the **Auto Answer** setting.
3. Change the **Distinctive Ring** setting to match the pattern that the telephone company assigned to your fax number.

 **NOTE:** By default, the printer is set to answer all ring patterns. If you do not set the **Distinctive Ring** to match the ring pattern assigned to your fax number, the printer might answer both voice calls and fax calls or it might not answer at all.

 **TIP:** You can also use the Ring Pattern Detection feature in the printer control panel to set distinctive ring. With this feature, the printer recognizes and records the ring pattern of an incoming call and, based on this call, automatically determines the distinctive ring pattern assigned by your telephone company to fax calls. For more information, see [Change the answer ring pattern for distinctive ring](#).

4. (Optional) Change the **Rings to Answer** setting to the lowest setting (two rings).
5. Run a fax test.

The printer automatically answers incoming calls that have the ring pattern you selected (**Distinctive Ring** setting) after the number of rings you selected (**Rings to Answer** setting). The printer begins emitting fax reception tones to the sending fax machine and receives the fax.

If you encounter problems setting up the printer with optional equipment, contact your local service provider or vendor for further assistance.

Case E: Shared voice/fax line

If you receive both voice calls and fax calls at the same phone number, and you have no other office equipment (or voice mail) on this phone line, set up the printer as described in this section.

Figure 5-4 Back view of the printer

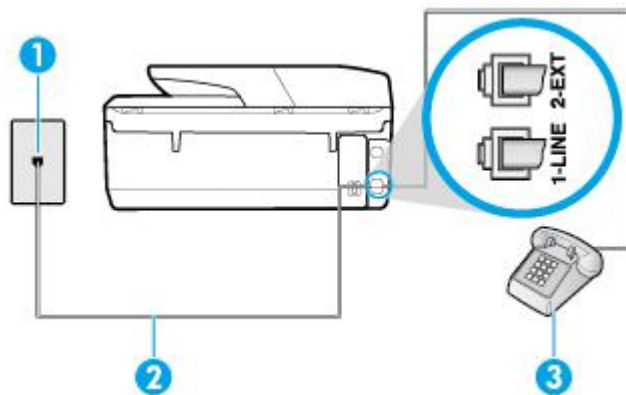

1	Telephone wall jack.
2	Connect the phone cord to the port labelled 1-LINE on the back of the printer. You might need to connect the phone cord to your country/region adapter.
3	Telephone (optional).

To set up the printer with a shared voice/fax line

1. Connect one end of the phone cord to your telephone wall jack, then connect the other end to the port labeled 1-LINE on the back of the printer.

 **NOTE:** You might need to connect the phone cord to your country/region adapter.

2. Do one of the following:

- If you have a parallel-type phone system, remove the white plug from the port labeled 2-EXT on the back of the printer, and then connect a phone to this port.
 - If you have a serial-type phone system, you might plug your phone directly on top of the printer cable which has a wall plug attached to it.
3. Now you need to decide how you want the printer to answer calls, automatically or manually:
- If you set up the printer to answer calls **automatically**, it answers all incoming calls and receives faxes. The printer cannot distinguish between fax and voice calls in this case; if you suspect the call is a voice call, you need to answer it before the printer answers the call. To set up the printer to answer calls automatically, turn on the **Auto Answer** setting.
 - If you set up the printer to answer faxes **manually**, you must be available to respond in person to incoming fax calls or the printer cannot receive faxes. To set up the printer to answer calls manually, turn off the **Auto Answer** setting.
4. Run a fax test.

If you pick up the phone before the printer answers the call and hear fax tones from a sending fax machine, you need to answer the fax call manually.

If you encounter problems setting up the printer with optional equipment, contact your local service provider or vendor for further assistance.

Case F: Shared voice/fax line with voice mail

If you receive both voice calls and fax calls at the same phone number, and you also subscribe to a voice mail service through your telephone company, set up the printer as described in this section.

NOTE: You cannot receive faxes automatically if you have a voice mail service at the same phone number you use for fax calls. You must receive faxes manually; this means you must be available to respond in person to incoming fax calls. If you want to receive faxes automatically instead, contact your telephone company to subscribe to a distinctive ring service, or to obtain a separate phone line for faxing.

Figure 5-5 Back view of the printer

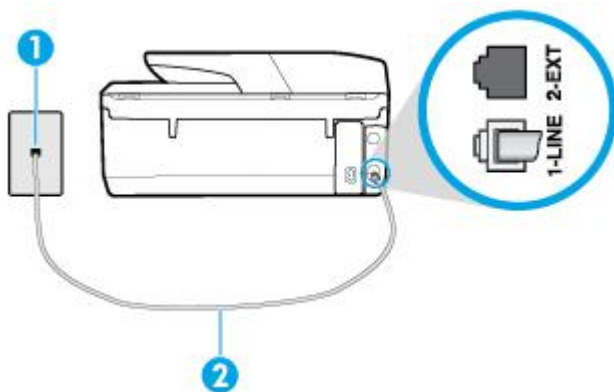

1	Telephone wall jack.
2	Connect the phone cord to the port labelled 1-LINE on the back of the printer. You might need to connect the phone cord to your country/region adapter.

To set up the printer with voice mail

1. Connect one end of the phone cord to your telephone wall jack, then connect the other end to the port labeled 1-LINE on the back of the printer.

 **NOTE:** You might need to connect the phone cord to your country/region adapter.

2. Turn off the **Auto Answer** setting.
3. Run a fax test.

You must be available to respond in person to incoming fax calls, or the printer cannot receive faxes. You must initiate the manual fax before voicemail picks up the line.

If you encounter problems setting up the printer with optional equipment, contact your local service provider or vendor for further assistance.

Case G: Fax line shared with computer modem (no voice calls received)

If you have a fax line on which you receive no voice calls, and you also have a computer modem connected on this line, set up the printer as described in this section.

 **NOTE:** If you have a computer dial-up modem, your computer dial-up modem shares the phone line with the printer. You cannot use both your modem and the printer simultaneously. For example, you cannot use the printer for faxing while you are using your computer dial-up modem to send an email or access the Internet.

- [Set up the printer with a computer dial-up modem](#)
- [Set up the printer with a computer DSL/ADSL modem](#)

Set up the printer with a computer dial-up modem

If you are using the same phone line for sending faxes and for a computer dial-up modem, follow these directions for setting up the printer.

Figure 5-6 Back view of the printer

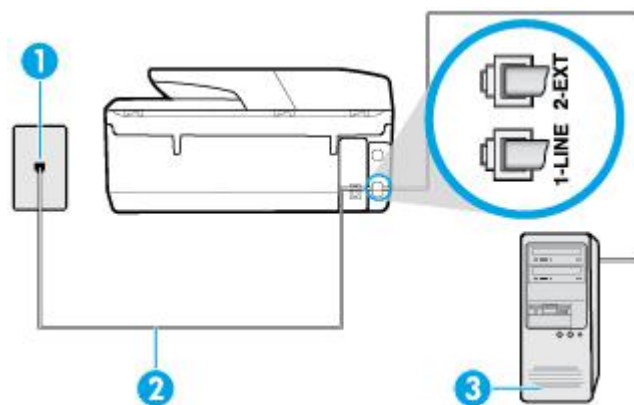

1	Telephone wall jack.
2	Connect the phone cord to the port labelled 1-LINE on the back of the printer. You might need to connect the phone cord to your country/region adapter.
3	Computer with modem.

To set up the printer with a computer dial-up modem

1. Remove the white plug from the port labeled 2-EXT on the back of the printer.
2. Find the phone cord that connects from the back of your computer (your computer dial-up modem) to a telephone wall jack. Disconnect the cord from the telephone wall jack and plug it into the port labeled 2-EXT on the back of the printer.
3. Connect one end of the phone cord to your telephone wall jack, then connect the other end to the port labeled 1-LINE on the back of the printer.

 **NOTE:** You might need to connect the phone cord to your country/region adapter.

4. If your modem software is set to receive faxes to your computer automatically, turn off that setting.

 **NOTE:** If you do not turn off the automatic fax reception setting in your modem software, the printer cannot receive faxes.

5. Turn on the **Auto Answer** setting.
6. (Optional) Change the **Rings to Answer** setting to the lowest setting (two rings).
7. Run a fax test.

When the phone rings, the printer automatically answers after the number of rings you set in the **Rings to Answer** setting. The printer begins emitting fax reception tones to the sending fax machine and receives the fax.

If you encounter problems setting up the printer with optional equipment, contact your local service provider or vendor for further assistance.

Set up the printer with a computer DSL/ADSL modem

If you have a DSL line and use that phone line to send faxes, follow these instructions to set up your fax.

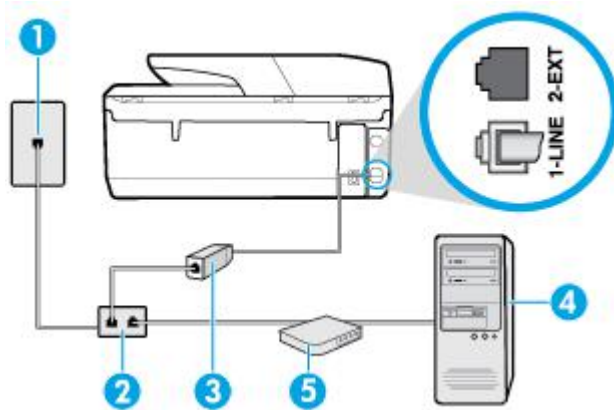

1	Telephone wall jack.
2	Parallel splitter.
3	DSL/ADSL filter. Connect one end of the phone cord to the 1-LINE port on the back of the printer. Connect the other end of the cord to the DSL/ADSL filter. You might need to connect the phone cord to your country/region adapter.

4	Computer.
5	Computer DSL/ADSL modem.



 **NOTE:** You need to purchase a parallel splitter. A parallel splitter has one RJ-11 port on the front and two RJ-11 ports on the back. Do not use a 2-line phone splitter, a serial splitter, or a parallel splitter which has two RJ-11 ports on the front and a plug on the back.

Figure 5-7 Example of a parallel splitter



To set up the printer with a computer DSL/ADSL modem

1. Obtain a DSL filter from your DSL provider.
2. Connect one end of the phone cord to the DSL filter, and then connect the other end to the port labeled 1-LINE on the back of the printer.

 **NOTE:** You might need to connect the phone cord to your country/region adapter.

3. Connect the DSL filter to the parallel splitter.
4. Connect the DSL modem to the parallel splitter.
5. Connect the parallel splitter to the wall jack.
6. Run a fax test.

When the phone rings, the printer automatically answers after the number of rings you set in the **Rings to Answer** setting. The printer begins emitting fax reception tones to the sending fax machine and receives the fax.

If you encounter problems setting up the printer with optional equipment, contact your local service provider or vendor for further assistance.

Case H: Shared voice/fax line with computer modem

There are two different ways to set up the printer with your computer based on the number of phone ports on your computer. Before you begin, check your computer to see if it has one or two phone ports.

- [Shared voice/fax with computer dial-up modem](#)
- [Shared voice/fax with computer DSL/ADSL modem](#)

Shared voice/fax with computer dial-up modem

If you use your phone line for both fax and telephone calls, use these instructions to set up your fax.

There are two different ways to set up the printer with your computer based on the number of phone ports on your computer. Before you begin, check your computer to see if it has one or two phone ports.

 **NOTE:** If your computer has only one phone port, you need to purchase a parallel splitter (also called a coupler), as shown in the illustration. (A parallel splitter has one RJ-11 port on the front and two RJ-11 ports on the back. Do not use a two-line phone splitter, a serial splitter, or a parallel splitter which has two RJ-11 ports on the front and a plug on the back.)

Figure 5-8 Example of a parallel splitter



Figure 5-9 Back view of the printer

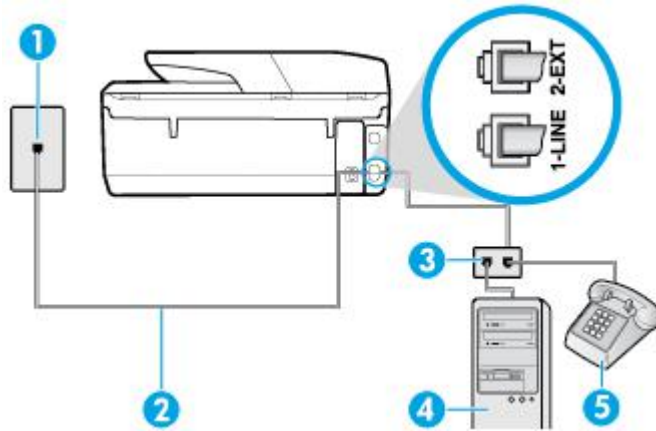

1	Telephone wall jack.
2	Connect the phone cord to the port labelled 1-LINE on the back of the printer.
3	Parallel splitter.
4	Computer with modem.
5	Telephone.

To set up the printer on the same phone line as a computer with two phone ports

1. Remove the white plug from the port labeled 2-EXT on the back of the printer.
2. Find the phone cord that connects from the back of your computer (your computer dial-up modem) to a telephone wall jack. Disconnect the cord from the telephone wall jack and plug it into the port labeled 2-EXT on the back of the printer.
3. Connect a phone to the "OUT" port on the back of your computer dial-up modem.
4. Connect one end of the phone cord to your telephone wall jack, then connect the other end to the port labeled 1-LINE on the back of the printer.

 **NOTE:** You might need to connect the phone cord to your country/region adapter.

5. If your modem software is set to receive faxes to your computer automatically, turn off that setting.

 **NOTE:** If you do not turn off the automatic fax reception setting in your modem software, the printer cannot receive faxes.

6. Now you need to decide how you want the printer to answer calls, automatically or manually:
 - If you set up the printer to answer calls **automatically**, it answers all incoming calls and receives faxes. The printer cannot distinguish between fax and voice calls in this case; if you suspect the call

is a voice call, you need to answer it before the printer answers the call. To set up the printer to answer calls automatically, turn on the **Auto Answer** setting.

- If you set up the printer to answer faxes **manually**, you must be available to respond in person to incoming fax calls or the printer cannot receive faxes. To set up the printer to answer calls manually, turn off the **Auto Answer** setting.

7. Run a fax test.

If you pick up the phone before the printer answers the call and hear fax tones from a sending fax machine, you need to answer the fax call manually.

If you use your phone line for voice, fax, and your computer dial-up modem, follow these directions to set up your fax.

If you encounter problems setting up the printer with optional equipment, contact your local service provider or vendor for further assistance.

Shared voice/fax with computer DSL/ADSL modem

Use these instructions if your computer has a DSL/ADSL modem

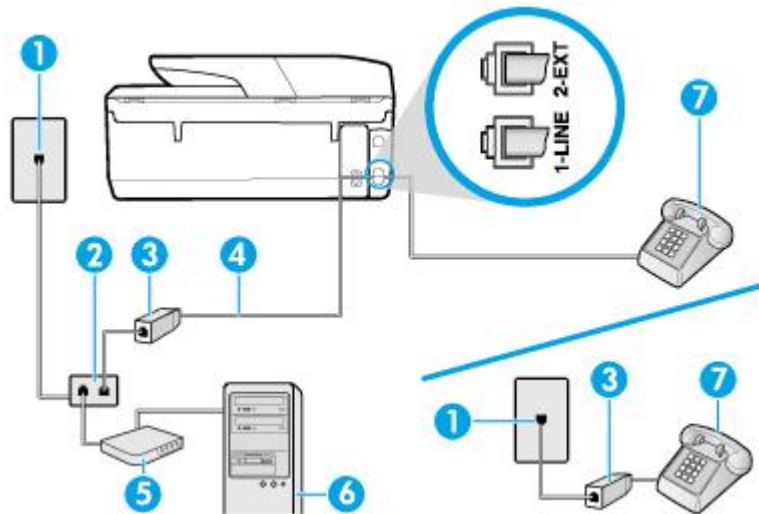

1	Telephone wall jack.
2	Parallel splitter.
3	DSL/ADSL filter.
4	Connect the phone cord to the port labelled 1-LINE on the back of the printer. You might need to connect the phone cord to your country/region adapter.
5	DSL/ADSL modem.
6	Computer.
7	Telephone.



NOTE: You need to purchase a parallel splitter. A parallel splitter has one RJ-11 port on the front and two RJ-11 ports on the back. Do not use a 2-line phone splitter, a serial splitter, or a parallel splitter which has two RJ-11 ports on the front and a plug on the back.

Figure 5-10 Example of a parallel splitter



To set up the printer with a computer DSL/ADSL modem

1. Obtain a DSL filter from your DSL provider.

 **NOTE:** Phones in other parts of the home/office sharing the same phone number with DSL service need to be connected to additional DSL filters to avoid noise when making voice calls.
2. Connect one end of the phone cord to the DSL filter, and then connect the other end to the port labeled 1-LINE on the back of the printer.

 **NOTE:** You might need to connect the phone cord to your country/region adapter.
3. If you have a parallel-type phone system, remove the white plug from the port labeled 2-EXT on the back of the printer, and then connect a phone to this port.
4. Connect the DSL filter to the parallel splitter.
5. Connect the DSL modem to the parallel splitter.
6. Connect the parallel splitter to the wall jack.
7. Run a fax test.

When the phone rings, the printer automatically answers after the number of rings you set in the **Rings to Answer** setting. The printer begins emitting fax reception tones to the sending fax machine and receives the fax.

If you encounter problems setting up the printer with optional equipment, contact your local service provider or vendor for further assistance.

Case I: Shared voice/fax line with answering machine

If you receive both voice calls and fax calls at the same phone number, and you also have an answering machine that answers voice calls at this phone number, set up the printer as described in this section.

Figure 5-11 Back view of the printer

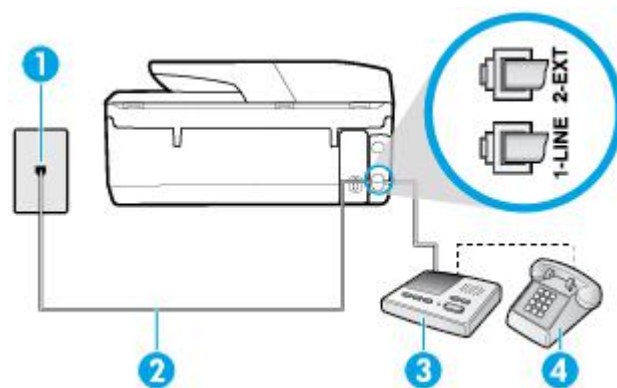

1	Telephone wall jack.
2	Connect the phone cord to the port labelled 1-LINE on the back of the printer. You might need to connect the phone cord to your country/region adapter.

3	Answering machine.
4	Telephone (optional).

To set up the printer with a shared voice/fax line with answering machine

1. Remove the white plug from the port labeled 2-EXT on the back of the printer.
2. Unplug your answering machine from the telephone wall jack, and connect it to the port labeled 2-EXT on the back of the printer.

 **NOTE:** If you do not connect your answering machine directly to the printer, fax tones from a sending fax machine might be recorded on your answering machine, and you might not receive faxes with the printer.

3. Connect one end of the phone cord to your telephone wall jack, then connect the other end to the port labeled 1-LINE on the back of the printer.

 **NOTE:** You might need to connect the phone cord to your country/region adapter.

4. (Optional) If your answering machine does not have a built-in phone, for convenience you might want to connect a phone to the back of your answering machine at the "OUT" port.

 **NOTE:** If your answering machine does not let you connect an external phone, you can purchase and use a parallel splitter (also known as a coupler) to connect both the answering machine and telephone to the printer. You can use standard phone cords for these connections.

5. Turn on the **Auto Answer** setting.
6. Set your answering machine to answer after a low number of rings.
7. Change the **Rings to Answer** setting on the printer to the maximum number of rings supported by your printer. (The maximum number of rings varies by country/region.)
8. Run a fax test.

When the phone rings, your answering machine answers after the number of rings you have set, and then plays your recorded greeting. The printer monitors the call during this time, "listening" for fax tones. If incoming fax tones are detected, the printer emits fax reception tones and receives the fax; if there are no fax tones, the printer stops monitoring the line and your answering machine can record a voice message.

If you encounter problems setting up the printer with optional equipment, contact your local service provider or vendor for further assistance.

Case J: Shared voice/fax line with computer modem and answering machine

If you receive both voice calls and fax calls at the same phone number, and you also have a computer modem and answering machine connected on this phone line, set up the printer as described in this section.

 **NOTE:** Since your computer dial-up modem shares the phone line with the printer, you cannot use both your modem and the printer simultaneously. For example, you cannot use the printer for faxing while you are using your computer dial-up modem to send an email or access the Internet.

- [Shared voice/fax line with computer dial-up modem and answering machine](#)
- [Shared voice/fax line with computer DSL/ADSL modem and answering machine](#)

Shared voice/fax line with computer dial-up modem and answering machine

There are two different ways to set up the printer with your computer based on the number of phone ports on your computer. Before you begin, check your computer to see if it has one or two phone ports.

 **NOTE:** If your computer has only one phone port, you need to purchase a parallel splitter (also called a coupler), as shown in the illustration. (A parallel splitter has one RJ-11 port on the front and two RJ-11 ports on the back. Do not use a two-line phone splitter, a serial splitter, or a parallel splitter which has two RJ-11 ports on the front and a plug on the back.)

Figure 5-12 Example of a parallel splitter



Figure 5-13 Back view of the printer

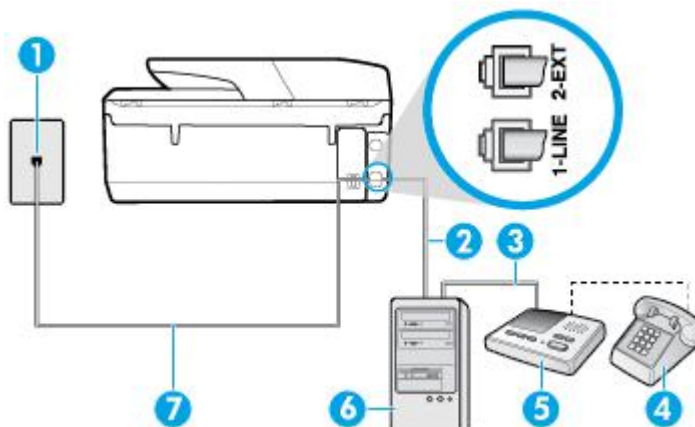

1	Telephone wall jack.
2	"IN" phone port on your computer.
3	"OUT" phone port on your computer.
4	Telephone (optional).
5	Answering machine.
6	Computer with modem.
7	Connect the phone cord to the port labelled 1-LINE on the back of the printer. You might need to connect the phone cord to your country/region adapter.

To set up the printer on the same phone line as a computer with two phone ports

1. Remove the white plug from the port labeled 2-EXT on the back of the printer.
2. Find the phone cord that connects from the back of your computer (your computer dial-up modem) to a telephone wall jack. Disconnect the cord from the telephone wall jack and plug it into the port labeled 2-EXT on the back of the printer.
3. Unplug your answering machine from the telephone wall jack, and connect it to the port labeled "OUT" on the back of the computer (the computer dial-up modem).

- Connect one end of the phone cord to your telephone wall jack, then connect the other end to the port labeled 1-LINE on the back of the printer.

 **NOTE:** You might need to connect the phone cord to your country/region adapter.

- (Optional) If your answering machine does not have a built-in phone, for convenience you might want to connect a phone to the back of your answering machine at the "OUT" port.

 **NOTE:** If your answering machine does not let you connect an external phone, you can purchase and use a parallel splitter (also known as a coupler) to connect both the answering machine and telephone to the printer. You can use standard phone cords for these connections.

- If your modem software is set to receive faxes to your computer automatically, turn off that setting.

 **NOTE:** If you do not turn off the automatic fax reception setting in your modem software, the printer cannot receive faxes.

- Turn on the **Auto Answer** setting.

- Set your answering machine to answer after a low number of rings.

- Change the **Rings to Answer** setting on the printer to the maximum number of rings supported by the product. (The maximum number of rings varies by country/region.)

- Run a fax test.

When the phone rings, your answering machine answers after the number of rings you have set, and then plays your recorded greeting. The printer monitors the call during this time, "listening" for fax tones. If incoming fax tones are detected, the printer emits fax reception tones and receives the fax; if there are no fax tones, the printer stops monitoring the line and your answering machine can record a voice message.

If you encounter problems setting up the printer with optional equipment, contact your local service provider or vendor for further assistance.

Shared voice/fax line with computer DSL/ADSL modem and answering machine

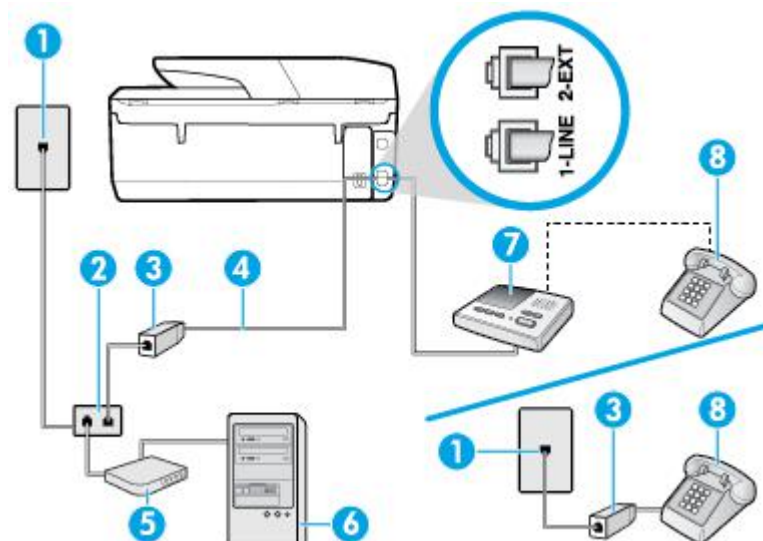

- | | |
|---|----------------------|
| 1 | Telephone wall jack. |
| 2 | Parallel splitter. |
| 3 | DSL/ADSL filter. |

4	Phone cord connected to the 1-LINE port on the back of the printer. You might need to connect the phone cord to your country/region adapter.
5	DSL/ADSL modem.
6	Computer.
7	Answering machine.
8	Telephone (optional).



 **NOTE:** You need to purchase a parallel splitter. A parallel splitter has one RJ-11 port on the front and two RJ-11 ports on the back. Do not use a 2-line phone splitter, a serial splitter, or a parallel splitter which has two RJ-11 ports on the front and a plug on the back.

Figure 5-14 Example of a parallel splitter



To set up the printer with a computer DSL/ADSL modem

1. Obtain a DSL/ADSL filter from your DSL/ADSL provider.

 **NOTE:** Phones in other parts of the home/office sharing the same phone number with DSL/ADSL service need to be connected to additional DSL/ADSL filters, to avoid noise when making voice calls.

2. Connect one end of the phone cord to the DSL/ADSL filter, and then connect the other end to the port labeled 1-LINE on the back of the printer.

 **NOTE:** You might need to connect the phone cord to your country/region adapter.

3. Connect the DSL/ADSL filter to the splitter.
4. Unplug the answering machine from the telephone wall jack, and connect it to the port labeled 2-EXT on the back of the printer.

 **NOTE:** If you do not connect your answering machine directly to the printer, fax tones from a sending fax machine might be recorded on your answering machine, and you might not receive faxes with the printer.

5. Connect the DSL modem to the parallel splitter.
6. Connect the parallel splitter to the wall jack.
7. Set your answering machine to answer after a low number of rings.
8. Change your **Rings to Answer** setting on the printer to the maximum number of rings supported by the printer.

 **NOTE:** The maximum number of rings varies by country/region.

9. Run a fax test.

When the phone rings, your answering machine answers after the number of rings you have set, and then play your recorded greeting. The printer monitors the call during this time, “listening” for fax tones. If incoming fax tones are detected, the printer emits fax reception tones and receive the fax; if there are no fax tones, the printer stops monitoring the line and your answering machine can record a voice message.

If you use the same phone line for telephone, fax, and have a computer DSL modem, follow these instructions to set up your fax.

If you encounter problems setting up the printer with optional equipment, contact your local service provider or vendor for further assistance.

Case K: Shared voice/fax line with computer dial-up modem and voice mail

If you receive both voice calls and fax calls at the same phone number, use a computer dial-up modem on the same phone line, and subscribe to a voice mail service through your telephone company, set up the printer as described in this section.

NOTE: You cannot receive faxes automatically if you have a voice mail service at the same phone number you use for fax calls. You must receive faxes manually; this means you must be available to respond in person to incoming fax calls. If you want to receive faxes automatically instead, contact your telephone company to subscribe to a distinctive ring service, or to obtain a separate phone line for faxing.

Since your computer dial-up modem shares the phone line with the printer, you cannot use both your modem and the printer simultaneously. For example, you cannot use the printer for faxing if you are using your computer dial-up modem to send an email or access the Internet.

There are two different ways to set up the printer with your computer based on the number of phone ports on your computer. Before you begin, check your computer to see if it has one or two phone ports.

- If your computer has only one phone port, you need to purchase a parallel splitter (also called a coupler), as shown in the illustration. (A parallel splitter has one RJ-11 port on the front and two RJ-11 ports on the back. Do not use a two-line phone splitter, a serial splitter, or a parallel splitter which has two RJ-11 ports on the front and a plug on the back.)

Figure 5-15 Example of a parallel splitter



- If your computer has two phone ports, set up the printer as follows:

Figure 5-16 Back view of the printer

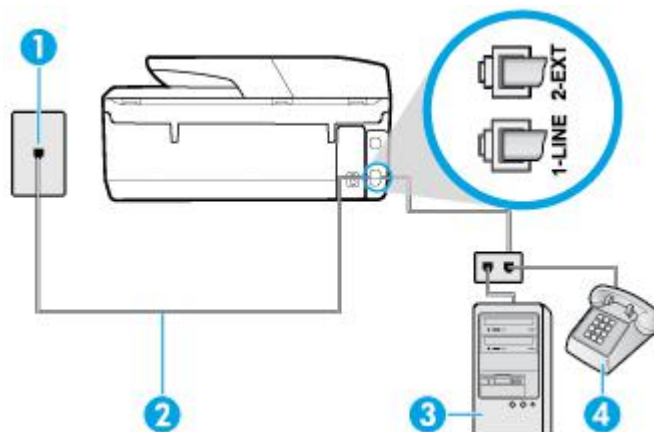

- | | |
|---|--|
| 1 | Telephone wall jack. |
| 2 | Connect the phone cord to the port labelled 1-LINE on the back of the printer.
You might need to connect the phone cord to your country/region adapter. |

3	Computer with modem.
4	Telephone.

To set up the printer on the same phone line as a computer with two phone ports

1. Remove the white plug from the port labeled 2-EXT on the back of the printer.
2. Find the phone cord that connects from the back of your computer (your computer dial-up modem) to a telephone wall jack. Disconnect the cord from the telephone wall jack and plug it into the port labeled 2-EXT on the back of the printer.
3. Connect a phone to the "OUT" port on the back of your computer dial-up modem.
4. Connect one end of the phone cord to your telephone wall jack, then connect the other end to the port labeled 1-LINE on the back of the printer.

 **NOTE:** You might need to connect the phone cord to your country/region adapter.

5. If your modem software is set to receive faxes to your computer automatically, turn off that setting.

 **NOTE:** If you do not turn off the automatic fax reception setting in your modem software, the printer cannot receive faxes.

6. Turn off the **Auto Answer** setting.
7. Run a fax test.

You must be available to respond in person to incoming fax calls, or the printer cannot receive faxes.

If you encounter problems setting up the printer with optional equipment, contact your local service provider or vendor for further assistance.

Test fax setup

You can test your fax setup to check the status of the printer and to make sure it is set up correctly for faxing. Perform this test after you have completed setting up the printer for faxing. The test does the following:

- Tests the fax hardware
- Verifies the correct type of phone cord is connected to the printer
- Checks that the phone cord is plugged into the correct port
- Checks for a dial tone
- Checks for an active phone line
- Tests the status of your phone line connection

The printer prints a report with the results of the test. If the test fails, review the report for information on how to fix the problem and rerun the test.

To test fax setup via the printer control panel

1. Set up the printer for faxing according to your particular home or office setup instructions.
2. Make sure the cartridges are installed, and that full-size paper is loaded in the input tray before starting the test.
3. On the printer control panel display, from the Home screen, touch  (**Fax**).

4. Touch **Setup**.
5. Touch **Tools** , and then touch **Test Fax**.

The printer displays the status of the test on the display and prints a report.

6. Review the report.
 - If the test passes and you are still having problems faxing, check the fax settings listed in the report to verify the settings are correct. A blank or incorrect fax setting can cause problems faxing.
 - If the test fails, review the report for more information on how to fix any problems found.

6 Web Services

This section contains the following topics:

- [What are Web Services?](#)
- [Set up Web Services](#)
- [Print with HP ePrint](#)
- [Remove Web Services](#)

What are Web Services?

The printer offers innovative, web-enabled solutions that can help you quickly access the Internet, obtain documents, and print them faster and with less hassle—and all without using a computer.

 **NOTE:** To use these web features, the printer must be connected to the Internet. You cannot use these web features if the printer is connected using a USB cable.

HP ePrint

- **HP ePrint** is a free service from HP that allows you to print to your HP ePrint-enabled printer anytime, from any location. It's as simple as sending an email to the email address assigned to your printer when you enable Web Services on the printer. No special drivers or software are needed. If you can send an email, you can print from anywhere, using **HP ePrint**.

 **NOTE:** You can sign up for an account on [HP Connected](#) (might not be available in all countries/regions), and sign in to configure the ePrint settings.

Once you have signed up for an account on [HP Connected](#) (might not be available in all countries/regions), you can sign in to view your **HP ePrint** job status, manage your **HP ePrint** printer queue, control who can use your printer's **HP ePrint** email address to print, and get help for **HP ePrint**.

Set up Web Services

Before you set up Web Services, make sure your printer is connected to the Internet using a wireless connection.

To set up Web Services, use one of the following methods.

To set up Web Services using the printer control panel

1. On the printer control panel display, from the Home screen, touch  (**Setup**).
2. Touch **Web Services**.
3. Touch **Accept** to accept the Web Services terms of use and enable Web Services.
4. On the screen that appears, touch **OK** to allow the printer to automatically check for product updates.

 **NOTE:** If prompted for proxy settings and if your network uses proxy settings, follow the onscreen instructions to set up a proxy server. If you do not have the proxy details, contact your network administrator or the person who set up the network.

5. If the **Printer Update Options** screen is displayed, select **Install Automatically (Recommended)** or **Alert When Available**.
6. When the printer is connected to the server, the printer prints an information page. Follow the instructions on the information page to finish the setup.

To set up Web Services using the embedded web server

1. Open the EWS. For more information, see [Embedded web server](#).
2. Click the **Web Services** tab.
3. In the **Web Services Settings** section, click **Setup**, click **Continue**, and follow the onscreen instructions to accept the terms of use.
4. If prompted, choose to allow the printer to check for and install printer updates.

 **NOTE:** When updates are available, they are automatically downloaded and installed, and then the printer restarts.

 **NOTE:** If prompted for proxy settings and if your network uses proxy settings, follow the onscreen instructions to set up a proxy server. If you do not have the proxy details, contact your network administrator or the person who set up the network.

5. When the printer is connected to the server, the printer prints an information page. Follow the instructions on the information page to finish the setup.

Print with HP ePrint

To use **HP ePrint**, do the following:

- Be sure you have an Internet- and email-capable computer or mobile device.
- Enable Web Services on the printer. For more information, see [Set up Web Services](#).

 **TIP:** For more information about managing and configuring **HP ePrint** settings and to learn about the latest features, visit [HP Connected](#). This site might not be available in all countries/regions..

To print documents using HP ePrint

1. On your computer or mobile device, open your email application.
2. Create a new email message, and then attach the file that you want to print.
3. Enter the **HP ePrint** email address in the “To” field, and then select the option to send the email message.



 **NOTE:** Do not enter any additional email addresses in either the “To” or “Cc” fields. The **HP ePrint** server does not accept print jobs if there are multiple email addresses.

To find the HP ePrint email address

1. On the printer control panel display, from the Home screen, touch  (**Setup**).
2. Touch **Web Services**.
3. Touch **Display Email Address**.

 **NOTE:** Touch **Print Info** to print an information page that contains the printer code and instructions on how to customize the email address.

To turn off HP ePrint



1. On the printer control panel display, from the Home screen, touch  (**HP ePrint**), and then touch  (**Web Services Settings**).
2. Touch the toggle button next to **HP ePrint** to turn it off.

 **NOTE:** To remove all Web Services, see [Remove Web Services](#).

Remove Web Services

Use the following instructions to remove Web Services.

To remove Web Services using the printer control panel

1. On the printer control panel display, from the Home screen, touch  (**HP ePrint**), and then touch  (**Web Services Settings**).
2. Touch **Remove Web Services**.

To remove Web Services using the embedded web server

1. Open the EWS. For more information, see [Embedded web server](#) .
2. Click the **Web Services** tab, and then click **Remove Web Services** in the **Web Services Settings** section.
3. Click **Remove Web Services**.
4. Click **Yes** to remove Web Services from your printer.

7 Work with cartridges

To ensure the best print quality from the printer, you need to perform some simple maintenance procedures.

This section contains the following topics:

- [Information on cartridges and the printhead](#)
- [Check the estimated ink levels](#)
- [Replace the cartridges](#)
- [Order cartridges](#)
- [Store printing supplies](#)
- [Anonymous usage information storage](#)
- [Ink cartridge warranty information](#)

Information on cartridges and the printhead

The following tips help maintain HP cartridges and ensure consistent print quality.

- The instructions in this guide are for replacing cartridges, and are not intended for first time installation.
- Keep all cartridges in the original sealed packages until they are needed.
- Be sure to turn off the printer properly. For more information, see [Turn the printer off](#).
- Store cartridges at room temperature (15-35° C or 59-95° F).
- Do not clean the printhead unnecessarily. This wastes ink and shortens the life of the cartridges.
- Handle cartridges carefully. Dropping, jarring, or rough handling during installation can cause temporary printing problems.
- If you are transporting the printer, do the following to prevent ink leaking from the printer or other damage from occurring to the printer:
 - Make sure you turn off the printer by pressing  (the Power button). Wait until all sounds of internal motion stop before unplugging the printer.
 - Make sure you leave the cartridges installed.
 - The printer must be transported sitting flat; it should not be placed on its side, back, front, or top.

 **CAUTION:** Whenever you remove a cartridge, you should replace it as quickly as possible. Leaving an ink cartridge slot empty exposes the printhead to the air, and can result in print quality issues or printhead damage. Never turn the printer off while an ink cartridge is missing.

Related topics

- [Check the estimated ink levels](#)

Check the estimated ink levels

You can check the estimated ink levels from the printer software or from the printer control panel.

To check the estimated ink levels from the printer control panel

- ▲ From Home screen, touch  (Ink) to check the estimated ink levels.

 **NOTE:** Ink level alerts and indicators provide estimates for planning purposes only. When you receive a low-ink alert, consider having a replacement cartridge available to avoid possible printing delays. You do not have to replace the cartridges until prompted to do so.

 **NOTE:** If you have installed a refilled or remanufactured cartridge, or a cartridge that has been used in another printer, the ink level indicator might be inaccurate or unavailable.

 **NOTE:** Ink from the cartridges is used in the printing process in a number of different ways, including in the initialization process, which prepares the printer and cartridges for printing, and in printhead servicing, which keeps print nozzles clear and ink flowing smoothly. In addition, some residual ink is left in the cartridge after it is used. For more information, see www.hp.com/go/inkusage.

Replace the cartridges

 **NOTE:** For information on recycling used ink supplies, see [HP inkjet supplies recycling program](#).

If you do not already have replacement cartridges for the printer, see [Order cartridges](#).

 **NOTE:** At this time, some portions of the HP website are available in English only.

 **NOTE:** Not all cartridges are available in all countries/regions.

 **CAUTION:** Whenever you remove a cartridge, you should replace it as quickly as possible. Leaving an ink cartridge slot empty exposes the printhead to the air, and can result in print quality issues or printhead damage. Never turn the printer off while an ink cartridge is missing.

To replace the cartridges

1. Make sure the printer is turned on and the scanner lid is closed.
2. Open the cartridge access door.

 **NOTE:** Wait until the print carriage stops moving before proceeding.

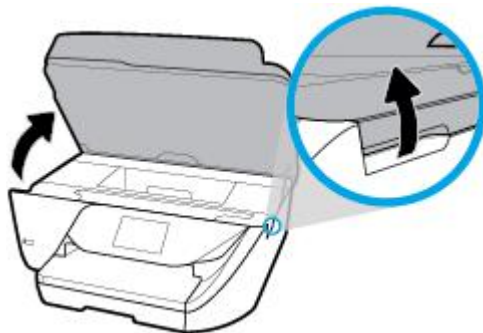

3. Press the front of the cartridge to release it, and then remove it from the slot.

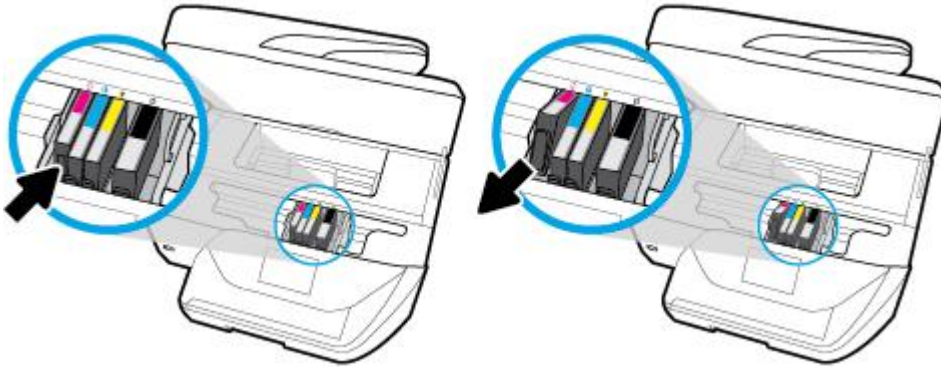

4. Remove the new cartridge from its packaging.

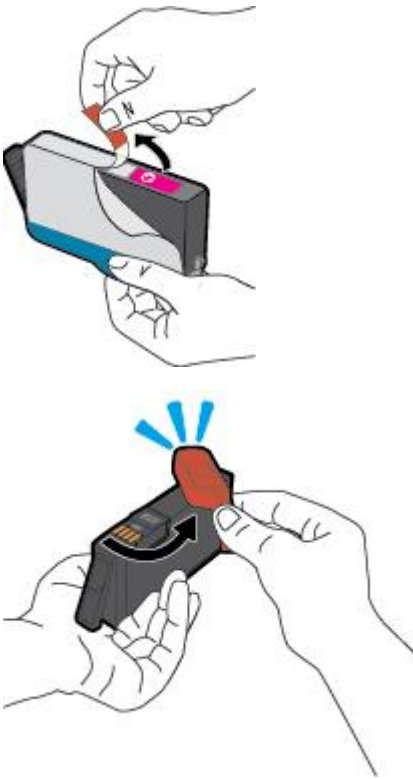

- Using the color-coded letters for help, slide the cartridge into the empty slot until it is securely installed in the slot.

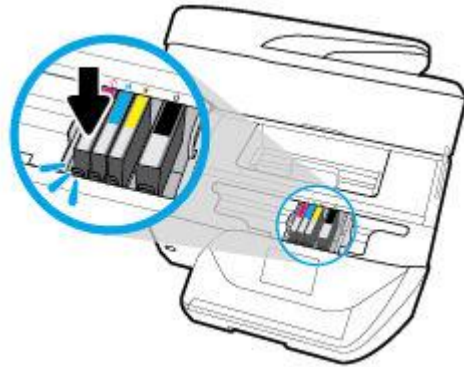

Make sure that the color-coded letter on the cartridge matches that on the slot.

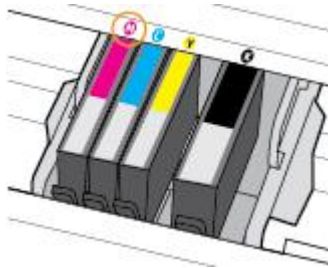

- Repeat steps 3 through 5 for each cartridge you are replacing.
- Close the cartridge access door.

Order cartridges

To order cartridges, go to www.hp.com. (At this time, some portions of the HP website are available in English only.) Ordering cartridges online is not supported in all countries/regions. However, many countries have information on ordering by telephone, locating a local store and printing a shopping list. In addition, you can visit the www.hp.com/buy/supplies page to obtain information about purchasing HP products in your country.

Use only the replacement cartridges that have the same cartridge number as the cartridge you are replacing. You can find the cartridge number in the following places:

- In the embedded web server, by clicking the **Tools** tab, and then, under **Product Information** clicking **Ink Gauge**. For more information, see [Embedded web server](#).
- On the printer status report (see [Understand printer reports](#)).
- On the label of the cartridge you are replacing.
- On a sticker inside the printer. Open the cartridge access door to locate the sticker.



NOTE: The cartridge that comes with the printer is not available for separate purchase.

Store printing supplies

Cartridges can be left in the printer for extended periods of time. However, to assure optimal cartridge health, be sure to turn off the printer properly when the printer is not in use. For more information, see [Turn the printer off](#).

Anonymous usage information storage

The HP cartridges used with this printer contain a memory chip that assists in the operation of the printer. In addition, this memory chip stores a limited set of anonymous information about the usage of the printer, which might include the following: the number of pages printed using the cartridge, the page coverage, frequency of printing, and the printing modes used.



This information helps HP design future printers to meet our customers' printing needs. The data collected from the cartridge memory chip does not contain information that can be used to identify a customer or user of the cartridge or their printer.

HP collects a sampling of the memory chips from cartridges returned to HP's free return and recycling program (HP Planet Partners: www.hp.com/recycle). The memory chips from this sampling are read and studied in order to improve future HP printers. HP partners who assist in recycling this cartridge might have access to this data, as well.

Any third party possessing the cartridge might have access to the anonymous information on the memory chip. If you prefer to not allow access to this information, you can render the chip inoperable. However, after you render the memory chip inoperable, the cartridge cannot be used in an HP printer.

If you are concerned about providing this anonymous information, you can make this information inaccessible by turning off the memory chip's ability to collect the printer's usage information.

To turn off the collecting usage information function

1. On the printer control panel display, from the Home screen, swipe left to see  (**Setup**) and touch  (**Setup**).
2. Touch **Preferences**.
3. Touch **On** next to **Store Usage Info** to turn it off.

 **NOTE:** To turn the usage information function on, restore the factory defaults. For more information about how to restore the defaults, see [Restore original factory defaults and settings](#).

 **NOTE:** You can continue to use the cartridge in the HP printer if you turn off the memory chip's ability to collect the printer's usage information.

Ink cartridge warranty information

The HP cartridge warranty is applicable when the product is used in its designated HP printing device. This warranty does not cover HP ink products that have been refilled, remanufactured, refurbished, misused, or tampered with.

During the warranty period the product is covered as long as the HP ink is not depleted and the end of warranty date has not been reached. The end of warranty date, in YYYY-MM format, may be found on the product as indicated:

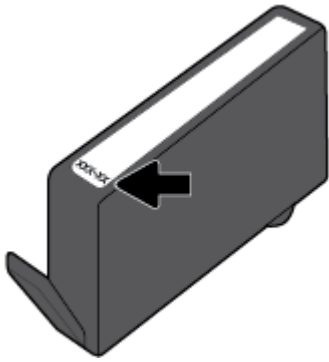

8 Network setup

Additional advanced settings are available from the printer's home page (embedded web server or EWS). For more information, see [Embedded web server](#).

This section contains the following topics:

- [Set up the printer for wireless communication](#)
- [Change network settings](#)
- [Use Wi-Fi Direct](#)

Set up the printer for wireless communication

- [Before you begin](#)
- [Set up the printer on your wireless network](#)
- [Change the connection type](#)
- [Test the wireless connection](#)
- [Turn on or off the wireless capability of the printer](#)



NOTE: If you encounter problems connecting the printer, see [Network and connection issues](#).



TIP: For more information about setting up and using the printer wirelessly, visit the HP Wireless Printing Center (www.hp.com/go/wirelessprinting).

Before you begin

Ensure the following:

- The wireless network is set up and working properly.
- The printer and the computers that use the printer are on the same network (subnet).

While connecting the printer, you might be prompted to enter the wireless network name (SSID) and a wireless password.

- The wireless network name is the name of your wireless network.
- The wireless password prevents other people from connecting to your wireless network without your permission. Depending on the level of security required, your wireless network might use either a WPA passphrase or WEP key.



If you have not changed the network name or the security passkey since setting up your wireless network, you can sometimes find them on the back or side of the wireless router.

If you cannot find the network name or the security password or cannot remember this information, see the documentation provided with your computer or with the wireless router. If you still cannot find this information, contact your network administrator or the person who set up the wireless network.

Set up the printer on your wireless network

Use the Wireless Setup Wizard from the printer control panel display to set up wireless communication.

 **NOTE:** Before you proceed, go through the list at [Before you begin](#).

1. From the printer control panel display, touch  (Wireless).
2. Touch  (**Settings**).
3. Touch **Wireless Settings**.
4. Touch **Wireless Setup Wizard** or **Wi-Fi Protected Setup**.
5. Follow the display instructions to complete the setup.

If you are already using the printer with a different type of connection, such as a USB connection, follow the instructions in [Change the connection type](#) to set up the printer on your wireless network.

Change the connection type

After you have installed the HP printer software and connected the printer to your computer or to a network, you can use the software to change the connection type (for example, from a USB connection to a wireless connection).

To change from a USB connection to a wireless network (Windows)

Before you proceed, go through the list at [Before you begin](#).

1. Open the HP printer software. For more information, see [Open the HP printer software \(Windows\)](#).
2. Click **Tools**.
3. Click **Device Setup & Software**.
4. Select **Convert a USB connected printer to wireless**. Follow the onscreen instructions.

To change from a USB connection to a wireless connection (OS X)

1. Remove the USB cable from the printer.
2. Restore the printer to its network defaults. For more information, see [Restore original factory defaults and settings](#).
3. Download the most recent version of HP Easy Start from 123.hp.com.
4. Open HP Easy Start and follow the onscreen instructions to connect your printer.



Learn more about how to change from a USB to wireless connection. [Click here to go online for more information](#). At this time, this website might not be available in all languages.

To change from a wireless connection to a USB connection (Windows)

- ▲ Connect the printer and the computer with the provided USB cable. This USB port is at the rear of the printer. For the specific location, see [Back view](#).



To change from a wireless connection to a USB connection (OS X)

1. Open **System Preferences** .
2. Click **Printers & Scanners** .
3. Select your printer in the left pane and click - at the bottom of the list. Do the same for the fax entry, if there is one for the current connection.
4. Connect a USB cable to both your computer and printer.
5. Click + below the list of printers at the left.
6. Select the new USB printer from the list.
7. Choose your printer model name from the **Use** pop-up menu.
8. Click **Add**.

Test the wireless connection



Print the wireless test report for information about the printer wireless connection. The wireless test report provides information about the printer status, hardware (MAC) address, and IP address. If there is a problem with the wireless connection or if a wireless connection attempt failed, the wireless test report also provides diagnostic information. If the printer is connected to a network, the test report displays details about the network settings.

To print the wireless test report

1. From the printer control panel display, touch  (Wireless), and then touch  (**Settings**).
2. Touch **Print Reports**.
3. Touch **Wireless Test Report**.

Turn on or off the wireless capability of the printer

The blue Wireless light on the printer control panel is lit when the wireless capability of the printer is on.

1. From the printer control panel display, touch  (Wireless), and then touch  (**Settings**).
2. Touch the toggle button next to **Wireless** to turn the wireless capability on or off.



Change network settings

From the printer control panel, you can set up and manage your printer's wireless connection and perform a variety of network management tasks. This includes viewing and changing network settings, restoring network defaults, and turning the wireless function on or off.

 **CAUTION:** Network settings are provided for your convenience. However, unless you are an advanced user, you should not change some of these settings (such as the link speed, IP settings, default gateway, and firewall settings).

To print network settings

Do one of the following:



- On the printer control panel display, from the Home screen, touch  (Wireless) to display the network status screen. Touch **Print Info** to print the network configuration page.
- On the printer control panel display, from the Home screen, touch  (**Setup**), touch **Tools**, and then touch **Network Configuration Report**.

To change IP settings

The default IP setting for the IP settings is **Automatic**, which sets the IP settings automatically. If you are an advanced user and want to use different settings (such as the IP address, subnet mask, or the default gateway), you can change them manually.

 **TIP:** Before setting a manual IP address, it is recommended to first connect the printer to the network using Automatic mode. This allows the router to configure the printer with other needed settings like subnet mask, default gateway and DNS address.

 **CAUTION:** Be careful when manually assigning an IP address. If you enter an invalid IP address during the installation, your network components cannot connect with the printer.

1. From the printer control panel display, touch  (Wireless), and then touch  (**Settings**).
2. Touch **Advanced Settings**.
3. Touch **IP Settings**.

A message appears warning that changing the IP address removes the printer from the network.

4. Touch **OK** to continue.
5. **Automatic** is selected by default. To change the settings manually, touch **Manual**, and then enter the appropriate information for the following settings:
 - **IP Address**
 - **Subnet Mask**
 - **Default Gateway**
 - **DNS Address**
6. Enter your changes, and then touch **Apply**.

Use Wi-Fi Direct

With Wi-Fi Direct, you can print wirelessly from a computer, smart phone, tablet, or other wireless-capable device—without connecting to an existing wireless network.



Guidelines for using Wi-Fi Direct

- Make sure your computer or mobile device has the necessary software.
 - If you are using a computer, make sure you have installed the HP printer software.

If you have not installed the HP printer software on the computer, connect to Wi-Fi Direct first and then install the printer software. Select **Wireless** when prompted by the printer software for a connection type.



- If you are using a mobile device, make sure you have installed a compatible printing app. For more information about mobile printing, visit www.hp.com/global/us/en/eprint/mobile_printing_apps.html.
- Make sure Wi-Fi Direct for your printer is turned on.
- Up to five computers and mobile devices can use the same Wi-Fi Direct connection.
- Wi-Fi Direct can be used while the printer is also connected either to a computer using a USB cable or to a network using a wireless connection.
- Wi-Fi Direct cannot be used to connect a computer, mobile device, or printer to the Internet.

To turn on Wi-Fi Direct

1. On the printer control panel display, from the Home screen, touch  (Wi-Fi Direct).
2. Touch  (**Settings**).
3. If the display shows that Wi-Fi Direct is **Off** , touch the toggle button next to **Wi-Fi Direct** to turn it on.

 **TIP:** You can also turn on Wi-Fi Direct from the EWS. For more information about using the EWS, see [Embedded web server](#) .

To change connection method

1. On the printer control panel display, from the Home screen, touch  (Wi-Fi Direct).
2. Touch  (**Settings**).
3. Touch **Connection Method** and then select **Automatic** or **Manual** .

To print from a wireless-capable mobile device that supports Wi-Fi Direct

Make sure you have installed the latest version of HP Print Service Plugin on your mobile device. You can download this plugin from the Google Play application store.

1. Make sure you have turned on Wi-Fi Direct on the printer.
2. Turn on Wi-Fi Direct on your mobile device. For more information, see the documentation provided with the mobile device.
3. From your mobile device, select a document from a print enabled application, and then select the option to print the document.

The list of available printers appears.

4. From the list of available printers, choose the Wi-Fi Direct name shown such as **DIRECT-**-HP OfficeJet 6950** (where ** are the unique characters to identify your printer and XXXX is the printer model located on the printer) to connect your mobile device.

If the mobile device is not automatically connected to the printer, follow the instructions on the printer control panel to connect to the printer. If a PIN code is displayed on the printer control panel, enter the PIN code on your mobile device.

When the mobile device is successfully connected to the printer, the printer starts printing.

To print from a wireless-capable mobile device that does not support Wi-Fi Direct

Make sure you have installed a compatible printing app on your mobile device. For more information, visit www.hp.com/global/us/en/eprint/mobile_printing_apps.html.

1. Make sure you have turned on Wi-Fi Direct on the printer.
2. Turn on the Wi-Fi connection on your mobile device. For more information, see the documentation provided with the mobile device.



NOTE: If your mobile device does not support Wi-Fi, you are not able to use Wi-Fi Direct.

3. From the mobile device, connect to a new network. Use the process you normally use to connect to a new wireless network or hotspot. Choose the Wi-Fi Direct name from the list of wireless networks shown such as **DIRECT-**-HP OfficeJet 6950** (where ** are the unique characters to identify your printer).

Enter the Wi-Fi Direct password when prompted.

4. Print your document.

To print from a wireless-capable computer (Windows)

1. Make sure you have turned on Wi-Fi Direct on the printer.
2. Turn on the computer's Wi-Fi connection. For more information, see the documentation provided with the computer.



NOTE: If your computer does not support Wi-Fi, you are not able to use Wi-Fi Direct.

3. From the computer, connect to a new network. Use the process you normally use to connect to a new wireless network or hotspot. Choose the Wi-Fi Direct name from the list of wireless networks shown such as **DIRECT-**-HP OfficeJet 6950** (where ** are the unique characters to identify your printer).

Enter the Wi-Fi Direct password when prompted.

4. Proceed to step 5 if the printer has been installed and connected to the computer over a wireless network. If the printer has been installed and connected to your computer with a USB cable, follow the steps below to install the printer software using the Wi-Fi Direct connection.
 - a. Open the HP printer software. For more information, see [Open the HP printer software \(Windows\)](#).
 - b. Click **Tools**.
 - c. Click **Device Setup & Software**, and then select **Connect a new device**.



NOTE: If you have previously installed the printer over USB and want to convert to Wi-Fi Direct, do not select the **Convert a USB connected printer to wireless** option.

- d. When the **Connection Options** software screen appears, select **Wireless**.
 - e. Select your HP printer from the detected printer list.
 - f. Follow the onscreen instructions.
5. Print your document.

To print from a wireless-capable computer (OS X)

1. Make sure you have turned on Wi-Fi Direct on the printer.
2. Turn on Wi-Fi on the computer.

For more information, see the documentation provided by Apple.

3. Click the Wi-Fi icon and choose the Wi-Fi Direct name, such as **DIRECT-**-HP OfficeJet 6950** (where ** are the unique characters to identify your printer).

If Wi-Fi Direct is turned on with security, enter the password when prompted.

4. Add the printer.
 - a. Open **System Preferences**.
 - b. Depending on your operating system, click **Printers & Scanners**.
 - c. Click + below the list of printers at the left.
 - d. Select the printer from the list of detected printers (the word “Bonjour” is listed the right column beside the printer name), and click **Add**.



[Click here](#) for online troubleshooting for Wi-Fi Direct, or for more help with setting up Wi-Fi Direct. At this time, this website might not be available in all languages.

9 Printer management tools

This section contains the following topics:

- [Toolbox \(Windows\)](#)
- [HP Utility \(OS X\)](#)
- [Embedded web server](#)

Toolbox (Windows)

The Toolbox provides maintenance information about the printer.

To open the Toolbox

1. Open the HP printer software. For more information, see [Open the HP printer software \(Windows\)](#).
2. Click **Print, Scan & Fax**.
3. Click **Maintain Your Printer**.

HP Utility (OS X)

HP Utility contains tools to configure print settings, calibrate the printer, order supplies online, and find website support information.

 **NOTE:** The features available in HP Utility vary depending on the selected printer.

Ink level warnings and indicators provide estimates for planning purposes only. When an indicator shows low-ink levels, consider having a replacement ink cartridge available to avoid possible printing delays. You do not need to replace ink cartridges until print quality becomes unacceptable.

Double-click HP Utility in the **HP** folder in the **Applications** folder.

Embedded web server

When the printer is connected to a network, you can use the printer's embedded web server (EWS) to view status information, change settings, and manage it from your computer.

 **NOTE:** To view or change some settings, you might need a password.

 **NOTE:** You can open and use the embedded web server without being connected to the Internet. However, some features are not available.

- [About cookies](#)
- [Open the embedded web server](#)
- [Embedded web server cannot be opened](#)

About cookies

The embedded Web server (EWS) places very small text files (cookies) on your hard drive when you are browsing. These files let the EWS recognize your computer the next time you visit. For example, if you have configured the EWS language, a cookie helps remember which language you have selected so that the next time you access the EWS, the pages are displayed in that language. Some cookies (such as the cookie that stores customer-specific preferences) are stored on the computer until you clear them manually.

You can configure your browser to accept all cookies, or you can configure it to alert you every time a cookie is offered, which allows you to decide which cookies to accept or refuse. You can also use your browser to remove unwanted cookies.

Depending on your printer, if you disable cookies, you also disable one or more of the following features:

- Using some setup wizards
- Remembering the EWS browser language setting
- Personalizing the EWS Home page

For information about how to change your privacy and cookie settings and how to view or delete cookies, see the documentation available with your Web browser.

Open the embedded web server

You can access the embedded web server through either a network or Wi-Fi Direct.

To open the embedded web server through a network



1. Find out the IP address or hostname of the printer by touching  (Wireless) or by printing a network configuration page.



NOTE: The printer must be on a network and must have an IP address.

2. In a supported web browser on your computer, type the IP address or hostname assigned to the printer.
For example, if the IP address is 123.123.123.123, type the following address into the web browser:
`http://123.123.123.123`.

To open the embedded web server through Wi-Fi Direct

1. On the printer control panel display, from the Home screen, touch  (Wi-Fi Direct).
2. Touch  (**Settings**).
3. If the display shows that Wi-Fi Direct is **Off** , touch the toggle button next to **Wi-Fi Direct** to turn it on.
4. From your wireless computer, turn wireless on, search for and connect to the Wi-Fi Direct name, for example: **DIRECT-**-HP OfficeJet 6950** (where ** are the unique characters to identify your printer).
Enter the Wi-Fi Direct password when prompted.
5. In a supported web browser on your computer, type the following address: `http://192.168.223.1`.

Embedded web server cannot be opened

Check your network setup

- Make sure you are not using a phone cord or a crossover cable to connect the printer to the network.
- Make sure the network cable is securely connected to the printer.
- Make sure the network hub, switch, or router is turned on and working correctly.

Check the computer

- Make sure the computer that you are using is connected to the same network as the printer.

Check your web browser

- Make sure the web browser meets the minimum system requirements.
- If your web browser uses any proxy settings to connect to the Internet, try turning off these settings. For more information, see the documentation available with your web browser.
- Make sure JavaScript and cookies are enabled in your web browser. For more information, see the documentation available with your web browser.

Check the printer IP address

- Make sure the printer IP address is correct.

To find out the printer IP address, on the printer control panel display, from the Home screen, touch  (Wireless).

To obtain the printer IP address by printing a network configuration page, on the printer control panel display, from the Home screen, touch  (**Setup**), touch **Tools**, and then touch **Network Configuration Report**.

- Make sure the printer IP address is valid. The printer IP address should have the similar format as the router IP address. For example, the router IP address might be 192.168.0.1 or 10.0.0.1 and the printer IP address is 192.168.0.5 or 10.0.0.5.

If the printer IP address is similar to 169.254.XXX.XXX or 0.0.0.0, it is not connected to the network.

 **TIP:** If you are using a computer running Windows, you can visit the HP online support website at www.support.hp.com. This website provides information and utilities that can help you correct many common printer problems.

10 Solve a problem

The information in this section suggests solutions to common problems. If your printer is not operating correctly and these suggestions did not solve your problem, try using one of the support services listed in [HP support](#) to obtain assistance.

This section contains the following topics:

- [Jams and paper-feed issues](#)
- [Printing issues](#)
- [Copy issues](#)
- [Scan issues](#)
- [Fax issues](#)
- [Network and connection issues](#)
- [Printer hardware issues](#)
- [Get help from the printer control panel](#)
- [Understand printer reports](#)
- [Solve problems using Web Services](#)
- [Maintain the printer](#)
- [Restore original factory defaults and settings](#)
- [HP support](#)

Jams and paper-feed issues

What do you want to do?

Clear a paper jam

Solve paper jam issues.	Use an HP online troubleshooting wizard Instructions for clearing the jam in the printer or in the document feeder and resolving issues with paper or the paper feed.
---	--



NOTE: The HP online troubleshooting wizards may not be available in all languages.

Read general instructions in the Help for clearing paper jams

Paper jams can occur in several locations inside the printer.



CAUTION: To prevent possible damage to the printhead, clear paper jams as soon as possible.

To clear a paper jam from input tray

1. Lift the output tray.



2. Pull out the input tray to extend it.



3. Press down the buttons on both sides of the input tray, and pull to remove the input tray.

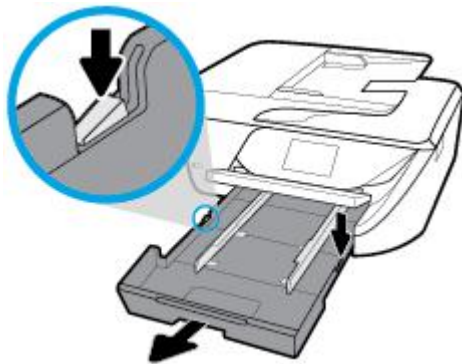

4. Check the gap in the printer where the input tray was. If there is any jammed paper, reach into the gap, grasp the paper with both hands and pull it towards you.

⚠ CAUTION: If the paper tears when you are removing it from the rollers, check the rollers and wheels for torn pieces of paper that might be remaining inside the printer.

If you do not remove all of the pieces of paper from the printer, more paper jams are likely to occur.

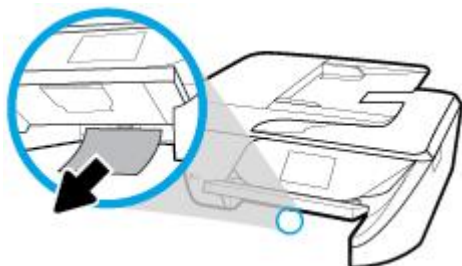

5. Insert the input tray, load paper, and lower the output tray.



To clear a paper jam from print zone

1. Press  (the Power button) to turn off the printer.
2. Open the ink cartridge access door.

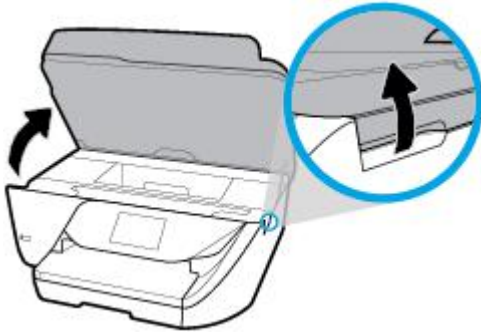

3. Check the paper path inside the printer.
 - a. Lift the handle of the paper path cover and remove the cover.



- b. Locate any jammed paper inside the printer, grasp it with both hands and pull it towards you.

⚠ CAUTION: If the paper tears when you are removing it from the rollers, check the rollers and wheels for torn pieces of paper that might be remaining inside the printer.

If you do not remove all the pieces of paper from the printer, more paper jams are likely to occur.



- c. Reinsert the paper path cover until it snaps into place.



4. If the problem is not resolved, check the print carriage area inside the printer.

⚠ CAUTION: During the process, avoid touching the cable attached to the print carriage.



- a. If there is any jammed paper, move the print carriage to the far right of the printer, grasp the jammed paper with both hands, and then pull it towards you.

⚠ CAUTION: If the paper tears when you are removing it from the rollers, check the rollers and wheels for torn pieces of paper that might be remaining inside the printer.

If you do not remove all the pieces of paper from the printer, more paper jams are likely to occur.



- b. Move the carriage to the far left of the printer, and do the same as in the previous step to remove any torn pieces of paper.



5. Close the ink cartridge access door.
6. Press  (the Power button) to turn on the printer.

To clear a paper jam in the document feeder

1. Lift the cover of the document feeder.



2. Lift the tab located on the front edge of the document feeder.

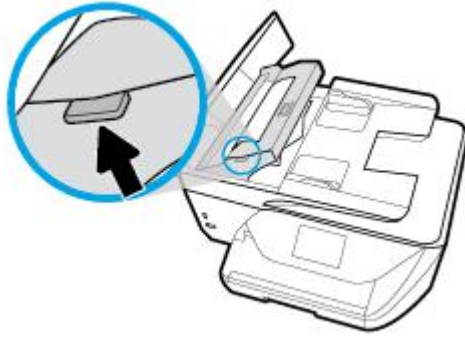

3. Gently pull the jammed paper out of the rollers.

CAUTION: If the paper tears when you are removing it from the rollers, check the rollers and wheels for torn pieces of paper that might remain inside the printer.

If you do not remove all the pieces of paper from the printer, more paper jams are likely to occur.



4. Close the document feeder cover, pressing down firmly until it snaps into place.



If the above solutions do not resolve the problem, [click here for more online troubleshooting.](#)

Clear a print carriage jam

[Resolve a print carriage jam.](#)

Use an HP online troubleshooting wizard

If something is blocking the print carriage or it does not move easily, get step-by-step instructions.



NOTE: The HP online troubleshooting wizards may not be available in all languages.

Read general instructions in the Help for clearing a print carriage jams

Remove any objects, such as paper, that are blocking the print carriage.



NOTE: Do not use any tools or other devices to remove jammed paper. Always use caution when removing jammed paper from inside the printer.

Learn how to avoid paper jams

To help avoid paper jams, follow these guidelines.

- Remove printed papers from the output tray frequently.
- Make sure that you are printing with paper that is not wrinkled, folded, or damaged.
- Prevent curled or wrinkled paper by storing all unused paper flat in a resealable bag.
- Do not use paper that is too thick or too thin for the printer.
- Make sure that the trays are loaded correctly and are not too full. For more information, see [Load paper](#).
- Ensure that paper loaded in the input tray lays flat and the edges are not bent or torn.
- Do not place too much paper in the document feeder tray. For information on the maximum number of sheets allowed in the document feeder, see [Specifications](#).
- Do not mix different paper types and paper sizes in the input tray; the entire stack of paper in the input tray must be the same size and type.
- Adjust the paper-width guides in the input tray to fit snugly against all paper. Make sure the paper-width guides do not bend the paper in the input tray.
- Do not force paper too far inside the input tray.
- If you are printing on both sides of a page, do not print highly saturated images on light weight paper.
- Use paper types that are recommended for the printer.
- If the printer is about to run out of paper, allow the printer to run out of paper first, and then add paper. Do not load paper when the printer is printing.

Solve paper-feed problems

What kind of problem are you having?

- **Paper is not picked up from a tray**
 - Make sure paper is loaded in the tray. For more information, see [Load paper](#). Fan the paper before loading.
 - Make sure the paper-width guides are set to the correct markings in the tray for the paper size you are loading. Also make sure the paper guides are snug, but not tight, against the stack.
 - Ensure that the stack of paper is aligned with the appropriate paper size lines on the bottom of the input tray, and does not exceed the stack height indicated by one or more label on the side or paper-width guide of the input tray.
 - Make sure paper in the tray is not curled. Uncurl paper by bending it in the opposite direction of the curl.
- **Pages are skewing**
 - Make sure the paper loaded in the input tray is aligned to the paper-width guides. If needed, pull out the input tray from the printer and reload the paper correctly, making sure that the paper guides are aligned correctly.
 - Load paper into the printer only when it is not printing.
- **Multiple pages are being picked up**

- Make sure the paper-width guides are set to the correct markings in the tray for the paper size you are loading. Also make sure the paper-width guides are snug, but not tight, against the stack.
- Ensure that the stack of paper is aligned with the appropriate paper size lines on the bottom of the input tray, and does not exceed the stack height indicated by one or more label on the side or paper-width guide of the input tray.
- Make sure the tray is not overloaded with paper.
- Use HP paper for optimum performance and efficiency.

Printing issues

What do you want to do?

Fix problems with page not printing (unable to print)

HP Print and Scan Doctor	The HP Print and Scan Doctor is a utility that will try to diagnose and fix the issue automatically. NOTE: This utility is only available for Windows operating system.
Troubleshoot problems with print jobs not printing	Use an HP online troubleshooting wizard. Get step-by-step instructions if the printer is not responding or printing.



NOTE: The HP Print and Scan Doctor and the HP online troubleshooting wizards may not be available in all languages.

Read general instructions in the Help for unable to print issues

To resolve print issues (Windows)

Make sure that the printer is turned on and that there is paper in the tray. If you are still unable to print, try the following in order:

1. Check for error messages from the printer display and resolve them by following the onscreen instructions.
2. If your computer is connected to the printer with a USB cable, disconnect and reconnect the USB cable. If your computer is connected to the printer with a wireless connection, confirm that the connection is working.
3. Verify that the printer is not paused or offline.

To verify that the printer is not paused or offline

- a. Depending on your operating system, do one of the following:
 - **Windows 10:** From the Windows **Start** menu, click **All apps**, select **Windows System, Control Panel**, and then click **View devices and printers** under **Hardware and Sound** menu.
 - **Windows 8.1 and Windows 8:** Point to or tap the upper-right corner of the screen to open the Charms bar, click the **Settings** icon, click or tap **Control Panel**, and then click or tap **View devices and printers**.
 - **Windows 7:** From the Windows **Start** menu, click **Devices and Printers**.

- **Windows Vista:** From the Windows **Start** menu, click **Control Panel**, and then click **Printers**.
 - **Windows XP:** From the Windows **Start** menu, click **Control Panel**, and then click **Printers and Faxes**.
- b. Either double-click the icon for your printer or right-click the icon for your printer and select **See what's printing** to open the print queue.
 - c. On the **Printer** menu, make sure there are no check marks next to **Pause Printing** or **Use Printer Offline**.
 - d. If you made any changes, try to print again.
4. Verify that the printer is set as the default printer.

To verify that the printer is set as the default printer

- a. Depending on your operating system, do one of the following:
 - **Windows 10:** From the Windows **Start** menu, click **All apps**, select **Windows System, Control Panel**, and then click **View devices and printers** under **Hardware and Sound** menu.
 - **Windows 8.1 and Windows 8:** Point to or tap the upper-right corner of the screen to open the Charms bar, click the **Settings** icon, click or tap **Control Panel**, and then click or tap **View devices and printers**.
 - **Windows 7:** From the Windows **Start** menu, click **Devices and Printers**.
 - **Windows Vista:** From the Windows **Start** menu, click **Control Panel**, and then click **Printers**.
 - **Windows XP:** From the Windows **Start** menu, click **Control Panel**, and then click **Printers and Faxes**.
 - b. Make sure the correct printer is set as the default printer.
The default printer has a check mark in a black or green circle next to it.
 - c. If the wrong printer is set as the default printer, right-click the correct printer and select **Set as Default Printer**.
 - d. Try using your printer again.
5. Restart the print spooler.

To restart the print spooler

- a. Depending on your operating system, do one of the following:

Windows 10

 - i. From the Windows **Start** menu, click **All apps**, and then click **Windows System**.
 - ii. Click **Control Panel, System and Security**, and then click **Administrative Tools**.
 - iii. Double-click **Services**.
 - iv. Right-click the **Print Spooler**, and then click **Properties**.
 - v. On the **General** tab, next to **Startup type**, make sure that **Automatic** is selected.
 - vi. If the service is not already running, under **Service status**, click **Start**, and then click **OK**.

Windows 8.1 and Windows 8

- i. Point to or tap the upper-right corner of the screen to open the Charms bar, and then click the **Settings** icon.
- ii. Click or tap **Control Panel**, and then click or tap **System and Security**.
- iii. Click or tap **Administrative Tools**, and then double-click or double-tap **Services**.
- iv. Right-click or touch and hold **Print Spooler**, and then click **Properties**.
- v. On the **General** tab, next to **Startup type**, make sure that **Automatic** is selected.
- vi. If the service is not already running, under **Service status**, click or tap **Start**, and then click or tap **OK**.

Windows 7

- i. From the Windows **Start** menu, click **Control Panel**, **System and Security**, and then **Administrative Tools**.
- ii. Double-click **Services**.
- iii. Right-click the **Print Spooler**, and then click **Properties**.
- iv. On the **General** tab, next to **Startup type**, make sure that **Automatic** is selected.
- v. If the service is not already running, under **Service status**, click **Start**, and then click **OK**.

Windows Vista

- i. From the Windows **Start** menu, click **Control Panel**, **System and Maintenance**, **Administrative Tools**.
- ii. Double-click **Services**.
- iii. Right-click the **Print Spooler service**, and then click **Properties**.
- iv. On the **General** tab, next to **Startup type**, make sure that **Automatic** is selected.
- v. If the service is not already running, under **Service status**, click **Start**, and then click **OK**.

Windows XP

- i. From the Windows **Start** menu, right click **My Computer**.
 - ii. Click **Manage**, and then click **Services and Applications**.
 - iii. Double-click **Services**, and then select **Print Spooler**.
 - iv. Right-click **Print Spooler**, and click **Restart** to restart the service.
 - b. Make sure the correct printer is set as the default printer.
The default printer has a check mark in a black or green circle next to it.
 - c. If the wrong printer is set as the default printer, right-click the correct printer and select **Set as Default Printer**.
 - d. Try using your printer again.
6. Restart the computer.
 7. Clear the print queue.

To clear the print queue

- a. Depending on your operating system, do one of the following:
 - **Windows 10:** From the Windows **Start** menu, click **All apps**, select **Windows System, Control Panel**, and then click **View devices and printers** under **Hardware and Sound** menu.
 - **Windows 8.1 and Windows 8:** Point to or tap the upper-right corner of the screen to open the Charms bar, click the **Settings** icon, click or tap **Control Panel**, and then click or tap **View devices and printers**.
 - **Windows 7:** From the Windows **Start** menu, click **Devices and Printers**.
 - **Windows Vista:** From the Windows **Start** menu, click **Control Panel**, and then click **Printers**.
 - **Windows XP:** From the Windows **Start** menu, click **Control Panel**, and then click **Printers and Faxes**.
- b. Double-click the icon for your printer to open the print queue.
- c. On the **Printer** menu, click **Cancel all documents** or **Purge Print Document**, and then click **Yes** to confirm.
- d. If there are still documents in the queue, restart the computer and try printing again after the computer has restarted.
- e. Check the print queue again to make sure it is clear, and then try to print again.

To check the power connection and reset the printer

1. Make sure the power cord is firmly connected to the printer.

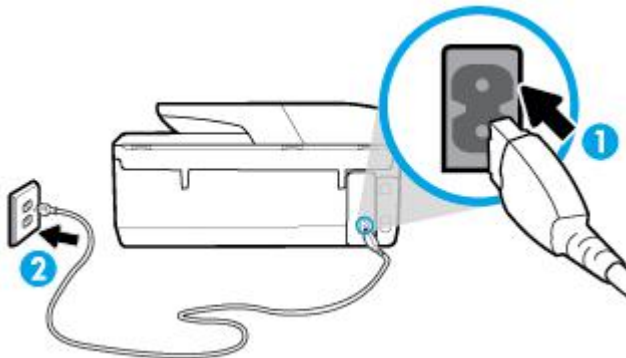

1 Power connection to the printer

2 Connection to a power outlet

2. Look at the Power button located on the printer. If it is not lit, the printer is turned off. Press the Power button to turn on the printer.



NOTE: If the printer is not receiving electrical power, connect it to another power outlet.

3. With the printer turned on, disconnect the power cord from the rear of the printer.
4. Unplug the power cord from the wall outlet.
5. Wait at least 15 seconds.
6. Plug the power cord back into the wall outlet.
7. Reconnect the power cord to the rear of the printer.

8. If the printer does not turn on by itself, press the Power button to turn on the printer.
9. Try using the printer again.

To resolve print issues (OS X)

1. Check for error messages and resolve.
2. Disconnect and reconnect the USB cable.
3. Verify that the product is not paused or offline.

To verify that the product is not paused or offline

- a. In **System Preferences**, click **Printers & Scanners**.
- b. Click the **Open Print Queue** button.
- c. Click a print job to select it.

Use the following buttons to manage the print job:

- **Delete:** Cancel the selected print job.
 - **Hold:** Pause the selected print job.
 - **Resume:** Continue a paused print job.
 - **Pause Printer:** Pause all print jobs in the print queue.
- d. If you made any changes, try to print again.
4. Restart the computer.

Fix print quality issues

[Step-by-step instructions for resolving most print quality issues](#)

Troubleshoot print quality issues online

Read general instructions in the Help for resolving print quality issues



NOTE: To avoid print quality problems, always turn the printer off using the Power button, and wait until the Power button light goes out before you pull the plug or turn off a power strip. This allows the printer to move the cartridges to a capped position, where they are protected from drying out.

To improve print quality (Windows)

1. Make sure you are using original HP cartridges.
2. Check the paper type.

For best print quality, use high quality HP paper, or papers that adhere to the ColorLok® standard. For more information, see [Paper basics](#).

Always make sure the paper you are printing on is flat. For best results when printing images, use HP Advanced Photo Paper.

Store specialty paper in its original packaging inside a resealable plastic bag on a flat surface in a cool, dry place. When you are ready to print, remove only the paper you plan to use immediately. When you have finished printing, return any unused photo paper to the plastic bag. This prevents the photo paper from curling.

3. Check the printer software to make sure you have selected the appropriate paper type from the **Media** drop-down list and the appropriate print quality from the **Quality Settings** options.
 - In the printer software, under **Print, Scan, & Fax**, in the **Print** section, click **Set Preferences** to access the print properties.
4. Check the estimated ink levels to determine if the cartridges are low on ink. For more information, see [Check the estimated ink levels](#). If the cartridges are low on ink, consider replacing them.
5. Align the printhead.

To align the printhead from the printer software



NOTE: Aligning the printhead ensures the high-quality output. The printhead does not have to be realigned when cartridges are replaced.

- a. Load letter or A4 unused plain white paper into the input tray.
 - b. Open the HP printer software. For more information, see [Open the HP printer software \(Windows\)](#).
 - c. In the printer software, under **Print, Scan, & Fax**, in the **Print** section, click **Maintain Your Printer** to access the printer toolbox.
 - d. In **Printer Toolbox**, click **Align Printheads** on the **Device Services** tab. The printer prints an alignment sheet.
6. Print a diagnostics page if the cartridges are not low on ink.

To print a diagnostics page from the printer software

- a. Load letter, A4, or legal unused plain white paper into the input tray.
 - b. Open the HP printer software. For more information, see [Open the HP printer software \(Windows\)](#).
 - c. In the printer software, under **Print, Scan, & Fax**, in the **Print** section, click **Maintain Your Printer** to access the printer toolbox.
 - d. Click **Print Diagnostic Information** on the **Device Reports** tab to print a diagnostics page.
7. Review the blue, magenta, yellow, and black boxes on the diagnostics page. If you are seeing streaks in the color and black boxes, or no ink in portions of the boxes, then automatically clean the printhead.

To clean the printhead from the printer software



NOTE: Cleaning uses ink, so clean the printhead only when necessary. The cleaning process takes a few minutes. Some noise might be generated in the process.

- a. Load letter, A4, or legal unused plain white paper into the input tray.
 - b. Open the HP printer software. For more information, see [Open the HP printer software \(Windows\)](#).
 - c. In the printer software, under **Print, Scan, & Fax**, in the **Print** section, click **Maintain Your Printer** to access the printer toolbox.
 - d. Click **Clean Printheads** on the **Device Services** tab. Follow the onscreen instructions.
8. If cleaning the printhead does not solve the problem, contact HP support. Go to www.support.hp.com. This website provides information and utilities that can help you correct many common printer problems. If prompted, select your country/region, and then click **All HP Contacts** for information on calling for technical support.

To improve print quality (OS X)

1. Make sure you are using original HP cartridges.
2. Check the paper type.

For best print quality, use high quality HP paper, or papers that adhere to the ColorLok® standard. For more information, see [Paper basics](#).

Always make sure the paper you are printing on is flat. For best results when printing images, use HP Advanced Photo Paper.

Store specialty paper in its original packaging inside a resealable plastic bag on a flat surface in a cool, dry place. When you are ready to print, remove only the paper you plan to use immediately. When you have finished printing, return any unused photo paper to the plastic bag. This prevents the photo paper from curling.

3. Make sure you have selected the appropriate paper type and print quality in the **Print** dialog.
4. Check the estimated ink levels to determine if the cartridges are low on ink.
Consider replacing the print cartridges if they are low on ink.
5. Align the printhead.

To align the printhead from the software

- a. Load Letter or A4 plain, white paper in the input tray.
- b. Open HP Utility.



NOTE: HP Utility is located in the **HP** folder in the **Applications** folder.

- c. Select your printer from the list of devices at the left of the window.
 - d. Click **Align**.
 - e. Click **Align** and follow the onscreen instructions.
 - f. Click **All Settings** to return to the **Information and Support** pane.
6. Print a test page.

To print a test page

- a. Load Letter or A4 plain, white paper in the input tray.
- b. Open HP Utility.



NOTE: HP Utility is located in the **HP** folder in the **Applications** folder.

- c. Select your printer from the list of devices at the left of the window.
 - d. Click **Test Page**.
 - e. Click the **Print Test Page** button, and follow the onscreen instructions.
7. If the diagnostic page shows streaks or missing portions of the text or colored boxes, clean the printhead automatically.

To automatically clean the printhead

- a. Load Letter or A4 plain, white paper in the input tray.
- b. Open HP Utility.



NOTE: HP Utility is located in the **HP** folder in the **Applications** folder.

- c. Select your printer from the list of devices at the left of the window.
- d. Click **Clean Printheads**.
- e. Click **Clean**, and follow the onscreen instructions.



CAUTION: Clean the printhead only when necessary. Unnecessary cleaning wastes ink and shortens the life of the print head.





NOTE: If print quality still seems poor after you complete cleaning, try aligning the printhead. If print quality problems persist after cleaning and aligning, contact HP support.

- f. Click **All Settings** to return to the **Information and Support** pane.



To improve print quality from the printer display

1. Make sure you are using original HP cartridges.
2. Make sure you have selected the appropriate paper type and print quality.
3. Check the estimated ink levels to determine if the cartridges are low on ink. For more information, see [Check the estimated ink levels](#). If the cartridges are low on ink, consider replacing them.
4. Align the printhead.



To align the printhead from the printer display

- a. Load A4 or letter unused plain white paper into the input tray.
 - b. On the printer control panel display, from the Home screen, swipe left to see  (**Setup**) and touch  (**Setup**).
 - c. Touch **Tools**, touch **Align Printer**, and then follow the onscreen instructions.
5. Print a diagnostics page if the cartridges are not low on ink.

To print a diagnostics page from the printer display

- a. Load A4 or letter unused plain white paper into the input tray.
 - b. On the printer control panel display, from the Home screen, swipe left to see  (**Setup**) and touch  (**Setup**).
 - c. Touch **Tools**, and then touch **Print Quality Report**.
6. Review the blue, magenta, yellow, and black boxes on the diagnostics page. If you are seeing streaks in the color and black boxes, or no ink in portions of the boxes, then automatically clean the printhead.

To clean the printhead from the printer display

- a. Load A4 or letter unused plain white paper into the input tray.
 - b. On the printer control panel display, from the Home screen, swipe left to see  (**Setup**) and touch  (**Setup**).
 - c. Touch **Tools** , touch **Clean Printhead**, and then follow the onscreen instructions.
7. If cleaning the printhead does not solve the problem, contact HP support. Go to www.support.hp.com . This website provides information and utilities that can help you correct many common printer problems. If prompted, select your country/region, and then click **All HP Contacts** for information on calling for technical support.

Copy issues

Troubleshoot copy problems	Use an HP online troubleshooting wizard. Get step-by-step instructions if the printer does not create a copy, or if your printouts are low quality.
--	--

 **NOTE:** The HP online troubleshooting wizards may not be available in all languages.

[Tips for copy and scan success](#)

Scan issues

HP Print and Scan Doctor	The HP Print and Scan Doctor is a utility that will try to diagnose and fix the issue automatically. NOTE: This utility is only available for Windows operating system.
Solve scan problems	Use an HP online troubleshooting wizard. Get step-by-step instructions if you cannot create a scan or if your scans are low quality.

 **NOTE:** The HP Print and Scan Doctor and the HP online troubleshooting wizards may not be available in all languages.

[Tips for copy and scan success](#)

Fax issues

Run the fax test report first to see if there is a problem with your fax setup. If the test passes and you are still having problems faxing, check the fax settings listed in the report to verify that the settings are correct.

Run the fax test

You can test your fax setup to check the status of the printer and to make sure it is set up correctly for faxing. Perform this test only after you have completed fax setup on the printer. The test does the following:

- Tests the fax hardware
- Verifies that the correct type of phone cord is connected to the printer
- Checks that the phone cord is plugged into the correct port
- Checks for a dial tone
- Tests the status of your phone line connection
- Checks for an active phone line

To test fax setup via the printer control panel

1. Set up the printer for faxing according to your particular home or office setup instructions.
2. Make sure the cartridges are installed and that full-size paper is loaded in the input tray before starting the test.
3. From the printer control panel display, on the Home screen, touch **Fax**, touch **Setup**, touch **Setup Wizard**, and then follow the onscreen instructions.

The printer displays the status of the test on the display and prints a report.

4. Review the report.
 - If the fax test failed, review the solutions below.
 - If the fax test passed and you are still having problems faxing, verify that the fax settings listed in the report are correct. You can also use HP's online troubleshooting wizard.

What to do if the fax test failed

If you ran a fax test and the test failed, review the report for basic information about the error. For more detailed information, check the report to see which part of the test failed, and then review the appropriate topic in this section for solutions to try.

The "Fax Hardware Test" failed

- Turn the printer off by pressing  (the Power button) located on the front left side of the printer and then unplug the power cord from the back of the printer. After a few seconds, plug the power cord in again, and then turn the power on. Run the test again. If the test fails again, continue reviewing the troubleshooting information in this section.
- Try to send or receive a test fax. If you can send or receive a fax successfully, there might not be a problem.
- If you are running the test from the **Fax Setup Wizard** (Windows) or **HP Utility** (OS X), make sure the printer is not busy completing another task, such as receiving a fax or making a copy. Check the display for a message indicating that the printer is busy. If it is busy, wait until it is finished and in the idle state before running the test.
- If you are using a phone splitter, this can cause faxing problems. (A splitter is a two-cord connector that plugs into a telephone wall jack.) Try removing the splitter and connecting the printer directly to the telephone wall jack.

After you resolve any problems found, run the fax test again to make sure it passes and the printer is ready for faxing. If the **Fax Hardware Test** continues to fail and you experience problems faxing, contact HP support. Go to www.support.hp.com. This website provides information and utilities that can help you correct many common printer problems. If prompted, select your country/region, and then click **All HP Contacts** for information on calling for technical support.

The "Fax Connected to Active Telephone Wall Jack" test failed

- Check the connection between the telephone wall jack and the printer to make sure the phone cord is secure.
- Connect one end of the phone cord to your telephone wall jack, then connect the other end to the port labeled 1-LINE on the back of the printer.
- If you are using a phone splitter, this can cause faxing problems. (A splitter is a two-cord connector that plugs into a telephone wall jack.) Try removing the splitter and connecting the printer directly to the telephone wall jack.
- Try connecting a working phone and phone cord to the telephone wall jack that you are using for the printer and check for a dial tone. If you do not hear a dial tone, contact your telephone company and have them check the line.
- Try to send or receive a test fax. If you can send or receive a fax successfully, there might not be a problem.

After you resolve any problems found, run the fax test again to make sure it passes and the printer is ready for faxing.

The "Phone Cord Connected to Correct Port on Fax" test failed

If you are using a phone splitter, this can cause faxing problems. (A splitter is a two-cord connector that plugs into a telephone wall jack.) Try removing the splitter and connecting the printer directly to the telephone wall jack.

Plug the phone cord into the correct port

1. Connect one end of the phone cord to your telephone wall jack, then connect the other end to the port labeled 1-LINE on the back of the printer.



NOTE: If you use the 2-EXT port to connect to the telephone wall jack, you cannot send or receive faxes. The 2-EXT port should only be used to connect other equipment, such as an answering machine.

Figure 10-1 Back view of the printer

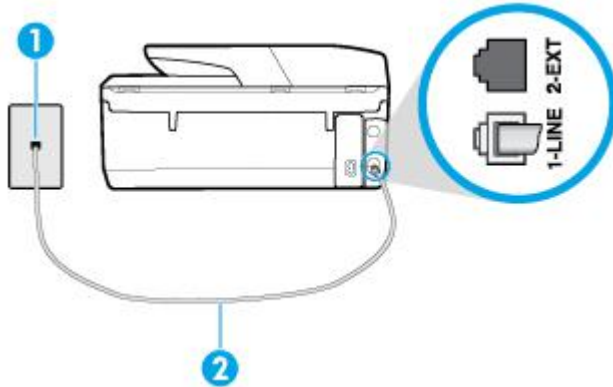

1 Telephone wall jack.

2 Connect the phone cord to the port labelled 1-LINE on the back of the printer.

2. After you have connected the phone cord to the port labeled 1-LINE, run the fax test again to make sure it passes and the printer is ready for faxing.
3. Try to send or receive a test fax.

The "Using Correct Type of Phone Cord with Fax" test failed

- Connect one end of the phone cord to your telephone wall jack, then connect the other end to the port labeled 1-LINE on the back of the printer.

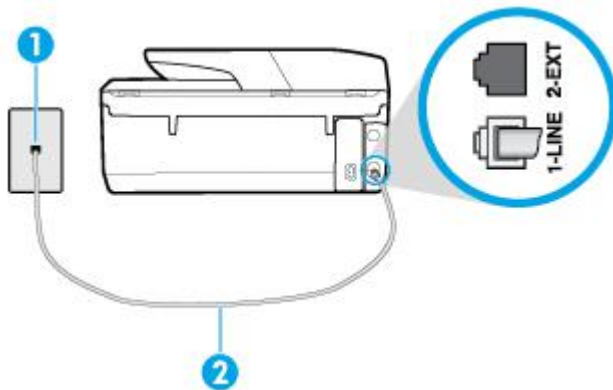

1 Telephone wall jack.

2 Connect the phone cord to the port labelled 1-LINE on the back of the printer.

- Check the connection between the telephone wall jack and the printer to make sure the phone cord is secure.
- If you are using a phone splitter, this can cause faxing problems. (A splitter is a two-cord connector that plugs into a telephone wall jack.) Try removing the splitter and connecting the printer directly to the telephone wall jack.

The "Dial Tone Detection" test failed

- Other equipment, which uses the same phone line as the printer, might be causing the test to fail. To find out if other equipment is causing a problem, disconnect everything from the phone line, and then run the test again. If the **Dial Tone Detection Test** passes without the other equipment, then one or more pieces of the equipment is causing problems; try adding them back one at a time and rerunning the test each time, until you identify which piece of equipment is causing the problem.
- Try connecting a working phone and phone cord to the telephone wall jack that you are using for the printer and check for a dial tone. If you do not hear a dial tone, contact your telephone company and have them check the line.
- Connect one end of the phone cord to your telephone wall jack, then connect the other end to the port labeled 1-LINE on the back of the printer.
- If you are using a phone splitter, this can cause faxing problems. (A splitter is a two-cord connector that plugs into a telephone wall jack.) Try removing the splitter and connecting the printer directly to the telephone wall jack.
- If your telephone system is not using a standard dial tone, such as some private branch exchange (PBX) systems, this might cause the test to fail. This does not cause a problem sending or receiving faxes. Try sending or receiving a test fax.
- Check to make sure the country/region setting is set appropriately for your country/region. If the country/region setting is not set or is set incorrectly, the test might fail and you might have problems sending and receiving faxes.
- Make sure you connect the printer to an analog phone line or you cannot send or receive faxes. To check if your phone line is digital, connect a regular analog phone to the line and listen for a dial tone. If you do not hear a normal sounding dial tone, it might be a phone line set up for digital phones. Connect the printer to an analog phone line and try sending or receiving a fax.

After you resolve any problems found, run the fax test again to make sure it passes and the printer is ready for faxing. If the **Dial Tone Detection** test continues to fail, contact your telephone company and have them check the phone line.

The "Fax Line Condition" test failed

- Make sure you connect the printer to an analog phone line or you cannot send or receive faxes. To check if your phone line is digital, connect a regular analog phone to the line and listen for a dial tone. If you do not hear a normal sounding dial tone, it might be a phone line set up for digital phones. Connect the printer to an analog phone line and try sending or receiving a fax.
- Check the connection between the telephone wall jack and the printer to make sure the phone cord is secure.
- Connect one end of the phone cord to your telephone wall jack, then connect the other end to the port labeled 1-LINE on the back of the printer.
- Other equipment, which uses the same phone line as the printer, might be causing the test to fail. To find out if other equipment is causing a problem, disconnect everything from the phone line, and then run the test again.
 - If the **Fax Line Condition Test** passes without the other equipment, then one or more pieces of the equipment is causing problems; try adding them back one at a time and rerunning the test each time, until you identify which piece of equipment is causing the problem.
 - If the **Fax Line Condition Test** fails without the other equipment, connect the printer to a working phone line and continue reviewing the troubleshooting information in this section.

- If you are using a phone splitter, this can cause faxing problems. (A splitter is a two-cord connector that plugs into a telephone wall jack.) Try removing the splitter and connecting the printer directly to the telephone wall jack.

After you resolve any problems found, run the fax test again to make sure it passes and the printer is ready for faxing. If the **Fax Line Condition** test continues to fail and you experience problems faxing, contact your telephone company and have them check the phone line.

Troubleshoot fax problems

Troubleshoot fax problems	Use an HP online troubleshooting wizard. Resolve problems sending or receiving a fax or faxing to your computer.
---	---



NOTE: The HP online troubleshooting wizards may not be available in all languages.



Read general instructions in the Help for specific fax problems

What kind of fax problem are you having?

The display always shows Phone Off Hook

- HP recommends using a 2-wire phone cord.
- Other equipment that uses the same phone line as the printer might be in use. Make sure extension phones (phones on the same phone line, but not connected to the printer) or other equipment are not in use or off the hook. For example, you cannot use the printer for faxing if an extension phone is off the hook, or if you are using a computer dial-up modem to send email or access the Internet.

The printer is having problems sending and receiving faxes

- Make sure the printer is turned on. Look at the display on the printer. If the display is blank and  (the Power button) light is not lit, the printer is turned off. Make sure the power cord is firmly connected to the printer and plugged into a power outlet. Press  (the Power button) to turn on the printer.

After turning on the printer, HP recommends you wait five minutes before sending or receiving a fax. The printer cannot send or receive faxes while it is initializing after being turned on.

- If HP Digital Fax has been enabled, you might not be able to send or receive faxes if the fax memory is full (limited by printer memory).

- Make sure you used the phone cord supplied in the box with the printer to connect to the telephone wall jack. One end of the phone cord should be connected to the port labeled 1-LINE on the back of the printer and the other end to your telephone wall jack, as shown in the illustration.

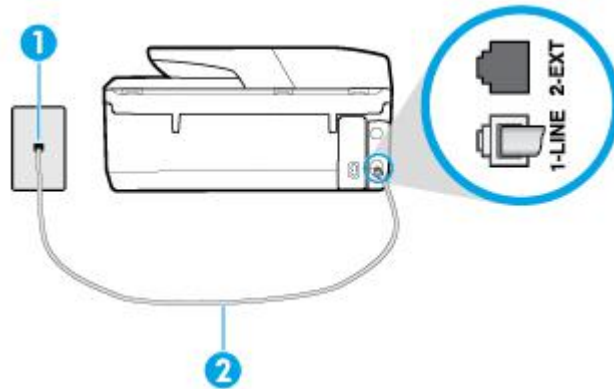

1	Telephone wall jack.
2	Connect the phone cord to the port labelled 1-LINE on the back of the printer.

- Try connecting a working phone and phone cord to the telephone wall jack that you are using for the printer and check for a dial tone. If you do not hear a dial tone, call your local telephone company for service.
- Other equipment, which uses the same phone line as the printer, might be in use. For example, you cannot use the printer for faxing if an extension phone is off the hook, or if you are using a computer dial-up modem to send an email or access the Internet.
- Check to see if another process has caused an error. Check the display or your computer for an error message providing information about the problem and how to solve it. If there is an error, the printer cannot send or receive a fax until the error condition is resolved.
- The phone line connection might be noisy. Phone lines with poor sound quality (noise) can cause faxing problems. Check the sound quality of the phone line by plugging a phone into the telephone wall jack and listening for static or other noise. If you hear noise, turn **Error Correction Mode (ECM)** off and try faxing again. If the problem persists, contact your telephone company.
- If you are using a digital subscriber line (DSL) service, make sure that you have a DSL filter connected or you cannot fax successfully.
- Make sure the printer is not connected to a telephone wall jack that is set up for digital phones. To check if your phone line is digital, connect a regular analog phone to the line and listen for a dial tone. If you do not hear a normal sounding dial tone, it might be a phone line set up for digital phones.
- If you are using either a private branch exchange (PBX) or an integrated services digital network (ISDN) converter/terminal adapter, make sure the printer is connected to the correct port and the terminal adapter is set to the correct switch type for your country/region, if possible.
- If the printer shares the same phone line with a DSL service, the DSL modem might not be grounded correctly. If the DSL modem is not grounded correctly, it can create noise on the phone line. Phone lines with poor sound quality (noise) can cause faxing problems. You can check the sound quality of the phone line by plugging a phone into the telephone wall jack and listening for static or other noise. If you hear noise, turn off your DSL modem and completely remove power for at least 15 minutes. Turn the DSL modem back on and listen to the dial tone again.

 **NOTE:** You might notice static on the phone line again in the future. If the printer stops sending and receiving faxes, repeat this process.

If the phone line is still noisy, contact your telephone company. For information on turning your DSL modem off, contact your DSL provider for support.

- If you are using a phone splitter, this can cause faxing problems. (A splitter is a two-cord connector that plugs into a telephone wall jack.) Try removing the splitter and connecting the printer directly to the telephone wall jack.

The printer cannot receive faxes, but can send faxes

- If you are not using a distinctive ring service, check to make sure that the **Distinctive Ring** feature on the printer is set to **All Standard Rings**.
- If **Auto Answer** is set to **Off**, you need to receive faxes manually; otherwise, the printer cannot receive the fax.
- If you have a voice mail service at the same phone number you use for fax calls, you must receive faxes manually, not automatically. This means that you must be available to respond in person to incoming fax calls.
- If you have a computer dial-up modem on the same phone line with the printer, check to make sure that the software that came with your modem is not set to receive faxes automatically. Modems that are set up to receive faxes automatically take over the phone line to receive all incoming faxes, which prevents the printer from receiving fax calls.
- If you have an answering machine on the same phone line with the printer, you might have one of the following problems:
 - Your answering machine might not be set up correctly with the printer.
 - Your outgoing message might be too long or too loud to allow the printer to detect fax tones, and the sending fax machine might disconnect.
 - Your answering machine might not have enough quiet time after your outgoing message to allow the printer to detect fax tones. This problem is most common with digital answering machines.

The following actions might help solve these problems:

- When you have an answering machine on the same phone line you use for fax calls, try connecting the answering machine directly to the printer.
- Make sure the printer is set to receive faxes automatically.
- Make sure the **Rings to Answer** setting is set to a greater number of rings than the answering machine.
- Disconnect the answering machine and then try receiving a fax. If faxing is successful without the answering machine, the answering machine might be causing the problem.
- Reconnect the answering machine and record your outgoing message again. Record a message that is approximately 10 seconds in duration. Speak slowly and at a low volume when recording your message. Leave at least 5 seconds of silence at the end of the voice message. There should be no background noise when recording this silent time. Try to receive a fax again.



NOTE: Some digital answering machines might not retain the recorded silence at the end of your outgoing message. Play back your outgoing message to check.

- If the printer shares the same phone line with other types of phone equipment, such as an answering machine, a computer dial-up modem, or a multi-port switch box, the fax signal level might be reduced. The signal level can also be reduced if you use a splitter or connect extra cables to extend the length of your phone. A reduced fax signal can cause problems during fax reception.

To find out if other equipment is causing a problem, disconnect everything except the printer from the phone line, and then try to receive a fax. If you can receive faxes successfully without the other equipment, one or more pieces of the other equipment is causing problems; try adding them back one at a time and receiving a fax each time, until you identify which equipment is causing the problem.

- If you have a special ring pattern for your fax phone number (using a distinctive ring service through your telephone company), make sure that the **Distinctive Ring** feature on the printer is set to match.

The printer cannot send faxes, but can receive faxes

- The printer might be dialing too fast or too soon. You might need to insert some pauses in the number sequence. For example, if you need to access an outside line before dialing the phone number, insert a pause following the access number. If your number is 95555555, and 9 accesses an outside line, you might insert pauses as follows: 9-555-5555. To enter a pause in the fax number you are typing, touch the * repeatedly, until a dash (-) appears on the display.

You can also send the fax using monitor dialing. This enables you to listen to the phone line as you dial. You can set the pace of your dialing and respond to prompts as you dial.

- The number you entered when sending the fax is not in the proper format or the receiving fax machine is having problems. To check this, try calling the fax number from a telephone and listen for fax tones. If you cannot hear fax tones, the receiving fax machine might not be turned on or connected, or a voice mail service could be interfering with the recipient's phone line. You can also ask the recipient to check the receiving fax machine for any problems.

Fax tones are recorded on my answering machine

- When you have an answering machine on the same phone line you use for fax calls, try connecting the answering machine directly to the printer. If you do not connect the answering machine as recommended, fax tones might be recorded on your answering machine.
- Make sure the printer is set to receive faxes automatically and that the **Rings to Answer** setting is correct. The number of rings to answer for the printer should be greater than the number of rings to answer for the answering machine. If the answering machine and the printer are set to the same number of rings to answer, both devices answer the call and fax tones are recorded on the answering machine.
- Set your answering machine to a low number of rings and the printer to answer in the maximum number of rings supported. (The maximum number of rings varies by country/region.) In this setup, the answering machine answers the call and the printer monitors the line. If the printer detects fax tones, the printer receives the fax. If the call is a voice call, the answering machine records the incoming message.

The computer cannot receive faxes (HP Digital Fax)

- The computer selected to receive faxes is turned off. Make sure the computer selected to receive faxes is switched on at all times.
- Different computers are configured for setup and receiving faxes and one of them may be switched off. If the computer receiving faxes is different from the one used for setup, both computers should be switched on at all times.
- HP Digital Fax is not activated or the computer is not configured to receive faxes. Activate HP Digital Fax and make sure the computer is configured to receive faxes.

Network and connection issues

What do you want to do?

Fix wireless connection

Choose one of the following troubleshooting options.

HP Print and Scan Doctor	The HP Print and Scan Doctor is a utility that will try to diagnose and fix the issue automatically. NOTE: This utility is only available for Windows operating system.
Use an HP online troubleshooting wizard	<ul style="list-style-type: none">• Troubleshoot your wireless problem, whether your printer has never been connected or it was connected and is no longer working.• Troubleshoot a firewall or antivirus issue, if you suspect that it is preventing your computer from connecting to the printer.

 **NOTE:** The HP Print and Scan Doctor and the HP online troubleshooting wizards may not be available in all languages.

Read general instructions in the Help for wireless troubleshooting

Check the network configuration or print the wireless test report to assist in diagnosing network connection issues.

1. From the printer control panel display, touch  (Wireless), and then touch  (**Settings**).
2. Touch **Print Reports**, and then touch **Network Configuration Page** or **Wireless Test Report**.

Find network settings for wireless connection

Choose one of the following troubleshooting options.

HP Print and Scan Doctor	The HP Print and Scan Doctor is a utility that can tell you the network name (SSID) and password (network key). NOTE: This utility is only available for Windows operating system. The Windows computer you are running the HP Print and Scan Doctor on should be connected to the network using a wireless connection. To check the wireless settings, open the HP Print and Scan Doctor, click on the Network tab at the top, select Show Advanced Info , and then select Show Wireless Info . You can also find the wireless settings by clicking on the Network tab at the top and selecting Open router web page .
Use an HP online troubleshooting wizard	Learn how to find your network name (SSID) and wireless password.

 **NOTE:** The HP Print and Scan Doctor and the HP online troubleshooting wizards may not be available in all languages.

Fix Wi-Fi Direct connection

Use an HP online troubleshooting wizard	Troubleshoot your Wi-Fi Direct problem or learn how to configure Wi-Fi Direct.
---	--

 **NOTE:** The HP online troubleshooting wizards may not be available in all languages.

Read general instructions in the Help for Wi-Fi Direct troubleshooting

1. Check the printer to confirm that Wi-Fi Direct is turned on:
 - ▲ On the printer control panel display, from the Home screen, touch  (Wi-Fi Direct).
2. From your wireless computer or mobile device, turn on the Wi-Fi connection, and then search for and connect to the Wi-Fi Direct name of your printer.
3. Enter the Wi-Fi Direct password when prompted.
4. If you are using a mobile device, make sure you have installed a compatible printing app. For more information about mobile printing, visit www.hp.com/global/us/en/eprint/mobile_printing_apps.html.

Printer hardware issues

 **TIP:** Run the [HP Print and Scan Doctor](#) to diagnose and automatically fix printing, scanning, and copying issues. The application is only available in some languages.

The printer shuts down unexpectedly

- Check the power and power connections.
- Make sure the printer's power cord is connected firmly to a functioning power outlet.

Printhead alignment fails

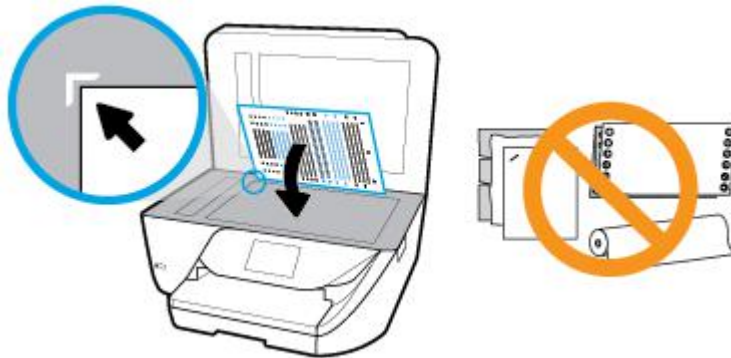

- Check that you have placed the printed page face down and properly aligned on the scanner as shown in the diagram.



- If the alignment process fails, make sure you have loaded unused, plain white paper into the input tray. If you have colored paper loaded in the input tray when you align the printhead, the alignment fails.
- If the alignment process fails repeatedly, you may need to clean the printhead, or you might have a defective sensor. To clean the printhead, see [Maintain the printhead and cartridges](#).
- If cleaning the printhead does not solve the problem, contact HP support. Go to www.support.hp.com. This website provides information and utilities that can help you correct many common printer problems. If prompted, select your country/region, and then click **All HP Contacts** for information on calling for technical support.

Resolve printer failure

Complete the following steps to resolve such problems.

1. Press  (the Power button) to turn off the printer.
2. Unplug the power cord, and then plug in the power cord again.
3. Press  (the Power button) to turn on the printer.

If this problem persists, write down the error code provided in the message, and then contact HP support. For more information about contacting HP support, see [HP support](#).

Get help from the printer control panel

You can use the printer's help topics to learn more about the printer, and some help topics include animations that guide you through procedures, such as loading paper.



To access the Help menu from the Home screen or contextual help for a screen, touch  on the printer control panel.

Understand printer reports

You can print the following reports to help troubleshoot problems with the printer.

- [Printer status report](#)
- [Network configuration page](#)
- [Print quality report](#)
- [Wireless test report](#)
- [Web access test report](#)

To print a printer report

1. From the printer control panel display, on the Home screen, swipe left to see  (**Setup**) and touch  (**Setup**).
2. Touch **Tools**.
3. Touch the desired option.

Printer status report

Use the printer status report to view current printer information and cartridge status. Also use the printer status report to help you troubleshoot problems with the printer.

The printer status report also contains a log of recent events.

If you need to call HP, it is often useful to print the printer status report before calling.

Network configuration page

If the printer is connected to a network, you can print a network configuration page to view the network settings for the printer and a list of networks detected by your printer. The last page of the report includes a list of all detectable wireless networks in the area, along with signal strength and the channels being used. This might help you select a channel for your network which is not heavily used by other networks (which will improve network performance).



NOTE: In order to get the list of detected wireless networks in the area, the wireless radio on the printer should be turned on. If it is off the list is not displayed.

You can use the network configuration page to help troubleshoot network connectivity problems. If you need to call HP, it is often useful to print this page before calling.

Print quality report

Print quality problems can have many causes—software settings, a poor image file, or the printing system itself. If you are unhappy with the quality of your prints, a Print Quality Report page can help you determine if the printing system is working correctly.

Wireless test report

When you print the Wireless Test Report, a number of tests are run to check various conditions of the printer wireless connection. The report shows the results of the tests. If an issue is discovered, message along with how to fix it is provided at the top of the report. Some key wireless configuration details are provided at the bottom section of the report.

Web access test report

Print the web access report to help identify internet connectivity issues which can affect Web Services.

Solve problems using Web Services

If you are having problems using Web Services, such as **HP ePrint**, check the following:

- Make sure the printer is connected to the Internet using an wireless connection.



NOTE: You cannot use these web features if the printer is connected using a USB cable.

- Make sure the latest product updates have been installed on the printer.
- Make sure Web Services is enabled on the printer. For more information, see [Set up Web Services](#).
- Make sure the network hub, switch, or router is turned on and working correctly.
- If you are connecting the printer using a wireless connection, make sure the wireless network is functioning properly. For more information, see [Network and connection issues](#).
- If you are using **HP ePrint**, check the following:
 - Make sure the printer's email address is correct.
 - Make sure that the printer's email address is the only address listed in the “To” line of the email message. If other email addresses are listed in the “To” line, the attachments you are sending might not print.
 - Make sure you are sending documents that meet the **HP ePrint** requirements. For more information, visit [HP Connected](#) This site might not be available in all countries/regions..

- If your network uses proxy settings when connecting to the Internet, make sure the proxy settings you are entering are valid:
 - Check the settings being used by the web browser you are using (such as Internet Explorer, Firefox, or Safari).
 - Check with the IT administrator or person who set up your firewall.

If the proxy settings used by your firewall have changed, you must update these settings in either the printer control panel or the embedded web server. If these settings are not updated, you will not be able to use Web Services.

For more information, see [Set up Web Services](#).

 **TIP:** For additional help on setting up and using Web Services, visit [HP Connected](#). This site might not be available in all countries/regions.



Maintain the printer

What do you want to do?

Clean the scanner glass

Dust or dirt on the scanner glass, scanner lid backing, or scanner frame can slow down performance, degrade the quality of scans, and affect the accuracy of special features such as fitting copies to a certain page size.

To clean the scanner glass

 **WARNING!** Before cleaning the printer, turn the printer off by pressing  (the Power button) and unplugging the power cord from the electrical socket.

1. Lift the scanner lid.

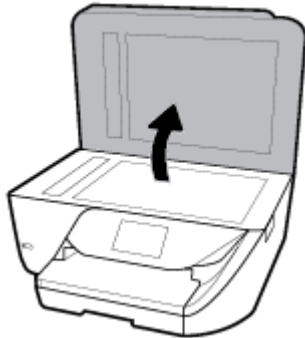

2. Clean the scanner glass and lid backing by using a soft, lint-free cloth that has been sprayed with a mild glass cleaner.



⚠ CAUTION: Use only glass cleaner to clean the scanner glass. Avoid cleaners that contain abrasives, acetone, benzene, and carbon tetrachloride, all of which can damage the scanner glass. Avoid isopropyl alcohol because it can leave streaks on the scanner glass.

CAUTION: Do not spray the glass cleaner directly on the scanner glass. If too much glass cleaner is applied, the cleaner could leak under the scanner glass and damage the scanner.

3. Close the scanner lid, and turn on the printer.

Clean the exterior

⚠ WARNING! Before cleaning the printer, turn the printer off by pressing  (the Power button) and unplug the power cord from the electrical socket.

Use a soft, damp, lint-free cloth to wipe dust, smudges, and stains off of the case. Keep fluids away from the interior of the printer, as well as from the printer control panel.

Clean the document feeder

If the document feeder picks up multiple pages or if it does not pick up plain paper, you can clean the rollers and separator pad.

To clean the rollers or separator pad

⚠ WARNING! Before cleaning the printer, turn the printer off by pressing  (the Power button) and unplug the power cord from the electrical socket.

1. Remove all originals from the document feeder tray.

- Lift the document feeder cover.



This provides easy access to the rollers (1) and separator pad (2).



1	Rollers
2	Separator pad

- Lightly dampen a clean lint-free cloth with distilled water, then squeeze any excess liquid from the cloth.
- Use the damp cloth to wipe any residue off the rollers or separator pad.



NOTE: If the residue does not come off using distilled water, try using isopropyl (rubbing) alcohol.

- Close the cover of the document feeder.

Maintain the printhead and cartridges

If you are experiencing problems with printing, you might have a problem with the printhead. You should perform the procedures in the following sections only when directed to do so for resolving print quality issues.

Performing the aligning and cleaning procedures unnecessarily can waste ink and shorten the life of the cartridges.

- Clean the printhead if your printed output is streaked or has any incorrect or missing colors.

There are three stages of cleaning. Each stage lasts about two minutes, uses one sheet of paper, and uses an increasing amount of ink. After each stage, review the quality of the printed page. You should only initiate the next phase of cleaning if the print quality is poor.



If print quality still seems poor after you complete all stages of cleaning, try aligning the printhead. If print quality problems persist after cleaning and aligning, contact HP support. For more information, see [HP support](#).

- Align the printhead when the printer status page shows streaking or white lines through any of the blocks of color, or if you are having print quality issues with your printouts.

 **NOTE:** Cleaning uses ink, so clean the printhead only when necessary. The cleaning process takes a few minutes. Some noise might be generated in the process.

Always use the Power button to turn off the printer. Turning the printer off improperly can cause print quality problems.

To clean or align the printhead



1. Load A4 or letter unused plain white paper into the input tray.
2. On the printer control panel display, from the Home screen, swipe left to see  (**Setup**) and touch  (**Setup**).
3. Touch **Tools** , touch **Clean Printhead** or **Align Printer**, and then follow the onscreen instructions.

 **NOTE:** You can also do the same from the HP printer software or embedded web server (EWS). To access the software or EWS, see [Open the HP printer software \(Windows\)](#) or [Open the embedded web server](#) .



Restore original factory defaults and settings

If you disable some functions or change some settings and want to change them back, you can restore the printer to the original factory settings or network settings.

To restore the printer to the original factory defaults

1. On the printer control panel display, from the Home screen, swipe left to see  (**Setup**) and touch  (**Setup**).
2. Touch **Tools** , touch **Restore Factory Defaults**, and then follow the onscreen instructions.

To restore the printer to the original network settings

1. From the Home screen, touch  (Wireless) and then touch  (**Settings**).
2. Touch **Restore Network Settings**, and then follow the onscreen instructions.
3. Print the network configuration page and verify that the network settings have been reset.

 **NOTE:** When you reset the printer network settings, previously configured wireless settings (such as the link speed or IP address) are removed. The IP address is set back to the Automatic mode.

 **TIP:** You can visit the HP online support website at www.support.hp.com for information and utilities that can help you correct many common printer problems.

(Windows) Run the [HP Print and Scan Doctor](#) to diagnose and automatically fix printing, scanning, and copying issues. The application is only available in some languages.

HP support

For the latest product updates and support information, visit the printer support website at www.support.hp.com. HP online support provides a variety of options for help with your printer:



Drivers & downloads: Download software drivers and updates, as well as product manuals and documentation that came in the box with your printer.



HP support forums: Visit HP Support Forums for answers to common questions and issues. You can view questions posted by other HP customers, or sign in and post your own questions and comments.



Troubleshooting: Use HP online tools to detect your printer and find recommended solutions.

Contact HP

If you need help from an HP technical support representative to solve a problem, visit the [Contact Support website](#). The following contact options are available at no cost for in-warranty customers (HP agent-assisted support for out-of-warranty customers may require a fee):



Chat with an HP support agent online.



Call an HP support agent.

When contacting HP support, be prepared to provide the following information:

- Product name (Located on the printer, such as HP OfficeJet 6950)
- Product number (located near the cartridge access area)



- Serial number (located on the back or bottom of the printer)

Register printer

By taking just a few quick minutes to register, you can enjoy quicker service, more efficient support, and product support alerts. If you did not register your printer while installing the software, you can register now at <http://www.register.hp.com>.

Additional warranty options

Extended service plans are available for the printer at additional costs. Go to www.support.hp.com, select your country/region and language, then explore the extended warranty options available for your printer.

A Technical information

This section contains the following topics:

- [Specifications](#)
- [Regulatory information](#)
- [Environmental product stewardship program](#)

Specifications

For more information, visit www.support.hp.com. Select your country or region. Click **Product Support & Troubleshooting**. Enter the name shown on the front of the printer, and then select **Search**. Click **Product information**, and then click **Product specifications**.

System requirements

- For information about software and system requirements or future operating system releases and support, visit the HP online support website at www.support.hp.com.

Environmental specifications

- Operating temperature: 5° to 40° C (41° to 104° F)
- Operating humidity: 15 to 80% RH non-condensing
- Recommended operating conditions: 15° to 32° C (59° to 90° F)
- Recommended relative humidity: 20 to 80% noncondensing

Input tray capacity

- Plain paper sheets (60 to 105 g/m² [16 to 28 lb]): Up to 225
- Envelopes: Up to 10
- Index cards: Up to 60
- Photo paper sheets: Up to 60

Output tray capacity

- Plain paper sheets (60 to 105 g/m² [16 to 28 lb]): Up to 60 (text printing)

Document feeder capacity

- Plain paper sheets (60 to 90 g/m² [16 to 24 lb]): Up to 35

Paper size and weights

For the list of supported paper sizes, see the HP printer software.

- Plain paper: 60 to 105 g/m² (16 to 28 lb)
- Envelopes: 75 to 90 g/m² (20 to 24 lb)

- Cards: Up to 200 g/m² (110-lb index maximum)
- Photo paper: Up to 280 g/m² (75 lb)

Print specifications

- Print speeds vary according to the complexity of the document and printer model
- Method: drop-on-demand thermal inkjet
- Language: PCL3 GUI
- Print resolution:
For a list of supported print resolutions, visit the printer support website at www.support.hp.com.
- Print margins:
For margin settings of different media, visit the printer support website at www.support.hp.com.

Copy specifications

- Digital image processing
- Copy speeds vary according to the selected copy quality.

Scan specifications

- Resolution: Up to 1200 x 1200 ppi optical
For more information about scan resolution, see the HP printer software.
- Color: 24-bit color, 8-bit grayscale (256 levels of gray)
- Maximum scan size:
 - Scanner glass: 216 x 297 mm (8.5 x 11.7 inches)
 - Document feeder: 216 x 356 mm (8.5 x 14 inches)

Fax specifications

- Walk-up black-and-white and color fax capability.
- Manual fax send and receive.
- Automatic busy redial up to five times (varies by country/region).
- Automatic no-answer redial up to two times (varies by country/region).
- Automatic communication problem redial up to five times (varies by country/region).
- Confirmation and activity reports.
- CCITT/ITU Group 3 fax with Error Correction Mode.
- Up to 33.6 Kbps transmission.
- 4 seconds per page speed at 33.6 Kbps (based on ITU-T Test Image #1 at standard resolution). More complicated pages or higher resolution takes longer and uses more memory.
- Ring detect with automatic fax/answering machine switching.
- Fax resolution:

	Photo (dpi)	Very Fine (dpi)	Fine (dpi)	Standard (dpi)
Black	203 x 196	300 x 300	203 x 196	203 x 98
Color	200 x 200	200 x 200	200 x 200	200 x 200

- Fax to PC specifications
 - Supported file types: TIFF and PDF
 - Supported fax types: black-and-white faxes

Cartridge yield

- Visit www.hp.com/go/learnaboutsupplies for more information on estimated cartridge yields.

Regulatory information

The printer meets product requirements from regulatory agencies in your country/region.

This section contains the following topics:

- [Regulatory model identification number](#)
- [FCC statement](#)
- [Notice to users in Korea](#)
- [VCCI \(Class B\) compliance statement for users in Japan](#)
- [Notice to users in Japan about the power cord](#)
- [Noise emission statement for Germany](#)
- [Visual display workplaces statement for Germany](#)
- [Notice to users of the U.S. telephone network: FCC requirements](#)
- [Notice to users of the Canadian telephone network](#)
- [Notice to users of the German telephone network](#)
- [Australia wired fax statement](#)
- [European Union Regulatory Notice](#)
 - [Products with external AC Adapters](#)
 - [Products with wireless functionality](#)
 - [European telephone network declaration \(Modem/Fax\)](#)
- [Declaration of conformity](#)
- [Regulatory information for wireless products](#)
 - [Exposure to radio frequency radiation](#)
 - [Notice to users in Brazil](#)
 - [Notice to users in Canada](#)
 - [Notice to users in Taiwan](#)
 - [Notice to users in Mexico](#)

- [Notice to users in Japan](#)
- [Notice to users in Korea](#)

Regulatory model identification number

For regulatory identification purposes, your product is assigned a Regulatory Model Number. The Regulatory Model Number for your product is SNPRC-1501-02. This regulatory number should not be confused with the marketing name (HP OfficeJet 6950 All-in-One series, etc.) or product numbers (P4C78A, etc.).

FCC statement

FCC statement

The United States Federal Communications Commission (in 47 CFR 15.105) has specified that the following notice be brought to the attention of users of this product.

This equipment has been tested and found to comply with the limits for a Class B digital device, pursuant to Part 15 of the FCC Rules. These limits are designed to provide reasonable protection against harmful interference in a residential installation. This equipment generates, uses and can radiate radio frequency energy and, if not installed and used in accordance with the instructions, may cause harmful interference to radio communications. However, there is no guarantee that interference will not occur in a particular installation. If this equipment does cause harmful interference to radio or television reception, which can be determined by turning the equipment off and on, the user is encouraged to try to correct the interference by one or more of the following measures:

- Reorient or relocate the receiving antenna.
- Increase the separation between the equipment and the receiver.
- Connect the equipment into an outlet on a circuit different from that to which the receiver is connected.
- Consult the dealer or an experienced radio/TV technician for help.

For further information, contact:

Manager of Corporate Product Regulations
HP Inc. 1501 Page Mill Road,
Palo Alto, CA 94304, U.S.A.

Modifications (part 15.21)

The FCC requires the user to be notified that any changes or modifications made to this device that are not expressly approved by HP may void the user's authority to operate the equipment.

This device complies with Part 15 of the FCC Rules. Operation is subject to the following two conditions: (1) this device may not cause harmful interference, and (2) this device must accept any interference received, including interference that may cause undesired operation.

Notice to users in Korea

B 급 기기 (가정용 방송통신기기)	이 기기는 가정용(B급)으로 전자파적합등록을 한 기기로서 주로 가정에서 사용하는 것을 목적으로 하며, 모든 지역에서 사용할 수 있습니다.
------------------------	--

VCCI (Class B) compliance statement for users in Japan

<p>この装置は、クラスB情報技術装置です。この装置は、家庭環境で使用することを目的としていますが、この装置がラジオやテレビジョン受信機に近接して使用されると、受信障害を引き起こすことがあります。取扱説明書に従って正しい取り扱いをして下さい。</p> <p>VCCI-B</p>

Notice to users in Japan about the power cord

<p>製品には、同梱された電源コードをお使い下さい。 同梱された電源コードは、他の製品では使用出来ません。</p>

Noise emission statement for Germany

<p>Geräuschemission LpA < 70 dB am Arbeitsplatz im Normalbetrieb nach DIN 45635 T. 19</p>
--

Visual display workplaces statement for Germany

<p>GS-Erklärung (Deutschland) Das Gerät ist nicht für die Benutzung im unmittelbaren Gesichtsfeld am Bildschirmarbeitsplatz vorgesehen. Um störende Reflexionen am Bildschirmarbeitsplatz zu vermeiden, darf dieses Produkt nicht im unmittelbaren Gesichtsfeld platziert werden.</p>
--

Notice to users of the U.S. telephone network: FCC requirements

Notice to users of the U.S. Telephone network: FCC requirements

This equipment complies with Part 68 of the FCC rules and the requirements adopted by the ACTA. On the rear (or bottom) of this equipment is a label that contains, among other information, a product identifier in the format US:AAAEQ##TXXXX. If requested, this number must be provided to the telephone company.

Applicable connector jack Universal Service Order Codes ("USOC") for the Equipment is: RJ-11C.

A plug and jack used to connect this equipment to the premises wiring and telephone network must comply with the applicable FCC Part 68 rules and requirements adopted by the ACTA. A compliant telephone cord and modular plug is provided with this product. It is designed to be connected to a compatible modular jack that is also compliant. See installation instructions for details.

The REN is used to determine the number of devices that may be connected to a telephone line. Excessive RENs on a telephone line may result in the devices not ringing in response to an incoming call. In most but not all areas, the sum of RENs should not exceed five (5.0). To be certain of the number of devices that may be connected to a line, as determined by the total RENs, contact the local telephone company. For products approved after July 23, 2001, the REN for this product is part of the product identifier that has the format US:AAAEQ##TXXXX. The digits represented by ## are the REN without a decimal point (e.g., 00 is a REN of 0.0).

If this equipment causes harm to the telephone network, the telephone company will notify you in advance that temporary discontinuance of service may be required. But if advance notice isn't practical, the telephone company will notify the customer as soon as possible. Also, you will be advised of your right to file a complaint with the FCC if you believe it is necessary.

The telephone company may make changes in its facilities, equipment, operations or procedures that could affect the operation of the equipment. If this happens the telephone company will provide advance notice in order for you to make necessary modifications to maintain uninterrupted service.

If trouble is experienced with this equipment, please contact the manufacturer, or look elsewhere in this manual, for repair or warranty information. If the equipment is causing harm to the telephone network, the telephone company may request that you disconnect the equipment until the problem is resolved.

Connection to party line service is subject to state tariffs. Contact the state public utility commission, public service commission or corporation commission for information.

If your home has specially wired alarm equipment connected to the telephone line, ensure the installation of this equipment does not disable your alarm equipment. If you have questions about what will disable alarm equipment, consult your telephone company or a qualified installer.

WHEN PROGRAMMING EMERGENCY NUMBERS AND/OR MAKING TEST CALLS TO EMERGENCY NUMBERS:

- 1) Remain on the line and briefly explain to the dispatcher the reason for the call.
- 2) Perform such activities in the off-peak hours, such as early morning or late evenings.



Note The FCC hearing aid compatibility rules for telephones are not applicable to this equipment.

The Telephone Consumer Protection Act of 1991 makes it unlawful for any person to use a computer or other electronic device, including FAX machines, to send any message unless such message clearly contains in a margin at the top or bottom of each transmitted page or on the first page of the transmission, the date and time it is sent and an identification of the business or other entity, or other individual sending the message and the telephone number of the sending machine or such business, other entity, or individual. (The telephone number provided may not be a 900 number or any other number for which charges exceed local or long distance transmission charges.)

In order to program this information into your FAX machine, you should complete the steps described in the software.

Notice to users of the Canadian telephone network

Note à l'attention des utilisateurs du réseau téléphonique Canadien/notice to users of the Canadian telephone network

Cet appareil est conforme aux spécifications techniques des équipements terminaux d'Industrie Canada. Le numéro d'enregistrement atteste de la conformité de l'appareil. L'abréviation IC qui précède le numéro d'enregistrement indique que l'enregistrement a été effectué dans le cadre d'une Déclaration de conformité stipulant que les spécifications techniques d'Industrie Canada ont été respectées. Néanmoins, cette abréviation ne signifie en aucun cas que l'appareil a été validé par Industrie Canada.

Pour leur propre sécurité, les utilisateurs doivent s'assurer que les prises électriques reliées à la terre de la source d'alimentation, des lignes téléphoniques et du circuit métallique d'alimentation en eau sont, le cas échéant, branchées les unes aux autres. Cette précaution est particulièrement importante dans les zones rurales.



Remarque Le numéro REN (Ringer Equivalence Number) attribué à chaque appareil terminal fournit une indication sur le nombre maximal de terminaux qui peuvent être connectés à une interface téléphonique. La terminaison d'une interface peut se composer de n'importe quelle combinaison d'appareils, à condition que le total des numéros REN ne dépasse pas 5.

Basé sur les résultats de tests FCC Partie 68, le numéro REN de ce produit est 0.1.

This equipment meets the applicable Industry Canada Terminal Equipment Technical Specifications. This is confirmed by the registration number. The abbreviation IC before the registration number signifies that registration was performed based on a Declaration of Conformity indicating that Industry Canada technical specifications were met. It does not imply that Industry Canada approved the equipment. Users should ensure for their own protection that the electrical ground connections of the power utility, telephone lines and internal metallic water pipe system, if present, are connected together. This precaution might be particularly important in rural areas.



Note The Ringer Equivalence Number (REN) assigned to each terminal device provides an indication of the maximum number of terminals allowed to be connected to a telephone interface. The termination on an interface might consist of any combination of devices subject only to the requirement that the sum of the Ringer Equivalence Numbers of all the devices does not exceed 5.

The REN for this product is 0.1, based on FCC Part 68 test results.

Notice to users of the German telephone network

Hinweis für Benutzer des deutschen Telefonnetzes

Dieses HP-Fax ist nur für den Anschluss eines analogen Public Switched Telephone Network (PSTN) gedacht. Schließen Sie den TAE N-Telefonstecker, der im Lieferumfang des HP All-in-One enthalten ist, an die Wandsteckdose (TAE 6) Code N an. Dieses HP-Fax kann als einzelnes Gerät und/oder in Verbindung (mit seriellen Anschluss) mit anderen zugelassenen Endgeräten verwendet werden.

Australia wired fax statement

In Australia, the HP device must be connected to Telecommunication Network through a line cord which meets the requirements of the Technical Standard AS/ACIF S008.

European Union Regulatory Notice



Products bearing the CE marking comply with one or more of the following EU Directives as may be applicable: Low Voltage Directive 2006/95/EC, EMC Directive 2004/108/EC, Ecodesign Directive 2009/125/EC, R&TTE Directive 1999/5/EC, RoHS Directive 2011/65/EU. Compliance with these directives is assessed using applicable European Harmonised Standards. The full Declaration of Conformity can be found at the following website: www.hp.com/go/certificates (Search with the product model name or its Regulatory Model Number (RMN), which may be found on the regulatory label.)

The point of contact for regulatory matters is:

HP Deutschland GmbH, HQ-TRE, Schickardstrasse 32, 71034 Boeblingen, Germany

Products with external AC Adapters

CE compliance of this product is valid only if powered with the correct CE-marked AC adapter provided by HP.

Products with wireless functionality

EMF

- This product meets international guidelines (ICNIRP) for exposure to radio frequency radiation. If it incorporates a radio transmitting and receiving device that in normal use, a separation distance of 20 cm ensures that radio frequency exposure levels comply with EU requirements.

Wireless functionality in Europe

- This product is designed for use without restrictions in all EU countries plus Iceland, Liechtenstein, Norway and Switzerland.

European telephone network declaration (Modem/Fax)

HP products with FAX capability comply with the requirements of the R&TTE Directive 1999/5/EC (Annex II) and carry the CE marking accordingly. However, due to differences between the individual PSTNs provided in different countries/regions, the approval does not, of itself, give an unconditional assurance of successful operation on every PSTN network termination point. In the event of problems, you should contact your equipment supplier in the first instance.

Declaration of conformity



DECLARATION OF CONFORMITY

according to ISO/IEC 17050-1 and EN 17050-1

DoC #: SNPRC-1501-02

Supplier's Name: Hewlett-Packard Company
Supplier's Address: 138 Depot Road, #04-01, Singapore 109683
declares, that the product
Product Name and Model: HP OfficeJet Pro 6860 All-in-One Printer, HP OfficeJet Pro 6960 All-in-One Printer, HP OfficeJet Pro 6960 All-in-One Printer Series, HP OfficeJet 6950 All-in-One Printer, HP OfficeJet 6950 All-in-One Printer Series.
Regulatory Model Number:¹⁾ SNPRC-1501-02
Product Options: All
Power Adapter: Internal. A9T80-60008 (WW), A9T80-60009 (For China & India only).
Radio Module Number: SDGOB-1392

conforms to the following Product Specifications and Regulations:

EMC: CISPR22:2008 / EN55022:2010 Class B
CISPR24:2010 / EN55024:2010
EN 61000-3-2:2006+A1:2009+A2:2009
EN 61000-3-3:2008
FCC CFR 47, Part 15 / ICES - 003, Issue 5

Safety: IEC 60950-1:2005 (2nd Edition) +A1:2009
EN 60950-1:2006 +A11:2009 +A1:2010 +A12:2011
EN 62479:2010

Telecom: EN 301 489-1 V1.9.2:2011 / EN 301 489-17 V2.2.1:2012
EN 300 328 V1.8.1:2012
EN 62311:2008
FCC Rules and Regulations 47 CFR Part 68
TIA-968-B Telecommunications - Telephone Terminal Equipment Technical Requirements for Connection of Terminal Equipment to the Telephone Network (Sep 2009)
ES 203 021-2/-3 V2.1.2
CS - 03, Part 1, Issue 9, Amendment 4, December 2010

Energy: Regulation (EC) No. 1275/2008
ENERGY STAR® Qualified Imaging Equipment Operational Mode (OM) Test Procedure
EN 50564:2011
IEC 62301:2011

RoHS: EN 50581: 2012

The product herewith complies with the requirements of the Low Voltage Directive 2006/95/EC, the EMC Directive 2004/108/EC, the R&TTE Directive 1999/5/EC, the Ecodesign Directive 2009/125/EC, RoHS Directive 2011/65/EU, and carries the  marking accordingly.

This device complies with part 15 of the FCC Rules. Operation is subject to the following two conditions:

(1) This device may not cause harmful interference, and (2) this device must accept any interference received, including interference that may cause undesired operation.

Additional Information:

- 1) This product is assigned a Regulatory Model Number which stays with the regulatory aspects of the design. The Regulatory Model Number is the main product identifier in the regulatory documentation and test reports, this number should not be confused with the marketing name or the product numbers.
- 2) The product was tested in a typical configuration.
- 3) The internal power adapter A9T80-60009 is for India and China market only.
- 4) WIFI module operates only in 2.4 GHz band within this product.

Singapore
Nov 2015

Hou-Meng Yik, Manager
Product Regulations Manager
HP Singapore Inkjet Printing Solutions

Local contact for regulatory topics only:

EU: HP Deutschland GmbH, HQ-TRE, Schickardstrasse 32, 71034 Boeblingen, Germany
U.S.: HP Inc, 1501 Page Mill Road Palo Alto, CA 94304, U.S.A. 650-857-1501

www.hp.eu/certificates

Regulatory information for wireless products

This section contains the following regulatory information pertaining to wireless products:

- [Exposure to radio frequency radiation](#)
- [Notice to users in Brazil](#)
- [Notice to users in Canada](#)
- [Notice to users in Taiwan](#)
- [Notice to users in Mexico](#)
- [Notice to users in Japan](#)
- [Notice to users in Korea](#)

Exposure to radio frequency radiation

Exposure to radio frequency radiation



Caution The radiated output power of this device is far below the FCC radio frequency exposure limits. Nevertheless, the device shall be used in such a manner that the potential for human contact during normal operation is minimized. This product and any attached external antenna, if supported, shall be placed in such a manner to minimize the potential for human contact during normal operation. In order to avoid the possibility of exceeding the FCC radio frequency exposure limits, human proximity to the antenna shall not be less than 20 cm (8 inches) during normal operation.

Notice to users in Brazil

Aviso aos usuários no Brasil

Este equipamento opera em caráter secundário, isto é, não tem direito à proteção contra interferência prejudicial, mesmo de estações do mesmo tipo, e não pode causar interferência a sistemas operando em caráter primário.

Notice to users in Canada

Notice to users in Canada/Note à l'attention des utilisateurs canadiens

Under Industry Canada regulations, this radio transmitter may only operate using an antenna of a type and maximum (or lesser) gain approved for the transmitter by Industry Canada. To reduce potential radio interference to other users, the antenna type and its gain should be so chosen that the equivalent isotropically radiated power (e.i.r.p.) is not more than that necessary for successful communication.

This device complies with Industry Canada licence-exempt RSS standard(s). Operation is subject to the following two conditions: (1) this device may not cause interference, and (2) this device must accept any interference, including interference that may cause undesired operation of the device.

WARNING! Exposure to Radio Frequency Radiation The radiated output power of this device is below the Industry Canada radio frequency exposure limits. Nevertheless, the device should be used in such a manner that the potential for human contact is minimized during normal operation.

To avoid the possibility of exceeding the Industry Canada radio frequency exposure limits, human proximity to the antennas should not be less than 20 cm (8 inches).

Conformément au Règlement d'Industrie Canada, cet émetteur radioélectrique ne peut fonctionner qu'avec une antenne d'un type et d'un gain maximum (ou moindre) approuvé par Industrie Canada. Afin de réduire le brouillage radioélectrique potentiel pour d'autres utilisateurs, le type d'antenne et son gain doivent être choisis de manière à ce que la puissance isotrope rayonnée équivalente (p.i.r.e.) ne dépasse pas celle nécessaire à une communication réussie.

Cet appareil est conforme aux normes RSS exemptes de licence d'Industrie Canada. Son fonctionnement dépend des deux conditions suivantes : (1) cet appareil ne doit pas provoquer d'interférences nuisibles et (2) doit accepter toutes interférences reçues, y compris des interférences pouvant provoquer un fonctionnement non souhaité de l'appareil.

AVERTISSEMENT relatif à l'exposition aux radiofréquences. La puissance de rayonnement de cet appareil se trouve sous les limites d'exposition de radiofréquences d'Industrie Canada. Néanmoins, cet appareil doit être utilisé de telle sorte qu'il soit mis en contact le moins possible avec le corps humain.

Afin d'éviter le dépassement éventuel des limites d'exposition aux radiofréquences d'Industrie Canada, il est recommandé de maintenir une distance de plus de 20 cm entre les antennes et l'utilisateur.

Notice to users in Taiwan

低功率電波輻射性電機管理辦法

第十二條

經型式認證合格之低功率射頻電機，非經許可，公司、商號或使用者均不得擅自變更頻率、加大功率或變更設計之特性及功能。

第十四條

低功率射頻電機之使用不得影響飛航安全及干擾合法通信；經發現有干擾現象時，應立即停用，並改善至無干擾時方得繼續使用。

前項合法通信，指依電信法規定作業之無線電通信。低功率射頻電機須忍受合法通信或工業、科學及醫藥用電波輻射性電機設備之干擾。

Notice to users in Mexico

Aviso para los usuarios de México

La operación de este equipo está sujeta a las siguientes dos condiciones: (1) es posible que este equipo o dispositivo no cause interferencia perjudicial y (2) este equipo o dispositivo debe aceptar cualquier interferencia, incluyendo la que pueda causar su operación no deseada.

Para saber el modelo de la tarjeta inalámbrica utilizada, revise la etiqueta regulatoria de la impresora.

Notice to users in Japan

この機器は技術基準適合証明又は工事設計認証を受けた無線設備を搭載しています。

Notice to users in Korea

해당 무선설비는 전파혼신 가능성이 있으므로 인명안전과 관련된 서비스는 할 수 없음

Environmental product stewardship program

HP is committed to providing quality products in an environmentally sound manner. Design for recycling has been incorporated into this product. The number of materials has been kept to a minimum while ensuring proper functionality and reliability. Dissimilar materials have been designed to separate easily. Fasteners and other connections are easy to locate, access, and remove using common tools. High priority parts have been designed to access quickly for efficient disassembly and repair. For more information, visit HP's Commitment to the Environment website at:

www.hp.com/hpinfo/globalcitizenship/environment

- [Eco-Tips](#)
- [European Union Commission Regulation 1275/2008](#)
- [Paper](#)
- [Plastics](#)
- [Material safety data sheets](#)
- [Recycling program](#)
- [HP inkjet supplies recycling program](#)
- [Power consumption](#)
- [Disposal of waste equipment by users](#)
- [Chemical substances](#)
- [Restriction of hazardous substance \(Ukraine\)](#)
- [Restriction of hazardous substance \(India\)](#)
- [Restriction on hazardous substances statement \(Turkey\)](#)

- [China SEPA Eco Label User Information](#)
- [China Energy Label for Printer, Fax and Copier](#)
- [Declaration of the Presence Condition of the Restricted Substances Marking \(Taiwan\)](#)
- [The Table of Hazardous Substances/Elements and their Content \(China\)](#)
- [EPEAT](#)
- [Battery disposal in Taiwan](#)
- [California Perchlorate Material Notice](#)
- [EU Battery Directive](#)
- [Battery notice for Brazil](#)

Eco-Tips

HP is committed to helping customers reduce their environmental footprint. Please visit the HP Environmental Programs and Initiatives website for more information on HP's environmental initiatives.

www.hp.com/hpinfo/globalcitizenship/environment/

European Union Commission Regulation 1275/2008

For product power data, including the power consumption of the product in networked standby if all wired network ports are connected and all wireless network ports are activated, please refer to section P14 'Additional Information' of the product IT ECO Declaration at www.hp.com/hpinfo/globalcitizenship/environment/productdata/itecodesktop-pc.html.

Paper

This product is suited for the use of recycled paper according to DIN 19309 and EN 12281:2002.

Plastics

Plastic parts over 25 grams are marked according to international standards that enhance the ability to identify plastics for recycling purposes at the end of product life.

Material safety data sheets

Material safety data sheets (MSDS) can be obtained from the HP website at:

www.hp.com/go/msds

Recycling program

HP offers an increasing number of product return and recycling programs in many countries/regions, and partners with some of the largest electronic recycling centers throughout the world. HP conserves resources by reselling some of its most popular products. For more information regarding recycling of HP products, please visit:

www.hp.com/recycle

HP inkjet supplies recycling program

HP is committed to protecting the environment. The HP Inkjet Supplies Recycling Program is available in many countries/regions, and lets you recycle used print cartridges and ink cartridges free of charge. For more information, go to the following website:

www.hp.com/hpinfo/globalcitizenship/environment/recycle/

Power consumption

HP printing and imaging equipment marked with the ENERGY STAR® logo is certified by the U.S. Environmental Protection Agency. The following mark will appear on ENERGY STAR certified imaging products:



Additional ENERGY STAR certified imaging product model information is listed at: www.hp.com/go/energystar

Disposal of waste equipment by users



This symbol means do not dispose of your product with your other household waste. Instead, you should protect human health and the environment by handing over your waste equipment to a designated collection point for the recycling of waste electrical and electronic equipment. For more information, please contact your household waste disposal service, or go to <http://www.hp.com/recycle>.

Chemical substances

HP is committed to providing our customers with information about the chemical substances in our products as needed to comply with legal requirements such as REACH (*Regulation EC No 1907/2006 of the European Parliament and the Council*). A chemical information report for this product can be found at: www.hp.com/go/reach.

Restriction of hazardous substance (Ukraine)

Технічний регламент щодо обмеження використання небезпечних речовин (Україна)

Обладнання відповідає вимогам Технічного регламенту щодо обмеження використання деяких небезпечних речовин в електричному та електронному обладнанні, затвердженого постановою Кабінету Міністрів України від 3 грудня 2008 № 1057

Restriction of hazardous substance (India)

Restriction of hazardous substances (India)

This product complies with the "India E-waste (Management and Handling) Rule 2011" and prohibits use of lead, mercury, hexavalent chromium, polybrominated biphenyls or polybrominated diphenyl ethers in concentrations exceeding 0.1 weight % and 0.01 weight % for cadmium, except for the exemptions set in Schedule 2 of the Rule.

Restriction on hazardous substances statement (Turkey)

Restriction on Hazardous Substances statement (Turkey)	Türkiye Cumhuriyeti: EEE Yönetmeliğine Uygunur
---	--

China SEPA Eco Label User Information

中国环境标识认证产品用户说明

噪声大于63.0Db(A)的办公设备不宜放置于办公室内，请在独立的隔离区域使用。

如需长时间使用本产品或打印大量文件，请确保在通风良好的房间内使用。

如您需要确认本产品处于零能耗状态，请按下电源关闭按钮，并将插头从电源插座断开。

您可以使用再生纸，以减少资源耗费。

复印机、打印机和传真机能源效率标识 实施规则

依据“复印机、打印机和传真机能源效率标识实施规则”，该打印机具有中国能效标识。标识上显示的能效等级和操作模式值根据“复印机、打印机和传真机能效限定值及能效等级”标准（“GB 21521”）来确定和计算。

1. 能效等级

产品能效等级分为3级，其中1级能效最高。能效限定值根据产品类型和打印速度由标准确定。能效等级则根据基本功耗水平以及网络接口和内存等附加组件和功能的功率因子之和来计算。

2. 能效信息

喷墨打印机

- 操作模式功率

睡眠状态的能耗按照 GB 21521 标准来衡量和计算。该数据以瓦特 (W) 表示。

- 待机功率

待机状态是产品连接到电网电源上功率最低的状态。该状态可以延续无限长时间，且使用者无法改变此状态下产品的功率。对于“成像设备”产品，“待机”状态通常相当于“关闭”状态，但也可能相当于“准备”状态或“睡眠”状态。该数据以瓦特 (W) 表示。

- 睡眠状态预设延迟时间

出厂前由制造商设置的时间决定了该产品在完成主功能后进入低耗模式（例如睡眠、自动关机）的时间。该数据以分钟表示。

- 附加功能功率因子之和

网络接口和内存等附加功能的功率因子之和。该数据以瓦特 (W) 表示。

标识上显示的能耗数据是根据典型配置测量得出的数据，此类配置包含登记备案的打印机依据复印机、打印机和传真机能源效率标识实施规则所选的所有配置。因此，该特定产品型号的实际能耗可能与标识上显示的数据有所不同。

要了解规范的更多详情，请参考最新版的 GB 21521 标准。

Declaration of the Presence Condition of the Restricted Substances Marking (Taiwan)

限用物質含有情況標示聲明書

Declaration of the Presence Condition of the Restricted Substances Marking

單元 Unit	限用物質及其化學符號					
	Restricted substances and its chemical symbols					
	鉛 Lead (Pb)	汞 Mercury (Hg)	鎘 Cadmium (Cd)	六價鉻 Hexavalent chromium (Cr ⁺⁶)	多溴聯苯 Polybrominated biphenyls (PBB)	多溴二苯醚 Polybrominate d diphenyl ethers (PBDE)
外殼和紙匣 (External Casings and Trays)	0	0	0	0	0	0
電線 (Cables)	0	0	0	0	0	0
印刷電路板 (Printed Circuit Boards)	—	0	0	0	0	0
列印引擎(Print Engine)	—	0	0	0	0	0
列印機組件 (Print Assembly)	—	0	0	0	0	0
噴墨印表機墨水匣 (Print Supplies)	0	0	0	0	0	0
列印機配件 (Print Accessory)	—	0	0	0	0	0

備考 1. “超出 0.1 wt %” 及 “超出 0.01 wt %” 係指限用物質之百分比含量超出百分比含量基準值。
 Note 1: “Exceeding 0.1 wt %” and “exceeding 0.01 wt %” indicate that the percentage content of the restricted substance exceeds the reference percentage value of presence condition.

備考 2. “0” 係指該項限用物質之百分比含量未超出百分比含量基準值。
 Note 2: “0” indicates that the percentage content of the restricted substance does not exceed the percentage of reference value of presence.

備考 3. “—” 係指該項限用物質為排除項目。
 Note 3: The “—” indicates that the restricted substance corresponds to the exemption.

若要存取產品的最新使用指南或手冊，請前往 www.support.hp.com。選取搜尋您的產品，然後依照畫面上的指示繼續執行。

To access the latest user guides or manuals for your product, go to www.support.hp.com. Select **Find your product**, and then follow the onscreen instructions.

The Table of Hazardous Substances/Elements and their Content (China)

产品中有害物质或元素的名称及含量
根据中国《电器电子产品有害物质限制使用管理办法》

部件名称	有害物质					
	铅 (Pb)	汞 (Hg)	镉 (Cd)	六价铬 (Cr(VI))	多溴联苯 (PBB)	多溴二苯醚 (PBDE)
外壳和托盘	0	0	0	0	0	0
电线	0	0	0	0	0	0
印刷电路板	X	0	0	0	0	0
打印系统	X	0	0	0	0	0
显示器	X	0	0	0	0	0
喷墨打印机墨盒	0	0	0	0	0	0
驱动光盘	X	0	0	0	0	0
扫描仪	X	0	0	0	0	0
网络配件	X	0	0	0	0	0
电池板	X	0	0	0	0	0
自动双面打印系统	0	0	0	0	0	0
外部电源	X	0	0	0	0	0

本表格依据SJ/T 11364的规定编制。
 0: 表示该有害物质在该部件所有均质材料中的含量均在GB/T 26572 规定的限量要求以下。
 X: 表示该有害物质至少在该部件的某一均质材料中的含量超出GB/T 26572 规定的限量要求。

此表中所有名称中含“X”的部件均符合欧盟 RoHS 立法。

注: 环保使用期限的参考标识取决于产品正常工作的温度和湿度等条件。



EPEAT

EPEAT

Most HP products are designed to meet EPEAT. EPEAT is a comprehensive environmental rating that helps identify greener electronics equipment. For more information on EPEAT go to www.epeat.net. For information on HP's EPEAT registered products go to www.hp.com/hpinfo/globalcitizenship/environment/pdf/epeat_printers.pdf.

Battery disposal in Taiwan



廢電池請回收

California Perchlorate Material Notice

California Perchlorate Material Notice

Perchlorate material - special handling may apply. See:
<http://www.dtsc.ca.gov/hazardouswaste/perchlorate/>

This product's real-time clock battery or coin cell battery may contain perchlorate and may require special handling when recycled or disposed of in California.

EU Battery Directive



English	<p>European Union Battery Directive This product contains a battery that is used to maintain data integrity of real time clock or product settings and is designed to last the life of the product. Any attempt to service or replace this battery should be performed by a qualified service technician.</p>
Français	<p>Directive sur les batteries de l'Union Européenne Ce produit contient une batterie qui permet de maintenir l'intégrité des données pour les paramètres du produit ou l'horloge en temps réel et qui a été conçue pour durer aussi longtemps que le produit. Toute tentative de réparation ou de remplacement de cette batterie doit être effectuée par un technicien qualifié.</p>
Deutsch	<p>Batterie-Richtlinie der Europäischen Union Dieses Produkt enthält eine Batterie, die dazu dient, die Datenintegrität der Echtzeituhr sowie der Produkteinstellungen zu erhalten, und die für die Lebensdauer des Produkts ausreicht. Im Bedarfsfall sollte das Instandhalten bzw. Austauschen der Batterie von einem qualifizierten Servicetechniker durchgeführt werden.</p>
Italiano	<p>Direttiva dell'Unione Europea relativa alla raccolta, al trattamento e allo smaltimento di batterie e accumulatori Questo prodotto contiene una batteria utilizzata per preservare l'integrità dei dati dell'orologio in tempo reale o delle impostazioni del prodotto e la sua durata si intende pari a quella del prodotto. Eventuali interventi di riparazione o sostituzione della batteria devono essere eseguiti da un tecnico dell'assistenza qualificato.</p>
Español	<p>Directiva sobre baterías de la Unión Europea Este producto contiene una batería que se utiliza para conservar la integridad de los datos del reloj de tiempo real o la configuración del producto y está diseñada para durar toda la vida útil del producto. El mantenimiento o la sustitución de dicha batería deberá realizarla un técnico de mantenimiento cualificado.</p>
Čeština	<p>Směrnice Evropské unie pro nakládání s bateriemi Tento výrobek obsahuje baterii, která slouží k uchování správných dat hodin reálného času nebo nastavení výrobku. Baterie je navržena tak, aby vydržela celou životnost výrobku. Jakýkoliv pokus o opravu nebo výměnu baterie by měl provést kvalifikovaný servisní technik.</p>
Dansk	<p>EU's batteridirektiv Produktet indeholder et batteri, som bruges til at vedligeholde dataintegriteten for realtidsur- eller produktindstillinger og er beregnet til at holde i hele produktets levetid. Service på batteriet eller udskiftning bør foretages af en uddannet servicetekniker.</p>
Nederlands	<p>Richtlijn batterijen voor de Europese Unie Dit product bevat een batterij die wordt gebruikt voor een juiste tijdsaanduiding van de klok en het behoud van de productinstellingen. Bovendien is deze ontworpen om gedurende de levensduur van het product mee te gaan. Het onderhoud of de vervanging van deze batterij moet door een gekwalificeerde onderhoudstechnicus worden uitgevoerd.</p>
Eesti	<p>Euroopa Liidu akude direktiiv Toode sisaldab akut, mida kasutatakse reaalaja kella andmeühitsuse või toote säätete säilitamiseks. Aku on valmistatud kestma terve toote kasutusaja. Akut tohib koolitada või vahetada ainult kvalifitseeritud hooldustehnik.</p>
Svenska	<p>Euroopan unionin paristodirektiivi Tämä laite sisältää pariston, jota käytetään reaaliaikaisen kellon tietojen ja laitteen asetusten säilyttämiseen. Pariston on suunniteltu kestäväen laitteen koko käyttöajan ajan. Pariston mahdollinen korjaus tai vaihto on jätettävä päteväin huoltohenkilön tehtäväksi.</p>
Ελληνικά	<p>Οδηγία της Ευρωπαϊκής Ένωσης για τις ηλεκτρικές σήλας Αυτό το προϊόν περιλαμβάνει μια μπαταρία, η οποία χρησιμοποιείται για τη διατήρηση της ακεραιότητας των δεδομένων ρολογιού πραγματικού χρόνου ή των ρυθμίσεων προϊόντος και έχει σχεδιαστεί έτσι ώστε να διαρκέσει όσο και το προϊόν. Τυχόν απόπειρες επιδιόρθωσης ή αντικατάστασης αυτής της μπαταρίας θα πρέπει να πραγματοποιούνται από κατάλληλα εκπαιδευμένο τεχνικό.</p>
Magyar	<p>Az Európai unió telepek és akkumulátorok direktívája A termék tartalmaz egy elemet, melynek feladata az, hogy biztosítsa a valós idejű óra vagy a termék beállításainak adatintegritását. Az elem úgy van tervezve, hogy végig kitartsa a termék használatá során. Az elem bármilyen javítását vagy cseréjét csak képzett szakember végezheti el.</p>
Latviešu	<p>Eiropas Savienības Bateriju direktīva Produktam ir baterija, ko izmanto reāli laika pulksteņa vai produkta iestatījumu datu integritātes saglabāšanai, un tā ir paredzēta visam produkta dzīvības ciklam. Jebkura apkošana vai baterijas nomaiņa ir jāveic atbilstoši kvalificētam darbiniekam.</p>
Lietuviškai	<p>Europos Sąjungaos baterijų ir akumuliatorių direktiva Šiame gaminyje yra baterija, kuri naudojama, kad būtų galima prižiūrėti realaus laiko laikrodžio veikimą arba gaminio nuostatas; ji skirta veikti visą gaminio eksploatavimo laiką. Bet kokias šios baterijos aptarnavimo arba keitimo darbus turi atlikti kvalifikuotas aptarnavimo technikas.</p>
Polski	<p>Dyrektywa Unii Europejskiej w sprawie baterii i akumulatorów Produkt zawiera baterię wykorzystywaną do zachowania integralności danych zegara czasu rzeczywistego lub ustawień produktu, która podtrzymuje działanie produktu. Przegląd lub wymiana baterii powinny być wykonywane wyłącznie przez uprawnionego technika serwisu.</p>
Português	<p>Directiva sobre baterías da União Européia Este produto contém uma bateria que é usada para manter a integridade dos dados do relógio em tempo real ou das configurações do produto e é projetada para ter a mesma duração que este. Qualquer tentativa de consertar ou substituir essa bateria deve ser realizada por um técnico qualificado.</p>
Slovenčina	<p>Smernica Európskej únie pre zaobchádzanie s batériami Tento výrobok obsahuje batériu, ktorá slúži na uchovanie správnych údajov hodín reálneho času alebo nastavení výrobku. Batéria je skonštruovaná tak, aby vydržala celú životnosť výrobku. Akýkoľvek pokus o opravu alebo výmenu batérie by mal vykonať kvalifikovaný servisný technik.</p>
Slovensky	<p>Direktiva Evropske unije o baterijah in akumulatorjih V tem izdelku je baterija, ki zagotavlja natančnost podatkov ure v realnem času ali nastavitev izdelka v celotni življenjski dobi izdelka. Kakršno koli popravilo ali zamenjava te baterije lahko izvede le pooblaščen tehnik.</p>
Српски	<p>EU-ja batteridirektiv Produkten innehåller ett batteri som används för att upprätthålla data i realtidsklockan och produktinställningarna. Batteriet ska räcka produktens hela livslängd. Endast kvalificerade servicetekniker får utföra service på batteriet och byta ut det.</p>
Български	<p>Директива за батерии на Европейския съюз Този продукт съдържа батерия, която се използва за поддържане на целостта на данните на часовника в реално време или настройките за продукта, създадена на издръжливост през целия живот на продукта. Сервизът или замяната на батерията трябва да се извършва от квалифициран техник.</p>
Română	<p>Directiva Uniunii Europene referitoare la baterii Acest produs conține o baterie care este utilizată pentru a menține integritatea datelor ceasului de timp real sau setările produsului și care este proiectată să funcționeze pe întreaga durată de viață a produsului. Orice lucrare de service sau de înlocuire a acestei baterii trebuie efectuată de un tehnician de service calificat.</p>

Battery notice for Brazil

A bateria deste equipamento não foi projetada para ser removida pelo cliente.

B Errors (Windows)

- [Low on ink](#)
- [Very low on ink](#)
- [Cartridge problem](#)
- [Paper size mismatch](#)
- [Ink cartridge carriage stalled](#)
- [Paper jam or tray problem](#)
- [Out of paper](#)
- [Printer failure](#)
- [Door open](#)
- [Ink cartridge failure](#)
- [Printer supply upgrade problem](#)
- [Counterfeit Cartridge Advisory](#)
- [Incompatible cartridges](#)
- [Use SETUP cartridges](#)
- [Do not use SETUP cartridges](#)
- [Problem with SETUP cartridges](#)
- [Problem with Printer Preparation](#)
- [Paper too short](#)
- [Ink cartridge incorrectly installed](#)
- [Problem with printhead](#)
- [Please Connect to HP Instant Ink](#)
- [Paper Jam in Automatic Document Feeder](#)
- [HP Protected Cartridge Installed](#)
- [Used HP Instant Ink Cartridge](#)
- [Older generation cartridge installed](#)
- [Paper too long to auto-duplex](#)

Low on ink

The cartridge identified in the message is low on ink.

Ink level warnings and indicators provide estimates for planning purposes only. When you receive a low ink warning message, consider having a replacement cartridge available to avoid possible printing delays. You do not have to replace the cartridges until prompted to do so.

For information about replacing cartridges, see [Replace the cartridges](#). For information about ordering cartridges, see [Order cartridges](#). For information about recycling used ink supplies, see [HP inkjet supplies recycling program](#).



NOTE: Ink from the cartridges is used in the printing process in a number of different ways, including in the initialization process, which prepares the printer and cartridges for printing. In addition, some residual ink is left in the cartridge after it is used. For more information see www.hp.com/go/inkusage.

Very low on ink

The cartridge identified in the message is very low on ink.

Ink level warnings and indicators provide estimates for planning purposes only. When you receive a very low ink warning message, HP recommends having a replacement cartridge available to avoid possible printing delays. You do not need to replace cartridges until the print quality is unacceptable.

For information about replacing cartridges, see [Replace the cartridges](#). For information about ordering cartridges, see [Order cartridges](#). For information about recycling used ink supplies, see [HP inkjet supplies recycling program](#).



NOTE: Ink from the cartridges is used in the printing process in a number of different ways, including in the initialization process, which prepares the printer and cartridges for printing. In addition, some residual ink is left in the cartridge after it is used. For more information see www.hp.com/go/inkusage.

Cartridge problem

The cartridge identified in the message is missing, damaged, incompatible, or inserted into the wrong slot in the printer.



NOTE: If the cartridge is identified in the message as incompatible, see [Order cartridges](#) for information about obtaining cartridges for the printer.

To solve this problem, try the following solutions. Solutions are listed in order, with the most likely solution first. If the first solution does not solve the problem, continue trying the remaining solutions until the issue is resolved.

Solution 1: Turn the printer off and on

Turn off the printer, and then turn it on again.

If the problem persists, try the next solution.

Solution 2: Install the cartridges correctly

Make sure all of the cartridges are properly installed.

For information about replacing cartridges, see [Replace the cartridges](#).

Paper size mismatch

The paper size or type selected in the printer driver does not match the paper loaded in the printer. Make sure that the correct paper is loaded in the printer, and then print the document again. For more information, see [Load paper](#).



NOTE: If the paper loaded in the printer is the correct size, change the selected paper size in the printer driver, and then print the document again.

Ink cartridge carriage stalled

Something is blocking the cartridge carriage (the part of the printer that holds the cartridges).

To clear the obstruction check the printer for jams.

For more information, see [Jams and paper-feed issues](#).

Paper jam or tray problem

Paper has become jammed in the printer.

Before you try to clear the jam, check the following:

- Make sure that you have loaded paper that meets specifications and is not wrinkled, folded, or damaged. For more information, see [Recommended papers for printing](#).
- Make sure that the printer is clean. For more information, see [Maintain the printer](#).
- Make sure that the trays are loaded correctly and are not too full. For more information, see [Load paper](#).

For instructions on clearing jams, as well as more information about how to avoid jams, see [Jams and paper-feed issues](#).

Out of paper



The default tray is empty.

Load more paper, and then touch **OK**.

For more information, see [Load paper](#).

Printer failure

There was a problem with the printer or ink system. Usually, you can resolve such problems by completing the following steps:

1. Press  (the Power button) to turn off the printer.
2. Unplug the power cord, and then plug in the power cord again.
3. Press  (the Power button) to turn on the printer.

If this problem persists, write down the error code provided in the message, and then contact HP support. For more information about contacting HP support, see [HP support](#).

Door open

Before the printer can print documents, all doors and covers must be closed.

 **TIP:** When completely closed, most doors and covers snap into place.

If the problem persists after you've securely closed all doors and covers, contact HP support. For more information, see [HP support](#).

Ink cartridge failure

The cartridges listed in the message are damaged or have failed.

See [Replace the cartridges](#).

Printer supply upgrade problem

The supply upgrade was not successful. The cartridges listed in the message can still be used in this printer. Replace the Supply Upgrade cartridge. For more information, see [Replace the cartridges](#).

Counterfeit Cartridge Advisory

The installed cartridge is not a new, genuine HP cartridge. Contact the store where this cartridge was purchased. To report suspected fraud, visit HP at www.hp.com/go/anticounterfeit. To continue using the cartridge, click **Continue**.

Incompatible cartridges

The cartridge is not compatible with your printer.

Solution: Remove this cartridge immediately and replace with a compatible cartridge. For information about how to install new cartridges, see [Replace the cartridges](#).

Use SETUP cartridges

When you first setup the printer, you must install the cartridges that shipped in the box with the printer. These cartridges are labeled SETUP, and they calibrate your printer before the first print job. Failure to install the SETUP cartridges during the initial product setup causes an error. If you installed a set of regular cartridges, remove them and install the SETUP cartridges to complete printer setup. After printer setup is complete, the printer can use regular cartridges.

if you still receive error messages and the printer cannot complete ink system initialization, contact HP support. For more information, see [HP support](#).

[Click here to go online for more information](#). At this time, this website might not be available in all languages.

Do not use SETUP cartridges

SETUP cartridges cannot be used after the printer has been initialized. Remove and install non-SETUP cartridges. For more information, see [Replace the cartridges](#).

Problem with SETUP cartridges

There is a problem with the SETUP cartridges and the printer cannot complete ink system initialization. Please contact [HP support](#).

Problem with Printer Preparation

The printer clock has failed and ink preparation may not be complete. The estimated Ink Level gauge might be inaccurate.

Solution: Check the print quality of your print job. If it is not satisfactory, running the printhead cleaning procedure from the toolbox might improve it.

Paper too short

The paper loaded is shorter than the minimum requirement. Paper that meets the printer requirements must be loaded. For more information, see [Recommended papers for printing](#) and [Load paper](#).

Ink cartridge incorrectly installed

The cartridge indicated in the message is not installed correctly.

Make sure all of the cartridges are properly installed:

1. Make sure the printer is turned on and the scanner lid is closed.
2. Open the cartridge access door.

 **NOTE:** Wait until the print carriage stops moving before proceeding.

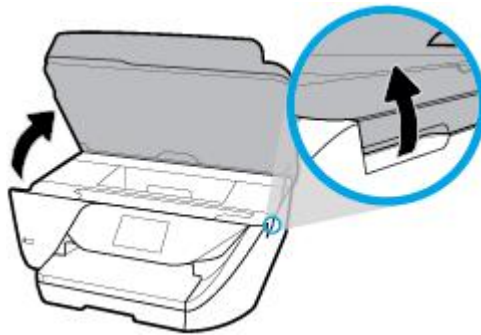

3. Press the front of the cartridge to release it, and then remove it from the slot.

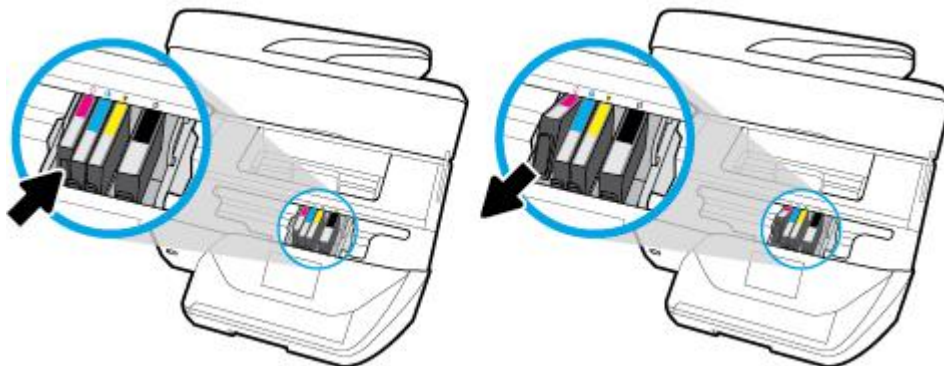

4. Make sure that the color-coded letter on the cartridge matches that on the slot.
5. Insert the cartridge into the slot. Press firmly on the cartridge to ensure proper contact.
6. Close the cartridge access door.

For information about replacing cartridges, see [Replace the cartridges](#). For information about ordering cartridges, see [Order cartridges](#). For information about recycling used ink supplies, see [HP inkjet supplies recycling program](#).

Problem with printhead

There is a problem with the printhead.

Turn off the printer, and then turn it on again.

If the problem persists, contact HP support for service. For more information, see [HP support](#).

Please Connect to HP Instant Ink

The printer must be connected to HP Instant Ink, otherwise you will be unable to print soon without further warning. See the printer control panel for instructions on connecting, or visit the [HP Instant Ink program](#) website for more information.

Paper Jam in Automatic Document Feeder

Clear a paper jam in the document feeder. For more information, see [Jams and paper-feed issues](#).

HP Protected Cartridge Installed

The ink cartridge listed on the printer control panel can only be used in the printer that initially protected the cartridge using the HP Cartridge Protection feature. The ink cartridge must be replaced in this printer.

For information about how to install a new ink cartridge, see [Replace the cartridges](#).

Used HP Instant Ink Cartridge

The cartridge is not compatible with your printer.

This error can occur if you install an HP Instant Ink cartridge into a printer that has not been enrolled in the HP Instant Ink program. It can also occur if the HP Instant Ink cartridge was previously used in a different printer enrolled in the HP Instant Ink program.

Visit the [HP Instant Ink program](#) website for more information.

Older generation cartridge installed

The older generation cartridge does not work in your printer. It can still be used with some older printer models. If you do not own an older printer model and your cartridge is a genuine HP cartridge, contact HP Support. For more information about contacting HP support, see [HP support](#). To order a genuine HP replacement cartridge online, see [Order cartridges](#). For problems with cartridges obtained from HP Instant Ink, please visit the [HP Instant Ink program](#) website for more information.

Paper too long to auto-duplex

The paper loaded is longer than supported by the printer automatic duplexing. You can manually duplex it by selecting "manual duplex" or "print odd pages" and "print even pages" in your printer software (if supported). For more information, see [Recommended papers for printing](#) and [Load paper](#).

Index

A

- accessibility 2
- ADSL, fax setup with
 - parallel phone systems 60
- align printhead 126
- answer ring pattern
 - change 50
 - parallel phone systems 61
- answering machine
 - fax tones recorded 119
 - set up with fax (parallel phone systems) 69
 - set up with fax and modem 70
- automatic fax reduction 44

B

- backup fax 42
- baud rate 51
- black and white pages
 - fax 37
- blocked fax numbers
 - set up 44
- both sides, print on 25
- broadcast faxing
 - send 40
- buttons, control panel 8

C

- carriage
 - clear carriage jams 101
- cartridge access door, locating 7
- Cartridges 7
- cartridges 83
 - check ink levels 81
 - locating 7
 - replace 81
 - tips 80
- clean
 - document feeder 125
 - exterior 125
 - printhead 126, 127
 - scanner glass 124
- clear
 - fax logs 55
- colored text, and OCR 32

- computer modem
 - shared with fax (parallel phone systems) 64
 - shared with fax and answering machine (parallel phone systems) 70
 - shared with fax and voice line (parallel phone systems) 66
 - shared with fax and voice mail (parallel phone systems) 74
- confirmation reports, fax 53
- connectors, locating 7
- control panel
 - buttons 8
 - lights 8
 - status icons 8
- copy
 - specifications 130
- correct port test, fax 113
- customer support
 - warranty 128

D

- diagnostic page 123
- dial tone test, failure 115
- dial type, setting 50
- dial-up modem
 - shared with fax (parallel phone systems) 64
 - shared with fax and answering machine (parallel phone systems) 70
 - shared with fax and voice line (parallel phone systems) 66
 - shared with fax and voice mail (parallel phone systems) 74
- distinctive ringing
 - change 50
 - parallel phone systems 61
- document feeder
 - clean 125
 - feeding problems, troubleshoot 125
 - load originals 17
- double-sided printing 25

- DSL, fax setup with
 - parallel phone systems 60

E

- ECM. *See* error correction mode
- edit
 - text in OCR program 32
- embedded web server
 - about 93
 - opening 94
 - troubleshoot, cannot be opened 95
 - Webscan 34
- environmental specifications 129
- environmental sustainability
 - program 141
- error correction mode 41
- error reports, fax 54
- EWS. *See* embedded web server

F

- fax
 - answer mode 49
 - answering machine and modem, shared with (parallel phone systems) 70
 - answering machine
 - troubleshoot 119
 - answering machine, set up (parallel phone systems) 69
 - auto answer 49
 - backup fax 42
 - blocking numbers 44
 - confirmation reports 53
 - dial tone test, failed 115
 - dial type, setting 50
 - distinctive ringing setup (parallel phone systems) 61
 - distinctive ringing, change pattern 50
 - DSL, set up (parallel phone systems) 60
 - error correction mode 41
 - error reports 54
 - forwarding 43

- header 49
- Internet Protocol, over 52
- ISDN line, set up (parallel phone systems) 60
- line condition test, failed 115
- log, clear 55
- log, print 54
- manual receive 42
- modem and answering machine, shared with (parallel phone systems) 70
- modem and voice line, shared with (parallel phone systems) 66
- modem and voice mail, shared with (parallel phone systems) 74
- modem, shared with (parallel phone systems) 64
- monitor dialing 39, 40
- parallel phone systems 56
- PBX system, set up (parallel phone systems) 60
- phone cord connection test, failed 113
- phone cord type test, failed 114
- print last transaction details 55
- receive 41
- receive, troubleshoot 116, 118
- redial options 51
- reduction 44
- reports 53
- reprint 43
- rings to answer 49
- send 37
- send, troubleshoot 116, 119
- separate line setup (parallel phone systems) 59
- settings, change 48
- setup types 57
- shared phone line setup (parallel phone systems) 62
- sound volume 52
- specifications 130
- speed 51
- test failed 112
- test setup 75
- troubleshoot 111

- voice mail, set up (parallel phone systems) 63
- wall jack test, failed 113
- FoIP 52
- forwarding faxes 43

G

- glass, scanner
 - clean 124
 - load originals 17
 - locating 6

H

- hardware, fax setup test 112
- header, fax 49
- Help button 9
- HP Utility (OS X)
 - opening 93
- humidity specifications 129

I

- ink cartridges
 - part numbers 83
- ink level icons 9
- ink levels, check 81
- Internet Protocol
 - fax, using 52
- IP address
 - checking for printer 95
- IP settings 89
- ISDN line, set up with fax
 - parallel phone systems 60

J

- jams
 - clear 96
 - paper to avoid 12
- junk fax mode 44

L

- lights, control panel 8
- line condition test, fax 115
- log, fax
 - print 54

M

- Mac OS 21
- maintain
 - page smear 126
 - printhead 126

- maintenance
 - align printhead 126
 - check ink levels 81
 - clean 125
 - clean printhead 127
 - diagnostic page 123
 - printhead 126
 - replace cartridges 81

manual faxing

- receive 42
- send 39

media

- duplexing 25

memory

- reprint faxes 43
- save faxes 42

modem

- shared with fax (parallel phone systems) 64
- shared with fax and answering machine (parallel phone systems) 70
- shared with fax and voice line (parallel phone systems) 66
- shared with fax and voice mail (parallel phone systems) 74
- monitor dialing 39, 40
- multi-feeds, troubleshoot 102

N

networks

- connector illustration 7
- IP settings 89
- settings, change 88
- view and print settings 89
- wireless communication setup 86
- wireless settings 123

O

OCR

- edit scanned documents 32
- operating systems supported 129
- OS X

- HP Utility 93

output tray

- locating 6

P

paper

- clear jams 96

- HP, order 12
- load tray 13
- selecting 12
- skewed pages 102
- specifications 129
- troubleshoot feeding 102
- paper-feed problems, troubleshoot 102
- parallel phone systems
 - answering machine setup 69
 - countries/regions with 56
 - distinctive ringing setup 61
 - DSL setup 60
 - ISDN setup 60
 - modem and answering machine setup 70
 - modem and voice mail setup 74
 - modem setup 64
 - modem shared with voice line setup 66
 - PBX setup 60
 - separate line setup 59
 - setup types 57
 - shared line setup 62
- PBX system, set up with fax
 - parallel phone systems 60
- phone book
 - change contact 46
 - change group contacts 47
 - delete contacts 48
 - print list 48
 - send fax 37
 - set up 46
 - set up group contacts 47
- phone cord
 - connected to correct port test failed 113
 - correct type test failed 114
- phone line, answer ring pattern 50
- phone, fax from
 - receive 42
 - send, 39
- power
 - troubleshoot 121
- power input, locating 7
- print
 - diagnostic page 123
 - double-sided 25
 - fax logs 54
 - fax reports 53
 - faxes 43
 - last fax details 55
 - troubleshoot 121
 - Print brochures
 - print 21
 - print quality
 - clean page smear 126
 - print quality report 123
 - printer control panel
 - locating 6
 - network settings 88
 - send faxes 38
 - printer software (Windows)
 - about 93
 - opening 19, 93
 - printer status report
 - information on 122
 - printhead 126
 - clean 127
 - printhead, align 126
 - pulse dialing 50
- R**
 - radio interference
 - regulatory information 139
 - rear access panel
 - illustration 7
 - receive faxes
 - auto answer mode 49
 - automatically 41
 - blocking numbers 44
 - forwarding 43
 - manually 42
 - rings to answer 49
 - troubleshoot 116, 118
 - recycle
 - ink cartridges 143
 - redial options, setting 51
 - reduce fax 44
 - regulatory information 131, 139
 - regulatory notices
 - regulatory model identification number 132
 - replace cartridges 81
 - reports
 - confirmation, fax 53
 - diagnostic 123
 - error, fax 54
 - fax test failed 112
 - web access 123
 - wireless test 123
- reprint
 - faxes from memory 43
 - rings to answer 49
- S**
 - save
 - faxes in memory 42
 - scan
 - from Webscan 34
 - OCR 32
 - scan specifications 130
 - scanner glass
 - clean 124
 - load originals 17
 - locating 6
 - send faxes
 - basic fax 37
 - from a phone 39
 - memory, from 40
 - monitor dialing 39, 40
 - troubleshoot 116, 119
 - send scans
 - for OCR 32
 - serial phone systems
 - countries/regions with 56
 - setup types 57
 - settings
 - network 88
 - speed, fax 51
 - volume, fax 52
 - setup
 - answering machine (parallel phone systems) 69
 - answering machine and modem (parallel phone systems) 70
 - computer modem (parallel phone systems) 64
 - computer modem and answering machine (parallel phone systems) 70
 - computer modem and voice line (parallel phone systems) 66
 - computer modem and voice mail (parallel phone systems) 74
 - distinctive ringing 50
 - distinctive ringing (parallel phone systems) 61
 - DSL (parallel phone systems) 60

- fax scenarios 57
- fax, with parallel phone systems 56
- ISDN line (parallel phone systems) 60
- PBX system (parallel phone systems) 60
- separate fax line (parallel phone systems) 59
- shared phone line (parallel phone systems) 62
- test fax 75
- voice mail (parallel phone systems) 63
- voice mail and computer modem (parallel phone systems) 74
- skew, troubleshoot
 - print 102
- software
 - OCR 32
 - Webscan 34
- specifications
 - paper 129
 - physical 129
 - system requirements 129
- status
 - network configuration page 123
- status icons 8
- subscriber identification code 49
- system requirements 129

T

- technical information
 - copy specifications 130
 - fax specifications 130
 - scan specifications 130
- telephone line, answer ring pattern 50
- telephone wall jack, fax 113
- telephone, fax from
 - receive 42
 - send 39
- temperature specifications 129
- tests, fax
 - dial tone, failed 115
 - failed 112
 - fax line condition 115
 - fax phone cord type test failed 114
 - hardware, failed 112

- port connection, failed 113
- setup 75
- telephone wall jack 113
- tone dialing 50
- trays
 - clear paper jams 96
 - load paper 13
 - locating 6
 - paper-width guides illustration 6
 - troubleshoot feeding 102
- troubleshoot
 - answering machines 119
 - control panel help system 122
 - embedded web server 95
 - fax 111
 - fax dial tone test failed 115
 - fax hardware test failed 112
 - fax line test failed 115
 - fax phone cord connection test failed 113
 - fax phone cord type test failed 114
 - fax tests 112
 - fax wall jack test, failed 113
 - multiple pages are picked 102
 - network configuration page 123
 - paper not picked up from tray 102
 - paper-feed problems 102
 - power 121
 - print 121
 - printer status report 122
 - receive faxes 116, 118
 - send faxes 116, 119
 - skewed pages 102
- two-sided printing 25

U

- USB connection
 - port, locating 6, 7

V

- view
 - network settings 89

- voice mail
 - set up with fax (parallel phone systems) 63
 - set up with fax and computer modem (parallel phone systems) 74
- volume
 - fax sounds 52

W

- wall jack test, fax 113
- warranty 128
- web access test report 123
- Webscan 34
- websites
 - accessibility information 2
 - environmental programs 141
- Windows
 - print brochures 21
 - system requirements 129
- wireless communication
 - regulatory information 139
 - set up 86
- wireless connection icons 9
- wireless test report 123

