



OFFICEJET PRO X476 AND X576 MFP SERIES

User Guide





HP Officejet Pro X476 and X576 MFP Series

User Guide

Copyright and License

© 2012 Copyright Hewlett-Packard Development Company, L.P.

Reproduction, adaptation, or translation without prior written permission is prohibited, except as allowed under the copyright laws.

The information contained herein is subject to change without notice.

The only warranties for HP products and services are set forth in the express warranty statements accompanying such products and services. Nothing herein should be construed as constituting an additional warranty. HP shall not be liable for technical or editorial errors or omissions contained herein.

Edition 3, 4/2014

Trademark Credits

Adobe®, Acrobat®, and PostScript® are trademarks of Adobe Systems Incorporated.

Intel® Core™ is a trademark of Intel Corporation in the U.S. and other countries.

Java™ is a US trademark of Sun Microsystems, Inc.

Microsoft®, Windows®, Windows® XP, and Windows Vista® are U.S. registered trademarks of Microsoft Corporation.

UNIX® is a registered trademark of The Open Group.

ENERGY STAR and the ENERGY STAR mark are registered U.S. marks.

Conventions used in this guide

 **TIP:** Tips provide helpful hints or shortcuts.

 **NOTE:** Notes provide important information to explain a concept or to complete a task.

 **CAUTION:** Cautions indicate procedures that you should follow to avoid losing data or damaging the product.

 **WARNING!** Warnings alert you to specific procedures that you should follow to avoid personal injury, catastrophic loss of data, or extensive damage to the product.

Table of contents

1 Product basics	1
Product overview	2
HP Officejet Pro X476 MFP Series models	2
HP Officejet Pro X576 MFP Series models	3
Environmental features	4
Accessibility features	4
Product views	5
Front view	5
Back view	6
Interface ports	7
Serial number and model number location	8
Control panel layout	9
2 Control panel menus	13
Copy menu	14
Fax menus	16
Scan menus	17
Apps	18
Plug and Print	18
Setup Menu	18
Fax Setup menu	19
Network Setup menu	22
HP Digital Solutions Setup menu	24
Device Setup menu	24
Tools menu	29
Print Reports menu	30
3 Connect the product	31
Connect the product using a USB cable	32
CD installation	32
Connect the product to a network	33

Supported network protocols	33
Install the product on a wired network	33
Configure IP network settings	34
HP ePrint	36
Install the product on a wireless network (wireless models only)	37
Connect the product to a wireless network using the Wireless Setup Wizard	37
Connect the product to a wireless network using WPS	38
Install the software for a wireless product currently on the network	38
Manually connect the product to a wireless network	38

4 Use the product with Windows 41

Supported operating systems and printer drivers for Windows	42
Select the correct printer driver for Windows	42
HP Universal Print Driver (UPD)	44
Change print job settings for Windows	45
Priority for print settings	45
Change the settings for all print jobs until the software program is closed	45
Change the default settings for all print jobs	45
Change the product configuration settings	46
Remove the printer driver from Windows	47
Supported utilities for Windows	48
Other Windows components and utilities	48

5 Use the product with Mac 49

Supported operating systems and printer drivers for Mac	50
Software for Mac computers	51
HP Utility for Mac	51
Priority for print settings for Mac	52
Change printer-driver settings for Mac	53
Change the settings for all print jobs until the software program is closed	53
Change the default settings for all print jobs	53
Change the product configuration settings	53
Remove the printer driver from Mac operating systems	54
Supported utilities for Mac	55
HP Embedded Web Server	55
Fax with Mac	56
Scan with Mac	57
Use the HP Scan software to scan images to a Mac computer.	57
Scan using Apple Preview and Image Capture applications (Mac OS X v10.6 and later)	57
Solve problems with Mac	59

6 Paper and print media	61
Understand paper use	62
Change the printer driver to match the paper type and size in Windows	64
Supported paper sizes	65
Supported paper types and tray capacity	68
Load paper trays	70
Load Tray 1 (multi-purpose tray on left side of the product)	70
Load Tray 2 or optional Tray 3	71
Load the document feeder	72
Configure trays	74
7 Ink cartridges	75
Ink cartridge information	75
Supplies views	77
Ink cartridge view	77
Manage ink cartridges	78
Change settings for ink cartridges	78
Store and recycle supplies	79
HP anticounterfeit website	79
Replacement instructions	80
Replace the ink cartridges	80
Solve issues with supplies	83
Check the ink cartridges	83
Interpret control panel messages for supplies	85
8 Print	89
Print tasks (Windows)	90
Open the printer driver with Windows	90
Get help for any printing option with Windows	90
Change the number of print copies with Windows	91
Save custom print settings for reuse with Windows	91
Improve print quality with Windows	94
Print on both sides (duplex) with Windows	96
Print multiple pages per sheet with Windows	97
Select page orientation with Windows	99
Set Advanced color options with Windows	100
Print tasks (Mac)	101
Create and use printing presets with Mac	101
Print a cover page with Mac	101
Print multiple pages on one sheet of paper with Mac	102

Print on both sides of the page (duplex printing) with Mac	102
Set the color options with Mac	102
Additional print tasks (Windows)	104
Cancel a print job with Windows	104
Print colored text as black (grayscale) with Windows	104
Print on special paper or labels with Windows	104
Print the first or last page on different paper with Windows	106
Scale a document to fit page size with Windows	109
Add a watermark to a document with Windows	110
Create a booklet with Windows	111
Additional print tasks (Mac OS X)	113
Cancel a print job with Mac	113
Change the paper size and type with Mac	113
Resize documents or print on a custom paper size with Mac	113
Use watermarks with Mac	113
Use HP ePrint	115
Use the HP ePrint Mobile Driver	116
AirPrint	117
Connect the printer with HP Wireless Direct	118
Connect and print from a WiFi capable mobile device	118
Connect and print from a WiFi capable computer over a wireless router and Wireless Direct	119
Connect and print from a WiFi capable computer over Wireless Direct only	119
Change from printing over USB to a Wireless Direct connection	120
Plug and Print USB Drive printing	121
9 Color	123
Adjust color	124
Change the color theme for a print job	124
Change the color options	125
Use the HP EasyColor option	127
Match colors to your computer screen	128
Print fade- and water-resistant prints	129
10 Copy	131
Use copy functions	132
Copy	132
Multiple copies	132
Copy a multiple-page original	133
Copy identification cards	134
Cancel a copy job	135

Reduce or enlarge a copy	135
Collate a copy job	136
Copy settings	137
Check the scanner glass for dirt and smudges	137
Adjust the lightness or darkness for copies	138
Define custom copy settings	138
Set the paper size and type for copying on special paper	139
Copy photos	140
Copy mixed size originals	141
Copy on both sides	142
Copy on both sides automatically	142
11 Scan	143
Use scan functions	144
Scan methods	144
Cancel a scan	146
Scan settings	147
Scanner resolution and color	147
Scan quality	149
Scan a photo to USB	150
12 Fax	151
Set up fax	152
Install and connect the hardware	152
Configure fax settings	152
Use the HP Fax Setup Wizard (Windows)	153
Use the phone book	154
Use speed dials	154
Manage group-dial entries	155
Set fax settings	156
Send-fax settings	156
Receive-fax settings	159
Set fax polling	162
Use fax	163
Fax software	163
Cancel a fax	163
Use fax on a DSL, PBX, or ISDN system	163
Use fax on a VoIP service	164
Fax memory	165
Delete faxes from memory	165
Send a fax	165

Receive a fax	173
Solve fax problems	174
Fax troubleshooting checklist	174
Fax error messages	176
Fax logs and reports	181
Change error correction and fax speed	182
Solve problems sending faxes	182
Solve problems receiving faxes	189
Solve general fax problems	193
Regulatory information and warranties	195

13 Manage and maintain 197

Print information pages	198
Use the HP Embedded Web Server	200
About cookies	200
Open the HP Embedded Web Server	201
Features	201
Use HP Web Jetadmin software	204
Product security features	204
Security statements	204
Assign an administrator password in the HP Embedded Web Server	204
Control Panel Lock	205
Disable unused protocols and services	205
Administrator Settings	206
Color Access Control	206
Protected Protocols – HTTPS	206
Firewall	206
Scan-to and Fax-to Folder Authentication	206
Syslog	207
Certificates	207
Signed Firmware	207
Wireless Authentication	207
Economy settings	208
Print with General Office mode	208
Power handling	208
Clean the product	210
Clean the printhead	210
Clean the scanner glass strip and platen	210
Clean the document feeder pickup rollers and separation pad	211
Clean the touch screen	212
Product updates	213

14 Solve problems	215
Customer support	216
Problem-solving checklist	217
Step 1: Check that the product power is on	217
Step 2: Check the control panel for error messages	217
Step 3: Test print functionality	217
Step 4: Test copy functionality	218
Step 5: Test the fax sending functionality	218
Step 6: Test the fax receiving functionality	218
Step 7: Try sending a print job from a computer	218
Step 8: Test the Plug and Print USB Drive printing functionality	218
Factors that affect product performance	219
Restore the factory-set defaults	219
Paper feeds incorrectly or becomes jammed	220
The product does not pick up paper	220
The product picks up multiple sheets of paper	220
Prevent paper jams	220
Clear jams	222
Jam locations	222
Clear jams from the document feeder	223
Clear jams in Tray 1 (Multi-purpose tray)	224
Clear jams in Tray 2	228
Clear jams in optional Tray 3	229
Clear jams in the left door	230
Clear jams in the output bin	232
Clear jams in the duplexer	233
Improve print quality	236
Use the correct paper type setting in the printer driver	236
Adjust color	237
Use paper that meets HP specifications	240
Check the ink cartridges	240
Clean ink smears	242
Clean the printhead	243
Use the printer driver that best meets your printing needs	243
Improve print quality for copies	244
The product does not print or it prints slowly	245
The product does not print	245
The product prints slowly	246
Solve Plug and Print USB Drive printing problems	247
The USB Print menu does not open when you insert the USB accessory	247
The file does not print from the USB storage device	247

The file that you want to print is not listed in the USB Print menu	248
Solve product connectivity problems	248
Solve USB direct-connect problems	248
Solve network problems	248
Solve wireless network problems	251
Wireless connectivity checklist	251
The control panel displays the message: The wireless feature on this product has been turned off	252
The product does not print after the wireless configuration completes	252
The product does not print, and the computer has a third-party firewall installed	253
The wireless connection does not work after moving the wireless router or product	253
Cannot connect more computers to the wireless product	253
The wireless product loses communication when connected to a VPN	254
The network does not appear in the wireless networks list	254
The wireless network is not functioning	255
Solve product software problems with Windows	256
Solve product software problems with Mac	258
The printer driver is not listed in the Print & Scan list	258
The product name does not appear in the product list in the Print & Scan list	258
The printer driver does not automatically set up the selected product in the Print & Scan list	258
A print job was not sent to the product that you wanted	259
When connected with a USB cable, the product does not appear in the Print & Scan list after the driver is selected.	259
You are using a generic printer driver when using a USB connection	259
Appendix A Supplies and accessories	261
Order parts, accessories, and supplies	262
Part numbers	262
Appendix B Service and support	263
Hewlett-Packard limited warranty statement	264
End User License Agreement	266
OpenSSL	269
Customer support	270
Appendix C Product specifications	271
Physical specifications	272
Power consumption, electrical specifications, and acoustic emissions	272
Acoustic emissions	272
Environmental specifications	273

Appendix D Environmental product stewardship program 275

Protecting the environment 276

Ozone production 277

Power consumption 278

Paper use 279

Plastics 280

HP Officejet print supplies 281

Return and recycling instructions 282

 United States and Puerto Rico 282

 Non-U.S. returns 283

 Battery disposal 283

 Printer recycling 283

Paper 284

Material restrictions 285

Disposal of waste equipment by users 286

Electronic Hardware Recycling 287

Chemical substances 288

Material Safety Data Sheet (MSDS) 289

For more information 290

Substances Table (China) 291

Restriction on Hazardous Substances statement (Turkey) 292

Restriction on Hazardous Substances statement (Ukraine) 293

Restriction on Hazardous Substances statement (Vietnam) 294

Appendix E Regulatory information 295

Regulatory Notices 296

 Regulatory model identification number 296

 FCC Statement 296

VCCI statement (Japan) 297

Power cord instructions 298

Power cord statement (Japan) 298

EMC statement (Korea) 299

GS statement (Germany) 300

European Union Regulatory Notice 301

Additional statements for telecom (fax) products 303

 EU Statement for Telecom Operation 303

 New Zealand Telecom Statements 303

 Additional FCC statement for telecom products (US) 303

 Telephone Consumer Protection Act (US) 305

 Industry Canada CS-03 requirements 305

Note à l'attention des utilisateurs du réseau téléphonique Canadien/notice to users of the Canadian telephone network	305
Australia Wired Fax Statement	306
Notice to users of the German telephone network	306
Vietnam Telecom wired marking for ICTQC Type approved products	306
Additional statements for wireless products	307
FCC compliance statement—United States	307
Notice to users in the US and Canada	307
Australia statement	307
Brazil ANATEL statement	307
Canadian statements	307
Japan statement	308
Korean statement	308
Taiwan statement	308
Mexico statement	308
Anonymous usage information storage	309

Appendix F How do I?	311
-----------------------------------	------------

Index	313
--------------------	------------

1 Product basics

- [Product overview](#)
- [Environmental features](#)
- [Accessibility features](#)
- [Product views](#)

Product overview

HP Officejet Pro X476 MFP Series models

Officejet Pro X476dn models

CN460A



Paper handling:

- Tray 1 (50-sheet capacity for 75 GSM or 20 lb. Bond paper)
- Tray 2 (500-sheet capacity for 75 GSM or 20 lb. Bond paper)
- Optional Tray 3 (500-sheet capacity for 75 GSM or 20 lb. Bond paper)
- ADF Feeder Tray (50-sheet capacity for 75 GSM or 20 lb. Bond paper)
- Standard output bin (250-sheet capacity for 75 GSM or 20 lb. Bond paper)
- Automatic duplex printing

Supported operating systems:

- Windows XP, 32-bit (Service Pack 2 or Higher)
- Windows Vista, 32-bit and 64-bit
- Windows 7, 32-bit and 64-bit
- Windows 8, 32-bit and 64-bit
- Windows 8 Pro, 32-bit & 64-bit
- Mac OS X v10.6 and later

NOTE: For additional information on Operating System support, see Supported operating systems and printer drivers for Windows.

Connectivity:

- Hi-Speed USB 2.0
- 10/100 Ethernet (wired) LAN connection

Print:

- Simplex prints up to 30 pages per minute (ppm) for both color and black on Letter-size paper with Professional quality
- Duplex prints up to 15 pages per minute (ppm) for both color and black on Letter-size paper with Professional quality
- Plug and Print USB Drive printing (no computer required)

Copy:

- Copies at up to 20 ppm in black and 15 ppm in color
- 50-page document feeder that supports page sizes from 127 to 356 mm (5 to 14 in) in length and from 127 to 216 mm (5 to 8.5 in) in width
- Flatbed scanner supports page sizes up to 297 mm (11.7 in) in length and up to 215 mm (8.5 in) in width
- Automatic duplex copying

Scan:

- Automatic duplex scanning
- Scan to Memory Device (no computer required)

Fax:

- V.34 with an RJ-11 fax port

Officejet Pro X476dw models

CN461A



Has the same features as the Officejet Pro X476dn Series, but includes the following:

- 802.11 B/G/N Single Band wireless adapter
- HP Wireless Direct printing

HP Officejet Pro X576 MFP Series models

Officejet Pro X576dw models

CN462A



Paper handling:

- Tray 1 (50-sheet capacity for 75 GSM or 20 lb. Bond paper)
- Tray 2 (500-sheet capacity for 75 GSM or 20 lb. Bond paper)
- Optional Tray 3 (500-sheet capacity for 75 GSM or 20 lb. Bond paper)
- ADF Feeder Tray (50-sheet capacity for 75 GSM or 20 lb. Bond paper)
- Standard output bin (250-sheet capacity for 75 GSM or 20 lb. Bond paper)
- Automatic duplex printing

Supported operating systems:

- Windows XP, 32-bit (Service Pack 2 or Higher)
- Windows Vista, 32-bit and 64-bit
- Windows 7, 32-bit and 64-bit
- Windows 8, 32-bit and 64-bit
- Windows 8 Pro, 32-bit & 64-bit
- Mac OS X v10.6 and later

NOTE: For additional information on Operating System support, see Supported operating systems and printer drivers for Windows.

Connectivity:

- Hi-Speed USB 2.0
- 802.11 B/G/N Single Band wireless adapter
- 10/100 Ethernet (wired) LAN connection
- HP ePrint
- HP Wireless Direct printing

Print:

- Simplex prints up to 40 pages per minute (ppm) for both color and black on Letter-size paper with Professional quality
- Duplex prints up to 20 pages per minute (ppm) for both color and black on Letter-size paper with Professional quality
- Plug and Print USB Drive printing (no computer required)

Copy:

- Copies at up to 20 ppm in black and 15 ppm in color
- 50-page document feeder that supports page sizes from 127 to 356 mm (5 to 14 in) in length and from 127 to 216 mm (5 to 8.5 in) in width
- Flatbed scanner supports page sizes up to 297 mm (11.7 in) in length and up to 215 mm (8.5 in) in width
- Automatic duplex copying

Scan:

- Automatic duplex scanning
- Scan to Memory Device (no computer required)

Fax:

- V.34 with an RJ-11 fax port

Environmental features

Duplex printing	Automatic duplex printing is available with the Officejet Pro X476 and Officejet Pro X576. Duplex printing saves the environment and saves you money.
Print multiple pages per sheet	Save paper by printing two or more pages of a document side-by-side on one sheet of paper. Access this feature through the printer driver.
Copies multiple pages per sheet	Save paper by copying two pages of an original document side-by-side on one sheet of paper.
Recycling	Reduce waste by using recycled paper. Recycle ink cartridges by using the HP Planet Partners return process.
Energy savings	Sleep modes and timer options enable this product to quickly go into reduced power states when not printing, thus saving energy.



NOTE: Additional energy savings may be realized by turning off the printer if it will not be used for more than four hours.

Accessibility features

The product includes several features that aid users with limited vision, hearing, dexterity or strength.

- Online user guide that is compatible with text screen-readers.
- Ink cartridges can be installed and removed using one hand.
- All doors and covers can be opened using one hand.

Product views

Front view

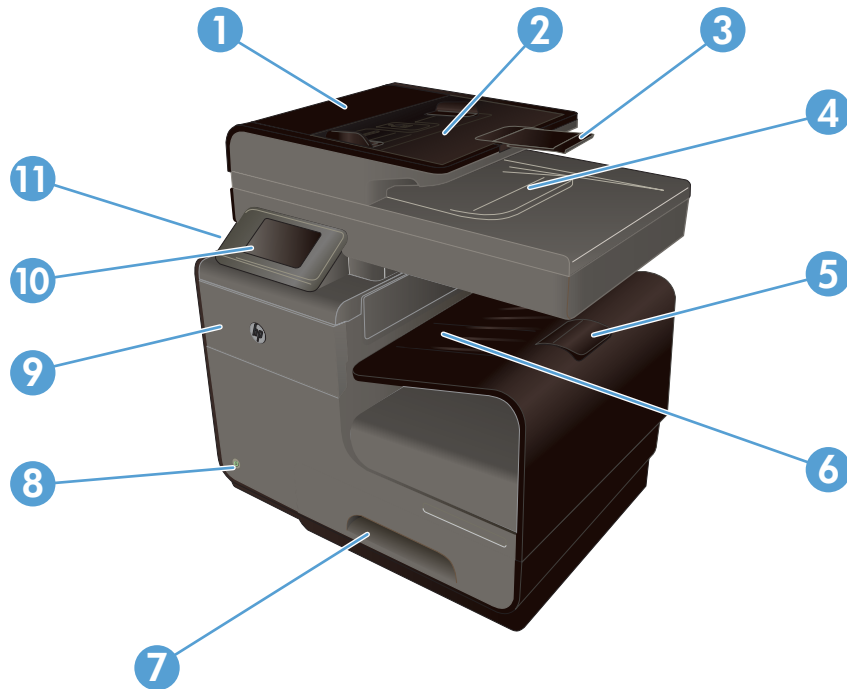

1	Document feeder cover, provides access for clearing jams
2	Document feeder input tray
3	Document feeder input tray extension
4	Document feeder output bin
5	Output bin extension
6	Output bin
7	Tray 2 - Main paper tray
8	On/Off button
9	Ink cartridge door
10	Color touch screen control panel
11	USB 2.0 port

 **IMPORTANT:** Caution should be taken when moving the printer since tilting at an angle of > 15 degrees could result in ink leakage, especially soon after startup.

Back view

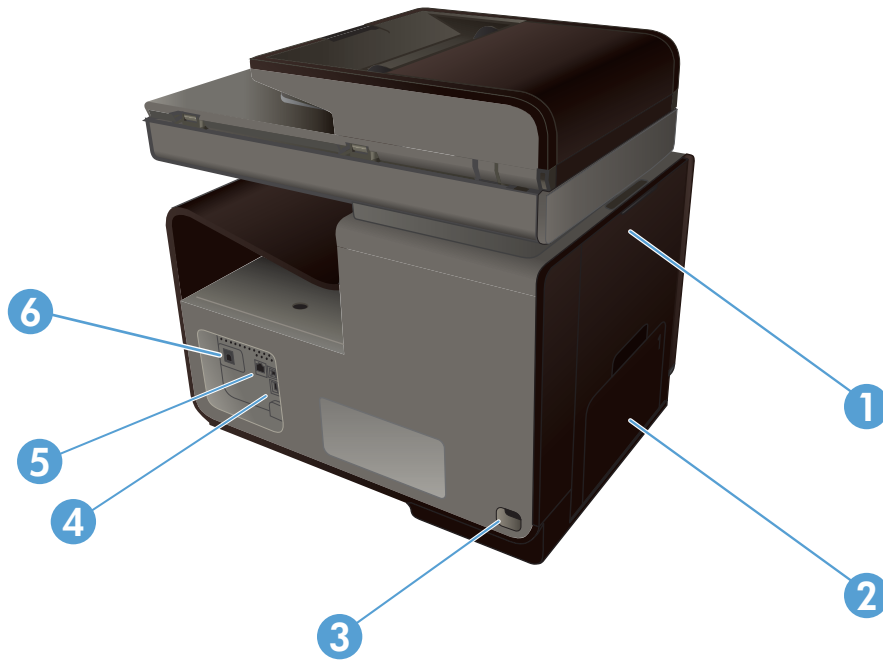

1	Left door (access for clearing jams)
2	Tray 1 (Multi-purpose tray)
3	Power connection
4	Hi-Speed USB 2.0 ports
5	Ethernet port
6	Fax line port

Interface ports

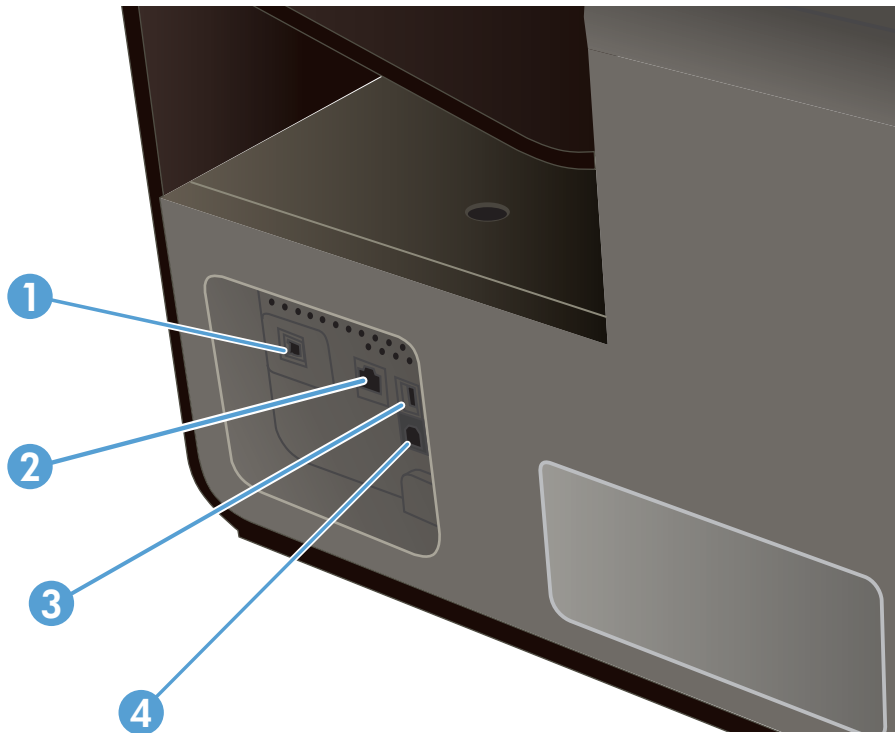

1	Fax line port
2	Ethernet port
3	USB Host port accepts USB storage devices for Scan-to-USB and Plug and Print. NOTE: A USB Host port is also located on the front of the product behind the control panel.
4	USB Device port accepts a USB cable from a PC (alternative to Network and Wireless connections).

Serial number and model number location

Open the ink cartridge door to view the serial number and product model number label.

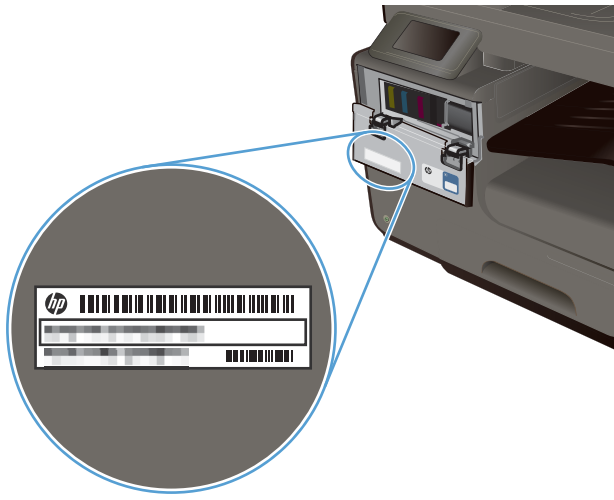

Control panel layout





1		Display and touch screen area
2	?	Help button: provides access to the product help system
3	▶	Right arrow button: moves the cursor to the right or moves the display image to the next screen NOTE: This button illuminates only when the current screen can use this feature.
4	✖	Cancel button: cancels the current job or exits the current screen. NOTE: This button illuminates only when the current screen can use this feature.
5	↶	Back button: returns to the previous screen NOTE: This button illuminates only when the current screen can use this feature.
6	◀	Left arrow button: moves the cursor to the left NOTE: This button illuminates only when the current screen can use this feature.
7	🏠	Home button: provides quick access to the Home screen. This button only illuminates only when the current screen can use this feature.
8	📶	Wireless light: indicates the wireless network is enabled. The light blinks while the product is establishing a connection to the wireless network. When connected, the light stops blinking and stays lit.

Buttons on the Home screen

The Home screen provides access to the product features, and it indicates the product status.

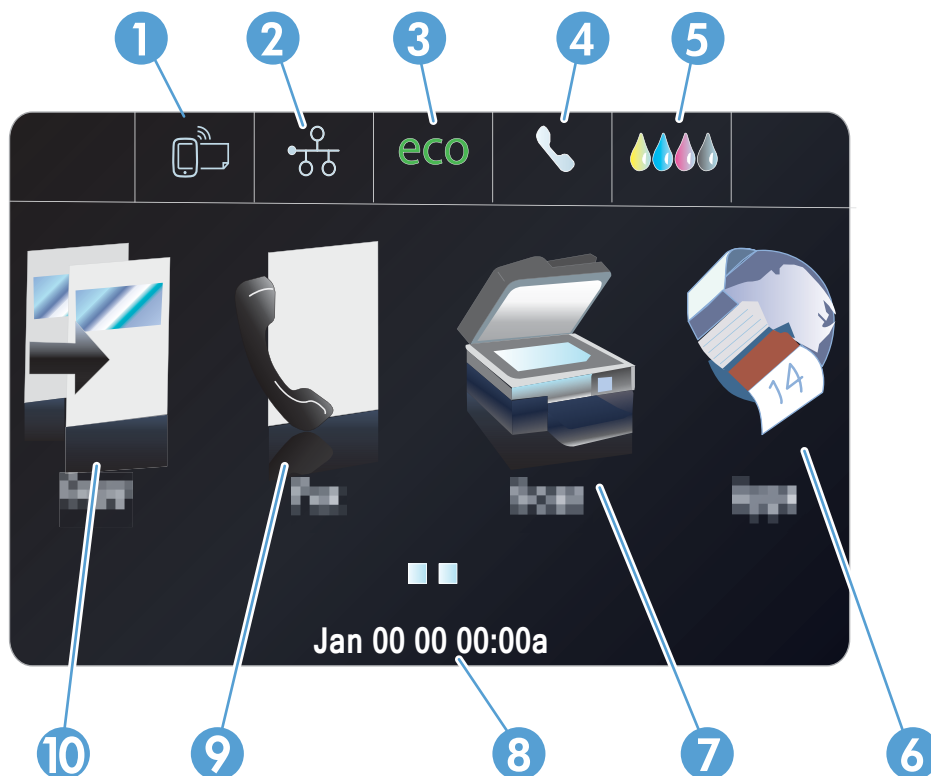



 **NOTE:** Depending on the product configuration, the features on the Home screen can vary. The layout might also be reversed for some languages.



- 1 Web Services  button: provides quick access to HP Web Services features, including HP ePrint.

HP ePrint is a tool that prints documents by using any e-mail enabled device to send them to the product's e-mail address.
- 2 Network  button: provides access to network settings and information. From the network settings screen, you can print the [Network Summary](#) page, set up a wireless network connection, and access advanced network settings.



NOTE: The wireless network feature is only available on select models.

NOTE: When you are connected to a wireless network, this icon changes to a set of signal strength bars.
- 3 Eco Settings **eco** button: provides a list of options to help reduce energy and paper consumption.
- 4 Fax Status  button: provides a list of available fax reports and settings.
- 5 Supplies  button: provides information about supplies status. From the supplies summary screen, you can print the [Supplies Status](#) page.
- 6 [Apps](#)  button: provides access to the [Apps](#) menu to print directly from select Web applications.
- 7 [Scan](#)  button: provides access to the scan feature.

8 Status display. When the product is idle, this area of the control panel displays the time and date and allows for access to the time and date settings by touching this area. When the product is processing a job, job status information replaces the time and date display.

9 **Fax**  button: provides access to the fax feature.

10 **Copy**  button: provides access to the copy feature.

From the Home screen you can touch the right arrow button of the Control Panel to access the **USB Doc Print**  button and **Setup**  button. The USB Doc Print button provides access to the Plug and Print USB Drive printing and scanning feature (no computer is required), and the Setup button provides access to the product settings.

Control panel help system

The product has a built-in Help system that explains how to use each screen. To open the Help system, press the Help ? button in the upper-right corner of the control panel.

For some screens, the Help opens to a global menu where you can search for specific topics. You can browse through the menu structure by touching the buttons in the menu.

Some Help screens include animations that guide you through procedures, such as clearing paper jams.

For screens that contain settings for individual tasks, the Help opens to a topic that explains the options for that task.

2 Control panel menus

- [Copy menu](#)
- [Fax menus](#)
- [Scan menus](#)
- [Apps](#)
- [Plug and Print](#)
- [Setup Menu](#)

Copy menu

To access these features, touch the **Copy**  button, from the Control Panel.



NOTE: Settings that you change with this menu expire 2 minutes after the last copy completes.

Menu item	Sub-menu item	Sub-menu item	Description
Number of Copies	(1–99)		Specifies the number of copies
Two-Sided	1-Sided to 1-Sided Copy*		Specifies the duplex setting for copies.
	1-Sided to 2-Sided Copy		
	2-Sided to 1-Sided Copy		
	2-Sided to 2-Sided Copy		
Lighter/Darker			Specifies how light or dark you would like to make the copy.
Start	Black		Specifies to make a black and white or color copy.
	Color		
Preview			Provides an on-screen preview of what is being copied.

Menu item	Sub-menu item	Sub-menu item	Description			
Settings	HP Copy Fix	On	Enhances printouts by removing dark edges and fixing page skew problems for black and white copies.			
		Off*				
	ID Copy	On	Copies both sides of identification cards, or other small-size documents, onto the same side of one sheet of paper.			
		Off*				
	Resize	Actual*	Resizes the copy.			
		Full Page=91%				
		Fit to Page				
		Legal to Letter=72%				
		A4 to Letter=91%				
		Custom Size				
	Quality	Presentation	Professional*	Sets the copy quality.		
			General Office			
			Collate		On	Specifies whether to collate copy jobs
			Off*			
Margin Shift	On	Off*	Shifts the left margin for binding.			
		Crop			Allows you to copy a specific portion of the page.	
Copy Preview			Provides an on-screen preview of what is being copied.			
Tray Selection	Tray 1	Tray 2*	Specifies which tray, and the paper size and type, to use for copies.			
		Tray 3				
		Enhancements		Text	Enhances specific aspects of your copy	
Photo						
Mixed*						
None						
Set as New Defaults			Saves any changes you have made to this menu as the new defaults			

Fax menus

To open these menus, touch the Fax  button.

Menu item	Sub-menu item	Sub-menu item	Description
Settings	Resolution	Standard	Sets the resolution for sent documents. Higher resolution images have more dots per inch (dpi), so they show more detail. Lower resolution images have fewer dots per inch and show less detail, but the file size is smaller.
		Fine*	
		Very Fine	
		Photo	
	Lighter/Darker		Sets the brightness level of the fax.
	Fax Send Original	1-Sided Original 2-Sided Original 2-Sided Original With Cover Page	Sets how faxes are sent on paper.
	Set as New Defaults		Saves any adjusted settings as the new default for the product.
Fax Methods	Scan and Fax		Allows the product to scan the entire document before dialing, and it prints an image of the first page faxed on the confirmation page.
	Broadcast Fax		The broadcast feature can be used to send a fax to a distribution list. A broadcast list must be created before sending a broadcast fax.
	Send Fax Later		Allows a fax to be sent at a later time and date.
	Poll to Receive		Allows the product to send a fax from another machine remotely .

Scan menus

To open these menus, touch the **Scan**  button.

Menu item	Sub-menu item	Sub-menu item	Description
Computer			Scans to a computer that is on the same network or connected to the product
Memory Device			Scans to a USB drive connected to the product.
Network Folder			Scans to a folder or directory on the network.
Email			Sends the scan to a specified email address.
Document Type	PDF Color (Compressed)		
	PDF Color		
	PDF Black		
	JPEG Color		
	JPEG Grayscale		
Resolution	TIFF Black		
	600 dpi* (default resolution for scanning from glass)		Specifies the resolution to use for the scanned image.
	300 dpi* (default resolution for from ADF)		Scan quality increases with higher resolution, but the file size also increases.
	200 dpi		
Filename	75 dpi		
			Provides a way to set a standard name prefix for scan job files.
Settings (Settings can be adjusted after you select the scanning method)	Original	1-Sided Original*	Specifies the number of sides of the original document to scan.
		2-Sided Original	
	Lighter/Darker		Allows the scan to be darkened or lightened based on the slider selection.

Menu item	Sub-menu item	Sub-menu item	Description
	Paper Size	Automatic* Letter (8.5 x 11in.) Legal (8.5 x 14in.) 4x6 5x7	Specifies the size of the page to use for the scanned file. The default page size will vary depending on your country.
	Set as New Defaults		Saves any changes you have made to this menu as the new defaults.

Apps

Use the Apps menu to enable Web Services on the product and use HP ePrint and print Apps.

Plug and Print

Use the Plug and Print menu to print directly from a USB Flash or Hard Drive device.

Setup Menu

To open this menu, touch the [Setup](#)  button. The following sub menus are available:

- [Fax Setup menu](#)
- [Network Setup menu](#)
- [HP Digital Solutions Setup menu](#)
- [Device Setup menu](#)
- [Tools menu](#)
- [Print Reports menu](#)

Fax Setup menu

In the following table, items that have an asterisk (*) indicate the factory default setting.

Menu item	Sub-menu item	Sub-menu item	Description
Fax Setup Wizard			This is a tool for configuring the fax settings. Follow the on-screen prompts and select the appropriate response for each question.
Speed-Dial Setup	Add/Edit Speed-Dial		Configures stored individual and group contact fax information.
	Group Speed-Dial		
	Delete Speed-Dial		
	Print Speed-Dial		
Basic Fax Setup	Fax Header	Enter your name.	Sets the identifying information that is sent to the receiving product.
		Enter your fax number.	
	Two-Sided Fax Print	Print on 1 Side*	Print incoming faxes for ease or economy.
		Print on 2 Sides	
	Auto Answer	On*	Receive faxes automatically (on) or manually (off). Default setting varies by country.
		Off	
	Rings to Answer		Sets the number of rings that must occur before the fax modem answers. The default setting is 5.
	Fax Paper Size	Letter (8.5 x 11 in.)	Sets the default paper size for outgoing faxes.
		A4 (297 x 210 mm)	
		Legal (8.5 x 14 in.)	
	Fax Sound Volume	Soft*	Sets the volume for listening to initial fax connection signals.
		Loud	
		Off	
	Dial Type	Tone Dialing*	Sets whether the product should use tone or pulse dialing.
		Pulse Dialing	
	Dial Prefix	On	Specifies a prefix number that must be dialed when sending faxes from the product. If you turn this feature on, the product prompts you to enter the number and then it automatically includes that number every time you send a fax.
		Off*	
	Block Junk Faxes	Block Junk Faxes	Modifies the junk fax list. The junk fax list can contain up to 100 numbers. When the product receives a call from one of the junk fax numbers, it deletes the incoming fax. It also logs the junk fax in the activity log with other job-accounting information. Print reports allows you to chose from printing the Junk Fax List, Caller ID History, and Fax Log.
		Add Numbers	
		Remove All Numbers	
		Print Reports	
			NOTE: This feature requires subscription of caller ID services with your telephone company.

Menu item	Sub-menu item	Sub-menu item	Description
	HP Digital Fax	View Settings Fax Print Disable HP Digital Fax	To use the HP Digital Fax feature, set it up using the software that came with the product and a computer that is connected to the same network as the product.
Advanced Fax Setup	Distinctive Ring	Ring Pattern Detection All Rings* Single Double Triple Double and Triple	<p>If you have distinctive ring phone service, use this item to configure how the product responds to incoming calls.</p> <ul style="list-style-type: none"> • All Rings: The product answers any calls that come through the telephone line. • Single: The product answers any calls that produce a single-ring pattern. • Double: The product answers any calls that produce a double-ring pattern. • Triple: The product answers any calls that produce a triple-ring pattern. • Double and Triple: The product answers any calls that produce a double-ring or triple-ring pattern.
	Redial Setup	Busy Redial No Answer Redial Communication Error Redial	Sets whether the product should attempt to redial if the line is busy, there is no answer, or if there is a communication error.
	Fax Stamping	On Off*	Sets the product to print the date, time, sender's phone number, and page number on each page of incoming faxes.
	Fax Confirmation	On (Fax Send)* On (Fax Receive) On (Send and Receive) Off	Prints a thumbnail image of the fax on the Fax Confirmation page, if enabled.
	Automatic Reduction	On* Off	<p>If the fit-to-page option is turned on, the product automatically reduces long faxes up to 75% to fit the information on the default paper size (for example, the fax is reduced from legal to letter size).</p> <p>If the fit-to-page option is turned off, long faxes print at full size on multiple pages. The factory-set default for incoming fax auto reduction is On.</p> <p>If you have the stamp-received faxes option turned on, you might also want to turn on auto reduction. This reduces the size of the incoming faxes slightly, and prevents the page-stamp from forcing a fax onto two pages.</p>

Menu item	Sub-menu item	Sub-menu item	Description
	Backup Fax Reception	On* On Error Only Off	Stores an electronic backup of received faxes
	Error Correction Mode	On* Off	The error correction mode allows the sending device to re-transmit data if it detects an error signal.
	Confirm Fax Number	On Off*	Sets whether the product confirms a fax number before sending.
	Fax Speed	Fast (33600 bps)* Medium (14400 bps) Slow (9600 bps)	Sets the fax communication speed.
	Fax forwarding	On (Print and Forward) On (Forward) Off*	Forwards the fax to another fax machine. Select the print and forward option to print a hard copy.
	Fax Report	On (Fax Send)* On (Fax Receive) On (Send and Receive) Off	Prints a fax information page based on the selected settings.
	Restore Fax Defaults		Resets all fax configurations to their factory defaults.
Fax Tools	Reprint Faxes in Memory		The product reprints all stored faxes.
	Run Fax Test		Performs a fax test to verify that the phone cord is plugged in the correct outlet and that there is a signal on the phone line. A fax test report is printed indicating the results.
	Clear Fax Log		Clears all faxes in memory.
Fax Reports	Last Transaction		Prints a detailed report of the last fax operation, either sent or received.
	Fax Log		Prints the last 30 entries in the fax log.
	Speed-Dial List		Prints a list of the speed dials that have been set up for this product. The speed-dial list holds up to 99 numbers.
	Caller ID Report		Prints a list of all incoming fax phone numbers, up to the maximum of 30 numbers.
	Junk Fax Report		Prints a list of phone numbers that are blocked from sending faxes to this product.

Network Setup menu

In the following table, items that have an asterisk (*) indicate the factory default setting.



NOTE: Wireless menu options are only available on products that support wireless connectivity. For more information, refer to the Product Basics chapter of this user guide.

Menu item	Sub-menu item	Sub-menu item	Description
Wireless Menu (wireless products only)	On		Enables or disables the wireless network feature.
	Off		
NOTE: You can also access this menu by touching the Wireless  button on the control panel.	On		Configure the Wireless Direct settings for the product.
	On With Security		
	Off		
Wireless Setup Wizard (wireless products only)	Print Guide		Guides you through the steps to set up the product on a wireless network.
	Continue		
Wi-Fi Protected Setup (wireless products only)	Continue	Push Button	If your wireless router supports WPS, use this method to set up the product on a wireless network. This is the simplest method.
		PIN	
View Network Summary	View Wired		Prints a summary of your network settings.
	View Wireless		
Print Wireless Test Report (wireless products only)			Prints a wireless test report.
Print Network Configuration Page			Prints a report of your network configuration settings.
Advanced Setup	Link Speed	Automatic*	Sets the link speed. After setting the link speed, the product automatically restarts.
		10T Full	
		10T Half	
		100TX Full	
		100TX Half	
	IP Settings	Automatic (DHCP)*	Set whether the product's IP setting are configured automatically with DHCP or set manually.
		Manual (Static)	
	IPv6	On*	Enable or disable the IPv6 protocol on the product.
		Off	

Menu item	Sub-menu item	Sub-menu item	Description
	Hostname	OK Change	Use this setting the change how the product is identified on the network.
	Legacy Default IP	On Off	
Restore Network Defaults			Resets all network configurations to their factory defaults.

HP Digital Solutions Setup menu

In the following table, items that have an asterisk (*) indicate the factory default setting.

Menu item	Sub-menu item	Description
Digital Solution Setup Wizard		Guides you through the steps to set up HP Digital Solutions

Device Setup menu

In the following table, items that have an asterisk (*) indicate the factory default setting.

Menu item	Sub-menu item	Sub-menu item	Sub-menu item	Description	
Preferences	Date and Time			Sets the time format, current time, date format, and current date for the product.	
		Language	List of available control-panel display languages.	Sets the language in which the control panel displays messages and product reports.	
		Country/Region	List of available countries/regions		
	Keyboard		QWERTY*		Selects which keyboard layout to use on the Control Panel.
			AZERTY		
			QWERTZ		
		Screen Brightness			Adjust the sliding bar to control the screen brightness on the Control Panel
	Sound Effects Volume	Soft*		Adjusts the product's sound effect level.	
		Loud			
		Off			
	Faster Browsing	On		Sets the browsing speed to go faster than the default.	
		Off*			
Paper Handling	Default Tray	Tray 1 (Multipurpose)		Sets the default tray to print from for copying documents.	
		Tray 2 (Main)*			
		Tray 3 (Accessory) only if installed			
	Tray Selection	For Copy		Sets the default tray for copying, for plug and print printing, and fax printing.	
		For Plug and Print			
		For Fax Print			

Menu item	Sub-menu item	Sub-menu item	Sub-menu item	Description
	Paper Selection	Tray 1	Default paper size	Sets the default media size and type for each tray.
		Tray 2	Letter (8.5 x 11 in.)	
		Tray 3	A4 (297 x 210 mm)	
			...	
			For a complete list of paper sizes, see Supported paper sizes.	
			Default paper type	
			Plain Paper	
			Premium Inkjet	
			...	
			For a complete list of paper sizes, see Supported paper types and tray capacity.	
Default Paper in Tray	Tray 1	Default Paper Size	Letter (8.5 x 11 in.) A4 (297 x 210 mm) ...	Select the default paper size for Tray 1 (multi-purpose tray).
		Default Paper Type	Plain Paper Premium Inkjet ...	Sets the paper type for printing internal reports, faxes, or any print job that does not specify a type.
			For a complete list of paper sizes, see Supported paper types and tray capacity.	

Menu item	Sub-menu item	Sub-menu item	Sub-menu item	Description
	Tray 2	Default Paper Size	Letter (8.5 x 11 in.) A4 (297 x 210 mm) ...	Select the default paper size for Tray 2 (main paper tray).
		Default Paper Type	Plain Paper Premium Inkjet ...	Sets the paper type for printing internal reports, faxes, or any print job that does not specify a type.
	Tray 3	Default Paper Size	Letter (8.5 x 11 in.) A4 (297 x 210 mm) ...	Sets the default paper size for the optional Tray 3.
		Default Paper Type	Plain Paper Premium Inkjet ...	Sets the type of paper for printing internal reports, faxes, or any print job that does not specify a type.
Tray Lock	Tray 1 Tray 2 Tray 3 None*			Tray Lock is a feature that "locks" a tray so that the only time the printer will draw from that tray is when it is specifically requested. This is useful when putting special paper in a tray, such as letterhead. If using "Automatically Select" for the paper source and Tray 1 is locked, the printer will only draw from the remaining trays, either Tray 2 or optional Tray 3, if it is installed. Printing can still be done from the locked tray, but the source must be specified. Tray 1 lock may be overridden under certain conditions.

Menu item	Sub-menu item	Sub-menu item	Sub-menu item	Description
Ink Low Warning Level	Automatic			Determines when the Low Ink warning message appears on the control panel. Chose Custom to select a cartridge color and ink level value from 1–99.
	Custom			
Power Handling	Standby	5 minutes		Determines when to put the product in Standby mode.
		10 minutes*		
		15 Minutes		
		30 Minutes		
		1 Hour		
	Sleep after Standby	15 Minutes After Standby		Determines when to put the product to sleep after it has been put into Standby mode.
		30 Minutes After Standby		
		1 hour After Standby		
		2.hours.after.standby*		
	Schedule On/Off	Schedule On		Schedules a time to automatically turn the product on or off.
		Schedule Off		
Print Settings	Personality	Automatic*		Sets the printer language. By default, the product automatically selects which language to use.
		PCL5 Only		
		PCL6 Only		
		PS Only		
	Copies			Sets the number of copies (0–99) to make when the Copy button is touched. The default value is 1.
	Quality	General Office		Sets the default print quality.
		Professional		
		Presentation		
	Duplex	On		Set the product's auto-duplexing feature.
		Off		

Menu item	Sub-menu item	Sub-menu item	Sub-menu item	Description
	PCL Configuration	Form Length		Sets the text attributes for the printer control language being used.
		Orientation		
		Font Number		
		Font Pitch		
		Font Point Size		
		Symbol Set		
		Append CR to LF		
	Print Postscript Error	On		Sets the product to print any postscript errors that occur.
		Off		

Tools menu

Use the [Tools](#) menu to improve the product's print quality and view estimated ink levels.

Menu item	Description
Display Estimated Ink Levels	Displays a graph of how much ink has been consumed for each cartridge.
Clean Printhead	Use this feature to clean, adjust, and align the printheads. Follow the on-screen instructions to correctly improve the product's print quality.
Cartridge Chip Information	The cartridge chip stores anonymous information about the usage of the product.
Control Panel Lock	Use this feature to lock the product's control panel and prevent unauthorized use of the product.
Clean Ink Smear	Use this feature to solve print quality problems caused by ink smearing on printed pages.
Restore Factory Defaults	Sets all settings to the factory default values.

Print Reports menu

Use the [Print Reports](#) menu to print reports that provide information about the product.

Menu item	Sub-menu item	Description
Printer Status Report		Prints current product information, cartridge status, and more assistance.
Print Quality Report		Prints a quality test that will help you diagnose minor print issues
Usage Page		Shows a count of all paper sizes that have passed through the product; lists whether they were monochrome or color, simplex or duplex, and reports the page count. This report is useful for reconciling contractual billing statements.
Network Configuration Page		Prints useful information about the product's wired or wireless network connection.
Event Log		Prints a list of errors and intermittent failures designed to help you troubleshoot problems.
Fax Reports	Last Transaction Fax Log Speed-Dial List Caller ID Report Junk Fax Report	Provides a list of report options that will help you manage the product's fax features.
PCL Font List		Prints a list of all the PCL fonts that are installed.
PCL6 Font List		Prints a list of all the PCL6 fonts that are installed.
PS Font List		Prints a list of all the PS fonts that are installed

3 Connect the product

- [Connect the product using a USB cable](#)
- [Connect the product to a network](#)
- [Install the product on a wireless network \(wireless models only\)](#)

Connect the product using a USB cable

This product supports a USB 2.0 connection. Use an A-to-B type USB cable. HP recommends using a cable that is no longer than 2 m (6.5 ft).

CAUTION: Do not connect the USB cable until the installation software prompts you to connect it.

CD installation

1. Quit all open programs on the computer.
2. Install the software from the CD, and follow the onscreen instructions.

NOTE: If you are installing on a Mac, click the HP Installer icon to install the software.

3. When prompted, select the **USB-Connect the printer to the computer using a USB cable** option, and then click the **Next** button.

NOTE: A dialog displays warning that Web Services (HP ePrint and print Apps) will not be available with a USB installation. Click the **Yes** button to proceed with the USB installation, or click the **No** button to cancel the USB installation.

4. When the software prompts you, connect the USB cable to the computer and the product.

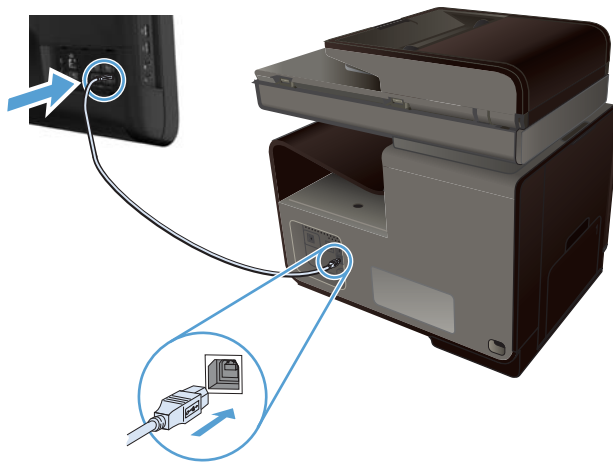

5. When the installation is complete, print a page from any program to make sure that the printing software is correctly installed.

Connect the product to a network

Supported network protocols

To connect a networking-equipped product to a network, you need a network that uses one or more of the following protocols.

- TCP/IP (IPv4 or IPv6)



NOTE: While this product can be used over IPv6 networks, a product software installation from the CD is not supported over IPv6 networks.

- LPD Printing
- SLP
- WS-Discovery
- HP Wireless Direct

Install the product on a wired network

Use this procedure to install the product on a wired network using Windows.

Obtain the IP address

1. Connect the ethernet cable to the product and to the network. Turn the product on.

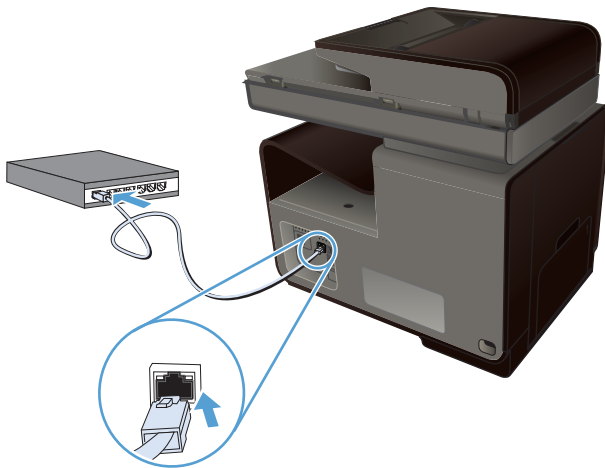

2. Wait for 60 seconds before continuing. During this time, the network recognizes the product and assigns an IP address or host name for the product.
3. Touch the Network  button to display the IP address.

For more information about the network connection, print a network configuration page:

1. Touch the [Print Reports](#) menu.
2. Touch the [Network Configuration Page](#) menu item to print the network configuration report.
3. Find the IP address on the network configuration report.



Install the software

1. Quit all programs on the computer.
2. Install the software from the CD.
3. Follow the onscreen instructions.
4. When prompted, select the **Wired Network - Connect the printer to your network using an Ethernet cable.** option, and then click the **Next** button.
5. From the list of available printers, select the printer that has the correct IP address.
6. When the installation is complete, print a page from any program to make sure that the printing software is correctly installed.

Configure IP network settings

View or change network settings

Use the embedded Web server to view or change IP configuration settings.

1. Print a configuration page, and locate the IP address.
 - If you are using IPv4, the IP address contains only digits. It has this format:
`xxx . xxx . xxx . xxx`
 - If you are using IPv6, the IP address is a hexadecimal combination of characters and digits. It has a format similar to this:

xxxx : : xxxx : xxxx : xxxx : xxxx

2. To open the HP Embedded Web Server, type the IP address (IPv4) into the address line of a Web browser. For IPv6, use the protocol established by the Web browser for entering IPv6 addresses.
3. Click the **Networking** tab to obtain network information. You can change settings as needed.

Set or change the product password

Use the HP Embedded Web Server to set a password or change an existing password for a product on a network so unauthorized users cannot change the product settings.

1. Type the product IP address into the address line of a Web browser. Click the **Settings** tab, click **Security**, and then click the **Password Settings** link.

 **NOTE:** If a password has previously been set, you are prompted to type the password. Type "admin" for User Name along with the password, and then click the **Apply** button.

2. Type the new password in the **Password** box and in the **Confirm Password** box.
3. At the bottom of the window, click the **Apply** button to save the password.

Manually configure IPv4 TCP/IP parameters from the control panel

Use the control-panel menus to manually set an IPv4 address, subnet mask, and default gateway.

1. Touch the **Setup**  button.
2. Scroll to and touch the **Network Setup** menu.
3. Touch the **Advanced Setup** menu, and then touch the **IPv4 Settings** button.
4. Touch the **Manual IP Address** button
5. Use the numeric keypad to enter the IP address, and touch the **OK** button. Touch the **Yes** button to confirm.
6. Use the numeric keypad to enter the subnet mask, and touch the **OK** button. Touch the **Yes** button to confirm.
7. Use the numeric keypad to enter the default gateway, and touch the **OK** button. Touch the **Yes** button to confirm.

Link speed and duplex settings

 **NOTE:** This information applies only to Ethernet (wired) networks. It does not apply to wireless networks.

The link speed and communication mode of the print server must match the network hub. For most situations, leave the product in automatic mode. Incorrect changes to the link speed and duplex settings might prevent the product from communicating with other network devices. If you need to make changes, use the product control panel.

 **NOTE:** The setting must match with the network product to which you are connecting (a network hub, switch, gateway, router, or computer).

 **NOTE:** Making changes to these settings causes the product to turn off and then on. Make changes only when the product is idle.

1. Touch the **Setup**  button.
2. Scroll to and touch the **Network Setup** menu.
3. Touch the **Advanced Setup** menu item.
4. Touch the **Link Speed** menu.
5. Select one of the following options.

Setting	Description
Automatic	The print server automatically configures itself for the highest link speed and communication mode allowed on the network.
10T Half	10 megabytes per second (Mbps), half-duplex operation
10T Full	10 Mbps, full-duplex operation
100TX Half	100 Mbps, half-duplex operation
100TX Full	100 Mbps, full-duplex operation

6. Touch the **OK** button. The product turns off and then on.

HP ePrint

With HP ePrint, you can print anywhere, anytime, from a mobile phone, laptop, or any other mobile device. HP ePrint works with any email-capable device. If you can e-mail, you can print to an HP ePrint-enabled product. For more details, go to www.hpeprintcenter.com.

 **NOTE:** The product must be connected to a network and have Internet access to use HP ePrint.

HP ePrint is disabled as a default setting in the product. Use this procedure to enable it.

1. Type the product IP address into the address line of a Web browser to open the HP Embedded Web Server.
2. Click the **HP Web Services** tab.
3. Select the option to enable Web Services.

Install the product on a wireless network (wireless models only)

Before installing the product software, make sure the product is not connected to the network using an ethernet cable.

If your wireless router does not support Wi-Fi Protected Setup (WPS), obtain the wireless router network settings from your system administrator, or complete the following tasks:

- Obtain the wireless network name or service set identifier (SSID).
- Determine the security password or encryption key for the wireless network.

Connect the product to a wireless network using the Wireless Setup Wizard

The wireless setup wizard is the best method for installing the product on a wireless network.

1. From the Home screen on the product control panel, touch the **Setup**  button.
2. Touch the **Network** button, and then touch the **Wireless Setup Wizard** button.
3. The product scans for available wireless networks and returns a list of network names (SSIDs). Select the SSID for your wireless router from the list if it is available. If the SSID for your wireless router is not in the list, touch the **Enter SSID** button. When prompted for the type of network security, select the option that your wireless router uses. A keypad opens on the control panel display.
4. If your wireless router uses WPA security, type the passphrase on the keypad.
If your wireless router uses WEP security, type the key on the keypad.
5. Touch the **OK** button, and wait while the product establishes a connection with the wireless router. Establishing the wireless connection can take a few minutes.

Connect the product to a wireless network using WPS

1. From the Home screen on the product control panel, touch the **Setup**  button.
2. Touch the **Network** menu button, and then touch **Continue**.
3. Use one of these methods to complete the setup:
 - **Pushbutton:** Select the **Push Button** option and follow the instructions on the control panel. Establishing the wireless connection can take a few minutes.
 - **PIN:** Select the **Generate PIN** option and follow the instructions on the control panel. The product generates a unique PIN, which you must type into the wireless router's setup screen. Establishing the wireless connection can take a few minutes.

 **NOTE:** If this method is not successful, try using the Wireless Setup Wizard on the product control panel or try using the USB cable connection method.

Install the software for a wireless product currently on the network

If the product already has an IP address on a wireless network and you want to install product software on a computer, complete the following steps.

1. From the product control panel, print a configuration page to obtain the product IP address.
2. Install the software from the CD.
3. Follow the on-screen instructions.
4. When prompted, select the **Wireless- Connect the printer to your wireless network and internet.** option, and then click the **Next** button.
5. From the list of available printers, select the printer that has the correct IP address.

Manually connect the product to a wireless network

During the first 120 minutes of product setup, or after resetting the product's network defaults (and without a network cable attached to the product), the product's wireless radio will broadcast a wireless setup network for the product.

The name of this network is "HP-Setup-xx-[product name]".

 **NOTE:** The “xx” in the network is name is the last two characters of the product's MAC address. The product name will be either HP Officejet Pro X476 MFP Series or HP Officejet Pro X576 MFP Series.

1. From a wireless enabled product, connect to the setup network for the device.
2. Open a web browser while connected to this setup network, and open the HP Embedded Web Server (HP EWS) using the following IP address:
 - 192.168.223.1
3. Find the Wireless Setup Wizard in the product's EWS and follow the on screen instructions to manually connect the product.

 **NOTE:** The product uses Automatic DHCP by default.

4 Use the product with Windows

- [Supported operating systems and printer drivers for Windows](#)
- [Select the correct printer driver for Windows](#)
- [Change print job settings for Windows](#)
- [Remove the printer driver from Windows](#)
- [Supported utilities for Windows](#)

Supported operating systems and printer drivers for Windows

The product supports the following Windows operating systems:

Recommended software installation

- Windows XP (32-bit, Service Pack 2 or higher)
- Windows Vista (32-bit and 64-bit)
- Windows 7 (32-bit and 64-bit)
- Windows 8 (32-bit and 64-bit)

Print and scan drivers only

- Windows 2003 Server (32-bit, Service Pack 3)
- Windows 2008 Server
- Windows 2008 Server R2

NOTE: Windows Server install support is available through the Enterprise (command line) install method only.

The product supports the following Windows printer drivers:

- HP PCL 6 (this is the default printer driver and is included on the CD)
- HP Universal Print Driver for Windows Postscript
- HP Universal Print Driver for PCL 5
- HP Universal Print Driver for PCL 6

The printer drivers include online Help that has instructions for common printing tasks and also describes the buttons, checkboxes, and drop-down lists that are in the printer driver.



NOTE: For downloads of, and more information about, the HP UPD Postscript, PCL 5, and PCL 6 drivers, see www.hp.com/go/upd.

Select the correct printer driver for Windows

Printer drivers provide access to the product features and allow the computer to communicate with the product (using a printer language). The following printer drivers are available at <http://www.hp.com/go/support>.

HP PCL 6 driver (This print driver is provided on the in-box CD and is also available from <http://www.hp.com/go/support>.)

- Provided as the default driver. This driver is automatically installed unless you select a different one.
- Recommended for all Windows environments
- Provides the overall best speed, print quality, and product-feature support for most users
- Developed to align with the Windows Graphic Device Interface (GDI) for the best speed in Windows environments
- Might not be fully compatible with third-party and custom software programs that are based on PCL 5

HP UPD PS driver (This print driver is available for download from www.hp.com/go/upd)

- Recommended for printing with Adobe® software programs or with other highly graphics-intensive software programs
- Provides support for printing from postscript emulation needs, or for postscript flash font support

HP UPD PCL 5 (This print driver is available for download from www.hp.com/go/upd)

- Recommended for general office printing in Windows environments
- Compatible with previous PCL versions and older HP Officejet products
- The best choice for printing from some third-party or custom software programs
- The best choice when operating with mixed environments, which require the product to be set to PCL 5 (UNIX, Linux, mainframe)
- Designed for use in corporate Windows environments to provide a single driver for use with multiple printer models
- Preferred when printing to multiple printer models from a mobile Windows computer

HP UPD PCL 6 (This print driver is available for download from www.hp.com/go/upd)

- Recommended for printing in all Windows environments
 - Provides the overall best speed, print quality, and printer feature support for most users
 - Developed to align with Windows Graphic Device Interface (GDI) for best speed in Windows environments
 - May not be fully compatible with third-party and custom solutions based on PCL5
-

HP Universal Print Driver (UPD)

The HP Universal Print Driver (UPD) for Windows is a single driver that gives you instant access to virtually any HP Officejet product, from any location, without downloading separate drivers. It is built on proven HP print driver technology and has been tested thoroughly and used with many software programs. It is a powerful solution that performs consistently over time.

The HP UPD communicates directly with each HP product, gathers configuration information, and then customizes the user interface to show the product's unique, available features. It automatically enables features that are available for the product, such as two-sided printing, so you do not need to enable them manually.

For more information, go to www.hp.com/go/upd.

UPD installation modes

Traditional mode	<ul style="list-style-type: none">• Use this mode if you are installing the driver for a single computer. See www.hp.com/go/upd.• When installed in Traditional mode, UPD operates like a discrete printer driver. It operates with a specific product.• If you use this mode, you must install UPD separately for each computer and for each product.
Dynamic mode	<ul style="list-style-type: none">• To use this mode, download UPD from the Internet. See www.hp.com/go/upd.• Dynamic mode allows you to use a single driver installation, so you can discover and print to HP products in any location.• Use this mode if you are installing UPD for a workgroup or to have convenient access to a fleet of printers for individual users.

Change print job settings for Windows

Priority for print settings

Changes to print settings are prioritized depending on where the changes are made:



NOTE: The names of commands and dialog boxes might vary depending on your software program. In managed environments, administrators may enforce printing policies and restrictions.

- **Page Setup dialog box:** Click **Page Setup** or a similar command on the **File** menu of the program you are working in to open this dialog box. Settings changed here override settings changed anywhere else.
- **Print dialog box:** Click **Print**, **Print Setup**, or a similar command on the **File** menu of the program you are working in to open this dialog box. Settings changed in the **Print** dialog box have a lower priority and usually do not override changes made in the **Page Setup** dialog box.
- **Printer Properties dialog box (printer driver):** Click **Properties** in the **Print** dialog box to open the printer driver. Settings changed in the **Printer Properties** dialog box usually do not override settings anywhere else in the printing software, but will be applied if no conflicting command is sent with a print job. You can change most of the print settings here.
- **Default printer driver settings:** The default printer driver settings determine the settings used in all print jobs, *unless* settings are changed in the **Page Setup**, **Print**, or **Printer Properties** dialog boxes.
- **Printer control panel settings:** Settings changed at the printer control panel have a lower priority than changes made anywhere else.

Change the settings for all print jobs until the software program is closed

1. On the **File** menu in the software program, click **Print**.
2. Select the driver, and then click **Properties** or **Preferences**.

The steps can vary; this procedure is most common.

Change the default settings for all print jobs

1. **Windows XP, Windows Server 2003, and Windows Server 2008 (using the default Start menu view):** Click **Start**, and then click **Printers and Faxes**.

Windows XP, Windows Server 2003, and Windows Server 2008 (using the Classic Start menu view): Click **Start**, click **Settings**, and then click **Printers**.

Windows Vista: Click **Start**, click **Control Panel**, and then in the category for **Hardware and Sound** click **Printer**.

Windows 7: Click **Start**, and then click **Devices and Printers**.

2. Right-click the driver icon, and then select **Printing Preferences**.

Change the product configuration settings

1. **Windows XP, Windows Server 2003, and Windows Server 2008 (using the default Start menu view):** Click **Start**, and then click **Printers and Faxes**.

Windows XP, Windows Server 2003, and Windows Server 2008 (using the Classic Start menu view): Click **Start**, click **Settings**, and then click **Printers**.

Windows Vista: Click **Start**, click **Control Panel**, and then in the category for **Hardware and Sound** click **Printer**.

Windows 7: Click **Start**, and then click **Devices and Printers**.

2. Right-click the driver icon, and then select **Properties** or **Printer properties**.
3. Click the **Device Settings** tab.

Remove the printer driver from Windows

Windows XP

1. Click **Start, Control Panel**, and then **Add or Remove Programs**.
2. Find and select the product from the list.
3. Click the **Change/Remove** button to remove the software.

Windows Vista

1. Click **Start, Control Panel**, and then **Programs and Features**.
2. Find and select the product from the list.
3. Select the **Uninstall/Change** option.

Windows 7

1. Click **Start, Control Panel**, and then under the **Programs** heading, click **Uninstall a program**.
2. Find and select the product from the list.
3. Select the **Uninstall** option.

Supported utilities for Windows

- HP Web Jetadmin
- HP Embedded Web Server
- HP ePrint
- HP Wireless Direct

Other Windows components and utilities

- HP OfficeJet Scan
- HP Digital Fax
- HP Printer Assistant (available when the product software is installed from CD)

5 Use the product with Mac

- [Supported operating systems and printer drivers for Mac](#)
- [Software for Mac computers](#)
- [Priority for print settings for Mac](#)
- [Change printer-driver settings for Mac](#)
- [Remove the printer driver from Mac operating systems](#)
- [Supported utilities for Mac](#)
- [Fax with Mac](#)
- [Scan with Mac](#)
- [Solve problems with Mac](#)

Supported operating systems and printer drivers for Mac

The product supports the following Mac operating systems:

- Mac OS X 10.6 and later



NOTE: See www.hp.com/support for the latest drivers for Mac.



NOTE: For Mac OS X 10.6 and later, Intel Core Processor Macs are supported.

The HP Officejet software installer provides PostScript® Printer Description (PPD) files, Printer Dialog Extensions (PDEs), and the HP Utility for use with Mac OS X computers. The HP printer PPD and PDE files, in combination with the built-in Apple PostScript printer drivers, provide full printing functionality and access to specific HP printer features.

Software for Mac computers

HP Utility for Mac

Use the HP Utility to set up product features that are not available in the printer driver.

You can use the HP Utility when the product uses a universal serial bus (USB) cable or is connected to a TCP/IP-based network.

Open the HP Utility

Use any of the following methods to open the HP Utility:

- From the dock, click **HP Utility**.
- From **Applications**, open the Hewlett-Packard folder, and then click **HP Utility**.
- Click the **Utility** tab of the **Options and Supplies panel** from **Print and Fax**.

HP Utility features

Use the HP Utility software to perform the following tasks:

- Obtain information about supplies status.
- Obtain information about the product, such as the firmware version and the serial number.
- Print a configuration page.
- For products connected to an IP-based network, obtain network information and open the HP Embedded Web Server.
- Configure the paper type and size for the tray.
- Configure basic fax settings.

Priority for print settings for Mac

Changes to print settings are prioritized depending on where the changes are made:



NOTE: The names of commands and dialog boxes might vary depending on your software program.

- **Page Setup dialog box:** Click **Page Setup** or a similar command on the **File** menu of the program you are working in to open this dialog box. Settings changed here might override settings changed anywhere else.
- **Print dialog box:** Click **Print**, **Print Setup**, or a similar command on the **File** menu of the program you are working in to open this dialog box. Settings changed in the **Print** dialog box have a lower priority and do *not* override changes made in the **Page Setup** dialog box.
- **Default printer driver settings:** The default printer driver settings determine the settings used in all print jobs, *unless* settings are changed in the **Page Setup**, **Print**, or **Printer Properties** dialog boxes.
- **Printer control panel settings:** Settings changed at the printer control panel have a lower priority than changes made anywhere else.

Change printer-driver settings for Mac

Change the settings for all print jobs until the software program is closed

1. On the **File** menu, click the **Print** button.
2. Change the settings that you want on the various menus.

Change the default settings for all print jobs

1. On the **File** menu, click the **Print** button.
2. Change the settings that you want on the various menus.
3. On the **Presets** menu, click the **Save As...** option and type a name for the preset.

These settings are saved in the **Presets** menu. To use the new settings, you must select the saved preset option every time you open a program and print.

Change the product configuration settings

1. From the Apple menu , click the **System Preferences** menu and then click the **Print & Scan** icon.
2. Select the product in the left side of the window.
3. Click the **Options & Supplies** button.
4. Click the **Driver** tab.
5. Configure the installed options.

Remove the printer driver from Mac operating systems

You must have administrator rights to remove the software.

1. Open **System Preferences**.
2. Select **Print & Scan**.
3. Highlight the product.
4. Click the minus (-) symbol to delete the print queue.

Supported utilities for Mac

HP Embedded Web Server

The product is equipped with the HP Embedded Web server, which provides access to information about product and network activities. Access the HP Embedded Web Server from the HP Utility. Open the **Printer Settings** menu, and then select the **Additional Settings** option.

You can also access the HP Embedded Web Server by entering the product's IP address into Safari Web browser:

1. Select the page icon in the left side of the Safari toolbar.
2. Click the Bonjour logo.
3. In the list of printers, double-click this product. The HP Embedded Web Server opens.

To access the HP Embedded Web Server from other web browsers, type the product's IP address in the browser's address field.

The HP Embedded Web Server can also be accessed through the **System Preferences** menu. Click **System Preferences**, click **Print and Scan**, select your product name, click **Options and Supplies**, click **General**, and then click **Show Printer Webpage**.

Fax with Mac

To send a fax by printing to a fax driver, complete the following steps:

1. Open the document that you want to fax.
2. Click **File** and then click **Print**.
3. In the **Printer** pop-up menu, select the fax print queue that you want to use.
4. In the **Copies** field, adjust the number of copies if necessary.
5. In the **Paper Size** pop-up menu, adjust the paper size if necessary.
6. In the **Fax Information** area, enter the fax number of one or more recipients. Other Fax Options may also be available, including **Preview**, **Color** or **Black & White**, **Layout**, **Paper Handling**, and **Scheduler** settings.



NOTE: If you need to include a dialing prefix, enter it in the **Dialing Prefix** field.

7. Click **Fax**.

Scan with Mac

Use the HP Scan software to scan images to a Mac computer.

If you have installed an HP driver for your product that supports scanning, use the following steps to scan:

1. Load the document onto the scanner glass or into the document feeder.
2. Open the **Applications** folder, and then click **Hewlett-Packard**. Select **HP Scan**.
3. Open the **HP Scan** menu and click **Preferences**. From the **Scanner** pop-up menu, select this product from the list.
4. To use the standard preset settings, which produce acceptable results for images and text, click the **Continue** button.

To use presets optimized for pictures or text documents, select a preset from the **Scanning Presets** pop-up menu. When you are ready to scan, click the **Continue** button.

5. To scan more pages, load the next page and click the **+** button. Adjust scanner and presets as needed, and then click the **Continue** button. If using the flatbed scanner, you are prompted to **Scan Next Item** when the scan is complete. Repeat until you have scanned all the pages. Use the **-** button to delete unwanted scanned items.
6. Click the **Send** button, and then browse to the folder on your computer where you want to save the file, or choose a printer to print the scanned items.

 **NOTE:** Use Edit tools to modify scanned items. To modify all scanned items at once, use the **Batch** menu.

Scan using Apple Preview and Image Capture applications (Mac OS X v10.6 and later)

Use the Apple Preview or Image Capture applications with Mac OS X v10.6 and later to scan during any of the following conditions:

- You recently upgraded to Mac OS X v10.6 or later and cannot access the HP Scan application.
- A full feature driver update is not available for your product, or your product released before the HP drivers that support scanning for your product.
- You have not yet installed the available HP software that includes scanning.
- You are troubleshooting a scanning problem and trying to identify the source of the problem.

Scan using Apple Preview

1. Click the Apple Preview icon in the dock, or open Preview from the Applications folder.
2. From the **Preview File** menu, select the **Import from Scanner** option.

 **NOTE:** If your product connects to a network, select the **Include Networked Devices** option, and then select the **Import from Scanner** option from the **Preview File** menu to display your networked product in the list.

3. Select your product from the list. The scan interface opens.

 **NOTE:** You can click the **Show Details** button to view settings and options.

Scan using Image Capture

1. Click the Apple Image Capture icon in the dock, or open Image Capture from the Applications folder.
2. Select your product from the list, or if your product connects to a network, select it from the **Shared** list. The scan interface opens.

 **NOTE:** You can click the **Show Details** button to view settings and options.

Solve problems with Mac

For information about solving problems with a Mac, see [Solve product software problems with Mac on page 258](#).

6 Paper and print media

- [Understand paper use](#)
- [Change the printer driver to match the paper type and size in Windows](#)
- [Supported paper sizes](#)
- [Supported paper types and tray capacity](#)
- [Load paper trays](#)
- [Configure trays](#)

Understand paper use

HP Officejet inks for business are specifically developed for use with HP printheads. Unique ink formulations help extend the life of the printheads and enhance reliability. When used with ColorLok® paper, these inks provide laser-like color output that dries quickly and is ready for distribution.

This product supports a variety of paper and other print media. Paper or print media that does not meet the following guidelines might cause poor print quality, increased jams, and premature wear on the product.

It is possible for paper to meet all of these guidelines and still not produce satisfactory results. This might be the result of improper handling, unacceptable temperature and/or humidity levels, or other variables over which Hewlett-Packard has no control.

CAUTION: Using paper or print media that does not meet Hewlett-Packard's specifications might cause problems for the product, requiring repair. This repair is not covered by the Hewlett-Packard warranty or service agreements.

- For best results, use only HP-brand paper and print media designed for inkjet printers or multiuse.
- Use paper or print media made for inkjet printers.
- Hewlett-Packard Company cannot recommend the use of other brands of media because HP cannot control their quality.

NOTE: Based on HP internal testing using a range of plain papers, HP highly recommends using papers with the ColorLok® logo for this product. For details, go to www.hp.com/go/printpermanence.



Use the following guidelines to obtain satisfactory results when using special paper or print media. Set the paper type and size in the printer driver to obtain the best results.

Media type	Do	Do not
Envelopes	<ul style="list-style-type: none">• Store envelopes flat.• Use envelopes where the seam extends all the way to the corner of the envelope.	<ul style="list-style-type: none">• Do not use envelopes that are wrinkled, nicked, stuck together, or otherwise damaged.• Do not use envelopes that have clasps, snaps, windows, or coated linings.
Labels	<ul style="list-style-type: none">• Use only labels that have no exposed backing between them.• Use labels that lie flat.• Use only full sheets of labels.	<ul style="list-style-type: none">• Do not use labels that have wrinkles or bubbles, or are damaged.• Do not print partial sheets of labels.

Media type	Do	Do not
Letterhead or preprinted forms	<ul style="list-style-type: none"> • Use only letterhead or forms approved for use in inkjet printers. 	<ul style="list-style-type: none"> • Do not use raised or metallic letterhead.
Heavy paper	<ul style="list-style-type: none"> • Use only heavy paper that is approved for use in inkjet printers and meets the weight specifications for this product. 	<ul style="list-style-type: none"> • Do not use paper that is heavier than the recommended media specification for this product unless it is HP paper that has been approved for use in this product.
Glossy or coated paper	<ul style="list-style-type: none"> • Use only glossy or coated paper that is approved for use in inkjet printers. 	<ul style="list-style-type: none"> • Do not use glossy or coated paper designed for use in laser products.

Change the printer driver to match the paper type and size in Windows

1. On the **File** menu in the software program, click **Print**.
2. Select the product, and then click the **Properties** or **Preferences** button.
3. Click the **Paper/Quality** tab.
4. Select a size from the **Paper size** drop-down list.
5. Select a paper type from the **Paper type** drop-down list.
6. Click the **OK** button.

Supported paper sizes

 **NOTE:** To obtain best print results, select the appropriate paper size and type in your print driver before printing.

Table 6-1 Supported paper and print media sizes

Size	Dimensions	Tray 1	Tray 2	Tray 3	Automatic duplex printing
Letter	216 x 279 mm (8.5 x 11 inches)	✓	✓	✓	✓
Oficio 8.5 x 13	(8.5 x 13 inches)	✓		✓	✓
Oficio 216x340 mm	216 x 340 mm	✓		✓	✓
Legal	216 x 356 mm (8.5 x 14 inches)	✓		✓	✓
A4	210 x 297 mm (8.3 x 11.7 inches)	✓	✓	✓	✓
Executive	184 x 267 mm (7.25 x 10.5 inches)	✓	✓	✓	✓
Statement	140 by 216 mm (5.5 x 8.5 inches)	✓	✓	✓	
A5	148 x 210 mm (5.8 x 8.3 inches)	✓	✓	✓	
A6	105 x 148.5 mm (4.13 x 5.83 inches)	✓			
B5 (JIS)	182 x 257 mm (7.17 x 10.12 inches)	✓	✓	✓	✓
B6 (JIS)	128x182mm (5 x 7 inches)	✓			
16k	184 x 260 mm (7.24 x 10.23 inches)				
	195 x 270 mm (7.68 x 10.62 inches)	✓	✓	✓	
	197 x 273 mm (7.75 x 10.75 inches)				
Custom	Minimum: (3 x 5 inches)	Width: (3 to 8.5 inches)	Width: (4 to 8.5 inches)	Width: (4 to 8.5 inches)	
	Maximum: (8.5 to 14 inches)	Length: (5 to 14 inches)	Length: (8.27 to 11.7 inches)	Length: (8.27 to 14 inches)	

Table 6-2 Supported envelopes

Size	Dimensions	Tray 1	Tray 2	Tray 3	Automatic duplex printing
Envelope #10	105 x 241 mm (4.13 x 9.49 inches)	✓	✓		
Envelope DL	110 x 220 mm (4.33 x 8.66 inches)	✓	✓		
Envelope C5	162 x 229 mm (6.4 x 9 inches)	✓	✓		
Envelope B5	176 x 250 mm (6.7 x 9.8 inches)	✓	✓		
Envelope C6	114 x 162 mm (4.5 x 6.4 inches)	✓			
Envelope Monarch	98 x 191 mm (3.9 x 7.5 inches)	✓			
Japanese Envelope Chou #3	120 x 235 mm (4.7 x 9.3 inches)	✓	✓		
Japanese Envelope Chou #4	90 x 205 mm (3.5 x 8.1 inches)	✓			

Table 6-3 Supported cards

Size	Dimensions	Tray 1	Tray 2	Tray 3	Automatic duplex printing
3x5	(76.2 x 127 mm) (3 x 5 inches)	✓			
4x6	(102 x 152 mm) (4 x 6 inches)	✓			
5x8	(127 x 203 mm) (5 x 8 inches)	✓			
A6	(105 x 148.5 mm) (4.13 x 5.83 inches)	✓			
Japanese Postcard	(100 x 148 mm) (3.9 x 5.8 inches)	✓			
Double Japan Postcard Rotated	(148 x 200 mm) (5.8 x 7.9 inches)	✓			

Table 6-4 Supported photo media

Size	Dimensions	Tray 1	Tray 2	Tray 3	Automatic duplex printing
4x6	(102 x 152 mm) (4 x 6 inches)	✓			

Table 6-4 Supported photo media (continued)

Size	Dimensions	Tray 1	Tray 2	Tray 3	Automatic duplex printing
10x15cm	(100 x 150 mm) (3.9 x 5.9 inches)	✓			
L	(89 x 127 mm) (3.5 x 5 inches)	✓			
5x7 Photo Media (5 x 7 in no-tabs)	(127 x 178 mm) (5 x 7 inches)	✓			
Photo Media (Letter & A4)		✓	✓	✓	
Japanese Postcard	(100 x 148 mm) (3.9 x 5.8 inches)	✓			
Custom	Minimum: (3 to 5 inches) Maximum: (8.5 to 14 inches)	Width: (3 to 8.5 inches) Length: (5 to 14 inches)	Width: (4 to 8.5 inches) Length: (8.27 to 11.7 inches)	Width: (4 to 8.5 inches) Length: (8.27 to 14 inches)	

Table 6-5 Other supported media

Size	Dimensions	Tray 1	Tray 2	Tray 3	Automatic duplex printing
Labels (Letter and A4)		✓	✓	✓	

Supported paper types and tray capacity

Table 6-6 Tray 1 (multi-purpose) on left side of the product

Paper type	Weight	Capacity ¹	Paper orientation
Every day:	60 to 175 g/m ² (16 to 47 lb)	Up to 50 sheets	Side to be printed on face-down, with the top edge at the front of the tray
<ul style="list-style-type: none"> Unspecified and Plain HP EcoSMART Lite Light 60-74g Intermediate 85-95g Mid-Weight 96-110g Heavy 111-130g HP Premium Presentation Matte 120g Extra Heavy 131-175g 			
<ul style="list-style-type: none"> HP Brochure Matte 180g HP Brochure Glossy 180g Cardstock 176-220g HP Cover Matte 200g HP Advanced Photo Papers 	Up to 220 g/m ² (58 lb) ¹	Up to 25 sheets	Side to be printed on face-down, with the top edge at the back of the tray
<ul style="list-style-type: none"> Envelope Heavy Envelope Labels 		Up to 7 envelopes or labels	Side to be printed on face-down, with the top edge toward the product

¹ Capacity can vary depending on paper weight and thickness, and environmental conditions.

Table 6-7 Tray 2 (main tray) and Tray 3 (accessory tray)

Paper type	Weight	Capacity ¹	Paper orientation
<ul style="list-style-type: none"> Unspecified and Plain HP EcoSMART Lite Light 60-74g Intermediate 85-95g Mid-Weight 96-110g Heavy 111-130g HP Premium Presentation Matte 120g Extra Heavy 131-175g 	60 to 175 g/m ² (16 to 47 lb)	Up to 500 sheets	Side to be printed on face-up, with the top edge at the front of the tray
<ul style="list-style-type: none"> HP Brochure Matte 180g HP Brochure Glossy 180g Cardstock 176-220g HP Cover Matte 200g HP Advanced Photo Papers 	Up to 220 g/m ² (58 lb) ¹	Up to 100 sheets	Side to be printed on face-up, with the top edge at the back of the tray
<ul style="list-style-type: none"> Envelope Heavy Envelope Labels 		Up to 30 envelopes or labels. NOTE: Tray 3 does not support envelope printing.	Side to be printed on face-up, with the top edge toward the product

¹ Capacity can vary depending on paper weight and thickness, and environmental conditions.

Load paper trays

Load Tray 1 (multi-purpose tray on left side of the product)

1. Open Tray 1.

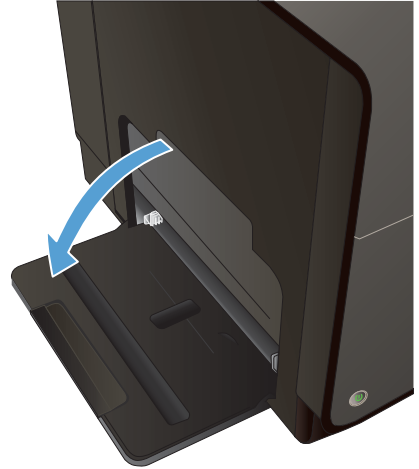

2. Pull out the extension tray.



3. Extend the paper guides fully and then load the paper stack into Tray 1. Adjust the paper guides to the size of the paper.

NOTE: Place the paper into Tray 1 with the side to be printed on face-down and top of page toward the front of the tray.



Load Tray 2 or optional Tray 3

1. Pull the tray out of the product.

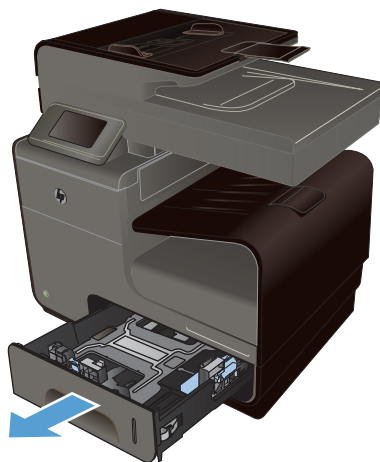

2. Slide open the paper length and width guides.

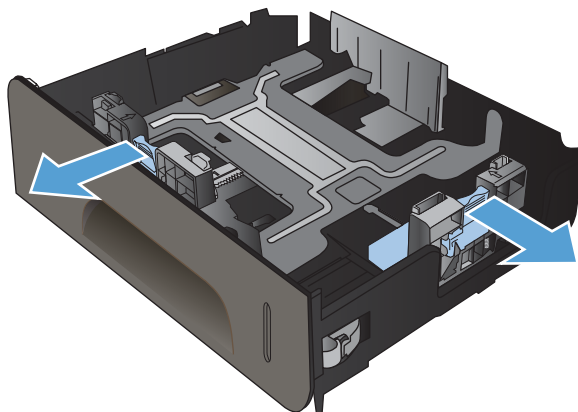

3. Place the paper in the tray and make sure that it is flat at all four corners. Slide the side paper width guides so that they align with the paper-size marking in the bottom of the tray. Slide the front paper length guide so that it pushes the stack of paper against the back of the tray.

NOTE: Place the paper into the tray with the side to be printed on face-up.

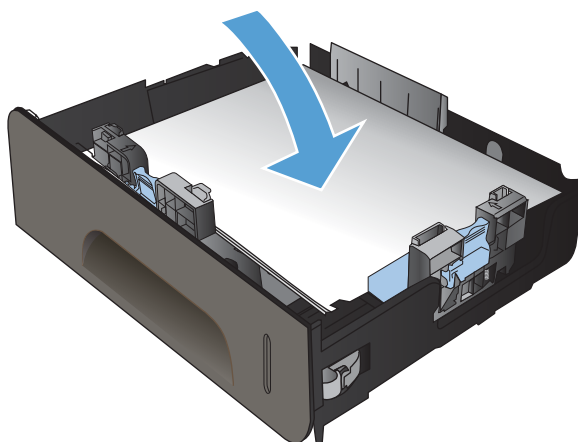

4. Push down on the paper to make sure that the paper stack is below the paper limit tabs on the side of the tray.

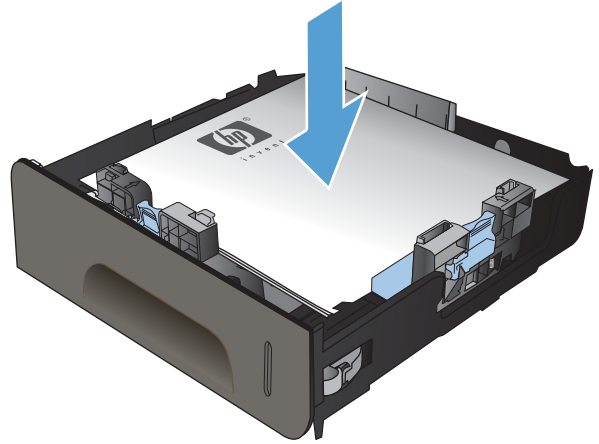

5. Slide the tray into the product.



Load the document feeder

The document feeder holds up to 50 sheets of 75 g/m² (20 lb bond) paper.

⚠ CAUTION: To prevent damage to the product, do not load an original document that contains correction tape, correction fluid, paper clips, or staples. Also, do not load photographs, small originals, or fragile originals into the document feeder.

1. Insert the originals into the document feeder face-up.



2. Adjust the guides until they are snug against the paper.



Configure trays

By default, the product pulls paper from Tray 2. If Tray 2 is empty, the product pulls paper from Tray 1, or Tray 3 if it is installed. Configuring a tray on this product changes the speed settings to obtain the best print quality for the type of paper that you are using. If you are using special paper for all or most print jobs on the product, change this default tray setting on the product.

The following table lists possible ways you can use the tray settings to meet your printing needs.

Paper use	Configure the product	Print
Load Tray 1 and one other tray with the same paper, and have the product pick paper from one tray if the other one is empty.	Load paper in Tray 1. No configuration is needed, if the default settings for type and size have not been changed.	From the software program, print the job.
Occasionally use special paper, such as heavy paper or letterhead, from a tray that usually contains plain paper.	Load special paper in Tray 1.	From the software program print dialog, choose the paper type that matches the special paper loaded in the tray before sending the print job. Select Tray 1 as the Paper Source from the Paper/Quality tab (Windows) or Paper Feed menu (Mac).
Frequently use special paper, such as heavy paper or letterhead, from one tray.	Load special paper in Tray 1, and configure the tray for the paper type.	From the software program print dialog, choose the paper type that matches the special paper loaded in the tray before sending the print job. Select Tray 1 as the Paper Source from the Paper/Quality tab (Windows) or Paper Feed menu (Mac).

Configure trays

1. Make sure the product is turned on.
2. Perform one of the following tasks:
 - **Control panel:** Touch the **Setup**  button, touch **Paper Handling**, and then touch **Paper Selection**. Select the tray that you want to configure.
 - **Embedded Web server:** Click the **Settings** tab, and then click **Paper Settings** in the left panel. Select a **Default Media Size** and a **Default Media Type** for each tray.
3. Press **OK** or click **Apply**.

7 Ink cartridges

The information contained herein is subject to change without notice. For the latest User Guide information go to www.hp.com/support.

- [Ink cartridge information](#)
- [Supplies views](#)
- [Manage ink cartridges](#)
- [Replacement instructions](#)
- [Solve issues with supplies](#)

Ink cartridge information

Color	Cartridge number	Part number
Standard-capacity replacement black ink cartridge	HP 970	CN621A
High-capacity replacement black ink cartridge	HP 970XL	CN625A
Standard-capacity replacement cyan ink cartridge	HP 971	CN622A
High-capacity replacement cyan ink cartridge	HP 971XL	CN626A
Standard-capacity replacement yellow ink cartridge	HP 971	CN624A
High-capacity replacement yellow ink cartridge	HP 971XL	CN628A
Standard-capacity replacement magenta ink cartridge	HP 971	CN623A
High-capacity replacement magenta ink cartridge	HP 971XL	CN627A

Accessibility: The ink cartridge can be installed and removed by using one hand.

Environmental features: Recycle ink cartridges by using the HP Planet Partners return and recycling program.

For more information about supplies, go to www.hp.com/go/learnaboutsupplies.

Supplies views

Ink cartridge view



-
- | | |
|---|---|
| 1 | Metal connector and ink nozzle. Do not touch. Fingerprints may cause supply error messages. Dust may also cause supply error messages; do not leave ink cartridges outside the product for prolonged periods of time. |
|---|---|
-

Manage ink cartridges

Correctly using, storing, and monitoring the ink cartridge can help ensure high-quality print output.

Change settings for ink cartridges

Print when an ink cartridge is at estimated end of life

Supply-related notifications are communicated on the product control panel.

- A **<Supply> Low** message—where <Supply> is the cartridge—appears when an ink cartridge is nearing the estimated end of its useful life. Printing can continue, but consider having a replacement supply on hand.
- A **<Supply> Very Low** message appears when the ink cartridge is near its estimated end of useful life. Have a replacement ink cartridge on hand.
- **<Supply> Out of Ink** message appears when the ink cartridge is empty.

 **NOTE:** Although using the [Continue](#) setting allows printing beyond Very Low without replacing the cartridge, the product will shut down before any print problems occur.

Modify the Low on Ink Warning Level settings from the control panel

You can enable or disable the default settings at any time, and you do not have to re-enable them when you install a new ink cartridge.

1. From the Home screen on the control panel, touch the [Setup](#)  button.
2. Touch the [Device Setup](#) menu item.
3. Touch the [Ink Low Warning Level](#) item.
4. Select from the following options:
 - Select [Automatic](#) to keep the default low ink warning.
 - Select [Custom](#) to choose what ink level prompts a low ink level warning.

Print with General Office mode

General Office print mode uses less ink, which might extend the life of the cartridge.

1. On the **File** menu in the software program, click **Print**.
2. Select the product, and then click the **Properties** or **Preferences** button.
3. Click the **Paper/Quality** tab.
4. Select **General Office** from the **Print Quality** drop-down box.

Store and recycle supplies

Recycle supplies

Go to hp.com/recycle for full information on recycling, and to order postage-paid labels, envelopes, and boxes for recycling.

Ink cartridge storage

Do not remove the ink cartridge from its package until you are ready to use it.

HP policy on non-HP ink cartridges

Hewlett-Packard Company cannot recommend the use of non-HP ink cartridges, either new or remanufactured.

 **NOTE:** Any damage caused by a non-HP print cartridge is not covered under the HP warranty and service agreements.

HP anticounterfeit website

Go to www.hp.com/go/anticounterfeit when you install an HP print cartridge and the control-panel message says the cartridge is used or counterfeit. HP will help to take steps to resolve the problem.

Your ink cartridge might not be a genuine HP ink cartridge if you notice the following:

- The supplies status page indicates that a used or counterfeit supply is installed.
- You are experiencing a high number of problems with the ink cartridge.
- The cartridge does not look like it usually does (for example, the packaging differs from HP packaging).

Replacement instructions

Replace the ink cartridges

The product uses four colors and has a different ink cartridge for each color: yellow (Y), cyan (C), magenta (M), and black (K).

1. Open the ink cartridge door.

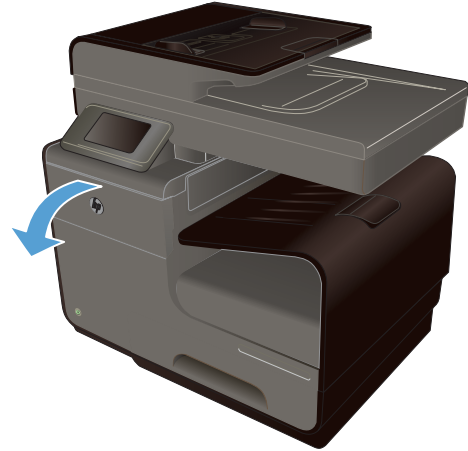

2. Push the old ink cartridge inward to unlock it.

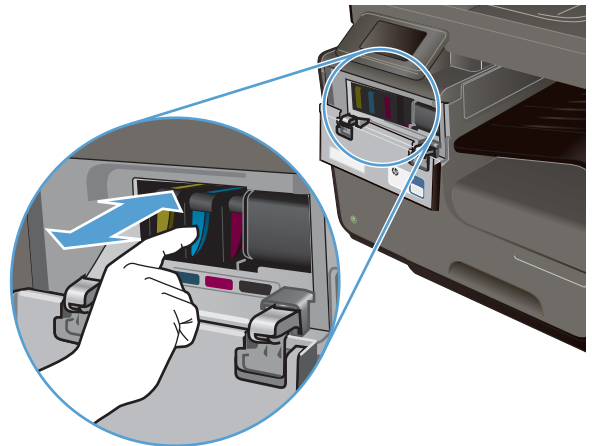

3. Grasp the edge of the old ink cartridge and then pull the cartridge straight out to remove it.

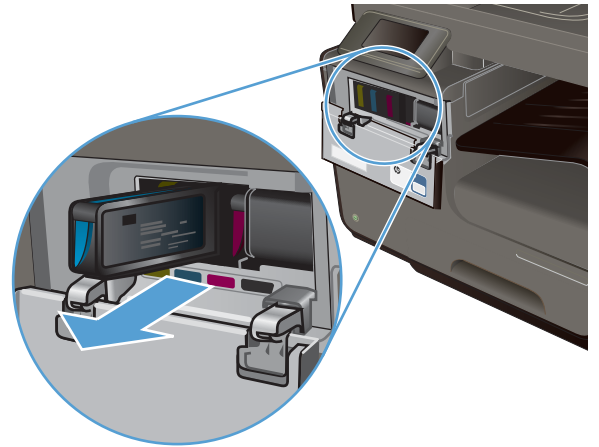

4. Remove the new ink cartridge from the packaging.

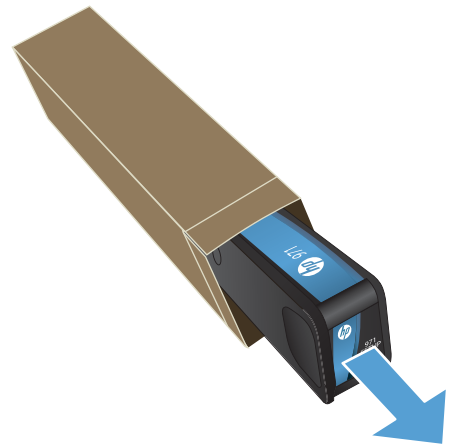

5. Do not touch the metal connector of the ink cartridge. Fingerprints on the connector can cause print-quality problems.



6. Insert the new ink cartridge into the product.

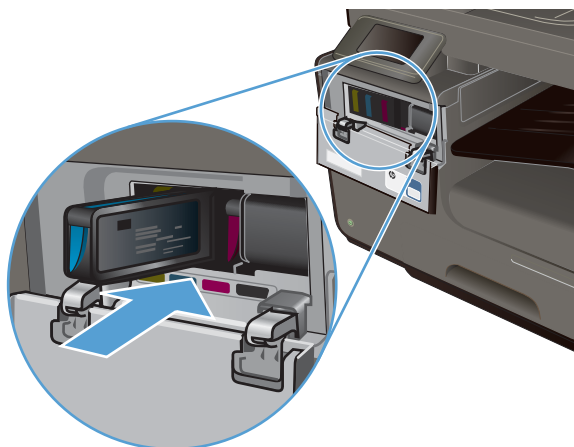

7. Close the ink cartridge door.



8. Place the old ink cartridge in the box and refer to HP's recycling instructions at <http://www.hp.com/recycle>.

Solve issues with supplies

Check the ink cartridges

If you are experiencing print quality problems, see [Improve print quality on page 236](#).

 **NOTE:** If you are using a General Office print setting, the printing might appear light.

If you determine that you need to replace an ink cartridge, look on the cartridge or print the Supplies Status Page to find the part number for the correct genuine HP ink cartridge.

Refilled or remanufactured ink cartridges

Hewlett-Packard Company cannot recommend the use of non-HP supplies, either new or remanufactured. Because they are not HP products, HP cannot influence their design or control their quality. If you are using a refilled or remanufactured ink cartridge and are not satisfied with the print quality, replace the cartridge with a genuine HP cartridge.

 **NOTE:** If you replace a non-HP ink cartridge with a genuine HP ink cartridge, the printhead may still contain non-HP ink until the printhead is depleted of that ink and is supplied with ink from the newly installed, genuine HP ink cartridge.

Interpret the Print Quality Page

1. On the control panel, touch the [Setup](#)  button.
2. Touch the [Print Reports](#) menu.
3. Select the [Print Quality Report](#) item to print it.
4. Follow the instructions on the page that prints.

This page contains four bands of color, which are divided into the groups as indicated in the following illustration. By examining each group, you can isolate the problem to a particular ink cartridge.

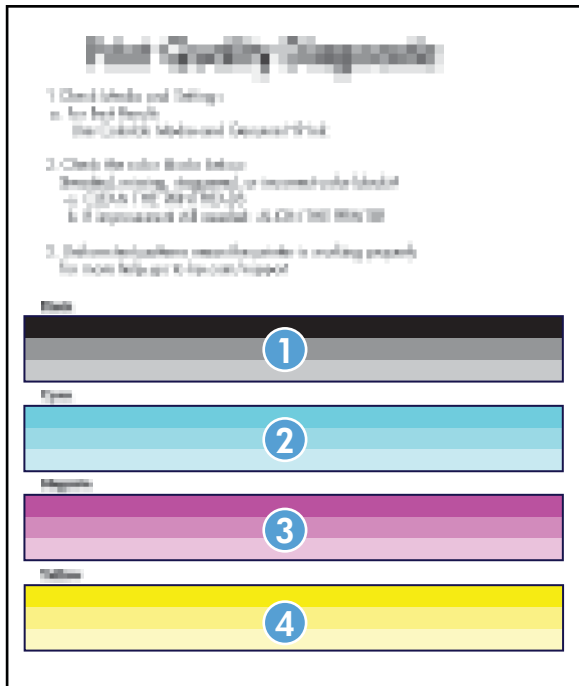

Section	Ink cartridge
1	Black
2	Cyan
3	Magenta
4	Yellow

- If dots or streaks appear in one or more groups, clean the printhead. If this does not solve the problem, contact HP.
- If streaks appear in multiple color bands, see if the problem still persists by performing an additional print head cleaning, and then contact HP. A component other than the ink cartridge is probably causing the problem.

Interpret control panel messages for supplies

Use SETUP cartridges

Description

The SETUP cartridges have been removed before the product has completed initialization.

Recommended action

Use the SETUP cartridges that came with your product for product initialization.

Do not use SETUP cartridges

Description

SETUP cartridges cannot be used after the device has been initialized.

Recommended action

Remove and install non-SETUP cartridges.

<Color>Cartridge Low

Description

The ink cartridge is nearing the end of its useful life.

Recommended action

Printing can continue, but consider having a replacement supply on hand.

<Color>Cartridge Very Low

Description

The ink cartridge is near the end of its useful life.

Recommended action

Have a replacement ink cartridge on hand.

Counterfeit or used <color> cartridge installed

Description

The original HP ink in this cartridge has been depleted.

Recommended action

Click OK to continue printing or replace with genuine HP cartridge.

Genuine HP supply installed

Description

A genuine HP supply was installed.

Recommended action

No action necessary.

Incompatible <color>

Description

You have installed an ink cartridge that is intended for use in a different HP product model. The product will NOT function with this print cartridge installed.

Recommended action

Install the correct ink cartridge for this product.

Install [color] cartridge

Description

This message can appear during the initial set up of the product and may also appear after the initial set up of the product has been completed.

If this message appears during initial setup, it means one of the color cartridges is not installed with the door closed. The product will not print if a cartridge is missing.

If this message appears after the initial set up of the product, it means that the cartridge is missing or is installed but damaged.

Recommended action

Install or replace the indicated color cartridge.

Non-HP ink cartridges installed

Description

No action necessary, this is a notification only.

Recommended action

No action necessary, this is a notification only.

Out of Ink <Color>

Description

The ink cartridge is at the end of its useful life, and the product will no longer print.

Recommended action

Replace the ink cartridge.

Used [color] installed**Description**

A used, but still genuine, HP color ink cartridge has been installed or moved.

Recommended action

You have a used, but still genuine, HP cartridge installed. No action required.

8 Print

- [Print tasks \(Windows\)](#)
- [Print tasks \(Mac\)](#)
- [Additional print tasks \(Windows\)](#)
- [Additional print tasks \(Mac OS X\)](#)
- [Use HP ePrint](#)
- [Use the HP ePrint Mobile Driver](#)
- [AirPrint](#)
- [Connect the printer with HP Wireless Direct](#)
- [Plug and Print USB Drive printing](#)

Print tasks (Windows)

The methods to open the print dialog from software programs can vary. The procedures that follow include a typical method. Some software programs do not have a **File** menu. See the documentation for your software program to learn how to open the print dialog.

Open the printer driver with Windows

1. On the **File** menu in the software program, click **Print**.
2. Select the product, and then click the **Properties** or **Preferences** button.

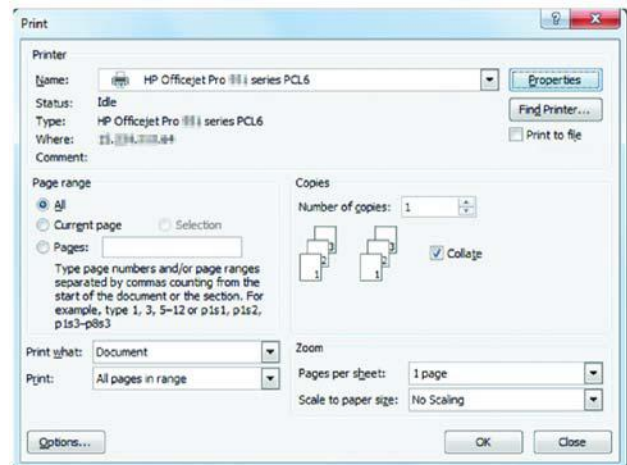

Get help for any printing option with Windows

1. Click the **Help** button to open the online Help.

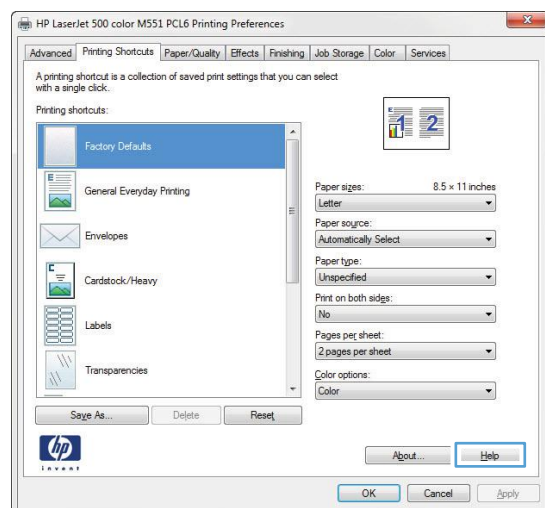

Change the number of print copies with Windows

1. On the **File** menu in the software program, click **Print**.
2. Select the product, and then select the number of copies.

Save custom print settings for reuse with Windows

Use a printing shortcut with Windows

1. On the **File** menu in the software program, click **Print**.
2. Select the product, and then click the **Properties** or **Preferences** button.

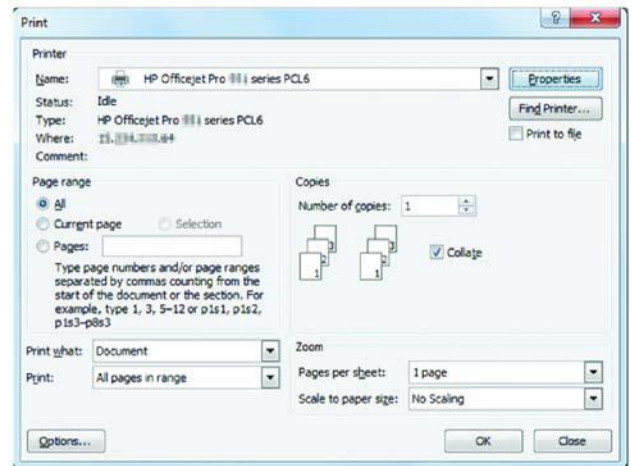

3. Click the **Printing Shortcuts** tab.

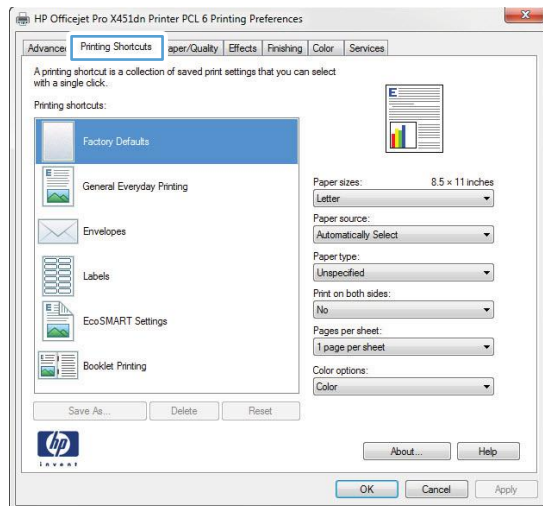

4. Select one of the shortcuts, and then click the **OK** button.

NOTE: When you select a shortcut, the corresponding settings change on the other tabs in the printer driver.

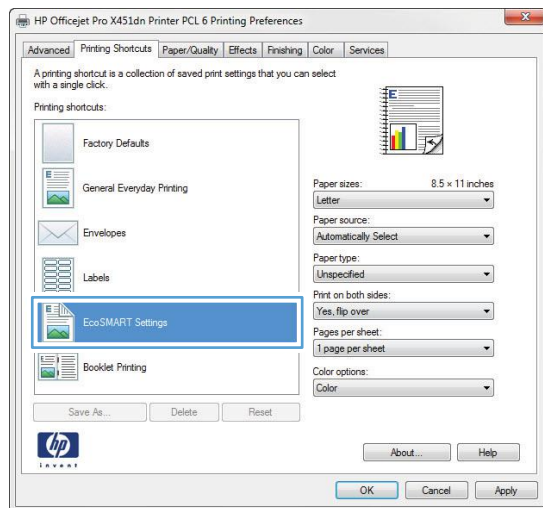

Create printing shortcuts

1. On the **File** menu in the software program, click **Print**.

2. Select the product, and then click the **Properties** or **Preferences** button.

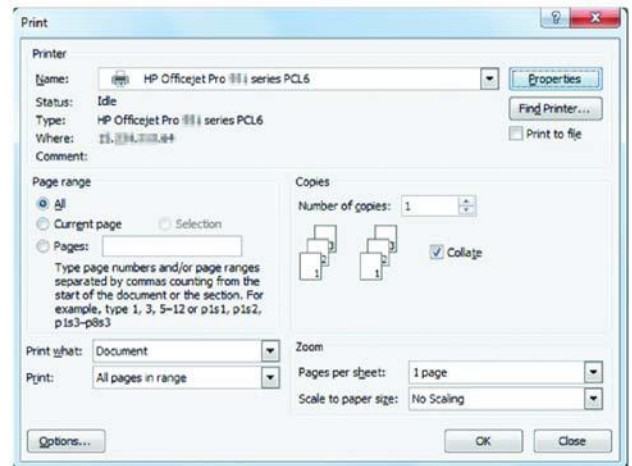

3. Click the **Printing Shortcuts** tab.

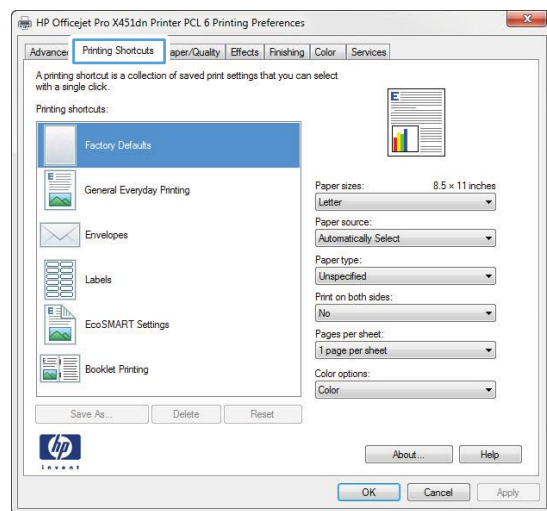

4. Select an existing shortcut as a base.

NOTE: Always select a shortcut before adjusting any of the settings on the right side of the screen. If you adjust the settings and then select a shortcut, all your adjustments are lost.

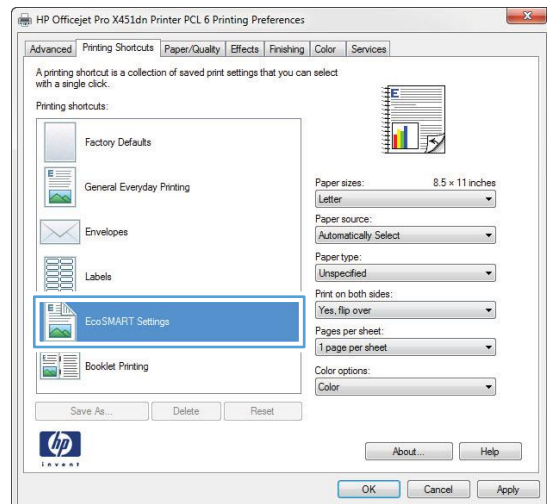

5. Select the print options for the new shortcut.

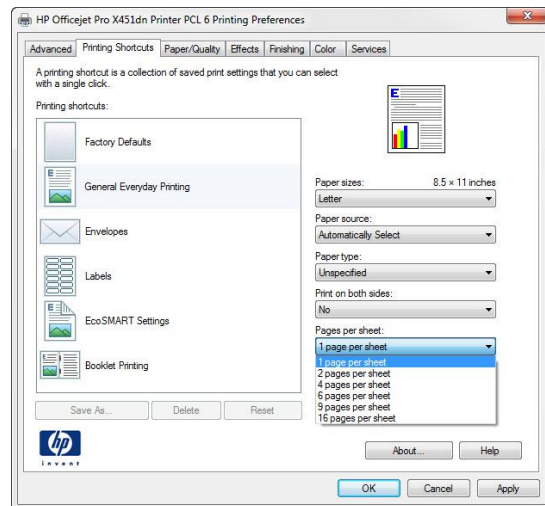

6. Click the **Save As** button.

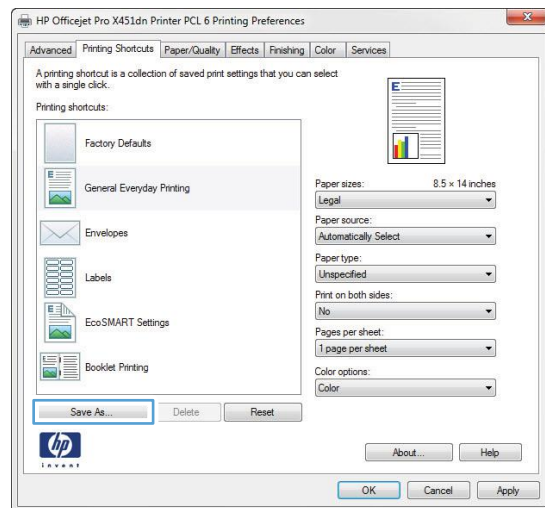

7. Type a name for the shortcut, and click the **OK** button.

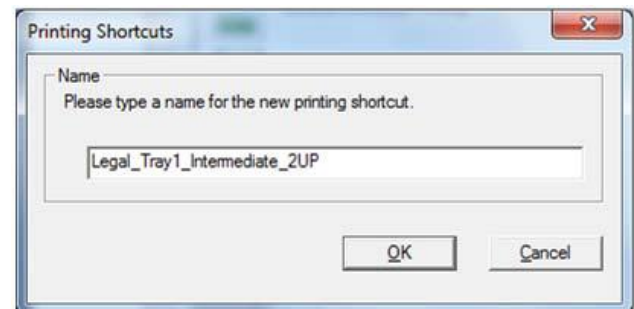

Improve print quality with Windows

Select the page size with Windows

1. On the **File** menu in the software program, click **Print**.
2. Select the product, and then click the **Properties** or **Preferences** button.

3. Click the **Paper/Quality** tab.
4. Select a size from the **Paper size** drop-down list.

Select a custom page size with Windows

1. On the **File** menu in the software program, click **Print**.
2. Select the product, and then click the **Properties** or **Preferences** button.
3. Click the **Paper/Quality** tab.
4. Click the **Custom** button.
5. Type a name for the custom size and specify the dimensions.
 - The width is the short edge of the paper.
 - The length is the long edge of the paper.



NOTE: Always load paper into the trays short edge first.

6. Click the **OK** button, and then click the **OK** button on the **Paper/Quality** tab. The custom page size will appear in the list of paper sizes the next time you open the printer driver.

Select the paper type with Windows

1. On the **File** menu in the software program, click **Print**.
2. Select the product, and then click the **Properties** or **Preferences** button.
3. Click the **Paper/Quality** tab.
4. From the **Paper type** drop-down list, click the **More...** option.
5. Expand the list of **Type is:** options.
6. Expand the category of paper types that best describes your paper, and then click the paper type that you are using.

Select the paper tray with Windows

1. On the **File** menu in the software program, click **Print**.
2. Select the product, and then click the **Properties** or **Preferences** button.
3. Click the **Paper/Quality** tab.
4. Select a tray from the **Paper source** drop-down list.

Print on both sides (duplex) with Windows

Automatically print on both sides with Windows

1. On the **File** menu in the software program, click **Print**.
2. Select the product, and then click the **Properties** or **Preferences** button.

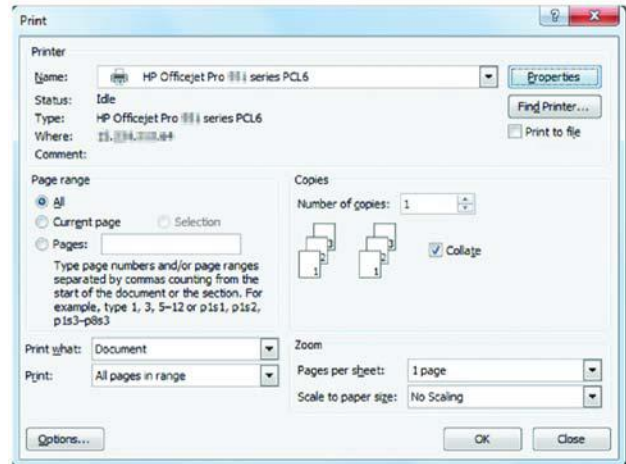

3. Click the **Finishing** tab.

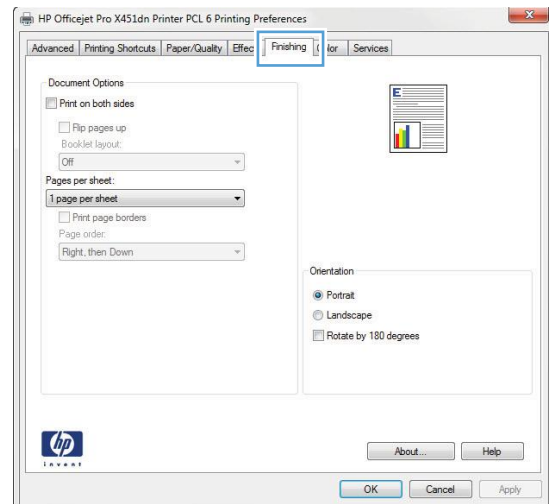

4. Select the **Print on both sides** check box. Click the **OK** button to print the job.

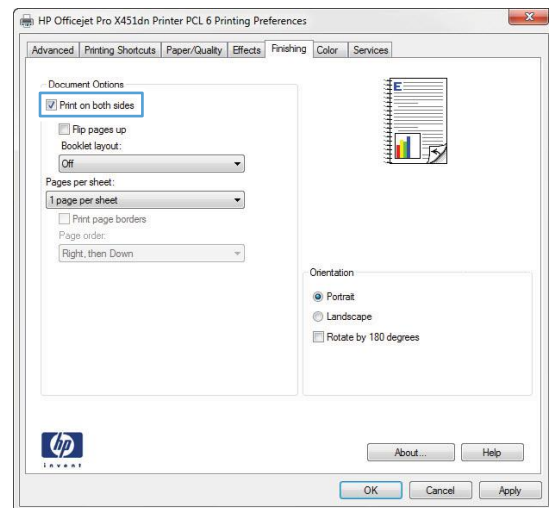

Print multiple pages per sheet with Windows

1. On the **File** menu in the software program, click **Print**.

2. Select the product, and then click the **Properties** or **Preferences** button.

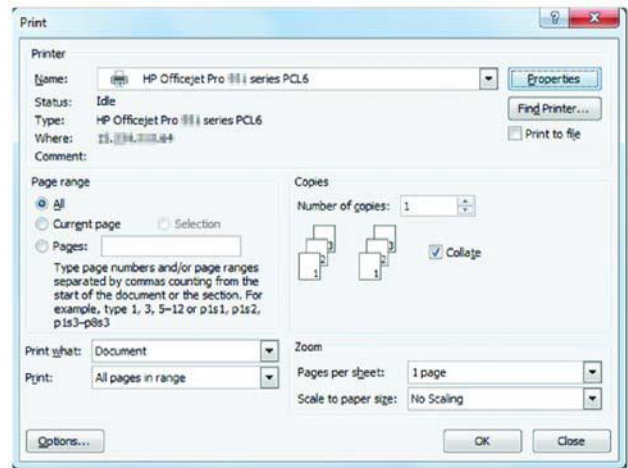

3. Click the **Finishing** tab.

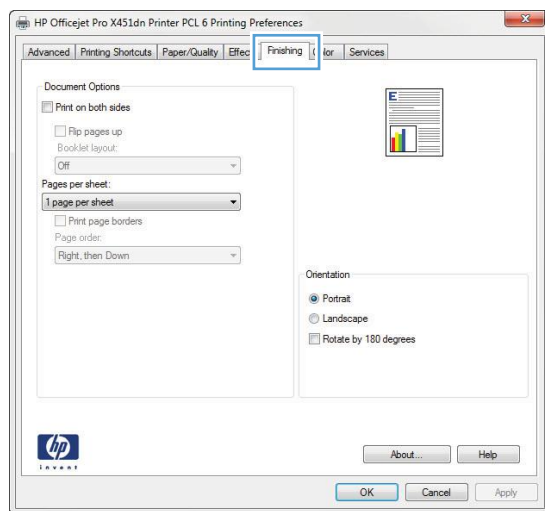

4. Select the number of pages per sheet from the **Pages per sheet** drop-down list.

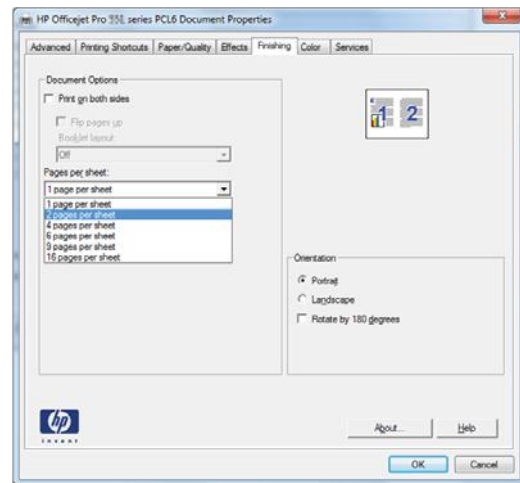

5. Select the correct **Print page borders**, **Page order**, and **Orientation** options.

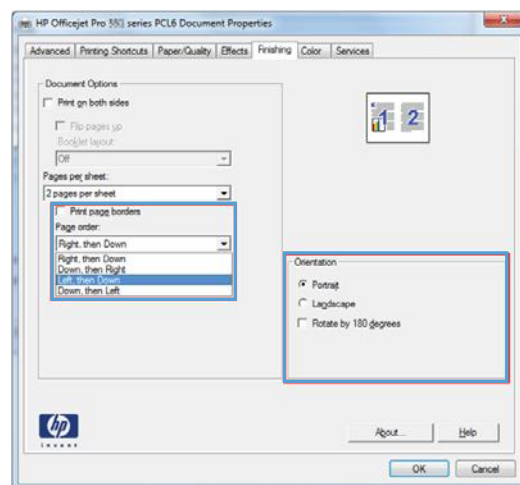

Select page orientation with Windows

1. On the **File** menu in the software program, click **Print**.
2. Select the product, and then click the **Properties** or **Preferences** button.

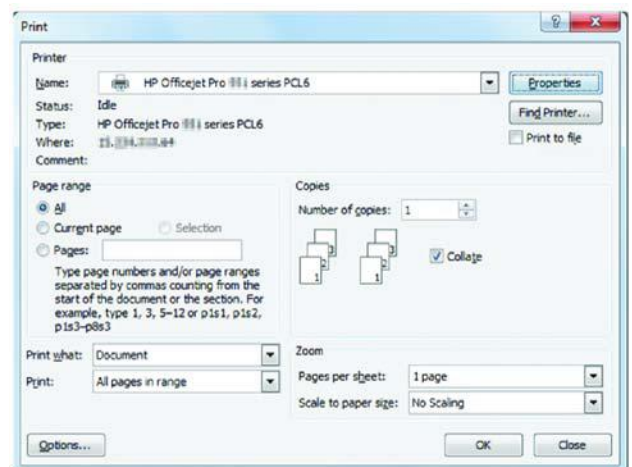

3. Click the **Finishing** tab.

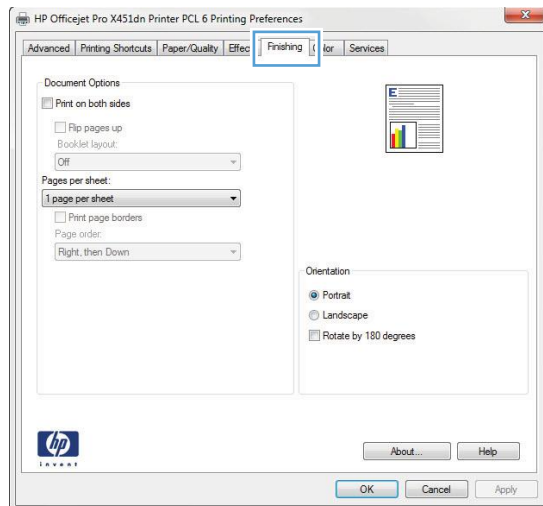

4. In the **Orientation** area, select the **Portrait** or **Landscape** option.

To print the page image upside down, select the **Rotate by 180 degrees** option.

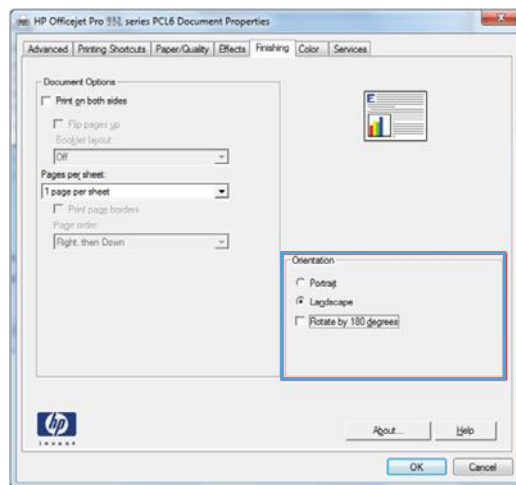

Set Advanced color options with Windows

1. On the **File** menu in the software program, click **Print**.
2. Select the product, and then click the **Properties** or **Preferences** button.
3. Click the **Color** tab.
4. Click the **HP EasyColor** check box to clear it.
5. In the **Color Options** area, click the **Ink Settings** button.
6. Use the sliders to adjust the settings, and then click **OK**.

Print tasks (Mac)

Create and use printing presets with Mac

Use printing presets to save the current printer driver settings for reuse.

Create a printing preset

1. On the **File** menu, click the **Print** option.
2. Select the product from the printer list.
3. Select the print settings that you want to save for reuse.
4. In the **Presets** menu, click the **Save As...** option, and type a name for the preset.
5. Click the **OK** button.

Use printing presets

1. On the **File** menu, click the **Print** option.
2. Select the product from the printer list.
3. In the **Presets** menu, select the printing preset.



NOTE: To use printer-driver default settings, select the **standard** or **Default Settings** option.

Print a cover page with Mac

1. On the **File** menu, click the **Print** option.
2. Select the product from the printer list.
3. Open the **Cover Page** menu, and then select where to print the cover page. Click either the **Before Document** button or the **After Document** button.
4. In the **Cover Page Type** menu, select the message that you want to print on the cover page.



NOTE: To print a blank cover page, select the **standard** option from the **Cover Page Type** menu.

Print multiple pages on one sheet of paper with Mac

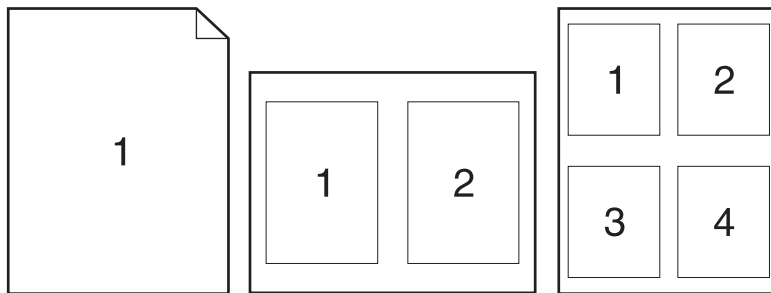

1. On the **File** menu, click the **Print** option.
2. Select the product from the **Printer** list.
3. Open the **Layout** menu.
4. From the **Pages per Sheet** menu, select the number of pages that you want to print on each sheet (1, 2, 4, 6, 9, or 16).
5. In the **Layout Direction** area, select the order and placement of the pages on the sheet.
6. From the **Borders** menu, select the type of border to print around each page on the sheet.

Print on both sides of the page (duplex printing) with Mac

Use automatic duplex printing

1. Insert enough paper into one of the trays to accommodate the print job.
2. On the **File** menu, click the **Print** option.
3. Open the **Layout** menu.
4. From the **Two-Sided** menu, select a binding option. This sets the default binding; subsequent duplex jobs can be printed by simply checking the **Two-Sided** checkbox next to the **Copies** field.

Set the color options with Mac

If you are using the HP Postscript printer driver for Mac, **HP EasyColor** technology scans all documents and automatically adjusts all photographic images with the same improved photographic results.

In the following example, the images on the left were created without using the **HP EasyColor** option. The images on the right show the enhancements that result from using the **HP EasyColor** option.

Bring your photos to LIFE



powered by hp EasyColor and the UPD



Bring your photos to LIFE



powered by hp EasyColor and the UPD



The **HP EasyColor** option is enabled by default in the HP Mac Postscript printer driver, so you do not need to make manual color adjustments. To disable the option so you can manually adjust the color settings, use the following procedure.

1. On the **File** menu, click the **Print** option.
2. Select the product from the **Printers** list.
3. Open the **Color Options** menu, and then click the **HP EasyColor** check box to clear it.
4. Adjust the **RGB Color Settings** by selecting a setting from the **RGB Color** drop-down menu.

Additional print tasks (Windows)

Cancel a print job with Windows

1. If the print job is currently printing, cancel it by touching the **Printing <filename>** display near the bottom of the product control panel, and then touch the **Cancel**  that becomes available on the right-side of the control panel.



NOTE: Cancelling a job clears the job that the product is currently processing. If more than one process is running, repeat step one to cancel the other jobs.

2. You can also cancel a print job from a software program or a print queue.
 - **Software program:** Typically, a dialog box appears briefly on the computer screen, allowing you to cancel the print job.
 - **Windows print queue:** If a print job is waiting in a print queue (computer memory) or print spooler, delete the job there.
 - **Windows XP, Server 2003, or Server 2008:** Click **Start**, click **Settings**, and then click **Printers and Faxes**. Double-click the product icon to open the window, right-click the print job that you want to cancel, and then click **Cancel**.
 - **Windows Vista:** Click **Start**, click **Control Panel**, and then, under **Hardware and Sound**, click **Printer**. Double-click the product icon to open the window, right-click the print job that you want to cancel, and then click **Cancel**.
 - **Windows 7:** Click **Start**, and then click **Devices and Printers**. Double-click the product icon to open the window, right-click the print job that you want to cancel, and then click **Cancel**.

Print colored text as black (grayscale) with Windows

1. On the **File** menu in the software program, click **Print**.
2. Select the product, and then click the **Properties** or **Preferences** button.
3. Click the **Advanced** tab.
4. Expand the **Document Options** section.
5. Expand the **Printer Features** section.
6. In the **Print All Text as Black** drop-down list, select the **Enabled** option.

Print on special paper or labels with Windows

1. On the **File** menu in the software program, click **Print**.

2. Select the product, and then click the **Properties** or **Preferences** button.

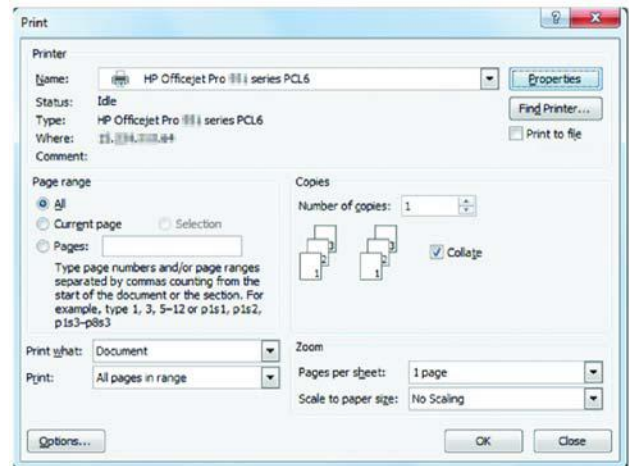

3. Click the **Paper/Quality** tab.

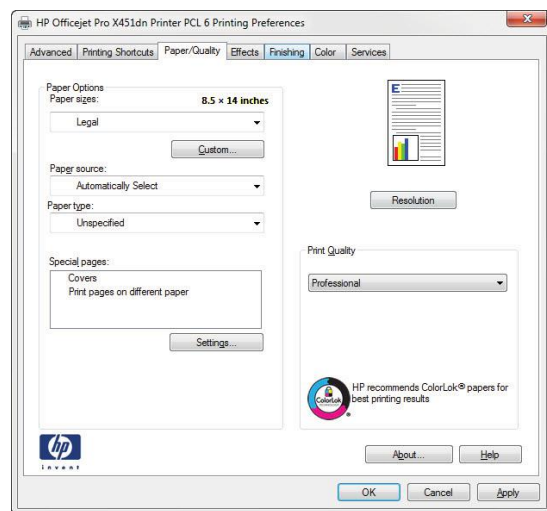

4. From the **Paper type** drop-down list, click the **More...** option.

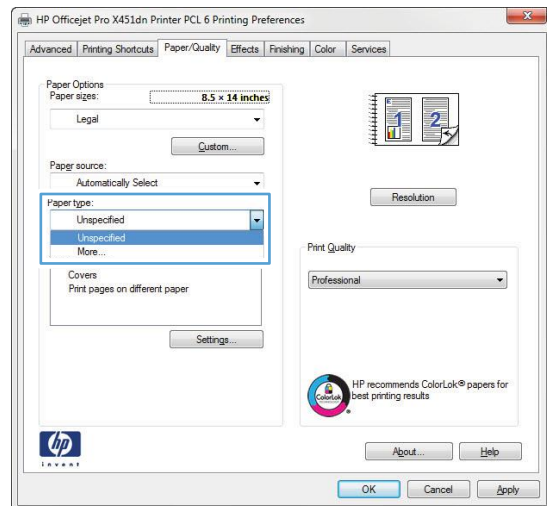

- Expand the list of **Type is:** options.

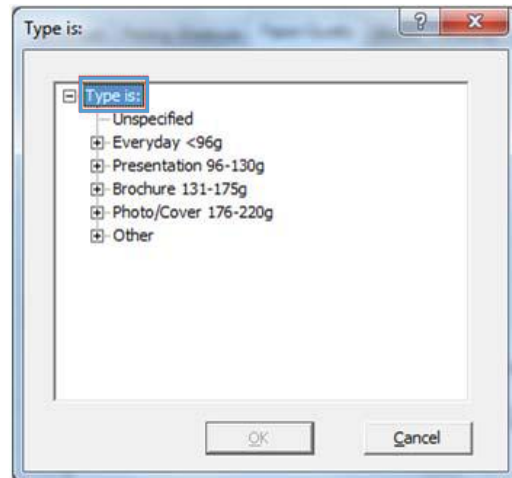

- Expand the category of paper types that best describes your paper.

NOTE: Labels are in the list of **Other** options.

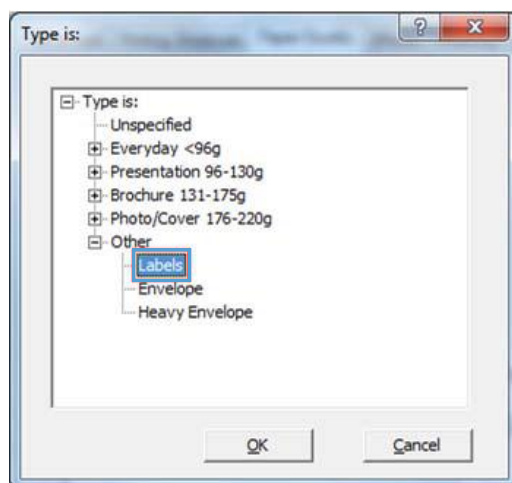

- Select the option for the type of paper you are using, and click the **OK** button.

Print the first or last page on different paper with Windows

- On the **File** menu in the software program, click **Print**.

2. Select the product, and then click the **Properties** or **Preferences** button.

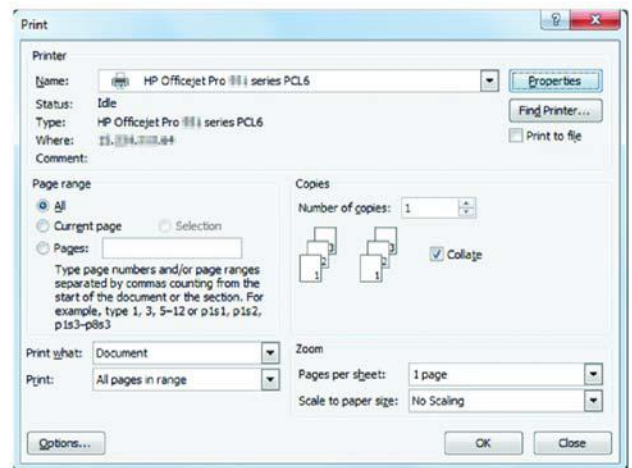

3. Click the **Paper/Quality** tab.

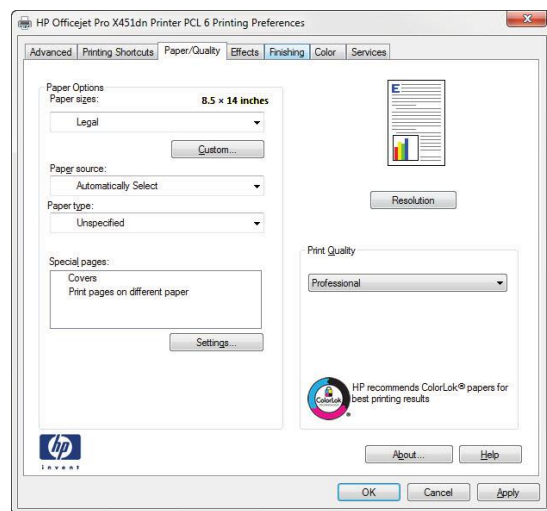

4. In the **Special pages** area, click the **Print pages on different paper** option, and then click the **Settings** button.

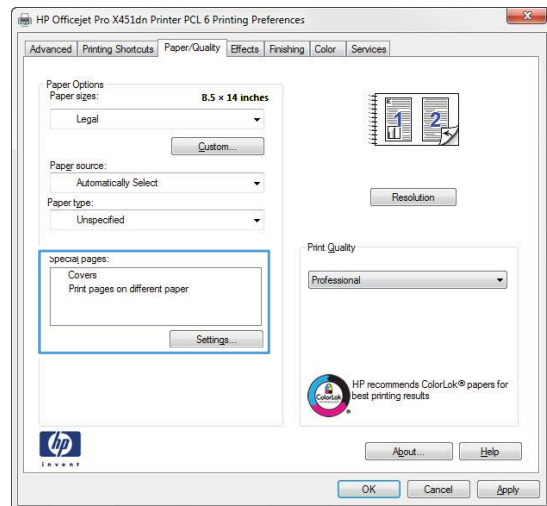

5. In the **Pages in document** area, select either the **First** or **Last** option.

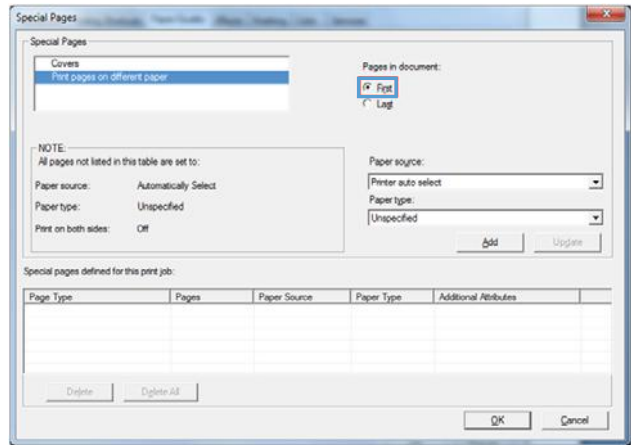

6. Select the correct options from the **Paper source** and **Paper type** drop-down lists. Click the **Add** button.

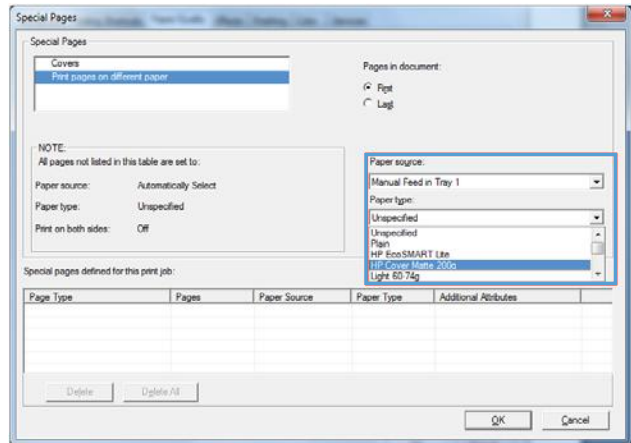

- If you are printing *both* the first and last pages on different paper, repeat steps 5 and 6, selecting the options for the other page.

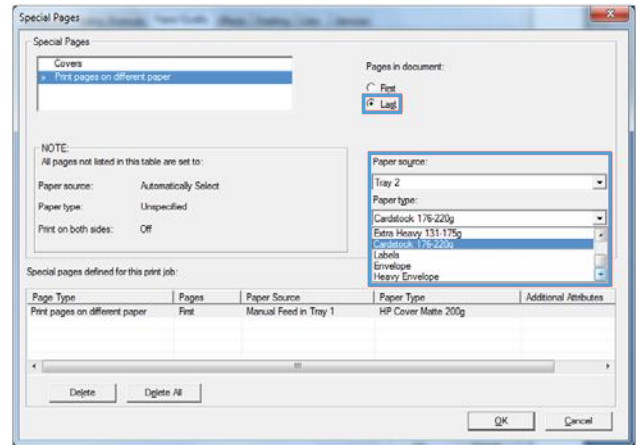

- Click the **OK** button.

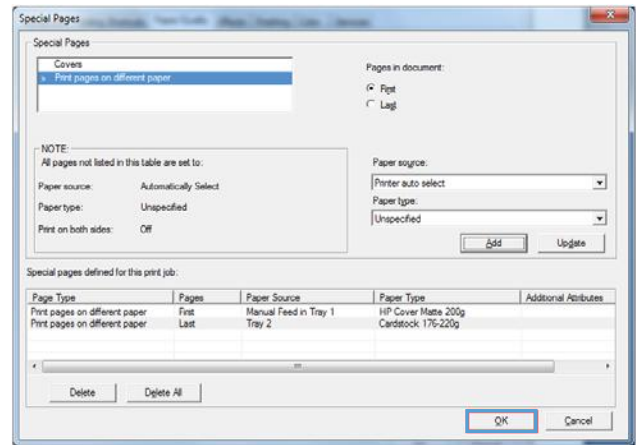

Scale a document to fit page size with Windows

- On the **File** menu in the software program, click **Print**.
- Select the product, and then click the **Properties** or **Preferences** button.

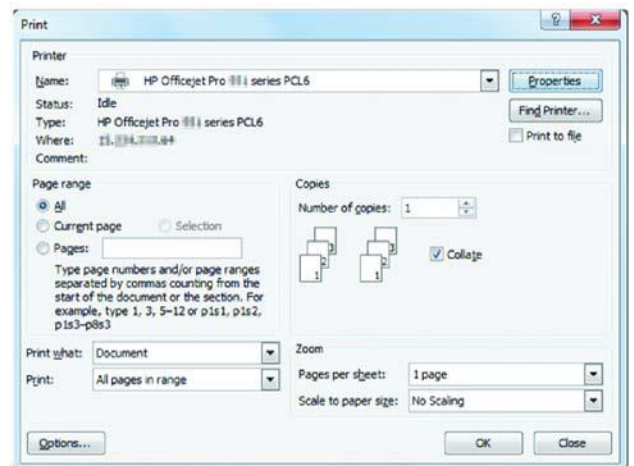

3. Click the **Effects** tab.

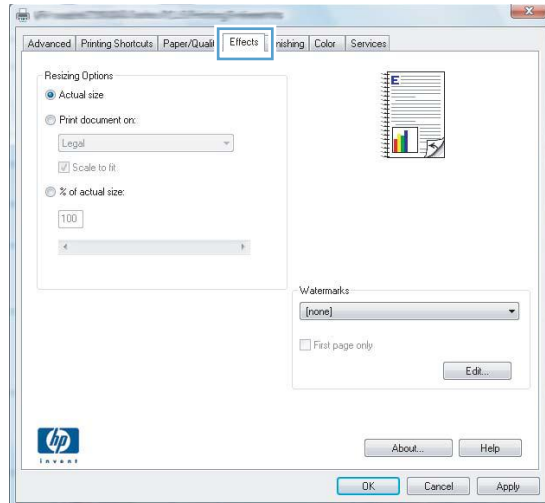

4. Select the **Print document on** option, and then select a size from the drop-down list.

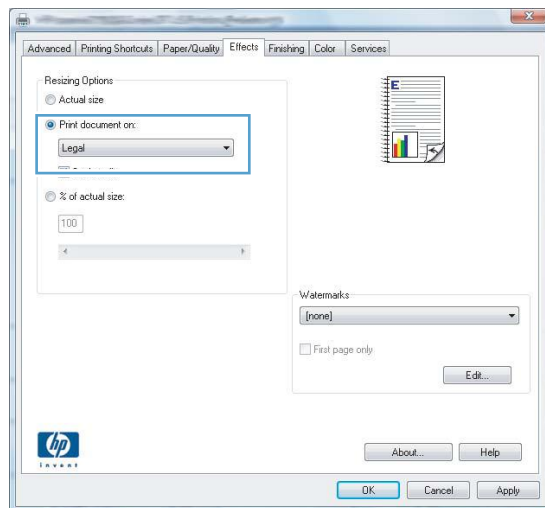

Add a watermark to a document with Windows

1. On the **File** menu in the software program, click **Print**.
2. Select the product, and then click the **Properties** or **Preferences** button.
3. Click the **Effects** tab.
4. Select a watermark from the **Watermarks** drop-down list.

Or, to add a new watermark to the list, click the **Edit** button. Specify the settings for the watermark, and then click the **OK** button.

5. To print the watermark on the first page only, select the **First page only** check box. Otherwise, the watermark is printed on each page.

Create a booklet with Windows

1. On the **File** menu in the software program, click **Print**.
2. Select the product, and then click the **Properties** or **Preferences** button.

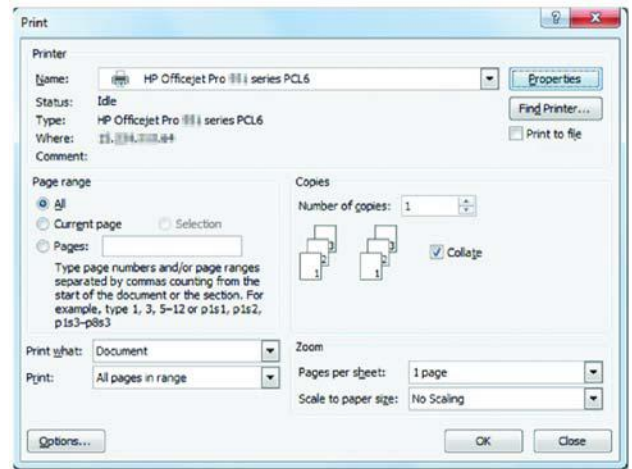

3. Click the **Finishing** tab.

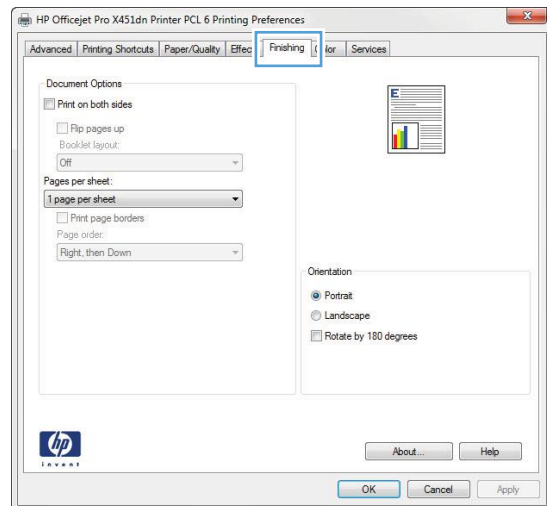

4. Select the **Print on both sides** check box.

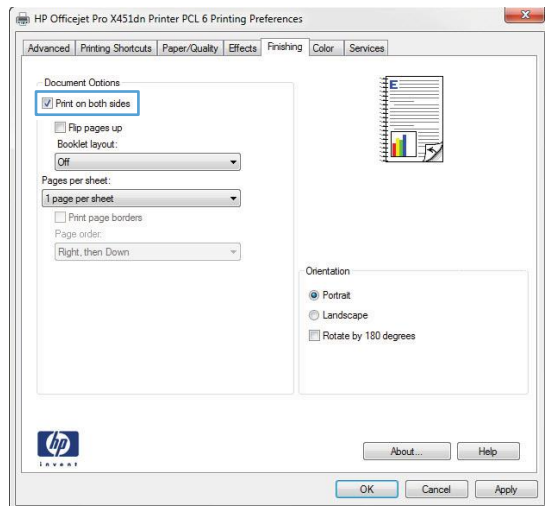

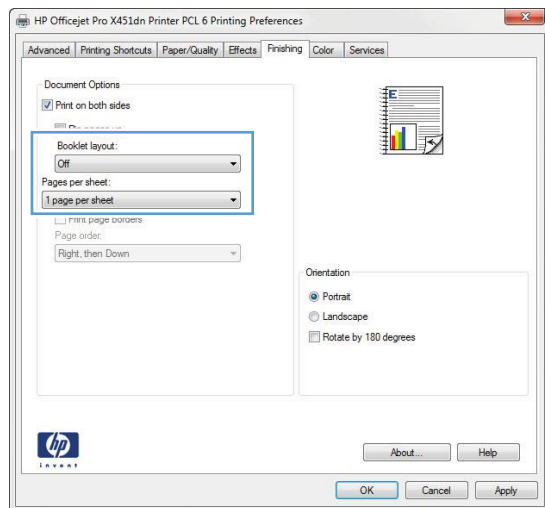

5. In the **Booklet layout** drop-down list, click the **Left binding** or **Right binding** option. The **Pages per sheet** option automatically changes to **2 pages per sheet**.



Additional print tasks (Mac OS X)

Cancel a print job with Mac

1. If the print job is currently printing, cancel it by touching the **Printing <filename>** display near the bottom of the product control panel, and then touch the **Cancel**  that becomes available on the right-side of the control panel.

 **NOTE:** Canceling a job clears the job that the product is currently processing. If more than one process is running, repeat step one to cancel the other jobs.

2. You can also cancel a print job from a software program or a print queue.
 - **Software program:** Typically, a dialog box appears briefly on the computer screen, allowing you to cancel the print job.
 - **Mac print queue:** Open the print queue by double-clicking the product icon in the dock. Highlight the print job, and then click **Delete**.

Change the paper size and type with Mac

1. On the **File** menu in the software program, click the **Print** option.
2. Select a size from the **Paper Size** drop-down list.
3. Open the **Paper/Quality** panel.
4. Select a type from the **Media Type** drop-down list.
5. Click the **Print** button.

Resize documents or print on a custom paper size with Mac

Mac OS X 10.6 and later

Use one of these methods.

1. On the **File** menu, click the **Print** option.
 2. Select the product, and then select the correct settings for the **Paper Size** and **Orientation** options.
-
1. On the **File** menu, click the **Print** option.
 2. Open the **Paper Handling** menu.
 3. In the **Destination Paper Size** area, click the **Scale to fit paper size** box, and then select the size from the drop-down list.
-

Use watermarks with Mac

1. On the **File** menu, click the **Print** option.
2. Open the **Watermarks** menu.
3. Check the **Watermark** box to print a semi-transparent message.

4. From the **Watermarks** menu, select whether to print the watermark on all pages or on the first page only.
5. From the **Text** menu, select one of the standard messages, or select the **Custom** option and type a new message in the box.
6. Select options for the remaining settings.

Use HP ePrint

Use HP ePrint to print documents by sending them as an e-mail attachment to the product's e-mail address from any e-mail enabled device.

 **NOTE:** The product must be connected to a wired or wireless network and have Internet access to use HP ePrint.

1. To use HP ePrint, you must first enable HP Web Services.
 - a. From the Home screen on the product control panel, touch the Web Services  button.
 - b. Touch the [Enable Web Services](#) button.
2. From the [HP Web Services](#) menu, touch the [Display E-Mail Address](#) button to display the product's e-mail address on the control panel.
3. Use the HP ePrintCenter Web site to define security settings and to configure default print settings for all HP ePrint jobs sent to this product.

- a. Go to www.hpeprintcenter.com.
- b. Click **Sign In**, and enter your HP ePrintCenter credentials or sign up for a new account.
- c. Select your product from the list, or click **+ Add printer** to add it. To add the product, you need the printer code, which is the segment of the product e-mail address that is before the @ symbol.

 **NOTE:** This code is valid for only 24 hours from the time you enable HP Web Services. If it expires, follow the instructions to enable HP Web Services again, and obtain a new code.

- d. To prevent your product from printing unexpected documents, click **ePrint Settings**, and then click the **Allowed Senders** tab. Click **Allowed Senders Only**, and add the e-mail addresses from which you want to allow ePrint jobs.
 - e. To set up default settings for all ePrint jobs sent to this product, click **ePrint Settings**, click **Print Options**, and select the settings that you want to use.
4. To print a document, attach it to an e-mail message sent to the product's e-mail address.

 **NOTE:** The email will be printed once it is received. As with any email, there is no guarantee when, or whether, it will be received. You can check the print status at www.eprintcenter.com.

 **NOTE:** Documents printed with HP ePrint may appear different from the original. Style, formatting, and text flow may differ from the original document. For documents that need to be printed with a higher quality (such as legal documents), we recommend that you print from the software application on your computer, where you will have more control over what your printout looks like.

Use the HP ePrint Mobile Driver

The HP ePrint Mobile Driver makes it easy to print from a desktop or laptop computer to any HP ePrint-capable product. After installing the driver, open the **Print** option from within your application, and then select **HP ePrint Mobile** from the installed printers list. This single driver makes it easy to find HP ePrint-enabled products that are registered to your ePrintCenter account. The target HP product can be at your desk or in a remote location, such as a branch office or across the globe—you can do remote printing by using the Internet without file type or size limitations. The target product can be anywhere in the world; if it is Web-connected and registered in ePrintCenter, you can send a print job to the product.

For Windows, the HP ePrint Mobile Driver also supports traditional direct IP printing to local network printers on the network (LAN or WAN) to supported PostScript® products.

Go to www.hp.com/go/eprintmobiledriver for drivers and information.

Supported operating systems

- Windows® XP (32-bit, SP 2 or greater)

 **NOTE:** Microsoft retired mainstream support for Windows XP in April 2009. HP will continue to provide best-effort support for the discontinued XP operating system.

- Windows Vista® (32-bit and 64-bit)
- Windows 7 (32-bit and 64-bit)
- Windows .Net 3.5 SP1

 **NOTE:** Windows .Net 3.5 is installed if you are not using the Add Printer wizard.

- Mac OS X v10.5 and v10.6

 **NOTE:** The HP ePrint Mobile Driver is a PDF workflow utility for Mac, and is not technically a print driver. HP ePrint Mobile for Mac supports print paths only through ePrintcenter and does not support direct IP printing to local network printers.

AirPrint

Direct printing using Apple's AirPrint is supported for iOS 4.2 and Mac OS X 10.7 or later. Use AirPrint to print directly to the product from an iPad (iOS 4.2), iPhone (3GS or later), or iPod touch (third generation or later) in the following mobile applications:

- Mail
- Photos
- Safari
- Select third-party applications

To use AirPrint, the product must be connected to a wireless network. For more information about using AirPrint and about which HP products are compatible with AirPrint, go to www.hp.com/go/airprint.

 **NOTE:** You might need to upgrade the product firmware to use AirPrint. Go to www.hp.com/support.

 **NOTE:** When using the AirPrint driver, the options and settings will differ from the full-featured driver provided by HP. This document describes the full-featured HP driver features.

Connect the printer with HP Wireless Direct

Connect a computer, smart phone, tablet, or other Wi-Fi capable device directly to your HP printer with HP Wireless Direct. With an HP Wireless Direct connection you can print wirelessly, without a router, from your Wi-Fi capable devices.

- HP printing software is required for printing over Wireless Direct from a computer. A compatible printing application is required for printing over Wireless Direct from a smart phone or tablet.
- A Wireless Direct connection is turned on and managed from the printer's control panel.
- If your WiFi capable device supports WPA2 encryption, you can enable security when you setup a Wireless Direct connection.
- Five devices or fewer can simultaneously use Wireless Direct to connect to your printer.
- A Wireless Direct connection can be used while your printer is also connected to a wireless network or a USB cable.
- Wireless Direct cannot connect to the internet.

This section covers the following topics:

- [Connect and print from a WiFi capable mobile device](#)
- [Connect and print from a WiFi capable computer over a wireless router and Wireless Direct](#)
- [Connect and print from a WiFi capable computer over Wireless Direct only](#)
- [Change from printing over USB to a Wireless Direct connection](#)

Connect and print from a WiFi capable mobile device

1. Setup your printer. A compatible print application is required for printing from a mobile device. If your mobile print application can print over a wireless network connection, you can print over Wireless Direct.



NOTE: Compatible with mobile devices with HP ePrint mobile app installed, HP Printer Control app installed, Apple devices with iOS 4.2+, and HP webOS devices.

2. Turn on your printer's Wireless Direct connection.
 - Press (X476 Series) or touch (X576 Series) the **Setup**  button from the control panel.
 - Open the **Network Setup** menu.
 - Open the **Wireless Direct** menu.
 - Select **On** to enable Wireless Direct connections or select **On With Security** to enable secure, Wireless Direct connections to the printer.
3. Turn on your mobile device's Wi-Fi capability.

4. From your mobile device, search for and connect to the Wireless Direct name for your printer, such as HP-Setup-xx-Officejet Pro X576.
5. From your mobile device's print application, confirm your HP printer is the default printer, select print, and then print your document.

Connect and print from a WiFi capable computer over a wireless router and Wireless Direct

1. Setup and install your printer over a wireless router. Make sure you can successfully print over your wireless router before proceeding.
2. Turn on your printer's Wireless Direct connection.
 - Press (X476 Series) or touch (X576 Series) the **Setup**  button from the control panel.
 - Open the **Network Setup** menu.
 - Open the **Wireless Direct** menu.
 - Select **On** to enable Wireless Direct connections or select **On With Security** to enable secure, Wireless Direct connections to the printer.
3. Turn on your computer's Wi-Fi capability.
4. From your computer, search for and connect to the Wireless Direct name for your printer, such as HP-Setup-xx-Officejet Pro X576.
5. From your computer, select print, and then confirm to print your document.

Connect and print from a WiFi capable computer over Wireless Direct only

1. Setup your printer, but do not install the HP printer software.
2. Turn on your printer's Wireless Direct connection.
 - Press (X476 Series) or touch (X576 Series) the **Setup**  button from the control panel.
 - Open the **Network Setup** menu.
 - Open the **Wireless Direct** menu.
 - Select **On** to enable Wireless Direct connections or select **On With Security** to enable secure, Wireless Direct connections to the printer.
3. Turn on your computer's Wi-Fi capability.

4. From your computer, search for and connect to the Wireless Direct name for your printer, such as HP-Setup-xx-Officejet Pro X576.
5. Install the HP printer software.
 - When the **Connection Options** software screen is shown, select **Wireless**.
 - When the list of detected printers is shown, select your HP printer, and then finish installing.

Change from printing over USB to a Wireless Direct connection

Follow these steps after setting up your printer with a USB connection.

1. Turn on your printer's Wireless Direct connection.
 - Press (X476 Series) or touch (X576 Series) the **Setup**  button from the control panel.
 - Open the **Network Setup** menu.
 - Open the **Wireless Direct** menu.
 - Select **On** to enable Wireless Direct connections or select **On With Security** to enable secure, Wireless Direct connections to the printer.
2. Turn on your computer's Wi-Fi capability.
3. From your computer, search for and connect to the Wireless Direct name for your printer, such as HP-Setup-xx-Officejet Pro X576.
4. From your computer, configure the printer software to print over Wireless Direct.
 - a. Select Windows **Start** button > **All Programs** > **HP** > HP Officejet Pro X576 MFP Series **Printer Setup & Software**
 - b. Select **Connect New Printer**.
5. When you want to print over Wireless Direct, select your printer labeled (Network) from the Windows Printers group in the software application that you are using.



IMPORTANT: Do not select **Convert a USB connected printer to wireless**.

- c. When the **Connection Options** software screen is shown, select **Wireless**.
- d. When the list of detected printers is shown, select your HP printer, and then finish installing.



NOTE: There will be two instances of your printer in the Printers group, so be sure to select the printer named HP Officejet Pro X576 MFP Series(Network).

Plug and Print USB Drive printing

This product features printing from a USB flash drive, so you can quickly print files without sending them from a computer. The product accepts standard USB storage accessories in the USB port on the front and back of the product. You can print the following types of files:

- .PDF
- .JPEG
- .JPG
- .PNG
- .TIFF

1. Insert the USB drive into the USB port on the front or back of the product. The Plug and Print menu opens.

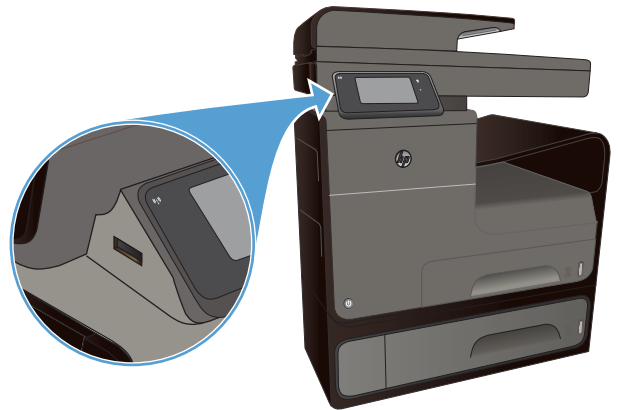

2. Select a document from the list of documents and folders on the USB device.
3. Touch the [Settings](#) button to modify the print settings for the job, if necessary.
4. Touch [Start Black](#) or [Start Color](#) to start the print job.
5. To scan a document and save it as a .JPEG or .PDF file onto the USB drive, load the document onto the scanner glass or into the document feeder. Touch the [Scan to USB Drive](#) item. Touch the [Settings](#) button to adjust the scan settings.

9 Color

- [Adjust color](#)
- [Use the HP EasyColor option](#)
- [Match colors to your computer screen](#)
- [Print fade- and water-resistant prints](#)

Adjust color

Manage color by changing the settings on the **Color** (Windows) and **Color Options** tab (Mac) in the printer driver.

Change the color theme for a print job

1. On the **File** menu in the software program, click **Print**.
2. Click **Properties** or **Preferences** (Windows).
3. Click the **Color** tab (Windows) or **Color Options** tab (Mac) and uncheck HP EasyColor.
4. Select a color theme from the **Color Themes** (Windows) or **RGB Color** (Mac) drop-down list.

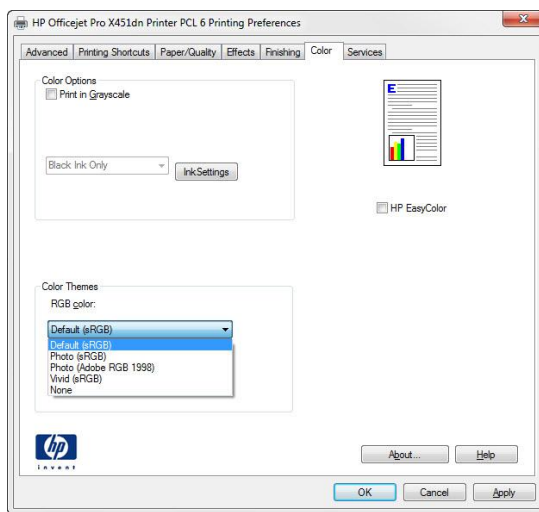

- **Default (sRGB):** This theme sets the product to print RGB data in raw device mode. When using this theme, manage color in the software program or in the operating system for correct rendering.
- **Vivid:** The product increases the color saturation in the midtones. Use this theme when printing business graphics.
- **Photo:** The product interprets RGB color as if it were printed as a photograph using a digital mini lab. The product renders deeper, more saturated colors differently than with the Default (sRGB) theme. Use this theme when printing photos.
- **Photo (Adobe RGB 1998):** Use this theme with printing digital photos that use the AdobeRGB color space rather than sRGB. Turn off color management in the software program when using this theme.
- **None:** No color theme is used.

Change the color options

Change the color options settings for the current print job from the color tab of the printer driver.

1. On the **File** menu in the software program, click the **Print** item.
2. Click **Properties** or **Preferences** (Windows).
3. Click the **Color** tab (Windows) or **Color Options** tab (Mac).
4. Clear the **HP EasyColor** check box.

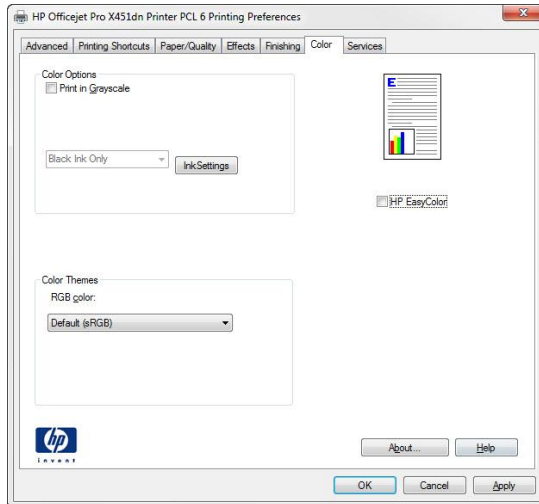

5. Click the **Ink Settings** button (Windows) or expand the **Advanced** menu (Mac), and then use the slider to make the following adjustments:
 - **Dry Time**
 - **Saturation**
 - **Black Ink Spread**



NOTE: Changing color settings manually can impact output. HP recommends that only color graphics experts change these settings.

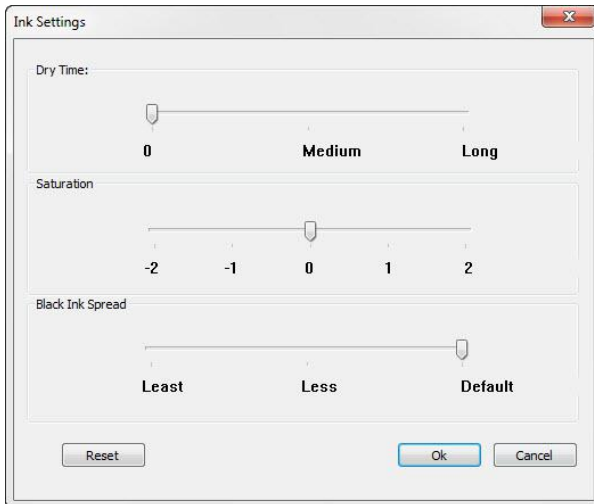

 **NOTE:** Changing color settings manually can impact output. HP recommends that only color graphics experts change these settings.

6. Click **OK** so save your adjustments and close the window, or click **Reset** to return the settings to the factory defaults (Windows).
7. Click the **Print in Grayscale** option (Windows) or **Print Color as Gray** (Mac) to print a color document in black and shades of gray. Use this option to print color documents for photocopying or faxing. You can also use this option to print draft copies or to save color cartridge life.

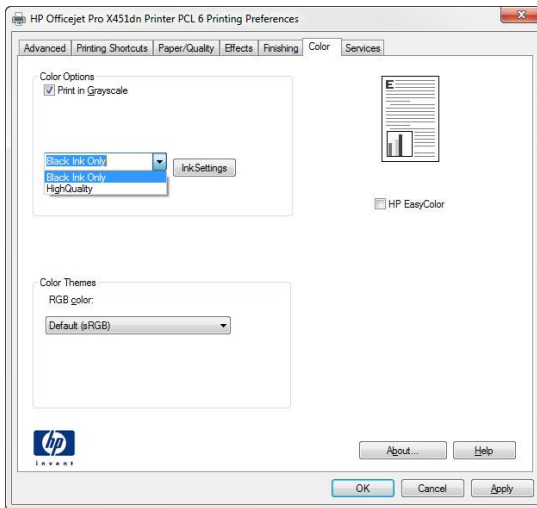

8. Click the **OK** button (Windows).

Use the HP EasyColor option

If you are using the HP PCL 6 printer driver for Windows, the **HP EasyColor** technology automatically improves mixed-content documents that are printed from Microsoft Office programs. This technology scans documents and automatically adjusts photographic images in .JPEG or .PNG format.

HP EasyColor technology enhances the entire image at one time, rather than dividing it into several pieces, which results in improved color consistency, sharper details, and faster printing.

If you are using the HP Postscript printer driver for Mac, **HP EasyColor** technology scans all documents and automatically adjusts all photographic images with the same improved photographic results.

In the following example, the images on the left were created without using the **HP EasyColor** option. The images on the right show the enhancements that result from using the **HP EasyColor** option.



The **HP EasyColor** option is enabled by default in both the HP PCL 6 printer driver and the HP Mac Postscript printer driver, so you do not need to make manual color adjustments. To disable the option so you can manually adjust the color settings, open the **Color** tab in the Windows driver or the **Color Options** tab in the Mac driver, and then click the **HP EasyColor** check box to clear it.

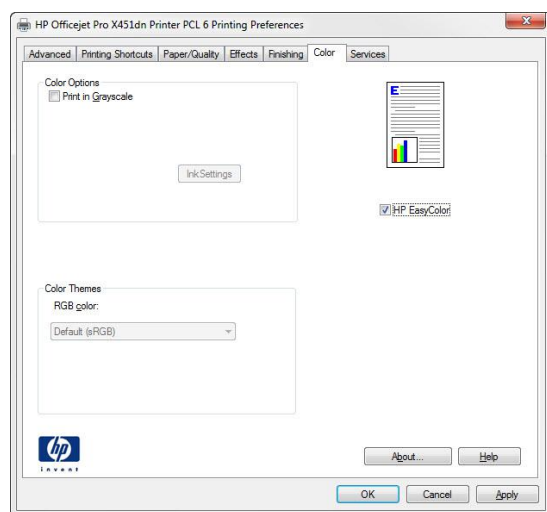

Match colors to your computer screen

For most users, the best method for matching colors is to print sRGB colors.

The process of matching printer output color to your computer screen is complex, because printers and computer monitors use different methods of producing color. Monitors *display* colors by using light pixels that use an RGB (red, green, blue) color process, but printers *print* colors by using a CMYK (cyan, magenta, yellow, and black) process.

Many factors can influence your ability to match printed colors to those on your monitor:

- Print media
- Printer ink
- Printing process (inkjet, press, or laser technology, for example)
- Overhead lighting
- Personal differences in perception of color
- Software programs
- Printer drivers
- Computer operating systems
- Monitors
- Video cards and drivers
- Operating environment (humidity, for example)

Keep these factors in mind when colors on your screen do not perfectly match your printed colors.

Print fade- and water-resistant prints

HP Officejet pigment inks designed for business use are like liquid laser toner—providing professional, durable color documents that stand up to handling and dry quickly. Print professional, water-resistant documents on plain paper.

Not only do HP Officejet pigment inks offer vivid colors and bold blacks, they provide benefits over traditional dye-based inks, including superior water and fade resistance and better durability. These unique qualities are possible because the pigment solid does not dissolve in water but is dispersed to prevent pigment settling. As a result, output resists rain and water spills, and you can handle important documents with confidence.

HP Officejet inks for business are specifically developed for use with HP printheads. Unique ink formulations help extend the life of the printheads and enhance reliability. When used with ColorLok® paper, these inks provide laser-like color output that dries quickly and is ready for distribution.

 **NOTE:** Based on HP internal testing using a range of plain papers, HP highly recommends using papers with the ColorLok® logo for this product. For details, go to <http://www.hp.com/go/printpermanence>.



10 Copy

- [Use copy functions](#)
- [Copy settings](#)
- [Copy photos](#)
- [Copy mixed size originals](#)
- [Copy on both sides](#)

Use copy functions

Copy

1. Load the document onto the scanner glass or into the document feeder.

CAUTION: When using the document feeder, ensure there are no staples in your document.

CAUTION: When performing a copy, ensure the scan lid is closed.



2. From the Home screen, touch the **Copy**  button.
3. Touch the **Black** or **Color** button to start copying.

Multiple copies

1. Load the document onto the scanner glass or into the document feeder.



2. From the Home screen, touch the **Copy**  button.

3. Touch the arrows to change the number of copies, or touch the existing number and type the number of copies.
4. Touch the **Black** or **Color** button to start copying.

Copy a multiple-page original

1. Insert the originals into the document feeder face-up.



2. Adjust the guides until they are snug against the paper.



3. From the Home screen, touch the **Copy**  button.
4. Touch the **Black** or **Color** button to start copying.

Copy identification cards

Use the **ID Copy** feature to copy both sides of identification cards, or other small-size documents, onto the same side of one sheet of paper. The product prompts you to copy the first side and then to place the second side on a different area of the scanner glass and copy again. The product prints both images at the same time.

1. Load the document onto the scanner glass.



2. From the Home screen, touch the **Copy**  button.
3. Touch the **Settings** button, and then touch **ID Copy**.
4. Touch the **Black** or **Color** button to start copying.
5. The product prompts you to place the next page on a different section of the scanner glass.



6. Touch the **OK** button if you have more pages to copy, or touch the **Done** button if this is the last page.
7. The product copies all pages onto one side of a sheet of paper.

Cancel a copy job

1. Touch the Cancel **X** button on the product control panel.

 **NOTE:** Use the Cancel **X** button if the current job screen has not timed out. You can also cancel the job from the queue of the status bar.

2. Remove the remaining pages from the document feeder.

Reduce or enlarge a copy

1. Load the document onto the scanner glass or into the document feeder.



2. From the Home screen, touch the **Copy**  button.
3. Touch the **Settings** button, and then touch the **Reduce/Enlarge** button. Touch the arrow buttons to scroll through the options, and then touch an option to select it.
4. Touch the **Black** or **Color** button to start copying.

Collate a copy job

1. Load the document onto the scanner glass or into the document feeder.



2. From the Home screen, touch the **Copy**  button.
3. Touch the **Settings** button, and then touch the **Collate** button to select.
4. Touch the **Black** or **Color** button to start copying.

Copy settings

Check the scanner glass for dirt and smudges

Over time, specks of debris might collect on the scanner glass and white plastic backing, which can affect performance. Use the following procedure to clean the scanner glass and white plastic backing.

1. Use the power switch to turn off the product, and then unplug the power cord from the electrical socket.

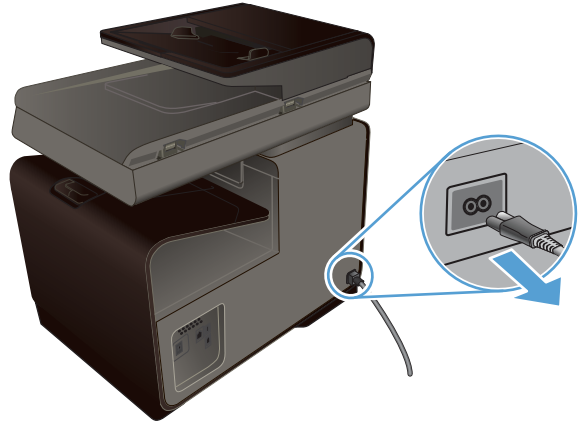

2. Open the scanner lid.
3. Clean the scanner glass and the white plastic backing with a soft cloth or sponge that has been moistened with nonabrasive glass cleaner.

CAUTION: Do not use abrasives, acetone, benzene, ammonia, ethyl alcohol, or carbon tetrachloride on any part of the product; these can damage the product. Do not place liquids directly on the glass or platen. They might seep and damage the product.



4. Dry the glass and white plastic with a chamois or a cellulose sponge to prevent spotting.
5. Plug in the product, and then use the power button to turn on the product.

Adjust the lightness or darkness for copies

1. Load the document onto the scanner glass or into the document feeder.



2. From the Home screen, touch the **Copy**  button.
3. Touch the **Settings** button, select **Lighter/Darker**, and then touch the arrow buttons to adjust the setting.
4. Touch the **Black** or **Color** button to start copying.

Define custom copy settings

When you change the copy settings at the control panel, the custom settings remain in effect for approximately 2 minutes after the job completes, and then the product returns to the default settings. To immediately return to the default settings, press the **Cancel**  button from the Home screen.

Print or copy edge-to-edge

The product cannot print fully edge-to-edge. The maximum printing area is 203.2 x 347 mm (8 x 13.7 in), leaving a 4.23 mm (1/6 inch) unprintable border around the page.

Considerations for printing or scanning documents with cropped edges:

- When the original is smaller than the output size, move the original 5 mm (3/16 inch) away from the corner indicated by the icon on the scanner. Recopy or scan in this position.
- When the original is the size of the desired output, use the **Reduce/Enlarge** feature to reduce the image so the copy is not cropped.

Set the paper size and type for copying on special paper

1. From the Home screen, touch the **Copy** button.

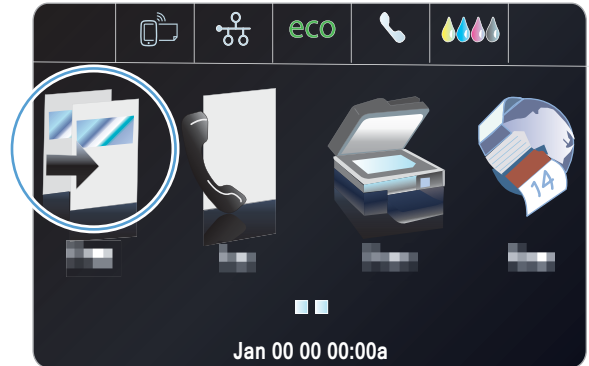

2. Touch the **Settings** button, and then scroll to and touch the **Tray Selection** button.
3. Set the paper size/type as needed for the tray.

NOTE: Your settings may be saved as defaults for the tray.

4. Touch the **Black** or **Color** button to start copying.

Copy photos

 **NOTE:** Copy photos from the scanner glass, not from the document feeder.

1. Place the photo on the scanner glass, picture-side down at the upper left corner of the glass, and close the scanner lid.



2. From the Home screen, touch the **Copy**  button.
3. Touch the **Settings** button, and then scroll to and touch the **Enhancements** button.
4. Touch the **Mixed** button.
5. Touch the **Black** or **Color** button to start copying.

Copy mixed size originals

Use the scanner glass to make copies of mixed size originals.

 **NOTE:** You can use the document feeder to copy mixed size originals only if the pages share a common dimension. For example, you can combine Letter and Legal size pages because they have the same width. Stack the pages so the top edges are even with each other and so the pages have the same width but varying lengths.

1. Load paper into the tray that is large enough for the largest page in the original document.
2. Place one page of the original document face down in the upper left corner of the scanner glass.



3. From the Home screen, touch the **Copy**  button.
4. Touch the **Settings** button, and then scroll to and touch the **Tray Selection** button.
5. From the list of paper sizes, touch the name of the paper size that is loaded in the tray.
6. Touch the **Black** or **Color** button to start copying.
7. Repeat these steps for each page.

Copy on both sides

Copy on both sides automatically

1. Load the first page of the document onto the scanner glass or into the document feeder.



2. From the Home screen, touch the **Copy**  button.
3. Touch the **Two-Sided** button.
4. Select the duplexing option that you want to use. For example, to copy a two-sided original with two-sided output, select the **2-Sided to 2-Sided** option.
5. Touch the **Black** or **Color** button to start copying.

11 Scan

- [Use scan functions](#)
- [Scan settings](#)
- [Scan a photo to USB](#)

Use scan functions

Use the product to scan a document from the scanner glass or document feeder.

 **CAUTION:** When using the document feeder, ensure there are no staples in your document.

CAUTION: For best scan quality, close scanner lid before you turn on the printer. This will allow the scanner to calibrate.

Scan methods

Perform scan jobs in the following ways.

- Scan to a USB drive from the product control panel.
- Scan from a computer by using HP Scan software
- Scan from TWAIN-compliant or Windows Imaging Application (WIA)-compliant software

 **NOTE:** To learn about and use text-recognition software, install the Readiris program from the software CD. Text-recognition software is also known as optical character recognition (OCR) software.

Scan to a USB drive

1. Load the document onto the scanner glass or into the document feeder.
2. Connect a USB drive into the port on the front or back of the product.
3. From the Home screen, touch the **Scan**  button.
4. Touch the **Scan to USB Drive** screen.
5. Touch the **Scan** button to scan and save the file. The product creates a folder named **HP** on the USB drive, and it saves the file in .PDF or .JPG format using an automatically generated file name.

 **NOTE:** When the summary screen opens, you can touch it to adjust settings.

Scan an original from HP scanning software

Follow the instructions for your operating system.

 **NOTE:** Use the HP software to scan documents into editable text, a format that allows you to search, copy, paste, and edit within the scanned document. Use this format to edit letters, newspaper clippings, and many other documents.

Windows

1. Load your original print-side down on the left–rear corner of the glass or print-side up in the ADF.
2. On the computer, open the HP scanning software:
 - From the computer desktop, click **Start**.
 - Select **Programs** or **All Programs**.
 - Select the folder for your HP printer.
 - Select **HP Scan**.
3. Select a scan shortcut. Make changes to the scan settings, if needed.
4. To start the scan, click **Scan**.

Mac OS X

1. Load your original print-side down on the left–rear corner of the glass or print-side up in the ADF.
2. Double-click the **HP Scan** icon. This icon is located in the **Hewlett-Packard** folder in the **Applications** folder at the top level of the hard disk.
3. Follow the prompts to complete the scan.

Scan by using other software

The product is TWAIN-compliant and Windows Imaging Application (WIA)-compliant. The product works with Windows-based programs that support TWAIN-compliant or WIA-compliant scanning devices and with Macintosh-based programs that support TWAIN-compliant scanning devices.

While you are in a TWAIN-compliant or WIA-compliant program, you can gain access to the scanning feature and scan an image directly into the open program. For more information, see the Help file or the documentation that came with your TWAIN-compliant or WIA-compliant software program or see [How to Scan in Windows without Using HP Software](#).

Scan from a TWAIN-compliant program

Generally, a software program is TWAIN-compliant if it has a command such as **Acquire**, **File Acquire**, **Scan**, **Import New Object**, **Insert from**, or **Scanner**. If you are unsure whether the program is compliant or you do not know what the command is called, see the software program Help or documentation.

When scanning from a TWAIN-compliant program, the HP Scan software program might start automatically. If the HP Scan program starts, you can make changes while previewing the image. If the program does not start automatically, the image goes to the TWAIN-compliant program immediately.

Start the scan from within the TWAIN-compliant program. See the software program Help or documentation for information about the commands and steps to use.

Scan from a WIA-compliant program

WIA is another way to scan an image directly into a software program. WIA uses Microsoft software to scan, instead of the HP Scan software.

Generally, a software program is WIA-compliant if it has a command such as **Picture/From Scanner or Camera** in the Insert or File menu. If you are unsure whether the program is WIA-compliant, see the software program Help or documentation.

Start the scan from within the WIA-compliant program. See the software program Help or documentation for information about the commands and steps to use.

-Or-

From the Windows control panel, in the **Cameras and Scanner** folder (located inside the **Hardware and Sound** folder for Windows Vista and Windows 7), double-click the product icon. This opens the standard Microsoft WIA Wizard, which enables you to scan to a file.

Scan by using optical character recognition (OCR) software

To import scanned text into your preferred word-processing program for editing, open the HP Scan software and select the shortcut named **Save as Editable Text (OCR)**.

You can also use third-party OCR software. The Readiris Pro OCR program is included on a separate CD that shipped with the product. To use the Readiris Pro program, install it from the appropriate software CD, and then follow the instructions in the online Help.

Cancel a scan

To cancel a scan job, use one of the following procedures.

- On the product control panel, touch the Cancel  button.
- Select and delete the job from the status bar after the time-out occurs.

Scan settings

Scanner resolution and color

If you are printing a scanned image, and the quality is not what you expected, you might have selected a resolution or color setting in the scanner software that does not match your needs. Resolution and color affect the following qualities of scanned images:

- Clarity
- Texture of gradations (smooth or rough)
- Scan time
- File size

Scanning resolution is measured in pixels per inch (ppi).

 **NOTE:** Scanning ppi levels are not interchangeable with printing dpi (dots per inch) levels.

Color, grayscale, and black and white define the number of colors possible. You can adjust the scanner hardware resolution to up to 600 ppi.

The resolution and color guidelines table lists simple tips that you can follow to meet your scanning needs.

 **NOTE:** Setting the resolution and color to a higher values can create large files on disk and slow the scanning process. Before setting the resolution and color, determine how you are going to use the scanned image.

Resolution and color guidelines

The following table describes the recommended resolution and color settings for different types of scan jobs.

 **NOTE:** The default resolution setting is approximately 600 dpi for flatbed scanning and approximately 300 dpi for ADF scanning.

Intended use	Recommended resolution	Recommended color settings
Fax	300 dpi	<ul style="list-style-type: none">• Black and White
E-mail	300 dpi	<ul style="list-style-type: none">• Black and White, if the image does not require smooth gradation• Grayscale, if the image requires smooth gradation• Color, if the image is in color
Edit text	300 dpi	<ul style="list-style-type: none">• Black and White
Print (graphics or text)	600 dpi for normal graphics and text	<ul style="list-style-type: none">• Grayscale for shaded or colored graphics and photos• Color, if the image is in color
Display on screen	75 dpi	<ul style="list-style-type: none">• Black and White for text• Grayscale for graphics and photos• Color, if the image is in color

Lighter/Darker

You can set the brightness values by using the slider to lighten or darken your scanned image.

Scan quality

Over time, specks of debris might collect on the scanner glass and white plastic backing, which can affect performance. Use the following procedure to clean the scanner glass and white plastic backing.

1. Use the power switch to turn off the product, and then unplug the power cord from the electrical socket.

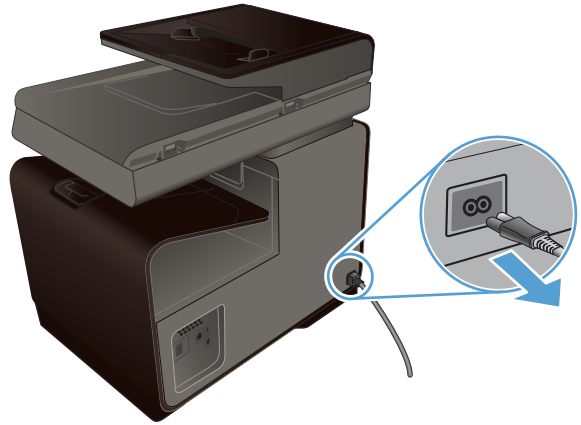

2. Open the scanner lid.
3. Clean the scanner glass and the white plastic backing with a soft cloth or sponge that has been moistened with nonabrasive glass cleaner.

CAUTION: Do not use abrasives, acetone, benzene, ammonia, ethyl alcohol, or carbon tetrachloride on any part of the product; these can damage the product. Do not place liquids directly on the glass or platen. They might seep and damage the product.



4. Dry the glass and white plastic with a chamois or a cellulose sponge to prevent spotting.
5. Plug in the product, and then use the power switch to turn on the product.

Scan a photo to USB

1. Place the photo on the scanner glass, picture-side down at the upper left corner of the glass, and close the scanner lid.



2. Insert a USB storage device into the port on the front or back of the product.
3. From the Home screen, touch the **Scan**  button.
4. Touch the **Scan to USB Drive** button. The control panel shows a summary of scan settings. Touch this screen to adjust any settings.
5. Touch the **Scan** button to scan the document and save it in a folder on the USB flash drive.

12 Fax

- [Set up fax](#)
- [Use the phone book](#)
- [Set fax settings](#)
- [Use fax](#)
- [Solve fax problems](#)
- [Regulatory information and warranties](#)

Set up fax

Install and connect the hardware

Connect fax to a telephone line

- ▲ Connect the telephone cable to the line port  on the product and to the telephone jack on the wall.

The product is an analog device. HP recommends using the product on a dedicated analog telephone line. If you are using a digital environment, such as DSL, PBX, ISDN, or VoIP, make sure to use the correct filters and configure the digital settings correctly. For more information, contact your digital service provider.



NOTE: Some countries/regions might require an adapter to the phone cord that came with the product.

Configure fax settings

You can configure the product fax settings from the control panel or from the HP Embedded Web Server.

In the United States and many other countries/regions, setting the time, date, and other fax header information is a legal requirement.

Use the control panel to set the fax time, date, and header

To use the control panel to set the date, time, and header, complete the following steps:

1. From the Home screen, touch the **Setup**  button.
2. Touch the **Device Setup** menu.
3. Touch the **Preferences** menu.
4. Scroll to and touch the **Date and Time** button.
5. Select the 12-hour clock or 24-hour clock.
6. Use the keypad to enter the current time, and then touch the **OK** button.
7. Select the date format.
8. Use the keypad to enter the current date, and then touch the **OK** button.
9. From the **Fax Setup** menu, touch the **Basic Fax Setup** menu, and then touch the **Fax Header** menu.

10. Use the keypad to enter your name and fax's telephone number when prompted, and then touch the **OK** button.



NOTE: The maximum number of characters for the fax number is 20.

11. Use the keypad to enter your company name or other header identifying information, and then touch the **OK** button.



NOTE: The maximum number of characters for the fax header is 25.

Include common localized characters

When using the control panel to enter text, or to enter a name for a one-touch key, speed-dial entry, or group-dial entry, touch the **123** button to open a keypad that contains special characters.

Use the HP Fax Setup Wizard (Windows)

If you did not complete the fax setup process at the time you installed the software, you can complete it at any time by using the HP Fax Setup Wizard.

1. On your computer, click **Start**, and then click **Programs**.
2. Click **HP**, click the name of the product, and then click on your printer. Choose the **Fax Setup Wizard** from the **Fax** section of the HP Printer Assistant.
3. Follow the on-screen instructions in the Fax Setup Wizard to configure the fax settings.

Use the phone book

You can store frequently dialed fax numbers (up to 75 entries) either as individual fax numbers or as other phone book fax number entries.

Use speed dials

Create and edit speed-dial entries

1. From the product's Home screen, touch the **Fax** button.



2. Touch the **Speed-Dial Setup** menu.
3. Touch the **Add/Edit Speed-Dial** button.
4. Touch an unassigned number from the list.
5. When prompted, use the keypad to enter a number for the entry, and then touch the **Next** button.
6. Use the keypad to enter a name for the fax number, and then touch the **Done** button.

Delete speed-dial entries

1. From the Home screen, touch the **Fax** button.



2. Touch the **Speed-Dial Setup** menu.

3. Touch the [Delete Speed-Dial](#) button.
4. Touch the entry that you want to delete.

Manage group-dial entries

Create and edit group-dial entries



1. Create an individual entry for each fax number that you want in the group.
 - a. From the Home screen, touch the [Fax](#)  button.
 - b. Touch the [Speed-Dial Setup](#) menu.
 - c. Touch the [Add/Edit Speed-Dial](#) button.
 - d. Touch an unassigned number from the list.
 - e. Use the keypad to enter the fax number for the entry, and then touch the [Next](#) button.
 - f. Use the keypad to enter a name for the entry, and then touch the [Done](#) button.
2. From the [Speed-Dial Setup](#) menu, touch the [Group Speed-Dial](#) button.
3. Touch an unassigned number from the list.
4. Touch the name of each individual entry that you want to include in the group. When you are finished, touch the [OK](#) button.
5. Use the keypad to enter a name for the group, and then touch the [Done](#) button.

Set fax settings

Send-fax settings

Set special dialing symbols and options

You can insert pauses into a fax number that you are dialing. Pauses are often needed when dialing internationally or connecting to an outside line. To access these symbols, touch the * character on the key pad.

Special symbol	Button	Description
Pause for dial tone		The W button is available on the control panel keypad for entering a fax number. This character causes the product to wait for a dial tone before dialing the remainder of the telephone number.
Hook flash		The R button is available on the control panel keypad for entering a fax number. This character causes the product to insert a hook flash.

Set a dialing prefix

A dial prefix is a number or group of numbers that are automatically added to the beginning of every fax number you enter at the control panel or from the software. The maximum number of characters for a dial prefix is 50.

The default setting is **Off**. You might want to turn this setting on and enter a prefix if, for example, you have to dial a number such as 9 to get a telephone line outside of your company telephone system. While this setting is active, you can dial a fax number without the dial prefix by using manual dial.

1. From the Home screen, touch the **Setup**  button.
2. Touch the **Fax Setup** menu.
3. Touch the **Basic Setup** menu.
4. Scroll to and touch the **Dial Prefix** button, and then touch the **On** button.
5. Use the keypad to enter the prefix, and then touch the **Done** button. You can use numbers, pauses, and dialing symbols.

Set tone-dialing or pulse-dialing

Use this procedure to set the product to tone-dialing or pulse-dialing mode. The factory-set default is **Tone Dialing**. Do not change this setting unless you know that the telephone line cannot use tone dialing.

 **NOTE:** The pulse-dialing option is not available in all countries/regions.

1. From the Home screen, touch the **Setup**  button.
2. Touch the **Fax Setup** menu.

3. Touch the **Basic Setup** menu.
4. Scroll to and touch the **Dial Type** button, and then touch the **Tone Dialing** or **Pulse Dialing** button.

Set autore dial and the time between redials

If the product was unable to send a fax because the receiving fax machine did not answer or was busy, the product attempts to redial based on the redial-on-busy, redial-on-no-answer, and redial-on-communication-error options.

Set the redial-on-busy option

If this option is on, the product redials automatically if it receives a busy signal. The factory-set default for the redial-on-busy option is **On**.

1. From the Home screen, touch the **Setup**  button.
2. Touch the **Fax Setup** menu.
3. Touch the **Advanced Fax Setup** menu.
4. Touch the **Redial Setup** button.
5. Scroll to and touch the **Busy Redial** button, and then touch the **On** button.

Set the redial-on-no-answer option

If this option is on, the product redials automatically if the receiving machine does not answer. The factory-set default for the redial-on-no-answer option is **Off**.

1. From the Home screen, touch the **Setup**  button.
2. Touch the **Fax Setup** menu.
3. Touch the **Advanced Fax Setup** menu.
4. Touch the **Redial Setup** button.
5. Scroll to and touch the **No Answer Redial** button, and then touch the **On** button.

Set the redial-on-communication-error option

If this option is on, the product redials automatically if some sort of communication error occurs. The factory-set default for the redial-on-communication-error option is **On**.

 **NOTE:** The redial on communication error functionality is only available with Scan and Fax, Send Fax Later, or Broadcast Fax methods.

1. From the Home screen, touch the **Setup**  button.
2. Touch the **Fax Setup** menu.
3. Touch the **Advanced Fax Setup** menu.

4. Touch the [Redial Setup](#) button
5. Scroll to and touch the [Communication Error Redial](#) button, and then touch the [On](#) button.

Set light/dark and resolution

Set the light/dark setting

This setting affects the lightness and darkness of an outgoing fax as it is being sent.

The default light/dark setting is normally applied to items that are being faxed. The slider is set to the middle as the default setting.

1. From the Home screen, touch the [Fax](#)  button.
2. Touch the [Settings](#) menu.
3. Touch the [Lighter/Darker](#) button, and then touch one of the arrows to adjust the slider.

Set resolution

 **NOTE:** Increasing the resolution increases the fax size. Larger faxes increase the send time and could exceed the available memory in the product.

Use this procedure to change the default resolution for all fax jobs to one of the following settings:

- [Standard](#): This setting provides the lowest quality and the fastest transmission.
- [Fine](#): This setting provides a higher resolution quality than [Standard](#), which is usually appropriate for text documents.
- [Very Fine](#): This setting is best used for documents that mix text and images. The transmission time is slower than the [Fine](#) setting.
- [Photo](#): This setting is best for documents that contain images.

The factory-set default resolution setting is [Fine](#).

Set the default resolution setting

1. From the Home screen, touch the [Fax](#)  button.
2. Touch the [Settings](#) button.
3. Touch the [Resolution](#) button, and then touch one of the options.

Cover-page templates

Several business and personal fax cover-page templates are available in the HP Digital Fax software program.

 **NOTE:** You cannot alter cover-sheet templates, but you can edit the fields within the templates.

Receive-fax settings

Set fax forwarding

You can set your product to forward incoming faxes to another fax number. When the fax arrives at your product, it is stored in the memory. The product then dials the fax number that you have specified and sends the fax. If the product cannot forward a fax because of an error (for example, the number is busy) and repeated redial attempts are unsuccessful, your product prints the fax.

If the product runs out of memory while receiving a fax, it terminates the incoming fax and only forwards the pages and partial pages that have been stored in the memory.

When using the fax-forwarding feature, the product (rather than the computer) must be receiving the faxes, and the answer mode must be set to [Automatic](#).

1. From the Home screen, touch the [Setup](#)  button.
2. Touch the [Fax Setup](#) menu.
3. Touch the [Advanced Fax Setup](#) menu.
4. Touch the Fax forwarding menu.
5. Touch the [Forward Fax](#) button, and touch the [On](#) button.
6. Use the keypad to enter the fax-forwarding number, and then touch the [Done](#) button.

Block or unblock fax numbers

 **NOTE:** Faxing blocking is only supported where the caller ID feature is supported.

If you do not want to receive faxes from specific people or businesses, you can block as many as 30 fax numbers by using the control panel. When you block a fax number and someone from that number sends you a fax, the control-panel display indicates that the number is blocked, the fax does not print, and the fax is not saved in memory. Faxes from blocked fax numbers appear in the fax activity log with a “discarded” designation. You can unblock blocked fax numbers individually or all at one time.

 **NOTE:** The sender of a blocked fax is not notified that the fax failed.

1. From the Home screen, touch the [Setup](#)  button.
2. Touch the [Fax Setup](#) menu.
3. Touch the [Basic Fax Setup](#) menu.
4. Touch the [Block Junk Faxes](#) button.
5. Touch the [Add Numbers](#) button.
6. Use the keypad to enter the fax number that you want to block, and then touch the [Done](#) button.

Set the number of rings-to-answer

When the answer mode is set to [Automatic](#), the product rings-to-answer setting determines the number of times the telephone rings before the product answers an incoming call.

If the product is connected to a telephone line that receives both fax and voice calls (a shared line) and that also uses an answering machine, you might need to adjust the rings-to-answer setting. The number of rings-to-answer for the product must be greater than the rings-to-answer on the answering machine. This allows the answering machine to answer the incoming call and record a message if it is a voice call. When the answering machine answers the call, the product listens to the call and automatically answers it if it detects fax tones.

The default setting for rings-to-answer is five for the U.S. and Canada, and two for other countries/regions.

Use the following table to determine the number of rings-to-answer to use.

Type of telephone line	Recommended rings-to-answer setting
Dedicated fax line (receiving only fax calls)	Set to a number of rings within the range shown on the control-panel display. (The minimum and maximum number of rings allowed varies by country/region.)
One line with two separate numbers and a ring-pattern service	One or two rings. (If you have an answering machine or computer voicemail for the other telephone number, make sure that the product is set to a greater number of rings than the answering system. Also, use the distinctive-ring feature to differentiate between voice and fax calls.)
Shared line (receiving both fax and voice calls) with only an attached telephone	Five rings or more.
Shared line (receiving both fax and voice calls) with an attached answering machine or computer voicemail	Two rings more than the answering machine or computer voicemail.

To set or change the number of rings-to-answer, use the following steps:

1. From the Home screen, touch the [Setup](#)  button.
2. Touch the [Fax Setup](#) menu.
3. Touch the [Basic Fax Setup](#) menu.
4. Touch the [Rings to Answer](#) button.
5. Use the keypad to enter the number of rings, and then touch the [Done](#) button.

Set distinctive ring

Ring-pattern or distinctive-ring service is available through some local telephone companies. The service allows you to have more than one telephone number on a single line. Each telephone number has a unique ring pattern, so that you can answer voice calls and the product can answer fax calls.

If you subscribe to a ring-pattern service with a telephone company, you must set the product to answer the correct ring pattern. Not all countries/regions support unique ring patterns. Contact the telephone company to determine if this service is available in your country/region.

 **NOTE:** If you do not have ring-pattern service and you change the ring-pattern settings to something other than the default, [All Rings](#), the product might not be able to receive faxes.

The settings are as follows:

- **Ring Pattern Detection:** Turn off or on the product's ring pattern detection capability.
- **All Rings:** The product answers any calls that come through the telephone line.
- **Single:** The product answers any calls that produce a single-ring pattern.
- **Double:** The product answers any calls that produce a double-ring pattern.
- **Triple:** The product answers any calls that produce a triple-ring pattern.
- **Double and Triple:** The product answers any calls that produce a double-ring or triple-ring pattern.

To change ring patterns for call answering, complete the following steps:

1. From the Home screen, touch the [Setup](#)  button.
2. Touch the [Fax Setup](#) menu.
3. Touch the [Advanced Fax Setup](#) menu.
4. Touch the [Distinctive Ring](#) button, and then touch the name of an option.

Use autoreduction for incoming faxes

The factory-set default for incoming fax autoreduction is [On](#).

If you have the [Fax Stamping](#) option turned on, you might also want to turn on autoreduction. This reduces the size of the incoming faxes slightly, and prevents the page-stamp from forcing a fax onto two pages.

 **NOTE:** Make sure that the default paper size setting matches the size of the paper in the tray.

1. From the Home screen, touch the [Setup](#)  button.
2. Touch the [Fax Setup](#) menu.
3. Touch the [Advanced Fax Setup](#) menu.
4. Touch the Automatic Reduction button, and then touch the [On](#) button.

Set the fax sounds volume

Control the volume of the fax sounds from the control panel.

Set stamp-received faxes

The product prints the sender identification information at the top of each received fax. You can also stamp the incoming fax with your own header information to confirm the date and time that the fax was received. The factory-set default for stamp-received faxes is **Off**.

 **NOTE:** Turning on the stamp-received setting might increase the page size and cause the product to print a second page.

 **NOTE:** This option applies only to received faxes that the product prints.

1. From the Home screen, touch the **Setup**  button.
2. Touch the **Fax Setup** menu.
3. Touch the **Advanced Fax Setup** menu.
4. Scroll to and touch the **Fax Stamping** button, and then touch the **On** or **Off** button.

Set fax polling

If someone else has set up a fax to be polled (sent on demand), you can request that the fax be sent to your product. (This is known as polling another machine).

1. From the Home screen, touch the **Fax**  button.
2. Touch the **Fax Methods** button.
3. Touch the **Poll to Receive** button.
4. Use the keypad to enter the number of the fax machine that you want to poll, and then touch the **Start Fax** button.

The product dials the other fax machine and requests the fax.

Use fax

Fax software

Supported fax programs

The PC fax program that came with the product is the only PC fax program that works with the product. To continue to use a PC fax program previously installed on the computer, use the modem that is already connected to the computer; it will not function through the product modem.

Cancel a fax

Use these instructions to cancel a single fax that is currently dialing or a fax that is being transmitted or received.

Cancel the current fax

Press the Cancel  button on the control panel if the current job screen has not timed out. You may also go to the status bar and select the job to cancel it after it has timed out.

Cancel a pending fax job

Use this procedure to cancel a fax job in the following situations:

- The product is waiting to redial after encountering a busy signal, an unanswered call, or a communication error.
- The fax is scheduled to be sent at a future time.

Use the following steps to cancel a fax job by using the [Fax Job Status](#) menu:

1. From the Home screen, touch the Fax  button.
2. Touch the [Fax Job Status](#) button.
3. Touch the fax number for the job that you want to cancel.

Use fax on a DSL, PBX, or ISDN system

HP products are designed specifically for use with traditional analog phone services. They are not designed to work on DSL, PBX, ISDN lines, or VoIP services, but they work with the proper setup and equipment.

 **NOTE:** HP recommends discussing DSL, PBX, ISDN, and VoIP setup options with the service provider.

The HP Officejet product is an analog device that is not compatible with all digital phone environments (unless a digital-to-analog converter is used). HP does not guarantee that the product will be compatible with digital environments or digital-to-analog converters.

DSL

A digital subscriber line (DSL) uses digital technology over standard copper telephone wires. This product is not directly compatible with those digital signals. However, if the configuration is specified during DSL setup, the signal can be separated so that some of the bandwidth is used to transmit an analog signal (for voice and fax) while the remaining bandwidth is used to transmit digital data.

 **NOTE:** Not all faxes are compatible with DSL services. HP does not guarantee that the product will be compatible with all DSL service lines or providers.

A typical DSL modem employs a filter to separate the higher frequency DSL modem communication from lower frequency analog phone and fax modem communication. It is often necessary to use a filter with analog phones and analog fax products that are connected to a telephone line used by a DSL modem. The DSL service provider usually provides this filter. Contact the DSL provider for more information or for assistance.

PBX

The product is an analog device that is not compatible in all digital phone environments. Digital-to-analog filters or converters may be needed for faxing functionality. If faxing issues occur in a PBX environment, it might be necessary to contact the PBX provider for assistance. HP does not guarantee that the product will be compatible with digital environments or digital-to-analog converters.

Contact the PBX provider for more information and for assistance.

ISDN

The product is an analog device that is not compatible in all digital phone environments. Digital-to-analog filters or converters may be needed for faxing functionality. If faxing issues occur in an ISDN environment, it might be necessary to contact the ISDN provider for assistance. HP does not guarantee that the product will be compatible with ISDN digital environments or digital-to-analog converters.

Use fax on a VoIP service

Voice over internet protocol (VoIP) services are often not compatible with fax machines unless the provider explicitly states that it supports fax over IP services.

If the product experiences problems getting a fax to work on a VoIP network, verify that all cables and settings are correct. Decreasing the fax-speed setting might allow the product to send a fax over a VoIP network.

If the VoIP provider offers a "Pass through" mode for the connection, that will offer better fax performance on VoIP. Also if the provider has "comfort noise" added to the line, fax performance can be enhanced if this feature is not enabled.

If faxing problems continue, contact the VoIP provider.

Fax memory

Fax memory contents are retained when there is a loss of power

The product's NEND memory protects against data loss when a power failure occurs. NAND RAM can maintain its data for years without power applied.

Delete faxes from memory

Use this procedure if you are concerned that someone else has access to your product and might try to reprint faxes from the memory.

CAUTION: In addition to clearing the reprint memory, this procedure clears any fax that is currently being sent, unsent faxes that are pending redial, faxes that are scheduled to be sent at a future time, and faxes that are not printed or forwarded.

1. From the Home screen, touch the **Setup**  button.
2. Touch the **Fax Setup** menu.
3. Touch the **Fax Tools** Menu
4. Touch the **Clear Fax Log** button.

Send a fax

Fax from the flatbed scanner

NOTE: Only one page (and not multiple pages) can be faxed using the flatbed.

1. Place the document face-down on the scanner glass.



2. From the Home screen, touch the **Fax**  button.
3. Use the keypad to type the fax number.
4. Touch the **Start Black** or **Start Color** button.

Fax from the document feeder

1. Insert the originals into the document feeder face-up.

NOTE: The document feeder capacity is up to 50 sheets of 75 g/m² or 20 lb paper.

CAUTION: To prevent damage to the product, do not use an original that contains correction tape, correction fluid, paper clips, or staples. Also, do not load photographs, small originals, or fragile originals into the document feeder.



2. Adjust the paper guides until they are snug against the paper.



3. From the Home screen, touch the **Fax**  button.
4. Use the keypad to type the fax number.
5. Touch the **Start Black** or **Start Color** button.

Use speed dials and group-dial entries

1. Load the document into the document feeder or onto the scanner glass.



2. From the Home screen, touch the **Fax**  button.
3. On the keypad, touch the Speed-Dial icon.

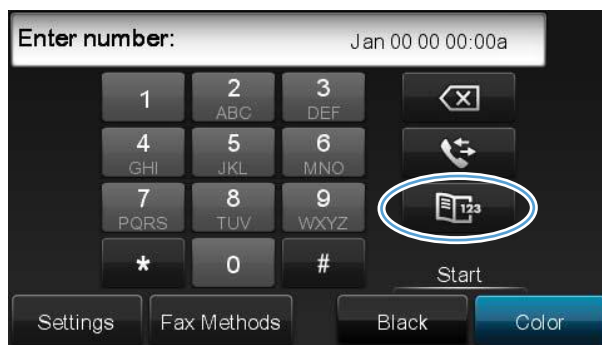

4. Touch the name of the individual or group entry that you want to use.
5. Touch the **Start Black** or **Start Color** button.

Send a standard fax from the computer

You can send a document on your computer as a fax, without printing a copy and faxing it from the printer.

 **NOTE:** Faxes sent from your computer by this method use the printer's fax connection, not your Internet connection or computer modem. Therefore, make sure the printer is connected to a working telephone line and that the fax function is set up and functioning correctly.

To use this feature, you must install the printer software using the installation program provided on the HP software CD provided with the printer.

Windows

1. Open the document on your computer that you want to fax.
2. On the **File** menu in your software application, click **Print**.
3. From the **Name** list, select the printer that has "**fax**" in the name.
4. To change settings (such as Orientation, Page Order, Pages Per Sheet), click the button that opens the **Properties** dialog box. Depending on your software application, this button might be called **Properties**, **Options**, **Printer Setup**, **Printer**, or **Preferences**.
5. After you have changed any settings, click **OK**.
6. Click **Print** or **OK**.
7. Enter the fax number and other information for the recipient, change any further settings for the fax (such as selecting to send the document as a black fax or a color fax), and then click **Send Fax**. The printer begins dialing the fax number and faxing the document.

Mac OS X

1. Open the document on your computer that you want to fax.
2. From the **File** menu in your software application, click **Print**.
3. Select the printer that has "**(Fax)**" in the name.
4. Select **Fax Information** from the pop-up menu.

 **NOTE:** If you cannot find the pop-up menu, try clicking the disclosure triangle next to the **Printer selection**.

5. Enter the fax number and other information in the boxes provided.

 **TIP:** To send a color fax, select **Fax Options** from the pop-up menu, and then click **Color**.

6. Select any other fax options you want, and then click **Fax** to begin dialing the fax number and faxing the document.

Send a fax from the software

The following information provides basic instructions for sending faxes by using the software that came with the product. All other software-related topics are covered in the software Help, which can be opened from the software-program **Help** menu.

You can fax electronic documents from a computer if you meet the following requirements:

- The product is connected directly to the computer or to a network to which the computer is connected.
- The product software is installed on the computer.
- The computer operating system is one that this product supports.

Send a fax from the software

1. Click **Start**, click **Programs** (or **All Programs** in Windows XP), and then click **HP**.
2. Click the product name, and then click **HP Printer Assistant**.
3. Click the **Send a Fax** icon to open the fax software.
4. Load the document onto the scanner glass.
5. Enter a recipient or add one from the address book.
6. Click the **Add Cover Page** button and then click the **Add Scan** button to scan the document on the scanner glass and add it to the fax job.
7. Click the **Send Fax** button to send the fax.

Send a fax by dialing from a telephone connected to the fax line

Occasionally, you might want to dial a fax number from a telephone that is connected to the same line as the product. For example, if you are sending a fax to a person whose device is in the manual receive mode, you can precede the fax with a voice call to let that person know that the fax is coming.

 **NOTE:** The telephone must be connected on the same telephone line as the printer (but through a separate port).

1. Load the document into the document feeder.
2. From the Home screen, touch the **Fax**  button.
3. Pick up the handset of a telephone that is connected to the same line as the product. Dial the fax number by using the telephone keypad.
4. When the recipient answers, instruct the person to start the fax machine.
5. When you hear the fax tones, touch the **Start Fax** button on the control panel, wait until **Connecting** appears on the control panel display, and then hang up the telephone.

Send a fax with confirmation

You can set the product so that it prompts you to enter the fax number a second time to confirm that you are sending the fax to the correct number.

1. From the Home screen, touch the **Setup**  button.
2. Touch the **Fax Setup** menu.
3. Touch the **Advanced Fax Setup** menu.
4. Scroll to and touch the **Fax Confirmation** menu, and then touch the **On** button.
5. Send the fax.

Schedule a fax to be sent later

Use the product control panel to schedule a fax to be sent automatically at a future time to one or more destinations. After you have entered the scheduled time, your document will be scanned into memory and then returns to the Ready state.

 **NOTE:** If the product cannot transmit the fax at the scheduled time, that information is indicated on the fax error report (if that option is turned on) or recorded in the fax activity log. The transmittal might not be initiated because the fax-sending call is not answered, or because a busy signal stops the redial attempts.

If a fax has been scheduled to be sent at a future time but it requires updating, send the additional information as another job. All faxes that are scheduled to go to the same fax number at the same time are delivered as individual faxes.

1. Load the document into the document feeder.



2. From the Home screen, touch the **Fax**  button.
3. Touch the **Fax Methods** button.
4. Touch the **Send Fax Later** button.
5. Use the keypad to enter the time of day to send the fax. Touch the **OK** button.
6. Use the keypad to enter the date to send the fax. Touch the **OK** button.
7. Use the keypad to type the fax number or select one from the phone book/speed-dial list. Touch the **OK** button. The product scans the document and saves the file in memory until the designated time.

Send a fax using monitor dialing

Monitor dialing allows you to dial a number from the printer control panel as you would dial a regular telephone. When you send a fax using monitor dialing, you can hear the dial tones, telephone prompts, or other sounds through the speakers on the printer. This enables you to respond to prompts while dialing, as well as control the pace of your dialing.

 **TIP:** If you are using a calling card and do not enter your PIN fast enough, the printer might start sending fax tones too soon and cause your PIN not to be recognized by the calling card service. If this is the case, you can create a speed dial entry to store the PIN for your calling card.

 **NOTE:** Make sure the volume is turned on to hear a dial tone.

To send a fax using monitor dialing from the printer control panel

1. Load your originals.
2. Touch **Fax**, and then touch **Start Black** or **Start Color**.
If the printer detects an original loaded in the automatic document feeder, you hear a dial tone.
3. When you hear the dial tone, enter the number by using the keypad on the printer control panel.
4. Follow any prompts that might occur.

 **TIP:** If you are using a calling card to send a fax and you have your calling card PIN stored as a speed dial, when prompted to enter your PIN, touch Speed Dial to select the speed dial entry where you have your PIN stored.

Your fax is sent when the receiving fax machine answers.

Use access codes, credit cards, or calling cards

To use access codes, credit cards, or calling cards, dial manually to allow for pauses and dialing codes.

Send faxes internationally

To send a fax to an international destination, dial manually to allow for pauses and international dialing codes.

Receive a fax

Print a fax

The product stores about 2MB of memory. This is ~100 black and white A4 pages at FINE resolution.

These faxes are stored continuously. Reprinting them does not clear them from the memory.

Reprint a fax

1. From the Home screen, touch the **Setup**  button.
2. Touch the **Fax Setup** button.
3. Touch the **Fax Tools** button.
4. Touch the **Reprint Faxes** button.
5. Touch the entry for the fax that you want to reprint.

Receive faxes when fax tones are audible on the phone line

If you have a telephone line that receives both fax and telephone calls, and you hear fax tones when you answer the telephone, you can start the receiving process in one of two ways:

- If you are close to the product, press the **Start Fax** button on the control panel.
- If not, press **1-2-3** in sequence on the telephone keypad, listen for fax transmission sounds, and then hang up.

Solve fax problems

Fax troubleshooting checklist

- Several possible fixes are available. After each recommended action, retry faxing to see if the problem is resolved.
- For best results during fax problem solving, make sure the line from the product is plugged directly into the wall phone port. Disconnect all other devices that are connected to the product.
- 1. Verify that the telephone cord is plugged into the correct port on the back of the product.
- 2. Check the phone line by using the fax test:
 - a. On the control panel, open the **Setup**  menu, and then open the **Fax Setup** menu.
 - b. Select the **Fax Tools** button.
 - c. Select the **Run Fax Test** option. The product prints a fax test report.

The report contains the following possible results:

- **Pass:** The report contains all of the current fax settings for review.
 - **Fail:** The cord is in the wrong port. The report contains suggestions for how to resolve the issue.
 - **Fail :** The phone line is not active. The report contains suggestions for how to resolve the issue.
3. Verify that the product firmware is current:
 - a. Print a configuration page from the control panel **Print Reports** menu to obtain the current firmware date code.
 - b. Go to www.hp.com.
 1. Click the **Support & Drivers** link.
 2. Click the **Download drivers and software (and firmware)** link option.
 3. In the **For product** box, type the product model number, and then click the **Go** button.

4. Click the link for your operating system.
5. Scroll to the Firmware section of the table.
 - If the listed version matches the version on the configuration page, you have the most current version.
 - If the versions are different, download the firmware upgrade and update the firmware on the product following the on-screen instructions.



NOTE: The product must be connected to a computer with internet access to upgrade firmware.

- Resend the fax.

4. Verify that the fax was set up when the product software was installed.

From the computer, in the HP program folder, run the Fax Setup Utility.

5. Verify that the telephone service supports analog fax.
 - If using ISDN or digital PBX, contact your service provider for information about configuring to an analog fax line.
 - If using a VoIP service, change the **Fax Speed** setting to **Slow (9600 bps)** or disable **Fast (33600 bps)** from the control panel. Ask if your service provider supports fax and for the recommended fax modem speed. Some companies might require an adapter.
 - If using a DSL service, ensure that a filter is included on the phone line connection to the product. Contact the DSL service provider or purchase a DSL filter if you do not have one. If a DSL filter is installed, try another since these filters can be defective.
6. If the error persists, find more detailed problem-solving solutions in the sections that follow this one.

Fax error messages

Alert and warning messages appear temporarily and might require you to acknowledge the message by touching the **OK** button to resume or by touching the **Cancel** **X** button to cancel the job. With certain warnings, the job might not complete or the print quality might be affected. If the alert or warning message is related to printing and the auto-continue feature is on, the product will attempt to resume printing the job after the warning has appeared for 10 seconds without acknowledgement.

Communication error.

Description

A fax communication error occurred between the product and the sender or receiver.

Recommended action

Allow the product to retry sending the fax. Unplug the product telephone cord from the wall, plug in a telephone, and try making a call. Plug the product phone cord into a jack for another phone line.

Try a different phone cord.

Set the **Fax Speed** option to the **Slow (9600 bps)** setting or set the fax speed to a lower value.

Turn off the **Error Correction Mode** feature to prevent automatic error correction.



NOTE: Turning off the **Error Correction Mode** feature can reduce image quality.

Print the **Fax Activity Log** report from the control panel to determine if the error occurs with a specific fax number.

If the error persists, contact HP. See www.hp.com/support or the support flyer that came in the product box.

Document feeder door is open. Canceled fax.

Description

The cover at the top of the document feeder is open, and the product cannot send the fax.

Recommended action

Close the cover, and send the fax again.

Fax is busy. Canceled send.

Description

The fax line to which you were sending a fax was busy. The product has canceled sending the fax.

Recommended action

Call the recipient to ensure that the fax machine is on and ready.

Check that you are dialing the correct fax number.

Check that the [Busy Redial](#) option is enabled.

Open the [Service](#) menu, and touch the [Fax Service](#) button. Touch the [Run Fax Test](#) button. This test verifies that the phone cord is connected to the correct port and that the phone line has a signal. The product prints a report with the results.

If the error persists, contact HP. See www.hp.com/support or the support flyer that came in the product box.

Fax is busy. Redial pending.

Description

The fax line to which you were sending a fax was busy. The product automatically redials the busy number.

Recommended action

Allow the product to retry sending the fax.

Call the recipient to ensure that the fax machine is on and ready.

Check that you are dialing the correct fax number.

Open the [Service](#) menu, and touch the [Fax Service](#) button. Touch the [Run Fax Test](#) button. This test verifies that the phone cord is connected to the correct port and that the phone line has a signal. The product prints a report with the results.

If the error persists, contact HP. See www.hp.com/support or the support flyer that came in the product box.

Fax receive error.

Description

An error occurred while trying to receive a fax.

Recommended action

Ask the sender to resend the fax.

Try faxing back to the sender or another fax machine.

Check for a dial tone on the phone line by touching the [Start Fax](#) button.

Check that the telephone cord is securely connected by unplugging and replugging the cord.

Make sure that you are using the telephone cord that came with the product.

Open the [Service](#) menu, and touch the [Fax Service](#) button. Touch the [Run Fax Test](#) button. This test verifies that the phone cord is connected to the correct port and that the phone line has a signal. The product prints a report with the results.

Decrease the fax speed. Ask the sender to resend the fax.

Turn off error-correction mode. Ask the sender to resend the fax.



NOTE: Turning off error-correction mode can reduce the quality of the fax image.

Connect the product to a different phone line.

If the error persists, contact HP. See www.hp.com/support or the support flyer that came in the product box.

Fax Send error.

Description

An error occurred while trying to send a fax.

Recommended action

Try resending the fax.

Try faxing to another fax number.

Check for a dial tone on the phone line by touching the [Start Fax](#) button.

Check that the telephone cord is securely connected by unplugging and replugging the cord.

Make sure that you are using the telephone cord that came with the product.

Make sure that the phone line is working by disconnecting the product, plugging in a telephone to the phone line, and making a voice call.

Connect the product to a different phone line.

Set the fax resolution to [Standard](#) instead of the default of [Fine](#).

If the error persists, contact HP. See www.hp.com/support or the support flyer that came in the product box.

Fax storage is full. Canceling the fax receive.

Description

The amount of available memory for storing faxes is insufficient to store an incoming fax.

Recommended action

If you are using the [Private Receive](#) feature, print all received faxes to regain some memory.

If you still need more memory, clear faxes from memory. Open the [Service](#) menu. In the [Fax Service](#) menu, select the [Clear Fax Log](#) option.

Fax storage is full. Canceling the fax send.

Description

During the fax job, the memory filled. All pages of the fax have to be in memory for a fax job to work correctly. Only the pages that fit into memory were sent.

Recommended action

Cancel the current job. Turn the product off, and then turn it on again. Try sending the job again.

If the error reoccurs, cancel the job and turn the product off and then on a second time. The product might not have enough memory for some jobs.

No dial tone.

Description

The product could not detect a dial tone.

Recommended action

Check for a dial tone on the phone line by touching the [Start Fax](#) button.

Unplug the telephone cord from both the product and the wall and replug the cord.

Make sure that you are using the telephone cord that came with the product.

Unplug the product telephone cord from the wall, plug in a telephone, and try making a voice call.

Make sure that the phone cord from the wall telephone jack is plugged into the line-in port.

Plug the product phone cord into a port for another phone line.

Check the phone line by using the [Run Fax Test](#) option from the [Service](#) menu on the control panel.

If the error persists, contact HP. See www.hp.com/support or the support flyer that came in the product box.



NOTE: This product is not designed to be connected to a digital PBX or VOIP system. Disable Dial Tone Detection and try again.

No fax answer. Canceled send.

Description

Attempts to redial a fax number failed, or the [No Answer Redial](#) option was turned off.

Recommended action

Call the recipient to ensure that the fax machine is on and ready.

Check that you are dialing the correct fax number.

Check that the redial option is enabled.

Unplug the telephone cord from both the product and the wall and replug the cord.

Unplug the product telephone cord from the wall, plug in a telephone, and try making a voice call.

Make sure that the phone cord from the wall telephone jack is plugged into the line-in port.

Plug the product phone cord into a jack for another phone line.

If the error persists, contact HP. See www.hp.com/support or the support flyer that came in the product box.

No fax answer. Redial pending.

Description

The receiving fax line did not answer. The product attempts to redial after a few minutes.

Recommended action

Allow the product to retry sending the fax.

Call the recipient to ensure that the fax machine is on and ready.

Check that you are dialing the correct fax number.

If the product continues to redial, unplug the product telephone cord from the wall, plug in a telephone, and try making a voice call.

Make sure that the phone cord from the wall telephone jack is plugged into the line-in port.

Plug the product phone cord into a jack for another phone line.

Try a different phone cord.

If the error persists, contact HP. See www.hp.com/support or the support flyer that came in the product box.

No fax detected.

Description

The product answered the incoming call but did not detect that a fax machine was calling.

Recommended action

Allow the product to retry receiving the fax.

Try a different phone cord.

Plug the product phone cord into a jack for another phone line.

If the error persists, contact HP. See www.hp.com/support or the support flyer that came in the product box.

Fax logs and reports

Use the following instructions to print fax logs and reports:

Print individual fax reports

1. From the Home screen, touch the **Setup**  button, and then touch the **Print Reports** menu.

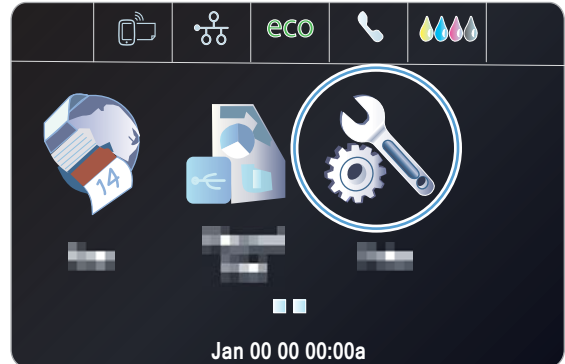



2. Touch the **Fax Reports** menu.
3. Touch the name of the report that you want to print.

Set the fax error report

A fax error report is a brief report that indicates the product experienced a fax job error. You can set it to print after the following events:

- Every fax error (the factory-set default)
- Send fax error
- Receive fax error
- Never

 **NOTE:** With this option, you will have no indication that a fax failed to be transmitted unless you print a fax activity log.

1. From the Home screen, touch the **Fax**  button.

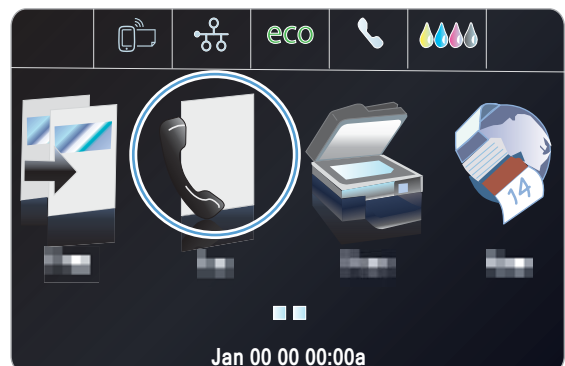

2. Touch the [Setup](#)  button.
3. Touch the [Fax Setup](#) button.
4. Touch the [Advanced Setup](#) button.
5. Touch the [Fax Error Report](#) button, and then touch the printing option that you want to use.

Change error correction and fax speed

Set the fax-error-correction mode

Usually, the product monitors the signals on the telephone line while it is sending or receiving a fax. If the product detects an error during the transmission and the error-correction setting is [On](#), the product can request that the portion of the fax be resent. The factory-set default for error correction is [On](#).

You should turn off error correction only if you are having trouble sending or receiving a fax, and you are willing to accept the errors in the transmission. Turning off the setting might be useful when you are trying to send a fax overseas or receive one from overseas, or if you are using a satellite telephone connection.

1. From the Home screen, touch the [Setup](#)  button.
2. Touch the [Fax Setup](#) menu.
3. Touch the [Advanced Fax Setup](#) menu.
4. Touch the [Error Correction Mode](#) button, and then touch the [On](#) button.

Change the fax speed

The fax-speed setting is the modem protocol that the product uses to send faxes. It is the worldwide standard for full-duplex modems that send and receive data across telephone lines at up to 33,600 bits per second (bps). The factory-set default for the fax-speed setting is [Fast \(33600 bps\)](#).

You should change the setting only if you are having trouble sending a fax to or receiving a fax from a particular device. Decreasing the fax speed might be useful when you are trying to send a fax overseas, or receive one from overseas, or if you are using a satellite telephone connection.

1. From the Home screen, touch the [Setup](#)  button.
2. Touch the [Fax Setup](#) menu.
3. Touch the [Advanced Fax Setup](#) menu.
4. Scroll to and touch the [Fax Speed](#) button, and then touch the speed setting that you want to use.



Solve problems sending faxes

- [An error message displays on the control panel](#)
- [The control panel displays a Ready message with no attempt to send the fax](#)

- [The control panel displays the message "Storing page 1" and does not progress beyond that message](#)
- [Faxes can be received, but not sent](#)
- [Unable to use fax functions from the control panel](#)
- [Unable to use speed dials](#)
- [Unable to use group dials](#)
- [Receive a recorded error message from the phone company when trying to send a fax](#)
- [Unable to send a fax when a phone is connected to the product](#)

An error message displays on the control panel

The Communication error. message appears

- Allow the product to retry sending the fax. Re-sending temporarily reduces the fax speed.
- Unplug the product telephone cord from the wall, plug in a telephone, and try making a call. Plug the product phone cord into a jack for another phone line.
- Try a different phone cord.
- From the control panel, change the **Fax Speed** option to the **Medium (14400 bps)** setting or **Slow (9600 bps)** setting.
 - From the Home screen, touch the **Setup**  button.
 - Open the **Fax Setup** menu.
 - Open the **Advanced Fax Setup** menu.
 - Open the **Fax Speed** menu.
 - Select the correct setting.
- Turn off the **Error Correction Mode** option.
 - From the Home screen, touch the **Setup**  button.
 - Open the **Fax Setup** menu.
 - Open the **Advanced Fax Setup** menu.
 - Open the **Error Correction Mode** menu.
 - Select the **Off** setting.



NOTE: Turning off the **Error Correction Mode** option can reduce image quality.

- If the error persists, contact HP. See www.hp.com/support or the support flyer that came in the product box.

No dial tone.

- Make sure that the telephone cord from the product is plugged directly into the wall telephone jack.
- Check for a dial tone on the phone line by using the [Start Fax](#) button.
- Unplug the product telephone cord from the wall, plug in a telephone, and try making a voice call.
- Unplug the telephone cord from both the product and the wall and replug the cord.
- Make sure that you are using the telephone cord that came with the product.
- Plug the product phone cord into a jack for another phone line.
- Check the phone line by using the [Run Fax Test](#) option from the [Service](#) menu on the control panel.
 - a. From the Home screen, touch the [Setup](#)  button.
 - b. Open the [Fax Setup](#) menu.
 - c. Open the [Fax Tools](#) menu.
 - d. Select the [Run Fax Test](#) item.

The Fax is busy. message appears

- Try sending the fax again.
- Call the recipient to ensure that the fax machine is on and ready.
- Check that you are dialing the correct fax number.
- Check for a dial tone on the phone line by using the [Start Fax](#) button.
- Make sure that the phone is working by disconnecting the product, plugging in a telephone to the phone line, and making a voice call.
- Plug the product phone cord into a jack for another phone line, and try sending the fax again.
- Try a different phone cord.
- Send the fax at a later time.
- If the error persists, contact HP. See www.hp.com/support or the support flyer that came in the product box.

The No fax answer. message appears



- Try to resend the fax.
- Call the recipient to ensure that the fax machine is on and ready.
- Check that you are dialing the correct fax number.

- Unplug the product telephone cord from the wall, plug in a telephone, and try making a voice call.
- Plug the product phone cord into a jack for another phone line.
- Try a different phone cord.
- Make sure that the phone cord from the wall telephone jack is plugged into the line-in port.
- Check the phone line by using the **Run Fax Test** option from the **Fax Setup** menu on the control panel.
 - a.** From the Home screen, touch the **Setup**  button.
 - b.** Open the **Fax Setup** menu.
 - c.** Open the **Fax Tools** menu.
 - d.** Select the **Run Fax Test** item.
- If the error persists, contact HP. See www.hp.com/support or the support flyer that came in the product box.

Document feeder paper jam

- Verify that the paper meets product size requirements. The product does not support pages longer than 381 mm (15 in) for faxing.
- Copy or print the original to letter, A4, or legal size paper, and then resend the fax.

The Fax storage is full. message appears

- Turn the product off then on.
- Print stored faxes that have not been printed.
 - a.** Touch the **Setup**  button, and then touch the **Fax Setup** menu.
 - b.** Open the **Fax Tools** menu.
 - c.** Select the **Reprint Faxes in Memory** item.
- Delete stored faxes from memory.
 - a.** From the Home screen, touch the **Setup**  button.
 - b.** Open the **Fax Setup** menu.
 - c.** Open the **Fax Tools** menu.
 - d.** Select the **Clear Fax Log** item.
- Divide the large fax job into smaller sections, and then fax them individually.

Scanner error

- Verify that the paper meets product size requirements. The product does not support pages longer than 381 mm (15 in) for faxing.
- Copy or print the original onto letter, A4, or legal size paper and then resend the fax.

The control panel displays a Ready message with no attempt to send the fax

- Check the fax activity log for errors.
 - a. Touch the [Setup](#)  button, and then touch the [Print Reports](#) menu.
 - b. Open the [Fax Reports](#) menu.
 - c. Open the [Fax Log](#) menu.
 - d. Select the [Print Log Now](#) option.
- If an extension phone is connected between the product and the wall, make sure that the phone is hung up.
- Connect the product directly into the wall telephone jack and resend the fax.

The control panel displays the message "Storing page 1" and does not progress beyond that message

- Delete stored faxes from memory.
 - a. From the Home screen, touch the [Setup](#)  button.
 - b. Open the [Fax Setup](#) menu.
 - c. Open the [Fax Tools](#) menu.
 - d. Select the [Clear Fax Log](#) item.

Faxes can be received, but not sent

Send fax and nothing happens.

1. Check for a dial tone on the phone line by using the [Start Fax](#) button.
2. Turn the product off then on.
3. Use the control panel or the HP Fax Setup Wizard to configure the fax time, date, and fax header information.
 - a. From the Home screen, touch the [Setup](#)  button.
 - b. Open the [Fax Setup](#) menu.
 - c. Open the [Basic Setup](#) menu.

- d. Open the [Dial Prefix](#) menu.
- e. Select the [On](#) setting.
- Set up all entries in the group with speed dial entries.
 - a. Open an unused speed dial entry.
 - b. Enter the fax number for the speed dial.
 - c. Touch the [OK](#) button to save the speed dial.

Receive a recorded error message from the phone company when trying to send a fax

- Make sure you dial the fax number correctly, and make sure that the phone service is not blocked. For example, some phone services might prevent long distance calling.
- If an outside line requires a prefix, turn on the [Dial Prefix](#) option or include the prefix in the speed dial number.
 - a. From the Home screen, touch the [Setup](#)  button.
 - b. Open the [Fax Setup](#) menu.
 - c. Open the [Basic Fax Setup](#) menu.
 - d. Open the [Dial Prefix](#) menu.
 - e. Select the [On](#) setting.



NOTE: To send a fax without a prefix, when the [Dial Prefix](#) option is turned on, send the fax manually.

- Send a fax to an international number
 - a. If a prefix is required, manually dial the telephone number with the prefix.
 - b. Enter the country/region code before dialing the phone number.
 - c. Wait for pauses as you hear the tones on the phone.
 - d. Send the fax manually from the control panel.

Unable to send a fax when a phone is connected to the product

- Make sure that the telephone is hung up.
- Make sure that an extension telephone on the same line is not being used for a voice call when faxing.
- Unplug the phone from the line, and then try sending the fax.

Solve problems receiving faxes

- [The fax does not respond](#)
- [An error message displays on the control panel](#)
- [A fax is received but does not print](#)
- [Sender receives a busy signal](#)
- [No dial tone](#)
- [Cannot send or receive a fax on a PBX line](#)

The fax does not respond

Voice mail is available on the fax line

- Add a distinctive ring service to your telephone line and change the [Distinctive Ring](#) setting on the product to match the ring pattern supplied by the telephone company. Contact your telephone company for information.
 - a. Verify that the answer mode is set to the [Automatic](#) setting.
 - b. From the Home screen, touch the [Setup](#)  button.
 - c. Open the [Fax Setup](#) menu.
 - d. Open the [Basic Fax Setup](#) menu.
 - e. Open the [Distinctive Ring](#) menu.
 - f. Select the correct setting.
- Buy a dedicated line for faxing.

The product is connected to a DSL phone service

- Check the installation and features. A DSL modem requires a high-pass filter on the phone line connection to the product. Contact your DSL service provider for a filter or buy a filter.
- Verify that the filter is plugged in.
- Replace the existing filter to make sure that it is not defective.

The product uses a fax over IP or VoIP phone service

- Set the [Fax Speed](#) option to the [Slow \(9600 bps\)](#) or [Medium \(14400 bps\)](#) setting, or disable the [Fast \(33600 bps\)](#) setting.
 - a. From the Home screen, touch the [Setup](#)  button.
 - b. Open the [Fax Setup](#) menu.
 - c. Open the [Advanced Fax Setup](#) menu.

- d. Open the [Fax Speed](#) menu.
- e. Select the correct setting.
- Contact your service provider to make sure that fax is supported and for a recommended fax speed settings. Some companies might require an adapter.

An error message displays on the control panel

The **No fax detected.** message appears



NOTE: This error does not always refer to a missed fax. If a voice call is made to a fax number by mistake and the caller hangs up, the **No fax detected.** message appears on the control panel.

- Ask the sender to resend the fax.
- Make sure that the telephone cord from the product is plugged into the wall telephone jack.
- Try a different phone cord.
- Plug the product phone cord into a jack for another phone line.
- Make sure the telephone line and phone wall jack are active by plugging in a telephone and checking for a dial tone.
- Make sure that the telephone cord is plugged into the “line” port on the product.
- Check the phone line by running a fax test from the control panel.
- If the error persists, contact HP. See www.hp.com/support or the support flyer that came in the product box.

The **Communication error.** message appears

- Ask the sender to send the fax again or send at a later time when line conditions have improved.
- Unplug the product telephone cord from the wall, plug in a telephone, and try making a call. Plug the product phone cord into a jack for another phone line.
- Try a different phone cord.
- Set the [Fax Speed](#) option to the [Slow \(9600 bps\)](#) or [Medium \(14400 bps\)](#) setting, or disable the [Fast \(33600 bps\)](#) setting.
 - a. From the Home screen, touch the [Setup](#)  button.
 - b. Open the [Fax Setup](#) menu.
 - c. Open the [Advanced Fax Setup](#) menu.
 - d. Open the [Fax Speed](#) menu.
 - e. Select the correct setting.
- Turn off the [Error Correction Mode](#) feature to prevent automatic error correction.



NOTE: Turning off the [Error Correction Mode](#) feature can reduce image quality.

- a. From the Home screen, touch the [Setup](#)  button.
 - b. Open the [Fax Setup](#) menu.
 - c. Open the [Advanced Fax Setup](#) menu.
 - d. Open the [Error Correction Mode](#) menu.
 - e. Select the [Off](#) setting.
- Print the [Fax Activity Log](#) report from the control panel to determine if the error occurs with a specific fax number.
 - a. Touch the Setup button, and then touch the Reports button.
 - b. Open the [Fax Reports](#) menu.
 - c. Select the [Fax Activity Log](#) item.
 - If the error persists, contact HP. See www.hp.com/support or the support flyer that came in the product box.

The Fax storage is full. message appears

- Turn the product off then on.
- Print all of the faxes, and then have the sender resend the fax.
- Ask the sender to divide a large fax job into smaller sections, and then fax them individually.
- Make sure that the resolution of the sending fax machine is not set to the [Photo](#) setting or the [Superfine](#) setting.
 - a. From the Home screen, touch the [Setup](#)  button.
 - b. Open the [Fax Setup](#) menu.
 - c. Open the [Advanced Fax Setup](#) menu.
 - d. Open the [Resolution](#) menu.
 - e. Select the correct setting.
- Cancel all fax jobs or clear the faxes from memory.

A fax is received but does not print

The Private Receive feature is on

- When the [Private Receive](#) feature is activated, received faxes are stored in memory. A password is required to print the stored faxes.
- Enter the password to print the fax. If you do not know the password, contact the product administrator.



NOTE: Memory errors might occur if the faxes are not printed. The product will not answer if the memory is full.

Sender receives a busy signal

A handset is connected to the product

- Make sure the phone is hung up.
- Change the [Answer Mode](#) option to match the product setup.
 - a. From the Home screen, touch the [Setup](#)  button.
 - b. Open the [Fax Setup](#) menu.
 - c. Open the [Basic Fax Setup](#) menu.
 - d. Open the [Auto Answer](#) menu.
 - e. Select [On](#).

A phone line splitter is being used

- If you are using a phone line splitter, remove the splitter and set up the phone as a downstream phone.
- Make sure the phone is hung up.
- Make sure the phone is not being used for a voice call when faxing.

No dial tone

- If using a phone line splitter, remove the phone line splitter and set up the phone as a downstream phone.

Cannot send or receive a fax on a PBX line

- If you are using a PBX phone line, contact your PBX administrator to configure an analog fax line for your product.

Solve general fax problems

- [Faxes are sending slowly](#)
- [Fax quality is poor](#)
- [Fax cuts off or prints on two pages](#)



Faxes are sending slowly

The product is experiencing poor phone line quality.

- Retry sending the fax when the line conditions have improved.
- Check with the phone service provider that the line supports fax.
- Turn off the [Error Correction Mode](#) setting.
 - a. Open the [Setup](#)  menu.
 - b. Open the [Fax Setup](#) menu.
 - c. Open the [Advanced Fax Setup](#) menu.
 - d. Open the [Error Correction Mode](#) menu.
 - e. Select the [Off](#) setting.





NOTE: This can reduce image quality.

- Use white paper for the original. Do not use colors such as gray, yellow, or pink.
- Increase the [Fax Speed](#) setting.
 - a. Open the [Setup](#)  menu.
 - b. Open the [Fax Setup](#) menu.
 - c. Open the [Advanced Fax Setup](#) menu.
 - d. Open the [Fax Speed](#) menu.
 - e. Select the correct setting.
- Divide large fax jobs into smaller sections, and then fax them individually.
- Change the fax settings on the control panel to a lower resolution.
 - a. From the home screen, touch the [Fax](#)  button.
 - b. Touch the [Settings](#) button.
 - c. Open the [Resolution](#) menu.
 - d. Select the correct setting.

Fax quality is poor

Fax is blurry or light.

- Increase fax resolution when sending faxes. Resolution does not affect received faxes.
 - a. From the home screen, touch the **Fax**  button.
 - b. Touch the **Settings** menu.
 - c. Open the **Resolution** menu.
 - d. Select the correct setting.

 **NOTE:** Increasing resolution slows transmission speed.

- Turn on the **Error Correction Mode** setting from the control panel.
 - a. Open the **Setup**  menu.
 - b. Touch the **Fax Setup** menu.
 - c. Touch the **Advanced Setup** menu.
 - d. Open the **Error Correction Mode** menu.
 - e. Select the **On** setting.
- Check the ink cartridges and replace if necessary.
- Ask the sender to darken the contrast setting on the sending fax machine, and then resend the fax.

Fax cuts off or prints on two pages

- Set the **Default Paper Size** setting. Faxes print on a single size of paper based on the **Default Paper Size** settings.
 - a. Open the **Setup**  menu.
 - b. Touch the **Fax Setup** menu.
 - c. Touch the **Basic Fax Setup** menu.
 - d. Touch the **Fax Paper Size** menu.
 - e. Select the correct setting.
- Set the paper type and size for the tray used for faxes.

 **NOTE:** If the **Default Paper Size** setting is set to letter, a legal size original prints on two pages.

Regulatory information and warranties

For regulatory and warranty information, see the *HP OfficeJet Pro X476 AND X576 MFP Series Warranty and Legal Guide*.

13 Manage and maintain

- [Print information pages](#)
- [Use the HP Embedded Web Server](#)
- [Use HP Web Jetadmin software](#)
- [Product security features](#)
- [Economy settings](#)
- [Clean the product](#)
- [Product updates](#)

Print information pages

Information pages reside within the product memory. These pages help diagnose and solve problems with the product.

 **NOTE:** If the product language was not correctly set during installation, you can set the language manually so the information pages print in one of the supported languages. Change the language by using the [Device Setup](#) menu on the control panel or the HP Embedded Web Server.

1. From the Home screen, touch the [Setup](#)  button.
2. Touch the [Print Reports](#) button.
3. Touch the name of the report that you want to print.

Menu Item	Sub Menu Item	Description
Printer Status Report		Prints the ink cartridge status. Includes the following information: <ul style="list-style-type: none">• Estimated percentage of cartridge life remaining• Approximate pages remaining• Part numbers for HP ink cartridges• Number of pages printed• Information about ordering new HP ink cartridges and recycling used HP ink cartridges
Print Quality Report		Prints a page that helps solve problems with print quality
Usage Page		Shows a count of all paper sizes that have passed through the product; lists whether they were monochrome or color, simplex or duplex, and reports the page count. This report is useful for reconciling contractual billing statements.
Network Configuration Page		Displays status for: <ul style="list-style-type: none">• Network hardware configuration• Enabled features• TCP/IP and SNMP information• Network statistics• Wireless network configuration (wireless models only)
Event Log		Prints a log of errors and other events during product use.
Fax Reports	Fax Confirmation	Sets whether the product prints a confirmation report after a successful fax job.
	Fax Error Report	Sets whether the product prints a report after a failed fax job.
	Last Transaction	Prints a detailed report of the last fax operation, either sent or received.
	Fax Log	The fax service log prints out the last 40 entries in the fax log.
	Speed Dial List	Prints a list of the speed dials that have been set up for this product.
	Caller ID Report	Prints a list of all incoming fax phone numbers

Menu Item	Sub Menu Item	Description
	Junk Fax Report	Prints a list of phone numbers that are blocked from sending faxes to this product.
PCL Font List		Prints a list of all installed PCL fonts
PS Font List		Prints a list of all installed PS fonts
PS Font List		Prints a list of all the PS fonts that are installed

Use the HP Embedded Web Server

This product is equipped with an embedded Web server (EWS), which provides access to information about product and network activities. A Web server provides an environment in which Web programs may run, much in the same way that an operating system, such as Windows, provides an environment for programs to run on a computer. The output from these programs can then be displayed by a Web browser.

An “embedded” Web server resides on a hardware device (such as an HP printer) or in firmware, rather than as software that is loaded on a network server.

The advantage of an EWS is that it provides an interface to the product that anyone with a network-connected product and computer can use. There is no special software to install or configure, but you must have a supported Web browser on the computer. To gain access to the EWS, type the IP address for the product in the address line of the browser.

 **NOTE:** For Macintosh operating systems, you can use the HP EWS over a USB connection after installing the Macintosh software included with the product.

About cookies

The HP EWS places very small text files (cookies) on your hard drive when you are browsing. These files let the HP EWS recognize your computer the next time you visit. For example, if you have configured the HP EWS language, a cookie helps remember which language you have selected so that the next time you access the HP EWS, the pages are displayed in that language. Though some cookies are cleared at the end of each session (such as the cookie that stores the selected language), others (such as the cookie that stores customer-specific preferences) are stored on the computer until you clear them manually.

 **IMPORTANT:** The cookies that the HP EWS stores on your computer are only used for saving settings on your computer or for sharing information between the printer and the computer. These cookies are not sent to any HP Websites.

You can configure your browser to accept all cookies, or you can configure it to alert you every time a cookie is offered, which allows you to decide which cookies to accept or refuse. You can also use your browser to remove unwanted cookies.

Depending on your printer, if you disable cookies, you also disable one or more of the following features:

- Starting where you left the application (especially useful when using setup wizards).
- Remembering the HP EWS browser language setting.
- Personalizing the HP EWS Home page.

For information about how to change your privacy and cookie settings and how to view or delete cookies, see the documentation available with your Web browser.

Open the HP Embedded Web Server

To open the HP Embedded Web Server (HP EWS), type the IP address or host name of the product in the address field of a supported Web browser. To find the IP address, print a Printer Status Report or Network Configuration Page, or get the IP address from the product control panel.

You can also open the HP EWS from the Windows printer driver. Open the **Services** tab and then click the **Device and Supplies Status** icon.

For Mac, the HP EWS can be opened from the HP Utility or from **System Preferences** -> **Print & Scan** -> [product name] -> **Options & Supplies** -> **General** -> **Show Printer Webpage**.

 **NOTE:** If an error occurs while opening the HP EWS, confirm that the proxy settings are correct for your network.

 **TIP:** After you open the URL, bookmark it so that you can return to it quickly in the future.

Features

- [Home tab](#)
- [Scan tab](#)
- [Fax tab](#)
- [Web Services tab](#)
- [Network tab](#)
- [Tools Tab](#)
- [Settings Tab](#)

 **NOTE:** Changing network settings in the HP EWS might disable some of product, or product software or features.

Home tab

Use the **Home** tab to customize various views and tasks related to your device. The **Home** tab includes the following items:

 **NOTE:** Not all of the following items are visible by default. Use the **Personalize this page** button show or hide the items of your choice.

- **Recently Visited:** Displays 5 most recently visited embedded HP EWS links
- **Printer Status:** Displays current printer status.
- **Diagnostic:** Provide links to diagnostic tasks.
- **ePrint:** Displays the status of ePrint connection.
- **Fax Status:** Displays the five most-recent entries in the fax log.
- **Ink Level Status:** Displays ink level status.

- **Manage:** Useful links for managing the HP EWS.
- **Wired Network Status:** Displays wired (802.3) status or wired (802.11) status (wireless models).
- **Setup:** Displays setup options.
- **Custom Shortcut:** Customize quick links to be added as shortcut.
- **Support:** Links to Hewlett-Packard's support Web site.
- **Scan to Computer:** Starts a scan to a computer.

 **NOTE:** Settings for this page are automatically saved in the Web browser's cookies. If the Web browser's cookies are deleted, these settings are lost.

Scan tab

Use the **Scan** tab to configure the product's scan features. The **Scan** tab includes the following items:

- **Scan to Computer:** Use Webscan.

 **IMPORTANT:** For security purposes, Webscan is disabled by default. To enable Webscan, open the **Settings** tab, click on **Administrator Settings**, click the **Enable** checkbox beside Webscan, and then click the **Apply** button.

When Webscan is enabled, anyone with access to the printer can scan whatever is on the scanner glass.

- **Scan to Email**
 - **Scan to Email Setup:** Use this to setup the Scan to Email function.
 - **Outgoing Email Profiles:** Configure the sender of the scanned documents.
 - **Email Address Book:** Configure the list of people to whom you can send the scanned documents.
 - **Email Options:** Configure a default SUBJECT line and body text and configure the default scan settings.
- **Scan to Network Folder**
 - **Network Folder Setup:** Configure a network folder for saving scanned images or documents from the printer.

Fax tab

Use the **Fax** tab to configure the product's fax features. The **fax** tab includes the following items:

- **Fax Setup Wizard:** Configure the printer's fax feature.
- **Basic Fax Settings:** Change the header name/fax number and set other basic fax settings.
- **Advanced Fax Settings:** Set fax details such as Error Reporting, Confirmation, etc.

- **Fax Speed-dial:** Enter and store speed dial numbers.
- **Fax Forwarding:** Automatically redirect incoming faxes to another fax number.
- **Junk Fax Blocker:** Block faxes from specific people or businesses.

Information area:

- **Fax Log:** Contains a list of the faxes that have been sent from or received by this product.

HP Digital Fax area:

- **Digital Fax Profile:** Save incoming black-and-white faxes to a designated folder on the network or forward them as email.

Web Services tab

Use the **HP Web Services** tab to configure and enable HP Web Services for this product. You must enable HP Web Services to use the HP ePrint feature.

Network tab

Use the **Network** tab to configure and secure network settings for the product when it is connected to an IP-based network. This tab does not display if the product is connected to other types of networks.

Tools Tab

Product Information

- **Printer Information:** Find basic device information such as serial number, name and firmware version.
- **Ink Gauge:** See estimated ink levels, ink cartridge part numbers, and estimated printable pages remaining for each cartridge.
- **Ink Settings:** Change the threshold at which the printer provides the "Low on Ink" notification.

Reports

- **Usage Report:** View the number of pages processed for printing, scanning, copying and faxing.
- **Printer Reports:** Print various reports.
- **Event Log:** View logged events such as firmware errors.

Utilities

- **Bookmarking:** Bookmark pages in the HP EWS.
- **Print Quality Toolbox:** Run maintenance tools to improve the print quality of your printouts.
- **Asset Tracking:** Assign an asset number/location to this device.

Backup and Restore

- **Backup:** Create a password-encrypted file that stores the printer's settings.
- **Restore:** Restore the printer's settings using a backup file created by the HP EWS.

Job Management

- **Job Monitor:** Monitor or cancel jobs currently active or pending in the printer.

Printer Restart

- **Power Cycle:** Allows you to turn off and restart the printer.

Settings Tab

Set and maintain various options on your product including power management, date and time, security, printing, and paper settings, email alerts, default copy settings, restore factory defaults and firewall settings.

Use HP Web Jetadmin software

HP Web Jetadmin is an award-winning, industry-leading tool for efficiently managing a wide variety of networked HP devices, including printers, multifunction products, and digital senders. This single solution allows you to remotely install, monitor, maintain, troubleshoot, and secure your printing and imaging environment — ultimately increasing business productivity by helping you save time, control costs, and protect your investment.

HP Web Jetadmin updates are periodically made available to provide support for specific product features. Visit www.hp.com/go/webjetadmin and click the **Self Help and Documentation** link to learn more about updates.

Product security features

Security statements

This product supports security standards and protocols that help secure the product, protect information on your network, and simplify monitoring and maintenance of the product.

For information about HP's secure imaging and printing solutions, visit www.hp.com/go/Secureprinting. The site provides links to white papers and FAQ documents about security features and may include information about additional security features that are not contained in this document.

Assign an administrator password in the HP Embedded Web Server

The HP Embedded Web Server allows you to assign an administrator password so that unauthorized users cannot change product configuration settings in the HP Embedded Web Server. When the admin password is assigned and applied, you must enter the password to make any configuration changes

that are done through the HP Embedded Web Server. If you change an existing password, you must first enter that password. You can also remove the password by entering the existing password and then deleting the assigned password.

Control Panel Lock

The HP Embedded Web Server allows the ability to lock certain features on the product's control panel to prevent unauthorized use. Once the control panel lock is enabled, certain control panel configuration features cannot be changed from the control panel. The control panel lock setting itself can also be secured. This is accomplished by setting the HP Embedded Web Server administrator password. Once the HP Embedded Web Server administrator password is set, the admin password must be entered when accessing the control panel lock enable/disable setting.

Disable unused protocols and services

The HP Embedded Web Server allows the ability to disable unused protocols and services. These protocol and services settings can also be protected from being changed by setting the EWS admin password. These protocols and services include the following:

- **IPv4 and IPv6 disable/enable:** To operate properly on a TCP/IP network, the product must be configured with valid TCP/IP network configuration settings, such as an IP address that is valid for your network. This product supports two versions of this protocol: version 4 (IPv4) and version 6 (IPv6). IPv4 and IPv6 can be enabled/disable individually or simultaneously enabled.
- **Bonjour disable/enable:** Bonjour services are typically used on small networks for IP address and name resolution where conventional a DNS server is not used. The Bonjour service can be enabled or disabled.
- **SNMP disable/enable:** SNMP (Simple Network Management Protocol) is used by network management applications for product management. This product supports the SNMPv1 protocol on IP networks. This product allows the ability to enable/disable SNMPv1.
- **WINS disable/enable:** If you have a Dynamic Host Configuration Protocol (DHCP) service on your network, the product automatically obtains its IP address from that server and registers its name with any RFC 1001 and 1002-compliant dynamic name services as long as the Windows Internet Name Service (WINS) server IP address has been specified. The WINS server IP address configuration can be enable or disabled. If enabled, then the primary and secondary WINS server can be specified.
- **SLP disable/enable:** Service Location Protocol (SLP) is an Internet standard network protocol that provides a framework to allow network applications to discover the existence, location and configuration of networked services in enterprise networks. This protocol can be enabled or disabled.
- **LPD disable/enable:** Line Printer Daemon (LPD) refers to the protocol and programs associated with line-printer spooling services that may be installed on various TCP/IP systems. LPD can be enabled or disabled.
- **LLMNR disable/enable:** Link-Local Multicast Name Resolution (LLMNR) is a protocol based on the Domain Name System (DNS) packet format that allows both IPv4 and IPv6 hosts to perform name resolution for hosts on the same local link. LLMNR can be enabled or disabled.

- **Port 9100 disable/enable:** The product supports raw IP printing through TCP Port 9100. This HP-proprietary TCP/IP port on the product is the default port for printing and it is accessed by HP software. Port 9100 can be enabled or disabled.
- **Web Services disable/enable:** The product supports the ability to enable or disable Microsoft Web Services Dynamic Discovery (WS Discovery) protocols or Microsoft Web Services for Devices (WSD) Print services supported on the product. These web services can be enabled or disabled together or WS Discovery can be enabled separately.
- **Internet Printing Protocol (IPP) disable/enable:** Internet Printing Protocol (IPP) is an Internet-standard protocol that allows you to print documents and manage jobs over the internet. IPP can be disabled or enabled.

Administrator Settings

The HP Embedded Web Server allows the ability to enable and disable certain product capabilities. These include network, Ethernet, wireless, wireless access point (i.e. disables wireless direct capability), USB, fax, fax reprint, copy, digital send, webscan, control panel lock, color fax, color copy, color print from memory devices, all web services, only ePrint, and only Apps. The product must be turned off, and then turned on again, for settings to take effect.

Color Access Control

HP's suite of color access control tools allows you to enable or disable color by individuals users or groups and applications. For more information see www.hp.com/go/upd. The HP Embedded Web Server also allows you to disable color faxing, color copying, and color print from memory devices.

Protected Protocols – HTTPS

The HP Embedded Web Server features the ability to enable encryption of product communication through the HTTPS redirection feature. When used, HTTPS prevents others from viewing information between the EWS and the product via encryption – providing a secure communication method.

Firewall

The HP Embedded Web Server allows the ability to enable and configure product firewall rules, priorities, templates, services and policies. The firewall feature provides a network-layer of security on both IPv4 and IPv6 networks. The firewall configuration capability provides control over IP addresses that are allowed access the product, and the ability to set permissions and priorities for digital send, management, discovery, and print services—providing a more secure way of controlling access to the product.

Scan-to and Fax-to Folder Authentication

The Scan-to and Fax-to network folder allows sending to a network folder via the Windows file sharing mechanism. A username and password may be required to log onto the network where the network folder is located. In addition, appropriate privileges may be required to have write access to the network folder.

Syslog

Support of Syslog, a standard protocol for logging status messages to a designated server, can be used to track the activities and status of devices on the network. The HP Embedded Web Service provides the ability to enable Syslog and to specify the server to which the status messages will be sent. Specifying the priority of those status messages is also supported.

Certificates

The HP Embedded Web Server provides the ability to install and manage certificates for the authentication of product, server and network. This includes the ability to create a certificate, install a certificate, and import and export certificates.

Signed Firmware

Support of digitally-signed firmware updates eliminates exposure to malicious software by preventing the installation of non-approved firmware on the product.

Wireless Authentication

The HP Embedded Web Server provides the ability to configure wireless networking via such 802.1x wireless enterprise authentication protocols as EAP-TLS, LEAP, and PEAP to support access control. The HP Embedded Web Server also provides the ability to configure wireless dynamic key encryption such as WEP encryption and WPA-PSK authentication. In addition, Wireless Direct Authentication can be enabled or disabled.

Economy settings

Print with General Office mode

General Office print mode uses less ink, which might extend the life of the cartridge.

1. On the **File** menu in the software program, click **Print**.
2. Select the product, and then click the **Properties** or **Preferences** button.
3. Click the **Paper/Quality** tab.
4. Select **General Office** from the **Print Quality** drop-down box.

Power handling

The product includes power handling features that can help reduce energy consumption

The Standby and Sleep After Standby modes reduce power consumption when the product has been inactive for an extended period. You can set the length of time before the product enters Standby or Sleep After Standby modes.

The Schedule On/Off feature turns the product on or off after a certain length of time. You can adjust this time-delay setting.

Set Standby

1. From the Home screen, touch the **Setup**  button.
2. Open the following menus:
 - [Device Setup](#)
 - [Power Handling](#)
 - [Standby](#)
3. Select the time for the standby delay.

 **NOTE:** The default value is 10 minutes.

Set Sleep After Standby

1. From the Home screen, touch the [Setup](#)  button.
2. Open the following menus:
 - [Device Setup](#)
 - [Power Handling](#)
 - [Sleep After Standby](#)
3. Select the time for the sleep after standby delay.

 **NOTE:** The default is 2 hours.

Schedule On/Off

1. From the Home screen, touch the [Setup](#)  button.
2. Open the following menus:
 - [Device Setup](#)
 - [Power Handling](#)
 - [Schedule On/Off](#)
3. Enable [Schedule On](#) or [Schedule Off](#) and set the times for those events to take affect.

Clean the product

Clean the printhead

During the printing process, paper, ink, and dust particles can accumulate inside the product. Over time, this buildup can cause print-quality problems such as ink specks or smearing. This product has a cleaning mode that can correct and prevent these types of problems.

Clean the printhead from the product control panel

1. From the Home screen, touch the **Setup**  button.
2. Touch the **Tools** menu.
3. Touch the **Clean Printhead** button.
4. Load plain letter or A4 paper when you are prompted.
5. Touch the **OK** button to begin the cleaning process.

A page feeds through the product slowly. Discard the page when the process is completed.

Clean the scanner glass strip and platen

Over time, specks of debris might collect on the scanner glass and white plastic backing, which can affect performance. Use the following procedure to clean the scanner glass and white plastic backing.

1. Use the power switch to turn off the product, and then unplug the power cord from the electrical socket.
2. Open the scanner lid.

3. Clean the scanner glass and the white plastic backing with a soft cloth or sponge that has been moistened with nonabrasive glass cleaner.



⚠ CAUTION: Do not use abrasives, acetone, benzene, ammonia, ethyl alcohol, or carbon tetrachloride on any part of the product; these can damage the product. Do not place liquids directly on the glass or platen. They might seep and damage the product.

4. Dry the glass and white plastic backing with a chamois or a cellulose sponge to prevent spotting.
5. Plug in the product, and then use the power switch to turn on the product.

Clean the document feeder pickup rollers and separation pad

If the product document feeder experiences paper-handling problems, such as jams or multiple-page feeds, clean the document feeder rollers and separation pad.

1. Open the document feeder cover.

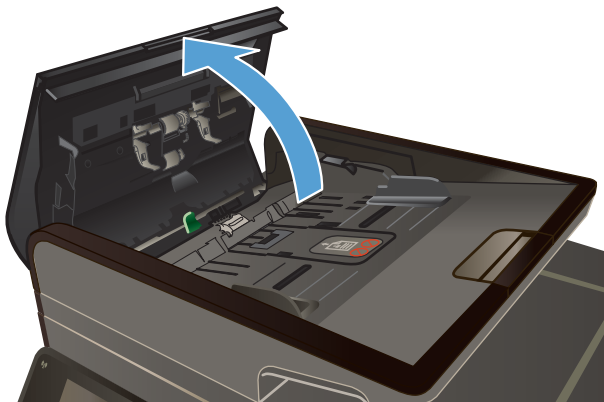

2. Use a moist, lint-free cloth to wipe both pickup rollers and the separation pad to remove dirt.

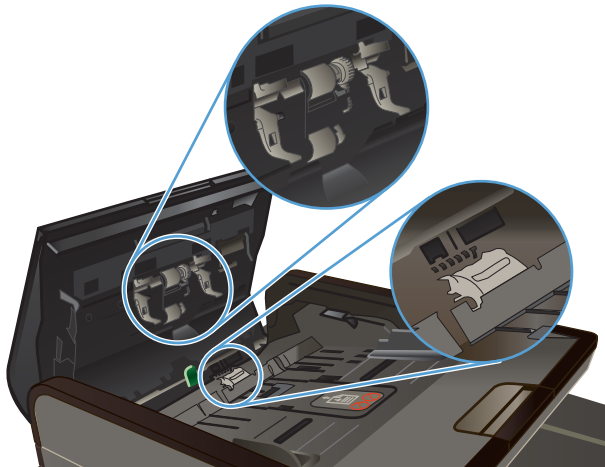

3. Close the document feeder cover.

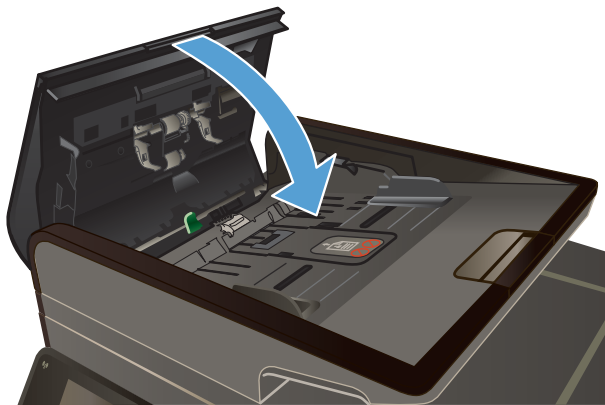

Clean the touch screen

Clean the touch screen whenever it is necessary to remove fingerprints or dust. Wipe the touch screen gently with a clean, water-dampened, lint-free cloth.

⚠ CAUTION: Use water only. Solvents or cleaners can damage the touch screen. Do not pour or spray water directly onto the touch screen.

Product updates

Software and firmware updates and installation instructions for this product are available at www.hp.com/support . Click **Support & Drivers**, click the operating system, and then select the download for the product.

14 Solve problems

- [Customer support](#)
- [Problem-solving checklist](#)
- [Restore the factory-set defaults](#)
- [Paper feeds incorrectly or becomes jammed](#)
- [Clear jams](#)
- [Improve print quality](#)
- [The product does not print or it prints slowly](#)
- [Solve Plug and Print USB Drive printing problems](#)
- [Solve product connectivity problems](#)
- [Solve wireless network problems](#)
- [Solve product software problems with Windows](#)
- [Solve product software problems with Mac](#)

Customer support

Get telephone support, free during your warranty period, for your country/region	Country/region phone numbers are on the flyer that was in the box with your product or at www.hp.com/support/ .
Have the product name, serial number, date of purchase, and problem description ready.	
Get 24-hour Internet product support and troubleshooting and download drivers and software, and electronic information	www.hp.com/support
Get support for products used with a Macintosh computer	www.hp.com/go/macosex
Download software utilities, drivers, and electronic information	http://www.hp.com/go/support
Order additional HP service or maintenance agreements	www.hp.com/go/carepack
Register your product	www.register.hp.com

Problem-solving checklist

Follow these steps when trying to solve a problem with the product.

- [Step 1: Check that the product power is on](#)
- [Step 2: Check the control panel for error messages](#)
- [Step 3: Test print functionality](#)
- [Step 4: Test copy functionality](#)
- [Step 5: Test the fax sending functionality](#)
- [Step 6: Test the fax receiving functionality](#)
- [Step 7: Try sending a print job from a computer](#)
- [Step 8: Test the Plug and Print USB Drive printing functionality](#)
- [Factors that affect product performance](#)

Step 1: Check that the product power is on

1. Make sure the product is plugged in and turned on.
2. Make sure the power cable is connected to the product and the outlet.
3. Check the power source by connecting the power cable to a different outlet.
4. If the product motors do not rotate, make sure the ink cartridges are installed and that the doors are all closed. The control panel displays messages to indicate these problems.
5. If the document feeder motor does not rotate, open the document feeder cover and remove any packing material or shipping tape.
6. If the scanner bulb does not light during copying, scanning, or faxing, contact HP support.

Step 2: Check the control panel for error messages

The control panel should indicate ready status. If an error message appears, resolve the error.

Step 3: Test print functionality

1. From the control panel Home screen, touch the **Setup**  button.
2. Open the **Print Reports** menu, and select the Printer Status Report item to print the report.
3. If the report does not print, make sure paper is loaded in the tray, and check the control panel to see if paper is jammed inside the product.





NOTE: Make sure the paper in the tray meets specifications for this product.

Step 4: Test copy functionality

1. Place the configuration page into the document feeder and make a copy. If paper does not feed smoothly through the document feeder, you might need to clean the document feeder rollers and separation pad. Make sure the paper meets specifications for this product.
2. Place the configuration page onto the scanner glass and make a copy.
3. If the print quality on the copied pages is not acceptable, clean the scanner glass and the small glass strip.

Step 5: Test the fax sending functionality

1. From the control panel Home screen, touch the **Setup**  button.
2. Open the Fax Setup menu, and then open the Fax Tools menu. Touch the **Run Fax Test** button to test the fax functionality.
3. Touch the **Fax**  button on the product control panel, and then touch the **Start Fax** button.

Step 6: Test the fax receiving functionality

1. From the control panel Home screen, touch the **Setup**  button.
2. Touch the **Fax Setup** menu, and then touch the **Fax Tools** menu. Touch the **Run Fax Test** button to test the fax functionality.
3. Use another fax machine to send a fax to the product.
4. Review and reset the product fax settings.

Step 7: Try sending a print job from a computer

1. Use a word-processing program to send a print job to the product.
2. If the job does not print, make sure you selected the correct printer driver.
3. Uninstall and then reinstall the product software.

Step 8: Test the Plug and Print USB Drive printing functionality

1. Load a .PDF document or .JPEG photo onto a USB flash drive, and insert it in the slot on the front of the product.
2. The **USB Print** menu opens. Try printing the document or photo.
3. If no documents are listed, try a different type of USB flash drive.

Factors that affect product performance

Several factors affect the time it takes to print a job:

- The software program that you are using and its settings
- The use of special paper (such as heavy paper and custom-size paper)
- Product processing and download time
- The complexity and size of graphics
- The speed of the computer you are using
- The USB or network connection
- Whether the product is printing in color or in monochrome
- The type of USB drive, if you are using one

Restore the factory-set defaults

⚠ CAUTION: Restoring the factory-set defaults returns all of the product and network settings to the factory defaults, and it also clears the fax header name, phone number, and any stored faxes in the product memory. This procedure also clears the fax phone book, and deletes any pages that are stored in the memory. The procedure then automatically restarts the product.

1. On the product control panel, touch the **Setup**  button.
2. Scroll to and touch the **Tools** menu.
3. Scroll to and touch the **Restore Factory Defaults** button, and then touch the **OK** button.

The product automatically restarts.

Paper feeds incorrectly or becomes jammed

- [The product does not pick up paper](#)
- [The product picks up multiple sheets of paper](#)
- [Prevent paper jams](#)

The product does not pick up paper

If the product does not pick up paper from the tray, try these solutions.

1. Open the product and remove any jammed sheets of paper.
2. Load the tray with the correct size of paper for your job.
3. Make sure the paper guides in the tray are adjusted correctly for the size of paper. Align the guides with the paper-size markings in the bottom of the tray.
4. Remove the stack of paper from the tray and **flex it**, rotate it 180 degrees, and flip it over. *Do not fan the paper.* Return the stack of paper to the tray.
5. Check the product control panel to see if the product is waiting for you to acknowledge a prompt to feed the paper manually through Tray 1, the multi-purpose tray on the left side of the product. Load paper, and continue.

The product picks up multiple sheets of paper

If the product picks up multiple sheets of paper from the tray, try these solutions.

1. Remove the stack of paper from the tray and **flex it**, rotate it 180 degrees, and flip it over. *Do not fan the paper.* Return the stack of paper to the tray.
2. Use only paper that meets HP specifications for this product.
3. Use paper that is not wrinkled, folded, or damaged. If necessary, use paper from a different package. Make sure all paper in the tray is the same type and size.
4. Make sure the tray is not overfilled. If it is, remove the entire stack of paper from the tray, straighten the stack, and then return less paper to the tray.
5. Make sure the paper guides in the tray are adjusted correctly for the size of paper. Align the guides with the paper-size markings in the bottom of the tray.

Prevent paper jams

To reduce the number of paper jams, try these solutions.

1. Use only paper that meets HP specifications for this product. Light-weight, short grain paper is not recommended for use in this product.
2. Use paper that is not wrinkled, folded, or damaged. If necessary, use paper from a different package.

3. Use paper that has not previously been printed or copied on.
4. Make sure the tray is not overfilled. If it is, remove the entire stack of paper from the tray, straighten the stack, and then return some of the paper to the tray.
5. Make sure the paper guides in the tray are adjusted correctly for the size of paper. Adjust the guides so they are touching the paper stack without bending it.
6. Make sure that the tray is fully inserted in the product.
7. If you are printing on heavy, embossed, or perforated paper, use Tray 1, the multi-purpose tray on the left side of the printer, and then feed sheets manually one at a time.

Clear jams

Jam locations

Jams can occur in these locations:

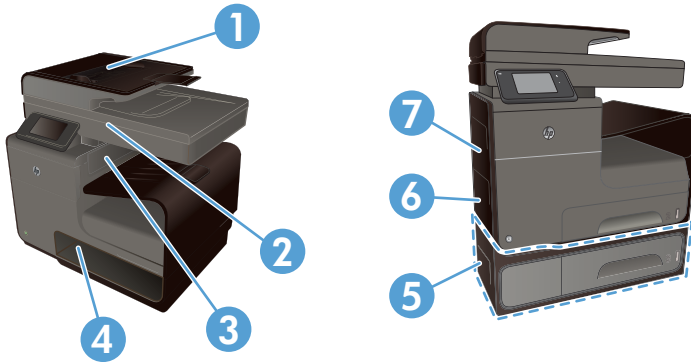

1	Document feeder
2	Scanner
3	Output bin
4	Tray 2
5	Optional Tray 3 and left jam-access door
6	Tray 1
7	Left door

Traces of ink might remain in the product after a jam. This problem typically resolves itself after a few sheets have been printed.

Clear jams from the document feeder

1. Turn the product off.

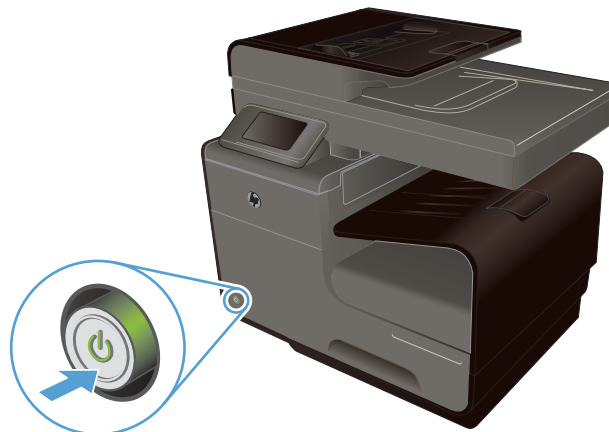

2. Open the document feeder cover.

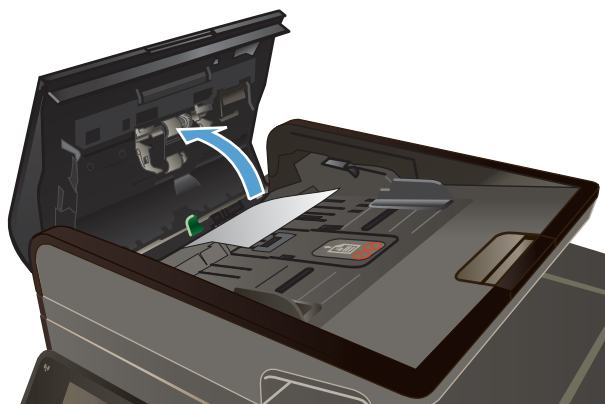

3. Lift the document feeder roller assembly, and gently pull the jammed paper out.



4. Close the document feeder cover.

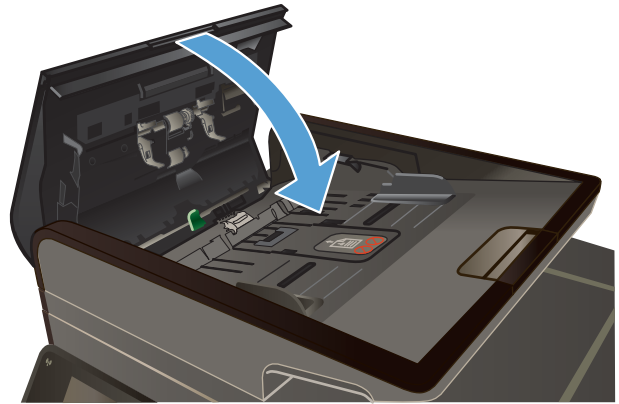

5. Open the scanner lid. If paper is jammed behind the white plastic backing, gently pull it out.

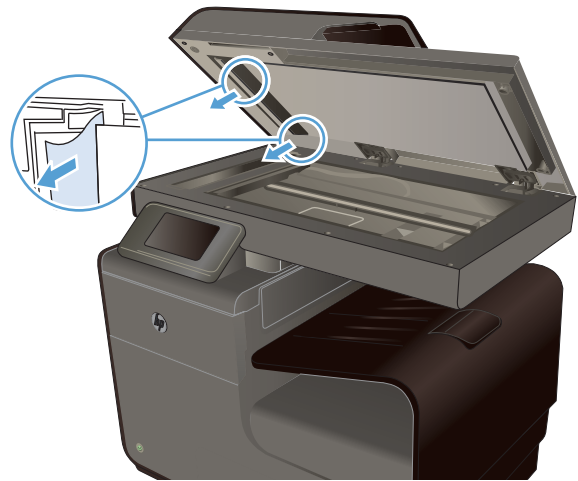

Clear jams in Tray 1 (Multi-purpose tray)

1. If the jammed sheet is visible and easily accessible in Tray 1, pull it from Tray 1.

NOTE: If the sheet tears, make sure that all of the fragments are removed before you resume printing.

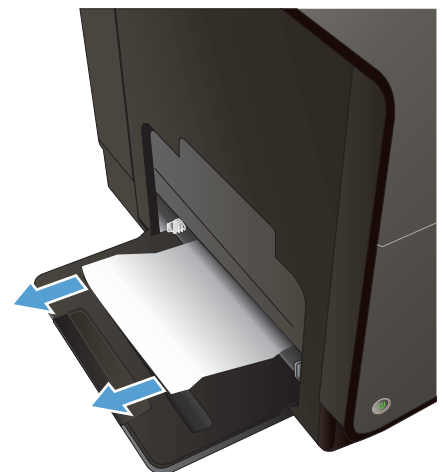

2. The jammed sheet may also be accessible by removing Tray 2 and removing the jammed sheet by pulling it to the right and then out of the product.

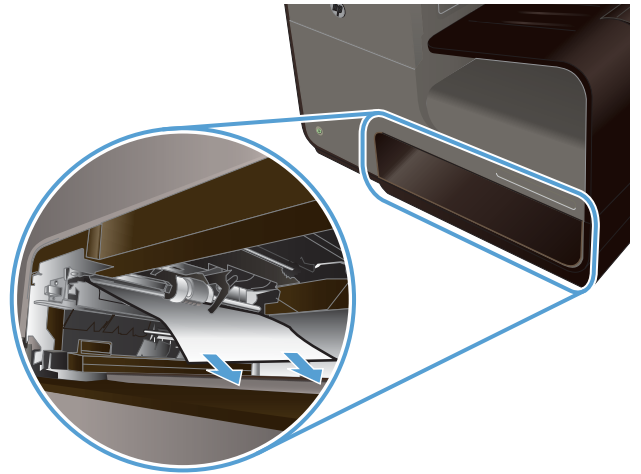

3. If the jammed sheet is not visible or easily accessible in Tray 1, open the left door to access the jammed sheet.

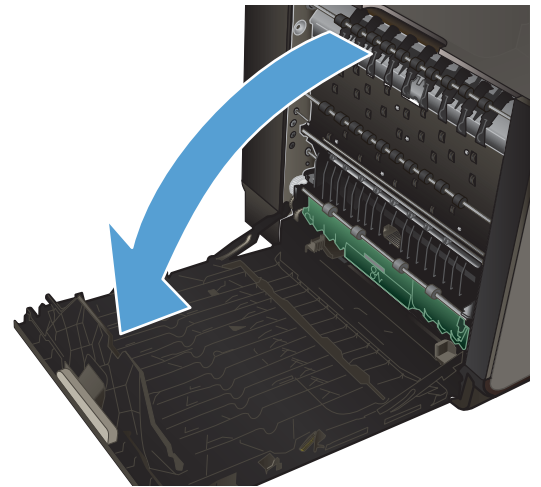

4. If the paper is still not visible or accessible, remove the duplexer by pulling it out with both hands. Set the duplexer aside, upright, on a piece of paper to prevent ink spills.

CAUTION: When pulling out the duplexer, avoid making direct contact with the black cylinder to prevent ink smear on skin or clothes.

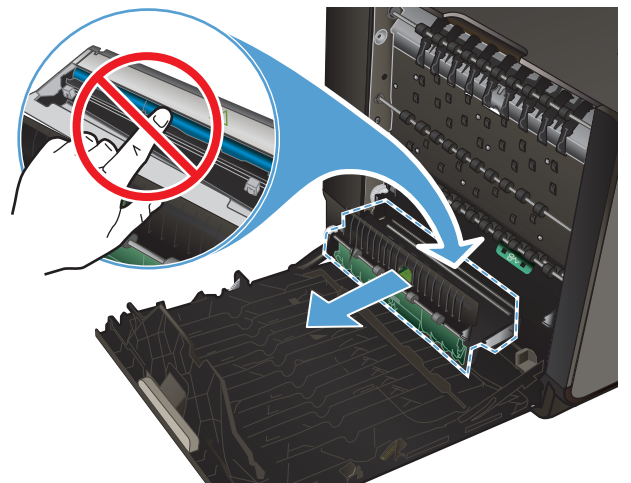

5. Lower the platen by pressing down on the green tab. This will cause the product to try to feed the sheet through the print zone. You may need to gently pull on the sheet if it does not feed. Remove the sheet.

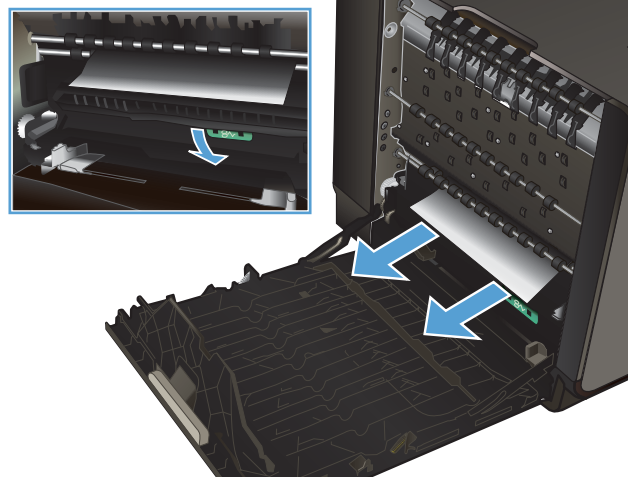

6. Lift the green tab to place the platen back into its operating position.

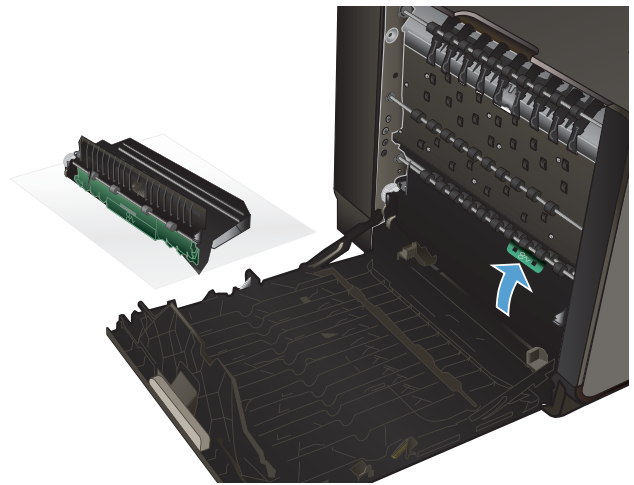

7. Reinstall the duplexer.

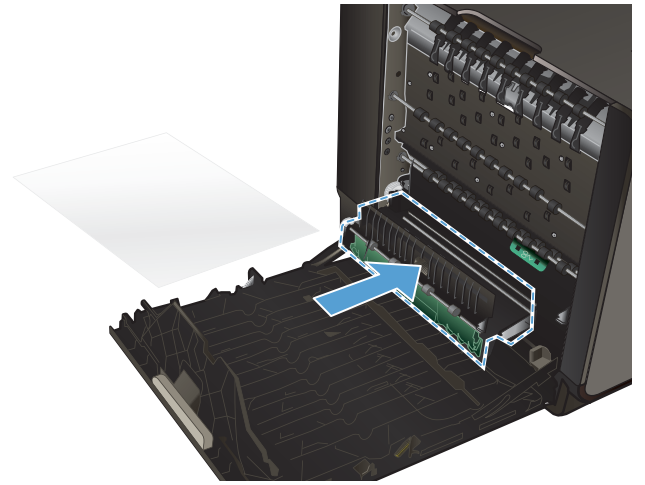

8. Close the left door.

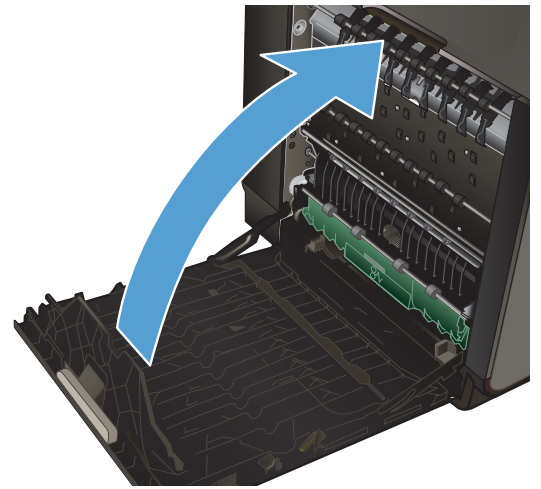

Clear jams in Tray 2

1. Open Tray 2 by pulling it out and releasing the latch at the rear left of the tray.

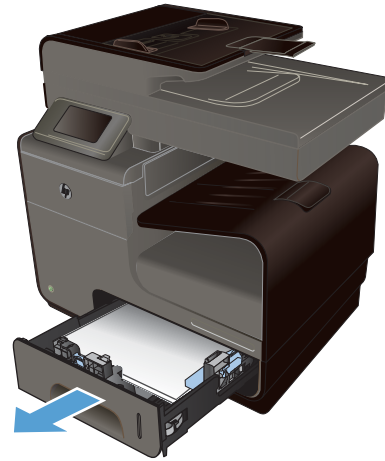

2. Remove the jammed sheet by pulling it to the right and then out of the product.

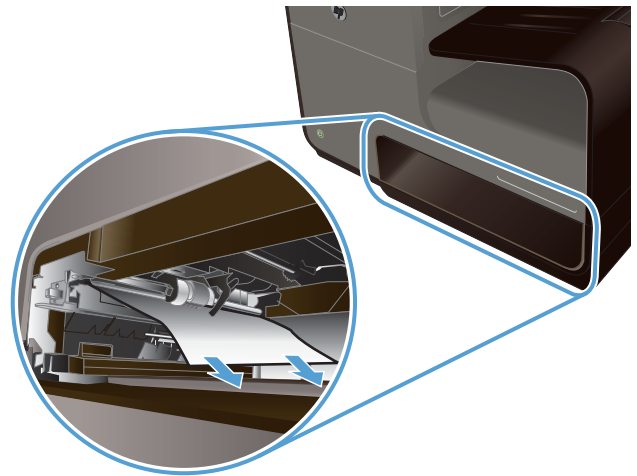

3. Close Tray 2.

NOTE: To close the tray, push in the middle or with even pressure on both sides. Avoid pushing on one side only.

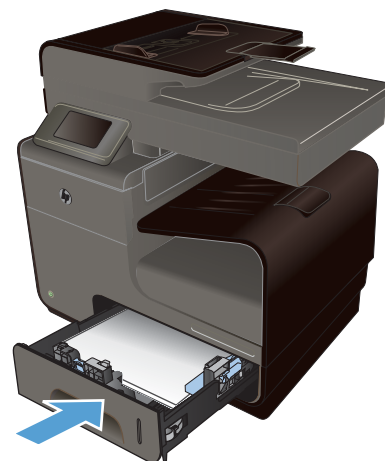

Clear jams in optional Tray 3

1. Open Tray 3.

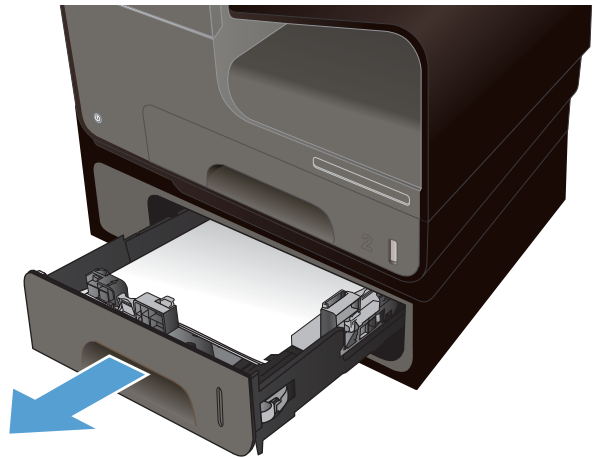

2. Remove the jammed sheet by pulling it to the right and then out of the product.

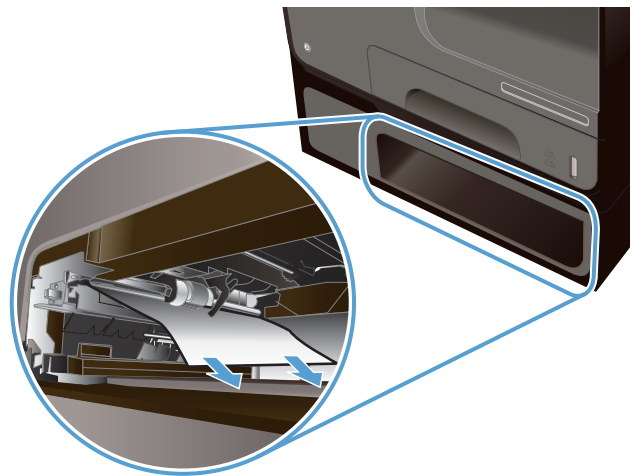

3. If the jam cannot be cleared at the tray, try clearing the jam from the Tray 3 left door.

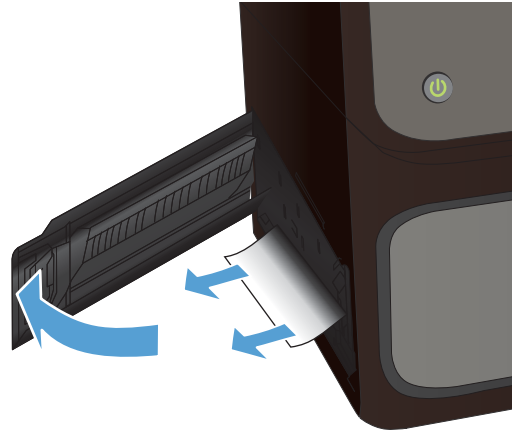

4. Close Tray 3.

NOTE: To close the tray, push in the middle or with even pressure on both sides. Avoid pushing on one side only.

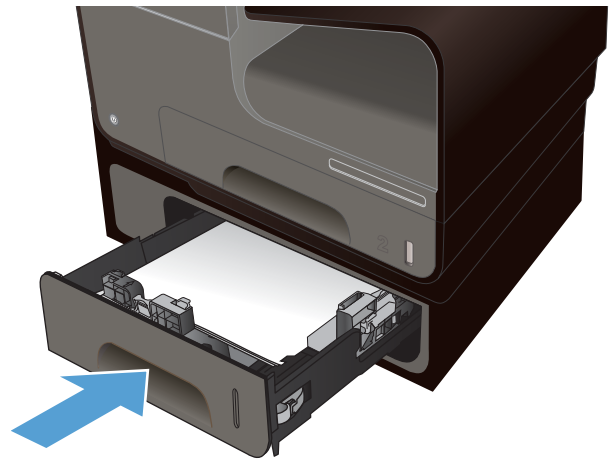

Clear jams in the left door

1. Open the left door.

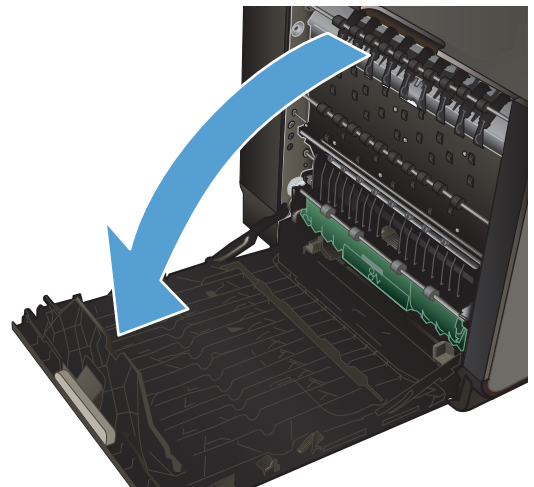

2. Gently remove any visible paper from the rollers and delivery area.

NOTE: If the sheet tears, make sure that all fragments are removed before you resume printing. Do not use sharp objects to remove fragments.

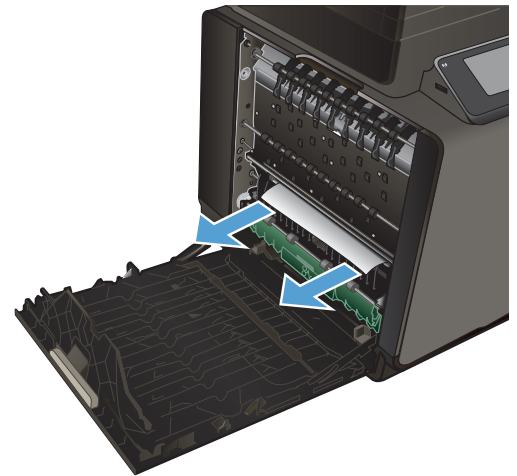

3. Close the left door.

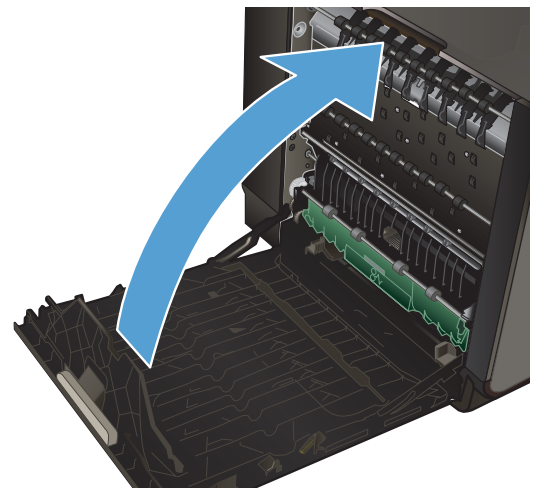

Clear jams in the output bin

1. Look for jammed paper in the output bin area.
2. Remove any visible media.

NOTE: If the sheet tears, make sure that all fragments are removed before resuming printing.



3. Open and then close the left door to clear the message.

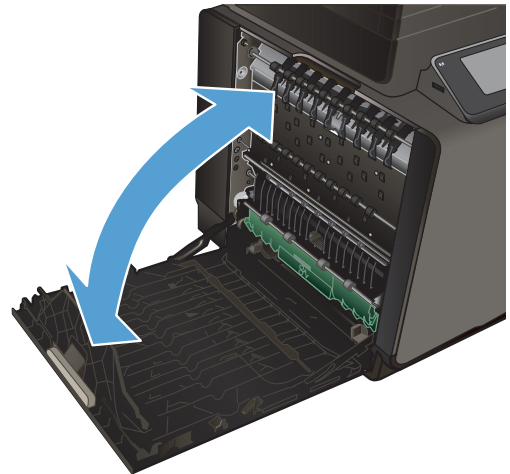

Clear jams in the duplexer

1. Open the left door.

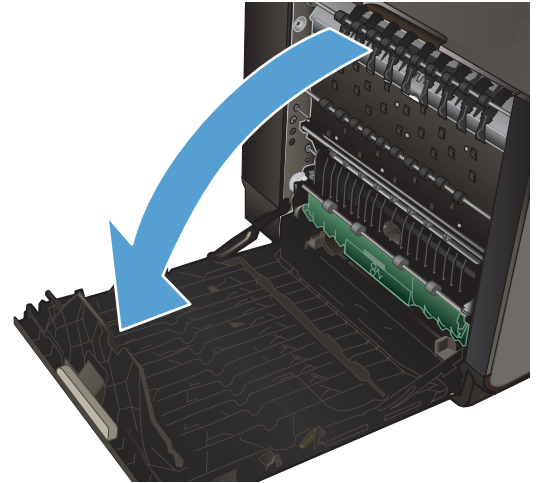

2. If you can see the trailing edge of the sheet, remove the sheet from the product.

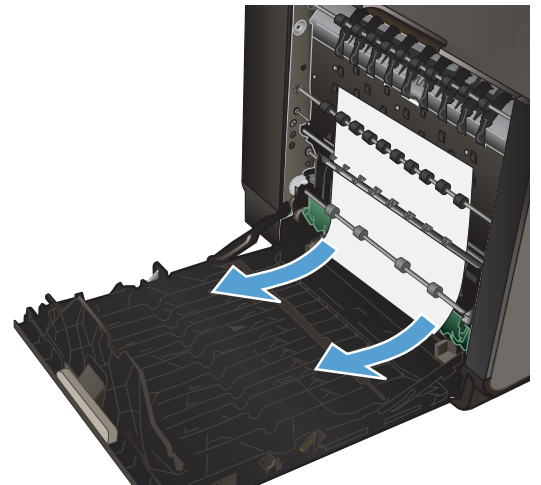

3. If the paper is not visible or accessible, remove the duplexer by pulling it out with both hands. Set the duplexer aside, upright, on a piece of paper to prevent ink spills.

CAUTION: When pulling out the duplexer, avoid making direct contact with the black cylinder to prevent ink smear on skin or clothes.

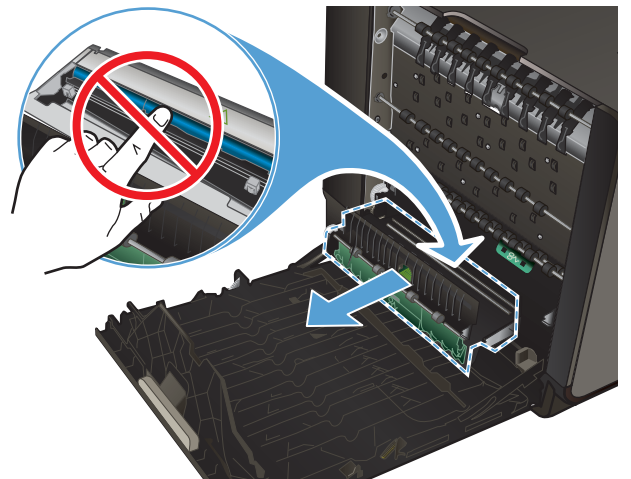

4. Lower the platen by pressing down on the green tab. This will cause the product to try to feed the sheet through the print zone. You may need to gently pull on the sheet if it does not feed. Remove the sheet.

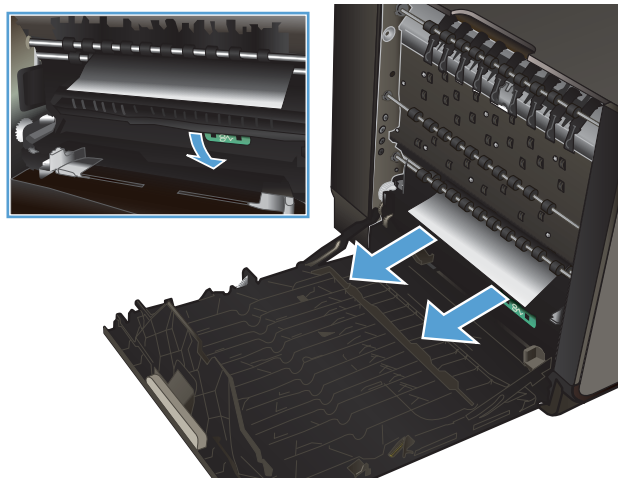

5. Lift the green tab to place the platen back into its operating position.

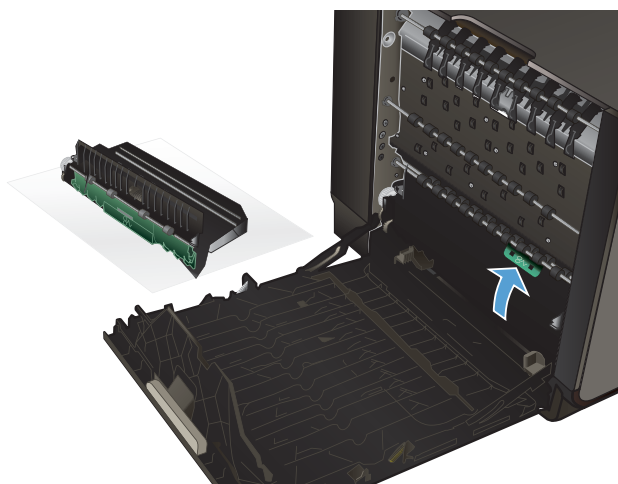

6. Reinstall the duplexer.

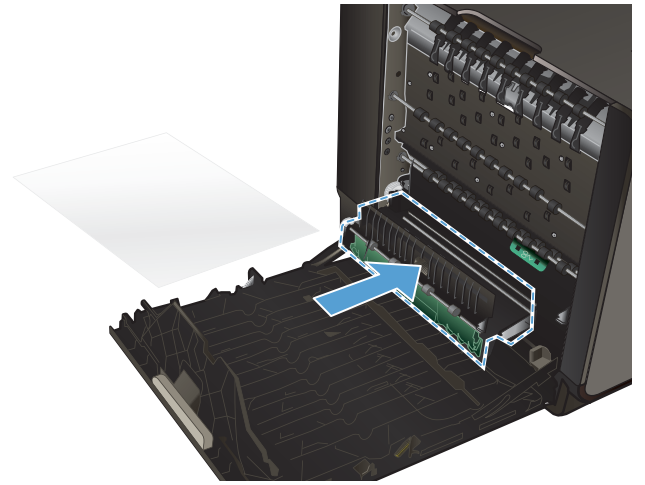

7. Close the left door.

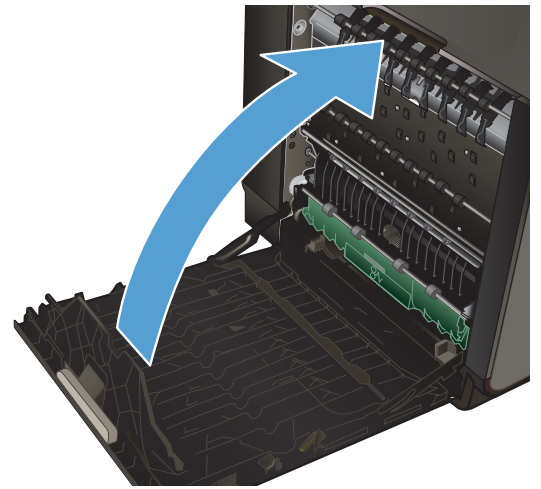

Improve print quality

You can prevent most print-quality problems by following these guidelines.

- [Use the correct paper type setting in the printer driver](#)
- [Adjust color](#)
- [Use paper that meets HP specifications](#)
- [Check the ink cartridges](#)
- [Clean ink smears](#)
- [Clean the printhead](#)
- [Use the printer driver that best meets your printing needs](#)
- [Improve print quality for copies](#)

Use the correct paper type setting in the printer driver

Check the paper type setting if you are having any of the following problems:

- Ink is smearing on the printed pages.
- Repeated marks occur on the printed pages.
- Printed pages are curled.
- Printed pages have small unprinted areas.

Change the paper type and size setting for Windows

1. From a software program that has the **Print** feature available, click on the **File** menu, and then click **Print**.
2. Select the product, and then click the **Properties** or **Preferences** button.
3. Click the **Paper/Quality** tab.
4. From the **Paper type** drop-down list, click the **More...** option.
5. Expand the list of **Type is:** options.
6. Expand each category of paper types until you find the paper type that you are using.
7. Select the option for the type of paper you are using, and click the **OK** button.

Change the paper type and size setting for Mac

1. On the **File** menu in the software program, click the **Print** option.
2. Select a size from the **Paper Size** drop-down list.

3. Open the **Paper/Quality** menu.
4. Select a type from the **Media Type** drop-down list.
5. Click the **Print** button.

Adjust color

Manage color by changing the settings on the **Color** (Windows) and **Color Options** tab (Mac) in the printer driver.

Change the color theme for a print job

1. On the **File** menu in the software program, click **Print**.
2. Click **Properties** or **Preferences** (Windows).
3. Click the **Color** tab (Windows) or **Color Options** tab (Mac) and uncheck HP EasyColor.
4. Select a color theme from the **Color Themes** (Windows) or **RGB Color** (Mac) drop-down list.

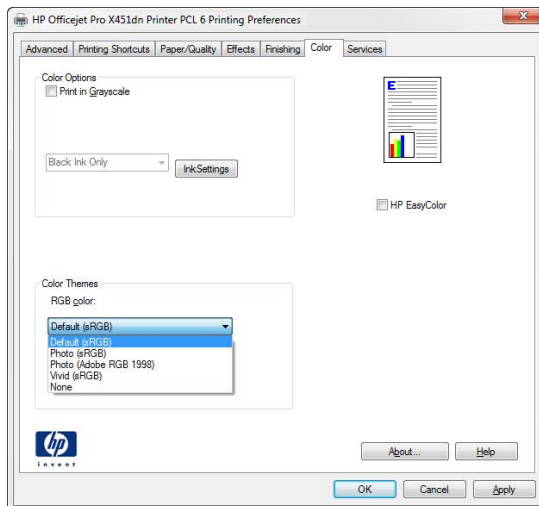

- **Default (sRGB):** This theme sets the product to print RGB data in raw device mode. When using this theme, manage color in the software program or in the operating system for correct rendering.
- **Vivid:** The product increases the color saturation in the midtones. Use this theme when printing business graphics.
- **Photo:** The product interprets RGB color as if it were printed as a photograph using a digital mini lab. The product renders deeper, more saturated colors differently than with the Default (sRGB) theme. Use this theme when printing photos.
- **Photo (Adobe RGB 1998):** Use this theme with printing digital photos that use the AdobeRGB color space rather than sRGB. Turn off color management in the software program when using this theme.
- **None:** No color theme is used.

Change the color options

Change the color options settings for the current print job from the color tab of the printer driver.

1. On the **File** menu in the software program, click the **Print** item.
2. Click **Properties** or **Preferences** (Windows).
3. Click the **Color** tab (Windows) or **Color Options** tab (Mac).
4. Clear the **HP EasyColor** check box.

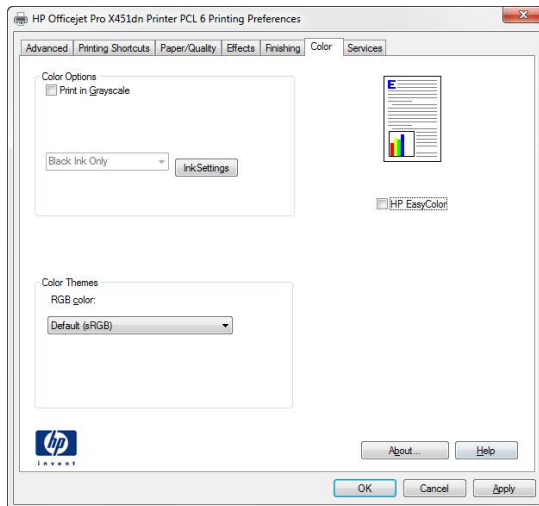

5. Click the **Ink Settings** button (Windows) or expand the **Advanced** menu (Mac), and then use the slider to make the following adjustments:
 - **Dry Time**
 - **Saturation**
 - **Black Ink Spread**

 **NOTE:** Changing color settings manually can impact output. HP recommends that only color graphics experts change these settings.

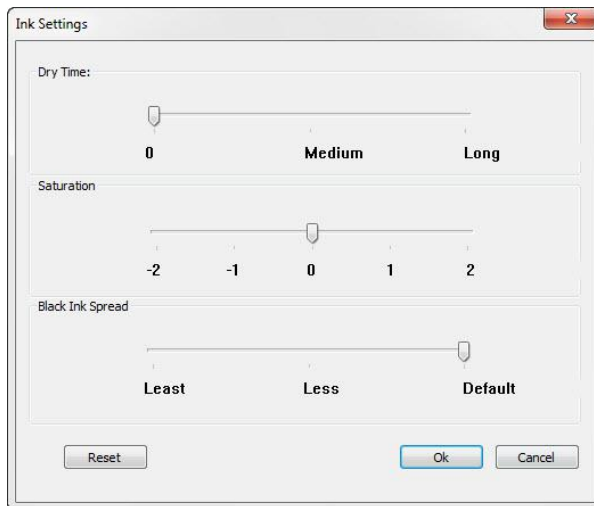

 **NOTE:** Changing color settings manually can impact output. HP recommends that only color graphics experts change these settings.

6. Click **OK** so save your adjustments and close the window, or click **Reset** to return the settings to the factory defaults (Windows).
7. Click the **Print in Grayscale** option (Windows) or **Print Color as Gray** (Mac) to print a color document in black and shades of gray. Use this option to print color documents for photocopying or faxing. You can also use this option to print draft copies or to save color cartridge life.

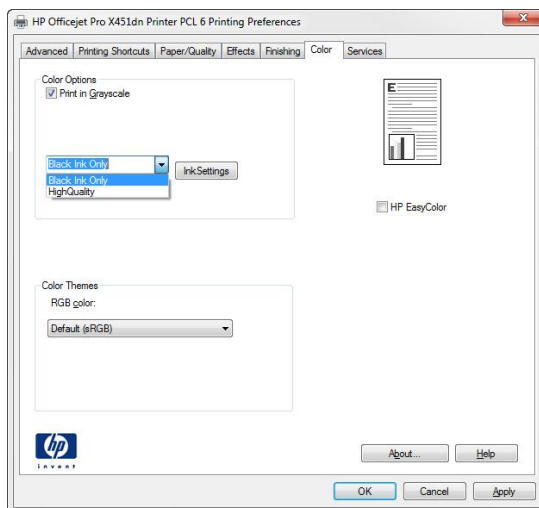

8. Click the **OK** button (Windows).

Use paper that meets HP specifications

Use different paper if you are having any of the following problems:

- The printing is too light or seems faded in areas.
- Specks of ink are on the printed pages.
- Ink is smearing on the printed pages.
- Printed characters seem misformed.
- Printed pages are curled.

Always use a paper type and weight that this product supports. In addition, follow these guidelines when selecting paper:

- Use paper that is of good quality and free of cuts, nicks, tears, spots, loose particles, dust, wrinkles, voids, staples, and curled or bent edges.
- Use paper that has not been previously printed on.
- Use paper that is designed for use in inkjet printers.
- Use paper that is not too rough. Using smoother paper generally results in better print quality.

 **NOTE:** Based on HP internal testing using a range of plain papers, HP highly recommends using papers with the ColorLok® logo for this product. For details, go to <http://www.hp.com/go/printpermanence>.



Check the ink cartridges

Check the ink cartridges by printing a status report, and replace them if necessary, if you are having any of the following problems:

- Printed pages have small unprinted areas.
- Printed pages have streaks or bands.

 **NOTE:** If you are using a draft print setting, the printing might appear light.

If you determine that you need to replace an ink cartridge, look on the cartridge or print the Supplies Status Page to find the part number for the correct genuine HP ink cartridge.

Refilled or remanufactured ink cartridges

Hewlett-Packard Company cannot recommend the use of non-HP supplies, either new or remanufactured. Because they are not HP products, HP cannot influence their design or control their quality. If you are using a refilled or remanufactured ink cartridge and are not satisfied with the print quality, replace the cartridge with a genuine HP cartridge.

 **NOTE:** If you replace a non-HP ink cartridge with a genuine HP ink cartridge, the printhead may still contain non-HP ink until the printhead is depleted of that ink and is supplied with ink from the newly installed, genuine HP ink cartridge.

Interpret the Print Quality Page

1. On the control panel, touch the **Setup**  button.
2. Touch the **Print Reports** menu.
3. Select the **Print Quality Report** item to print it.
4. Follow the instructions on the page that prints.

This page contains four bands of color, which are divided into the groups as indicated in the following illustration. By examining each group, you can isolate the problem to a particular ink cartridge.

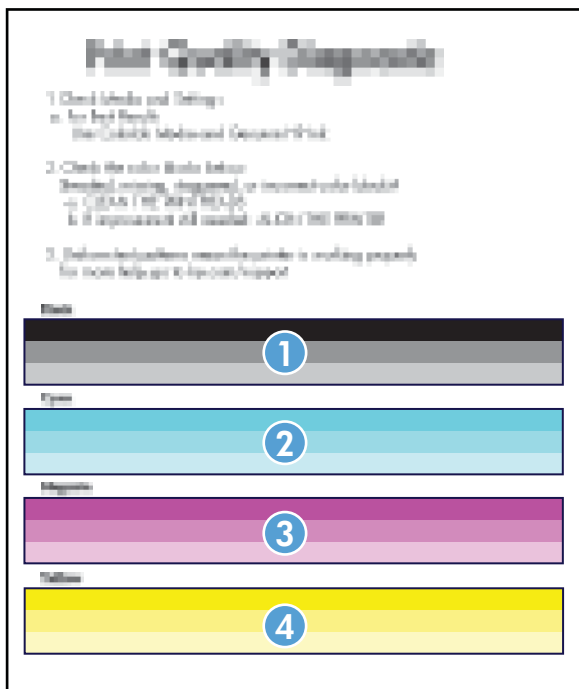

Section	Ink cartridge
1	Black
2	Cyan

Section	Ink cartridge
3	Magenta
4	Yellow

- If dots or streaks appear in one or more groups, clean the printhead. If this does not solve the problem, contact HP.
- If streaks appear in multiple color bands, see if the problem still persists by performing an additional print head cleaning, and then contact HP. A component other than the ink cartridge is probably causing the problem.

Inspect the ink cartridge for damage

1. Remove the ink cartridge from the product, and verify that there is no debris in the cartridge path.
2. Examine the metal connector of the ink cartridge.

⚠ CAUTION: Do not touch the metal connector on the edge of the cartridge. Fingerprints on the metal connector can cause print-quality problems.



3. If you see any scratches, or other damage on the metal connector, replace the ink cartridge.
4. If the metal connector does not appear to be damaged, push the cartridge gently back into its slot until it locks in place. Print a few pages to see if the problem has resolved.

Clean ink smears

Print a cleaning page to remove dust and excess ink from the printhead and paper path if you are having any of the following problems:

- Specks of ink are on the printed pages.
- Ink is smearing on the printed pages.
- Repeated marks occur on the printed pages.

Use the following procedure to clean ink smears.

1. Load plain letter or A4 paper when you are prompted.
2. From the control panel, touch the **Setup**  button.
3. Press or touch the **Tools** menu button.
4. Press or touch the **Clean ink Smear** menu button.
5. Press or touch the **OK** button to begin the cleaning process.

A page feeds through the product slowly. Retain this page for further print quality evaluation.

Clean the printhead

Printhead cleaning can help fix many print quality problems.

Use the following procedure to clean the printhead.

1. Load plain letter or A4 paper.
2. From the control panel, touch the **Setup**  button.
3. Press or touch the **Tools** menu button.
4. Press or touch the **Clean Printhead** menu button.
5. Press or touch the **OK** button to begin the cleaning process.

A page feeds through the product slowly. Retain this page for further print quality evaluation.

6. Follow the steps on the steps on the control panel.

Use the printer driver that best meets your printing needs

You might need to use a different printer driver if the printed page has unexpected lines in graphics, missing text, missing graphics, incorrect formatting, or substituted fonts.

HP PCL 6 driver

- Provided as the default driver. This driver is automatically installed when using the CD.
 - Recommended for all Windows environments.
 - Provides the overall best speed, print quality, and product-feature support for most users.
 - Developed to align with the Windows Graphic Device Interface (GDI) for the best speed in Windows environments.
 - Might not be fully compatible with third-party and custom software programs that are based on PCL 5.
-

HP UPD PS driver

- Recommended for printing with Adobe® software programs or with other highly graphics-intensive software programs.
- Provides support for printing from postscript emulation needs, or for postscript flash font support.
- This driver is available for download at <http://www.hp.com/go/upd>.

HP UPD PCL 5

- Recommended for general office printing in Windows environments.
- Compatible with previous PCL versions and older HP Inkjet products.
- The best choice for printing from third-party or custom software programs.
- The best choice when operating with mixed environments, which require the product to be set to PCL 5 (UNIX, Linux, mainframe).
- Designed for use in corporate Windows environments to provide a single driver for use with multiple printer models.
- Preferred when printing to multiple printer models from a mobile Windows computer.
- This driver is available for download at <http://www.hp.com/go/upd>.

HP UPD PCL 6

- Recommended for printing in all Windows environments.
 - Provides the overall best speed, print quality, and printer feature support for most users.
 - Developed to align with Windows Graphic Device Interface (GDI) for best speed in Windows environments.
 - May not be fully compatible with third-party and custom solutions based on PCL5.
 - This driver is available for download at <http://www.hp.com/go/upd>.
-

Download additional printer drivers from this Web site: <http://www.hp.com/go/support>.

Improve print quality for copies

If you encounter print quality problems in copied documents, review the solutions for printed documents listed previously in this document. However, some print-quality problems occur only in copied documents.

- If streaks appear on copies made by using the document feeder, clean the small glass strip on the left side of the scanner assembly.
- If dots or other defects appear on copies made by using the scanner glass, clean the scanner glass and the white plastic backing.



1. Use the power switch to turn off the product, and then unplug the power cord from the electrical socket.
2. Open the scanner lid.
3. Clean the scanner glass and the white plastic backing with a soft cloth or sponge that has been moistened with nonabrasive glass cleaner.

⚠ CAUTION: Do not use abrasives, acetone, benzene, ammonia, ethyl alcohol, or carbon tetrachloride on any part of the product; these can damage the product. Do not place liquids directly on the glass or platen. They might seep and damage the product.

4. Dry the glass and white plastic backing with a chamois or a cellulose sponge to prevent spotting.
5. Plug in the product, and then use the power switch to turn on the product.

The product does not print or it prints slowly

The product does not print

If the product does not print at all, try the following solutions.

1. Make sure the product is turned on and that the control panel indicates it is ready.
 - If the control panel does not indicate the product is ready, turn the product off and then on again.
 - If the control panel indicates the product is ready, try sending the job again.
2. If the control panel indicates the product has an error, resolve the error and then try to print a test page from the control panel. If the test page prints, there may be a communication problem between the product and the computer you are trying to print from.

3. Make sure the cables are all connected correctly. If the product is connected to a network, check the following items:
 - Check the light next to the network connection on the product. If the network is active, the light is green.
 - Make sure that you are using a network cable and not a phone cord to connect to the network.
 - Make sure the network router, hub, or switch is turned on and that it is working correctly.
4. Install the HP software from the CD that came with the product. Using generic printer drivers can cause delays clearing jobs from the print queue.
5. From the list of printers on your computer, right-click the name of this product, click **Properties**, and open the **Ports** tab.
 - If you are using a network cable to connect to the network, make sure the printer name listed on the **Ports** tab matches the product name on the product configuration page.
 - If you are using a USB cable and are connecting to a wireless network, make sure the box is checked next to **Virtual printer port for USB**.
6. If you are using a personal firewall system on the computer, it might be blocking communication with the product. Try temporarily disabling the firewall to see if it is the source of the problem.
7. If your computer or the product is connected to a wireless network, low signal quality or interference might be delaying print jobs.

The product prints slowly

If the product prints, but it seems slow, try the following solutions.

1. Make sure the computer meets the minimum specifications for this product. For a list of specifications, go to this Web site: www.hp.com/support .
2. If the paper type setting is not correct for the type of paper you are using, change the setting to the correct paper type.
3. If your computer or the product is connected to a wireless network, low signal quality or interference might be delaying print jobs.

Solve Plug and Print USB Drive printing problems

- [The USB Print menu does not open when you insert the USB accessory](#)
- [The file does not print from the USB storage device](#)
- [The file that you want to print is not listed in the USB Print menu](#)

The USB Print menu does not open when you insert the USB accessory

1. You might be using a USB storage device or a file system that this product does not support. Save the files on a standard USB storage device that uses File Allocation Table (FAT) file systems. The product supports FAT12, FAT16, and FAT32 USB storage accessories.
2. If another menu is already open, close that menu and then reinsert the USB storage device.
3. The USB storage device might have multiple partitions. (Some USB storage device manufacturers install software on the accessory that creates partitions, similar to a CD.) Reformat the USB storage device to remove the partitions, or use a different USB storage device.
4. The USB storage device might require more power than the product can provide.
 - a. Remove the USB storage device.
 - b. Turn the product off and then on.
 - c. Use a USB storage device that has its own power supply or that requires less power.
5. The USB storage device might not be functioning correctly.
 - a. Remove the USB storage device.
 - b. Turn the product off and then on.
 - c. Try printing from another USB storage device.

The file does not print from the USB storage device

1. Make sure paper is in the tray.
2. Check the control panel for messages. If paper is jammed in the product, clear the jam.

The file that you want to print is not listed in the USB Print menu

1. You might be trying to print a file type that the USB printing feature does not support. The product supports .PDF, PNG, .JPEG, and PostScript file types.
2. You might have too many files in a single folder on the USB storage accessory. Reduce the number of files in the folder by moving them to subfolders.
3. You might be using a character set for the file name that the product does not support. In this case, the product replaces the file names with characters from a different character set. Rename the files using ASCII characters.

Solve product connectivity problems

Solve USB direct-connect problems

If you have connected the product directly to a computer, check the USB cable.

- Verify that the cable is connected to the computer and to the product.
- Verify that the cable is not longer than 5 m (16.4 ft). Try using a shorter cable.
- Verify that the cable is working correctly by connecting it with another product. Replace the cable if necessary.

Solve network problems

Check the following items to verify that the product is communicating with the network. Before beginning, print a configuration page from the product control panel and locate the product IP address that is listed on this page.

- [Poor physical connection](#)
- [The computer is using the incorrect IP address for the product](#)
- [The computer is unable to communicate with the product](#)
- [The product is using incorrect link and duplex settings for the network](#)
- [New software programs might be causing compatibility problems](#)
- [The computer or workstation might be set up incorrectly](#)
- [The product is disabled, or other network settings are incorrect](#)

Poor physical connection

1. Verify that the product is attached to the correct ethernet port using the proper cable.
2. Verify that cable connections are securely attached.

3. Look at the ethernet port on the back of the product, and verify that the amber activity light and the green link-status light are active.
4. If the problem continues, try a different cable or port on the network router, switch, or hub.

The computer is using the incorrect IP address for the product

1. On the computer, open the printer properties and click the **Ports** tab. Verify that the current IP address for the product is selected. The product IP address is listed on the product configuration page or through the control panel.
2. If you installed the product using an HP standard TCP/IP port, select the box labeled **Always print to this printer, even if its IP address changes.**
3. If you installed the product using a Microsoft standard TCP/IP port, use the hostname instead of the IP address.

If you installed the product using the CD installer, or downloaded the fully-featured installer from the HP's web site, you can view or change the product IP address using the following steps:

- a. Click **Start**.
 - b. Click **All Programs**.
 - c. Click **HP**.
 - d. Click your product.
 - e. Click **Update IP Address** to open a utility that reports the known ("previous") IP address for the product and allows you to change the IP address, if necessary.
4. If the IP address is correct, delete the product entry from the list of installed printers, and then add it again.

The computer is unable to communicate with the product

1. Test network communication by pinging the product.
 - a. Open a command-line prompt on your computer. For Windows, click **Start**, click **Run**, and then type `cmd`.
 - b. Type `ping` followed by the IP address for your product.
 - c. If the window displays round-trip times, both the network and device are working.
2. If the ping command failed, verify that the network router, hubs, or switches are on, and then verify that the network settings, the product, and the computer are all configured for the same network.

The product is using incorrect link and duplex settings for the network

Hewlett-Packard recommends leaving this setting in automatic mode (the default setting). If you change these settings, you must also change them for your network.

New software programs might be causing compatibility problems

Verify that any new software programs are correctly installed and that they use the correct printer driver.

The computer or workstation might be set up incorrectly

1. Check the network drivers, printer drivers, and the network redirection.
2. Verify that the operating system is configured correctly.

The product is disabled, or other network settings are incorrect

1. Review the configuration page to check the status of the network protocol. Enable it if necessary.
2. Reconfigure the network settings if necessary.

Solve wireless network problems

- [Wireless connectivity checklist](#)
- [The control panel displays the message: The wireless feature on this product has been turned off](#)
- [The product does not print after the wireless configuration completes](#)
- [The product does not print, and the computer has a third-party firewall installed](#)
- [The wireless connection does not work after moving the wireless router or product](#)
- [Cannot connect more computers to the wireless product](#)
- [The wireless product loses communication when connected to a VPN](#)
- [The network does not appear in the wireless networks list](#)
- [The wireless network is not functioning](#)

Wireless connectivity checklist

- The product and the wireless router are turned on and have power. Also make sure the wireless radio in the product is turned on.
- The service set identifier (SSID) is correct. Print a configuration page to determine the SSID. If you are not sure the SSID is correct, run the wireless setup again.
- With secured networks, make sure the security information is correct. If the security information is incorrect, run the wireless setup again.
- If the wireless network is working correctly, try accessing other computers on the wireless network. If the network has Internet access, try connecting to the Internet over another wireless connection.
- The encryption method (AES or TKIP) is the same for the product as it is for the wireless access point, such as a wireless router (on networks using WPA security).
- The product is within the range of the wireless network. For most networks, the product must be within 30 m (100 ft) of the wireless access point (wireless router).
- Obstacles do not block the wireless signal. Remove any large metal objects between the access point and the product. Make sure poles, walls, or support columns containing metal or concrete do not separate the product and wireless access point.
- The product is located away from electronic devices that might interfere with the wireless signal. Many devices can interfere with the wireless signal including motors, cordless phones, security system cameras, other wireless networks, and some Bluetooth devices.
- The printer driver is installed on the computer.
- You have selected the correct printer port.
- The computer and product connect to the same wireless network.

The control panel displays the message: The wireless feature on this product has been turned off

1. Touch the **Setup**  button, and then touch the **Wireless Setup** menu.
2. Touch the **Turn Wireless On/Off** button, and then touch the **On** button.

The product does not print after the wireless configuration completes

1. Make sure the product is turned on and in the ready state.
2. Make sure you are connecting to the correct wireless network.
3. Make sure that the wireless network is working correctly.
 - a. On the control panel, touch the **Setup**  button, and then touch the **Network Setup** menu item.
 - b. Select the **Print Wireless Network Test** item to test the wireless network. The product prints a report with the results.
4. Make sure that the correct port or product is selected.
 - a. For printers installed *without* the fully-featured installer:
 1. From the list of printers on your computer, right-click the name of this product, click **Properties**, and then open the **Ports** tab.
 2. Make sure the box is checked next to **Virtual printer port for USB**.
 - b. If you installed the product using the CD installer, or downloaded the fully-featured installer from the HP's web site, you can view or change the product IP address using the following steps:
 - i. Click **Start**.
 - ii. Click **All Programs**.
 - iii. Click **HP**.
 - iv. Click your product.
 - v. Click **Update IP Address** to open a utility that reports the known ("previous") IP address for the product and allows you to change the IP address, if necessary.
5. Make sure that your computer is working correctly. If necessary, restart your computer.

The product does not print, and the computer has a third-party firewall installed

1. Update the firewall with the most recent update available from the manufacturer.
2. If programs request firewall access when you install the product or try to print, make sure you allow the programs to run.
3. Temporarily turn off the firewall, and then install the wireless product on the computer. Enable the firewall when you have completed the wireless installation.

The wireless connection does not work after moving the wireless router or product

Make sure that the router or product connects to the same network that your computer connects to.

1. From the control panel, touch the [Setup](#)  button, and then touch the [Print Reports](#) menu.
2. Select the [Network Configuration Page](#) item to print the report.
3. Compare the service set identifier (SSID) on the configuration report to the SSID in the printer configuration for your computer.
4. If the SSIDs are not the same, the devices are not connecting to the same network. Reconfigure the wireless setup for your product.

Cannot connect more computers to the wireless product

1. Make sure that the other computers are within the wireless range and that no obstacles block the signal. For most networks, the wireless range is within 30 m (100 ft) of the wireless access point.
2. Make sure the product is turned on and in the ready state.
3. Turn off any third-party firewalls on your computer.
4. Make sure that the wireless network is working correctly.
 - a. On the product control panel, touch the [Setup](#)  button, and then touch the [Network Setup](#) menu.
 - b. Touch the [Print Wireless Test Report](#) item to test the wireless network. The product prints a report with the results.

5. Make sure that the correct port or product is selected.
 - a. For printers installed *without* the fully-featured installer:
 1. From the list of printers on your computer, right-click the name of this product, click **Properties**, and then open the **Ports** tab.
 2. Make sure the box is checked next to **Virtual printer port for USB**.
 - b. If you installed the product using the CD installer, or downloaded the fully-featured installer from the HP's web site, you can view or change the product IP address using the following steps:
 - i. Click **Start**.
 - ii. Click **All Programs**.
 - iii. Click **HP**.
 - iv. Click your product.
 - v. Click **Update IP Address** to open a utility that reports the known ("previous") IP address for the product and allows you to change the IP address, if necessary.
6. Make sure that your computer is working correctly. If necessary, restart your computer.

The wireless product loses communication when connected to a VPN

- Typically, you cannot connect to a VPN and other networks at the same time.

The network does not appear in the wireless networks list

- Make sure the wireless router is turned on and has power.
- The network might be hidden. However, you can still connect to a hidden network.

The wireless network is not functioning

1. To verify if the network has lost communication, try connecting other devices to the network.
2. Test network communication by pinging the network.
 - a. Open a command-line prompt on your computer. For Windows, click **Start**, click **Run**, and then type `cmd`.
 - b. Type `ping` followed by the service set identifier (SSID) for your network.
 - c. If the window displays round-trip times, the network is working.
3. Make sure that the router or product connects to the same network that your computer connects to.
 - a. From the product control panel, touch the [Setup](#)  button, and then touch the [Print Reports](#) menu.
 - b. Touch the [Network Configuration Page](#) item to print the report.
 - c. Compare the service set identifier (SSID) on the configuration report to the SSID in the printer configuration for your computer.
 - d. If the SSIDs are not the same, the devices are not connecting to the same network. Reconfigure the wireless setup for your product.

Solve product software problems with Windows

Problem	Solution
A printer driver for the product is not visible in the Printer folder	Reinstall the product software. NOTE: Close any applications that are running. To close an application that has an icon in the system tray, right-click the icon, and select Close or Disable . Try plugging the USB cable into a different USB port on the computer.
An error message was displayed during the software installation	Reinstall the product software. NOTE: Close any applications that are running. To close an application that has an icon in the task bar, right-click the icon, and select Close or Disable . Check the amount of free space on the drive where you are installing the product software. If necessary, free up as much space as you can, and reinstall the product software. If necessary, run the Disk Defragmenter, and reinstall the product software.
The product is in Ready mode, but nothing prints	Print a Configuration page from the product Control Panel, and verify the product functionality. Verify that all of the cables are correctly seated and within specifications. This includes the USB and power cables. Try a new cable. Verify the IP Address on the Configuration Page matches the IP address for the software port. Use one of the following procedures: Windows XP, Windows Server 2003, Windows Server 2008, and Windows Vista, installed without using the fully-featured installer (such as Add Printer Wizard in Windows) <ol style="list-style-type: none">1. Click Start.2. Click Settings.3. Click Printers and Faxes (using the default Start menu view) or click Printers (using the Classic Start menu view).4. Right-click the product driver icon, and then select Properties.5. Click the Ports tab, and then click Configure Port.6. Verify the IP address, and then click OK or Cancel.7. If the IP Addresses are not the same, delete the driver, and reinstall the driver using the correct IP address.

Problem	Solution
Windows 7, installed without using the fully-featured installer (such as Add Printer Wizard in Windows)	<ol style="list-style-type: none"> 1. Click Start. 2. Click Devices and Printers. 3. Right-click the product driver icon, and then select Printer properties. 4. Click the Ports tab, and then click Configure Port. 5. Verify the IP address, and then click OK or Cancel. 6. If the IP Addresses are not the same, delete the driver, and reinstall the driver using the correct IP address.
Windows XP, Windows Server 2003, Windows Server 2008, and Windows Vista, Windows 7, installed using the fully-featured installer	<ol style="list-style-type: none"> 1. Click Start. 2. Click All Programs. 3. Click HP. 4. Click your product. 5. Click Update IP Address to open a utility that reports the known ("previous") IP address for the product and allows you to change the IP address, if necessary.

Solve product software problems with Mac

- [The printer driver is not listed in the Print & Scan list](#)
- [The product name does not appear in the product list in the Print & Scan list](#)
- [The printer driver does not automatically set up the selected product in the Print & Scan list](#)
- [A print job was not sent to the product that you wanted](#)
- [When connected with a USB cable, the product does not appear in the Print & Scan list after the driver is selected.](#)
- [You are using a generic printer driver when using a USB connection](#)

The printer driver is not listed in the Print & Scan list

1. Make sure that the product .GZ file is in the following hard-drive folder: `Library/Printers/PPDs/Contents/Resources`. If necessary, reinstall the software.
2. If the GZ file is in the folder, the PPD file might be corrupt. Delete the file and then reinstall the software.

The product name does not appear in the product list in the Print & Scan list

1. Make sure that the cables are connected correctly and the product is on.
2. Print a configuration page to check the product name. Verify that the name on the configuration page matches the product name in the Print & Scan list.
3. Replace the USB or ethernet cable with a high-quality cable.

The printer driver does not automatically set up the selected product in the Print & Scan list

1. Make sure that the cables are connected correctly and the product is on.
2. Make sure that the product .GZ file is in the following hard-drive folder: `Library/Printers/PPDs/Contents/Resources`. If necessary, reinstall the software.
3. If the GZ file is in the folder, the PPD file might be corrupt. Delete the file and then reinstall the software.
4. Replace the USB or ethernet cable with a high-quality cable.

A print job was not sent to the product that you wanted

1. Open the print queue and restart the print job.
2. Another product with the same or similar name might have received your print job. Print a configuration page to check the product name. Verify that the name on the configuration page matches the product name in the Print & Scan list.

When connected with a USB cable, the product does not appear in the Print & Scan list after the driver is selected.

Software troubleshooting

- ▲ Make sure that your Mac operating system is Mac OS X 10.6 or later.

Hardware troubleshooting

1. Make sure that the product is turned on.
2. Make sure that the USB cable is connected correctly.
3. Make sure that you are using the appropriate high-speed USB cable.
4. Make sure that you do not have too many USB devices drawing power from the chain. Disconnect all of the devices from the chain, and connect the cable directly to the USB port on the computer.
5. Check to see if more than two non-powered USB hubs are connected in a row on the chain. Disconnect all of the devices from the chain, and then connect the cable directly to the USB port on the computer.

 **NOTE:** The iMac keyboard is a non-powered USB hub.

You are using a generic printer driver when using a USB connection

If you connected the USB cable before you installed the software, you might be using a generic printer driver instead of the driver for this product.

1. Delete the generic printer driver.
2. Reinstall the software from the product CD. Do not connect the USB cable until the software installation program prompts you.
3. If multiple printers are installed, make sure that you have selected the correct printer in the **Format For** drop-down menu in the **Print** dialog box.

A Supplies and accessories

- [Order parts, accessories, and supplies](#)
- [Part numbers](#)

Order parts, accessories, and supplies

Order supplies and paper	www.hp.com/go/suresupply
Order genuine HP parts or accessories	www.hp.com/buy/parts
Order through service or support providers	Contact an HP-authorized service or support provider.

Part numbers

Item	Part number	Cartridge number	Description
Ink cartridges	CN621A	HP 970	Standard-capacity black ink cartridge with HP Officejet pigment ink
	CN625A	HP 970XL	High-capacity black ink cartridge with HP Officejet pigment ink
	CN622A	HP 971	Standard-capacity cyan ink cartridge with HP Officejet pigment ink
	CN626A	HP 971XL	High-capacity cyan ink cartridge with HP Officejet pigment ink
	CN624A	HP 971	Standard-capacity yellow ink cartridge with HP Officejet pigment ink
	CN628A	HP 971XL	High-capacity yellow ink cartridge with HP Officejet pigment ink
	CN623A	HP 971	Standard-capacity magenta ink cartridge with HP Officejet pigment ink
	CN627A	HP 971XL	High-capacity magenta ink cartridge with HP Officejet pigment ink
Paper-handling accessories	CN595A		500-sheet paper feeder (optional Tray 3)
USB cable	8121-0868		2-meter A-to-B cable



NOTE: For information about the yield for the cartridges, see www.hp.com/go/pageyield. Actual yield depends on specific use.

Some ink cartridges may not be available in all regions.

B Service and support

- [Hewlett-Packard limited warranty statement](#)
- [End User License Agreement](#)
- [OpenSSL](#)
- [Customer support](#)

Hewlett-Packard limited warranty statement

HP PRODUCT	DURATION OF LIMITED WARRANTY
HP Officejet Pro X476dn, X476dw, X576dw	1 year

HP warrants to you, the end-user customer, that HP hardware and accessories will be free from defects in materials and workmanship after the date of purchase, for the period specified above. If HP receives notice of such defects during the warranty period, HP will, at its option, either repair or replace products which prove to be defective. Replacement products may be either new or equivalent in performance to new.

HP warrants to you that HP software will not fail to execute its programming instructions after the date of purchase, for the period specified above, due to defects in material and workmanship when properly installed and used. If HP receives notice of such defects during the warranty period, HP will replace software which does not execute its programming instructions due to such defects.

HP does not warrant that the operation of HP products will be uninterrupted or error free. If HP is unable, within a reasonable time, to repair or replace any product to a condition as warranted, you will be entitled to a refund of the purchase price upon prompt return of the product.

HP products may contain remanufactured parts equivalent to new in performance or may have been subject to incidental use.

Warranty does not apply to defects resulting from (a) improper or inadequate maintenance or calibration, (b) software, interfacing, parts or supplies not supplied by HP, (c) unauthorized modification or misuse, (d) operation outside of the published environmental specifications for the product, or (e) improper site preparation or maintenance.

TO THE EXTENT ALLOWED BY LOCAL LAW, THE ABOVE WARRANTIES ARE EXCLUSIVE AND NO OTHER WARRANTY OR CONDITION, WHETHER WRITTEN OR ORAL, IS EXPRESSED OR IMPLIED AND HP SPECIFICALLY DISCLAIMS ANY IMPLIED WARRANTIES OR CONDITIONS OF MERCHANTABILITY, SATISFACTORY QUALITY, AND FITNESS FOR A PARTICULAR PURPOSE. Some countries/regions, states or provinces do not allow limitations on the duration of an implied warranty, so the above limitation or exclusion might not apply to you. This warranty gives you specific legal rights and you might also have other rights that vary from country/region to country/region, state to state, or province to province.

HP's limited warranty is valid in any country/region or locality where HP has a support presence for this product and where HP has marketed this product. The level of warranty service you receive may vary according to local standards. HP will not alter form, fit or function of the product to make it operate in a country/region for which it was never intended to function for legal or regulatory reasons.

TO THE EXTENT ALLOWED BY LOCAL LAW, THE REMEDIES IN THIS WARRANTY STATEMENT ARE YOUR SOLE AND EXCLUSIVE REMEDIES. EXCEPT AS INDICATED ABOVE, IN NO EVENT WILL HP OR ITS SUPPLIERS BE LIABLE FOR LOSS OF DATA OR FOR DIRECT, SPECIAL, INCIDENTAL, CONSEQUENTIAL (INCLUDING LOST PROFIT OR DATA), OR OTHER DAMAGE, WHETHER BASED IN CONTRACT, TORT, OR OTHERWISE. Some countries/regions, states or provinces do not allow the exclusion or limitation of incidental or consequential damages, so the above limitation or exclusion may not apply to you.

THE WARRANTY TERMS CONTAINED IN THIS STATEMENT, EXCEPT TO THE EXTENT LAWFULLY PERMITTED, DO NOT EXCLUDE, RESTRICT OR MODIFY AND ARE IN ADDITION TO THE MANDATORY STATUTORY RIGHTS APPLICABLE TO THE SALE OF THIS PRODUCT TO YOU.

End User License Agreement

PLEASE READ CAREFULLY BEFORE USING THIS SOFTWARE PRODUCT: This End-User License Agreement (“EULA”) is a contract between (a) you (either an individual or the entity you represent) and (b) Hewlett-Packard Company (“HP”) that governs your use of the software product (“Software”). This EULA does not apply if there is a separate license agreement between you and HP or its suppliers for the Software, including a license agreement in online documentation. The term “Software” may include (i) associated media, (ii) a user guide and other printed materials, and (iii) “online” or electronic documentation (collectively “User Documentation”).

RIGHTS IN THE SOFTWARE ARE OFFERED ONLY ON THE CONDITION THAT YOU AGREE TO ALL TERMS AND CONDITIONS OF THIS EULA. BY INSTALLING, COPYING, DOWNLOADING, OR OTHERWISE USING THE SOFTWARE, YOU AGREE TO BE BOUND BY THIS EULA. IF YOU DO NOT ACCEPT THIS EULA, DO NOT INSTALL, DOWNLOAD, OR OTHERWISE USE THE SOFTWARE. IF YOU PURCHASED THE SOFTWARE BUT DO NOT AGREE TO THIS EULA, PLEASE RETURN THE SOFTWARE TO YOUR PLACE OF PURCHASE WITHIN FOURTEEN DAYS FOR A REFUND OF THE PURCHASE PRICE; IF THE SOFTWARE IS INSTALLED ON OR MADE AVAILABLE WITH ANOTHER HP PRODUCT, YOU MAY RETURN THE ENTIRE UNUSED PRODUCT.

- 1. THIRD PARTY SOFTWARE.** The Software may include, in addition to HP proprietary software (“HP Software”), software under licenses from third parties (“Third Party Software” and “Third Party License”). Any Third Party Software is licensed to you subject to the terms and conditions of the corresponding Third Party License. Generally, the Third Party License is in a file such as “license.txt” or a “readme” file. You should contact HP support if you cannot find a Third Party License. If the Third Party Licenses include licenses that provide for the availability of source code (such as the GNU General Public License) and the corresponding source code is not included with the Software, then check the product support pages of HP's website (hp.com) to learn how to obtain such source code.
- 2. LICENSE RIGHTS.** You will have the following rights provided you comply with all terms and conditions of this EULA:
 - a. Use.** HP grants you a license to Use one copy of the HP Software. “Use” means installing, copying, storing, loading, executing, displaying, or otherwise using the HP Software. You may not modify the HP Software or disable any licensing or control feature of the HP Software. If this Software is provided by HP for Use with an imaging or printing product (for example, if the Software is a printer driver, firmware, or add-on), the HP Software may only be used with such product (“HP Product”). Additional restrictions on Use may appear in the User Documentation. You may not separate component parts of the HP Software for Use. You do not have the right to distribute the HP Software.
 - b. Copying.** Your right to copy means you may make archival or back-up copies of the HP Software, provided each copy contains all the original HP Software’s proprietary notices and is used only for back-up purposes.
- 3. UPGRADES.** To Use HP Software provided by HP as an upgrade, update, or supplement (collectively “Upgrade”), you must first be licensed for the original HP Software identified by HP as eligible for the Upgrade. To the extent the Upgrade supersedes the original HP Software, you may no longer use such HP Software. This EULA applies to each Upgrade unless HP provides other terms with the Upgrade. In case of a conflict between this EULA and such other terms, the other terms will prevail.

- 4. TRANSFER.**
 - a.** Third Party Transfer. The initial end user of the HP Software may make a one-time transfer of the HP Software to another end user. Any transfer will include all component parts, media, User Documentation, this EULA, and if applicable, the Certificate of Authenticity. The transfer may not be an indirect transfer, such as a consignment. Prior to the transfer, the end user receiving the transferred Software will agree to this EULA. Upon transfer of the HP Software, your license is automatically terminated.
 - b.** Restrictions. You may not rent, lease or lend the HP Software or Use the HP Software for commercial timesharing or bureau use. You may not sublicense, assign or otherwise transfer the HP Software except as expressly provided in this EULA.
- 5. PROPRIETARY RIGHTS.** All intellectual property rights in the Software and User Documentation are owned by HP or its suppliers and are protected by law, including applicable copyright, trade secret, patent, and trademark laws. You will not remove any product identification, copyright notice, or proprietary restriction from the Software.
- 6. LIMITATION ON REVERSE ENGINEERING.** You may not reverse engineer, decompile, or disassemble the HP Software, except and only to the extent that the right to do so is allowed under applicable law.
- 7. CONSENT TO USE OF DATA.** HP and its affiliates may collect and use technical information you provide in relation to (i) your Use of the Software or the HP Product, or (ii) the provision of support services related to the Software or the HP Product. All such information will be subject to HP's privacy policy. HP will not use such information in a form that personally identifies you except to the extent necessary to enhance your Use or provide support services.
- 8. LIMITATION OF LIABILITY.** Notwithstanding any damages that you might incur, the entire liability of HP and its suppliers under this EULA and your exclusive remedy under this EULA will be limited to the greater of the amount actually paid by you for the Product or U.S. \$5.00. TO THE MAXIMUM EXTENT PERMITTED BY APPLICABLE LAW, IN NO EVENT WILL HP OR ITS SUPPLIERS BE LIABLE FOR ANY SPECIAL, INCIDENTAL, INDIRECT, OR CONSEQUENTIAL DAMAGES (INCLUDING DAMAGES FOR LOST PROFITS, LOST DATA, BUSINESS INTERRUPTION, PERSONAL INJURY, OR LOSS OF PRIVACY) RELATED IN ANY WAY TO THE USE OF OR INABILITY TO USE THE SOFTWARE, EVEN IF HP OR ANY SUPPLIER HAS BEEN ADVISED OF THE POSSIBILITY OF SUCH DAMAGES AND EVEN IF THE ABOVE REMEDY FAILS OF ITS ESSENTIAL PURPOSE. Some states or other jurisdictions do not allow the exclusion or limitation of incidental or consequential damages, so the above limitation or exclusion may not apply to you.
- 9. U.S. GOVERNMENT CUSTOMERS.** Software was developed entirely at private expense. All Software is commercial computer software within the meaning of the applicable acquisition regulations. Accordingly, pursuant to US FAR 48 CFR 12.212 and DFAR 48 CFR 227.7202, use, duplication and disclosure of the Software by or for the U.S. Government or a U.S. Government subcontractor is subject solely to the terms and conditions set forth in this End User License Agreement, except for provisions which are contrary to applicable mandatory federal laws.
- 10. COMPLIANCE WITH EXPORT LAWS.** You will comply with all laws, rules, and regulations (i) applicable to the export or import of the Software, or (ii) restricting the Use of the Software, including any restrictions on nuclear, chemical, or biological weapons proliferation.
- 11. RESERVATION OF RIGHTS.** HP and its suppliers reserve all rights not expressly granted to you in this EULA.

© 2009 Hewlett-Packard Development Company, L.P.

Rev. 04/09

OpenSSL

This product includes software developed by the OpenSSL Project for use in the OpenSSL Toolkit (<http://www.openssl.org/>)

THIS SOFTWARE IS PROVIDED BY THE OpenSSL PROJECT ``AS IS'' AND ANY EXPRESSED OR IMPLIED WARRANTIES, INCLUDING, BUT NOT LIMITED TO, THE IMPLIED WARRANTIES OF MERCHANTABILITY AND FITNESS FOR A PARTICULAR PURPOSE ARE DISCLAIMED. IN NO EVENT SHALL THE OpenSSL PROJECT OR ITS CONTRIBUTORS BE LIABLE FOR ANY DIRECT, INDIRECT, INCIDENTAL, SPECIAL, EXEMPLARY, OR CONSEQUENTIAL DAMAGES (INCLUDING, BUT NOT LIMITED TO, PROCUREMENT OF SUBSTITUTE GOODS OR SERVICES;

LOSS OF USE, DATA, OR PROFITS; OR BUSINESS INTERRUPTION) HOWEVER CAUSED AND ON ANY THEORY OF LIABILITY, WHETHER IN CONTRACT, STRICT LIABILITY, OR TORT (INCLUDING NEGLIGENCE OR OTHERWISE) ARISING IN ANY WAY OUT OF THE USE OF THIS SOFTWARE, EVEN IF ADVISED OF THE POSSIBILITY OF SUCH DAMAGE.

This product includes cryptographic software written by Eric Young (ey@cryptsoft.com). This product includes software written by Tim Hudson (tjh@cryptsoft.com).

Customer support

Get telephone support, free during your warranty period, for your country/region	Country/region phone numbers are on the flyer that was in the box with your product or at www.hp.com/support/ .
Have the product name, serial number, date of purchase, and problem description ready.	
Get 24-hour Internet product support and troubleshooting and download drivers and software, and electronic information	www.hp.com/support
Get support for products used with a Macintosh computer	www.hp.com/go/macosex
Download software utilities, drivers, and electronic information	http://www.hp.com/go/support
Order additional HP service or maintenance agreements	www.hp.com/go/carepack
Register your product	www.register.hp.com

C Product specifications

- [Physical specifications](#)
- [Power consumption, electrical specifications, and acoustic emissions](#)
- [Acoustic emissions](#)
- [Environmental specifications](#)

Physical specifications

Table C-1 Physical specifications

Product	Height	Depth	Width	Weight
HP Officejet Pro X476 MFP Series	521 mm (20.5 inches)	406 mm (16.0 inches)	521 mm (20.5 inches)	23.7 kg (50.0 lb)
HP Officejet Pro X576 MFP Series	518 mm (20.4 inches)	399 mm (15.7 inches)	516 mm (20.3 inches)	23.1 kg (51 lb), without supplies

Power consumption, electrical specifications, and acoustic emissions

CAUTION: Power requirements are based on the country/region where the product is sold. Do not convert operating voltages. This will damage the product and any such damage is not covered under the HP limited warranty and service agreements.

Acoustic emissions

Table C-2 Acoustic emission levels

Operation	LwAd-mono (B)	LwAd-color (B)	Notes
Print	6.9	6.8	
Copy	7.1	6.9	ADF models
Scan	6.9	6.7	ADF models

HP recommends that the machine be located in a room in which no employee has his/her regular work station.

Environmental specifications

Table C-3 Environmental specifications¹

	Operating	Transporting
Temperature	15° to 30° C (59° to 86° F)	-40° to 60° C (-40° to 140° F)
Relative humidity	20 to 80%	90% or less (non-condensing)
Altitude	0 to 3048 m (0 to 10,000 ft)	
Tilt	IMPORTANT: Caution should be taken when moving the printer since tilting at an angle of > 15 degrees could result in ink leakage, especially soon after startup	

¹ Values are subject to change.

D Environmental product stewardship program

- [Protecting the environment](#)
- [Ozone production](#)
- [Power consumption](#)
- [Paper use](#)
- [Plastics](#)
- [HP Officejet print supplies](#)
- [Return and recycling instructions](#)
- [Paper](#)
- [Material restrictions](#)
- [Disposal of waste equipment by users](#)
- [Electronic Hardware Recycling](#)
- [Chemical substances](#)
- [Material Safety Data Sheet \(MSDS\)](#)
- [For more information](#)
- [Substances Table \(China\)](#)
- [Restriction on Hazardous Substances statement \(Turkey\)](#)
- [Restriction on Hazardous Substances statement \(Ukraine\)](#)
- [Restriction on Hazardous Substances statement \(Vietnam\)](#)

Protecting the environment

Hewlett-Packard Company is committed to providing quality products in an environmentally sound manner. This product has been designed with several attributes to minimize impacts on our environment.

Ozone production

This product generates no appreciable ozone gas (O_3).

Power consumption

Power usage drops significantly while in Ready or Sleep mode, which saves natural resources and saves money without affecting the high performance of this product. Hewlett-Packard printing and imaging equipment marked with the ENERGY STAR® logo is qualified to the U.S. Environmental Protection Agency's ENERGY STAR specifications for imaging equipment. The following mark will appear on ENERGY STAR qualified imaging products:



Additional ENERGY STAR qualified imaging product model information is listed at:

www.hp.com/go/energystar



NOTE: Additional energy savings may be realized by turning off the printer if it will not be used for a longer time.

Paper use

This product's optional automatic duplex feature (two-sided printing) and N-up printing (multiple pages printed on one page) capability can reduce paper usage and the resulting demands on natural resources.



NOTE: Recycled paper and A4 sized paper can be used for duplexing.

Plastics

Plastic parts over 25 grams are marked according to international standards that enhance the ability to identify plastics for recycling purposes at the end of the product's life.

HP Officejet print supplies

HP is committed to providing inventive, high-quality products and services that are environmentally sound, from product design and manufacturing to distribution, customer use and recycling. When you participate in the HP Planet Partners program, we ensure your HP Officejet ink cartridges are recycled properly, processing them to recover plastics and metals for new products and diverting millions of tons of waste from landfills. Since this cartridge is being recycled and used in new materials, it will not be returned to you. Thank you for being environmentally responsible!

 **NOTE:** Go to <http://www.hp.com/recycle> for complete recycling information and to order postage-paid labels, envelopes, or boxes, for recycling.

Return and recycling instructions

United States and Puerto Rico

Go to www.hp.com/recycle for complete recycling information and to order post-paid labels and envelopes or boxes. Please follow the applicable instructions below.

Multiple returns (more than one cartridge)

1. Package each HP Officejet ink cartridge in its original box and bag.
2. Tape the boxes together using strapping or packaging tape. The package can weigh up to 31 kg (70 lb).
3. Use a single pre-paid shipping label.

OR

1. Use your own suitable box, or request a free bulk collection box from www.hp.com/recycle or 1-800-340-2445 (holds up to 31 kg (70 lb) of HP Deskjet ink cartridges).
2. Use a single pre-paid shipping label.

Single returns

1. Package the HP Officejet ink cartridge in its original bag and box.
2. Place the shipping label on the front of the box.

Shipping

For US and Puerto Rico HP Officejet ink cartridge recycling returns, use the pre-paid, pre-addressed shipping label contained in the box. To use the UPS label, give the package to the UPS driver during your next delivery or pick-up, or take it to an authorized UPS drop-off center. (Requested UPS Ground pickup will be charged normal pick-up rates) For the location of your local UPS drop-off center, call 1-800-PICKUPS or visit www.ups.com.

If you are returning the package with the FedEx label, give the package to either the U.S. Postal Service carrier or FedEx driver during your next pick-up or delivery. (Requested FedEx Ground pickup will be charged normal pick-up rates). Or, you can drop off your packaged ink cartridge(s) at any U.S. Post Office or any FedEx shipping center or store. For the location of your nearest U.S. Post Office, please call 1-800-ASK-USPS or visit www.usps.com. For the location of your nearest FedEx shipping center/store, please call 1-800-GOFEDEX or visit www.fedex.com.

For more information, or to order additional labels or boxes for bulk returns, visit www.hp.com/recycle or call 1-800-340-2445. Information subject to change without notice.

Residents of Alaska and Hawaii

Do not use the UPS label. Call 1-800-340-2445 for information and instructions. The U.S. Postal Service provides no-cost cartridge return transportation services under an arrangement with HP for Alaska and Hawaii.

Non-U.S. returns

To participate in HP Planet Partners return and recycling program, just follow the simple directions in the recycling guide (found inside the packaging of your new product supply item) or visit www.hp.com/recycle. Select your country/region for information on how to return your HP Officejet printing supplies.

Battery disposal

For battery disposal information, see <http://www8.hp.com/us/en/hp-information/environment/product-recycling.html>

Printer recycling

For printer recycling information, see <http://www8.hp.com/us/en/hp-information/environment/product-recycling.html>

Paper

This product is capable of using recycled papers when the paper meets HP guidelines. This product is suitable for the use of recycled paper according to EN12281:2002.

Material restrictions

This HP product does not contain intentionally added mercury.

This HP product contains a battery that might require special handling at end-of-life. The batteries contained in or supplied by Hewlett-Packard for this product include the following:

HP Officejet Pro X476 and X576 MFP Series	
Type	Lithium Manganese Dioxide
Weight	3.0 g
Location	On main board
User-removable	No



廢電池請回收



Dit HP Product bevat een lithium-mangane-dioxide batterij. Deze bevindt zich op de hoofdprintplaat. Wanneer deze batterij leeg is, moet deze volgens de geldende regels worden afgevoerd.



廢電池請回收

Please recycle waste batteries.

California Perchlorate Material Notice

Perchlorate material - special handling may apply. See:
<http://www.dtsc.ca.gov/hazardouswaste/perchlorate/>

This product's real-time clock battery or coin cell battery may contain perchlorate and may require special handling when recycled or disposed of in California.

For recycling information, you can go to www.hp.com/recycle, or contact your local authorities or the Electronics Industries Alliance: www.eiae.org.

Disposal of waste equipment by users

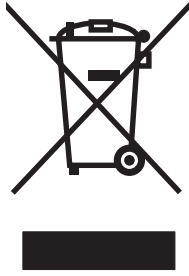

This symbol means do not dispose of your product with your other household waste. Instead, you should protect human health and the environment by handing over your waste equipment to a designated collection point for the recycling of waste electrical and electronic equipment. For more information, go to <http://www.hp.com/recycle>

Electronic Hardware Recycling

HP encourages customers to recycle used electronic hardware. For more information about recycling programs go to: <http://www.hp.com/recycle>.

Chemical substances

HP is committed to providing our customers with information about the chemical substances in our products as needed to comply with legal requirements such as REACH (Regulation EC No 1907/2006 of the European Parliament and the Council). A chemical information report for this product can be found at: www.hp.com/go/reach.

Material Safety Data Sheet (MSDS)

Material Safety Data Sheets (MSDS) for supplies containing chemical substances (for example, ink) can be obtained by accessing the HP Web site at www.hp.com/go/msds or www.hp.com/hpinfo/community/environment/productinfo/safety.

For more information

To obtain information about these environmental topics:

- Product environmental profile sheet for this and many related HP products
- HP's commitment to the environment
- HP's environmental management system
- HP's end-of-life product return and recycling program
- Material Safety Data Sheets

Visit www.hp.com/go/environment or www.hp.com/hpinfo/globalcitizenship/environment.

Substances Table (China)

有毒有害物质表

根据中国电子信息产品污染控制管理办法的要求而出台

部件名称	有毒有害物质和元素					
	铅 (Pb)	汞 (Hg)	镉 (Cd)	六价铬 (Cr(VI))	多溴联苯 (PBB)	多溴二苯醚 (PBDE)
打印引擎	0	0	0	0	0	0
复印机组件	0	0	0	0	0	0
控制面板	0	0	0	0	0	0
塑料外壳	0	0	0	0	0	0
格式化板组件	0	0	0	0	0	0
碳粉盒	0	0	0	0	0	0

3690 b

0：表示在此部件所用的所有同类材料中，所含的此有毒或有害物质均低于 SJ/T11363-2006 的限制要求。

X：表示在此部件所用的所有同类材料中，至少一种所含的此有毒或有害物质高于 SJ/T11363-2006 的限制要求。

注：引用的“环保使用期限”是根据在正常温度和湿度条件下操作使用产品而确定的。

Restriction on Hazardous Substances statement (Turkey)

Türkiye Cumhuriyeti: EEE Yönetmeliğine Uygundur

Restriction on Hazardous Substances statement (Ukraine)

Обладнання відповідає вимогам Технічного регламенту щодо обмеження використання деяких небезпечних речовин в електричному та електронному обладнанні, затвердженого постановою Кабінету Міністрів України від 3 грудня 2008 № 1057

Restriction on Hazardous Substances statement (Vietnam)

“Các sản phẩm của công ty Hewlett-Packard tuân thủ Thông tư 30/2011/TT-BCT quy định tạm thời về giới hạn hàm lượng cho phép của một số hóa chất độc hại trong sản phẩm điện, điện tử”

E Regulatory information

- [Regulatory Notices](#)
- [VCCI statement \(Japan\)](#)
- [Power cord instructions](#)
- [Power cord statement \(Japan\)](#)
- [EMC statement \(Korea\)](#)
- [GS statement \(Germany\)](#)
- [European Union Regulatory Notice](#)
- [Additional statements for telecom \(fax\) products](#)
- [Additional statements for wireless products](#)
- [Anonymous usage information storage](#)

Regulatory Notices

Regulatory model identification number

For regulatory identification purposes, your product is assigned a Regulatory Model Number. The Regulatory Model Number for your product is VCVRA-1212. This regulatory number should not be confused with the marketing name (HP Officejet Pro X476 MFP Series, HP Officejet Pro X576 MFP Series, etc.) or product numbers (CN459A, CN463A, CN596A, CV037A etc.).

FCC Statement

This equipment has been tested and found to comply with the limits for a Class B digital device, pursuant to Part 15 of the FCC rules. These limits are designed to provide reasonable protection against harmful interference in a residential installation. This equipment generates, uses, and can radiate radio frequency energy. If this equipment is not installed and used in accordance with the instructions, it may cause harmful interference to radio communications. However, there is no guarantee that interference will not occur in a particular installation. If this equipment does cause harmful interference to radio or television reception, which can be determined by turning the equipment off and on, the user is encouraged to try to correct the interference by one or more of the following measures:

- Reorient or relocate the receiving antenna.
- Increase separation between equipment and receiver.
- Connect equipment to an outlet on a circuit different from that to which the receiver is located.
- Consult your dealer or an experienced radio/TV technician.



NOTE: Any changes or modifications to the printer that are not expressly approved by HP could void the user's authority to operate this equipment.

Use of a shielded interface cable is required to comply with the Class B limits of Part 15 of FCC rules.

For further information, contact: Manager of Corporate Product Regulations Hewlett-Packard Company
3000 Hanover Street Palo Alto, Ca 94304 (650) 857-1501

This device complies with Part 15 of FCC Rules. Operation is subject to the following two conditions: (1) this device may not cause interference, and (2) this device must accept any interference, including interference that may cause undesired operation of the device.

VCCI statement (Japan)

この装置は、クラスB情報技術装置です。この装置は、家庭環境で使用することを目的としていますが、この装置がラジオやテレビジョン受信機に近接して使用されると、受信障害を引き起こすことがあります。取扱説明書に従って正しい取り扱いをして下さい。

VCCI-B

Power cord instructions

Make sure your power source is adequate for the product voltage rating. The voltage rating is on the product label. The product uses either 100-127 Vac or 220-240 Vac and 50/60 Hz.

Connect the power cord between the product and a grounded AC outlet.

 **CAUTION:** To prevent damage to the product, use only the power cord that is provided with the product.

Power cord statement (Japan)

製品には、同梱された電源コードをお使い下さい。
同梱された電源コードは、他の製品では使用出来ません。

EMC statement (Korea)

B급 기기 (가정용 방송통신기기)	이 기기는 가정용(B급)으로 전자파적합등록을 한 기기로서 주로 가정에서 사용하는 것을 목적으로 하며, 모든 지역에서 사용할 수 있습니다.
-----------------------	--

GS statement (Germany)

Das Gerät ist nicht für die Benutzung im unmittelbaren Gesichtsfeld am Bildschirmarbeitsplatz vorgesehen. Um störende Reflexionen am Bildschirmarbeitsplatz zu vermeiden, darf dieses Produkt nicht im unmittelbaren Gesichtsfeld platziert werden.

European Union Regulatory Notice

Products bearing the CE marking  comply with the following EU Directives:

- Low Voltage Directive 2006/95/EC
- EMC Directive 2004/108/EC
- Ecodesign Directive 2009/125/EC, where applicable

CE compliance of this product is valid only if powered with the correct CE-marked AC adapter provided by HP.

If this product has wired and/or wireless telecommunications functionality, it also complies with the essential requirements of the following EU Directive:

- R&TTE; Directive 1999/5/EC

Compliance with these directives implies conformity to applicable harmonized European standards (European Norms) that are listed in the EU Declaration of Conformity issued by HP for this product or product family and available (in English only) either within the product documentation or at the following website: www.hp.com/go/certificates (type the product number in the search field).

The compliance is indicated by one of the following conformity markings placed on the product:

	For non-telecommunications products and for EU harmonized telecommunications products, such as Bluetooth® within power class below 10mW.
	For EU non-harmonized telecommunications products (If applicable, a 4-digit notified body number is inserted between CE and !).

Please refer to the regulatory label provided on the product.

The telecommunications functionality of this product may be used in the following EU and EFTA countries: Austria, Belgium, Bulgaria, Cyprus, Czech Republic, Denmark, Estonia, Finland, France, Germany, Greece, Hungary, Iceland, Ireland, Italy, Latvia, Liechtenstein, Lithuania, Luxembourg, Malta, Netherlands, Norway, Poland, Portugal, Romania, Slovak Republic, Slovenia, Spain, Sweden, Switzerland, and United Kingdom.

The telephone connector (not available for all products) is intended for connection to analogue telephone networks.

Products with wireless LAN devices

Some countries may have specific obligations or special requirements about the operation of Wireless LAN networks such as indoor use only or restrictions of the channels available. Please make sure that the country settings of the wireless network are correct.

France

For 2.4-GHz Wireless LAN operation of this product, certain restrictions apply: This product may be used indoors for the entire 2400-MHz to 2483.5-MHz frequency band (channels 1 to 13). For outdoor use, only the 2400-MHz to 2454-MHz frequency band (channels 1 to 7) may be used. For the latest requirements, see www.arcep.fr.

The point of contact for regulatory matters is:

Hewlett-Packard GmbH, Dept./MS: HQ-TRE, Herrenberger Strasse 140, 71034 Boeblingen,
GERMANY

Additional statements for telecom (fax) products

EU Statement for Telecom Operation

This product is intended to be connected to the analog Public Switched Telecommunication Networks (PSTN) of European Economic Area (EEA) countries/regions.

Network compatibility depends on customer selected settings, which must be reset to use the equipment on a telephone network in a country/region other than where the product was purchased. Contact the vendor or Hewlett-Packard Company if additional product support is necessary.

This equipment has been certified by the manufacturer in accordance with Directive 1999/5/EC (annex II) for Pan-European single-terminal connection to the public switched telephone network (PSTN). However, due to differences between the individual PSTNs provided in different countries, the approval does not, of itself, give an unconditional assurance of successful operation on every PSTN network termination point.

In the event of problems, you should contact your equipment supplier in the first instance.

This equipment is designed for DTMF tone dialing and loop disconnect dialing. In the unlikely event of problems with loop disconnect dialing, it is recommended to use this equipment only with the DTMF tone dial setting.

New Zealand Telecom Statements

The grant of a Telepermit for any item of terminal equipment indicates only that Telecom has accepted that the item complies with minimum conditions for connection to its network. It indicates no endorsement of the product by Telecom, nor does it provide any sort of warranty. Above all, it provides no assurance that any item will work correctly in all respects with another item of Telepermitted equipment of a different make or model, nor does it imply that any product is compatible with all of Telecom's network services.

This equipment may not provide for the effective hand-over of a call to another device connected to the same line.

This equipment shall not be set up to make automatic calls to the Telecom "111" Emergency Service.

This product has not been tested to ensure compatibility with the FaxAbility distinctive ring service for New Zealand.

Additional FCC statement for telecom products (US)

This equipment complies with Part 68 of the FCC rules and the requirements adopted by the ACTA. On the rear (or bottom) of this equipment is a label that contains, among other information, a product identifier in the format US:AAAEQ##TXXXX. If requested, this number must be provided to the telephone company.

Applicable connector jack Universal Service Order Codes ("USOC") for the Equipment is: RJ-11C.

A plug and jack used to connect this equipment to the premises wiring and telephone network must comply with the applicable FCC Part 68 rules and requirements adopted by the ACTA. A compliant

telephone cord and modular plug is provided with this product. It is designed to be connected to a compatible modular jack that is also compliant. See installation instructions for details.

The REN is used to determine the number of devices that may be connected to a telephone line. Excessive RENs on a telephone line may result in the devices not ringing in response to an incoming call. In most but not all areas, the sum of RENs should not exceed five (5.0). To be certain of the number of devices that may be connected to a line, as determined by the total RENs, contact the local telephone company. For products approved after July 23, 2001, the REN for this product is part of the product identifier that has the format US:AAAEQ##TXXXX. The digits represented by ## are the REN without a decimal point (e.g., 00 is a REN of 0.0).

If this equipment causes harm to the telephone network, the telephone company will notify you in advance that temporary discontinuance of service may be required. But if advance notice isn't practical, the telephone company will notify the customer as soon as possible. Also, you will be advised of your right to file a complaint with the FCC if you believe it is necessary.

The telephone company may make changes in its facilities, equipment, operations or procedures that could affect the operation of the equipment. If this happens the telephone company will provide advance notice in order for you to make necessary modifications to maintain uninterrupted service.

If trouble is experienced with this equipment, please contact the manufacturer, or look elsewhere in this manual, for repair or warranty information. If the equipment is causing harm to the telephone network, the telephone company may request that you disconnect the equipment until the problem is resolved.

Connection to party line service is subject to state tariffs. Contact the state public utility commission, public service commission or corporation commission for information.

 **CAUTION:** If your home has specially wired alarm equipment connected to the telephone line, ensure the installation of this equipment does not disable your alarm equipment. If you have questions about what will disable alarm equipment, consult your telephone company or a qualified installer.

WHEN PROGRAMMING EMERGENCY NUMBERS AND(OR) MAKING TEST CALLS TO EMERGENCY NUMBERS:

- Remain on the line and briefly explain to the dispatcher the reason for the call.
- Perform such activities in the off-peak hours, such as early morning or late evening.

 **NOTE:** The FCC hearing aid compatibility rules for telephones are not applicable to this equipment.

The Telephone Consumer Protection Act of 1991 makes it unlawful for any person to use a computer or other electronic device, including FAX machines, to send any message unless such message clearly contains in a margin at the top or bottom of each transmitted page or on the first page of the transmission, the date and time it is sent and an identification of the business or other entity, or other individual sending the message and the telephone number of the sending machine or such business, other entity, or individual. (The telephone number provided may not be a 900 number or any other number for which charges exceed local or long-distance transmission charges.)

In order to program this information into your FAX machine, you should complete the steps described in the software.

Telephone Consumer Protection Act (US)

The Telephone Consumer Protection Act of 1991 makes it unlawful for any person to use a computer or other electronic device, including fax machines, to send any message unless such message clearly contains, in a margin at the top or bottom of each transmitted page or on the first page of the transmission, the date and time it is sent and an identification of the business, other entity, or individual sending the message and the telephone number of the sending machine or such business, or other entity, or individual. (The telephone number provided cannot be a 900 number or any other number for which charges exceed local or long distance transmission charges).

Industry Canada CS-03 requirements

Notice: The Industry Canada label identifies certified equipment. This certification means the equipment meets certain telecommunications network protective, operational, and safety requirements as prescribed in the appropriate Terminal Equipment Technical Requirement document(s). The Department does not guarantee the equipment will operate to the user's satisfaction. Before installing this equipment, users should ensure that it is permissible for the equipment to be connected to the facilities of the local telecommunications company. The equipment must also be installed using an acceptable method of connection. The customer should be aware that compliance with the above conditions may not prevent degradation of service in some situations. Repairs to certified equipment should be coordinated by a representative designated by the supplier. Any repairs or alterations made by the user to this equipment, or equipment malfunctions, may give the telecommunications company cause to request the user to disconnect the equipment. Users should ensure for their own protection that the electrical ground connections of the power utility, telephone lines, and internal metallic water pipe system, if present, are connected together. This precaution can be particularly important in rural areas.

 **CAUTION:** Users should not attempt to make such connections themselves, but should contact the appropriate electric inspection authority, or electrician, as appropriate. The Ringer Equivalence Number (REN) of this device is 0.0.

Notice: The Ringer Equivalence Number (REN) assigned to each terminal device provides an indication of the maximum number of terminals allowed to be connected to a telephone interface. The termination on an interface may consist of any combination of devices subject only to the requirement that the sum of the Ringer Equivalence Number of all the devices does not exceed five (5.0). The standard connecting arrangement code (telephone jack type) for equipment with direct connections to the telephone network is CA11A.

Note à l'attention des utilisateurs du réseau téléphonique Canadien/notice to users of the Canadian telephone network

Cet appareil est conforme aux spécifications techniques des équipements terminaux d'Industrie Canada. Le numéro d'enregistrement atteste de la conformité de l'appareil. L'abréviation IC qui précède le numéro d'enregistrement indique que l'enregistrement a été effectué dans le cadre d'une Déclaration de conformité stipulant que les spécifications techniques d'Industrie Canada ont été respectées. Néanmoins, cette abréviation ne signifie en aucun cas que l'appareil a été validé par Industrie Canada. Pour leur propre sécurité, les utilisateurs doivent s'assurer que les prises électriques reliées à la terre de la source d'alimentation, des lignes téléphoniques et du circuit métallique d'alimentation en eau sont, le cas échéant, branchées les unes aux autres. Cette précaution est particulièrement importante dans les zones rurales. Le numéro REN (Ringer Equivalence Number) attribué à chaque appareil terminal fournit une indication sur le nombre maximal de terminaux qui

peuvent être connectés à une interface téléphonique. La terminaison d'une interface peut se composer de n'importe quelle combinaison d'appareils, à condition que le total des numéros REN ne dépasse pas 5.

Basé sur les résultats de tests FCC Partie 68, le numéro REN de ce produit est 0.0B.

Australia Wired Fax Statement

In Australia the HP device must be connected to the Telecommunications Network through a line cord which meets the requirements of the Technical Standard AS/ACIF S008.

Notice to users of the German telephone network

This HP fax product is designed to connect only to the analogue public-switched telephone network (PSTN). Please connect the TAE N telephone connector plug, provided with the HP All-in-One into the wall socket (TAE 6) code N. This HP fax product can be used as a single device and/or in combination (in serial connection) with other approved terminal equipment.

Vietnam Telecom wired marking for ICTQC Type approved products



Additional statements for wireless products

FCC compliance statement—United States

Exposure to radio frequency radiation

⚠ CAUTION: The radiated output power of this device is far below the FCC radio frequency exposure limits. Nevertheless, the device shall be used in such a manner that the potential for human contact during normal operation is minimized.

In order to avoid the possibility of exceeding the FCC radio frequency exposure limits, human proximity to the antenna shall not be less than 20 cm (8 in)) during normal operation.

Notice to users in the US and Canada

⚠ CAUTION: When using IEEE 802.11a wireless LAN, this product is restricted to indoor use, due to its operation in the 5.15- to 5.25-GHz frequency range. The FCC/Industry Canada requires this product to be used indoors for the frequency range of 5.15 GHz to 5.25 GHz to reduce the potential for harmful interference to co-channel mobile satellite systems. High-power radar is allocated as the primary user of the 5.25- to 5.35-GHz and 5.65- to 5.85-GHz bands. These radar stations can cause interference with and/or damage to this device.

Australia statement

This device incorporates a radio-transmitting (wireless) device. For protection against radio transmission exposure, it is recommended that this device be operated no less than 20 cm from the head, neck, or body.

Brazil ANATEL statement

Este equipamento opera em caráter secundário, isto é, não tem direito à proteção contra interferência prejudicial, mesmo de estações do mesmo tipo, e não pode causar interferência a sistemas operando em caráter primário (Res. ANTEL 282/2001).

Canadian statements

Under Industry Canada regulations, this radio transmitter may only operate using an antenna of a type and maximum (or lesser) gain approved for the transmitter by Industry Canada. To reduce potential radio interference to other users, the antenna type and its gain should be so chosen that the equivalent isotropically radiated power (e.i.r.p.) is not more than that necessary for successful communication.

This device complies with Industry Canada licence-exempt RSS standard(s). Operation is subject to the following two conditions: (1) this device may not cause interference, and (2) this device must accept any interference, including interference that may cause undesired operation of the device.

⚠ WARNING! Exposure to Radio Frequency Radiation The radiated output power of this device is below the Industry Canada radio frequency exposure limits. Nevertheless, the device should be used in such a manner that the potential for human contact is minimized during normal operation.

To avoid the possibility of exceeding the Industry Canada radio frequency exposure limits, human proximity to the antennas should not be less than 20 cm (8 inches).

Japan statement

この機器は技術基準適合証明又は工事設計認証を受けた無線設備を搭載しています。

Korean statement

당해 무선설비는 운용 중 전파혼선 가능성이 있음

Taiwan statement

低功率電波輻射性電機管理辦法

第十二條 經型式認證合格之低功率射頻電機，非經許可，公司、商號或使用者均不得擅自變更頻率、加大功率或變更原設計之特性及功能。

第十四條 低功率射頻電機之使用不得影響飛航安全及干擾合法通信；經發現有干擾現象時，應立即停用，並改善至無干擾時方得繼續使用。前項合法通信，指依電信法規定作業之無線電通信。低功率射頻電機須忍受合法通信或工業、科學及醫療用電波輻射性電機設備之干擾。

Mexico statement

Aviso para los usuarios de México

La operación de este equipo está sujeta a las siguientes dos condiciones: (1) es posible que este equipo o dispositivo no cause interferencia perjudicial y (2) este equipo o dispositivo debe aceptar cualquier interferencia, incluyendo la que pueda causar su operación no deseada. Para saber el modelo de la tarjeta inalámbrica utilizada, revise la etiqueta regulatoria de la impresora.

Anonymous usage information storage

The HP cartridges used with this printer contain a memory chip that assists in the operation of the printer.

In addition, this memory chip stores a limited set of anonymous information about the usage of the printer, which might include the following: the date when the cartridge was first installed, the date when the cartridge was last used, the number of pages printed using the cartridge, the page coverage, frequency of printing, the printing modes used, any printing errors that might have occurred, and the printer model.

This information helps HP design future printers to meet our customers' printing needs. The data collected from the cartridge memory chip does not contain information that can be used to identify a customer or user of the cartridge or their printer.

HP collects a sampling of the memory chips from cartridges returned to HP's free return and recycling program (HP Planet Partners: www.hp.com/hpinfo/globalcitizenship/environment/recycle/). The memory chips from this sampling are read and studied in order to improve future HP printers. HP partners who assist in recycling this cartridge might have access to this data, as well.

Any third party possessing the cartridge might have access to the anonymous information on the memory chip. If you prefer to not allow access to this information, you can render the chip inoperable. However, after you render the memory chip inoperable, the cartridge cannot be used in an HP printer.

If you are concerned about providing this anonymous information, you can make this information inaccessible by turning off the memory chip's ability to collect the printer's usage information:

To disable the usage information function

1. On the printer control panel, touch **Setup**.
2. Select **Preferences**, and then select **Cartridge Chip Information**.
3. Touch **OK** to turn off usage information collection.

 **NOTE:** To re-enable the usage information function, restore the factory defaults.

 **NOTE:** You can continue to use the cartridge in the HP printer if you turn off the memory chip's ability to collect the printer's usage information.

F How do I?

- [Connect the product on page 31](#)
- [Use the product with Windows on page 41](#)
- [Use the product with Mac on page 49](#)
- [Paper and print media on page 61](#)
- [Ink cartridges on page 75](#)
- [Print on page 89](#)
- [Color on page 123](#)
- [Copy on page 131](#)
- [Scan on page 143](#)
- [Fax on page 151](#)
- [Manage and maintain on page 197](#)
- [Solve problems on page 215](#)

Index

A

- accessories
 - ordering 261, 262
- acoustic specifications 272
- advanced setup
 - fax 20
- AirPrint 117
- answering machines, connecting
 - fax settings 160
- anticounterfeit supplies 79
- autoreduction settings, fax 161

B

- batteries included 285
- bin, output
 - jams, clearing 232
 - locating 5
- blocking faxes 159
- booklets
 - creating (Windows) 111
- brightness scanning 148
- busy signals, redialing options 157

C

- canceling
 - copy jobs 135
 - faxes 163
 - print job 104, 113
 - scan jobs 146
- cartridges
 - non-HP 79
 - recycling 79, 281
 - replacing 80
 - storage 79
- cautions iii
- change
 - ink cartridge 80

- checklist
 - fax troubleshooting 174
- clean
 - touch screen 212
- cleaning
 - glass 137, 149, 210
 - paper path 242
 - printhead 210
- collating copies 136
- color
 - adjusting 124, 237
 - Colorlok technology 129
 - manage 123
 - matching 128
 - printed vs. monitor 128
 - printing in grayscale (Windows) 104
 - using 123
- color options
 - HP EasyColor (Windows) 127
 - setting (Windows) 100
- Color tab settings 102
- color, scanning settings 147, 148
- comparison, product models 1
- connecting to a wireless network 37
- connectivity
 - solving problems 248
 - USB 32
- contrast settings
 - copy 138
- control panel
 - buttons and lights 9
 - clean touch screen 212
 - cleaning page, printing 210
 - help 12
 - Home screen 10
 - menus 18

- Reports menu 30
- settings 45, 52
- conventions, document iii
- copies
 - changing number of (Windows) 91
- copy menu 14
- copying
 - canceling 135
 - collation 136
 - contrast, adjusting 138
 - double-sided 142
 - edge-to-edge 138
 - enlarging 135
 - light/dark settings 138
 - multiple copies 132
 - one-touch 132
 - paper settings 139
 - photos 140
 - quality, adjusting 244
 - reducing 135
- counterfeit supplies 79
- cover pages
 - printing (Mac) 101
 - printing on different paper (Windows) 106
- custom print settings (Windows) 91
- custom-size copies 135
- custom-size paper settings
 - Macintosh 113
- customer support
 - online 216, 270

D

- darkness settings
 - fax 158
- darkness, contrast settings
 - copy 138

- default gateway, setting 35
- defaults, restoring 219
- delaying fax sending 170
- deleting faxes from memory 165
- Device setup menu 24
- dialing
 - from a telephone 170
 - pauses, inserting 156
 - prefixes, inserting 156
 - redialing automatically, settings 157
 - tone or pulse settings 156
- dimensions 272
- disposal, end-of-life 285
- distinctive-ring settings 160
- document conventions iii
- document feeder
 - jams 223
 - loading 72
 - locating 5
- door release, locating 5
- dots per inch (dpi)
 - fax 158
- dpi (dots per inch)
 - fax 158
 - scanning 147
- drivers
 - changing paper types and sizes 64
 - changing settings (Mac) 53
 - changing settings (Windows) 45
 - presets (Mac) 101
 - settings 45
 - settings (Mac) 101
 - settings (Windows) 90
 - supported (Windows) 42
 - universal 44
- DSL
 - faxing 163
- duplex printing (double-sided)
 - settings (Windows) 96
- duplex settings, changing 36
- E**
 - e-mail, scanning to
 - resolution settings 148
 - economy settings 208
 - edge-to-edge printing 138
 - electrical specifications 272
 - electronic faxes
 - sending 169
 - embedded Web server (EWS)
 - features 200
 - end-of-life disposal 285
 - enlarging documents
 - copying 135
 - environmental features 4
 - environmental specifications 273
 - error messages, fax 176, 182, 189
 - error report, fax
 - printing 181
 - error-correction setting, fax 182
 - errors
 - software 256
 - ethernet port
 - locating 6, 7
 - extension phones
 - sending faxes from 170
- F**
 - factory-set defaults, restoring 219
 - fade- and water-resistant prints 129
 - fax
 - autoreduction 161
 - blocking 159
 - canceling 163
 - confirming number 170
 - contrast setting 158
 - delaying sending 170
 - deleting from memory 165
 - dial prefixes 156
 - dialing, tone or pulse 156
 - error report, printing 181
 - error-correction 182
 - factory-set defaults, restoring 219
 - forwarding 159
 - monitor dialing 171
 - pauses, inserting 156
 - polling 162
 - printing 173
 - receiving when you hear fax tones 173
 - redial settings 157
 - reports 21
 - reprinting from memory 173
 - resolution 158
 - ring patterns 160
 - ring type 20
 - rings-to-answer 160
 - sending from a telephone 170
 - sending from software 169
 - solve general problems 193
 - speed dials 167
 - stamp-received 162
 - unable to receive 189
 - unable to send 182
 - using DSL, PBX, or ISDN 163
 - using VoIP 164
 - V.34 setting 182
 - volume settings 161
 - fax date, setup
 - use control panel 152
 - use HP Fax Setup Wizard 153
 - fax header, setup
 - use control panel 152
 - use HP Fax Setup Wizard 153
 - fax menu 16
 - fax ports, locating 6, 7
 - fax reports, printing 21
 - fax time, setup
 - use control panel 152
 - use HP Fax Setup Wizard 153
 - fax troubleshooting
 - checklist 174
 - faxing
 - from a computer (Mac) 56, 169
 - from a computer (Windows) 169
 - features 2
 - firewall 37
 - first page
 - printing on different paper (Windows) 106
 - use different paper 101
 - Fit to Page setting, fax 161
 - fonts
 - lists, printing 30
 - forwarding faxes 159
 - fraud Web site 79
- G**
 - gateway, setting default 35
 - General Office setting 78, 208
 - glass, cleaning 137, 149, 210

- grayscale
 - printing (Windows) 104
- group-dial entries
 - creating 155
 - editing 155

H

- help
 - printing options (Windows) 90
- help, control panel 12
- Home screen, control panel 10
- HP Customer Care 216, 270
- HP Digital Solutions Setup menu 24
- HP Easy Color
 - disabling 127
 - using 127
- HP Embedded Web Server 48
- HP ePrint
 - description 36
- HP ePrint Mobile Driver 116
- HP ePrint, using 115
- HP fraud website 79
- HP Universal Print Driver 44
- HP Utility 51
- HP Utility, Mac 51
- HP Web Jetadmin 204
- HP Web Services, enabling 115
- humidity specifications
 - environment 273

I

- identification cards
 - copying 134
- ink cartridges
 - checking for damage 242
 - non-HP 79
 - part numbers 75, 262
 - replacing 80
 - storage 79
- input tray
 - loading 70
 - locating 5
- installing
 - product on wired networks 33
 - software, USB connections 32
 - software, wired networks 34
- interface ports
 - locating 6, 7

- IP address
 - obtaining 33
- IPv4 address 35
- ISDN
 - faxing 163

J

- jams
 - causes of 220
 - document feeder, clearing 223
 - locating 222
 - output bin, clearing 232
 - paper path, clearing 230
- Japanese VCCI statement 297
- Jetadmin, HP Web 204

K

- Korean EMC statement 299

L

- labels
 - printing (Windows) 104
- landscape orientation
 - selecting, Windows 99
- last page
 - printing on different paper (Windows) 106
- left door
 - jams, clearing 230
- license, software 266
- light/dark settings
 - fax 158
- lighter/darker scanning 148
- lightness
 - copy contrast 138
 - fax light/dark 158
- link speed settings 36
- loading paper
 - input tray 70
- logs, fax
 - error 181

M

- Mac
 - changing paper types and sizes 113
 - driver settings 53, 101
 - faxing 56
 - HP Utility 51
 - problems, troubleshooting 258

- removing software 54
- scanning from TWAIN-compliant software 145
- supported operating systems 50

Macintosh

- resize documents 113
- support 216, 270
- Macintosh driver settings
 - custom-size paper 113
 - watermarks 113
- managing network 34
- manual faxing
 - send 171
- matching colors 128
- material restrictions 285
- Material Safety Data Sheet (MSDS) 289
- media
 - custom-size, Macintosh settings 113
 - first page 101
 - pages per sheet 102
 - supported sizes 65
- memory
 - deleting faxes 165
 - reprinting faxes 173
- menu
 - control panel, access 18
 - copy 14
 - Device setup 24
 - fax 16
 - Fax setup 19
 - HP Digital Solutions Setup 24
 - Network config 22
 - scan 17
 - Service 29
- menus, control panel
 - Reports 30
- mercury-free product 285
- model
 - comparison 1
 - number, locating 8
- models, feature overview 2
- monitor dialing 171
- multiple pages per sheet 102
- printing (Windows) 97

- N**
- n-up printing 102
 - selecting (Windows) 97
 - network
 - configuring 22
 - password, changing 35
 - password, setting 35
 - settings, changing 34
 - settings, viewing 34
 - Network config menu 22
 - networks
 - default gateway 35
 - HP Web Jetadmin 204
 - IPv4 address 35
 - subnet mask 35
 - networks, wired
 - installing product 33
 - non-HP supplies 79
 - notes iii
 - number of copies, changing 132
- O**
- obtaining
 - IP address 33
 - OCR software 146
 - online help, control panel 12
 - online support 216, 270
 - opening printer drivers
 - (Windows) 90
 - operating environment,
 - specifications 273
 - operating systems supported 42, 50
 - optical character recognition
 - software 146
 - ordering
 - supplies and accessories 262
 - ordering supplies
 - Web sites 261
 - orientation
 - selecting, Windows 99
 - output bin
 - jams, clearing 232
 - locating 5
 - outside lines
 - dial prefixes 156
 - pauses, inserting 156
- P**
- page sizes
 - scaling documents to fit
 - (Windows) 109
 - pages per sheet 102
 - selecting (Windows) 97
 - paper
 - copy settings 139
 - covers, using different paper 106
 - custom-size, Macintosh
 - settings 113
 - default size for tray 74
 - fax autoreduction settings 161
 - first and last pages, using
 - different paper 106
 - first page 101
 - jams 220
 - pages per sheet 102
 - selecting 240
 - supported sizes 65
 - paper path
 - jams, clearing 230
 - paper pickup problems
 - solving 220
 - paper size
 - changing 64
 - paper sizes
 - selecting 94
 - selecting custom 95
 - paper type
 - changing 236
 - paper types
 - changing 64
 - selecting 95
 - paper, ordering 262
 - paper, special
 - printing (Windows) 104
 - pauses, inserting 156
 - PBX
 - faxing 163
 - PCL drivers 42
 - universal 44
 - PCL font list 30
 - PCL6 font list 30
 - phone book, fax
 - adding entries 167
 - phones
 - receiving faxes from 173
 - phones, downstream
 - sending faxes from 170
 - photos
 - copying 140
 - scanning 150
 - physical specifications 272
 - pixels per inch (ppi), scanning
 - resolution 147
 - Plug and Print USB Drive printing 121
 - polling faxes 162
 - portrait orientation
 - selecting, Windows 99
 - ports
 - locating 6, 7
 - power
 - consumption 272
 - ppi (pixels per inch), scanning
 - resolution 147
 - prefixes, dial 156
 - presets (Mac) 101
 - print cartridges
 - door release, locating 5
 - recycling 79, 281
 - print job
 - canceling 113
 - canceling, with Windows 104
 - print media
 - supported 65
 - print quality
 - improving 236
 - improving (Windows) 94
 - print quality page
 - interpreting 83, 241
 - printing 83, 241
 - printer driver
 - configuring wireless network 38
 - printer drivers
 - choosing 243
 - printer drivers (Mac)
 - changing settings 53
 - settings 101
 - printer drivers (Windows)
 - changing settings 45
 - settings 90
 - supported 42
 - printing
 - edge-to-edge 138

- from USB storage accessories 121
- settings (Mac) 101
- settings (Windows) 90
- printing on both sides
 - settings (Windows) 96
- priority, settings 45, 52
- problem-solving
 - no response 245
 - slow response 246
- product
 - model comparison 1
 - serial number, locating 8
- product overview 2
- protocol settings, fax 182
- PS Emulation drivers 42
- PS font list 30
- pulse-dialing 156

R

- Readiris OCR software 146
- receiving faxes
 - autoreduction settings 161
 - blocking 159
 - error report, printing 181
 - polling 162
 - reprinting 173
 - ring patterns, settings 160
 - rings-to-answer settings 160
 - stamp-received setting 162
 - when you hear fax tones 173
- recycling 4, 281
 - HP printing supplies returns and environmental program 282
- recycling supplies 79
- redialing
 - automatically, settings 157
- reducing documents
 - copying 135
- removing Mac software 54
- removing Windows software 47
- reports
 - event log 198
 - fax 21
 - network configuration page 198
 - PCL font list 199
 - printer status report 198
 - PS font list 199

- PS fonts list 199
- quality report 198
- Reports menu 30
- reports, fax
 - error 181
- reprinting faxes 173
- resize documents
 - Macintosh 113
 - Windows 109
- resizing documents
 - copying 135
- resolution
 - fax 158
 - scanning 147
- restoring factory-set defaults 219
- ring patterns 160
- ring tones
 - distinctive 160
- rings-to-answer setting 160

S

- scale documents
 - Macintosh 113
 - Windows 109
- scaling documents
 - copying 135
- scan menu 17
- scanner
 - glass cleaning 137, 149, 210, 244
- scanning
 - adjust 148
 - canceling 146
 - color 147
 - from Mac software 57
 - grayscale 148
 - methods 144
 - OCR software 146
 - photos 150
 - resolution 147
 - TWAIN-compliant software 145
 - WIA-compliant software 145
- send faxes
 - monitor dialing 171
- sending faxes
 - canceling 163
 - confirmation 170
 - delaying 170
 - error report, printing 181

- forwarding 159
- from downstream telephone 170
- from software 169
- serial number, locating 8
- Service menu 29
- settings
 - driver presets (Mac) 101
 - drivers 45
 - drivers (Mac) 53
 - factory-set defaults, restoring 219
 - priority 45, 52
- shortcuts (Windows)
 - creating 92
 - using 91
- size 272
- size, copy
 - reducing or enlarging 135
- sizes, media
 - Fit to Page setting, faxing 161
- small documents
 - copying 134
- software
 - embedded Web server 48
 - HP Utility 51
 - installing, USB connections 32
 - installing, wired networks 34
 - problems 256
 - Readiris Pro OCR 146
 - scanning from TWAIN or WIA 145
 - sending faxes 169
 - settings 45, 52
 - software license agreement 266
 - supported operating systems 42, 50
 - uninstalling for Windows 47
 - uninstalling Mac 54
 - Windows 48
 - Windows components 41
- solve
 - fax problems 182
- solve problems
 - fax 193
- solving
 - network problems 248

- Plug and Print USB Drive
 - printing problems 247
 - USB direct-connect problems 248
- special paper
 - printing (Windows) 104
- specifications
 - electrical and acoustic 272
 - environmental 273
 - physical 272
- speed dials
 - programming 167
- speed-dial entries
 - creating 154
 - editing 154
- standby
 - disabling 208
 - enabling 208
- status
 - Home screen, control panel 10
 - HP Utility, Mac 51
- storing
 - environmental specifications 273
 - ink cartridges 79
- subnet mask 35
- supplies
 - counterfeit 79
 - non-HP 79
 - ordering 261, 262
 - recycling 79, 281
 - status, viewing with HP Utility 51
- support
 - online 216, 270
- supported media 65

T

- TCP/IP
 - manually configuring IPv4 parameters 35
- technical support
 - online 216, 270
- telephones
 - receiving faxes from 173
- telephones, downstream
 - sending faxes from 170
- temperature specifications
 - environment 273
- tips iii

- tone-dialing 156
- touch screen, clean 212
- Tray 1
 - jams, clearing 224
- Tray 2
 - jams, clearing 228, 229
- Tray 3
 - part number 262
- trays
 - default paper size 74
 - jams, clearing 228, 229
 - locating 5
 - selecting (Windows) 95
- troubleshooting
 - checklist 217
 - fax error-correction setting 182
 - faxes 174
 - jams 220
 - Mac problems 258
 - network problems 248
 - paper feed problems 220
 - Plug and Print USB Drive printing problems 247
 - receive fax 189
 - send fax 182
 - USB direct-connect problems 248
- TWAIN-compliant software, scanning from 145
- two-sided printing
 - settings (Windows) 96

U

- unblocking fax numbers 159
- uninstalling Mac software 54
- uninstalling Windows software 47
- universal print driver 44
- USB cable, part number 262
- USB configuration 32
- USB port
 - locating 6, 7
- USB storage accessories
 - printing from 121

V

- V.34 setting 182
- VoIP
 - faxing 164
- volume, adjusting 161

W

- warnings iii
- warranty
 - license 266
 - product 264
- Waste disposal 286
- watermarks 113
 - adding (Windows) 110
- Web printing
 - HP ePrint 36
- Web sites
 - customer support 216, 270
 - HP Web Jetadmin, downloading 204
 - Macintosh customer support 216, 270
 - Material Safety Data Sheet (MSDS) 289
 - ordering supplies 261
 - universal print driver 44
- websites
 - fraud reports 79
- weight 272
- WIA-compliant software, scanning from 145
- Windows
 - driver settings 45
 - drivers supported 42
 - faxing from 169
 - scanning from TWAIN or WIA software 145
 - software components 41, 48
 - supported operating systems 42
 - universal print driver 44
- wireless
 - configuring 22
- wireless network
 - configuring with the setup wizard 37
 - configuring with WPS 38
 - installing the driver 38
- wireless network connection 37
- Wireless Setup Wizard
 - configuring wireless network 37
- WPS
 - configuring wireless network 38

