

HP Officejet J4500/J4660/J4680 All-in-One series User Guide

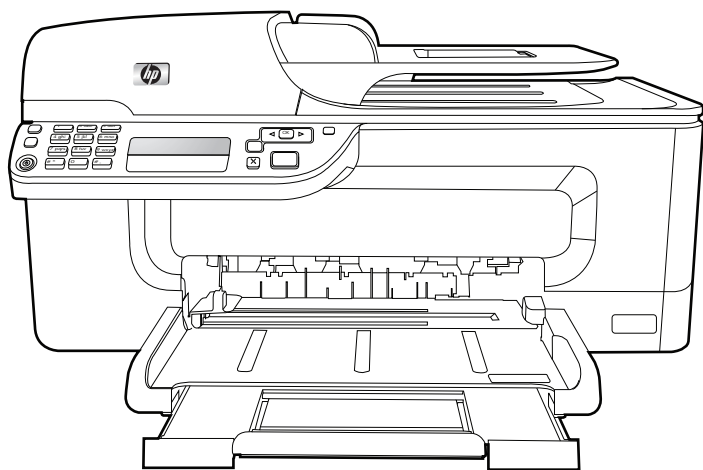

HP Officejet J4500/J4660/J4680
All-in-One series
User Guide



Copyright information

© 2008 Copyright Hewlett-Packard Development Company, L.P.

Hewlett-Packard Company notices

The information contained in this document is subject to change without notice.

All rights reserved. Reproduction, adaptation, or translation of this material is prohibited without prior written permission of Hewlett-Packard, except as allowed under copyright laws.

The only warranties for HP products and services are set forth in the express warranty statements accompanying such products and services. Nothing herein should be construed as constituting an additional warranty. HP shall not be liable for technical or editorial errors or omissions contained herein.

Acknowledgements

Windows, Windows XP, and Windows Vista are U.S. registered trademarks of Microsoft Corporation.

ENERGY STAR and the ENERGY STAR mark are registered U.S. marks.

Safety information



Always follow basic safety precautions when using this product to reduce risk of injury from fire or electric shock.

1. Read and understand all instructions in the documentation that comes with the device.
2. Use only a grounded electrical outlet when connecting this product to a power source. If you do not know whether the outlet is grounded, check with a qualified electrician.
3. Observe all warnings and instructions marked on the product.
4. Unplug this product from wall outlets before cleaning.
5. Do not install or use this product near water, or when you are wet.
6. Install the product securely on a stable surface.
7. Install the product in a protected location where no one can step on or trip over the line cord, and the line cord cannot be damaged.
8. If the product does not operate normally, see [Maintain and troubleshoot](#).

9. There are no user-serviceable parts inside. Refer servicing to qualified service personnel.

Accessibility

The device provides a number of features that make it accessible for people with disabilities.

Visual

The device software is accessible for users with visual impairments or low vision through the use of your operating system's accessibility options and features. It also supports most assistive technology such as screen readers, Braille readers, and voice-to-text applications. For users who are color blind, colored buttons and tabs used in the software and on the device control panel have simple text or icon labels that convey the appropriate action.

Mobility

For users with mobility impairments, the device software functions can be executed through keyboard commands. The software also supports Windows accessibility options such as StickyKeys, ToggleKeys, FilterKeys, and MouseKeys. The device doors, buttons, paper trays, and paper guides can be operated by users with limited strength and reach.

Support

For more details about the accessibility of this product and HP's commitment to product accessibility, visit HP's Web site at www.hp.com/accessibility.

For accessibility information for the Mac OS, visit the Apple Web site at www.apple.com/accessibility.

Contents

1 Get started	
Find other resources for the product	8
Understand the device parts	9
Front view	10
Printing supplies area	10
Back view	11
Device control panel buttons and lights	11
Device control panel buttons and lights	13
Connection information	14
2 Use the device	
Use device control panel menus	16
Device control-panel message types	16
Status messages	16
Warning messages	17
Error messages	17
Critical error messages	17
Change device settings	17
Use the HP Solution Center (Windows)	18
Use the HP photo and imaging software	18
Load originals	19
Load an original on the scanner glass	20
Load an original in the automatic document feeder (ADF)	21
Select print media	22
Tips for selecting and using print media	22
Understand specifications for supported media	23
Understand supported sizes	23
Understand supported media types and weights	26
Set minimum margins	26
Load media	27
Print on special and custom-sized media	28
Print borderless	29
Set up speed-dial entries	30
Set up fax numbers as speed-dial entries or groups	31
Set up speed-dial entries	31
Set up a speed-dial group	31
Print and view a list of speed-dial entries	32
View a list of speed-dial entries	32
3 Print	
Change print settings	33
Change settings from an application for current jobs (Windows)	33
Change default settings for all future jobs (Windows)	33
Change settings (Mac OS)	34
Cancel a print job	34

4 Scan	
Scan an original	35
Scan an original (direct connection)	35
Scan from a TWAIN-compliant or a WIA-compliant program	36
Scan from a TWAIN-compliant program	36
Scan from a WIA-compliant program	36
Edit a scanned original	36
Edit a scanned photo or graphic	37
Edit a scanned document using optical character recognition (OCR) software	37
Change scan settings	37
Cancel a scan job	37
5 Copy	
Make copies	38
Cancel a copy job	39
6 Fax	
Send a fax	40
Send a basic fax	40
Send a fax manually from a phone	41
Send a fax using monitor dialing	43
Send a fax from memory	43
Schedule a fax to send later	44
Send a fax to multiple recipients	44
Send a fax to multiple recipients from the device control panel	45
Send a color original or photo fax	45
Change the fax resolution and Lighter / Darker settings	46
Change the fax resolution	46
Change the Lighter / Darker setting	47
Set new default settings	47
Send a fax in Error Correction Mode	47
Receive a fax	48
Receive a fax manually	48
Set up backup fax	49
Reprint received faxes from memory	50
Poll to receive a fax	50
Forward faxes to another number	51
Set the paper size for received faxes	52
Set automatic reduction for incoming faxes	52
Block junk fax numbers	52
Add numbers to the junk fax list	53
Remove numbers from the junk fax list	53
Receive faxes to your computer	53
Activate Fax to PC	54
Modify Fax to PC settings	55

Change fax settings	55
Configure the fax header	55
Set the answer mode (Auto answer)	56
Set the number of rings before answering	56
Change the answer ring pattern for distinctive ring	57
Set the fax error correction mode	57
Set the dial type	58
Set the redial options	58
Set the fax speed	58
Fax over the Internet	59
Test fax setup	60
Use reports	60
Print fax confirmation reports	61
Print fax error reports	61
Print and view the fax log	62
Cancel a fax	62
7 Configure and manage	
Manage the device	63
Monitor the device	63
Administer the device	64
Use device management tools	64
Toolbox (Windows)	64
Open the Toolbox	65
Toolbox tabs	65
Embedded Web server (HP Officejet J4680 only)	66
To open the embedded Web server	66
Embedded Web server pages	66
HP Printer Utility (Mac OS)	67
Open the HP Printer Utility	67
HP Printer Utility panels	67
Understand the self-test report	68
Set up faxing for the device	69
Set up faxing (parallel phone systems)	69
Choose the correct fax setup for your home or office	70
Select your fax setup case	72
Case A: Separate fax line (no voice calls received)	73
Case B: Set up the device with DSL	74
Case C: Set up the device with a PBX phone system or an ISDN line	75
Case D: Fax with a distinctive ring service on the same line	76
Case E: Shared voice/fax line	77
Case F: Shared voice/fax line with voice mail	78
Case G: Fax line shared with computer modem (no voice calls received)	79
Case H: Shared voice/fax line with computer modem	81
Case I: Shared voice/fax line with answering machine	85
Case J: Shared voice/fax line with computer modem and answering machine	86
Case K: Shared voice/fax line with computer dial-up modem and voice mail	90
Serial-type fax setup	92

Configure the device (Windows)	93
Install the software before connecting the device (recommended)	93
Connect the device before installing the software	94
Share the device on a locally shared network	94
Configure the device (Mac OS)	95
To install the software	95
Share the device on a locally shared network	95
Set up the device for wireless communication (HP Officejet J4680 only)	96
Understand 802.11 wireless network settings	97
To set up wireless communication using the device control panel with wireless setup wizard	98
To set up wireless communication using the installer (Windows)	99
To set up the device on a wireless network (Mac OS)	99
To turn off wireless communication	100
To print a wireless test page	100
Reset wireless settings	100
Guidelines for reducing interference on a wireless network	100
Guidelines for ensuring wireless network security	100
To add hardware addresses to a WAP	101
Other guidelines	101
Uninstall and reinstall the software	101

8 Maintain and troubleshoot

Work with ink cartridges	104
Supported ink cartridges	104
Handle the ink cartridges	105
Replace the ink cartridges	105
Align the ink cartridges	108
Clean the ink cartridges	110
Clean the ink cartridge contacts	111
Clean the area around the ink nozzles	112
Store printing supplies	114
Clean the device	115
Clean the scanner glass	115
Clean the exterior	116
Clean the automatic document feeder	116
General troubleshooting tips and resources	119
Solve printing problems	120
The device shuts down unexpectedly	120
Error message appears on control-panel display	120
The device is not responding (nothing prints)	121
Device takes a long time to print	121
Blank or partial page printed	121
Something on the page is missing or incorrect	122
Placement of the text or graphics is wrong	122
The device prints half a page, then ejects the paper	123

Contents

Poor print quality and unexpected printouts	123
Common poor quality printout problems	124
Meaningless characters print	124
Ink is smearing	125
Ink is not filling the text or graphics completely	125
Output is faded or dull colored	126
Colors are printing as black and white	126
Wrong colors are printing	126
Printout shows bleeding colors	127
Colors do not line up properly	127
Lines or dots are missing from text or graphics	127
Solve paper-feed problems	127
Solve scan problems	129
Scanner did nothing	129
Scan takes too long	130
Part of the document did not scan or text is missing	130
Text cannot be edited	130
Error messages appear	131
Scanned image quality is poor	131
Scan defects are apparent	132
Solve copy problems	133
No copy came out	133
Copies are blank	133
Documents are missing or faded	134
Size is reduced	134
Copy quality is poor	134
Copy defects are apparent	135
The device prints half a page, then ejects the paper	135
Error messages appear	135
Paper mismatch	135
Solve fax problems	136
The fax test failed	136
Solve wireless problems (HP Officejet J4680 only)	148
Troubleshoot installation issues	150
Hardware installation suggestions	150
Software installation suggestions	151
Clear jams	152
Clear paper jams	152
Avoid paper jams	154
A HP supplies and accessories	
Order printing supplies online	155
Supplies	155
HP media	155
B Support and warranty	
Hewlett-Packard limited warranty statement	157
Obtain electronic support	158

Obtain HP telephone support	158
Before you call	158
Support process	159
HP support by phone	159
Phone support period	159
Telephone support numbers	159
Placing a call	159
After the phone support period	159
Additional warranty options	160
HP Quick Exchange Service (Japan)	160
Call HP Korea customer support	160
Prepare the device for shipment	161
Remove the ink cartridges before shipment	161
Pack the device	162
C Device specifications	
Physical specifications	164
Product features and capacities	165
Processor and memory specifications	165
System requirements	165
Network protocol specifications	166
Embedded Web server specifications	167
Print specifications	167
Fax specifications	167
Scan specifications	168
Environmental specifications	168
Electrical specifications	168
Acoustic emission specifications (print in Draft mode, noise levels per ISO 7779)	168
D Regulatory information	
FCC statement	171
Notice to users in Korea	171
VCCI (Class B) compliance statement for users in Japan	172
Notice to users in Japan about the power cord	172
RoHS notices (China only)	172
Noise emission statement for Germany	172
Notice to users of the U.S. telephone network: FCC requirements	173
Notice to users of the Canadian telephone network	174
Notice to users in the European Economic Area	175
Notice to users of the German telephone network	175
Australia wired fax statement	175
Regulatory information for wireless products	176
Exposure to radio frequency radiation	176
Notice to users in Brazil	176
Notice to users in Canada	176
Notice to users in Taiwan	177
European Union regulatory notice	178
Warning for Australia and New Zealand with phone handset	178
Regulatory model number	179

Contents

Declaration of conformity	179
J4500	180
J4660	181
J4680	182
Energy Star® notice	183
Index	184

1 Get started

This guide provides details about how to use the device and to resolve problems.

- [Find other resources for the product](#)
- [Understand the device parts](#)

 **NOTE:** If you are using the device with a computer running Windows 2000, Windows XP Starter Edition, or Windows XP x64, some features might not be available. For more information, see [Operating system compatibility](#).

Find other resources for the product

You can obtain product information and further troubleshooting resources that are not included in this guide from the following resources:

Resource	Description	Location
Setup poster	Provides illustrated setup information.	A printed version of the document is provided with the device.
Readme file and release notes	Provide late-breaking information and troubleshooting tips.	Included on the Starter CD.
Toolbox (Microsoft® Windows®)	Provides access to maintenance services. For more information, see Toolbox (Windows) .	The Toolbox is typically installed with the device software as an available installation option.
HP Printer Utility (Mac OS)	Contains tools to configure print settings, calibrate the device, clean the ink cartridges, print the configuration page, order supplies online, and find support information from the Web site. For more information, see HP Printer Utility (Mac OS) .	The HP Printer Utility is typically installed with the device software.
Device control panel	Provides status, error, and warning information about operations.	For more information, see Device control panel buttons and lights .
Logs and reports	Provides information about events that have occurred.	For more information, see Monitor the device .
Self-Test diagnostic page	<ul style="list-style-type: none">• Device information:<ul style="list-style-type: none">◦ Product name◦ Model number	For more information, see Understand the self-test report .

(continued)

Resource	Description	Location
	<ul style="list-style-type: none">◦ Serial number◦ Firmware version number• Number of pages printed from the trays and accessories• Ink levels• Ink cartridge health status	
HP Web sites	Provide the latest printer software, and product and support information.	www.hp.com/support www.hp.com
HP telephone support	Lists information to contact HP. During the warranty period, this support is often free of charge.	For more information, see Obtain HP telephone support .
HP photo and imaging software help	Provides information about using the software.	For more information, see Use the HP photo and imaging software .
Control Panel Guide	Device control panel instructions	Available through Solution Center and Toolbox (Windows).

Understand the device parts

- [Front view](#)
- [Printing supplies area](#)
- [Back view](#)
- [Device control panel buttons and lights](#)
- [Device control panel buttons and lights](#)
- [Connection information](#)

Front view

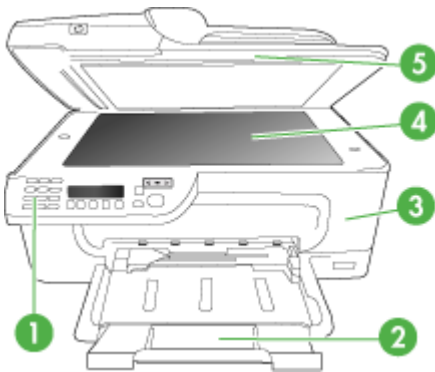

1	Device control panel
2	Main tray
3	Front access door
4	Scanner glass
5	Automatic document feeder

Printing supplies area

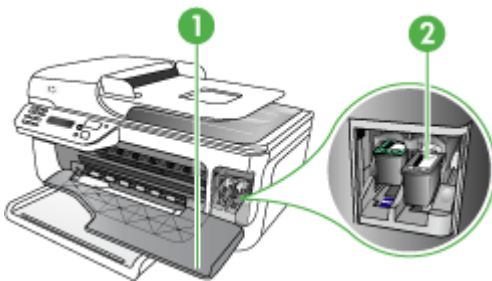

1	Front access door
2	Ink cartridges

Back view

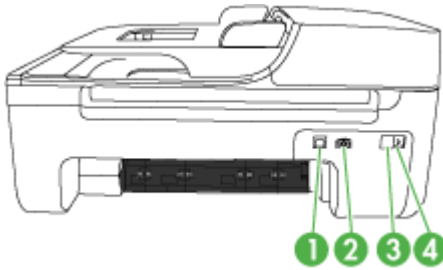

1	Rear universal serial bus (USB) port
2	Power input
3	1-LINE (fax)
4	2-EXT (phone)

Device control panel buttons and lights

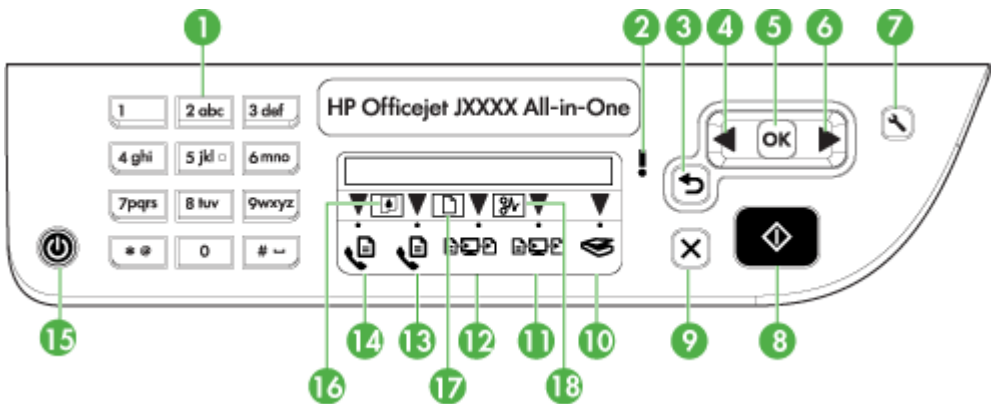

The following diagram and related table provide a quick reference to the device control panel features.

Label	Name and Description
1	Keypad: Enters values.
2	Attention light: Indicates an error condition.
3	Back button: Reverts back to its previous setting or upper level menu.
4	Left arrow button: Navigates forward through settings in the menus.
5	OK button: Selects the current menu or setting.
6	Right arrow button: Navigates in reverse through settings in the menus.

Label	Name and Description
7	Setup: Presents the Setup menu for generating reports and other maintenance settings, and for accessing the Help menu. The topic that you select from the Help menu opens a help window on your computer screen.
8	Start: Initiates a copy, fax, or scan job. Pressing Start processes the job according to the function selected. NOTE: To make a copy, the HP All-in-One must be connected to a computer, the computer must be turned on and you must be logged on, and the software must be installed and running. Also, the HP Digital Imaging Monitor in the Windows Taskbar must be installed and turned on at all times. On a Macintosh computer, once the software is installed, it is always available when you turn on the computer.
9	Cancel: Stops a job, exits a menu, or exits settings.
10	Scan function indicator
11	PC Copy Color function indicator
12	PC Copy B&W function indicator
13	Fax Color function indicator
14	Fax B&W function indicator
15	Power: Turns the device on or off. The Power button is lit when the device is on. The light blinks while performing a job. When the device is turned off, a minimal amount of power is still supplied. To completely disconnect the power supply, turn the device off, and then unplug the power cord.
16	Low ink indicator
17	Original loaded indicator
18	Paper jam indicator

Device control panel buttons and lights

Figure 1-1 Model J4660 device control panel

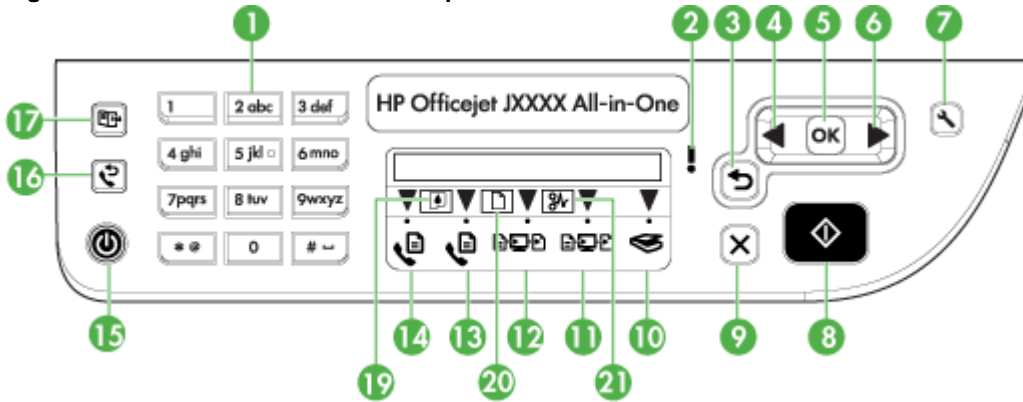
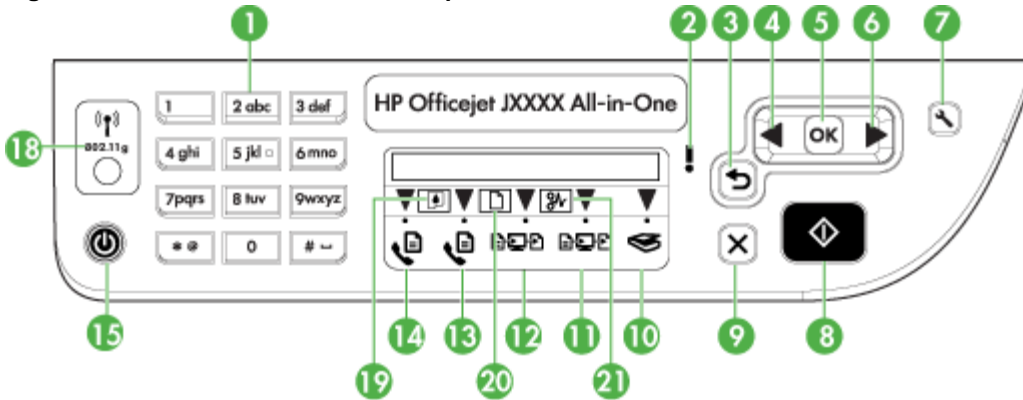

Figure 1-2 Model J4680 device control panel



Label	Name and Description
1	Keypad: Enters values.
2	Attention light: Indicates an error condition.
3	Back button: Reverts back to its previous setting or upper level menu.
4	Left arrow button: Navigates forward through settings in the menus.
5	OK button: Selects the current menu or setting.
6	Right arrow button: Navigates in reverse through settings in the menus.
7	Setup: Presents the Setup menu for generating reports and other maintenance settings, and for accessing the Help menu. The topic that you select from the Help menu opens a help window on your computer screen.
8	Start: Initiates a copy, fax, or scan job. Pressing Start processes the job according to the function selected.

Label	Name and Description
	<p>NOTE: To make a copy, the HP All-in-One must be connected to a computer, the computer must be turned on and you must be logged on, and the software must be installed and running. Also, the HP Digital Imaging Monitor in the Windows Taskbar must be installed and turned on at all times.</p> <p>On a Macintosh computer, once the software is installed, it is always available when you turn on the computer.</p>
9	Cancel: Stops a job, exits a menu, or exits settings.
10	Scan function indicator
11	PC Copy Color function indicator
12	PC Copy B&W function indicator
13	Fax Color function indicator
14	Fax B&W function indicator
15	<p>Power: Turns the device on or off. The Power button is lit when the device is on. The light blinks while performing a job.</p> <p>When the device is turned off, a minimal amount of power is still supplied. To completely disconnect the power supply, turn the device off, and then unplug the power cord.</p>
16	Redial button (model J4660): Displays the last number dialed.
17	Speed dial button (model J4660): Selects the first entry in the list of programmed speed dial entries.
18	Wireless button (model J4680): Turns the 802.11g wireless feature on or off. The button is lit when the wireless feature is on.
19	Low ink indicator
20	Original loaded indicator
21	Paper jam indicator

Connection information

Description	Recommended number of connected computers for best performance	Supported software features	Setup instructions
USB connection	One computer connected with a USB cable to the rear USB 2.0 high-speed port on the device.	All features are supported.	Follow the setup poster guide for detailed instructions.
Printer sharing	Up to five computers. The host computer must be turned on at all times, or the other computers cannot print to the device.	All features resident on the host computer are supported. Only print is supported from the other computers.	Follow the instructions in Share the device on a locally shared network .

(continued)

Description	Recommended number of connected computers for best performance	Supported software features	Setup instructions
802.11 wireless (HP Officejet J4680 only)	Up to five computers connected to the device using a hub or router.	All features are supported, including Webscan.	Follow the instructions in Set up the device for wireless communication (HP Officejet J4680 only) .

2 Use the device

This section contains the following topics:

- [Use device control panel menus](#)
- [Device control-panel message types](#)
- [Change device settings](#)
- [Use the HP Solution Center \(Windows\)](#)
- [Use the HP photo and imaging software](#)
- [Load originals](#)
- [Select print media](#)
- [Load media](#)
- [Print on special and custom-sized media](#)
- [Print borderless](#)
- [Set up speed-dial entries](#)

Use device control panel menus

The following sections provide a quick reference to top-level menus that appear on the control-panel display. To display a menu, press the menu button for the function you want to use.

- **Scan menu:** Presents a list of destinations. Some destinations require the HP Photosmart Software to be loaded.
- **Fax menu:** Allows you to enter a fax or speed-dial number, or display the Fax menu. Menu options include:
 - Modifying resolution
 - Lightening/darkening
 - Sending delayed faxes
 - Setting up new defaults

Device control-panel message types

This section contains the following topics:

- [Status messages](#)
- [Warning messages](#)
- [Error messages](#)
- [Critical error messages](#)

Status messages

Status messages reflect the current state of the device. They inform you of normal operation and require no action to clear them. They change as the state of the device changes. Whenever the device is ready, not busy, and has no pending warning messages, the date and time appear if the device is turned on.

Warning messages

Warning messages inform you of events that require your attention, but they do not prevent the device from operating. An example of a warning message is **Low On Ink**.

Error messages

Error messages communicate that some action must be performed, such as adding media or clearing a media jam. These messages are usually accompanied by a blinking red Attention light. Take the appropriate action to continue printing.

If the error message shows an error code, press the Power button to turn off the device, and then turn it on again. In most situations, this action solves the problem. If the message persists, your device might need service.

Critical error messages

Critical error messages inform you of a device failure. Some of these messages can be cleared by pressing the Power button to turn off the device, and then turning it on again. If a critical error persists, service is required. For more information, see [Support and warranty](#).

Change device settings

You can change the device settings from these places:

- From the device control panel.
- From the HP Solution Center (Windows) or HP Device Manager (Mac OS). For more information, see [Use the HP photo and imaging software](#).

 **NOTE:** When you are configuring settings in HP Solution Center or in the HP Device Manager, you cannot see the settings that have been configured from the device control panel.

To change settings from the device control panel

1. At the device control panel, press the left or right arrow keys to navigate to the function you are using (for example, Fax). Press **OK** to select that function.
2. To reach the option that you want to change, use one of the following methods:
 - Press a control-panel button, and then use the left or right arrow keys to adjust the value.
 - Select the option from the menu on the control-panel display.
3. Select the value that you want, and then press **OK**.

To change settings from the HP Solution Center (Windows)

- ▲ See [Use the HP photo and imaging software](#).

To change settings from the HP photo and imaging software (Mac OS)

1. Click the **HP Device Manager** icon in the Dock.
2. Select the device in the **Devices** drop-down menu.
3. On the **Information and Settings** menu, click an item that you want to change.

Use the HP Solution Center (Windows)

On a Windows computer, the HP Solution Center is the entry point for the HP Photosmart Software. Use the HP Solution Center to change print settings, order supplies, and access the onscreen Help.

The features available in the HP Solution Center vary depending on the devices you have installed. The HP Solution Center is customized to show icons that are associated with the selected device. If the selected device is not equipped with a particular feature, then the icon for that feature does not appear in the HP Solution Center.

If the HP Solution Center on your computer does not contain any icons, an error might have occurred during the software installation. To correct this, use the Control Panel in Windows to completely uninstall the HP Photosmart Software, and then reinstall the software. For more information, see the onscreen Help that came with the device.

For information about opening the HP Solution Center, see [Use the HP photo and imaging software](#).

Use the HP photo and imaging software

You can use the HP photo and imaging software to access many features that are not available from the device control panel.

The software is installed on your computer during setup. For further information, see the setup documentation that came with your device.

Access to the HP photo and imaging software differs by operating system (OS). For example, if you have a Windows computer, the HP photo and imaging software entry point is the HP Photosmart Software window. If you have a Macintosh computer, the HP photo and imaging software entry point is the HP Photosmart Studio window.

Regardless, the entry point serves as the launching pad for the HP photo and imaging software and services.

To open the HP Photosmart Software on a Windows computer

1. Do one of the following:
 - On the Windows desktop, double-click the HP Photosmart Software icon.
 - In the system tray at the far right of the Windows taskbar, double-click the **HP Digital Imaging Monitor** icon.
 - On the taskbar, click **Start**, point to **Programs** or **All Programs**, select **HP**, and then click **HP Photosmart Software**.
2. If you have more than one HP device installed, select the tab with your product's name.

 **NOTE:** On a Windows computer, the features available in the HP Photosmart Software vary depending on the devices you have installed. The software is customized to show icons that are associated with the selected device. If the selected device is not equipped with a particular feature, then the icon for that feature does not appear in the software.

 **TIP:** If the HP Photosmart Software on your computer does not contain any icons, an error might have occurred during the software installation. To correct this, use the Control Panel in Windows to completely uninstall the HP Photosmart Software; then reinstall the software. For more information, see the setup poster that came with your device.

To open the HP Photosmart Studio software on a Macintosh computer

1. Click the HP Photosmart Studio icon in the Dock.
The HP Photosmart Studio window appears.
2. In the HP Photosmart Studio task bar, click **Devices**.
The HP Device Manager window appears.
3. Select your device from the **Device** drop-down menu.
From here, you can scan, import documents, and perform maintenance procedures such as checking the ink levels for the ink cartridges.

 **NOTE:** On a Macintosh computer, the features available in the HP Photosmart Studio software vary depending on the selected device.

 **TIP:** When the HP Photosmart Studio software is opened, you can gain access to the Dock menu shortcuts by selecting and holding the mouse button over the HP Photosmart Studio icon in the Dock.

Load originals

You can load an original for a copy or a scan job on the scanner glass.

- [Load an original on the scanner glass](#)
- [Load an original in the automatic document feeder \(ADF\)](#)

 **NOTE:** To make a copy, the HP All-in-One must be connected to a computer, the computer must be turned on and you must be logged on, and the software must be installed and running. Also, the **HP Digital Imaging Monitor** in the Windows Taskbar must be installed and turned on at all times.

On a Macintosh computer, once the software is installed, it is always available when you turn on the computer.

Load an original on the scanner glass

You can copy, scan, or fax up to letter- or A4-size originals by loading them on the glass.

 **NOTE:** Many of the special features will not work correctly if the glass and lid backing are not clean. For more information, see [Clean the device](#).

NOTE: To make a copy, the HP All-in-One must be connected to a computer, the computer must be turned on and you must be logged on, and the software must be installed and running. Also, the **HP Digital Imaging Monitor** in the Windows Taskbar must be installed and turned on at all times.

On a Macintosh computer, once the software is installed, it is always available when you turn on the computer.

To load an original on the scanner glass

1. Lift the scanner lid.
2. Load your original print side down in the right front corner of the glass.

 **TIP:** For more help on loading an original, refer to the engraved guides along the edge of the glass.



3. Close the lid.

Load an original in the automatic document feeder (ADF)

You can copy, scan, or fax a one-sided, single- or multiple-page, A4- or letter-size document by placing it in the document feeder tray.

△ **CAUTION:** Do not load photos in the ADF; this might cause damage to your photos.

📄 **NOTE:** Two-sided legal-size documents cannot be scanned, copied, or faxed using the ADF. Some features do not work when you load your originals in the ADF. You must load your originals on the glass.

NOTE: To make a copy, the HP All-in-One must be connected to a computer, the computer must be turned on and you must be logged on, and the software must be installed and running. Also, the **HP Digital Imaging Monitor** in the Windows Taskbar must be installed and turned on at all times.

On a Macintosh computer, once the software is installed, it is always available when you turn on the computer.

The document feeder tray holds a maximum of 50 sheets of plain paper.

To load an original in the document feeder tray

1. Load your original, with the print side up, into the document feeder tray. Place the pages so that the top edge of the document goes in first. Slide the media into the automatic document feeder until you hear a beep or see a message on the display indicating that the loaded pages were detected.

💡 **TIP:** For more help on loading originals in the automatic document feeder, refer to the diagram engraved in the document feeder tray.

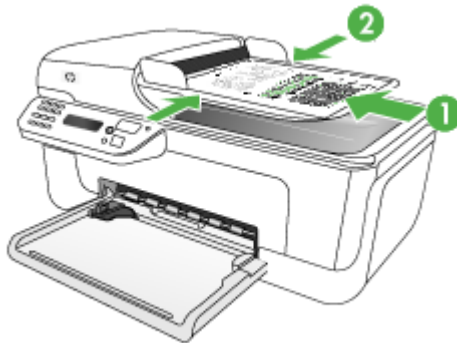

2. Slide the width guides inward until they stop at the left and right edges of the media.

📄 **NOTE:** Remove all originals from the document feeder tray before lifting the lid on the device.

Select print media

The device is designed to work well with most types of office media. It is best to test a variety of print media types before buying large quantities. Use HP media for optimum print quality. Visit the HP Web site at www.hp.com for more information about HP media.

- [Tips for selecting and using print media](#)
- [Understand specifications for supported media](#)
- [Set minimum margins](#)

Tips for selecting and using print media

For the best results, observe the following guidelines.

- Always use media that conforms to the device specifications. For more information, see [Understand specifications for supported media](#).
- Load only one type of media at a time into a tray.
- Load media print-side down and aligned against the right and back edges of the tray. For more information, see [Load media](#).
- Do not overload the trays. For more information, see [Understand specifications for supported media](#).
- To prevent jams, poor print quality, and other printing problems, avoid the following media:
 - Multipart forms
 - Media that is damaged, curled, or wrinkled
 - Media with cutouts or perforations
 - Media that is heavily textured, embossed, or does not accept ink well
 - Media that is too lightweight or stretches easily

Cards and envelopes

- Avoid envelopes that have a very slick finish, self-stick adhesives, clasps, or windows. Also avoid cards and envelopes with thick, irregular, or curled edges, or areas that are wrinkled, torn, or otherwise damaged.
- Use tightly constructed envelopes, and make sure the folds are sharply creased.
- Load envelopes with the flaps facing up.

Photo media

- Use the **Best** mode to print photographs. Note that in this mode, printing takes longer and more memory is required from your computer.
- Remove each sheet as it prints and set it aside to dry. Allowing wet media to stack up may cause smearing.

Transparencies

- Insert transparencies with the rough side down and the adhesive strip pointing towards the back of the device.
- Use the **Normal** mode to print transparencies. This mode provides longer drying time and ensures that the ink dries completely before the next page is delivered to the main tray.
- Remove each sheet as it prints and set it aside to dry. Allowing wet media to stack up may cause smearing.

Custom-sized media

- Use only custom-sized media that is supported by the device.
- If your application supports custom-sized media, set the media size in the application before printing the document. If not, set the size in the print driver. You might need to reformat existing documents to print them correctly on custom-sized media.

Understand specifications for supported media

Use the [Understand supported sizes](#) and [Understand supported media types and weights](#) tables to determine the correct media to use with your device, and determine what features will work with your media.

- [Understand supported sizes](#)
- [Understand supported media types and weights](#)

Understand supported sizes

Media size	Main tray
Standard media sizes	
8.5 x 13 inches (216 x 330 mm)	✓
U.S. Legal (216 x 356 mm; 8.5 x 14 inches)	✓
A4 (210 x 297 mm; 8.3 x 11.7 inches)	✓
U.S. Executive (184 x 267 mm; 7.25 x 10.5 inches)	✓
B5 (182 x 257 mm; 7.17 x 10.12 inches)	✓
A5 (148 x 210 mm; 5.8 x 8.3 inches)	✓
Borderless A4 (210 x 297 mm; 8.3 x 11.7 inches)	✓
Borderless A5 (148 x 210 mm; 5.8 x 8.3 inches)	✓
Borderless B5 (182 x 257 mm; 7.17 x 10.12 inches)	✓
Ofuku hagaki	✓
Borderless B7 ISO	✓

(continued)

Media size	Main tray
Borderless hagaki (100 x 148 mm)	✓
Borderless (10 x 15 cm, tab)	✓
Borderless (4 x 6 inches, tab)	✓
Borderless (4 x 6 inches, tab)	✓
Borderless (10 x 20 cm, tab)	✓
Borderless (4 x 8 inches, tab)	✓
Borderless HV	✓
Borderless A6	✓
Borderless cabinet	✓
Borderless 2L (same dimension as 5 x 7 inches)	✓
Borderless (13 x 18 cm), same dimension as 5 x 7 inches	✓
Borderless (8.5 x 11 inches)	✓
B7 ISO	✓
10 x 15 cm (tab)	✓
4 x 6 inches (tab)	✓
10 x 20 cm (tab)	✓
4 x 8 inches (tab)	✓
HV	✓
Cabinet	✓
2L (same dimension as 5 x 7 inches)	✓
13 x 18 cm (same dimension as 5 x 7 inches)	✓
Envelopes	
U.S. #10 Envelope (105 x 241 mm; 4.12 x 9.5 inches)	✓
Monarch Envelope (98 x 191 mm; 3.88 x 7.5 inches)	✓
Card Envelope (111 x 152 mm; 4.4 x 6 inches)	✓
A2 Envelope (111 x 146 mm; 4.37 x 5.75 inches)	✓
DL Envelope (110 x 220 mm; 4.3 x 8.7 inches)	✓

(continued)

Media size	Main tray
C6 Envelope (114 x 162 mm; 4.5 x 6.4 inches)	✓
Japanese Envelope Chou #3 (120 x 235 mm; 4.7 x 9.3 inches)	✓
Japanese Envelope Chou #4 (90 x 205 mm; 3.5 x 8.1 inches)	✓
Cards	
Index card (76.2 x 127 mm; 3 x 5 inches)	✓
Index card (102 x 152 mm; 4 x 6 inches)	✓
Index card (127 x 203 mm; 5 x 8 inches)	✓
A6 card (105 x 148.5 mm; 4.13 x 5.83 inches)	✓
Borderless A6 card (105 x 148.5 mm; 4.13 x 5.83 inches)	✓
Hagaki** (100 x 148 mm; 3.9 x 5.8 inches)	✓
Photo media	
Photo media (102 x 152 mm; 4 x 6 inches)	✓
Photo media (5 x 7 inches)	✓
Photo media (8 x 10 inches)	✓
Photo media (10 x 15 cm)	✓
Photo L (89 x 127 mm; 3.5 x 5 inches)	✓
Borderless photo media (102 x 152 mm; 4 x 6 inches)	✓
Borderless photo media (5 x 7 inches)	✓
Borderless photo media (8 x 10 inches)	✓
Borderless photo media (8.5 x 11 inches)	✓
Borderless photo media (10 x 15 cm)	✓
Borderless Photo L (89 x 127 mm; 3.5 x 5 inches)	✓
Other media	
Custom-sized media between between 76.20 to 210.06 mm wide and 101.60 to 762.00 mm long (3 to 8.5 inches wide and 4 to 30 inches long)	✓
Panorama (4 x 12 inches)	✓
Borderless panorama (4 x 12 inches)	✓

** The device is compatible with plain and inkjet hagaki from Japan Post only. It is not compatible with photo hagaki from Japan Post.

Understand supported media types and weights

Tray	Type	Weight	Capacity
Main tray	Paper	60 to 105 g/m ² (16 to 28 lb bond)	Up to 100 sheets of plain paper (25 mm or 1 inch stacked)
	Transparencies		Up to 70 sheets (17 mm or 0.67 inch stacked)
	Photo media	280 g/m ² (75 lb bond)	Up to 100 sheets (17 mm or 0.67 inch stacked)
	Labels		Up to 100 sheets (17 mm or 0.67 inch stacked)
	Envelopes	75 to 90 g/m ² (20 to 24 lb bond envelope)	Up to 30 sheets (17 mm or 0.67 inch stacked)
	Cards	Up to 200 g/m ² (110 lb index)	Up to 80 cards
Main tray	All supported media		Up to 100 sheets of plain paper (text printing)

Set minimum margins

The document margins must match (or exceed) these margin settings in portrait orientation.

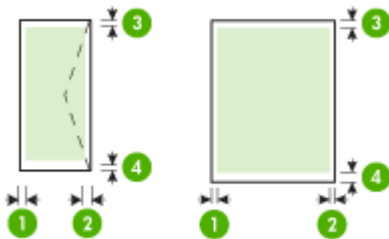

Media	(1) Left margin	(2) Right margin	(3) Top margin	(4) Bottom margin*
U.S. Letter U.S. Legal A4 U.S. Executive U.S. Statement B5 A5 Cards Custom-sized media Photo media	3.0 mm (0.118 inches)	3.0 mm (0.118 inches)	3.0 mm (0.118 inches)	3.0 mm (0.118 inches)
Envelopes	3.0 mm (0.118 inches)	3.0 mm (0.118 inches)	3.0 mm (0.118 inches)	14.3 mm (0.563 inches)

* To achieve this margin setting on a computer running Windows, click the **Advanced** tab in the print driver, and select **Minimize Margins**.

Load media

This section provides instructions for loading media into the device.

To load main tray

1. Pull out the tray extender.



2. Insert the media print-side down along the right of the main tray. Make sure the stack of media aligns with the right and back edges of the tray, and does not exceed the line marking in the tray.

 **NOTE:** Do not load paper while the device is printing.

3. Slide the media guides in the tray to adjust them for the media size that you have loaded.

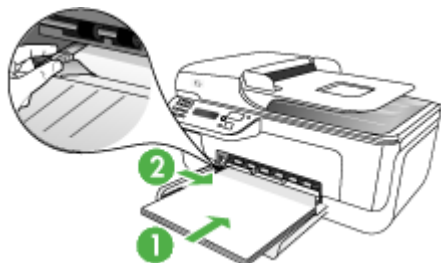

Print on special and custom-sized media

To print on special or custom-sized media (Windows)

1. Load the appropriate media. For more information, see [Load media](#).
2. With a document open, click **Print** on the **File** menu, and then click **Setup**, **Properties**, or **Preferences**.
3. Click the **Paper/Features** tab.
4. Select the media size from the **Size is** drop-down list.

To set a custom media size:

- a. Click the **Custom** button.
 - b. Type a name for the new custom size.
 - c. In the **Width** and **Height** boxes, type the dimensions, and then click **Save**.
 - d. Click **OK** twice to close the properties or preferences dialog box. Open the dialog box again.
 - e. Select the new custom size.
5. To select the media type:
 - a. Click **More** in the **Type is** drop-down list.
 - b. Click the desired media type, and then click **OK**.
 6. Select the media source from the **Source is** drop-down list.
 7. Change any other settings, and then click **OK**.
 8. Print your document.

To print on special or custom-sized media (Mac OS)

1. Load the appropriate media. For more information, see [Load media](#).
2. On the **File** menu, click **Page Setup**.

3. Verify that the correct printer is selected.
4. Select the media size.
5. To set a custom media size:
 - a. Click **Manage Custom Sizes** in the **Paper Size** pull-down menu.
 - b. Click **New** and type a name for the size in the **Paper Size Name** box.
 - c. In the **Width** and **Height** boxes, type the dimensions and set the margins, if desired.
 - d. Click **Done** or **OK**, and then click **Save**.
6. On the **File** menu, click **Page Setup**, and then select the new custom size.
7. Click **OK**.
8. On the **File** menu, click **Print**.
9. Open the **Paper Handling** panel.
10. Under **Destination Paper Size**, click the **Scale to fit paper size** button, and then select the customized paper size.
11. Change any other desired settings, and then click **OK** or **Print**.

Print borderless

Borderless printing lets you print to the edges of certain media types and a range of standard media sizes.

 **NOTE:** Open the file in a software application and assign the image size. Make sure the size corresponds to the media size on which you are printing the image.

You can also gain access to this feature from the **Printing Shortcuts** tab. Open the printer driver, select the **Printing Shortcuts** tab, and select the printing shortcut for this print job drop-down list.

NOTE: Borderless printing is not supported on plain media.

To print a borderless document (Windows)

1. Load the appropriate media. For more information, see [Load media](#).
2. Open the file that you want to print.
3. From the application, open the print driver:
 - a. Click **File**, and then click **Print**.
 - b. Click **Properties** or **Setup**.
4. Click the **Paper/Quality** tab.
5. Select the media size from the **Size is** drop-down list.
6. Select the **Borderless Printing** check box.
7. Select the media source from the **Source is** drop-down list.
8. Select the media type from the **Type is** drop-down list.

 **NOTE:** Borderless printing is not supported on plain media.

9. If you are printing photos, select **Best** from the **Print Quality** drop-down list. Alternatively, select **Maximum dpi**, which provides up to 4800 x 1200 optimized dpi* for optimum print quality.
*Up to 4800 x 1200 optimized dpi for color printing and 1200 input dpi. This setting might temporarily use a large amount of hard disk space (400 MB or more) and will print more slowly.
10. Change any other print settings, and then click **OK**.
11. Print the document.
12. If you printed on photo media with a tear-off tab, remove the tab to make the document completely borderless.

To print a borderless document (Mac OS)

1. Load the appropriate media. For more information, see [Load media](#).
2. Open the file that you want to print.
3. Click **File**, and then click **Page Setup**.
4. Verify that the correct printer is selected.
5. Select the borderless media size, and then click **OK**.
6. Click **File**, and then click **Print**.
7. Open the **Paper Type/Quality** panel.
8. Click the **Paper tab**, and then select the media type from the **Paper type** drop-down list.



NOTE: Borderless printing is not supported on plain media.

9. If you are printing photos, select **Best** from the **Quality** drop-down list. Alternatively, select **Maximum dpi**, which provides up to 4800 x 1200 optimized dpi*.
*Up to 4800 x 1200 optimized dpi for color printing and 1200 input dpi. This setting might temporarily use a large amount of hard disk space (400 MB or more) and will print more slowly.
10. Select the media source. If you are printing on thick or photo media, select the manual feed option.
11. Change any other print settings, and then click **Print**.
12. If you printed on photo media with a tear-off tab, remove the tab to make the document completely borderless.

Set up speed-dial entries

You can set up frequently used fax numbers as speed-dial entries. This lets you dial those numbers quickly by using the device control panel.

- [Set up fax numbers as speed-dial entries or groups](#)
- [Print and view a list of speed-dial entries](#)

Set up fax numbers as speed-dial entries or groups

You can store fax numbers or groups of fax numbers as speed-dial entries. For information about printing a list of the speed-dial entries that are set up, see [Print and view a list of speed-dial entries](#).

- [Set up speed-dial entries](#)
- [Set up a speed-dial group](#)

Set up speed-dial entries

- **HP Solution Center (Windows):** Open the HP Solution Center and follow the instructions in the onscreen Help.
- **HP Device Manager (Mac OS):** Launch **HP Device Manager**, click **Information and Settings**, and then select **Fax Speed Dial Settings** from the drop-down list.
- **Device control panel:** Press **Setup**, select the **Speed Dial** option, and then press **OK**.
 - To add or change an entry: Select **New Speed Dial** or **Group Speed Dial**, and then press the arrow keys to move to an unused entry number, or type a number on the keypad. Type the fax number, and then press **OK**. Include any pauses or other required numbers, such as an area code, an access code for numbers outside a PBX system (usually a 9 or 0), or a long-distance prefix. Type the name, and then press **OK**.
 - To delete one entry or all entries: Select **Delete Speed Dial**, press the arrow keys to highlight the speed-dial entry that you want to delete, and then press **OK**.

Set up a speed-dial group

If you send information to the same group of fax numbers on a regular basis, you can set up a speed-dial entry for a group in order to simplify the task. The speed-dial entry for a group can be associated with a speed-dial button on the device control panel.

A group member must be a member of the speed-dial list before you can add the member to a speed-dial group. You can add up to 20 fax numbers to each group (with up to 50 characters for each fax number).

- **HP Solution Center (Windows):** Open the HP Solution Center and follow the instructions in the onscreen Help.
- **HP Device Manager (Mac OS):** Launch **HP Device Manager**, click **Information and Settings**, and then select **Fax Speed Dial Settings** from the drop-down list.
- **Device control panel:** Press the **Setup** button, select the **Speed Dial** option, and then press **OK**.
 - To add a group: Select **Group Speed Dial**, select an unassigned speed-dial entry, and then press **OK**. Use the arrow keys to highlight a speed-dial entry, and then press **OK** to select it. Repeat this step to add additional speed-dial entries to this group. When finished, exit the menu.
 - To add entries to a group: Select **Group Speed Dial**, select the group speed-dial entry that you want to change, and then press **OK**. Use the arrow keys to highlight a speed-dial entry, and then press **OK** to select it. Repeat this step to add additional speed-dial entries to this group. When finished, exit the menu.

- To delete an entry from a group: Select **Group Speed Dial**, select the group speed-dial entry that you want to change, and then press **OK**. Use the arrow keys to highlight a speed-dial entry, and then press **OK** to select it. Repeat this step to remove additional speed-dial entries from this group. When finished, exit the menu.
- To delete a group: Select **Delete Speed Dial**, press the arrow keys to highlight the speed-dial entry that you want to delete, and then press **OK**.

Print and view a list of speed-dial entries

You can print or view a list of all of the speed-dial entries that have been set up. Each entry in the list contains the following information:

- Speed-dial number
- Name associated with the fax number or group of fax numbers
- For the fax speed-dial list, the fax number (or all of the fax numbers for a group)

View a list of speed-dial entries

- **HP Device Manager (Mac OS):** Launch **HP Device Manager**, click **Information and Settings**, and then select **Fax Speed Dial Settings** from the drop-down list.
- **HP Solution Center (Windows):** Open the HP Solution Center and follow the instructions in the onscreen Help.

3 Print

This section contains the following topics:

- [Change print settings](#)
- [Cancel a print job](#)

Change print settings

You can change print settings (such as paper size or type) from an application or the printer driver. Changes made from an application take precedence over changes made from the printer driver. However, after the application is closed, the settings return to the defaults configured in the driver.

 **NOTE:** To set print settings for all print jobs, make the changes in the printer driver.

For more information about the features of the Windows printer driver, see the online help for the driver. For more information about printing from a specific application, see the documentation that came with the application.

-
- [Change settings from an application for current jobs \(Windows\)](#)
 - [Change default settings for all future jobs \(Windows\)](#)
 - [Change settings \(Mac OS\)](#)

Change settings from an application for current jobs (Windows)

To change the settings

1. Open the document that you want to print.
2. On the **File** menu, click **Print**, and then click **Setup**, **Properties**, or **Preferences**. (Specific options may vary depending on the application that you are using.)
3. Change the settings that you want, and then click **OK**, **Print**, or a similar command.

Change default settings for all future jobs (Windows)

To change the settings

1. Click **Start**, point to **Settings**, and then click **Printers** or **Printers and Faxes**.
- Or -
Click **Start**, click **Control Panel**, and then double-click **Printers**.
2. Right-click the printer icon, and then click **Properties**, **Document Defaults**, or **Printing Preferences**.
3. Change the settings that you want, and then click **OK**.

Change settings (Mac OS)

To change the settings

1. On the **File** menu, click **Page Setup**.
2. Verify that the correct printer is selected.
3. Change the settings that you want (such as paper size), and then click **OK**.
4. On the **File** menu, click **Print** to open the print driver.
5. Change the settings that you want (such as media type), and then click **OK** or **Print**.

Cancel a print job

You can cancel a print job using one of the following methods.

Device control panel: Press **X** (**Cancel** button). This clears the job that the device is currently processing. It does not affect jobs waiting to be processed.

Windows: Double-click the printer icon that appears in the lower-right corner of the computer screen. Select the print job, and then press the **Delete** key on the keyboard.

Mac OS: Open the **System Preferences** and select **Printer & Faxes**. Double-click the printer in the **Printer Browser**. Select the print job, click **Hold**, and then click **Delete**.

4 Scan

You can scan originals and send them to a variety of destinations, such as a folder on the network or a program on a computer. You can use the device control panel, the HP photo and imaging software, and TWAIN-compliant or WIA-compliant programs on a computer.

Scan functions are only available after you install the software.

This section contains the following topics:

- [Scan an original](#)
- [Scan from a TWAIN-compliant or a WIA-compliant program](#)
- [Edit a scanned original](#)
- [Change scan settings](#)
- [Cancel a scan job](#)

Scan an original

You can start a scan from a computer or from the device control panel. This section explains how to scan from the device control panel only.

 **NOTE:** You can also use the HP Photosmart Software to scan an image, including panorama images. Using this software, you can edit a scanned image and create special projects using a scanned image. For information about how to scan from the computer, and how to adjust, resize, rotate, crop, and sharpen your scans, see the onscreen HP Photosmart Software Help that came with your software.

To use the scan features, your device and computer must be connected and turned on. The printer software must also be installed and running on your computer prior to scanning. To verify that the printer software is running on a computer running Windows, look for the device icon in the system tray at the lower-right side of the screen, near the clock. To verify this on a computer using the Mac OS, open the HP Device Manager, and click **Scan Picture**. If a scanner is available, it will launch the HP ScanPro application. If it is not available, a message appears to let you know that a scanner was not found.

 **NOTE:** Closing the **HP Digital Imaging Monitor** icon in your Windows system tray can cause your device to lose some of its scan functionality and result in the **No Connection** error message. If this happens, you can restore full functionality by restarting your computer or by starting the HP Photosmart Software.

- [Scan an original \(direct connection\)](#)

Scan an original (direct connection)

Use the following steps if your device is directly connected to a computer via a USB cable.

When the scan is complete, the scanned document will be in the location you selected.

To scan from the HP photo and imaging software

1. On the computer, open the HP photo and imaging software. For more information, see [Use the HP photo and imaging software](#).
2. See the onscreen Help for further instructions.

To scan from the device control panel (direct connect)

1. Load the original. For more information, see [Load originals](#).
2. Press the left arrow ◀ or the right arrow ▶ to select the **Scan** function, and then press **OK**.
3. Press the right arrow ▶ to select what to do with the scan, and then press **OK**.
4. Press **Start**.

Scan from a TWAIN-compliant or a WIA-compliant program

The device is TWAIN-compliant and WIA-compliant and works with programs that support TWAIN-compliant and WIA-compliant scanning devices. While you are in a TWAIN-compliant or WIA-compliant program, you can gain access to the scanning feature and scan an image directly into the program.

TWAIN is supported in all Windows and Mac OS operating systems.

In Windows operating systems, WIA is supported only for Windows XP and Vista direct connections. WIA is not supported for the Mac OS.

- [Scan from a TWAIN-compliant program](#)
- [Scan from a WIA-compliant program](#)

Scan from a TWAIN-compliant program

Generally, a software program is TWAIN-compliant if it has a command such as **Acquire**, **File Acquire**, **Scan**, **Import New Object**, **Insert from**, or **Scanner**. If you are unsure whether the program is compliant or you do not know what the command is called, see the software program Help or documentation.

Start the scan from within the TWAIN-compliant program. See the software program Help or documentation for information about the commands and steps to use.

Scan from a WIA-compliant program

Generally, a software program is WIA-compliant if it has a command such as **Picture/From Scanner or Camera** in the **Insert** or **File** menu. If you are unsure whether the program is compliant or you do not know what the command is called, see the software program Help or documentation.

Start the scan from within the WIA-compliant program. See the software program Help or documentation for information about the commands and steps to use.

Edit a scanned original

You can edit a scanned image using the HP Photosmart Software. You can also edit a scanned document by using your Optical Character Recognition (OCR) software.



NOTE: To edit a scanned image, OCR software must be installed on your computer.

- [Edit a scanned photo or graphic](#)
- [Edit a scanned document using optical character recognition \(OCR\) software](#)

Edit a scanned photo or graphic

You can edit a scanned photo or graphic using the HP Photosmart Software. Use this software to adjust the brightness, contrast, color saturation, and more. You can also rotate the image using the HP Photosmart Software.

For more information, see the onscreen HP Photosmart Software Help.

Edit a scanned document using optical character recognition (OCR) software

You can use OCR software to import scanned text into your preferred word-processing program for editing. This allows you to edit letters, newspaper clippings, and many other documents.

You can specify the word-processing program that you want to use for editing. If the word-processing icon is not present or active, either you do not have word-processing software installed on your computer, or the scanner software did not recognize the program during the installation. See the onscreen Help for the HP photo and imaging software for information about how to create a link to the word-processing program.

The OCR software does not support scanning colored text. Colored text is always converted to black-and-white text before being sent to OCR. Thus, all text in the final document is in black and white, regardless of the original color.

Because of the complexity of some word-processing programs and their interaction with the device, it is sometimes preferable to scan to Wordpad (a Windows accessory), and then cut and paste the text into the preferred word-processing program.

Change scan settings

To change scan settings

- **HP Device Manager (Mac OS):** Launch **HP Device Manager**, click **Information and Settings**, and then select **Scan Preferences** from the drop-down list.
- **Windows:** Open the device software, select **Settings**, select **Scan Settings and Preferences**, then select from the available options and make your selections.

Cancel a scan job

To cancel a scan job, press **Cancel** on the device control panel.

5 Copy

You can produce high-quality color and grayscale copies on a variety of paper types and sizes.

 **NOTE:** To make a copy, the HP All-in-One must be connected to a computer, the computer must be turned on and you must be logged on, and the software must be installed and running. Also, the **HP Digital Imaging Monitor** in the Windows Taskbar must be installed and turned on at all times.

On a Macintosh computer, once the software is installed, it is always available when you turn on the computer.

NOTE: If you are copying a document when a fax arrives, the fax is stored in the device memory until the copying finishes. This can reduce the number of fax pages stored in memory.

This section contains the following topics:



- [Make copies](#)
- [Cancel a copy job](#)

Make copies

 **NOTE:** To make a copy, the HP All-in-One must be connected to a computer, the computer must be turned on and you must be logged on, and the software must be installed and running. Also, the **HP Digital Imaging Monitor** in the Windows Taskbar must be installed and turned on at all times.

On a Macintosh computer, once the software is installed, it is always available when you turn on the computer.

To make a copy

1. Make sure you have paper loaded in the main tray.
2. Place your original face down on the scanner glass. For more information, see [Load originals](#).
3. Use the left arrow  or the right arrow  to select one of the following functions:
 - **PC Copy B&W:** To select a black-and-white copy job.
 - **PC Copy Color:** To select a color copy job.

 **NOTE:** If you have a color original, selecting the **PC Copy B&W** function produces a black-and-white copy of the color original, while selecting the **PC Copy Color** function produces a full-color copy of the color original.

4. Press **OK**.
5. Press **Start**.



NOTE: If you are using a computer running Windows, the product makes one copy and launches the HP Copy software so you can make additional copies.

If you are using a Macintosh computer, refer to your computer for a preview of your copy. If necessary, edit the preview image, then click **Accept** and print your copies.

Cancel a copy job

To stop copying, press **Cancel** on the device control panel.

6 Fax

You can use the device to send and receive faxes, including color faxes. You can schedule faxes to be sent at a later time and set up speed-dials to send faxes quickly and easily to frequently used numbers. From the device control panel, you can also set a number of fax options, such as resolution and the contrast between lightness and darkness on the faxes you send.

If the device is directly connected to a computer, you can use the HP photo and imaging software to perform fax procedures that are not available from the device control panel. For more information, see [Use the HP photo and imaging software](#).

 **NOTE:** Before you begin faxing, make sure you have set up the device properly for faxing. You might have already done this as part of the initial setup, by using either the control panel or the software that came with the device. You can verify the fax is set up correctly by running the fax setup test from the control panel. To run the fax test, press **Setup**, select **Tools**, select **Run fax test**, and then press **OK**.

This section contains the following topics:

- [Send a fax](#)
- [Receive a fax](#)
- [Change fax settings](#)
- [Fax over the Internet](#)
- [Test fax setup](#)
- [Use reports](#)
- [Cancel a fax](#)

Send a fax

You can send a fax in a variety of ways. Using the device control panel, you can send a black-and-white or color fax. You can also send a fax manually from an attached phone. This allows you to speak with the recipient before sending the fax.

- [Send a basic fax](#)
- [Send a fax manually from a phone](#)
- [Send a fax using monitor dialing](#)
- [Send a fax from memory](#)
- [Schedule a fax to send later](#)
- [Send a fax to multiple recipients](#)
- [Send a color original or photo fax](#)
- [Change the fax resolution and Lighter / Darker settings](#)
- [Send a fax in Error Correction Mode](#)

Send a basic fax



You can easily send a single- or multiple-page black-and-white fax by using the device control panel.

 **NOTE:** If you need printed confirmation that your faxes were successfully sent, enable fax confirmation **before** sending any faxes.

 **TIP:** You can also send a fax manually from a phone or by using monitor dialing. These features allow you to control the pace of your dialing. They are also useful when you want to use a calling card to charge the call and you have to respond to tone prompts while dialing.

 **NOTE:** The **Speed Dial** and **Redial** buttons are only available with the HP Officejet J4660 All-in-One.

To send a basic fax from the device control panel

1. Load your originals. For additional information, see [Load originals](#).
2. Press the the left arrow  or the right arrow  to select **Fax B&W** or **Fax Color**, and then press **OK**.
3. Enter the fax number by using the keypad, or by pressing **Speed Dial** or **Redial** to redial the last number dialed (HP Officejet J4660).

 **TIP:** To add a pause in the fax number you are entering, press **Redial**, or press the * button repeatedly, until a dash (-) appears on the display.

 **NOTE:** After entering a number, you can select a fax number from the speed dial list. You can also select a number from the speed dial list, and then enter a phone number after the number. You cannot enter a fax number that has more than 50 characters.

4. Press **Start**.

If the device detects an original loaded in the automatic document feeder, it sends the document to the number you entered.



 **TIP:** If the recipient reports issues with the quality of the fax you sent, you can try changing the resolution or contrast of your fax.

Send a fax manually from a phone

Sending a fax manually allows you to make a phone call and talk with the recipient before you send the fax. This is useful if you want to inform the recipient that you are going to send them a fax before sending it. When you send a fax manually, you can hear the dial tones, telephone prompts, or other sounds through the handset on your telephone. This makes it easy for you to use a calling card to send your fax.

Depending on how the recipient has their fax machine set up, the recipient might answer the phone, or the fax machine might take the call. If a person answers the phone, you can speak with the recipient before sending the fax. If a fax machine answers the call, you can send the fax directly to the fax machine when you hear the fax tones from the receiving fax machine.

To send a fax manually from an extension phone

1. Load your originals. For additional information, see [Load originals](#).
2. Press the the left arrow  or the right arrow  to select **Fax B&W** or **Fax Color**, and then press **OK**.

3. Dial the number by using the keypad on the phone that is connected to the device.

 **NOTE:** Do not use the keypad on the control panel of the device when manually sending a fax. You must use the keypad on your phone to dial the recipient's number.

 **TIP:** To switch between **Fax B&W** or **Fax Color**, press the **Back** button.

4. If the recipient answers the telephone, you can engage in a conversation before sending your fax.

 **NOTE:** If a fax machine answers the call, you will hear fax tones from the receiving fax machine. Proceed to the next step to transmit the fax.

5. When you are ready to send the fax, press **Start**.

 **NOTE:** If prompted, select **Send Fax**, and then place the original in the ADF.

If you were speaking with the recipient before sending the fax, inform the recipient that they should press **Start** on their fax machine after they hear fax tones.

The telephone line is silent while the fax is transmitting. At this point, you can hang up the telephone. If you want to continue speaking with the recipient, remain on the line until the fax transmission is complete.



To send a fax manually from a phone using the attached handset (HP Officejet J4660)

1. Load your originals. For additional information, see [Load originals](#).
2. Pick up the handset that is attached to the HP All-in-One and dial the number by using the keypad on the device control panel.

 **TIP:** To switch between **Fax B&W** or **Fax Color**, press the **Back** button.

3. If the recipient answers the telephone, you can engage in a conversation before sending your fax.

 **NOTE:** If a fax machine answers the call, you will hear fax tones from the receiving fax machine. Proceed to the next step to transmit the fax.

4. Press the the left arrow  or the right arrow  to select **Fax B&W** or **Fax Color**, and then press **OK**.

5. When you are ready to send the fax, press **Start**.

 **NOTE:** If prompted, select **Send Fax**, and then press **Start** again.

If you were speaking with the recipient before sending the fax, inform the recipient that they should press **Start** on their fax machine after they hear fax tones.

The telephone line is silent while the fax is transmitting. At this point, you can hang up the telephone. If you want to continue speaking with the recipient, remain on the line until the fax transmission is complete.

 **NOTE:** When sending a fax manually using the All-in-One's handset, the **Scan** and **Copy** functions are not available.



Send a fax using monitor dialing

Monitor dialing allows you to dial a number from the device control panel as you would dial a regular telephone. When you send a fax using monitor dialing, you can hear the dial tones, telephone prompts, or other sounds through the speakers on the device. This enables you to respond to prompts while dialing, as well as control the pace of your dialing.

 **TIP:** If you do not enter your calling card PIN fast enough, the device might start sending fax tones too soon and cause your PIN not to be recognized by the calling card service. If this is the case, you can create a speed dial entry to store the PIN for your calling card.

 **NOTE:** Make sure the volume is turned on, or you will not hear a dial tone.

To send a fax using monitor dialing from the device control panel

1. Load your originals. For additional information, see [Load an original in the automatic document feeder \(ADF\)](#).
2. Press the the left arrow  or the right arrow  to select **Fax B&W** or **Fax Color**, and then press **Start**.
If the device detects an original loaded in the automatic document feeder, you will hear a dial tone.
3. When you hear the dial tone, enter the number by using the keypad on the device control panel.
4. Follow any prompts that might occur.

 **TIP:** If you are using a calling card to send a fax and you have your calling card PIN stored as a speed dial, when prompted to enter your PIN, press **Speed Dial** to select the speed dial entry where you have your PIN stored.



Your fax is sent when the receiving fax machine answers.

Send a fax from memory

You can scan a black-and-white fax into memory and then send the fax from memory. This feature is useful if the fax number you are trying to reach is busy or temporarily unavailable. The device scans the originals into memory and sends them once it is able to connect to the receiving fax machine. After the device scans the pages into memory, you can immediately remove the originals from the document feeder tray.

 **NOTE:** You can only send a black-and-white fax from memory.

To send a fax from memory

1. Load your originals. For additional information, see [Load originals](#).
2. Press the the left arrow  or the right arrow  to select **Fax B&W** or **Fax Color**, and then press **OK**.
3. Enter the fax number by using the keypad, press **Speed Dial** to select a speed dial, or press **Redial/Pause** to redial the last number dialed.
4. Press the right arrow  until **Fax Method** appears, and then press **OK**.

5. Press the right arrow  until **Scan & Fax** appears, and then press **OK**.
6. Press **Start**.
The device scans the originals into memory and sends the fax when the receiving fax machine is available.





Schedule a fax to send later

You can schedule a black-and-white fax to be sent within the next 24 hours. This enables you to send a black-and-white fax late in the evening, when phone lines are not as busy or phone rates are lower, for example. The device automatically sends your fax at the specified time.





You can only schedule one fax to be sent at a time. You can continue to send faxes normally, however, while a fax is scheduled.

 **NOTE:** You can only send faxes in black and white due to memory limitations.

To schedule a fax from the device control panel

1. Load your originals. For additional information, see [Load originals](#).
2. Press the the left arrow  or the right arrow  to select **Fax B&W** or **Fax Color**, and then press **OK**.
3. Press the right arrow  until **Fax Method** appears, and then press **OK**.
4. Press the right arrow  until **Send Fax Later** appears, and then press **OK**.
5. Enter the send time by using the numeric keypad, and then press **OK**. If prompted, press **1** for **AM**, or **2** for **PM**.
6. Enter the fax number by using the keypad, press **Speed Dial** to select a speed dial, or press **Redial/Pause** to redial the last number dialed.
7. Press **Start**.
The device scans all pages and the scheduled time appears on the display. The fax is sent at the scheduled time.

To cancel a scheduled fax

1. Press the the left arrow  or the right arrow  to select **Fax B&W** or **Fax Color**, and then press **OK**.
2. Press the right arrow  until **Fax Method** appears, and then press **OK**.
3. Press the right arrow  until **Send Fax Later** appears, and then press **OK**.
If there is a fax already scheduled, the **Cancel** prompt appears on the display.
4. Press **1** to select **Yes**.

 **NOTE:** You can also cancel the scheduled fax by pressing **Cancel** on the device control panel when the scheduled time is visible on the display.

Send a fax to multiple recipients





This section contains the following topics:

- [Send a fax to multiple recipients from the device control panel](#)

Send a fax to multiple recipients from the device control panel

You can send a fax to multiple recipients at once by grouping individual speed dial entries into group speed dial entries.

To send a fax to multiple recipients using group speed dial

1. Load your originals. For additional information, see [Load originals](#).
2. Press the the left arrow  or the right arrow  to select **Fax B&W**, and then press **OK**.
3. Press the the left arrow  or the right arrow  until the appropriate group speed dial entry appears.

 **TIP:** You can also select a speed dial entry by entering its speed dial code using the keypad on the device control panel or you can press the **Speed Dial** button repeatedly (HP Officejet J4660 only).

4. Press **Start**.

If the device detects an original loaded in the automatic document feeder, it sends the document to each number in the group speed dial entry.



 **NOTE:** You can only use group speed dial entries to send faxes in black and white, because of memory limitations. The device scans the fax into memory then dials the first number. When a connection is made, it sends the fax and dials the next number. If a number is busy or not answering, the device follows the settings for **Busy Redial** and **No Answer Redial**. If a connection cannot be made, the next number is dialed and an error report is generated.

Send a color original or photo fax

You can fax a color original or photo from the device. If it determines that the recipient's fax machine only supports black-and-white faxes, the fax is sent in black and white.

HP recommends that you use only color originals for color faxing.

To send a color original or photo fax from the device control panel

1. Load your originals. For additional information, see [Load originals](#).
2. Press the the left arrow  or the right arrow  to select **Fax Color**, and then press **OK**.
3. Enter the fax number by using the keypad, press **Speed Dial** to select a speed dial, or press **Redial/Pause** to redial the last number dialed.
4. Press **Start**.

If the device detects an original loaded in the automatic document feeder, it sends the document to the number you entered.

 **NOTE:** If the recipient's fax machine only supports black-and-white faxes, the HP All-in-One automatically sends the fax in black and white. A message appears after the fax has been sent indicating that the fax was sent in black and white. Press **OK** to clear the message.

Change the fax resolution and Lighter / Darker settings

You can change the **Resolution** and **Lighter / Darker** settings for documents that you are faxing.

 **NOTE:** These settings do not affect copy settings. Copy quality and lightness/darkness are set independently from fax resolution and lightness/darkness. Also, the settings that you change from the device control panel do not affect faxes you send from your computer.

This section contains the following topics:

- [Change the fax resolution](#)
- [Change the Lighter / Darker setting](#)
- [Set new default settings](#)

Change the fax resolution

The **Resolution** setting affects the transmission speed and quality of faxed black-and-white documents. If the receiving fax machine does not support the resolution you have chosen, the HP All-in-One sends faxes at the highest resolution supported by the receiving fax machine.



 **NOTE:** You can only change the resolution for faxes that you are sending in black and white. The device sends all color faxes using **Fine** resolution.

The following resolution settings are available for sending faxes: **Fine**, **Very Fine**, **Photo**, and **Standard**.

- **Fine:** provides high-quality text suitable for faxing most documents. This is the default setting. When sending faxes in color, the device always uses the **Fine** setting.
- **Very Fine:** provides the best quality fax when you are faxing documents with very fine detail. If you choose **Very Fine**, be aware that the faxing process takes longer to complete and you can only send black-and-white faxes using this resolution. If you send a color fax, it will be sent using **Fine** resolution instead.
- **Photo:** provides the best quality fax when sending photographs in black and white. If you choose **Photo**, be aware that the faxing process takes longer to complete. When faxing photographs in black and white, HP recommends that you choose **Photo**.
- **Standard:** provides the fastest possible fax transmission with the lowest quality.

When you exit the Fax menu, this option returns to the default setting unless you set your changes as the default.

To change the resolution from the device control panel

1. Load your originals. For additional information, see [Load originals](#).
2. Press the left arrow  or the right arrow  to select **Fax B&W**, and then press **OK**.
3. Enter the fax number by using the keypad, press **Speed Dial** to select a speed dial, or press **Redial/Pause** to redial the last number dialed.
4. Press the right arrow  until **Resolution** appears, and then press **OK**.

5. Press the right arrow  to select a resolution setting, and then press **OK**.

6. Press **Start**.

If the device detects an original loaded in the automatic document feeder, it sends the document to the number you entered.





Change the Lighter / Darker setting

You can change the contrast of a fax to be darker or lighter than the original. This feature is useful if you are faxing a document that is faded, washed out, or handwritten. You can darken the original by adjusting the contrast.

 **NOTE:** The **Lighter / Darker** setting applies to black-and-white faxes only, not color faxes.

When you exit the Fax menu, this option returns to the default setting unless you set your changes as the default.

To change the Lighter / Darker setting from the device control panel

1. Load your originals. For additional information, see [Load originals](#).
2. Press the the left arrow  or the right arrow  to select **Fax B&W**, and then press **OK**.
3. Enter the fax number by using the keypad, press **Speed Dial** to select a speed dial, or press **Redial/Pause** to redial the last number dialed.
4. Press the right arrow  until **Lighter / Darker** appears, and then press **OK**.
5. Press the the left arrow  to lighten the fax or press the right arrow  to darken it, and then press **OK**.

The indicator moves to the left or right as you press an arrow button.



6. Press **Start**.

If the device detects an original loaded in the automatic document feeder, it sends the document to the number you entered.

Set new default settings

You can change the default value for the **Resolution** and **Lighter / Darker** settings through the device control panel.

To set new default settings from the device control panel

1. Make changes to the **Resolution** and **Lighter / Darker** fax settings, and then press **OK**.
2. Press the right arrow  until **Set As Default** appears, and then press **OK**.
3. Press the right arrow  until **Yes** appears, and then press **OK**.

Send a fax in Error Correction Mode



Error Correction Mode (ECM) prevents loss of data due to poor phone lines by detecting errors that occur during transmission and automatically requesting retransmission of the erroneous portion. Phone charges are unaffected, or might even be reduced, on good phone lines. On poor phone lines, ECM increases sending time and phone charges, but sends the data much more reliably. The default setting is **On**.

Turn ECM off only if it increases phone charges substantially, and you can accept poorer quality in exchange for reduced charges.

Before turning the ECM setting off, consider the following. If you turn ECM off

- The quality and transmission speed of faxes you send and receive are affected.
- The **Fax Speed** is automatically set to **Medium**.
- You will no longer be able to send or receive faxes in color.

To change the ECM setting from the control panel

1. Press **Setup**.
2. Press the right arrow  until **Fax Settings** appears, and then press **OK**.
3. Press the right arrow  until **Error Correction Mode** appears, and then press **OK**.
4. Press the right arrow  to select **On** or **Off**, and then press **OK**.

Receive a fax

You can receive faxes automatically or manually. If you turn off the **Auto Answer** option, you must receive faxes manually. If you turn on the **Auto Answer** option (the default setting), the device automatically answers incoming calls and receives faxes after the number of rings that are specified by the **Rings to Answer** setting. (The default **Rings to Answer** setting is five rings.)

If you receive a legal-size fax and the device is not currently set to use legal-size paper, the device reduces the fax so that it fits on the paper that is loaded. If you have disabled the **Automatic Reduction** feature, the device prints the fax on two pages.

 **NOTE:** If you are copying a document when a fax arrives, the fax is stored in the device memory until the copying finishes. This can reduce the number of fax pages stored in memory.

- [Receive a fax manually](#)
- [Set up backup fax](#)
- [Reprint received faxes from memory](#)
- [Poll to receive a fax](#)
- [Forward faxes to another number](#)
- [Set the paper size for received faxes](#)
- [Set automatic reduction for incoming faxes](#)
- [Block junk fax numbers](#)
- [Receive faxes to your computer](#)

Receive a fax manually

When you are on the phone, the person you are speaking with can send you a fax while you are still connected. This is referred to as manual faxing. Use the instructions in this section to receive a manual fax.

 **NOTE:** You can pick up the handset to talk or listen for fax tones.

You can receive faxes manually from a phone that is:

- Directly connected to the device (on the 2-EXT port)
- On the same phone line, but not directly connected to the device

To receive a fax manually

1. Make sure the device is turned on and you have paper loaded in the main tray.
2. Remove any originals from the document feeder tray.
3. Set the **Rings to Answer** setting to a high number to allow you to answer the incoming call before the device answers. Or, turn off the **Auto Answer** setting so that the device does not automatically answer incoming calls.
4. If you are currently on the phone with the sender, instruct the sender to press **Start** on their fax machine.
5. When you hear fax tones from a sending fax machine, do the following:
 - a. Press the left arrow ◀ or the right arrow ▶ to select **Black-and-white fax** or **Color fax**.
 - b. Press **Start**.
 - c. After the device begins to receive the fax, you can hang up the phone or remain on the line. The phone line is silent during fax transmission.

Set up backup fax



Depending on your preference and security requirements, you can set up the device to store all the faxes it receives, only the faxes it receives while the device is in an error condition, or none of the faxes it receives.

The following **Backup fax** modes are available:

On	<p>The default setting. When Backup fax is On, the device stores all received faxes in memory. This enables you to reprint up to eight of the most recently printed faxes if they are still saved in memory.</p> <p>NOTE: When device memory is low, it overwrites the oldest, printed faxes as it receives new faxes. If the memory becomes full of unprinted faxes, the device stops answering incoming fax calls.</p> <p>NOTE: If you receive a fax that is too large, such as a very detailed color photo, it might not be stored in memory due to memory limitations.</p>
On Error Only	<p>Causes the device to store faxes in memory only if an error condition exists that prevents the device from printing the faxes (for example, if the device runs out of paper). The device continues to store incoming faxes as long as there is memory available. (If the memory becomes full, the device stops answering incoming fax calls.) When the error condition is resolved, the faxes stored in memory print automatically, and then they are deleted from memory.</p>
Off	<p>Faxes are never stored in memory. For example, you might want to turn off Backup fax for security purposes. If an error condition occurs that prevents the device from printing (for example, the device runs out of paper), the device stops answering incoming fax calls.</p>

 **NOTE:** If **Backup fax** is enabled and you turn off the device, all faxes stored in memory are deleted, including any unprinted faxes that you might have received while the device was in an error condition. You must contact the senders to ask them to resend any unprinted faxes. For a list of the faxes you have received, print the **Fax Log**. The **Fax Log** is not deleted when the device is turned off.

To set backup fax from the device control panel

1. Press **Setup**.
2. Press the right arrow  until **Tools** appears, and then press **OK**.
3. Press the right arrow  until **Backup fax** appears, and then press **OK**.
4. Press the right arrow  to select **On**, **On Error Only**, or **Off**.
5. Press **OK**.



Reprint received faxes from memory

If you set the **Backup fax** mode to **On**, the received faxes are stored in memory, whether the device has an error condition or not.

 **NOTE:** After the memory becomes full, the oldest, printed faxes are overwritten as new faxes are received. If all the stored faxes are unprinted, the device does not receive any fax calls until you print or delete the faxes from memory. You might also want to delete the faxes in memory for security or privacy purposes.

Depending on the sizes of the faxes in memory, you can reprint up to eight of the most recently printed faxes, if they are still in memory. For example, you might need to reprint your faxes if you lost the copy of your last printout.

To reprint faxes in memory from the device control panel

1. Make sure you have paper loaded in the main tray.
2. Press **Setup**.
3. Press the right arrow  until **Print Report** appears, and then press **OK**.
4. Press the right arrow  until **Reprint Faxes** appears, and then press **OK**.
The faxes are printed in the reverse order from which they were received with the most recently received fax printed first, and so on.
5. Press **Start**.
6. If you want to stop reprinting the faxes in memory, press **Cancel**.

To delete all the faxes in memory from the device control panel





- ▲ Turn off the device by pressing the **Power** button.
All faxes stored in memory are deleted from memory when you turn off the power.

Poll to receive a fax

Polling allows the HP All-in-One to ask another fax machine to send a fax that it has in its queue. When you use the **Poll to Receive** feature, the HP All-in-One calls the designated fax machine and requests the fax from it. The designated fax machine must be set for polling and have a fax ready to send.

 **NOTE:** The HP All-in-One does not support polling pass codes. Polling pass codes are a security feature that require the receiving fax machine to provide a pass code to the device it is polling in order to receive the fax. Make sure the device you are polling does not have a pass code set up (or has not changed the default pass code) or the HP All-in-One will not be able to receive the fax.

To set up poll to receive a fax from the device control panel

1. Press the left arrow  or the right arrow  to select **Black-and-white fax** or **Color fax**, and then press **OK**.
2. Press the right arrow  until **Fax Method** appears, and then press **OK**.
3. Press the right arrow  until **Poll to Receive** appears, and then press **OK**.
4. Enter the fax number of the other fax machine.
5. Press **Start**.

 **NOTE:** If you selected **Color Fax** but the sender sent the fax in black and white, the device prints the fax in black and white.

Forward faxes to another number

You can set up the device to forward your faxes to another fax number. A received color fax is forwarded in black and white.

HP recommends that you verify the number you are forwarding to is a working fax line. Send a test fax to make sure the fax machine is able to receive your forwarded faxes.

To forward faxes from the device control panel

1. Press **Setup**.
2. Press the right arrow  until **Fax Settings** appears, and then press **OK**.
3. Press the right arrow  until **Fax Forwarding** appears, and then press **OK**.
4. Press the right arrow  until **On** appears, and then press **OK**.

 **NOTE:** If the device is not able to forward the fax to the designated fax machine (for example, if it is not turned on), the device prints the fax. If you set up the device to print error reports for received faxes, it will also print an error report.

5. At the prompt, enter the number of the fax machine that will receive the forwarded faxes, and then press **OK**.

Fax Forwarding appears on the device control panel display.

If the device loses power when **Fax Forwarding** is set up, it saves the **Fax Forwarding** setting and phone number. When the power is restored to the device, the **Fax Forwarding** setting is still **On**.





 **NOTE:** You can cancel fax forwarding by pressing **Cancel** on the device control panel when the **Fax Forwarding** message is visible on the display, or you can select **Off** from the **Fax Fwd, Black** menu.

Set the paper size for received faxes

You can select the paper size for received faxes. The paper size you select should match what is loaded in your main tray. Faxes can be printed on letter, A4, or legal paper only.

 **NOTE:** If an incorrect paper size is loaded in the main tray when you receive a fax, the fax does not print and an error message appears on the display. Load letter, A4, or legal paper, and then press **OK** to print the fax.





To set the paper size for received faxes from the device control panel

1. Press **Setup**.
2. Press the right arrow  until **Fax Settings** appears, and then press **OK**.
3. Press the right arrow  until **Paper Options** appears, and then press **OK**.
4. Press the right arrow  until **Fax Paper Size** appears, and then press **OK**.
5. Press the right arrow  to select an option, and then press **OK**.

Set automatic reduction for incoming faxes

The **Automatic Reduction** setting determines what the HP All-in-One does if it receives a fax that is too large for the default paper size. This setting is turned on by default, so the image of the incoming fax is reduced to fit on one page, if possible. If this feature is turned off, information that does not fit on the first page is printed on a second page. **Automatic Reduction** is useful when you receive a legal-size fax and letter-size paper is loaded in the main tray.

To set automatic reduction from the device control panel

1. Press **Setup**.
2. Press the right arrow  until **Fax Settings** appears, and then press **OK**.
3. Press the right arrow  until **Paper Options** appears, and then press **OK**.
4. Press the right arrow  until **Auto Fax Resize** appears, and then press **OK**.
5. Press the right arrow  to select **Off** or **On**.
6. Press **OK**.

Block junk fax numbers

If you subscribe to a caller ID service through your phone provider, you can block specific fax numbers so the device does not print faxes received from those numbers. When an incoming fax call is received, the device compares the number to the list of junk fax numbers to determine if the call should be blocked. If the number matches a number in the blocked fax numbers list, the fax is not printed. (The maximum number of fax numbers you can block varies by model.)

 **NOTE:** This feature is not supported in all countries/regions. If it is not supported in your country/region, **Junk Fax Blocker** does not appear in the **Fax Settings** menu.

NOTE: If no phone numbers are added in the Caller ID list, it is assumed that the user has not signed up for the Caller ID service with the phone company.

- [Add numbers to the junk fax list](#)
- [Remove numbers from the junk fax list](#)

Add numbers to the junk fax list

You can block specific numbers by adding them to the junk fax list.

To manually enter a number to block

1. Press **Setup**.
2. Press the right arrow ► to select **Fax Settings**, and then press **OK**.
3. Press the right arrow ► to select **Junk Fax Blocker**, and then press **OK**.
4. Press the right arrow ► to select **Add**, and then press **OK**.
5. To select a fax number to block from the caller ID list, select **Select no.**
- or -
To manually enter a fax number to block, select **Enter no.**
6. After entering a fax number to block, press **OK**.
Make sure you enter the fax number as it appears on the control-panel display, and not the fax number that appears on the fax header of the received fax, as these numbers can be different.
7. When the **Enter Another?** prompt appears, do one of the following:
 - **If you want to add another number to the list of junk fax numbers**, press **Yes**, and then repeat step 5 for each number you want to block.
 - **If you are done**, press **No**.

Remove numbers from the junk fax list

If you no longer want to block a fax number, you can remove a number from your junk fax list.

To remove numbers from the list of junk fax numbers

1. Press **Setup**.
2. Press **Fax Settings**, and then press **OK**.
3. Press **Junk Fax Blocker**, and then press **OK**.
4. Press **Delete**, and then press **OK**.
5. Press the right arrow button to scroll through the numbers you have blocked. When the number you want to remove appears, press **OK** to select it.
6. When the **Delete Another?** prompt appears, do one of the following:
 - **If you want to remove another number from the list of junk fax numbers**, press **Yes**, and then repeat step 5 for each number you no longer want to block.
 - **If you are done**, press **No**.

Receive faxes to your computer

Use Fax to PC to automatically receive faxes and save faxes directly to your computer. With Fax to PC, you can store digital copies of your faxes easily and also

eliminate the hassle of dealing with bulky paper files. Received faxes are saved as TIFF (Tagged Image File Format). Once the fax is received, you get a notification with a link to the folder where the fax is saved.

The files are named in the following method: XXXX_YYYYYYYY_ZZZZZZ.tif, where X is the sender's information, Y is the date, and Z is the time that the fax was received.

 **NOTE:** Fax to PC is available for receiving black-and-white faxes only. Color faxes are printed instead of being saved to the computer.

NOTE: Fax to PC is only supported on Windows.

NOTE: Faxes stored in the device memory will be lost if power is lost.

This section contains the following topics:

- [Activate Fax to PC](#)
- [Modify Fax to PC settings](#)

Activate Fax to PC

Use the Fax to PC Setup Wizard to activate Fax to PC. The Fax to PC Setup Wizard can be started from the Solution Center.

 **NOTE:** If you turn on Fax to PC, make sure the Backup Fax Reception is set to "On".

Fax to PC requirements:

- The administrator program, the computer that activated the Fax to PC feature, must be on at all times. Only one computer can act as the Fax to PC administrator computer.
- The destination folder's computer or server, if different than the Fax to PC administrator computer, must be on at all times. The destination computer must also be awake, faxes will not be saved if the computer is asleep or in hibernate mode.
- HP Digital Imaging monitor in Windows Taskbar must be on at all times.
- Paper must be loaded in the input tray.

To start the Fax to PC Setup Wizard from the Solution Center

1. Open the Solution Center. For more information, see [Use the HP Solution Center \(Windows\)](#).
2. Select **Settings**, and then select **Fax to PC Setup Wizard**.
3. Follow the onscreen instructions to set up Fax to PC.

Modify Fax to PC settings

You can update the Fax to PC settings from your computer at any time from the Fax settings page in the Solution Center. You can turn off Fax to PC and disable printing faxes from the device control panel.

To modify Fax to PC settings from the device control panel

1. Press the **Setup** button, select **Fax Settings**, and then **Fax to PC**.
2. Select the setting that you want to change. You can change the following settings:
 - **View PC hostname:** View the name of the computer that is set up to administer Fax to PC.
 - **Turn Off:** Turn off Fax to PC.



NOTE: Use the Solution Center to turn on Fax to PC.

- **Disable Fax Print:** Choose this option to print faxes as they are received. If you turn off printing, color faxes will still print.



NOTE: Because color faxes are not saved to the computer, color faxes are still printed. However, some multi-page color faxes may be too large for the device memory.

To modify Fax to PC settings from the Solution Center

1. Open the Solution Center. For more information, see [Use the HP Solution Center \(Windows\)](#).
2. Select **Settings**, and then select **Fax Settings**.
3. Select the **Fax to PC Settings** tab.
4. Make any changes to the settings you want to modify. Press **OK**.



NOTE: Any changes you make will overwrite the original settings.

Change fax settings

After completing the steps in the getting started guide that came with the device, use the following steps to change the initial settings or to configure other options for faxing.

- [Configure the fax header](#)
- [Set the answer mode \(Auto answer\)](#)
- [Set the number of rings before answering](#)
- [Change the answer ring pattern for distinctive ring](#)
- [Set the fax error correction mode](#)
- [Set the dial type](#)
- [Set the redial options](#)
- [Set the fax speed](#)



Configure the fax header

The fax header prints your name and fax number on the top of every fax you send. HP recommends that you set up the fax header by using the software that you installed

with the device. You can also set up the fax header from the device control panel, as described here.

 **NOTE:** In some countries/regions, the fax header information is a legal requirement.

To set or change the fax header





1. Press **Setup**.
2. Press the right arrow  to select **Fax Settings**, and then press **OK**.
3. Press the right arrow  to select **Fax Header**, and then press **OK**.
4. Enter your personal or company name using the numeric keypad, and then press **OK**.
5. Enter your fax number by using the numeric keypad, and then press **OK**.

Set the answer mode (Auto answer)

The answer mode determines whether the device answers incoming calls.

- Turn on the **Auto Answer** setting if you want the device to answer faxes **automatically**. The device answers all incoming calls and faxes.
- Turn off the **Auto Answer** setting if you want to receive faxes **manually**. You must be available to respond in person to the incoming fax call or the device does not receive faxes.

To set the answer mode to manual or automatic via the device control panel

1. Press **Setup**.
2. Press the right arrow  to select **Fax Settings**, and then press **OK**.
3. Press the right arrow  to select **Answer Options**, and then press **OK**.
4. Press the right arrow  to select **Auto Answer**, and then press **OK**.
5. Press the right arrow  to select **On** or **Off** as appropriate for your setup, and then press **OK**.

When **Auto Answer** is **On**, the device answers calls automatically. When **Auto Answer** is **Off**, it does not answer calls.

Set the number of rings before answering





If you turn on the **Auto Answer** setting, you can specify how many rings occur before incoming calls are automatically answered.

The **Rings to Answer** setting is important if you have an answering machine on the same phone line as the device, because you want the answering machine to answer the phone before the device does. The number of rings to answer for the device should be greater than the number of rings to answer for the answering machine.

For example, set your answering machine to a low number of rings and the device to answer in the maximum number of rings. (The maximum number of rings varies by country/region.) In this setup, the answering machine answers the call and the device

monitors the line. If the device detects fax tones, it receives the fax. If the call is a voice call, the answering machine records the incoming message.

To set the number of rings before answering via the device control panel

1. Press **Setup**.
2. Press the right arrow  to select **Fax Settings**, and then press **OK**.
3. Press the right arrow  to select **Answer Options**, and then press **OK**.
4. Press the right arrow  to select **Rings to Answer**, and then press **OK**.
5. Enter the appropriate number of rings by using the keypad, or press the left arrow  or the right arrow  to change the number of rings.
6. Press **OK** to accept the setting.

Change the answer ring pattern for distinctive ring



Many phone companies offer a distinctive ring feature that allows you to have several phone numbers on one phone line. When you subscribe to this service, each number is assigned a different ring pattern. You can set up the device to answer incoming calls that have a specific ring pattern.

If you connect the device to a line with distinctive ring, have your telephone company assign one ring pattern to voice calls and another ring pattern to fax calls. HP recommends that you request double or triple rings for a fax number. When the device detects the specified ring pattern, it answers the call and receives the fax.

If you do not have a distinctive ring service, use the default ring pattern, which is **All Rings**.

 **NOTE:** The HP fax cannot receive faxes when the main phone number is off the hook.

To change the answer ring pattern for distinctive ring via the device control panel

1. Verify that the device is set to answer fax calls automatically.
2. Press **Setup**.
3. Press the right arrow  to select **Basic Settings**, and then press **OK**.
4. Press the right arrow  to select **Ring Pattern**, and then press **OK**.
When the phone rings with the ring pattern assigned to your fax line, the device answers the call and receives the fax.

Set the fax error correction mode

Typically, the device monitors the signals on the phone line while it is sending or receiving a fax. If it detects an error signal during the transmission and the error-correction setting is on, the device can request that a portion of the fax be resent.

Turn off error correction only if you are having trouble sending or receiving a fax, and you want to accept the errors in the transmission. Turning off the setting might be useful when you are trying to send a fax to another country/region or receive a fax from another country/region, or if you are using a satellite phone connection.

To set the fax error-correction mode

1. Press **Setup**.
2. Press the right arrow ► to select **Fax Settings**, and then press **OK**.
3. Press the right arrow ► to select **Error Correction**, and then press **OK**.
4. Press the right arrow ► to select **On** or **Off**, and then press **OK**.

Set the dial type

Use this procedure to set tone-dialing or pulse-dialing mode. The factory-set default is **Tone**. Do not change the setting unless you know that your phone line cannot use tone dialing.

 **NOTE:** The pulse-dialing option is not available in all countries/regions.

To set the dial type

1. Press **Setup**.
2. Press the right arrow ► to select **Basic Settings**, and then press **OK**.
3. Press the right arrow ► to select **Tone or Pulse**, and then press **OK**.
4. Press the right arrow ► to select the appropriate option, and then press **OK**.

Set the redial options

If the device was unable to send a fax because the receiving fax machine did not answer or was busy, the device attempts to redial based on the settings for the busy-redial and no-answer-redial options. Use the following procedure to turn the options on or off.

- **Busy redial:** If this option is turned on, the device redials automatically if it receives a busy signal. The factory-set default for this option is **ON**.
- **No answer redial:** If this option is turned on, the device redials automatically if the receiving fax machine does not answer. The factory-set default for this option is **OFF**.

To set the redial options

1. Press **Setup**.
2. Press the right arrow ► to select **Fax Settings**, and then press **OK**.
3. Press the right arrow ► to select **Redial Options**, and then press **OK**.
4. Press the right arrow ► to select the appropriate **Busy Redial** or **No Answer Redial** options, and then press **OK**.

Set the fax speed

You can set the fax speed used to communicate between your device and other fax machines when sending and receiving faxes. The default fax speed is **Fast**.

If you use one of the following, setting the fax speed to a slower speed might be required:



- An Internet phone service
- A PBX system

- Fax over Internet Protocol (FoIP)
- An integrated services digital network (ISDN) service

If you experience problems sending and receiving faxes, you might want to try setting the **Fax Speed** setting to **Medium** or **Slow**. The following table provides the available fax speed settings.

Fax speed setting	Fax speed
Fast	v.34 (33600 baud)
Medium	v.17 (14400 baud)
Slow	v.29 (9600 baud)

To set the fax speed from the device control panel

1. Press **Setup**.
2. Press the right arrow  to select **Fax Settings**, and then press **OK**.
3. Press the right arrow  to select **Fax Speed**, and then press **OK**.
4. Select an option using the arrow keys, and then press **OK**.

Fax over the Internet

You may subscribe to a low cost phone service that allows you to send and receive faxes with your device by using the Internet. This method is called Fax over Internet Protocol (FoIP). You probably use a FoIP service (provided by your telephone company) if you:

- Dial a special access code along with the fax number, or
- Have an IP converter box that connects to the Internet and provides analog phone ports for the fax connection.

 **NOTE:** You can only send and receive faxes by connecting a phone cord to the port labeled "1-LINE" on the device. This means that your connection to the Internet must be done either through a converter box (which supplies regular analog phone jacks for fax connections) or your telephone company.

Some Internet faxing services do not work properly when the device is sending and receiving faxes at high speed (33600bps). If you experience problems sending and receiving faxes while using an Internet fax service, use a slower fax speed. You can do this by changing the **Fax Speed** setting from **High** (the default) to **Medium**. For information on changing this setting, see [Set the fax speed](#).

If you have questions about internet faxing, contact your internet faxing services support department.



Test fax setup

You can test your fax setup to check the status of the device and to make sure it is set up properly for faxing. Perform this test after you have completed setting up the device for faxing. The test does the following:

- Tests the fax hardware
- Verifies the correct type of phone cord is connected to the device
- Checks that the phone cord is plugged into the correct port
- Checks for a dial tone
- Checks for an active phone line
- Tests the status of your phone line connection

The device prints a report with the results of the test. If the test fails, review the report for information on how to fix the problem and rerun the test.

To test fax setup

1. Set up the device for faxing according to your particular home or office setup instructions.
2. Make sure the ink cartridges are installed, and that full-size paper is loaded in the main tray before starting the test.
3. From the device control panel, press **Setup**.
4. Press the right arrow  to select **Tools**, and then press **OK**.
5. Press the right arrow  to select **Run Fax Test**, and then press **OK**.
The device displays the status of the test on the display and prints a report.
6. Review the report.
 - If the test passes and you are still having problems faxing, check the fax settings listed in the report to verify the settings are correct. A blank or incorrect fax setting can cause problems faxing.
 - If the test fails, review the report for more information on how to fix any problems found.

Use reports

You can set up the device to print error reports and confirmation reports automatically for each fax you send and receive. You can also manually print system reports as required; these reports provide useful system information about the device.

By default, the device is set to print a report only if there is a problem sending or receiving a fax. A confirmation message that indicates whether a fax was successfully sent appears briefly on the control-panel display after each transaction.



- [Print fax confirmation reports](#)
- [Print fax error reports](#)
- [Print and view the fax log](#)

Print fax confirmation reports

If you require printed confirmation that your faxes were successfully sent, follow these instructions to enable fax confirmation **before** sending any faxes. Select either **On Fax Send** or **Send & Receive**.

The default fax confirmation setting is **Off**. This means that a confirmation report is not printed for each fax sent or received. A confirmation message indicating whether a fax was successfully sent appears briefly on the control-panel display after each transaction.

To enable fax confirmation

1. Press **Setup**.
2. Press the right arrow  to select **Print Report**, and then press **OK**.
3. Press the right arrow  to select **Fax Confirmation**, and then press **OK**.
4. Press the right arrow  to select one of the following, and then press **OK**.



Off	Does not print a fax confirmation report when you send and receive faxes successfully. This is the default setting.
On Fax Send	Prints a fax confirmation report for every fax you send.
On Fax Receive	Prints a fax confirmation report for every fax you receive.
Send & Receive	Prints a fax confirmation report for every fax you send and receive.

 **TIP:** If you choose **On Fax Send** or **Send & Receive**, and scan your fax to send from memory, you can include an image of the first page of the fax on the **Fax Sent Confirmation** report. Press **Setup**, press **Fax Confirmation**, and then press **On Fax Send** again. Select **On** from the **Image on Fax Send Report** menu.

Print fax error reports

You can configure the device so that it automatically prints a report when there is an error during transmission or reception.

To set the device to print fax error reports automatically

1. Press **Setup**.
2. Press the right arrow  to select **Print Report**, and then press **OK**.
3. Press the right arrow  to select **Fax Error**, and then press **OK**.
4. Press the right arrow  to select one of the following, and then press **OK**.

Send & Receive	Prints whenever a fax error occurs. This is the default setting.
Off	Does not print any fax error reports.
On Fax Send	Prints whenever a transmission error occurs.
On Fax Receive	Prints whenever a receiving error occurs.

Print and view the fax log

The logs list faxes that have been sent from the device control panel and all faxes that have been received.

You can print a log of faxes that have been received and sent by the device. Each entry in the log contains the following information:



- Transmission date and time
- Type (whether received or sent)
- Fax number
- Duration
- Number of pages
- Result (status) of transmission

To view the fax log from the HP photo and imaging software

1. At the computer, open the HP photo and imaging software. For more information, see [Use the HP photo and imaging software](#).
2. See the onscreen Help for the HP photo and imaging software for further instructions.

The log lists faxes that have been sent from the device control panel and the HP photo and imaging software and all faxes that have been received.

To print the fax log from the device control panel

1. Press **Setup**.
2. Press the right arrow  to select **Print Report**, and then press **OK**.
3. Press the right arrow  to select **Fax Log**, and then press **OK**.
4. Press **OK** again to print the log.

Cancel a fax

You can cancel a fax you are sending or receiving at any time.

To cancel a fax

- ▲ Press **Cancel** on the device control panel to stop a fax you are sending or receiving. If the device does not stop faxing, press **Cancel** again.

The device prints any pages it has already started printing and then cancels the remainder of the fax. This can take a few moments.

To cancel a number you are dialing

- ▲ Press **Cancel** to cancel a number you are currently dialing.

7 Configure and manage

This section is intended for the administrator or individual who is responsible for managing the device. This section contains information about the following topics.

- [Manage the device](#)
- [Use device management tools](#)
- [Understand the self-test report](#)
- [Set up faxing for the device](#)
- [Configure the device \(Windows\)](#)
- [Configure the device \(Mac OS\)](#)
- [Set up the device for wireless communication \(HP Officejet J4680 only\)](#)
- [Uninstall and reinstall the software](#)

Manage the device

The following, common tools can be used to manage the device. For information about accessing and using the tools, see [Use device management tools](#).

 **NOTE:** Specific procedures might include other methods.

Windows

- Device control panel
- Printer driver
- Toolbox

Mac OS

- Device control panel
- HP Printer Utility
- [Monitor the device](#)
- [Administer the device](#)

Monitor the device

This section provides instructions for monitoring the device.

Use this tool...	to obtain the following information...
Device control panel	Obtain information about the status of jobs that are being processed, the operating status of the device, and the status of ink cartridges.
Toolbox (Windows)	Ink cartridge information: Click the Estimated Ink Levels tab to view the ink-level information, and then scroll to display the Cartridge Details button. Click the

(continued)

Use this tool...	to obtain the following information...
	Cartridge Details button to view information about replacement ink cartridges.*
HP Printer Utility (Mac OS)	Ink cartridge information: Open the Information and Support panel and click Supplies Status . *

* Ink level warnings and indicators provide estimates for planning purposes only. When you receive a low-ink warning message, consider having a replacement cartridge available to avoid possible printing delays. You do not need to replace the ink cartridges until print quality becomes unacceptable.

Administer the device

This section provides information about administering the device and modifying settings.

Use this tool...	to do the following...
Device control panel	<ul style="list-style-type: none"> • Language and country/region: Press Setup, select Basic Settings, and then select Set Language. • Set the date and time: Press Setup, press Basic Settings, and then press Date and Time.
Toolbox (Windows)	Perform device maintenance tasks: Click the Device Services tab.
HP Printer Utility (Mac OS)	<ul style="list-style-type: none"> • Change tray settings: Click Paper Handling from the Printer Settings panel. • Perform device maintenance tasks: Open the Information and Support panel, and then click the option for the task that you want to perform.

Use device management tools

- [Toolbox \(Windows\)](#)
- [Embedded Web server \(HP Officejet J4680 only\)](#)
- [HP Printer Utility \(Mac OS\)](#)

Toolbox (Windows)

The Toolbox provides maintenance information about the device.

 **NOTE:** The Toolbox can be installed from the Starter CD by selecting the full installation option if the computer meets the system requirements.

- [Open the Toolbox](#)
- [Toolbox tabs](#)

Open the Toolbox

- From the HP Solution Center, click the **Settings** menu, point to **Print Settings**, and then click **Printer Toolbox**.
- Right-click the **HP Digital Imaging Monitor** in the taskbar, point to **Printer Model Name** and then click **Display Printer Toolbox**.

Toolbox tabs

The Toolbox contains the following tabs.

Tabs	Contents
Estimated Ink Level	<ul style="list-style-type: none">• Ink Level Information: Shows estimated ink level for each cartridge. NOTE: Ink level warnings and indicators provide estimates for planning purposes only. When you receive a low-ink warning message, consider having a replacement cartridge available to avoid possible printing delays. You do not need to replace the ink cartridges until print quality becomes unacceptable.• Shop Online: Provides access to a Web site from which you can order printing supplies for the device online.• Order by Phone: Shows telephone numbers that you can call to order supplies for the device. Telephone numbers are not available for all countries/regions.• Cartridge Details: Shows order numbers and expiration dates of the installed ink cartridges.
Information	Printer Information: Shows the device hardware. Information tab options include: Hardware information
Device Services	<ul style="list-style-type: none">• Print a Diagnostic Page: Allows you to print a report that gives device information, including connection type, errors, and firmware information.• Print a Test Page: Allows you to print the self-test report of the device. This page contains information about the device and ink cartridges. For more information, see Understand the self-test report.• Align the Ink Cartridges: Guides you through aligning the ink cartridges. For more information, see Align the ink cartridges.• Clean the Ink Cartridges: Guides you through cleaning the ink cartridges. For more information, see Clean the ink cartridges.• Back of Page Smear Cleaning: Cleans the ribs of the device if ink is smearing on the page.• Paper Feed Cleaning: Cleans the paper rollers of the device.

Embedded Web server (HP Officejet J4680 only)

When the device is connected to a network, you can use the embedded Web server to view status information, change settings, and manage it from your computer.

 **NOTE:** For a list of system requirements for the embedded Web server, see [Embedded Web server specifications](#).

Some settings might be restricted by the requirement for a password.

You can open and use the embedded Web server without being connected to the Internet; however, some features will not be available.

This section contains the following topics:

- [To open the embedded Web server](#)
- [Embedded Web server pages](#)

To open the embedded Web server

You can open the embedded Web server by using these methods:

 **NOTE:** To open the embedded Web server from the printer driver (Windows), or the HP Printer Utility (Mac OS), the device must be on a network and must have an IP address.

- **Web browser:** In a supported Web browser on your computer, type the IP address that has been assigned to the device.

For example, if the IP address is 123.123.123.123, type the following address into the Web browser: `http://123.123.123.123`

The IP address for the device is listed on the wireless test page (HP Officejet J4680 only). For more information, see [To print a wireless test page](#).

After opening the embedded Web server, you can bookmark it so that you can return to it quickly in the future.

- **HP Printer Utility (Mac OS):** On the **Printer Settings** panel, click **Additional Settings**, and then click the **Open Embedded Web Server** button.

Embedded Web server pages

The embedded Web server contains pages that you can use to view product information and change device settings. The pages also contain links to other e-services.

Pages/buttons	Contents
Information page	Shows status information about the device, its ink supplies and usage, and a log of device events (such as errors).
Settings page	Shows the settings that have been configured for the device and gives you the ability to change these settings.
Networking page	Shows network status and the network settings that have been configured for the device. These pages only appear if the device is connected to a network.

(continued)

Pages/buttons	Contents
Bluetooth page	Shows the Bluetooth settings that have been configured for the device and gives you the ability to change these settings.
Support and Order Supplies buttons	Support provides a number of support services. Order Supplies connects you to online ordering of supplies.

HP Printer Utility (Mac OS)

The HP Printer Utility contains tools to configure print settings, calibrate the device, order supplies online, and find Web site support information.

- [Open the HP Printer Utility](#)
- [HP Printer Utility panels](#)

Open the HP Printer Utility

To open the HP Printer Utility from the Desktop

1. From the **Finder**, select **Computer** from the **Go** menu.
2. Select the computer's hard disk, select **Library**, and then select **Printers**.
3. Select **HP**, select **Utilities**, and then select **HP Printer Selector**.
4. Select the device and click **Launch Utility**.

To open the HP Printer Utility from the HP Device Manager

1. Click the **HP Device Manager** icon in the Dock.
2. Select the device in the **Devices** drop-down menu.
3. On the **Information and Settings** menu, click **Maintain Printer**.
4. Select the device and click **Launch Utility**.

HP Printer Utility panels

Information and Support panel

- **Supplies Status:** Shows the information about currently installed ink cartridges.
- **Supply Info:** Shows the ink cartridge replacement options.
- **Device Information:** Displays information about the model and serial number. This page contains information about the device and the supplies.
- **Clean:** Guides you through cleaning the ink cartridges.
- **Align:** Guides you through aligning the ink cartridges.
- **HP Support:** Gain access to HP Web site where you can find support for the device, register the device, and find information about returning and recycling used printing supplies.

Understand the self-test report

Use the self-test report to:

- View current device information and ink cartridge status
- Help troubleshoot problems

The self-test report also contains a log of recent events.

If you need to call HP, it is often useful to print the self-test report before calling.



1. **Printer Information:** Shows device information (such as the product name, model number, serial number, and firmware version number), and the number of pages printed from the tray.
2. **Nozzle test pattern:** Missing lines indicate problems with the ink cartridges. Try cleaning the cartridges, or replacing the cartridges.
3. **Color bars and boxes:** Uneven, faded, or faint color bars or boxes indicate low ink. Check the ink levels.
4. **Event Log:** Shows a log of recent events that have occurred.

To print the Self-Test Report

- **Device control panel:** Press **Setup**, select **Print Report**, select **Self-Test**, and then press **OK**.
- **HP Printer Utility (Mac OS):** Click **Device Information** from the **Information and Support** panel, and then click **Print Configuration Page**.

Set up faxing for the device

After completing all the steps in the getting started guide, use the instructions in this section to complete your fax setup. Keep your getting started guide for later use.

In this section, you will learn how to set up the device so that faxing works successfully with equipment and services you might already have on the same phone line.

 **TIP:** You can also use the Fax Setup Wizard (Windows) or HP Fax Setup Utility (Mac OS) to help you quickly set up some important fax settings such as the answer mode and fax header information. You can access the Fax Setup Wizard (Windows) or HP Fax Setup Utility (Mac OS) through the software you installed with the device. After you run the Fax Setup Wizard (Windows) or HP Fax Setup Utility (Mac OS), follow the procedures in this section to complete your fax setup.

- [Set up faxing \(parallel phone systems\)](#)
- [Serial-type fax setup](#)

Set up faxing (parallel phone systems)

Before you begin setting up the device for faxing, determine which kind of phone system your country/region uses. The instructions for fax setup differ depending on whether you have a serial- or parallel-type phone system.

- If you do not see your country/region listed in the table below, you probably have a serial-type phone system. In a serial-type phone system, the connector type on your shared telephone equipment (modems, phones, and answering machines) does not allow a physical connection to the "2-EXT" port on the device. Instead, all equipment must be connected at the telephone wall jack.

 **NOTE:** In some countries/regions that use serial-type phone systems, the phone cord that came with the device might have an additional wall plug attached to it. This enables you to connect other telecom devices to the wall jack where you plug in the device.

- If your country/region is listed in the table below, you probably have a parallel-type telephone system. In a parallel-type phone system, you are able to connect shared telephone equipment to the phone line by using the "2-EXT" port on the back of the device.

 **NOTE:** If you have a parallel-type phone system, HP recommends you use the 2-wire phone cord supplied with the device to connect it to the telephone wall jack.

Table 7-1 Countries/regions with a parallel-type phone system

Argentina	Australia	Brazil
Canada	Chile	China
Colombia	Greece	India

Countries/regions with a parallel-type phone system (continued)

Indonesia	Ireland	Japan
Korea	Latin America	Malaysia
Mexico	Philippines	Poland
Portugal	Russia	Saudi Arabia
Singapore	Spain	Taiwan
Thailand	USA	Venezuela
Vietnam		

If you are unsure which kind of telephone system you have (serial or parallel), check with your telephone company.

- [Choose the correct fax setup for your home or office](#)
- [Select your fax setup case](#)
- [Case A: Separate fax line \(no voice calls received\)](#)
- [Case B: Set up the device with DSL](#)
- [Case C: Set up the device with a PBX phone system or an ISDN line](#)
- [Case D: Fax with a distinctive ring service on the same line](#)
- [Case E: Shared voice/fax line](#)
- [Case F: Shared voice/fax line with voice mail](#)
- [Case G: Fax line shared with computer modem \(no voice calls received\)](#)
- [Case H: Shared voice/fax line with computer modem](#)
- [Case I: Shared voice/fax line with answering machine](#)
- [Case J: Shared voice/fax line with computer modem and answering machine](#)
- [Case K: Shared voice/fax line with computer dial-up modem and voice mail](#)

Choose the correct fax setup for your home or office

To fax successfully, you need to know what types of equipment and services (if any) share the same phone line with the device. This is important because you might need to connect some of your existing office equipment directly to the device, and you might also need to change some fax settings before you can fax successfully.

To determine the best way to set up the device in your home or office, first read through the questions in this section and record your answers. Next, refer to the table in the following section and choose the recommended setup case based on your answers.

Make sure to read and answer the following questions in the order they are presented.

1. Do you have a digital subscriber line (DSL) service through your telephone company? (DSL might be called ADSL in your country/region.)
If you answered Yes, proceed directly to [Case B: Set up the device with DSL](#). You do not need to continue answering questions.
If you answered No, continue answering questions.
2. Do you have a private branch exchange (PBX) phone system or an integrated services digital network (ISDN) system?
If you answered Yes, proceed directly to [Case C: Set up the device with a PBX phone system or an ISDN line](#). You do not need to continue answering questions.
If you answered No, continue answering questions.
3. Do you subscribe to a distinctive ring service through your telephone company that provides multiple phone numbers with different ring patterns?
If you answered Yes, proceed directly to [Case D: Fax with a distinctive ring service on the same line](#). You do not need to continue answering questions.
If you answered No, continue answering questions.
Are you unsure if you have distinctive ring? Many phone companies offer a distinctive ring feature that allows you to have several phone numbers on one phone line.
When you subscribe to this service, each phone number will have a different ring pattern. For example, you can have single, double, and triple rings for the different numbers. You might assign one phone number with a single ring to your voice calls, and another phone number with double rings to your fax calls. This allows you to tell the difference between voice and fax calls when the phone rings.
4. Do you receive voice calls at the same phone number you will use for fax calls on the device?
Continue answering questions.
5. Do you have a computer dial-up modem on the same phone line as the device?
Are you unsure if you use a computer dial-up modem? If you answer Yes to any of the following questions, you are using a computer dial-up modem:
 - Do you send and receive faxes directly to and from your computer software applications through a dial-up connection?
 - Do you send and receive e-mail messages on your computer through a dial-up connection?
 - Do you access the Internet from your computer through a dial-up connection?Continue answering questions.
6. Do you have an answering machine that answers voice calls at the same phone number you will use for fax calls on the device?
Continue answering questions.
7. Do you subscribe to a voice mail service through your telephone company at the same phone number you will use for fax calls on the device?
After you have completed answering the questions, proceed to the next section to select your fax setup case.

Select your fax setup case

Now that you have answered all the questions about the equipment and services that share the phone line with the device, you are ready to choose the best setup case for your home or office.

From the first column in the following table, choose the combination of equipment and services applicable to your home or office setting. Then look up the appropriate setup case in the second or third column based on your phone system. Step-by-step instructions are included for each case in the sections that follow.

If you have answered all the questions in the previous section and have none of the described equipment or services, choose "None" from the first column in the table.

 **NOTE:** If your home or office setup is not described in this section, set up the device as you would a regular analog phone. Make sure you use the phone cord supplied in the box to connect one end to your telephone wall jack and the other end to the port labeled 1-LINE on the back of the device. If you use another phone cord, you might experience problems sending and receiving faxes.

Other equipment/services sharing your fax line	Recommended fax setup for parallel-type phone systems	Recommended fax setup for serial-type phone systems
None (You answered No to all questions.)	Case A: Separate fax line (no voice calls received)	Refer to your country in Serial-type fax setup
DSL service (You answered Yes to question 1 only.)	Case B: Set up the device with DSL	Refer to your country in Serial-type fax setup
PBX or ISDN system (You answered Yes to question 2 only.)	Case C: Set up the device with a PBX phone system or an ISDN line	Refer to your country in Serial-type fax setup
Distinctive ring service (You answered Yes to question 3 only.)	Case D: Fax with a distinctive ring service on the same line	Refer to your country in Serial-type fax setup
Voice calls (You answered Yes to question 4 only.)	Case E: Shared voice/fax line	Refer to your country in Serial-type fax setup
Voice calls and voice mail service (You answered Yes to questions 4 and 7 only.)	Case F: Shared voice/fax line with voice mail	Refer to your country in Serial-type fax setup
Computer dial-up modem (You answered Yes to question 5 only.)	Case G: Fax line shared with computer modem (no voice calls received)	Not applicable.
Voice calls and computer dial-up modem	Case H: Shared voice/fax line with computer modem	Not applicable.

(continued)

Other equipment/services sharing your fax line	Recommended fax setup for parallel-type phone systems	Recommended fax setup for serial-type phone systems
(You answered Yes to questions 4 and 5 only.)		
Voice calls and answering machine (You answered Yes to questions 4 and 6 only.)	Case I: Shared voice/fax line with answering machine	Not applicable.
Voice calls, computer dial-up modem, and answering machine (You answered Yes to questions 4, 5, and 6 only.)	Case J: Shared voice/fax line with computer modem and answering machine	Not applicable.
Voice calls, computer dial-up modem, and voice mail service (You answered Yes to questions 4, 5, and 7 only.)	Case K: Shared voice/fax line with computer dial-up modem and voice mail	Not applicable.

Case A: Separate fax line (no voice calls received)

If you have a separate phone line on which you receive no voice calls, and you have no other equipment connected on this phone line, set up the device as described in this section.

Figure 7-1 Back view of the device

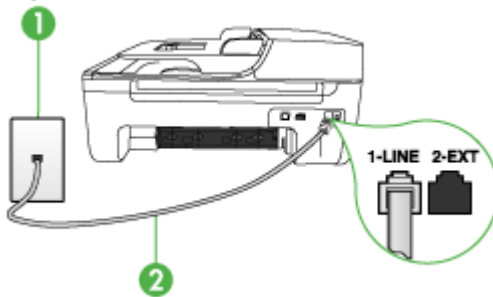

1	Telephone wall jack
2	Use the phone cord supplied in the box with the device to connect to the 1-LINE port

To set up the device with a separate fax line

1. Using the phone cord supplied in the box with the device, connect one end to your telephone wall jack, then connect the other end to the port labeled 1-LINE on the back of the device.

 **NOTE:** If you do not use the supplied cord to connect from the telephone wall jack to the device, you might not be able to fax successfully. This special phone cord is different from the phone cords you might already have in your home or office.

2. Turn on the **Auto Answer** setting.
3. (Optional) Change the **Rings to Answer** setting to the lowest setting (two rings).
4. Run a fax test.

When the phone rings, the device answers automatically after the number of rings you set in the **Rings to Answer** setting. The device begins emitting fax reception tones to the sending fax machine and receives the fax.

Case B: Set up the device with DSL

If you have a DSL service through your telephone company, and do not connect any equipment to the device, use the instructions in this section to connect a DSL filter between the telephone wall jack and the device. The DSL filter removes the digital signal that can interfere with the device, so the device can communicate properly with the phone line. (DSL might be called ADSL in your country/region.)

 **NOTE:** If you have a DSL line and you do not connect the DSL filter, you will not be able to send and receive faxes with the device.

Figure 7-2 Back view of the device



1	Telephone wall jack
2	DSL (or ADSL) filter and cord supplied by your DSL provider
3	Use the phone cord supplied in the box with the device to connect to the 1-LINE port

To set up the device with DSL

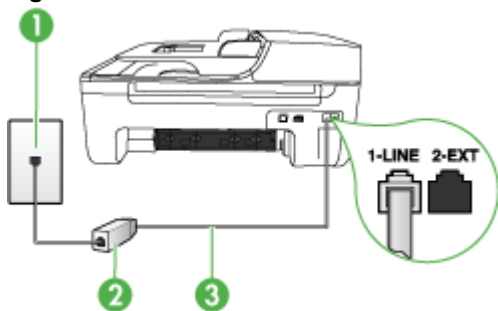
1. Obtain a DSL filter from your DSL provider.
2. Using the phone cord supplied in the box with the device, connect one end to the open port on the DSL filter, and then connect the other end to the port labeled 1-LINE on the back of the device.

 **NOTE:** If you do not use the supplied cord to connect from the DSL filter to the device, you might not be able to fax successfully. This special phone cord is different from the phone cords you might already have in your home or office. As only one phone cord is supplied, you may will need to obtain additional phone cords for this setup.

3. Connect an additional phone cord from the DSL filter to the telephone wall jack.
4. Run a fax test.

Case C: Set up the device with a PBX phone system or an ISDN line

If you are using either a PBX phone system or an ISDN converter/terminal adapter, make sure you do the following:

- If you are using either a PBX or an ISDN converter/terminal adaptor, connect the device to the port that is designated for fax and phone use. Also, make sure that the terminal adapter is set to the correct switch type for your country/region, if possible.

 **NOTE:** Some ISDN systems allow you to configure the ports for specific phone equipment. For example, you might have assigned one port for telephone and Group 3 fax and another port for multiple purposes. If you have problems when connected to the fax/phone port of your ISDN converter, try using the port designated for multiple purposes; it might be labeled "multi-combi" or something similar.

- If you are using a PBX phone system, set the call waiting tone to "off."

 **NOTE:** Many digital PBX systems include a call-waiting tone that is set to "on" by default. The call waiting tone will interfere with any fax transmission, and you will not be able to send or receive faxes with the device. Refer to the documentation that came with your PBX phone system for instructions on how to turn off the call-waiting tone.

- If you are using a PBX phone system, dial the number for an outside line before dialing the fax number.
- Make sure you use the supplied cord to connect from the telephone wall jack to the device. If you do not, you might not be able to fax successfully. This special phone cord is different from the phone cords you might already have in your home or office. If the supplied phone cord is too short, you can purchase a coupler from your local electronics store and extend it.

Case D: Fax with a distinctive ring service on the same line

If you subscribe to a distinctive ring service (through your telephone company) that allows you to have multiple phone numbers on one phone line, each with a different ring pattern, set up the device as described in this section.

Figure 7-3 Back view of the device

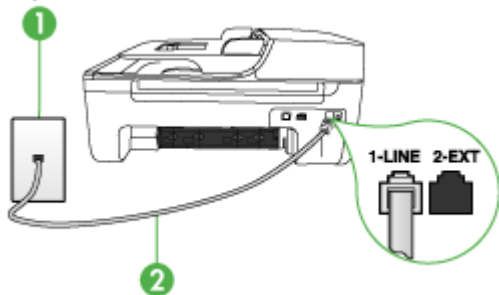

1	Telephone wall jack
2	Use the phone cord supplied in the box with the device to connect to the 1-LINE port

To set up the device with a distinctive ring service

- Using the phone cord supplied in the box with the device, connect one end to your telephone wall jack, then connect the other end to the port labeled 1-LINE on the back of the device.



NOTE: If you do not use the supplied cord to connect from the telephone wall jack to the device, you might not be able to fax successfully. This special phone cord is different from the phone cords you might already have in your home or office.

- Turn on the **Auto Answer** setting.
- Change the **Distinctive Ring** setting to match the pattern that the telephone company assigned to your fax number.



NOTE: By default, the device is set to answer all ring patterns. If you do not set the **Distinctive Ring** to match the ring pattern assigned to your fax number, the device might answer both voice calls and fax calls or it might not answer at all.

- (Optional) Change the **Rings to Answer** setting to the lowest setting (two rings).
- Run a fax test.

The device automatically answers incoming calls that have the ring pattern you selected (**Distinctive Ring** setting) after the number of rings you selected (**Rings to Answer** setting). The device begins emitting fax reception tones to the sending fax machine and receives the fax.

Case E: Shared voice/fax line

If you receive both voice calls and fax calls at the same phone number, and you have no other office equipment (or voice mail) on this phone line, set up the device as described in this section.

Figure 7-4 Back view of the device

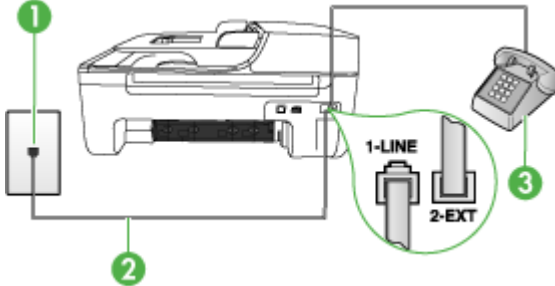

1	Telephone wall jack
2	Use the phone cord supplied in the box with the device to connect to the 1-LINE port
3	Telephone (optional)

To set up the device with a shared voice/fax line

1. Using the phone cord supplied in the box with the device, connect one end to your telephone wall jack, then connect the other end to the port labeled 1-LINE on the back of the device.

 **NOTE:** If you do not use the supplied cord to connect from the telephone wall jack to the device, you might not be able to fax successfully. This special phone cord is different from the phone cords you might already have in your home or office.

2. Do one of the following:
 - If you have a parallel-type phone system, remove the white plug from the port labeled 2-EXT on the back of the device, and then connect a phone to this port.
 - If you have a serial-type phone system, you might plug your phone directly on top of the device cable which has a wall plug attached to it.

3. Now you need to decide how you want the device to answer calls, automatically or manually:
 - If you set up the device to answer calls **automatically**, it answers all incoming calls and receives faxes. The device will not be able to distinguish between fax and voice calls in this case; if you suspect the call is a voice call, you will need to answer it before the device answers the call. To set up the device to answer calls automatically, turn on the **Auto Answer** setting.
 - If you set up the device to answer faxes **manually**, you must be available to respond in person to incoming fax calls or the device cannot receive faxes. To set up the device to answer calls manually, turn off the **Auto Answer** setting.
4. Run a fax test.

If you pick up the phone before the device answers the call and hear fax tones from a sending fax machine, you will need to answer the fax call manually.

Case F: Shared voice/fax line with voice mail

If you receive both voice calls and fax calls at the same phone number, and you also subscribe to a voice mail service through your telephone company, set up the device as described in this section.

 **NOTE:** You cannot receive faxes automatically if you have a voice mail service at the same phone number you use for fax calls. You must receive faxes manually; this means you must be available to respond in person to incoming fax calls. If you want to receive faxes automatically instead, contact your telephone company to subscribe to a distinctive ring service, or to obtain a separate phone line for faxing.

Figure 7-5 Back view of the device



1	Telephone wall jack
2	Use the phone cord supplied in the box with the device to connect to the "1-LINE" port

To set up the device with voice mail

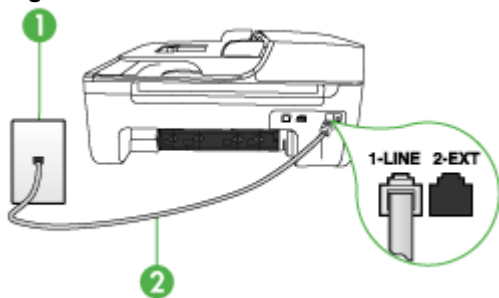
1. Using the phone cord supplied in the box with the device, connect one end to your telephone wall jack, then connect the other end to the port labeled 1-LINE on the back of the device.

 **NOTE:** If you do not use the supplied cord to connect from the telephone wall jack to the device, you might not be able to fax successfully. This special phone cord is different from the phone cords you might already have in your home or office.

2. Turn off the **Auto Answer** setting.
3. Run a fax test.

You must be available to respond in person to incoming fax calls, or the device cannot receive faxes. You must initiate the manual fax before voicemail picks up the line.

Case G: Fax line shared with computer modem (no voice calls received)

If you have a fax line on which you receive no voice calls, and you also have a computer modem connected on this line, set up the device as described in this section.

 **NOTE:** If you have a computer dial-up modem, your computer dial-up modem shares the phone line with the device. You will not be able to use both your modem and the device simultaneously. For example, you cannot use the device for faxing while you are using your computer dial-up modem to send an e-mail or access the Internet.

- [Set up the device with a computer dial-up modem](#)
- [Set up the device with a computer DSL/ADSL modem](#)

Set up the device with a computer dial-up modem

If you are using the same phone line for sending faxes and for a computer dial-up modem, follow these directions for setting up the device.

Figure 7-6 Back view of the device

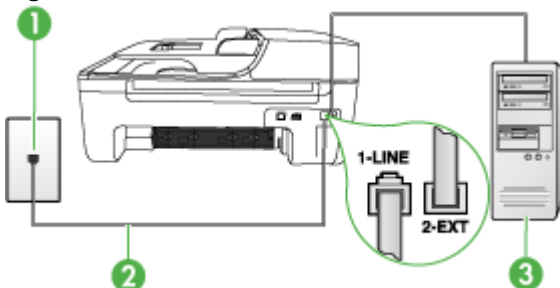

1	Telephone wall jack
2	Use the phone cord supplied in the box with the device to connect to the "1-LINE" port

To set up the device with a computer dial-up modem

1. Remove the white plug from the port labeled 2-EXT on the back of the device.
2. Find the phone cord that connects from the back of your computer (your computer dial-up modem) to a telephone wall jack. Disconnect the cord from the telephone wall jack and plug it into the port labeled 2-EXT on the back of the device.
3. Using the phone cord supplied in the box with the device, connect one end to your telephone wall jack, then connect the other end to the port labeled 1-LINE on the back of the device.



NOTE: If you do not use the supplied cord to connect from the telephone wall jack to the device, you might not be able to fax successfully. This special phone cord is different from the phone cords you might already have in your home or office.

4. If your modem software is set to receive faxes to your computer automatically, turn off that setting.



NOTE: If you do not turn off the automatic fax reception setting in your modem software, the device will not be able to receive faxes.

5. Turn on the **Auto Answer** setting.
6. (Optional) Change the **Rings to Answer** setting to the lowest setting (two rings).
7. Run a fax test.

When the phone rings, the device automatically answers after the number of rings you set in the **Rings to Answer** setting. The device begins emitting fax reception tones to the sending fax machine and receives the fax.

Set up the device with a computer DSL/ADSL modem

If you have a DSL line and use that phone line to send faxes, follow these instructions to set up your fax.

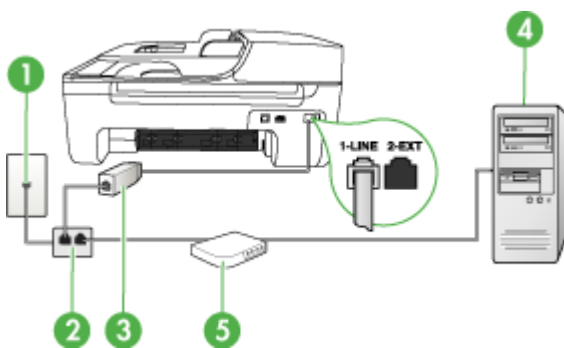

1	Telephone wall jack
2	Parallel splitter
3	DSL/ADSL filter Connect one end of the phone jack that was supplied with the device to connect to the 1-LINE port on the back of the device. Connect the other end of the cord to the DSL/ADSL filter.
4	Computer
5	Computer DSL/ADSL modem

 **NOTE:** You will need to purchase a parallel splitter. A parallel splitter has one RJ-11 port on the front and two RJ-11 ports on the back. Do not use a 2-line phone splitter, a serial splitter, or a parallel splitter which has two RJ-11 ports on the front and a plug on the back.



To set up the device with a computer DSL/ADSL modem

1. Obtain a DSL filter from your DSL provider.
2. Using the phone cord provided in the box with the device, connect one end to the DSL filter, and then connect the other end to the port labeled 1-LINE on the back of the device.

 **NOTE:** If you do not use the supplied cord to connect from the DSL filter to the back of the device, you might not be able to fax successfully. This special phone cord is different from the phone cords you might already have in your home or office.

3. Connect the DSL filter to the parallel splitter.
4. Connect the DSL modem to the parallel splitter.
5. Connect the parallel splitter to the wall jack.
6. Run a fax test.

When the phone rings, the device automatically answers after the number of rings you set in the **Rings to Answer** setting. The device begins emitting fax reception tones to the sending fax machine and receives the fax.

Case H: Shared voice/fax line with computer modem

If you receive both voice calls and fax calls at the same phone number, and you also have a computer modem connected on this phone line, set up the device as described in this section.

NOTE: Since your computer modem shares the phone line with the device, you cannot use both your modem and the device simultaneously. For example, you cannot use the device for faxing while you are using your computer modem to send an e-mail or access the Internet.

- [Shared voice/fax with computer dial-up modem](#)
- [Shared voice/fax with computer DSL/ADSL modem](#)

Shared voice/fax with computer dial-up modem

If you use your phone line for both fax and telephone calls, use these instructions to set up your fax.

There are two different ways to set up the device with your computer based on the number of phone ports on your computer. Before you begin, check your computer to see if it has one or two phone ports.

- If your computer has only one phone port, you will need to purchase a parallel splitter (also called a coupler), as shown below. (A parallel splitter has one RJ-11 port on the front and two RJ-11 ports on the back. Do not use a two-line phone splitter, a serial splitter, or a parallel splitter which has two RJ-11 ports on the front and a plug on the back.)

Figure 7-7 Example of a parallel splitter



- If your computer has one phone port, set up the device as described below.

Figure 7-8 Back view of the device

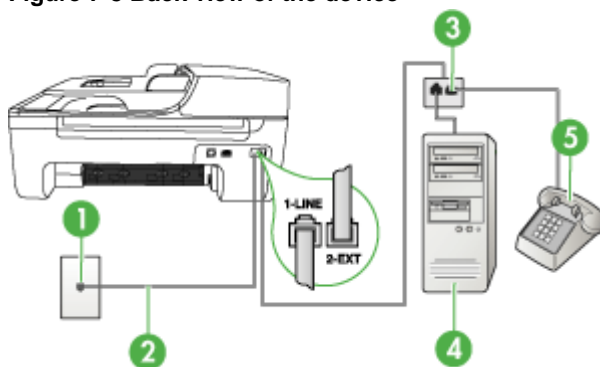

1	Telephone wall jack
2	Phone cord provided with the device plugged into the 1-LINE port on the back of the device
3	Parallel splitter

4	Computer
5	Telephone

To set up the device on the same phone line as a computer with one phone port

1. Remove the white plug from the port labeled 2-EXT on the back of the device.
2. Find the phone cord that connects from the back of your computer (your computer dial-up modem) to a telephone wall jack. Disconnect the cord from the telephone wall jack and plug it into the parallel splitter.
3. Connect a phone cord from the parallel splitter to the port labeled 2-EXT on the back of the device.
4. Connect a phone to the parallel splitter.
5. Using the phone cord supplied in the box with the device, connect one end to your telephone wall jack, then connect the other end to the port labeled 1-LINE on the back of the device.

 **NOTE:** If you do not use the supplied cord to connect from the telephone wall jack to the device, you might not be able to fax successfully. This special phone cord is different from the phone cords you might already have in your home or office.

6. If your modem software is set to receive faxes to your computer automatically, turn off that setting.

 **NOTE:** If you do not turn off the automatic fax reception setting in your modem software, the HP device will not be able to receive faxes.

7. Now you need to decide how you want the device to answer calls, automatically or manually:
 - If you set up the device to answer calls **automatically**, it answers all incoming calls and receives faxes. The device will not be able to distinguish between fax and voice calls in this case; if you suspect the call is a voice call, you will need to answer it before the device answers the call. To set up the device to answer calls automatically, turn on the **Auto Answer** setting.
 - If you set up the device to answer faxes **manually**, you must be available to respond in person to incoming fax calls or the device cannot receive faxes. To set up the device to answer calls manually, turn off the **Auto Answer** setting.

8. Run a fax test.

 **NOTE:** If your computer has two telephone ports on the back, you do not need to use a parallel splitter. You can plug the telephone into the “OUT” port on the computer dial-up modem.

If you pick up the phone before the device answers the call and hear fax tones from a sending fax machine, you will need to answer the fax call manually.

If you use your phone line for voice, fax, and your computer dial-up modem, follow these directions to set up your fax.

Shared voice/fax with computer DSL/ADSL modem

Use these instructions if your computer has a DSL/ADSL modem

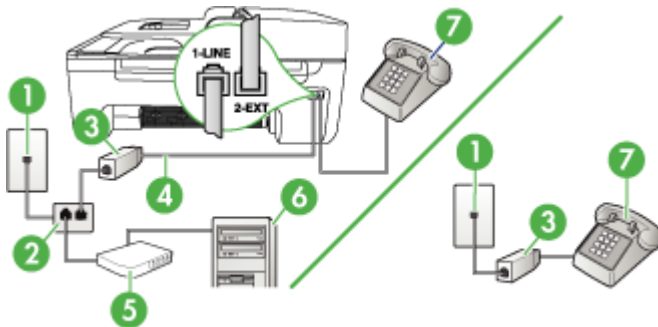

1	Telephone wall jack
2	Parallel splitter
3	DSL/ADSL filter
4	Phone cord supplied with the device
5	DSL/ADSL modem
6	Computer
7	Telephone

NOTE: You will need to purchase a parallel splitter. A parallel splitter has one RJ-11 port on the front and two RJ-11 ports on the back. Do not use a 2-line phone splitter, a serial splitter, or a parallel splitter which has two RJ-11 ports on the front and a plug on the back.



To set up the device with a computer DSL/ADSL modem

1. Obtain a DSL filter from your DSL provider.

 **NOTE:** Phones in other parts of the home/office sharing the same phone number with DSL service will need to be connected to additional DSL filters, otherwise you will experience noise when making voice calls.

2. Using the phone cord supplied in the box with the devices, connect one end to the DSL filter, then connect the other end to the port labeled 1-LINE on the back of the device.

 **NOTE:** If you do not use the supplied cord to connect from the DSL filter to the device, you might not be able to fax successfully. This special phone cord is different from phone cords you might already have in your home or office.

3. If you have a parallel-type phone system, remove the white plug from the port labeled 2-EXT on the back of the device, and then connect a phone to this port.
4. Connect the DSL filter to the parallel splitter.
5. Connect the DSL modem to the parallel splitter.
6. Connect the parallel splitter to the wall jack.
7. Run a fax test.

When the phone rings, the device automatically answers after the number of rings you set in the **Rings to Answer** setting. The device begins emitting fax reception tones to the sending fax machine and receives the fax.

Case I: Shared voice/fax line with answering machine

If you receive both voice calls and fax calls at the same phone number, and you also have an answering machine that answers voice calls at this phone number, set up the device as described in this section.

Figure 7-9 Back view of the device

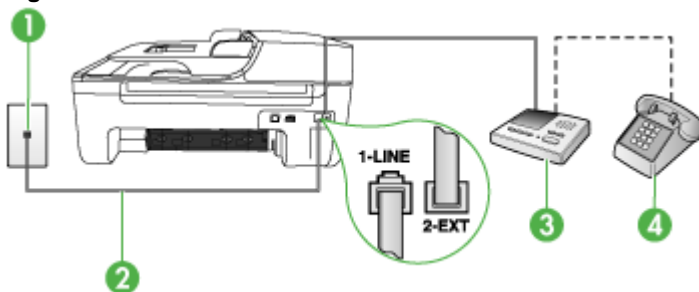

1	Telephone wall jack
2	Use the phone cord provided to connect to the 1-LINE port on the back of the device
3	Answering machine
4	Telephone (optional)

To set up the device with a shared voice/fax line with answering machine

1. Remove the white plug from the port labeled 2-EXT on the back of the device.
2. Unplug your answering machine from the telephone wall jack, and connect it to the port labeled 2-EXT on the back of the device.

 **NOTE:** If you do not connect your answering machine directly to the device, fax tones from a sending fax machine might be recorded on your answering machine, and you probably will not be able to receive faxes with the device.

3. Using the phone cord supplied in the box with the device, connect one end to your telephone wall jack, then connect the other end to the port labeled 1-LINE on the back of the device.

 **NOTE:** If you do not use the supplied cord to connect from the telephone wall jack to the device, you might not be able to fax successfully. This special phone cord is different from the phone cords you might already have in your home or office.

4. (Optional) If your answering machine does not have a built-in phone, for convenience you might want to connect a phone to the back of your answering machine at the "OUT" port.

 **NOTE:** If your answering machine does not let you connect an external phone, you can purchase and use a parallel splitter (also known as a coupler) to connect both the answering machine and telephone to the device. You can use standard phone cords for these connections.

5. Turn on the **Auto Answer** setting.
6. Set your answering machine to answer after a low number of rings.
7. Change the **Rings to Answer** setting on the device to the maximum number of rings supported by your device. (The maximum number of rings varies by country/region.)
8. Run a fax test.

When the phone rings, your answering machine answers after the number of rings you have set, and then plays your recorded greeting. The device monitors the call during this time, "listening" for fax tones. If incoming fax tones are detected, the device emits fax reception tones and receives the fax; if there are no fax tones, the device stops monitoring the line and your answering machine can record a voice message.

Case J: Shared voice/fax line with computer modem and answering machine

If you receive both voice calls and fax calls at the same phone number, and you also have a computer modem and answering machine connected on this phone line, set up the HP device as described in this section.

 **NOTE:** Since your computer dial-up modem shares the phone line with the HP device, you cannot use both your modem and the device simultaneously. For example, you cannot use the HP device for faxing while you are using your computer dial-up modem to send an e-mail or access the Internet.

- [Shared voice/fax line with computer dial-up modem and answering machine](#)
- [Shared voice/fax line with computer DSL/ADSL modem and answering machine](#)

Shared voice/fax line with computer dial-up modem and answering machine

There are two different ways to set the HP device with your computer based on the number of phone ports on your computer. Before you begin, check your computer to see if it has one or two phone ports.

- If your computer has only one phone port, you will need to purchase a parallel splitter, as shown below. (A parallel splitter has one RJ-11 port on the front and two RJ-11 ports on the back. Do not use a two-line phone splitter, a serial splitter, or a parallel splitter which has two RJ-11 ports on the front and a plug on the back.)

Figure 7-10 Example of a parallel splitter



- If your computer has one phone port, set up the HP device as described below.

Figure 7-11 Back view of the device

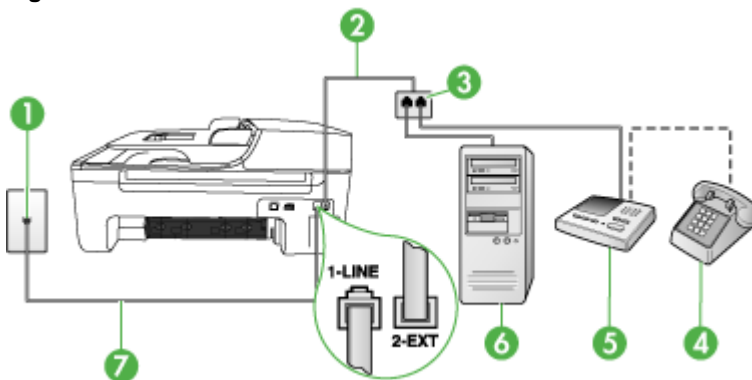

1	Telephone wall jack
2	Telephone cord connected to the parallel splitter
3	Parallel splitter
4	Telephone (optional)
5	Answering machine

6	Computer with modem
7	Use the phone cord supplied in the box with the device to connect to the "1-LINE" port

To set up the device on the same phone line as a computer with one phone port

1. Remove the white plug from the port labeled 2-EXT on the back of the HP device.
2. Find the phone cord that connects from the back of your computer (your computer dial-up modem) to a telephone wall jack. Disconnect the cord from the telephone wall jack and plug it into the port labeled 2-EXT on the back of the device.
3. Unplug your answering machine from the telephone wall jack, and connect it to the port labeled 2-EXT on the back of the device.

 **NOTE:** If you do not connect your answering machine directly to the device, fax tones from a sending fax machine might be recorded on your answering machine, and you might not be able to receive faxes with the device.

4. Using the phone cord supplied in the box with the HP device, connect one end to your telephone wall jack, then connect the other end to the port labeled 1-LINE on the back of the HP device.

 **NOTE:** If you do not use the supplied cord to connect from the telephone wall jack to the device, you might not be able to fax successfully. This special phone cord is different from the phone cords you might already have in your home or office.

5. (Optional) If your answering machine does not have a built-in phone, for convenience you might want to connect a phone to the back of your answering machine at the "OUT" port.

 **NOTE:** If your answering machine does not let you connect an external phone, you can purchase and use a parallel splitter (also known as a coupler) to connect both the answering machine and telephone to the device. You can use standard phone cords for these connections.

6. If your modem software is set to receive faxes to your computer automatically, turn off that setting.

 **NOTE:** If you do not turn off the automatic fax reception setting in your modem software, the device will not be able to receive faxes.

7. Turn on the **Auto Answer** setting.
8. Set your answering machine to answer after a low number of rings.
9. Change the **Rings to Answer** setting on the HP device to the maximum number of rings supported by your HP device. (The maximum number of rings varies by country/region.)
10. Run a fax test.

 **NOTE:** If you are using a computer with two telephone ports, you do not need a parallel splitter. You can plug the answering machine into the "OUT" port on the back of the computer.

When the phone rings, your answering machine answers after the number of rings you have set, and then plays your recorded greeting. The device monitors the call during this time, "listening" for fax tones. If incoming fax tones are detected, the device emits fax reception tones and receives the fax; if there are no fax tones, the device stops monitoring the line and your answering machine can record a voice message.

Shared voice/fax line with computer DSL/ADSL modem and answering machine

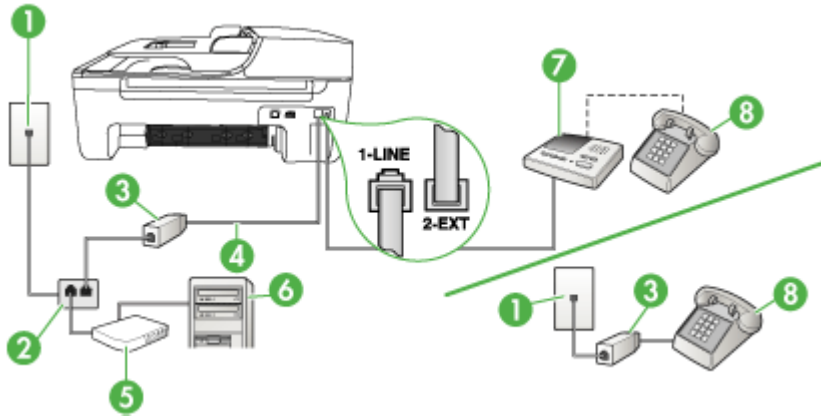

1	Telephone wall jack
2	Parallel splitter
3	DSL/ADSL filter
4	Phone cord provided with the device connected to the 1-LINE port on the back of the device
5	DSL/ADSL modem
6	Computer
7	Answering machine
8	Telephone (optional)

 **NOTE:** You will need to purchase a parallel splitter. A parallel splitter has one RJ-11 port on the front and two RJ-11 ports on the back. Do not use a 2-line phone splitter, a serial splitter, or a parallel splitter which has two RJ-11 ports on the front and a plug on the back.



To set up the device with a computer DSL/ADSL modem

1. Obtain a DSL/ADSL filter from your DSL/ADSL provider.

 **NOTE:** Phones in other parts of the home/office sharing the same phone number with DSL/ADSL service will need to be connected to additional DSL/ADSL filters, otherwise you will experience noise when making voice calls.

2. Using the phone cord supplied in the box with the device, connect one end to the DSL/ADSL filter, then connect the other end to the port labeled 1-LINE on the back of the device.

 **NOTE:** If you do not use the supplied cord to connect from the DSL/ADSL filter to the device, you might not be able to fax successfully. This special phone cord is different from the phone cords you might already have in your home or office.

3. Connect the DSL/ADSL filter to the splitter.
4. Unplug the answering machine from the telephone wall jack, and connect it to the port labeled 2-EXT on the back of the device.

 **NOTE:** If you do not connect your answering machine directly to the device, fax tones from a sending fax machine might be recorded on your answering machine, and you probably will not be able to receive faxes with the device.

5. Connect the DSL modem to the parallel splitter.
6. Connect the parallel splitter to the wall jack.
7. Set your answering machine to answer after a low number of rings.
8. Change your **Rings to Answer** setting on the device to the maximum number of rings supported by the device.

 **NOTE:** The maximum number of rings varies by country/region.

9. Run a fax test.

When the phone rings, your answering machine will answer after the number of rings you have set, and then play your recorded greeting. The device monitors the call during this time, “listening” for fax tones. If incoming fax tones are detected, the device will emit fax reception tones and receive the fax; if there are no fax tones, the device stops monitoring the line and your answering machine can record a voice message.

If you use the same phone line for telephone, fax, and have a computer DSL modem, follow these instructions to set up your fax.

Case K: Shared voice/fax line with computer dial-up modem and voice mail

If you receive both voice calls and fax calls at the same phone number, use a computer dial-up modem on the same phone line, and subscribe to a voice mail service through your telephone company, set up the device as described in this section.

NOTE: You cannot receive faxes automatically if you have a voice mail service at the same phone number you use for fax calls. You must receive faxes manually; this means you must be available to respond in person to incoming fax calls. If you want to receive faxes automatically instead, contact your telephone company to subscribe to a distinctive ring service, or to obtain a separate phone line for faxing.

Since your computer dial-up modem shares the phone line with the device, you cannot use both your modem and the device simultaneously. For example, you cannot use the device for faxing if you are using your computer dial-up modem to send an e-mail or access the Internet.

There are two different ways to set up the device with your computer based on the number of phone ports on your computer. Before you begin, check your computer to see if it has one or two phone ports.

- If your computer has only one phone port, you will need to purchase a parallel splitter (also called a coupler), as shown below. (A parallel splitter has one RJ-11 port on the front and two RJ-11 ports on the back. Do not use a two-line phone splitter, a serial splitter, or a parallel splitter which has two RJ-11 ports on the front and a plug on the back.)

Figure 7-12 Example of a parallel splitter



- If your computer has two phone ports, set up the device as described below.

Figure 7-13 Back view of the device

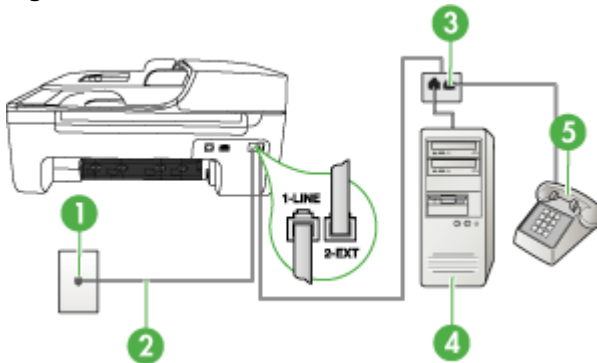

1	Telephone wall jack
2	Use the phone cord supplied in the box with the device to connect to the 1-LINE port
3	Parallel splitter
4	Computer with modem

To set up the device on the same phone line as a computer with two phone ports

1. Remove the white plug from the port labeled 2-EXT on the back of the device.
2. Find the phone cord that connects from the back of your computer (your computer dial-up modem) to a telephone wall jack. Disconnect the cord from the telephone wall jack and plug it into the port labeled 2-EXT on the back of the device.
3. Connect a phone to the "OUT" port on the back of your computer dial-up modem.
4. Using the phone cord supplied in the box with the device, connect one end to your telephone wall jack, then connect the other end to the port labeled 1-LINE on the back of the device.



NOTE: If you do not use the supplied cord to connect from the telephone wall jack to the device, you might not be able to fax successfully. This special phone cord is different from the phone cords you might already have in your home or office.

5. If your modem software is set to receive faxes to your computer automatically, turn off that setting.



NOTE: If you do not turn off the automatic fax reception setting in your modem software, the device will not be able to receive faxes.

6. Turn off the **Auto Answer** setting.
7. Run a fax test.

You must be available to respond in person to incoming fax calls, or the device cannot receive faxes.

Serial-type fax setup

For information on setting up the device for faxing using a serial-type phone system, see the Fax Configuration Web site for your country/region.

Austria	www.hp.com/at/faxconfig
Germany	www.hp.com/de/faxconfig
Switzerland (French)	www.hp.com/ch/fr/faxconfig
Switzerland (German)	www.hp.com/ch/de/faxconfig
United Kingdom	www.hp.com/uk/faxconfig
Finland	www.hp.fi/faxconfig
Denmark	www.hp.dk/faxconfig
Sweden	www.hp.se/faxconfig
Norway	www.hp.no/faxconfig
Netherlands	www.hp.nl/faxconfig
Belgium (Dutch)	www.hp.be/nl/faxconfig

(continued)

Belguim (French)	www.hp.be/fr/faxconfig
Portugal	www.hp.pt/faxconfig
Spain	www.hp.es/faxconfig
France	www.hp.com/fr/faxconfig
Ireland	www.hp.com/ie/faxconfig
Italy	www.hp.com/it/faxconfig

Configure the device (Windows)



NOTE: Microsoft Internet Explorer 6.0 or higher must be installed on the computer system to run the installation program.

In addition, you must have administrator privileges to install a printer driver on Windows 2000, Windows XP, or Windows Vista.

When setting up the device, HP recommends that you connect it after you install the software because the installation program is designed to provide you with the easiest setup experience. However, if you have connected the cable first, see [Connect the device before installing the software](#).

Connect the device directly to your computer using a USB cable.



NOTE: If you install the device software and connect the device to a computer running Windows, you can connect additional devices to the same computer with USB cables without reinstalling the device software.

- [Install the software before connecting the device \(recommended\)](#)
- [Connect the device before installing the software](#)
- [Share the device on a locally shared network](#)

Install the software before connecting the device (recommended)

To install the software

1. Close any applications that are running.
2. Insert the Starter CD into the CD drive. The CD menu runs automatically. If the CD menu does not start automatically, double-click the setup icon on the Starter CD.
3. On the CD menu, click the appropriate installation option and follow the onscreen instructions.
4. When prompted, turn on the device and connect it to the computer using a USB cable. The **Found New Hardware** wizard appears on the computer screen, and the device icon is created in the Printers folder.

 **NOTE:** You may connect the USB cable at a later time when you need to use the device.

You can also share the device with other computers using a simple form of networking known as locally shared networking. For more information, see [Share the device on a locally shared network](#).

Connect the device before installing the software

If you connected the device to the computer before installing the device software, the **Found New Hardware** wizard displays on the computer screen.

 **NOTE:** If you turned on the device, do not turn it off or unplug the cable from the device while the installation program is running. If you do so, the installation program will not finish.

To connect the device

1. In the **Found New Hardware** dialog box that displays methods for locating the printer driver, select the Advanced option, and then click **Next**.

 **NOTE:** Do not allow the **Found New Hardware** wizard to perform an automatic search for the printer driver.

2. Select the check box for specifying the driver location, and ensure that the other check boxes are clear.
3. Insert the Starter CD into the CD drive. If the CD menu appears, close it.
4. Browse to locate the root directory on the Starter CD (for example, D), and then click **OK**.
5. Click **Next** and follow the onscreen instructions.
6. Click **Finish** to close the **Found New Hardware** wizard. The wizard automatically starts the installation program (this might take a short while).
7. Complete the installation process.

 **NOTE:** You can also share the device with other computers using a simple form of networking known as locally shared networking. For more information, see [Share the device on a locally shared network](#).

Share the device on a locally shared network

In a locally shared network, the device is connected directly to the USB connector of a selected computer (known as the server) and is shared by other computers (clients).

 **NOTE:** When sharing a directly connected device, use the computer with the newest operating system as the server. For example, if you have a computer running Windows XP and another computer running an older version of Windows, use the computer running Windows XP as the server.

Use this configuration only in small groups or when usage is low. The connected computer is slowed down when many users print to the device.

Only the printing function is shared. Scan and Copy functions are not shared.

To share the device

1. Click **Start**, point to **Settings**, and then click **Printers** or **Printers and Faxes**.
- Or -
Click **Start**, click **Control Panel**, and then double-click **Printers**.
2. Right-click the device icon, click **Properties**, and then click the **Sharing** tab.
3. Click the option to share the device, and give it a share name.
4. To share the device with client computers that use other versions of Windows, click **Additional Drivers** to install those drivers as a convenience to the users. You must have the Starter CD in your CD drive.

Configure the device (Mac OS)

You can use the device with a single Macintosh computer using a USB cable, or you can share it among other users on a network.

This section contains the following topics:

- [To install the software](#)
- [Share the device on a locally shared network](#)

To install the software

1. Connect the device to your computer with a USB cable.
2. Insert the Starter CD into the CD drive. Double-click the CD icon on the desktop, and then double-click the setup icon. Also, you can locate the Installer folder on the Starter CD.
3. Click **Install Software** and follow the onscreen instructions.
4. If necessary, share the device with other Macintosh computer users. For more information, see [Share the device on a locally shared network](#).

Share the device on a locally shared network

When you connect the device directly, you can share it with other computers using a simple form of networking known as locally shared networking. Use this configuration only in small groups or when usage is low. The connected computer is slowed down when many users print to the device.

Basic requirements for sharing in the Mac OS environment include the following items:

- The Macintosh computers must be communicating on the network using TCP/IP, and they must have IP addresses. (AppleTalk is not supported.)
- The device that is being shared must be connected to a built-in USB port on the host Macintosh computer.
- Both the host Macintosh computer and the client Macintosh computers that are using the shared device must have printer sharing enabled, and the driver or PPD for the device that is installed.

For more information about USB device sharing, see the support information on the Apple Web site (www.apple.com) or the Apple Macintosh Help on the computer.

To share the device among computers running Mac OS

1. Turn on printer sharing on all Macintosh computers (host and clients) that are connected to the printer. Depending on the OS version you are using, do one of the following:
 - **Mac OS 10.3:** Open **System Preferences**, click **Print & Fax**, and then check the box next to **Share my printers with other computers**.
 - **Mac OS 10.4:** Open **System Preferences**, click **Print & Fax**, click the **Sharing** tab, check the box next to **Share these printers with other computers**, and then select the printer to be shared.
 - **Mac OS 10.5:** Open **System Preferences**, click **Print & Fax**, click the **Sharing** tab, check the box next to **Share these printers with other computers**, and then select the printer to be shared.
2. To print from the other Macintosh computers (the clients) on the network, do the following:
 - a. Click **File**, and then select **Page Setup** in the document you want to print.
 - b. In the drop-down menu next to **Format for**, select **Shared Printers**, and then select your device.
 - c. Select the **Paper Size**, and then click **OK**.
 - d. In the document, click **File**, and then select **Print**.
 - e. From the drop-down menu next to **Printer**, select **Shared Printers**, and then select your device.
 - f. Make additional settings, if necessary, and then click **Print**.

Set up the device for wireless communication (HP Officejet J4680 only)

You may set up the device for wireless communication using one of the following ways:

Setup method	Infrastructure wireless communication	Ad hoc wireless communication*
USB cable For more information, see To set up the device on a wireless network (Mac OS) or To set up wireless communication using the installer (Windows) .	✓	✓
Device control panel	✓	✓

* An ad hoc network can be set up using the Wireless Connection Utility on the Starter CD.



NOTE: If you encounter problems, see [Solve wireless problems \(HP Officejet J4680 only\)](#).

To use the device with any wireless connection, you must run the installation program at least once from the Starter CD and create a wireless connection.

Make sure the device is not connected to the network using a network cable.

The sending device must have built-in 802.11 capabilities or an 802.11 wireless card installed.

The device and the computers that use it must be on the same subnet.

Before installing the device software, you may wish to find out the settings of your network. Obtain the information from your system administrators, or complete the following tasks:

- Obtain your network's network name or Service Set Identifier (SSID) and communication mode (infrastructure or ad hoc) from the configuration utility for the network's wireless access point (WAP) or the computer's network card.
- Find out the type of encryption your network uses, such as Wired Equivalent Privacy (WEP).
- Find out the security password or encryption key of the wireless device.

This section contains the following topics:

- [Understand 802.11 wireless network settings](#)
- [To set up wireless communication using the device control panel with wireless setup wizard](#)
- [To set up wireless communication using the installer \(Windows\)](#)
- [To set up the device on a wireless network \(Mac OS\)](#)
- [To turn off wireless communication](#)
- [To print a wireless test page](#)
- [Reset wireless settings](#)
- [Guidelines for reducing interference on a wireless network](#)
- [Guidelines for ensuring wireless network security](#)

Understand 802.11 wireless network settings

Network name (SSID)

By default, the device looks for the wireless network name or SSID named "hpsetup." Your network may have a different SSID.

Communication mode

There are two communication mode options:

- **Ad hoc:** On an ad hoc network, the device is set to ad hoc communication mode and communicates directly with other wireless devices without the use of a WAP. All devices on the ad hoc network must:
 - Be 802.11 compatible
 - Have ad hoc as the communication mode
 - Have the same network name (SSID)

- Be on the same subnet and same channel
- Have the same 802.11 security settings
- **Infrastructure (recommended):** On an infrastructure network, the device is set to infrastructure communication mode and communicates with other devices on the network, whether the devices are wired or wireless, through a WAP. WAPs commonly act as routers or gateways on small networks.

Security settings

 **NOTE:** For more information on wireless security, visit www.weca.net/opensection/pdf/whitepaper_wi-fi_security4-29-03.pdf.

- **Network authentication:** The device's factory default setting is 'Open,' which does not require security for authorization or encryption. The other possible values are 'OpenThenShared,' 'Shared,' and 'WPA-PSK' (Wi-Fi® Protected Access Pre-Shared Key).

WPA increases the level of over-the-air data protection and access control on existing and future Wi-Fi networks. It addresses all known weaknesses of WEP, the original native security mechanism in the 802.11 standard.

WPA2 is the second generation of WPA security; it provides enterprise and consumer Wi-Fi users with a high level of assurance that only authorized users can access their wireless networks.

- **Data encryption:**
 - Wired Equivalent Privacy (WEP) provides security by encrypting data sent over radio waves from one wireless device to another wireless device. Devices on a WEP-enabled network use WEP keys to encode data. If your network uses WEP, you must know the WEP key(s) it uses.
 - WPA uses the Temporal Key Integrity Protocol (TKIP) for encryption and employs 802.1X authentication with one of the standard Extensible Authentication Protocol (EAP) types available today.
 - WPA2 provides a new encryption scheme, the Advanced Encryption Standard (AES). AES is defined in counter cipher-block chaining mode (CCM) and supports the Independent Basic Service Set (IBSS) to enable security between client workstations operating in ad hoc mode.

To set up wireless communication using the device control panel with wireless setup wizard

The Wireless Setup Wizard provides an easy way to set up and manage a wireless connection to your device.

 **NOTE:** To use this method, you must have a wireless network set up and running.

1. Set up the device hardware (see the getting started guide or the setup poster that came with your device).
2. On the device control panel, press the **Setup** button.
3. Press an arrow button to move to **Wireless Menu**, and then press **OK**.
4. Press an arrow button to move to **Setup Wizard**, and then press **OK**.
5. Follow the display instructions to complete the setup.

To set up wireless communication using the installer (Windows)

For this method, you will need to have a network set up and running.

1. Set up the device hardware (see the Wireless getting started guide).
2. Remove the protective cover from the device's network port.
3. Close any applications that are running on your computer system.
4. Insert the Starter CD into the CD drive. The CD menu runs automatically. If the CD menu does not start automatically, double-click the setup icon on the Starter CD.
5. On the CD menu, click the appropriate installation option and follow the onscreen instructions.
6. On the **Connection Type** screen, select **Wireless**, and then click **Next**.



NOTE: If the device cannot be found, you will have the option to temporarily use a network cable to communicate with the device and configure its wireless settings.

Complete the following steps to temporarily connect the device to your computer network if you are unable to establish wireless communication.

- a. Temporarily connect the device to the network with a USB cable.
 - b. Follow the onscreen instructions and disconnect the cable when prompted.
7. On the **Select a Network Name (SSID)** screen, click **Select a detected Wireless Network Name (SSID)** to select the wireless network, or click **Specify a wireless network** to enter a new network name.
 8. If you chose to enter a new network name, enter it on the device control panel, and then press **Done**.



NOTE: If the SSID that you entered is not found, you will be asked to provide security information. If the network does not use encryption, setup will attempt to verify the SSID before continuing.

9. If the device cannot connect to the network name, supply the appropriate WEP key or WPA passphrase on the keypad when prompted, and then press **Done**.



NOTE: Be sure to unplug the USB cable when you are done.

To set up the device on a wireless network (Mac OS)

1. Set up the device hardware (see the Wireless getting started guide).
2. Ensure an AirPort card is installed on the computer.
3. Close any applications that are running on your computer system.
4. Open the **AirPort Setup Assistant** from the Utilities folder. Refer to the AirPort documentation for details on setting up on wireless networks.
5. For ad hoc networks, click the **AirPort** icon on the menu bar and select "hpsetup" under **Computer to Computer Networks**. For wireless networks, click the **AirPort** icon, and then click **Other** to join the network.
6. Insert the Starter CD into the CD drive. The CD menu runs automatically. If the CD menu does not start automatically, double-click the setup icon on the Starter CD.
7. On the CD menu, click **Install Software** and follow the onscreen instructions.

8. On the **Connection Type** screen, select the wireless network option, and then click **Done**.
9. Follow the onscreen instructions to install the printer driver.

To turn off wireless communication

- **Device control panel:** Press **Setup**, then select **Wireless**, then select **Wireless ON/OFF**, and then select either **On** or **Off**.
- Press the wireless button on the front of the device.

To print a wireless test page

Print the wireless test page for information about the device's wireless connection. The wireless test page provides information about the device's status, MAC address, and IP address. If the device is connected to a network, the test page displays details about the network settings.

- ▲ **Device control panel:** Press **Setup**, select **Print Report**, select **Wireless Test**, and then press **OK**.

Reset wireless settings

Reset network configuration settings

If the device is still unable to communicate with the network, reset the device's network settings.

- Press **Setup**. Press an arrow button to move to **Network**, and then press **OK**.
- Press an arrow button to move to **Reset Wireless**, and then press **OK**.
- Print the wireless configuration page and verify that the network settings have been reset. For more information, see [Print wireless configuration settings](#). By default, the network name (SSID) is "hpsetup" and the communication mode is "ad hoc."

Guidelines for reducing interference on a wireless network

The following tips will help reduce the chances for interference in a wireless network:

- Keep the wireless devices away from large metal objects, such as filing cabinets, and other electromagnetic devices, such as microwaves and cordless telephones, as these objects can disrupt radio signals.
- Keep the wireless devices away from large masonry structures and other building structures as these objects can absorb radio waves and lower signal strength.
- For an infrastructure network, position the WAP in a central location in line of sight with the wireless devices on the network.
- Keep all wireless devices on the network within range of one another.

Guidelines for ensuring wireless network security

This section contains the following topics:

- [To add hardware addresses to a WAP](#)
- [Other guidelines](#)

To add hardware addresses to a WAP

MAC filtering is a security feature in which a WAP is configured with a list of MAC addresses (also called "hardware addresses") of devices that are allowed to gain access to the network through the WAP.

If the WAP does not have the hardware address of a device attempting to access the network, the WAP denies the device access to the network.

If the WAP filters MAC addresses, then the device's MAC address must be added to the WAP's list of accepted MAC addresses.

- ▲ Open the WAP's configuration utility, and add the device's hardware address to the list of accepted MAC addresses.

Other guidelines

To keep the wireless network secure, follow these guidelines:

- Use a password with at least 20 random characters. You can use up to 63 characters in a WPA password.
- Avoid any common words or phrases, easy sequences of characters (such as all 1s), and personally-identifiable information for passwords. Always use random strings composed of uppercase and lowercase letters, numbers, and if allowed, special characters such as punctuation.
- Change the password periodically.
- Change the default password provided by the manufacturer for administrator access to the access point or wireless router. Some routers let you change the administrator name as well.
- Place the access point or router in the center of a room and not near a window.
- Turn off administrative access over wireless if possible. If you do this, you need to connect to the router with a wired Ethernet connection when you want to make configuration changes.
- Turn off remote administrative access over the Internet on your router, if possible. You can use Remote Desktop to make an encrypted connection to a computer running behind your router and make configuration changes from the local computer you are accessing over the Internet.
- To avoid accidentally connecting to another party's wireless network, turn off the setting to automatically connect to non-preferred networks. This is disabled by default in Windows XP.

Uninstall and reinstall the software

If your installation is incomplete, or if you connected the USB cable to a Windows computer before being prompted by the software installation screen, you might need to uninstall and then reinstall the software. Do not simply delete the device application files from your computer. Make sure to remove them properly using the uninstall utility provided when you installed the software that came with the device.

There are three methods to uninstall the software on a Windows computer, and one method to uninstall on a Macintosh computer.

To uninstall from a Windows computer, method 1

1. Disconnect the device from your computer. Do not connect it to your computer until after you have reinstalled the software.
2. Press the **Power** button to turn off the device.
3. On the Windows taskbar, click **Start**, select **Programs** or **All Programs**, select **HP**, select **Officejet J4500 Series**, and then click **Uninstall**.
4. Follow the onscreen instructions.
5. If you are asked whether you would like to remove shared files, click **No**. Other programs that use these files might not work properly if the files are deleted.
6. Restart your computer.
7. To reinstall the software, insert the device Starter CD into your computer's CD-ROM drive, follow the onscreen instructions, and also see [Install the software before connecting the device \(recommended\)](#).
8. After the software is installed, connect the device to your computer.
9. Press the **Power** button to turn the device on.
After connecting and turning on the device, you might have to wait several minutes for all of the Plug and Play events to complete.
10. Follow the onscreen instructions.

When the software installation is complete, the **HP Digital Imaging Monitor** icon appears in the Windows system tray.

To uninstall from a Windows computer, method 2

 **NOTE:** Use this method if **Uninstall** is not available in the Windows Start menu.

1. On the Windows taskbar, click **Start**, select **Settings**, select **Control Panel**, and then click **Add/Remove Programs**.
- Or -
Click **Start**, click **Control Panel**, and then double-click **Programs and Features**.
2. Select **HP Officejet All-in-One Series**, and then click **Change/Remove** or **Uninstall/Change**.
Follow the onscreen instructions.
3. Disconnect the device from your computer.
4. Restart your computer.

 **NOTE:** It is important that you disconnect the device before restarting your computer. Do not connect the device to your computer until after you have reinstalled the software.

5. Insert the device Starter CD into your computer's CD-ROM drive and then start the Setup program.
6. Follow the onscreen instructions and also see [Install the software before connecting the device \(recommended\)](#).

To uninstall from a Windows computer, method 3

 **NOTE:** Use this method if **Uninstall** is not available in the Windows Start menu.

1. Insert the device Starter CD into your computer's CD-ROM drive, and then start the Setup program.
 2. Disconnect the device from your computer.
 3. Select **Uninstall** and follow the onscreen directions.
 4. Restart your computer.
-

 **NOTE:** It is important that you disconnect the device before restarting your computer. Do not connect the device to your computer until after you have reinstalled the software.

5. Start the Setup program for the device again.
6. Select **Install**.
7. Follow the onscreen instructions and also see [Install the software before connecting the device \(recommended\)](#).

To uninstall from a Macintosh computer

1. Launch **HP Device Manager**.
2. Click **Information and Settings**.
3. Select **Uninstall HP AiO Software** from the pull-down menu.
Follow the onscreen instructions.
4. After the software is uninstalled, restart your computer.
5. To reinstall the software, insert the device Starter CD into your computer's CD-ROM drive.
6. On the desktop, open the CD-ROM, and then double-click **HP All-in-One Installer**.
7. Follow the onscreen instructions and also see [To install the software](#).

8 Maintain and troubleshoot

This section contains the following topics:

- [Work with ink cartridges](#)
- [Clean the device](#)
- [General troubleshooting tips and resources](#)
- [Solve printing problems](#)
- [Poor print quality and unexpected printouts](#)
- [Solve paper-feed problems](#)
- [Solve scan problems](#)
- [Solve copy problems](#)
- [Solve fax problems](#)
- [Solve wireless problems \(HP Officejet J4680 only\)](#)
- [Troubleshoot installation issues](#)
- [Clear jams](#)

Work with ink cartridges

This section contains the following topics:

- [Supported ink cartridges](#)
- [Handle the ink cartridges](#)
- [Replace the ink cartridges](#)
- [Align the ink cartridges](#)
- [Clean the ink cartridges](#)
- [Clean the ink cartridge contacts](#)
- [Clean the area around the ink nozzles](#)
- [Store printing supplies](#)

Supported ink cartridges

The availability of ink cartridges varies by country/region. The ink cartridges might come in different sizes.

You can find the ink cartridge number in the following places:

- On the label of the ink cartridge you are replacing.
- **Windows:** From the **Toolbox**, if you have bidirectional communication, click the **Estimated Ink Levels** tab, scroll to display the **Cartridge Details** button, and then click **Cartridge Details**.
- **Mac OS:** From the **HP Printer Utility**, click **Supply Info** from the **Information and Support** panel, and then click **Retail Supplies Information**.

Handle the ink cartridges

Before you replace or clean a ink cartridge, you should know the part names and how to handle the ink cartridges.

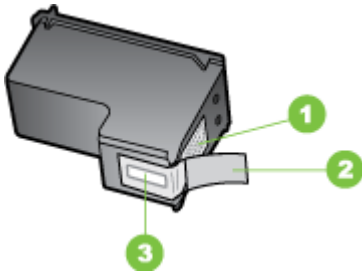

1	Copper-colored contacts
2	Plastic tape with pink pull tab (must be removed before installing)
3	Ink nozzles under tape

Hold the ink cartridges by their black plastic sides, with the label on top. Do not touch the copper-colored contacts or the ink nozzles.



 **NOTE:** Handle the ink cartridges carefully. Dropping or jarring cartridges can cause temporary printing problems, or even permanent damage.

Replace the ink cartridges

Follow these instructions when the ink level is low.

 **NOTE:** When the ink level for an ink cartridge is low, a message appears on the display. You can also check the ink levels by using the printer Toolbox (Windows) or the HP Printer Utility (Mac OS).

NOTE: Ink from the cartridges is used in the printing process in a number of different ways, including in the initialization process, which prepares the device and cartridges for printing. In addition, some residual ink is left in the cartridge after it is used. For more information see www.hp.com/go/inkusage.

Ink level warnings and indicators provide estimates for planning purposes only. When you receive a low-ink warning message, consider having a replacement cartridge

available to avoid possible printing delays. You do not need to replace the ink cartridges until print quality becomes unacceptable.

To order ink cartridges for the device, go to www.hpshopping.com. If prompted, choose your country/region, follow the prompts to select your product, and then click one of the shopping links on the page.

To replace the ink cartridges

1. Make sure the device is on.

△ **CAUTION:** If the HP All-in-One is off when you open the front access door to access the ink cartridges, the device will not release the cartridges for changing. You might damage the device if the ink cartridges are not docked safely when you try to remove them.

2. Open the front access door.
The print carriage moves to the far right side of the device.

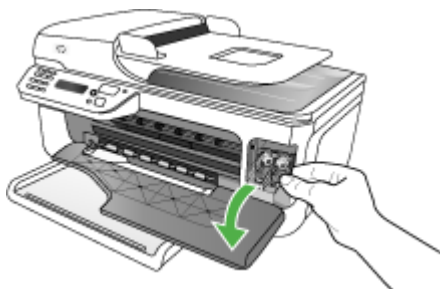

3. Wait until the print carriage is idle and silent, and then lightly press down on an ink cartridge to release it.
If you are replacing the tri-color ink cartridge, remove the ink cartridge from the slot on the left.

If you are replacing the black, photo, or gray photo ink cartridge, remove the ink cartridge from the slot on the right.

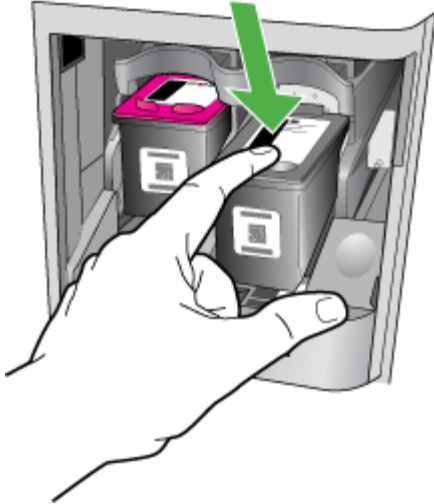

4. Pull the ink cartridge toward you out of its slot.
5. If you are removing the black ink cartridge in order to install the photo or gray photo ink cartridge, store the black ink cartridge in the ink cartridge protector or an airtight plastic container.
6. Remove the new ink cartridge from its packaging and, being careful to touch only the black plastic, gently remove the plastic tape by using the pink pull tab.

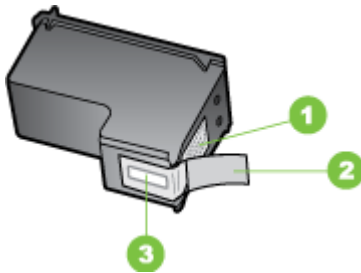

1	Copper-colored contacts
2	Plastic tape with pink pull tab (must be removed before installing)
3	Ink nozzles under tape

△ **CAUTION:** Do not touch the copper-colored contacts or ink nozzles. Also, do not re-tape the ink cartridges. Doing so can result in clogs, ink failure, and bad electrical connections.



7. Hold the ink cartridge with the HP logo on top, and insert the new ink cartridge into the empty cartridge slot. Make sure you push the ink cartridge in firmly until it snaps into place.

If you are installing the tri-color ink cartridge, slide it into the left slot.

If you are installing a black, photo, or gray photo ink cartridge, slide it into the right slot.

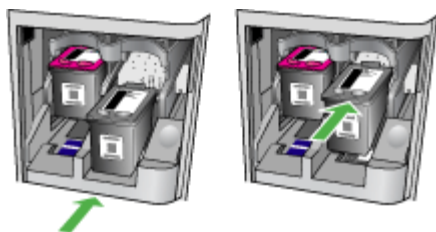

8. Close the front access door.
If you installed a new ink cartridge, the device prints an ink cartridge alignment page.
9. When prompted, ensure plain white paper is loaded in the input tray, then press **OK**.
10. Load the ink cartridge alignment sheet face down on the scanner glass in the front right corner with the top of the page to the right, and then press **OK**. For more information, see [Load an original on the scanner glass](#).

The HP All-in-One aligns the ink cartridges. Recycle or discard the ink cartridge alignment sheet.

Align the ink cartridges

The HP All-in-One prompts you to align cartridges every time you install or replace an ink cartridge. You can also align the ink cartridges at any time from the device control panel or by using the software you installed with the device. Aligning the ink cartridges ensures high-quality output.

 **NOTE:** If you remove and reinstall the same ink cartridge, the device will not prompt you to align the ink cartridges. It remembers the alignment values for that ink cartridge, so you do not need to realign the ink cartridges.

To align the ink cartridges from the device control panel when prompted

1. Make sure you have letter or A4 unused plain white paper loaded in the input tray, and then press **OK**.



NOTE: If you have colored paper loaded in the input tray when you align the ink cartridges, the alignment will fail. Load unused plain white paper into the input tray, and then try the alignment again.

If the alignment fails again, you might have a defective sensor or ink cartridge. Contact HP Support. Go to www.hp.com/support. If prompted, choose your country/region, and then click **Contact HP** for information on calling for technical support.

The HP All-in-One prints an ink cartridge alignment sheet.

2. Load the ink cartridge alignment sheet face down on the scanner glass in the front right corner with the top of the page to the right, and then press **OK**. For more information, see [Load an original on the scanner glass](#).

The HP All-in-One aligns the ink cartridges. Recycle or discard the ink cartridge alignment sheet.

To align the cartridges from the device control panel at any time

1. Load letter, A4, or legal unused plain white paper into the input tray.



NOTE: If you have colored paper loaded in the input tray when you align the ink cartridges, the alignment will fail. Load unused plain white paper into the input tray, and then try the alignment again.

If the alignment fails again, you might have a defective sensor or ink cartridge. Contact HP Support. Go to www.hp.com/support. If prompted, choose your country/region, and then click **Contact HP** for information on calling for technical support.

2. Press **Setup**.
3. Selects **Tools** and then select **Align Cartridge**.

The HP All-in-One prints an ink cartridge alignment sheet.

4. Load the ink cartridge alignment sheet face down on the scanner glass in the front right corner with the top of the page to the right, and then press **OK**. For more information, see [Load an original on the scanner glass](#).

The HP All-in-One aligns the ink cartridges. Recycle or discard the ink cartridge alignment sheet.

To align the ink cartridges from the HP Photosmart Software (Windows)

1. Load letter, A4, or legal unused plain white paper into the input tray.
2. In the HP Solution Center, click **Settings**, point to **Print Settings**, and then click **Printer Toolbox**.



NOTE: You can also open the **Printer Toolbox** from the **Print Properties** dialog box. In the **Print Properties** dialog box, click the **Services** tab, and then click **Service this device**.

The **Printer Toolbox** appears.

3. Click the **Device Services** tab.
4. Click **Align the Ink Cartridges**.
The HP All-in-One prints an ink cartridge alignment sheet.
5. Load the ink cartridge alignment sheet face down on the scanner glass in the front right corner with the top of the page to the right, and then press **OK**. For more information, see [Load an original on the scanner glass](#).
The HP All-in-One aligns the ink cartridges. Recycle or discard the ink cartridge alignment sheet.

To align the ink cartridges from the HP Photosmart Studio Software (Mac OS)

1. Load letter, A4, or legal unused plain white paper into the input tray.
2. **HP Printer Utility (Mac OS)**: Open the HP Printer Utility. For more information, see [HP Printer Utility \(Mac OS\)](#). Click **Align** and follow the onscreen instructions.
The HP All-in-One prints an ink cartridge alignment sheet.
3. Load the ink cartridge alignment sheet face down on the scanner glass in the front right corner with the top of the page to the right, and then press **OK**. For more information, see [Load an original on the scanner glass](#).
The HP All-in-One aligns the ink cartridges. Recycle or discard the ink cartridge alignment sheet.

Clean the ink cartridges

Use this feature when there is streaking, white lines through any of the lines of color or when a color is muddy. Do not clean ink cartridges unnecessarily, as this wastes ink and shortens the life of the ink nozzles.

To clean the ink cartridges from the control panel

1. Load letter, A4, or legal unused plain white paper into the input tray.
2. Press **Setup**.
3. Select **Tools**, and then select **Clean Cartridge**.
The device prints a page that you can recycle or discard.
If copy or print quality still seems poor after you clean the ink cartridges, try cleaning the ink cartridge contacts before replacing the affected ink cartridge.

To clean the ink cartridges from the HP Photosmart Software

1. Load letter, A4, or legal unused plain white paper into the input tray.
2. In the HP Solution Center, click **Settings**, point to **Print Settings**, and then click **Printer Toolbox**.



NOTE: You can also open the **Printer Toolbox** from the **Print Properties** dialog box. In the **Print Properties** dialog box, click the **Services** tab, and then click **Service this device**.

The **Printer Toolbox** appears.

3. Click the **Device Services** tab.

4. Click **Clean the Ink Cartridges**.
5. Follow the prompts until you are satisfied with the quality of the output, and then click **Done**.
If copy or print quality still seems poor after you clean the ink cartridges, try cleaning the ink cartridge contacts before replacing the affected ink cartridge.

HP Printer Utility (Mac OS)

1. Open the HP Printer Utility. For more information, see [HP Printer Utility \(Mac OS\)](#).
2. Click **Clean** and follow the onscreen instructions.

Clean the ink cartridge contacts

Clean the ink cartridge contacts only if you get repeated messages on the display prompting you to check an ink cartridge after you already have cleaned or aligned the ink cartridges.

Before cleaning the ink cartridge contacts, remove the ink cartridge and verify that nothing is covering the ink cartridge contacts, then reinstall the ink cartridge. If you continue to get messages to check the ink cartridges, clean the ink cartridge contacts.

Make sure you have the following materials available:

- Dry foam rubber swabs, lint-free cloth, or any soft material that will not come apart or leave fibers.



TIP: Coffee filters are lint-free and work well for cleaning ink cartridges.

- Distilled, filtered, or bottled water (tap water might contain contaminants that can damage the ink cartridges).



CAUTION: Do **not** use platen cleaners or alcohol to clean the ink cartridge contacts. These can damage the ink cartridge or the HP All-in-One.

To clean the ink cartridge contacts

1. Turn on the device and open the ink cartridge door.
The print carriage moves to the far right side of the device.
2. Wait until the print carriage is idle and silent, and then unplug the power cord from the back of the device.

 **NOTE:** Depending how long the HP All-in-One is unplugged, the date and time might be erased. You might need to reset the date and time later, when you plug the power cord back in.

3. Lightly press down on the ink cartridge to release it, and then pull it toward you out of the slot.
4. Inspect the ink cartridge contacts for ink and debris buildup.
5. Dip a clean foam rubber swab or lint-free cloth into distilled water, and squeeze any excess water from it.
6. Hold the ink cartridge by its sides.

7. Clean only the copper-colored contacts. Allow the ink cartridges to dry for approximately ten minutes.

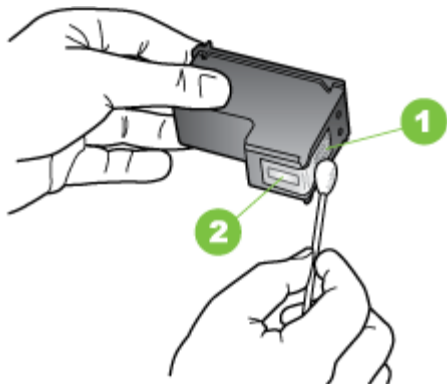

1	Copper-colored contacts
2	Ink nozzles (do not clean)

8. Slide the ink cartridge back into the slot. Push the ink cartridge forward until it clicks into place.
9. Repeat if necessary for the other ink cartridge.
10. Gently close the ink cartridge door and plug the power cord into the back of the device.

Clean the area around the ink nozzles

If the device is used in a dusty environment, a small amount of debris might accumulate inside the device. This debris can include dust, hair, carpet, or clothing fibers. When debris gets on the ink cartridges, it can cause ink streaks and smudges on printed pages. Ink streaking can be corrected by cleaning around the ink nozzles as described here.

 **NOTE:** Clean the area around the ink nozzles only if you continue to see streaks and smudges on your printed pages after you have already cleaned the ink cartridges by using the device control panel or the software you installed with the HP All-in-One.

Make sure you have the following materials available:

- Dry foam rubber swabs, lint-free cloth, or any soft material that will not come apart or leave fibers.

 **TIP:** Coffee filters are lint-free and work well for cleaning ink cartridges.

- Distilled, filtered, or bottled water (tap water might contain contaminants that can damage the ink cartridges).

 **CAUTION:** Do not touch the copper-colored contacts or ink nozzles. Touching these parts can result in clogs, ink failure, and bad electrical connections.

To clean the area around the ink nozzles

1. Turn on the device and open the ink cartridge door.
The print carriage moves to the far right side of the device.
2. Wait until the print carriage is idle and silent, and then unplug the power cord from the back of the device.

 **NOTE:** Depending how long the HP All-in-One is unplugged, the date and time might be erased. You might need to reset the date and time later, when you plug the power cord back in.

3. Lightly press down on the ink cartridge to release it, and then pull it toward you out of the slot.

 **NOTE:** Do not remove both ink cartridges at the same time. Remove and clean each ink cartridge one at a time. Do not leave an ink cartridge outside the device for more than 30 minutes.

4. Place the ink cartridge on a piece of paper with the ink nozzles facing up.
5. Lightly moisten a clean foam rubber swab with distilled water.

- Clean the face and edges around the ink nozzle area with the swab, as shown below.

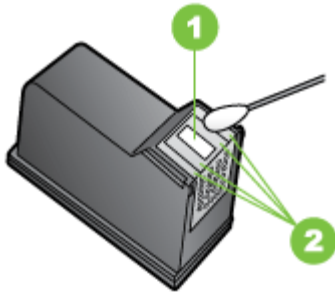

1	Nozzle plate (do not clean)
2	Face and edges around the ink nozzle area

△ **CAUTION:** Do **not** clean the nozzle plate.

- Slide the ink cartridge back into the slot. Push the ink cartridge forward until it clicks into place.
- Repeat if necessary for the other ink cartridge.
- Gently close the ink cartridge door and plug the power cord into the back of the device.

Store printing supplies

The ink cartridge protector is designed to keep an ink cartridge secure and prevent it from drying out when it is not being used. Whenever you remove an ink cartridge from the device with the intention of using it again later, store it in the ink cartridge protector. For example, store the black ink cartridge in an ink cartridge protector if you are removing it so you can print high-quality photos with the photo and tri-color ink cartridges.

 **NOTE:** If you do not have an ink cartridge protector, you can order one from HP Support. For more information, see [Support and warranty](#). You can also use an airtight container, such as a plastic tub. Make sure the nozzles are not touching anything when you store the ink cartridges.

To insert an ink cartridge into the ink cartridge protector

- ▲ Place the ink cartridge into the ink cartridge protector at a slight angle and snap it securely into place.

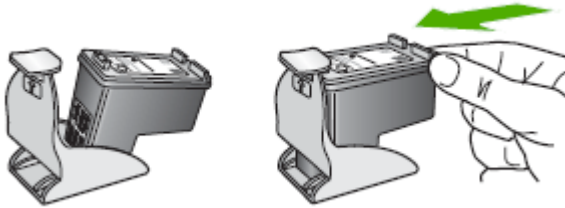

To remove the ink cartridge from the ink cartridge protector

- ▲ Press down on the top of the ink cartridge protector to release the ink cartridge, then gently remove the ink cartridge out of the ink cartridge protector.

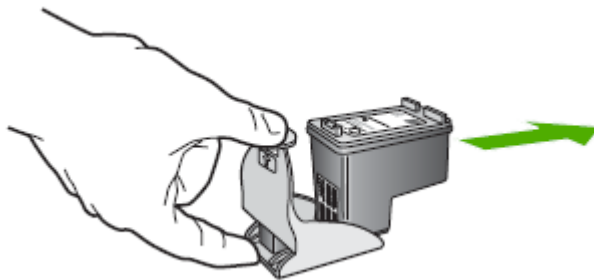

Clean the device

This section provides instructions for keeping the device in top working condition. Perform these maintenance procedures as necessary.

Dust or dirt on the scanner glass, scanner lid backing, or scanner frame can slow down performance, degrade the quality of scans, and affect the accuracy of special features.

- [Clean the scanner glass](#)
- [Clean the exterior](#)
- [Clean the automatic document feeder](#)

Clean the scanner glass

To clean the scanner glass

1. Turn off the device.
2. Lift the scanner lid.

3. Clean the glass by using a soft, lint-free cloth that has been sprayed with a mild glass cleaner. Dry the glass with a dry, soft, lint-free cloth.



△ **CAUTION:** Use only glass cleaner to clean the scanner glass. Avoid cleaners that contain abrasives, acetone, benzene, and carbon tetrachloride, all of which can damage the scanner glass. Avoid isopropyl alcohol because it can leave streaks on the glass.

CAUTION: Do not spray the glass cleaner directly on the glass. If too much glass cleaner is applied, the cleaner could leak under the glass and damage the scanner.

4. Close the scanner lid, and turn on the device.

Clean the exterior

 **NOTE:** Before cleaning the device, turn off the power and unplug the power cord from the electrical socket.

Use a soft, damp, lint-free cloth to wipe dust, smudges, and stains off of the case. The exterior of the device does not require cleaning. Keep fluids away from the interior of the device, as well as from the device control panel.

Clean the automatic document feeder

If the automatic document feeder picks up multiple pages or if it does not pick up plain paper, you can clean the rollers and separator pad. Lift the automatic document feeder cover to access the pick assembly inside the automatic document feeder, clean the rollers or separator pad, and then close the cover.

If you have lines or dust appearing on scanned documents or faxes, clean the mylar strip in the ADF.

To clean the rollers or separator pad

1. Remove all originals from the document feeder tray.
2. Lift the automatic document feeder cover (1).
This provides easy access to the rollers (2) and separator pad (3), as shown below.

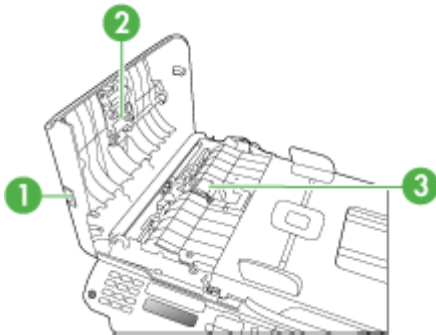

1	Automatic document feeder cover
2	Rollers
3	Separator pad

3. Lightly dampen a clean lint-free cloth with distilled water, then squeeze any excess liquid from the cloth.
4. Use the damp cloth to wipe any residue off the rollers or separator pad.

 **NOTE:** If the residue does not come off using distilled water, try using isopropyl (rubbing) alcohol.

5. Close the cover of the automatic document feeder.

To clean the plastic strip inside the automatic document feeder

1. Turn off the device and unplug the power cord.

 **NOTE:** Depending how long the device is unplugged, the date and time might be erased. You might need to reset the date and time later, when you plug the power cord back in.

2. Lift the cover of the automatic document feeder until it stops, and then gently pry the cover to release the catch.

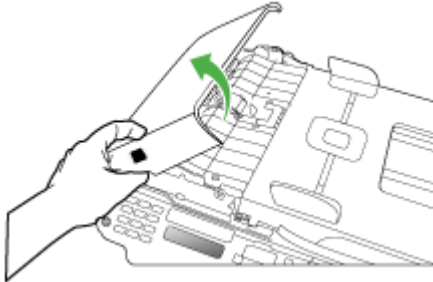

3. Continue lifting the automatic document feeder cover to the vertical position.

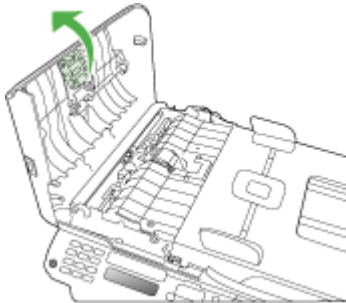

4. Lift the automatic document feeder mechanism.

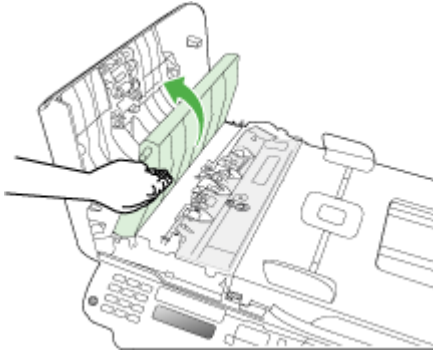

5. Clean the plastic strip with a soft cloth or sponge slightly moistened with a nonabrasive glass cleaner.

△ **CAUTION:** Do not use abrasives, acetone, benzene, or carbon tetrachloride on the plastic strip, since they can damage it. Do not place or spray liquid directly on the plastic strip. The liquid might seep under the glass and damage the device.

6. Gently lower the automatic document feeder mechanism to avoid dislodging the plastic strip, and then close the cover of the automatic document feeder.
7. Plug in the power cord, and then turn on the device.

📄 **NOTE:** If you still see dust or lines on scans after cleaning the plastic strip, you may need to order a new plastic strip. For more information, see [Support and warranty](#).

General troubleshooting tips and resources

Try these when you begin troubleshooting a printing problem.

- For a paper jam, see [Clear paper jams](#).
- For paper-feed problems, such as the paper skew and paper pick, see [Solve paper-feed problems](#).
- Power light is on and not blinking. When the device is turned on for the first time, it takes approximately 12 minutes to initialize it after the ink cartridges are installed.
- Power cord and other cables are working, and are firmly connected to the device. Make sure the device is connected firmly to a functioning alternating current (AC) power outlet, and is turned on. For voltage requirements, see [Electrical specifications](#).
- Media is loaded correctly in the input tray and is not jammed in the device.
- All packing tapes and materials are removed.

- The device is set as the current or default printer. For Windows, set it as the default in the Printers folder. For the Mac OS, set it as the default in the Printers & Faxes section of the System Preferences. See your computer's documentation for more information.
- **Pause Printing** is not selected if you are using a computer running Windows.
- You are not running too many programs when you are performing a task. Close programs that you are not using or restart the computer before attempting the task again.

Troubleshooting topics

- [Solve printing problems](#)
- [Poor print quality and unexpected printouts](#)
- [Solve paper-feed problems](#)
- [Solve copy problems](#)
- [Solve scan problems](#)
- [Solve fax problems](#)
- [Troubleshoot installation issues](#)

Solve printing problems

This section contains the following topics:

- [The device shuts down unexpectedly](#)
- [Error message appears on control-panel display](#)
- [The device is not responding \(nothing prints\)](#)
- [Device takes a long time to print](#)
- [Blank or partial page printed](#)
- [Something on the page is missing or incorrect](#)
- [Placement of the text or graphics is wrong](#)
- [The device prints half a page, then ejects the paper](#)

The device shuts down unexpectedly

Check the power and power connections

Make sure the device is connected firmly to a functioning alternating current (AC) power outlet. For voltage requirements, see [Electrical specifications](#).

Error message appears on control-panel display

A non-recoverable error has occurred

Disconnect all cables (such as power cord and USB cable), wait about 20 seconds, and reconnect the cables. If the problem persists, visit the HP Web site (www.hp.com/support) for the latest troubleshooting information, or product fixes and updates.

The device is not responding (nothing prints)

There are print jobs stuck in the print queue

Open the print queue, cancel all documents, and then reboot the computer. Try to print after the computer reboots. Refer to the Help system for the operating system for more information.

Check the device setup

For more information, see [General troubleshooting tips and resources](#).

Check the device software installation

If the device is turned off when printing, an alert message should appear on your computer screen; otherwise, the device software might not be installed correctly. To resolve this, uninstall the software completely, and then reinstall the device software. For more information, see [Uninstall and reinstall the software](#).

Check the cable connections

- Make sure both ends of the network/USB cable are secure.
- If the device is connected to a network, check the following:
 - Check the Link light on the back of the device.
 - Make sure you are not using a phone cord to connect the device.

Check any personal firewall software installed on the computer

The personal software firewall is a security program that protects a computer from intrusion. However, the firewall might block communication between the computer and the device. If there is a problem communicating with the device, try temporarily disabling the firewall. If the problem persists, the firewall is not the source of the communication problem. Re-enable the firewall.

Device takes a long time to print

Check the system configuration and resources

Make sure the computer meets the minimum system requirements for the device. For more information, see [System requirements](#).

Check the device software settings

Print speed is slower when **Best** or **Maximum dpi** is selected as the print quality. To increase the print speed, select different print settings in the device driver. For more information, see [Change print settings](#).

Blank or partial page printed

Clean the ink cartridge

Complete the ink cartridge cleaning procedure. For more information, see [Clean the ink cartridges](#).

Check the media settings

- Make sure you select the correct print quality settings in the printer driver for the media loaded in the trays.
- Make sure the page settings in the printer driver match the page size of media loaded in the tray.

More than one page is being picked

For more information on paper-feed problems, see [Solve paper-feed problems](#).

There is a blank page in the file

Check the file to make sure there is no blank page.

Something on the page is missing or incorrect

Check the margin settings

Make sure the margin settings for the document do not exceed the printable area of the device. For more information, see [Set minimum margins](#).

Check the color print settings

Make sure **Print in Grayscale** is not selected in the print driver.

Check the device location and length of USB cable

High electromagnetic fields (such as those generated by USB cables) can sometimes cause slight distortions to printouts. Move the device away from the source of the electromagnetic fields. Also, it is recommended that you use a USB cable that is less than 3 meters (9.8 feet) long to minimize the effects of these electromagnetic fields.

Check the ink cartridges

Make sure the correct ink cartridges are installed and the ink cartridges are not low on ink. For more information, see [Manage the device](#) and [Work with ink cartridges](#).

Placement of the text or graphics is wrong

Check how the media is loaded

Make sure the media width and length guides fit snugly against the edges of the stack of media, and make sure the tray is not overloaded. For more information, see [Load media](#).

Check the media size

- Content on a page might be cut off if the document size is larger than the media that you are using.
- Make sure the media size selected in the printer driver match the size of media loaded in the tray.

Check the margin settings

If the text or graphics are cut off at the edges of the page, make sure the margin settings for the document do not exceed the printable area of your device. For more information, see [Set minimum margins](#).

Check the page-orientation setting

Make sure the media size and page orientation selected in the application match the settings in the printer driver. For more information, see [Change print settings](#).

Check the device location and length of USB cable

High electromagnetic fields (such as those generated by USB cables) can sometimes cause slight distortions to printouts. Move the device away from the source of the electromagnetic fields. Also, it is recommended that you use a USB cable that is less than 3 meters (9.8 feet) long to minimize the effects of these electromagnetic fields.

If the above solutions do not work, the problem may be caused by the inability of the application to interpret print settings properly. See the release notes for known software conflicts, refer to the application's documentation, or contact the software manufacturer for specific help.

The device prints half a page, then ejects the paper

Check the ink cartridges

Make sure the correct ink cartridges are installed and the ink cartridges are not low on ink. For more information, see [Manage the device](#) and [Work with ink cartridges](#). HP cannot guarantee the quality of non-HP ink cartridges.

Poor print quality and unexpected printouts

This section contains the following topics:

- [Common poor quality printout problems](#)
- [Meaningless characters print](#)
- [Ink is smearing](#)
- [Ink is not filling the text or graphics completely](#)
- [Output is faded or dull colored](#)
- [Colors are printing as black and white](#)
- [Wrong colors are printing](#)
- [Printout shows bleeding colors](#)
- [Colors do not line up properly](#)
- [Lines or dots are missing from text or graphics](#)

Common poor quality printout problems

Check the ink cartridges

Make sure the correct ink cartridges are installed and the ink cartridges are not low on ink. For more information, see [Manage the device](#) and [Work with ink cartridges](#). HP cannot guarantee the quality of non-HP ink cartridges.

Check the paper quality

The paper might be too moist or too rough. Make sure the media meets HP specifications, and try to print again. For more information, see [Understand specifications for supported media](#).

Check the type of media loaded in the device

Make sure the tray supports the type of media you have loaded. For more information, see [Understand specifications for supported media](#).

Check the device location and length of USB cable

High electromagnetic fields (such as those generated by USB cables) can sometimes cause slight distortions to printouts. Move the device away from the source of the electromagnetic fields. Also, it is recommended that you use a USB cable that is less than 3 meters (9.8 feet) long to minimize the effects of these electromagnetic fields.

Align the ink cartridges

Align the ink cartridges. For more information, see [Align the ink cartridges](#).

Clean the ink cartridge

The ink cartridges may need to be cleaned. For more information, see, [Clean the ink cartridges](#).

Meaningless characters print

If an interruption occurs to a job that is printing, the device might not recognize the rest of the job.

Cancel the print job and wait for the device to return to the ready state. If the device does not return to the ready state, cancel all jobs and wait again. When the device is ready, resend the job. If prompted by the computer to retry the job, click **Cancel**.

Check the cable connections

If the device and computer are connected with a USB cable, the problem may be due to a poor cable connection.

Make sure the cable connections at both ends are secure. If the problem persists, turn off the device, disconnect the cable from the device, turn on the device without connecting the cable, and delete any remaining jobs from the print spooler. When the Power light is on and not flashing, reconnect the cable.

Check the document file

The document file may be damaged. If you can print other documents from the same application, try printing a backup copy of your document, if available.

Align the ink cartridges

Align the ink cartridges. For more information, see [Align the ink cartridges](#).

Ink is smearing

Check the print settings

- When you print documents that use much ink, allow more time to dry before handling the printouts. This is especially true for transparencies. In the printer driver, select the **Best** print quality, and also increase the ink drying time and reduce the ink saturation using the ink volume under the advanced features (Windows) or ink features (Mac OS). However, note that decreasing ink saturation might give printouts a "washed-out" quality.
- Color documents that have rich, blended colors can wrinkle or smear when printed using the **Best** print quality. Try using another print mode, such as **Normal**, to reduce ink, or use HP Premium Paper designed for printing vivid color documents. For more information, see [Change print settings](#).

Check the media type

Some types of media do not accept ink well. For these types of media, ink will dry more slowly and smearing may occur. For more information, see [Understand specifications for supported media](#).

Check the ink cartridges

Make sure the correct ink cartridges are installed and the ink cartridges are not low on ink. For more information, see [Manage the device](#) and [Work with ink cartridges](#). HP cannot guarantee the quality of non-HP ink cartridges.

Clean the ink cartridge

The ink cartridges may need to be cleaned. For more information, see, [Clean the ink cartridges](#).

Ink is not filling the text or graphics completely

Check the media type

Some media types are not suitable for use with the device. For more information, see [Understand specifications for supported media](#).

Check the ink cartridges

Make sure the ink cartridges are not low on ink. For more information, see [Manage the device](#) and [Work with ink cartridges](#). HP cannot guarantee the quality of non-HP ink cartridges.

Clean the ink cartridge

The ink cartridges may need to be cleaned. For more information, see, [Clean the ink cartridges](#).

Output is faded or dull colored

Check the print mode

The **Draft** or **Fast** mode in the printer driver allows you to print at a faster rate, which is good for printing drafts. To get better results, select **Normal** or **Best**. For more information, see [Change print settings](#).

Check the paper type setting

When printing on transparencies or other special media, select the corresponding media type in the print driver. For more information, see [Print on special and custom-sized media](#).

Clean the ink cartridge

The ink cartridges may need to be cleaned. For more information, see, [Clean the ink cartridges](#).

Check the ink cartridges

Make sure the correct ink cartridges are installed and the ink cartridges are not low on ink. For more information, see [Manage the device](#) and [Work with ink cartridges](#). HP cannot guarantee the quality of non-HP ink cartridges.

Colors are printing as black and white

Check the print settings

Make sure **Print in Grayscale** is not selected in the printer driver. For information on changing this setting, see [Change print settings](#).

Wrong colors are printing

Check the print settings

Make sure **Print in Grayscale** is not selected in the printer driver. For information on changing this setting, see [Change print settings](#).

Check the ink cartridges

Make sure the correct ink cartridges are installed and the ink cartridges are not low on ink. For more information, see [Manage the device](#) and [Work with ink cartridges](#). HP cannot guarantee the quality of non-HP ink cartridges.

Clean the ink cartridge

The ink cartridges may need to be cleaned. For more information, see, [Clean the ink cartridges](#).

Printout shows bleeding colors

Check the ink cartridges

Make sure the correct ink cartridges are installed and the ink cartridges are not low on ink. For more information, see [Manage the device](#) and [Work with ink cartridges](#). HP cannot guarantee the quality of non-HP ink cartridges.

Check the print settings

Make sure **Print in Grayscale** is not selected in the printer driver. For information on changing this setting, see [Change print settings](#).

Check the media type

Some types of media do not accept ink well. For these types of media, ink will dry more slowly and smearing may occur. For more information, see [Understand specifications for supported media](#).

Colors do not line up properly

Check the ink cartridges

Make sure the correct ink cartridges are installed and the ink cartridges are not low on ink. For more information, see [Manage the device](#) and [Work with ink cartridges](#). HP cannot guarantee the quality of non-HP ink cartridges.

Check the graphics placement

Use the zoom or print preview feature of your software to check for gaps in the placement of graphics on the page.

Align the ink cartridges

Align the ink cartridges. For more information, see [Align the ink cartridges](#).

Lines or dots are missing from text or graphics

Check the ink cartridges

Make sure the ink cartridges are not low on ink. For more information, see [Work with ink cartridges](#). HP cannot guarantee the quality of non-HP ink cartridges.

Solve paper-feed problems

Media is not supported for the printer or tray

Use only media that is supported for the device and the tray being used. For more information, see [Understand specifications for supported media](#).

Media is not picked up from a tray

- Make sure media is loaded in the tray. For more information, see [Load media](#). Fan the media before loading.
- Make sure the paper guides are set to the correct markings in the tray for the media size you are loading. Also make sure the guides are snug, but not tight, against the stack.
- Make sure media in the tray is not curled. Uncurl paper by bending it in the opposite direction of the curl.
- When using thin special media, make sure that the tray is completely loaded. If you are using special media that is only available in small quantities, try placing the special media on top of other paper of the same size to help fill the tray. (Some media is picked up more easily if the tray is full.)
- If you are using thick special media (such as brochure paper), load media so that the tray is between 1/4 and 3/4 full. If necessary, place the media on top of other paper of the same size so that the stack height is within this range.

Media is not coming out correctly

- Make sure the output tray extension is extended; otherwise, printed pages may fall off the device.

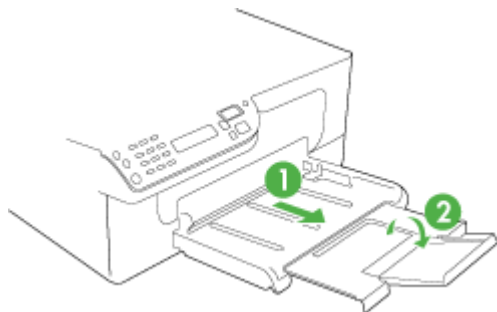

- Remove excess media from the output tray. There is a limit to the number of sheets the tray can hold.

Pages are skewing

- Make sure the media loaded in the trays is aligned to the paper guides. If needed, pull out the trays from the device and reload the media properly, making sure that the paper guides are properly aligned.
- Load media into the device only when it is not printing.

Multiple pages are being picked up

- Fan the media before loading.
- Make sure the paper guides are set to the correct markings in the tray for the media size you are loading. Also make sure the guides are snug, but not tight, against the stack.
- Make sure the tray is not overloaded with paper.

- When using thin special media, make sure that the tray is completely loaded. If you are using special media that is only available in small quantities, try placing the special media on top of other paper of the same size to help fill the tray. (Some media is picked up more easily if the tray is full.)
- If you are using thick special media (such as brochure paper), load media so that the tray is between 1/4 and 3/4 full. If necessary, place the media on top of other paper of the same size so that the stack height is within this range.
- Use HP media for optimum performance and efficiency.

Solve scan problems

If the following topics do not help, see [Support and warranty](#) for information about HP support.



NOTE: If you are starting the scan from a computer, see the software Help for troubleshooting information.

- [Scanner did nothing](#)
- [Scan takes too long](#)
- [Part of the document did not scan or text is missing](#)
- [Text cannot be edited](#)
- [Error messages appear](#)
- [Scanned image quality is poor](#)
- [Scan defects are apparent](#)

Scanner did nothing

- **Check the original**

Make sure that the original is placed on the scanner glass correctly. For more information, see [Load an original on the scanner glass](#).

- **Check the device**

The device might be coming out of PowerSave mode after a period of inactivity, which delays processing a short while. Wait until the device reaches the **READY** state.

- **Check the software**

Make sure the software is properly installed.

Scan takes too long

- **Check the settings**

- If you set the resolution too high, the scan job takes longer and results in larger files. To obtain good results when scanning or copying, do not use a resolution that is higher than needed. You can lower the resolution to scan more quickly.
- If you acquire an image through TWAIN, you can change the settings so that the original scans in black and white. See the onscreen Help for the TWAIN program for information.

- **Check the status of the device**

If you sent a print or copy job before you tried to scan, the scan starts if the scanner is not busy. However, the printing and scanning processes share memory, which means that the scan might be slower.

Part of the document did not scan or text is missing

- **Check the original**

- Make sure that you loaded the original correctly. For more information, see [Load originals](#).
- Colored backgrounds can cause images in the foreground to blend into the background. Try adjusting the settings before you scan the original, or try enhancing the image after you scan the original.

- **Check the settings**

- Make sure that the input media size is large enough for the original that you are scanning.
- If you are using the HP photo and imaging software, the default settings in the HP photo and imaging software might be set to automatically perform a specific task other than the one that you are attempting. See the onscreen Help for the HP photo and imaging software for instructions about changing the properties.

Text cannot be edited

- **Check the settings**

- Make sure that the OCR software is set to edit text.
- When you scan the original, make sure that you select a document type that creates editable text. If text is classified as a graphic, it is not converted to text.
- Your OCR program might be linked to a word-processing program that does not perform OCR tasks. See the product software Help for more information about linking programs.

- **Check the originals**

- Make sure that you placed the original correctly on the scanner glass. For more information, see [Load originals](#).
- The OCR program might not recognize text that is tightly spaced. For example, if the text that the OCR program converts has missing or combined characters, "rn" might appear as "m."

- The accuracy of the OCR program depends on the image quality, text size, and structure of the original and the quality of the scan itself. Make sure that your original has good image quality.
- Colored backgrounds can cause images in the foreground to blend too much. Try adjusting the settings before you scan the original, or try enhancing the image after you scan the original. If you are performing an OCR operation on an original, any colored text on the original does not scan well, if at all.

Error messages appear

"Unable to activate TWAIN source" or "An error occurred while acquiring the image"

- If you are acquiring an image from another device, such as a digital camera or another scanner, make sure that the other device is TWAIN-compliant. Devices that are not TWAIN-compliant do not work with the device software.
- Make sure that you have connected the USB Device Cable to the correct port on the back of your computer.
- Verify that the correct TWAIN source is selected. In the software, check the TWAIN source by selecting **Select Scanner** on the **File** menu.

Scanned image quality is poor

The original is a second-generation photo or picture

Reprinted photographs, such as those in newspapers or magazines, are printed by using tiny dots of ink that make an interpretation of the original photograph, which degrades the quality. Often, the ink dots form unwanted patterns that can be detected when the image is scanned or printed or when the image appears on a screen. If the following suggestions do not solve the problem, you might need to use a better-quality version of the original.

- To eliminate the patterns, try reducing the size of the image after scanning.
- Print the scanned image to see if the quality is better.
- Make sure that the resolution and color settings are correct for the type of scan job.

Text or images on the back of a two-sided original appear in the scan

Two-sided originals can "bleed" text or images from the back side to the scan if the originals are printed on media that is too thin or too transparent.

The scanned image is skewed (crooked)

The original might have been placed incorrectly. Be sure to use the media guides when you place the original on the scanner glass. For more information, see [Load originals](#).

The image quality is better when printed

The image that appears on the screen is not always an accurate representation of the quality of the scan.

- Try adjusting your computer monitor settings to use more colors (or levels of gray). On Windows computers, you typically make this adjustment by opening **Display** on the Windows control panel.
- Try adjusting the resolution and color settings.

The scanned image shows blots, lines, vertical white stripes, or other defects

- If the scanner glass is dirty, the image produced does not have optimum clarity. See [Clean the device](#) for cleaning instructions.
- The defects might be on the original and not a result of the scanning process.

Graphics look different from the original

The graphics settings might not be suitable for the type of scan job that you are performing. Try changing the graphics settings.

Take steps to improve the scan quality

- Use high-quality originals.
- Place the media correctly. If the media is placed incorrectly on the scanner glass, it might skew, which causes unclear images. For more information, see [Load originals](#).
- Adjust the software settings according to how you plan to use the scanned page.
- Use or make a carrier sheet to protect your originals.
- Clean the scanner glass. See [Clean the scanner glass](#) for more information.

Scan defects are apparent

• **Blank pages**

Make sure that the original document is placed correctly. Place the original document face down on the flatbed scanner with the top-left corner of the document located in the lower-right corner of the scanner glass.

• **Too light or dark**

- Try adjusting the settings. Be sure to use the correct resolution and color settings.
- The original image might be very light or dark or might be printed on colored paper.

• **Unwanted lines**

Ink, glue, correction fluid, or an unwanted substance might be on the scanner glass. Try cleaning the scanner glass. See [Clean the device](#) for more information.

• **Black dots or streaks**

- Ink, glue, correction fluid, or an unwanted substance might be on the scanner glass, the scanner glass might be dirty or scratched, or the lid backing might be dirty. Try cleaning the scanner glass and lid backing. See [Clean the device](#) for more information. If cleaning does not correct the problem, the scanner glass or lid backing might need to be replaced.
- The defects might be on the original and not a result of the scanning process.

• **Unclear text**

Try adjusting the settings. Make sure that the resolution and color settings are correct.

• **Size is reduced**

The HP software settings might be set to reduce the scanned image. See the product software Help for more information about changing the settings.

Solve copy problems

If the following topics do not help, see [Support and warranty](#) for information about HP support.

- [No copy came out](#)
- [Copies are blank](#)
- [Documents are missing or faded](#)
- [Size is reduced](#)
- [Copy quality is poor](#)
- [Copy defects are apparent](#)
- [The device prints half a page, then ejects the paper](#)
- [Error messages appear](#)
- [Paper mismatch](#)

No copy came out

- **Check the power**
Make sure that the power cord is securely connected, and the device turned on.
- **Check the status of the device**
 - The device might be busy with another job. Check the control-panel display for information about the status of jobs. Wait for any job that is processing to finish.
 - The device might be jammed. Check for jams. See [Clear paper jams](#).
- **Check the trays**
Make sure that media is loaded. See [Load media](#) for more information.
- **Check the computer**
To make a copy, the HP All-in-One must be connected to a computer, the computer must be turned on and you must be logged on, and the software must be installed and running. Also, the **HP Digital Imaging Monitor** in the Windows Taskbar must be installed and turned on at all times.
On a Macintosh computer, once the software is installed, it is always available when you turn on the computer.

Copies are blank

- **Check the media**
The media might not meet Hewlett-Packard media specifications (for example, the media is too moist or too rough). See [Understand specifications for supported media](#) for more information.
- **Check the trays**
If you are copying from the ADF, make sure that the originals have been loaded correctly. For more information, see [Load an original in the automatic document feeder \(ADF\)](#).
- **Check the computer**
To make a copy, the HP All-in-One must be connected to a computer, the computer must be turned on and you must be logged on, and the software must be

installed and running. Also, the **HP Digital Imaging Monitor** in the Windows Taskbar must be installed and turned on at all times.

On a Macintosh computer, once the software is installed, it is always available when you turn on the computer.

Documents are missing or faded

- **Check the media**

The media might not meet Hewlett-Packard media specifications (for example, the media is too moist or too rough). See [Understand specifications for supported media](#) for more information.

- **Check the settings**

The quality setting of **Fast** (which produces draft-quality copies) might be responsible for the missing or faded documents. From the copy software on your computer, open the printer driver and change to the **Normal** or **Best** setting.

- **Check the original**

- The accuracy of the copy depends on the quality and size of the original. If the original is too light, the copy might not be able to compensate, even if you adjust the contrast.
- Colored backgrounds might cause images in the foreground to blend into the background, or the background might appear in a different shade.

Size is reduced

The HP photo and imaging software settings might be set to reduce the scanned image. Change the settings, if needed. See the onscreen Help for the HP photo and imaging software for more information.

Copy quality is poor

- **Take steps to improve the copy quality**

- Use quality originals.
- Load the media correctly. If the media is loaded incorrectly, it might skew, causing unclear images. See [Understand specifications for supported media](#) for more information.
- Use or make a carrier sheet to protect your originals.

- **Check the device**

- The scanner lid might not be closed properly.
- The scanner glass or lid backing might need cleaning. See [Clean the device](#) for more information.
- The ADF might need cleaning. See [Clean the device](#) for more information.

Copy defects are apparent

- **Vertical white or faded stripes**

The media might not meet Hewlett-Packard media specifications (for example, the media is too moist or too rough). See [Understand specifications for supported media](#) for more information.
- **Unwanted lines**

The scanner glass, lid backing, or frame might need cleaning. See [Clean the device](#) for more information.
- **Black dots or streaks**

Ink, glue, correction fluid, or an unwanted substance might be on the scanner glass or lid backing. Try cleaning the device. See [Clean the device](#) for more information.
- Copy is slanted or skewed
 - Make sure that the ADF input tray is not too full.
 - Make sure that the ADF width adjusters are snug against the sides of the media.
- **Unclear text**
 - Try adjusting the contrast and copy-quality settings.
 - The default enhancement setting might not be suitable for the job. Check the setting and change it to enhance text or photographs, if needed.
- **Large, black typefaces look splotchy (not smooth)**

The default enhancement setting might not be suitable for the job. Check the setting and change it to enhance text or photographs, if needed.
- **Horizontal grainy or white bands in light-gray to medium-gray areas**

The default enhancement setting might not be suitable for the job. Check the setting and change it to enhance text or photographs, if needed.

The device prints half a page, then ejects the paper

Check the ink cartridges

Make sure the correct ink cartridges are installed and the ink cartridges are not low on ink. For more information, see [Manage the device](#) and [Work with ink cartridges](#). HP cannot guarantee the quality of non-HP ink cartridges.

Error messages appear

“Reload document and then reload job”

Press the **OK** button, and then reload the remaining documents (up to 20 pages) in the ADF. For more information see [Load originals](#).

Paper mismatch

Check the settings

From the copy software on your computer, open the printer driver and verify that the media size and type settings match the media loaded in the device.

Solve fax problems

This section contains fax setup troubleshooting information for the device. If the device is not set up properly for faxing, you might experience problems when sending faxes, receiving faxes, or both.

If you are having faxing problems, you can print a fax test report to check the status of the device. The test will fail if the device is not set up properly for faxing. Perform this test after you have completed setting up the device for faxing. For more information, see [Test fax setup](#).

If the test fails, review the report for information on how to fix any problems found. For more information, see [The fax test failed](#).

- [The fax test failed](#)
- [The display always shows Phone Off Hook](#)
- [The device is having problems sending and receiving faxes](#)
- [The device is having problems sending a manual fax](#)
- [The device cannot receive faxes, but can send faxes](#)
- [The device cannot send faxes, but can receive faxes](#)
- [Fax tones are recorded on my answering machine](#)
- [The phone cord that came with my device is not long enough](#)
- [Color faxes do not print](#)
- [The computer cannot receive faxes \(Fax to PC\)](#)

The fax test failed

If you ran a fax test and the test failed, review the report for basic information about the error. For more detailed information, check the report to see which part of the test failed, and then review the appropriate topic in this section for solutions to try.

This section contains the following topics:

- [The "Fax Hardware Test" failed](#)
- [The "Fax Connected to Active Telephone Wall Jack" test failed](#)
- [The "Phone Cord Connected to Correct Port on Fax" test failed](#)
- [The "Using Correct Type of Phone Cord with Fax" test failed](#)
- [The "Dial Tone Detection" test failed](#)
- [The "Fax Line Condition" test failed](#)

The "Fax Hardware Test" failed

Solution:

- Turn off the device by using the **Power** button located on the device control panel and then unplug the power cord from the back of the device. After a few seconds, plug the power cord in again, and then turn the power on. Run the test again. If the test fails again, continue reviewing the troubleshooting information in this section.
- Try to send or receive a test fax. If you can send or receive a fax successfully, there might not be a problem.
- If you are running the test from the **Fax Setup Wizard** (Windows) or **HP Fax Setup Utility** (Mac OS), make sure the device is not busy completing another task, such as receiving a fax or making a copy. Check the display for a message indicating that the device is busy. If it is busy, wait until it is finished and in the idle state before running the test.
- Make sure you use the phone cord that came with the device. If you do not use the supplied phone cord to connect from the telephone wall jack to the device, you might not be able to send or receive faxes. After you plug in the phone cord that came with the device, run the fax test again.
- If you are using a phone splitter, this can cause faxing problems. (A splitter is a two-cord connector that plugs into a telephone wall jack.) Try removing the splitter and connecting the device directly to the telephone wall jack.

After you resolve any problems found, run the fax test again to make sure it passes and the device is ready for faxing. If the **Fax Hardware Test** continues to fail and you experience problems faxing, contact HP Support. Go to www.hp.com/support. If prompted, choose your country/region, and then click **Contact HP** for information on calling for technical support.

The "Fax Connected to Active Telephone Wall Jack" test failed

Solution:

- Check the connection between the telephone wall jack and the device to make sure the phone cord is secure.
- Make sure you use the phone cord that came with the device. If you do not use the supplied phone cord to connect from the telephone wall jack to the device, you might not be able to send or receive faxes. After you plug in the phone cord that came with the device, run the fax test again.
- Make sure you have correctly connected the device to the telephone wall jack. Using the phone cord supplied in the box with the device, connect one end to your telephone wall jack, then connect the other end to the port labeled 1-LINE on the back of the device. For more information on setting up the device for faxing, see [Set up faxing for the device](#).
- If you are using a phone splitter, this can cause faxing problems. (A splitter is a two-cord connector that plugs into a telephone wall jack.) Try removing the splitter and connecting the device directly to the telephone wall jack.

- Try connecting a working phone and phone cord to the telephone wall jack that you are using for the device and check for a dial tone. If you do not hear a dial tone, contact your telephone company and have them check the line.
- Try to send or receive a test fax. If you can send or receive a fax successfully, there might not be a problem.

After you resolve any problems found, run the fax test again to make sure it passes and the device is ready for faxing.

The "Phone Cord Connected to Correct Port on Fax" test failed

Solution: Plug the phone cord into the correct port.

1. Using the phone cord supplied in the box with the device, connect one end to your telephone wall jack, then connect the other end to the port labeled 1-LINE on the back of the device.

 **NOTE:** If you use the 2-EXT port to connect to the telephone wall jack, you will not be able to send or receive faxes. The 2-EXT port should only be used to connect other equipment, such as an answering machine.

Figure 8-1 Back view of the device



1	Telephone wall jack
2	Use the phone cord supplied in the box with the device to connect to the "1-LINE" port

2. After you have connected the phone cord to the port labeled 1-LINE, run the fax test again to make sure it passes and the device is ready for faxing.
3. Try to send or receive a test fax.
 - Make sure you use the phone cord that came with the device. If you do not use the supplied phone cord to connect from the telephone wall jack to the device, you might not be able to send or receive faxes. After you plug in the phone cord that came with the device, run the fax test again.
 - If you are using a phone splitter, this can cause faxing problems. (A splitter is a two-cord connector that plugs into a telephone wall jack.) Try removing the splitter and connecting the device directly to the telephone wall jack.

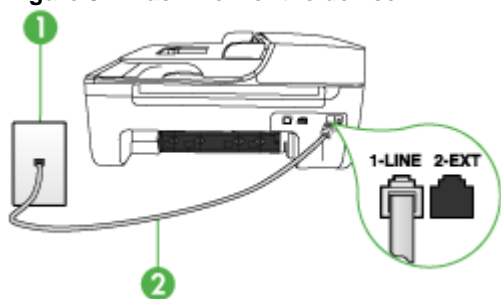
The "Using Correct Type of Phone Cord with Fax" test failed

Solution:

- Make sure you used the phone cord supplied in the box with the device to connect to the telephone wall jack. One end of the phone cord should be connected to the port labeled 1-LINE on the back of the device, and the other end to your telephone wall jack, as shown below.

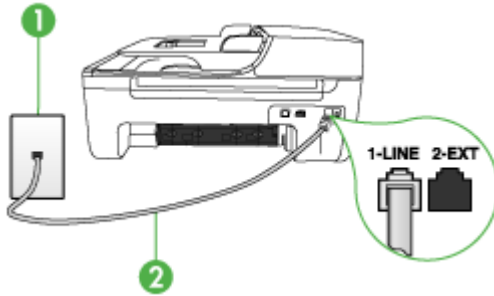

1	Telephone wall jack
2	Use the phone cord supplied in the box with the device to connect to the "1-LINE" port

If the phone cord that came with the device is not long enough, you can use a coupler to extend the length. You can purchase a coupler at an electronics store that carries phone accessories. You will also need another phone cord, which can be a standard phone cord that you might already have in your home or office.

- Check the connection between the telephone wall jack and the device to make sure the phone cord is secure.
- Make sure you use the phone cord that came with the device. If you do not use the supplied phone cord to connect from the telephone wall jack to the device, you might not be able to send or receive faxes. After you plug in the phone cord that came with the device, run the fax test again.
- If you are using a phone splitter, this can cause faxing problems. (A splitter is a two-cord connector that plugs into a telephone wall jack.) Try removing the splitter and connecting the device directly to the telephone wall jack.

The "Dial Tone Detection" test failed

Solution:

- Other equipment, which uses the same phone line as the device, might be causing the test to fail. To find out if other equipment is causing a problem, disconnect everything from the phone line, and then run the test again. If the **Dial Tone Detection Test** passes without the other equipment, then one or more pieces of the equipment is causing problems; try adding them back one at a time and rerunning the test each time, until you identify which piece of equipment is causing the problem.
- Try connecting a working phone and phone cord to the telephone wall jack that you are using for the device and check for a dial tone. If you do not hear a dial tone, contact your telephone company and have them check the line.
- Make sure you have correctly connected the device to the telephone wall jack. Using the phone cord supplied in the box with the device, connect one end to your telephone wall jack, then connect the other end to the port labeled 1-LINE on the back of the device.
- If you are using a phone splitter, this can cause faxing problems. (A splitter is a two-cord connector that plugs into a telephone wall jack.) Try removing the splitter and connecting the device directly to the telephone wall jack.
- If your telephone system is not using a standard dial tone, such as some PBX systems, this might cause the test to fail. This will not cause a problem sending or receiving faxes. Try sending or receiving a test fax.
- Check to make sure the country/region setting is set appropriately for your country/region. If the country/region setting is not set or is set incorrectly, the test might fail and you might have problems sending and receiving faxes.
- Make sure you connect the device to an analog phone line or you will not be able to send or receive faxes. To check if your phone line is digital, connect a regular analog phone to the line and listen for a dial tone. If you do not hear a normal sounding dial tone, it might be a phone line set up for digital phones. Connect the device to an analog phone line and try sending or receiving a fax.
- Make sure you use the phone cord that came with the device. If you do not use the supplied phone cord to connect from the telephone wall jack to the device, you might not be able to send or receive faxes. After you plug in the phone cord that came with the device, run the fax test again.

After you resolve any problems found, run the fax test again to make sure it passes and the device is ready for faxing. If the **Dial Tone Detection test** continues to fail, contact your telephone company and have them check the phone line.

The "Fax Line Condition" test failed

Solution:

- Make sure you connect the device to an analog phone line or you will not be able to send or receive faxes. To check if your phone line is digital, connect a regular analog phone to the line and listen for a dial tone. If you do not hear a normal sounding dial tone, it might be a phone line set up for digital phones. Connect the device to an analog phone line and try sending or receiving a fax.
- Check the connection between the telephone wall jack and the device to make sure the phone cord is secure.
- Make sure you have correctly connected the device to the telephone wall jack. Using the phone cord supplied in the box with the device, connect one end to your telephone wall jack, then connect the other end to the port labeled 1-LINE on the back of the device.
- Other equipment, which uses the same phone line as the device, might be causing the test to fail. To find out if other equipment is causing a problem, disconnect everything from the phone line, and then run the test again.
 - If the **Fax Line Condition Test** passes without the other equipment, then one or more pieces of the equipment is causing problems; try adding them back one at a time and rerunning the test each time, until you identify which piece of equipment is causing the problem.
 - If the **Fax Line Condition Test** fails without the other equipment, connect the device to a working phone line and continue reviewing the troubleshooting information in this section.
- If you are using a phone splitter, this can cause faxing problems. (A splitter is a two-cord connector that plugs into a telephone wall jack.) Try removing the splitter and connecting the device directly to the telephone wall jack.
- Make sure you use the phone cord that came with the device. If you do not use the supplied phone cord to connect from the telephone wall jack to the device, you might not be able to send or receive faxes. After you plug in the phone cord that came with the device, run the fax test again.

After you resolve any problems found, run the fax test again to make sure it passes and the device is ready for faxing. If the **Fax Line Condition** test continues to fail and you experience problems faxing, contact your telephone company and have them check the phone line.

The display always shows Phone Off Hook

Solution: You are using the wrong type of phone cord. Make sure you are using the phone cord that came with the device to connect the device to your phone line. If the phone cord that came with the device is not long enough, you can use a coupler to extend the length. You can purchase a coupler at an electronics store that carries phone accessories. You will also need another phone cord, which can be a standard phone cord that you might already have in your home or office.

Solution: Other equipment that uses the same phone line as the device might be in use. Make sure extension phones (phones on the same phone line, but not

connected to the device) or other equipment are not in use or off the hook. For example, you cannot use the device for faxing if an extension phone is off the hook, or if you are using a computer dial-up modem to send e-mail or access the Internet.

The device is having problems sending and receiving faxes

Solution: Make sure the device is turned on. Look at the display on the device. If the display is blank and the **Power** light is not lit, the device is turned off. Make sure the power cord is firmly connected to the device and plugged into a power outlet. Press the **Power** button to turn on the device.

After turning on the device, HP recommends you wait five minutes before sending or receiving a fax. The device cannot send or receive faxes while it is initializing after being turned on.

Solution: If Fax to PC has been enabled, you may not be able to send or receive faxes if the fax memory is full (limited by device memory).

Solution:

- Make sure you used the phone cord supplied in the box with the device to connect to the telephone wall jack. One end of the phone cord should be connected to the port labeled 1-LINE on the back of the device and the other end to your telephone wall jack, as shown below.

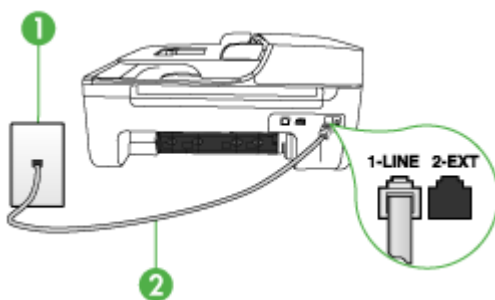

1	Telephone wall jack
2	Use the phone cord supplied in the box with the device to connect to the "1-LINE" port

If the phone cord that came with the device is not long enough, you can use a coupler to extend the length. You can purchase a coupler at an electronics store that carries phone accessories. You will also need another phone cord,

which can be a standard phone cord that you might already have in your home or office.

- Try connecting a working phone and phone cord to the telephone wall jack that you are using for the device and check for a dial tone. If you do not hear a dial tone, call your local telephone company for service.
- Other equipment, which uses the same phone line as the device, might be in use. For example, you cannot use the device for faxing if an extension phone is off the hook, or if you are using a computer dial-up modem to send an e-mail or access the Internet.
- Check to see if another process has caused an error. Check the display or your computer for an error message providing information about the problem and how to solve it. If there is an error, the device will not send or receive a fax until the error condition is resolved.
- The phone line connection might be noisy. Phone lines with poor sound quality (noise) can cause faxing problems. Check the sound quality of the phone line by plugging a phone into the telephone wall jack and listening for static or other noise. If you hear noise, turn **Error Correction Mode (ECM)** off and try faxing again. For information about changing ECM, see the onscreen Help. If the problem persists, contact your telephone company.
- If you are using a digital subscriber line (DSL) service, make sure that you have a DSL filter connected or you will not be able to fax successfully. For more information, see [Case B: Set up the device with DSL](#).
- Make sure the device is not connected to a telephone wall jack that is set up for digital phones. To check if your phone line is digital, connect a regular analog phone to the line and listen for a dial tone. If you do not hear a normal sounding dial tone, it might be a phone line set up for digital phones.
- If you are using either a private branch exchange (PBX) or an integrated services digital network (ISDN) converter/terminal adapter, make sure the device is connected to the correct port and the terminal adapter is set to the correct switch type for your country/region, if possible. For more information, see [Case C: Set up the device with a PBX phone system or an ISDN line](#).
- If the device shares the same phone line with a DSL service, the DSL modem might not be properly grounded. If the DSL modem is not properly grounded, it can create noise on the phone line. Phone lines with poor sound quality (noise) can cause faxing problems. You can check the sound quality of the phone line by plugging a phone into the telephone wall jack and listening for static or other noise. If you hear noise, turn off your DSL modem and completely remove power for at least 15 minutes. Turn the DSL modem back on and listen to the dial tone again.



NOTE: You might notice static on the phone line again in the future. If the device stops sending and receiving faxes, repeat this process.

If the phone line is still noisy, contact your telephone company. For information on turning your DSL modem off, contact your DSL provider for support.

- If you are using a phone splitter, this can cause faxing problems. (A splitter is a two-cord connector that plugs into a telephone wall jack.) Try removing the splitter and connecting the device directly to the telephone wall jack.

The device is having problems sending a manual fax

Solution:

 **NOTE:** This possible solution applies only in the countries/regions that receive a 2-wire phone cord in the box with the device, including: Argentina, Australia, Brazil, Canada, Chile, China, Colombia, Greece, India, Indonesia, Ireland, Japan, Korea, Latin America, Malaysia, Mexico, Philippines, Poland, Portugal, Russia, Saudi Arabia, Singapore, Spain, Taiwan, Thailand, USA, Venezuela, and Vietnam.

- Make sure the telephone you use to initiate the fax call is connected directly to the device. To send a fax manually, the telephone must be connected directly to the port labeled 2-EXT on the device, as shown below.

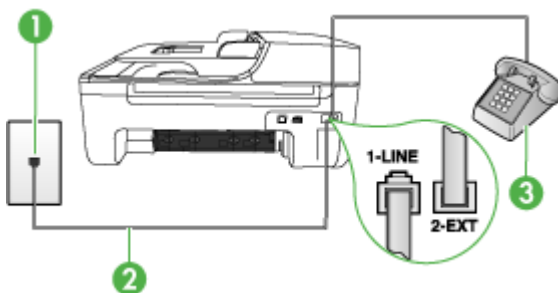

1	Telephone wall jack
2	Use the phone cord supplied in the box with the device to connect to the "1-LINE" port
3	Telephone

- If you are sending a fax manually from your phone that is connected directly to the device, you must use the keypad on the telephone to send the fax. You cannot use the keypad on the device control panel of the device.

 **NOTE:** If using a serial-type phone system, please connect your phone directly on top of the device cable which has a wall plug attached to it.

The device cannot receive faxes, but can send faxes

Solution:

- If you are not using a distinctive ring service, check to make sure that the **Distinctive Ring** feature on the device is set to **All Rings**. For more information, see [Change the answer ring pattern for distinctive ring](#).
- If **Auto Answer** is set to **Off**, you will need to receive faxes manually; otherwise, the device will not receive the fax. For information on receiving faxes manually, see [Receive a fax manually](#).

- If you have a voice mail service at the same phone number you use for fax calls, you must receive faxes manually, not automatically. This means that you must be available to respond in person to incoming fax calls. For information on setting up the device when you have a voice mail service, see [Case F: Shared voice/fax line with voice mail](#). For information on receiving faxes manually, see [Receive a fax manually](#).
- If you have a computer dial-up modem on the same phone line with the device, check to make sure that the software that came with your modem is not set to receive faxes automatically. Modems that are set up to receive faxes automatically take over the phone line to receive all incoming faxes, which prevents the device from receiving fax calls.
- If you have an answering machine on the same phone line with the device, you might have one of the following problems:
 - Your answering machine might not be set up properly with the device.
 - Your outgoing message might be too long or too loud to allow the device to detect fax tones, and the sending fax machine might disconnect.
 - Your answering machine might not have enough quiet time after your outgoing message to allow the device to detect fax tones. This problem is most common with digital answering machines.

The following actions might help solve these problems:

- When you have an answering machine on the same phone line you use for fax calls, try connecting the answering machine directly to the device as described in [Case I: Shared voice/fax line with answering machine](#).
- Make sure the device is set to receive faxes automatically. For information on setting up the device to receive faxes automatically, see [Receive a fax](#).
- Make sure the **Rings to Answer** setting is set to a greater number of rings than the answering machine. For more information, see [Set the number of rings before answering](#).
- Disconnect the answering machine and then try receiving a fax. If faxing is successful without the answering machine, the answering machine might be causing the problem.
- Reconnect the answering machine and record your outgoing message again. Record a message that is approximately 10 seconds in duration. Speak slowly and at a low volume when recording your message. Leave at least 5 seconds of silence at the end of the voice message. There should be no background noise when recording this silent time. Try to receive a fax again.

 **NOTE:** Some digital answering machines might not retain the recorded silence at the end of your outgoing message. Play back your outgoing message to check.

- If the device shares the same phone line with other types of phone equipment, such as an answering machine, a computer dial-up modem, or a multi-port switch box, the fax signal level might be reduced. The signal level can also be reduced if you use a splitter or connect extra cables to extend the length of your phone. A reduced fax signal can cause problems during fax reception. To find out if other equipment is causing a problem, disconnect everything except the device from the phone line, and then try to receive a fax. If you can receive faxes successfully without the other equipment, one or more pieces of the other equipment is causing problems; try adding them back one at a time and receiving a fax each time, until you identify which equipment is causing the problem.
 - If you have a special ring pattern for your fax phone number (using a distinctive ring service through your telephone company), make sure that the **Distinctive Ring** feature on the device is set to match. For more information, see [Change the answer ring pattern for distinctive ring](#).
-

The device cannot send faxes, but can receive faxes

Solution:

- The device might be dialing too fast or too soon. You might need to insert some pauses in the number sequence. For example, if you need to access an outside line before dialing the phone number, insert a pause following the access number. If your number is 95555555, and 9 accesses an outside line, you might insert pauses as follows: 9-555-5555. To enter a pause in the fax number you are typing, press **Redial/Pause**, or press the **Space (#)** button repeatedly, until a dash (-) appears on the display.
You can also send the fax using monitor dialing. This enables you to listen to the phone line as you dial. You can set the pace of your dialing and respond to prompts as you dial. For more information, see [Send a fax using monitor dialing](#).
 - The number you entered when sending the fax is not in the proper format or the receiving fax machine is having problems. To check this, try calling the fax number from a telephone and listen for fax tones. If you cannot hear fax tones, the receiving fax machine might not be turned on or connected, or a voice mail service could be interfering with the recipient's phone line. You can also ask the recipient to check the receiving fax machine for any problems.
-

Fax tones are recorded on my answering machine

Solution:

- When you have an answering machine on the same phone line you use for fax calls, try connecting the answering machine directly to the device as described in [Case I: Shared voice/fax line with answering machine](#). If you do not connect the answering machine as recommended, fax tones might be recorded on your answering machine.
 - Make sure the device is set to receive faxes automatically and that the **Rings to Answer** setting is correct. The number of rings to answer for the device should be greater than the number of rings to answer for the answering machine. If the answering machine and the device are set to the same number of rings to answer, both devices answer the call and fax tones are recorded on the answering machine.
 - Set your answering machine to a low number of rings and the device to answer in the maximum number of rings supported. (The maximum number of rings varies by country/region.) In this setup, the answering machine answers the call and the device monitors the line. If the device detects fax tones, the device receives the fax. If the call is a voice call, the answering machine records the incoming message. For more information, see [Set the number of rings before answering](#).
-

The phone cord that came with my device is not long enough

Solution: If the phone cord that came with the device is not long enough, you can use a coupler to extend the length. You can purchase a coupler at an electronics store that carries phone accessories. You will also need another phone cord, which can be a standard phone cord that you might already have in your home or office.

 **TIP:** If the device came with a 2-wire phone cord adaptor, you can use it with a 4-wire phone cord to extend the length. For information on using the 2-wire phone cord adaptor, see the documentation that came with it.

To extend your phone cord

1. Using the phone cord supplied in the box with the device, connect one end to the coupler, then connect the other end to the port labeled 1-LINE on the back of the device.
 2. Connect another phone cord to the open port on the coupler and to the telephone wall jack.
-

Color faxes do not print

Cause: The Incoming Fax Printing option is turned off.

Solution: To print color faxes, make sure that the Incoming Fax Printing option in the device control panel is turned on.

The computer cannot receive faxes (Fax to PC)

Cause: the **HP Digital Imaging Monitor** is turned off.

Solution: Check the taskbar and ensure that the **HP Digital Imaging Monitor** is turned on at all times.

Cause: The computer selected to receive faxes is turned off.

Solution: Make sure the computer selected to receive faxes is switched on at all times.

Cause: Different computers are configured for setup and receiving faxes and one of them may be switched off.

Solution: If the computer receiving faxes is different from the one used for setup, both computers should be switched on at all times.

Cause: Fax to PC is not activated or the computer is not configured to receive faxes.

Solution: Activate Fax to PC and make sure the computer is configured to receive faxes.



Cause: HP Digital Imaging Monitor is not operating properly.

Solution: Restart the **HP Digital Imaging Monitor** or restart the computer.

Solve wireless problems (HP Officejet J4680 only)

If the device is unable to communicate with the network after completing the wireless setup and software installation, perform one or more of the following tasks.

Print wireless configuration settings

- Press **Setup**.
- Press the right arrow  until **Print Report** appears, and then press **OK**.
- Press the right arrow  until **Wireless Configuration** appears, and then press **OK**.

Check the wireless communication settings

- Make sure the computer's wireless card is set to the correct wireless profile. A wireless profile is a set of network settings unique to a given network. A single wireless card might have several wireless profiles (for example, one for a home network and one for an office network). Open the Configuration utility for the network card installed on your computer, and ensure that the profile selected is the profile for the device's network.
- Make sure the device's network settings match those of your network. Do one of the following to find the settings for your network:
 - **Infrastructure communication:** Open the wireless access point's (WAP) Configuration utility.
 - **Ad hoc communication:** Open the Configuration utility for the network card installed in your computer.
- Compare the network's settings to those on the device's wireless configuration page, and note any differences. For more information, see [Print wireless configuration settings](#). Possible problems include the following:
 - The WAP filters hardware addresses (MAC addresses).
 - One of these settings in the device might be incorrect: communication mode, network name (SSID), channel (ad hoc networks only), authentication type, encryption.
 - Print a document. If the document still does not print, then reset the device's network settings and reinstall the device software.

If the wireless network settings are correct, the computer might be associated with another wireless network. Ensure that the computer is associated with the same wireless network as that of the device.

Users can ensure this by checking the wireless settings on their respective computers. In addition, ensure that the computers have access to the wireless network.

If the wireless network settings are incorrect, follow these steps to correct the device's settings:

1. Connect the device to your network with a network cable or to the computer using the network cable.
2. Open the device's embedded Web server.
3. Click the **Networking** tab, and then click **Wireless (802.11)** in the left pane.
4. Use the Wireless Setup wizard on the Wireless Setup tab to change the device's settings to match the settings of the network.
5. Close the device's embedded Web server, and then disconnect the network cable from the device.
6. Uninstall the device software completely, and then reinstall the software.

Add hardware addresses to a wireless access point (WAP)

MAC filtering is a security feature in which a wireless access point (WAP) is configured with a list of MAC addresses (also called "hardware addresses") of devices that are allowed to gain access to the network through the WAP. If the WAP does not have the hardware address of a device attempting to access the network, the WAP denies the

device access to the network. If the WAP filters MAC addresses, then the device's MAC address must be added to the WAP's list of accepted MAC addresses.

- Print the wireless configuration page. For more information, see [Print wireless configuration settings](#).
- Open the WAP's configuration utility, and add the device's hardware address to the list of accepted MAC addresses.

Reset network configuration settings

If the device is still unable to communicate with the network, reset the device's network settings.

- Press **Setup**. Press an arrow button to move to **Network**, and then press **OK**.
- Press an arrow button to move to **Restore Network Defaults**, and then press **OK**.
- Print the wireless configuration page and verify that the network settings have been reset. For more information, see [Print wireless configuration settings](#).
By default, the network name (SSID) is "hpsetup" and the communication mode is "ad hoc."

Troubleshoot installation issues

If the following topics do not help, see [Support and warranty](#) for information about HP support.

- [Hardware installation suggestions](#)
- [Software installation suggestions](#)

Hardware installation suggestions

Check the device

- Make sure that all packing tape and material have been removed from outside and inside the device.
- Make sure that the device is loaded with paper.
- Make sure that no lights are on or blinking except the Ready light, which should be on. If the Attention light is blinking, check for messages on the device control panel.

Check the hardware connections

- Make sure that any cords and cables that you are using are in good working order.
- Make sure that the power cord is connected securely to both the device and to a working power outlet.
- Make sure that the phone cord is connected to the 1-LINE port.

Check the ink cartridges

- Whenever you install a new ink cartridge, the device aligns the ink cartridges automatically. If the alignment fails, check to make sure the cartridges are installed correctly, and start the ink cartridge alignment. For more information, see [Align the ink cartridges](#).
- Make sure that all latches and covers are closed properly.

Check the computer system

- Make sure that your computer is running one of the supported operating systems.
- Make sure that the computer meets at least the minimum system requirements.

Check the device to ensure the following

- Power light is on and not blinking. When the device is first turned on, it takes approximately 45 seconds to warm up.
- The device is in the Ready state, and no other lights on the device control panel are lit or blinking. If lights are lit or blinking, see the message on the device control panel.
- Ensure power cord and other cables are working, and are firmly connected to the device.
- All packing tapes and materials are removed from the device.
- Duplexer is locked into place.
- Paper is loaded correctly in the tray, and is not jammed in the device.
- All latches and covers are closed.

Software installation suggestions

Verify installation preliminaries

- Make sure to use the Starter CD that contains the correct installation software for your operating system.
- Before installing software, make sure that all other programs are closed.
- If the computer does not recognize the path to the CD-ROM drive that you type, make sure that you are specifying the correct drive letter.
- If the computer cannot recognize the Starter CD in the CD-ROM drive, inspect the Starter CD for damage. You can download the device driver from the HP Web site (www.hp.com/support).

Check or perform the following

- Make sure the computer meets the system requirements.
- Before installing software on a Windows computer, ensure all other programs are closed.
- If the computer does not recognize the path to the CD drive that you typed, ensure you are specifying the correct drive letter.
- If the computer cannot recognize the Starter CD in the CD drive, inspect the CD for damage. You can download the device driver from the HP Web site (www.hp.com/support).
- In the Windows device manager, make sure that the USB drivers have not been disabled.
- If you are using a computer running Windows, and the computer cannot detect the device, run the uninstallation utility (util\ccc\uninstall.bat on the Starter CD) to perform a clean uninstallation of the device driver. Restart your computer, and reinstall the device driver.

Check the computer system

- Make sure that your computer is running one of the supported operating systems.
- Make sure that the computer meets at least the minimum system requirements.

Clear jams

Occasionally, media becomes jammed during a job. Try the following remedies before you attempt to clear the jam.

- Make sure that you are printing with media that meets specifications. For more information, see [Understand specifications for supported media](#).
- Make sure that you are printing with media that is not wrinkled, folded, or damaged.
- Make sure that the device is clean. For more information, see [Clean the device](#).
- Make sure that the trays are loaded correctly and are not too full. For more information, see [Load media](#).

This section contains the following topics:

- [Clear paper jams](#)
- [Avoid paper jams](#)

Clear paper jams

If the paper was loaded in the main tray, you might need to clear the paper jam from the rear door.

Paper can also jam in the automatic document feeder. Several common actions can cause paper to jam the automatic document feeder:

- Placing too much paper in the document feeder tray. For information on the maximum number of sheets allowed in the automatic document feeder, see [Load originals](#).
- Using paper that is too thick or too thin for the device.
- Trying to add paper to the document feeder tray while the device is feeding pages.

To clear a paper jam from the rear door

1. Press in the tab on the left side of the rear door to release the door. Remove the door by pulling it away from the device.

△ **CAUTION:** Trying to clear a paper jam from the front of the device can damage the print mechanism. Always access and clear paper jams through the rear door.

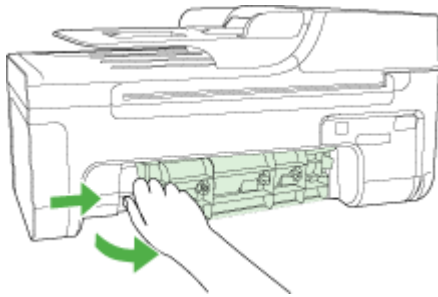

2. Gently pull the paper out of the rollers.

△ **CAUTION:** If the paper tears when you are removing it from the rollers, check the rollers and wheels for torn pieces of paper that might be remaining inside the device. If you do not remove all the pieces of paper from the device, more paper jams are likely to occur.

3. Replace the rear door. Gently push the door forward until it snaps into place.
4. Press **OK** to continue the current job.

To clear a paper jam in the automatic document feeder

1. Lift the cover of the automatic document feeder.



2. Gently pull the paper out of the rollers.

△ **CAUTION:** If the paper tears when you are removing it from the rollers, check the rollers and wheels for torn pieces of paper that might be remaining inside the device. If you do not remove all the pieces of paper from the device, more paper jams are likely to occur.

3. Close the cover of the automatic document feeder.

Avoid paper jams

To help avoid paper jams, follow these guidelines.

- Remove printed papers from the output tray frequently.
- Prevent curled or wrinkled paper by storing all unused paper flat in a resealable bag.
- Ensure that paper loaded in the input tray lays flat and the edges are not bent or torn.
- Do not combine different paper types and paper sizes in the input tray; the entire stack of paper in the input tray must be the same size and type.
- Adjust the paper-width guide in the input tray to fit snugly against all paper. Make sure the paper-width guide does not bend the paper in the input tray.
- Do not force paper too far forward in the input tray.
- Use paper types that are recommended for the device. For more information, see [Understand specifications for supported media](#).
- Do not leave originals on the glass. If you load an original in the automatic document feeder while there is already an original on the glass, the original can jam in the automatic document feeder.

A HP supplies and accessories

This section provides information on HP supplies and accessories for the device. The information is subject to changes, visit the HP Web site (www.hpshopping.com) for the latest updates. You may also make purchases through the Web site.

- [Order printing supplies online](#)
- [Supplies](#)

Order printing supplies online

Besides the HP Web site, you may order printing supplies using the following tools:

- **Toolbox (Windows):** On the **Estimated Ink Level** tab, click **Shop Online**.
- **HP Printer Utility (Mac OS):** Click **Supplies Status** from the **Information and Support** panel, click the **Shop for HP Supplies** drop-down menu, and then choose **Online**.

Supplies

- [HP media](#)

HP media

To order media such as HP Premium Plus Photo Paper or HP Premium Paper, go to www.hp.com. Choose your country/region, and then select **Buy** or **Shopping**.

B Support and warranty

The information in [Maintain and troubleshoot](#) suggests solutions to common problems. If your device is not operating correctly and those suggestions did not solve your problem, try using one of the following support services to obtain assistance.

This section contains the following topics:

- [Hewlett-Packard limited warranty statement](#)
- [Obtain electronic support](#)
- [Obtain HP telephone support](#)
- [Prepare the device for shipment](#)
- [Pack the device](#)

Hewlett-Packard limited warranty statement

HP product	Duration of limited warranty
Software Media	90 days
Printer	1 year
Print or Ink cartridges	Until the HP ink is depleted or the "end of warranty" date printed on the cartridge has been reached, whichever occurs first. This warranty does not cover HP ink products that have been refilled, remanufactured, refurbished, misused, or tampered with.
Accessories	1 year unless otherwise stated

A. Extent of limited warranty

- Hewlett-Packard (HP) warrants to the end-user customer that the HP products specified above will be free from defects in materials and workmanship for the duration specified above, which duration begins on the date of purchase by the customer.
- For software products, HP's limited warranty applies only to a failure to execute programming instructions. HP does not warrant that the operation of any product will be interrupted or error free.
- HP's limited warranty covers only those defects that arise as a result of normal use of the product, and does not cover any other problems, including those that arise as a result of:
 - Improper maintenance or modification;
 - Software, media, parts, or supplies not provided or supported by HP;
 - Operation outside the product's specifications;
 - Unauthorized modification or misuse.
- For HP printer products, the use of a non-HP cartridge or a refilled cartridge does not affect either the warranty to the customer or any HP support contract with the customer. However, if printer failure or damage is attributable to the use of a non-HP or refilled cartridge or an expired ink cartridge, HP will charge its standard time and materials charges to service the printer for the particular failure or damage.
- If HP receives, during the applicable warranty period, notice of a defect in any product which is covered by HP's warranty, HP shall either repair or replace the product, at HP's option.
- If HP is unable to repair or replace, as applicable, a defective product which is covered by HP's warranty, HP shall, within a reasonable time after being notified of the defect, refund the purchase price for the product.
- HP shall have no obligation to repair, replace, or refund until the customer returns the defective product to HP.
- Any replacement product may be either new or like-new, provided that it has functionality at least equal to that of the product being replaced.
- HP products may contain remanufactured parts, components, or materials equivalent to new in performance.
- HP's Limited Warranty Statement is valid in any country where the covered HP product is distributed by HP. Contracts for additional warranty services, such as on-site service, may be available from any authorized HP service facility in countries where the product is distributed by HP or by an authorized importer.

B. Limitations of warranty

TO THE EXTENT ALLOWED BY LOCAL LAW, NEITHER HP NOR ITS THIRD PARTY SUPPLIERS MAKES ANY OTHER WARRANTY OR CONDITION OF ANY KIND, WHETHER EXPRESS OR IMPLIED WARRANTIES OR CONDITIONS OF MERCHANTABILITY, SATISFACTORY QUALITY, AND FITNESS FOR A PARTICULAR PURPOSE.

C. Limitations of liability

- To the extent allowed by local law, the remedies provided in this Warranty Statement are the customer's sole and exclusive remedies.
- TO THE EXTENT ALLOWED BY LOCAL LAW, EXCEPT FOR THE OBLIGATIONS SPECIFICALLY SET FORTH IN THIS WARRANTY STATEMENT, IN NO EVENT SHALL HP OR ITS THIRD PARTY SUPPLIERS BE LIABLE FOR DIRECT, INDIRECT, SPECIAL, INCIDENTAL, OR CONSEQUENTIAL DAMAGES, WHETHER BASED ON CONTRACT, TORT, OR ANY OTHER LEGAL THEORY AND WHETHER ADVISED OF THE POSSIBILITY OF SUCH DAMAGES.

D. Local law

- This Warranty Statement gives the customer specific legal rights. The customer may also have other rights which vary from state to state in the United States, from province to province in Canada, and from country to country elsewhere in the world.
- To the extent that this Warranty Statement is inconsistent with local law, this Warranty Statement shall be deemed modified to be consistent with such local law. Under such local law, certain disclaimers and limitations of this Warranty Statement may not apply to the customer. For example, some states in the United States, as well as some governments outside the United States (including provinces in Canada), may:
 - Preclude the disclaimers and limitations in this Warranty Statement from limiting the statutory rights of a consumer (e.g., the United Kingdom);
 - Otherwise restrict the ability of a manufacturer to enforce such disclaimers or limitations; or
 - Grant the customer additional warranty rights, specify the duration of implied warranties which the manufacturer cannot disclaim, or allow limitations on the duration of implied warranties.
- THE TERMS IN THIS WARRANTY STATEMENT, EXCEPT TO THE EXTENT LAWFULLY PERMITTED, DO NOT EXCLUDE, RESTRICT, OR MODIFY, AND ARE IN ADDITION TO, THE MANDATORY STATUTORY RIGHTS APPLICABLE TO THE SALE OF THE HP PRODUCTS TO SUCH CUSTOMERS.

HP Limited Warranty

Dear Customer,

You will find below the name and address of the HP entity responsible for the performance of the HP Limited Warranty in your country.

You may have additional statutory rights against the seller based on your purchase agreement. Those rights are not in any way affected by this HP Limited Warranty.

Ireland: Hewlett-Packard Ireland Ltd, 30 Herbert Street IRL-Dublin 2

United Kingdom: Hewlett-Packard Ltd, Cain Road, Bracknell, GB-Berks RG12 1HN

Obtain electronic support

To find support and warranty information, go to the HP Web site at www.hp.com/support. If prompted, choose your country/region, and then click **Contact HP** for information on calling for technical support.

This Web site also offers technical support, drivers, supplies, ordering information and other options such as:

- Access online support pages.
- Send HP an e-mail message for answers to your questions.
- Connect with an HP technician by using online chat.
- Check for software updates.

You can also obtain support from the Toolbox (Windows) or HP Printer Utility (Mac OS), which provide easy, step-by-step solutions to common printing problems. For more information, see [Toolbox \(Windows\)](#) or [HP Printer Utility \(Mac OS\)](#).

Support options and availability vary by product, country/region, and language.

Obtain HP telephone support

During the warranty period, you may obtain assistance from the HP Customer Care Center.

This section contains the following topics:

- [Before you call](#)
- [Support process](#)
- [HP support by phone](#)
- [Additional warranty options](#)
- [HP Quick Exchange Service \(Japan\)](#)
- [Call HP Korea customer support](#)

Before you call

Visit the HP Web site (www.hp.com/support) for the latest troubleshooting information, or product fixes and updates.

To assist our Customer Care Center representatives to serve you better, prepare the following information if you need to call HP.

1. Print the self-test report of the device. For more information, see [Understand the self-test report](#). If the device does not print, get the following information ready:
 - Device model
 - Model number and serial number (check the back of the device)
2. Check the operating system that you are using, such as Windows XP.
3. Note how the device is connected to your system, such as through USB or network connection.
4. Obtain the version number of the printer software. (To find the version number of the printer driver, open the printer settings or properties dialog box, and click the **About** tab.)
5. If you have a problem printing from a particular application, note the application and version number.

Support process

If you have a problem, follow these steps

1. Check the documentation that came with the device.
2. Visit the HP online support Web site at www.hp.com/support. HP online support is available to all HP customers. It is the fastest source for up-to-date device information and expert assistance and includes the following features:
 - Fast access to qualified online support specialists
 - Software and driver updates for the HP All-in-One
 - Valuable troubleshooting information for common problems
 - Proactive device updates, support alerts, and HP newsgrams that are available when you register the HP All-in-One
3. Call HP support. Support options and availability vary by device, country/region, and language.

HP support by phone

This section contains the following topics:

- [Phone support period](#)
- [Telephone support numbers](#)
- [Placing a call](#)
- [After the phone support period](#)

Phone support period

One year of phone support is available in North America, Asia Pacific, and Latin America (including Mexico).

Telephone support numbers

In many locations, HP provides toll free telephone support during the warranty period. However, some of the support numbers might not be toll free.

For the most current list of telephone support numbers, see www.hp.com/support.

Placing a call

Call HP support while you are in front of the computer and the HP All-in-One. Be prepared to provide the following information:

- Model number (located on the label on the front of the device)
- Serial number (located on the back or bottom of the device)
- Messages that appear when the situation occurs
- Answers to these questions:
 - Has this situation happened before?
 - Can you re-create it?
 - Did you add any new hardware or software to your computer at about the time that this situation began?
 - Did anything else occur prior to this situation (such as a thunderstorm, HP All-in-One was moved, etc.)?

After the phone support period

After the phone support period, help is available from HP at an additional cost. Help may also be available at the HP online support Web site: www.hp.com/support. Contact your HP dealer or call the support phone number for your country/region to learn more about support options.

Additional warranty options

Extended service plans are available for the HP All-in-One at additional costs. Go to www.hp.com/support, select your country/region and language, then explore the services and warranty area for information about the extended service plans.

HP Quick Exchange Service (Japan)

インク カートリッジに問題がある場合は以下に記載されている電話番号に連絡してください。インク カートリッジが故障している、または欠陥があると判断された場合、HP Quick Exchange Service がこのインク カートリッジを正常品と交換し、故障したインク カートリッジを回収します。保障期間中は、修理代と送料は無料です。また、お住まいの地域にもよりますが、プリンタを次の日までに交換することも可能です。

電話番号： 0570-000511 (自動応答)
03-3335-9800 (自動応答システムが使用できない場合)

サポート時間： 平日の午前 9:00 から午後 5:00 まで
土日の午前 10:00 から午後 5:00 まで
祝祭日および 1 月 1 日から 3 日は除きます。

サービスの条件:

- サポートの提供は、カスタマケアセンターを通してのみ行われます。
- カスタマケアセンターがプリンタの不具合と判断した場合に、サービスを受けることができます。

ご注意：ユーザの扱いが不適切であったために故障した場合は、保障期間中であっても修理は有料となります。詳細については保証書を参照してください。

その他の制限:

- 運搬の時間はお住まいの地域によって異なります。詳しくは、カスタマケアセンターに連絡してご確認ください。
- 出荷配送は、当社指定の配送業者が行います。
- 配送は交通事情などの諸事情によって、遅れる場合があります。
- このサービスは、将来予告なしに変更することがあります。

For instructions on how to pack your device for exchange, see [Pack the device](#).

Call HP Korea customer support

HP 한국 고객 지원 문의

- 고객 지원 센터 대표 전화
1588-3003
- 제품가격 및 구입처 정보 문의 전화
080-703-0700
- 전화 상담 가능 시간:
평 일 09:00~18:00
토요일 09:00~13:00
(일요일, 공휴일 제외)

Prepare the device for shipment

If after contacting HP Customer Support or returning to the point of purchase, you are requested to send the device in for service, make sure you remove and keep the following items before returning your device:

- The ink cartridges
- The power cord, USB cable, and any other cable connected to the device
- Any paper loaded in the main tray
- Remove any originals you might have loaded in the device

This section contains the following topics:

- [Remove the ink cartridges before shipment](#)

Remove the ink cartridges before shipment

Before you return the device, make sure you remove the ink cartridges.



NOTE: This information does not apply to customers in Japan.

To remove ink cartridges before shipment

1. Turn on the device and wait until the print carriage is idle and silent. If the device will not turn on, skip this step and go to step 2.



NOTE: If the device does not turn on, you can unplug the power cord and then manually slide the print carriage to the far right side to remove the ink cartridges.

2. Gently pull open the ink cartridge cover.

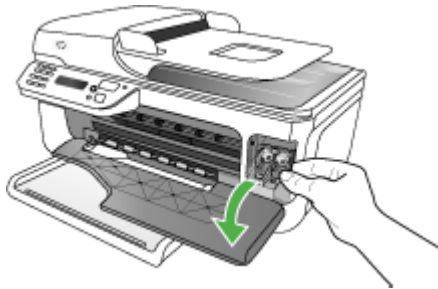

3. Remove the ink cartridges from their slots by grasping each between your thumb and forefinger and pulling it firmly toward you.

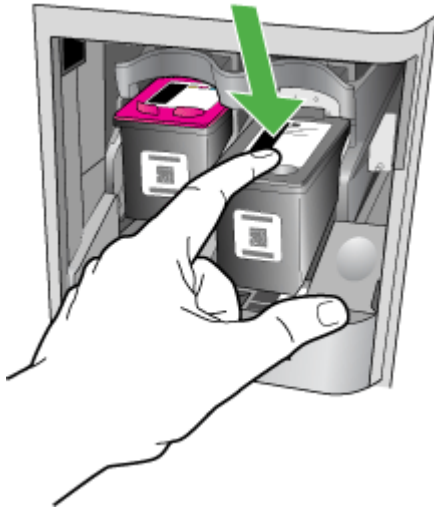

4. Place the ink cartridges in an airtight plastic container so they will not dry out, and put them aside. Do not send them with the device unless the HP customer support call agent instructs you to.
5. Close the front access door and wait a few minutes for the print carriage to move back to its home position (on the left side).
6. After the scanner is idle and has returned to its parked position, press the **Power** button to turn off the device.

Pack the device

Complete the following steps after you have prepared the device for shipment.

To pack the device

1. If available, pack the device for shipment by using the original packaging materials, or use the packaging materials that came with your replacement device.

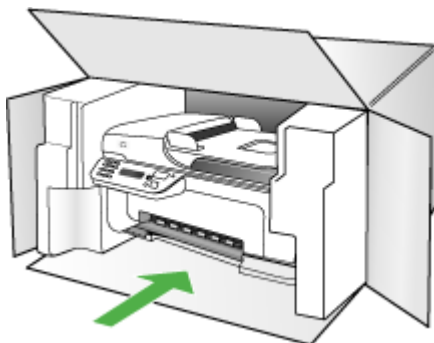

If you do not have the original packaging materials, please use other adequate packaging materials. Shipping damage caused by improper packaging and/or improper transportation is not covered under the warranty.

2. Place the return shipping label on the outside of the box.
3. Include the following items in the box:
 - A complete description of symptoms for service personnel (samples of print quality problems are helpful).
 - A copy of the sales slip or other proof of purchase to establish the warranty coverage period.
 - Your name, address, and a phone number where you can be reached during the day.

C Device specifications

For media and media-handling specifications, see [Understand specifications for supported media](#).

- [Physical specifications](#)
- [Product features and capacities](#)
- [Processor and memory specifications](#)
- [System requirements](#)
- [Network protocol specifications](#)
- [Embedded Web server specifications](#)
- [Print specifications](#)
- [Fax specifications](#)
- [Scan specifications](#)
- [Environmental specifications](#)
- [Electrical specifications](#)
- [Acoustic emission specifications \(print in Draft mode, noise levels per ISO 7779\)](#)

Physical specifications

Size (width x depth x height)

HP Officejet J4500, J4680: 433.5 x 401.5 x 216.7 mm (17.1 x 15.8 x 8.5 inches)

HP Officejet J4660 (with handset attached): 487.0 x 401.5 x 216.7 mm (19.2 x 15.8 x 8.5 inches)

Device weight (does not include printheads or ink cartridges)

HP Officejet J4500, J4680: 5.9 kg (13.0 lb)

HP Officejet J4660 (with handset attached): 6.1 kg (13.5 lb)

Product features and capacities

Feature	Capacity
Connectivity	<ul style="list-style-type: none">• USB 2.0-compliant high speed device• Wireless: 802.11b and 802.11g (HP Officejet J4680 only)
Ink cartridges	Black and tri-color ink cartridge
Supply yields	Visit www.hp.com/pageyield/ for more information on estimated ink cartridge yields.
Device languages	HP PCL 3 GUI
Duty cycle	Up to 3000 pages per month
Device control panel language support Language availability varies by country/region.	Bulgarian, Croatian, Czech, Danish, Dutch, English, Finnish, French, German, Greek, Hungarian, Italian, Japanese, Korean, Norwegian, Polish, Portuguese, Romanian, Russian, Simplified Chinese, Slovak, Slovenian, Spanish, Swedish, Traditional Chinese, Turkish.

Processor and memory specifications

Device processor

ARM9 180 MHz

Device memory

J4500, J4660: 16 MB RAM

J4680: 32 MB RAM

System requirements



NOTE: For the most current information about supported operating systems and system requirements, visit <http://www.hp.com/support/>

Operating system compatibility

- Windows 2000, Windows XP Home, Windows XP Professional, Windows XP Professional x64, Windows Vista, Windows Vista x64



NOTE: For Windows 2000, Windows XP Starter Edition, and Windows XP x64, only printer drivers, scanner drivers, and the Toolbox are available. Also, copying is not supported.

- Mac OS X (v10.3.9, v10.4.9, v10.5)
- Linux

Minimum requirements

- **Windows 2000 Service Pack 4:** Intel Pentium II or Celeron processor, 128 MB RAM, 200 MB free hard disk space
- **Windows XP (32-bit):** Intel Pentium II or Celeron processor, 512 MB RAM, 410 MB free hard disk space
- **Microsoft® Windows® x64:** AMD Athlon 64, AMD Opteron, Intel Xeon processor with Intel EM64T support, or Intel Pentium 4 processor with Intel EM64T support, 128 MB RAM, 200 MB free hard disk space, Microsoft Internet Explorer 6.0
- **Windows Vista:** 800 MHz 32-bit (x86) or 64-bit (x64) processor, 512 MB RAM, 765 MB free hard disk space
- **Mac OS X (v10.3.9, v10.4.9, v10.5):** PowerPC G3, G4, G5, or Intel Core Duo processor, 256 MB memory, 500 MB free hard disk space
- **Microsoft Internet Explorer 6.0 (Windows 2000, Windows XP); Internet Explorer 7.0 (Windows Vista)**
- **Quick Time 5.0 (Mac OS)**
- **Adobe Acrobat Reader 5 or later**

Recommended requirements

- **Windows 2000 Service Pack 4:** Intel Pentium III or higher processor, 256 MB RAM, 300 MB free hard disk space
- **Windows XP (32-bit):** Intel Pentium III or higher processor, 512 MB RAM, 450 MB free hard disk space
- **Microsoft® Windows® XP x64:** AMD Athlon 64, AMD Opteron, Intel Xeon processor with Intel EM64T support, or Intel Pentium 4 processor with Intel EM64T support, 256 MB RAM, 300 MB free hard disk space
- **Windows Vista:** 1 GHz 32-bit (x86) or 64-bit (x64) processor, 1 GB RAM, 800 MB free hard disk space
- **Mac OS X (v10.3.9, v10.4.9, v10.5):** PowerPC G3, G4, G5, or Intel Core Duo processor, 512 MB memory, 500 MB free hard disk space
- **Microsoft Internet Explorer 6.0 or later (Windows 2000, Windows XP); Internet Explorer 7.0 or later (Windows Vista)**
- **Quick Time 5.0 or later (Mac OS)**
- **Adobe Acrobat Reader 5 or later**

Network protocol specifications

Network operating system compatibility

- Windows 2000, Windows XP (32-bit), Windows XP x64 (Professional and Home Editions), Windows Vista (32-bit) & (64-bit) [Ultimate, Enterprise & Business Edition]
- Mac OS X (10.3, 10.4, 10.5)
- Microsoft Windows 2000 Server Terminal Services with Citrix Metaframe XP with Feature Release 3
- Microsoft Windows 2000 Server Terminal Services with Citrix Presentation Server 4.0
- Microsoft Windows 2000 Server Terminal Services
- Microsoft Windows 2003 Server Terminal Services
- Microsoft Windows 2003 Server Terminal Services with Citrix Presentation Server 4.0
- Microsoft Windows 2003 Server Terminal Services with Citrix Presentation Server 4.5
- Microsoft Windows 2003 Server Terminal Services with Citrix Metaframe XP with Feature Release 3

- Microsoft Windows 2003 Small Business Server Terminal Services
- Novell Netware 6, 6.5, Open Enterprise Server 6.5

Compatible network protocols

TCP/IP

Network management

Embedded Web server

Features

Ability to remotely configure and manage network devices

Embedded Web server specifications

Requirements

- A TCP/IP-based network (IPX/SPX-based networks are not supported)
- A Web browser (either Microsoft Internet Explorer 5.5 or higher, Opera 8.0 or higher, Mozilla Firefox 1.0 or higher, or Safari 1.2, or higher)
- A network connection (you cannot use the embedded Web server connected directly to a computer with a USB cable)
- An Internet connection (required for some features)



NOTE: You can open the embedded Web server without being connected to the Internet. However, some features will not be available.

- It must be on the same side of a firewall as the device.

Print specifications

Black print resolution

Up to 600 dpi rendered black (when printing from a computer)

Color print resolution

Up to 4800 x 1200 optimized dpi color on select HP photo papers with 1200 input dpi. Photo papers include the following:

- HP Premium Plus Photo
- HP Premium Photo
- HP Advanced Photo
- Photo Hagaki

Fax specifications

- Walk-up black-and-white and color fax capability.
- Up to 99 speed dials (varies by model).
- Up to 100-page memory (varies by model, based on ITU-T Test Image #1 at standard resolution). More complicated pages or higher resolution takes longer and uses more memory. Also, other product functions, such as copying, might affect the number of pages that can be stored in memory.
- Manual fax send and receive.
- Automatic busy redial up to five times (varies by model).
- Confirmation and activity reports.
- CCITT/ITU Group 3 fax with Error Correction Mode.
- 33.6 Kbps transmission.

- 3 seconds per page speed at 33.6 Kbps (based on ITU-T Test Image #1 at standard resolution). More complicated pages or higher resolution take longer and use more memory.
- Ring detect with automatic fax/answering machine switching.

	Photo (dpi)	Very Fine (dpi)	Fine (dpi)	Standard (dpi)
Black	196 x 203 (8-bit grayscale)	300 x 300	196 x 203	196 x 98
Color	300 x 300	200 x 200	200 x 200	200 x 200

Scan specifications

- Image editor included
- Integrated OCR software automatically converts scanned text to editable text
- Scan speeds vary according to the complexity of the document
- Twain-compliant interface
- Resolution: 1200 x 2400 dpi optical, up to 19200 dpi enhanced
- Color: 16-bit per RGB color, 48-bit total (from glass); 8-bit per RGB color, 24-bit total (from ADF)
- Maximum scan size from glass: 216 x 297 mm (8.5 x 11.7 inches)

Environmental specifications

Operating environment

Operating temperature: 5° to 40° C (41° to 104° F)

Recommended operating conditions: 15° to 32° C (59° to 90° F)

Recommended relative humidity: 20 to 80% noncondensing

Storage environment

Storage temperature: -40° to 60° C (-40° to 140° F)

Storage relative humidity: Up to 90% noncondensing at a temperature of 65° C (150° F)

Electrical specifications

Power supply

Universal power adapter (external)

Power requirements

Input voltage: 100 to 240 VAC ($\pm 10\%$), 50/60 Hz ($\pm 3\text{Hz}$)

Output voltage: 32 Vdc, LPS (600 mA min)

Power consumption

17 watts printing

Acoustic emission specifications (print in Draft mode, noise levels per ISO 7779)

Sound pressure (bystander position)

LpAd 56 (dBA)

Sound power

LwAd 7.0 (BA)

D Regulatory information

The device meets product requirements from regulatory agencies in your country/region.

This section contains the following topics:

- [FCC statement](#)
- [Notice to users in Korea](#)
- [VCCI \(Class B\) compliance statement for users in Japan](#)
- [Notice to users in Japan about the power cord](#)
- [RoHS notices \(China only\)](#)
- [Noise emission statement for Germany](#)
- [Notice to users of the U.S. telephone network: FCC requirements](#)
- [Notice to users of the Canadian telephone network](#)
- [Notice to users in the European Economic Area](#)
- [Notice to users of the German telephone network](#)
- [Australia wired fax statement](#)
- [Regulatory information for wireless products](#)
- [Warning for Australia and New Zealand with phone handset](#)
- [Regulatory model number](#)
- [Declaration of conformity](#)
- [Energy Star® notice](#)

FCC statement

FCC statement

The United States Federal Communications Commission (in 47 CFR 15.105) has specified that the following notice be brought to the attention of users of this product.

This equipment has been tested and found to comply with the limits for a Class B digital device, pursuant to Part 15 of the FCC Rules. These limits are designed to provide reasonable protection against harmful interference in a residential installation. This equipment generates, uses and can radiate radio frequency energy and, if not installed and used in accordance with the instructions, may cause harmful interference to radio communications. However, there is no guarantee that interference will not occur in a particular installation. If this equipment does cause harmful interference to radio or television reception, which can be determined by turning the equipment off and on, the user is encouraged to try to correct the interference by one or more of the following measures:

- Reorient the receiving antenna.
- Increase the separation between the equipment and the receiver.
- Connect the equipment into an outlet on a circuit different from that to which the receiver is connected.
- Consult the dealer or an experienced radio/TV technician for help.

For further information, contact:

Manager of Corporate Product Regulations
Hewlett-Packard Company
3000 Hanover Street
Palo Alto, Ca 94304
(650) 857-1501

Modifications (part 15.21)

The FCC requires the user to be notified that any changes or modifications made to this device that are not expressly approved by HP may void the user's authority to operate the equipment.

This device complies with Part 15 of the FCC Rules. Operation is subject to the following two conditions: (1) this device may not cause harmful interference, and (2) this device must accept any interference received, including interference that may cause undesired operation.

Notice to users in Korea

사용자 안내문(B급 기기)

이 기기는 비업무용으로 전자파 적합 등록을 받은 기기로서, 주거지역에서는 물론 모든 지역에서 사용할 수 있습니다.

VCCI (Class B) compliance statement for users in Japan

この装置は、情報処理装置等電波障害自主規制協議会（VCCI）の基準に基づくクラスB情報技術装置です。この装置は、家庭環境で使用することを目的としていますが、この装置がラジオやテレビジョン受信機に近接して使用されると受信障害を引き起こすことがあります。

取り扱い説明書に従って正しい取り扱いをして下さい。

Notice to users in Japan about the power cord

製品には、同梱された電源コードをお使い下さい。

同梱された電源コードは、他の製品では使用出来ません。

RoHS notices (China only)

Toxic and hazardous substance table

有毒有害物质表						
根据中国《电子信息产品污染控制管理办法》						
零件描述	有毒有害物质和元素					
	铅	汞	镉	六价铬	多溴联苯	多溴联苯醚
外壳和托盘*	0	0	0	0	0	0
电线*	0	0	0	0	0	0
印刷电路板*	X	0	0	0	0	0
打印系统*	X	0	0	0	0	0
显示器	X	0	0	0	0	0
喷墨打印机墨盒*	0	0	0	0	0	0
驱动光盘*	X	0	0	0	0	0
扫描仪*	X	X	0	0	0	0
网络配件*	X	0	0	0	0	0
电池板*	X	0	0	0	0	0
自动双面打印系统*	0	0	0	0	0	0
外部电源*	X	0	0	0	0	0

0: 指此部件的所有均一材质中包含的这种有毒有害物质，含量低于SJ/T11363-2006 的限制
X: 指此部件使用的均一材质中至少有一种包含的这种有毒有害物质，含量高于SJ/T11363-2006 的限制
注：环保使用期限的参考标识取决于产品正常工作的温度和湿度等条件
*以上只适用于使用这些部件的产品

Noise emission statement for Germany

Geräuschemission

LpA < 70 dB am Arbeitsplatz im Normalbetrieb nach DIN 45635 T. 19

Notice to users of the U.S. telephone network: FCC requirements

Notice to users of the U.S. telephone network: FCC requirements

This equipment complies with FCC rules, Part 68. On this equipment is a label that contains, among other information, the FCC Registration Number and Ringer Equivalent Number (REN) for this equipment. If requested, provide this information to your telephone company.

An FCC compliant telephone cord and modular plug is provided with this equipment. This equipment is designed to be connected to the telephone network or premises wiring using a compatible modular jack which is Part 68 compliant. This equipment connects to the telephone network through the following standard network interface jack: USOC RJ-11C.

The REN is useful to determine the quantity of devices you may connect to your telephone line and still have all of those devices ring when your number is called. Too many devices on one line might result in failure to ring in response to an incoming call. In most, but not all, areas the sum of the RENs of all devices should not exceed five (5). To be certain of the number of devices you may connect to your line, as determined by the REN, you should call your local telephone company to determine the maximum REN for your calling area.

If this equipment causes harm to the telephone network, your telephone company might discontinue your service temporarily. If possible, they will notify you in advance. If advance notice is not practical, you will be notified as soon as possible. You will also be advised of your right to file a complaint with the FCC. Your telephone company might make changes in its facilities, equipment, operations, or procedures that could affect the proper operation of your equipment. If they do, you will be given advance notice so you will have the opportunity to maintain uninterrupted service. If you experience trouble with this equipment, please contact the manufacturer, or look elsewhere in this manual, for warranty or repair information. Your telephone company might ask you to disconnect this equipment from the network until the problem has been corrected or until you are sure that the equipment is not malfunctioning.

This equipment may not be used on coin service provided by the telephone company.

Connection to party lines is subject to state tariffs. Contact your state public utility commission, public service commission, or corporation commission for more information.

This equipment includes automatic dialing capability. When programming and/or making test calls to emergency numbers:

- Remain on the line and explain to the dispatcher the reason for the call.
- Perform such activities in the off-peak hours, such as early morning or late evening.



Note The FCC hearing aid compatibility rules for telephones are not applicable to this equipment.

The Telephone Consumer Protection Act of 1991 makes it unlawful for any person to use a computer or other electronic device, including fax machines, to send any message unless such message clearly contains in a margin at the top or bottom of each transmitted page or on the first page of transmission, the date and time it is sent and an identification of the business, other entity, or other individual sending the message and the telephone number of the sending machine or such business, other entity, or individual. (The telephone number provided might not be a 900 number or any other number for which charges exceed local or long-distance transmission charges.) In order to program this information into your fax machine, you should complete the steps described in the software.

Notice to users of the Canadian telephone network

Note à l'attention des utilisateurs du réseau téléphonique canadien/Notice to users of the Canadian telephone network

Cet appareil est conforme aux spécifications techniques des équipements terminaux d'Industrie Canada. Le numéro d'enregistrement atteste de la conformité de l'appareil. L'abréviation IC qui précède le numéro d'enregistrement indique que l'enregistrement a été effectué dans le cadre d'une Déclaration de conformité stipulant que les spécifications techniques d'Industrie Canada ont été respectées. Néanmoins, cette abréviation ne signifie en aucun cas que l'appareil a été validé par Industrie Canada.

Pour leur propre sécurité, les utilisateurs doivent s'assurer que les prises électriques reliées à la terre de la source d'alimentation, des lignes téléphoniques et du circuit métallique d'alimentation en eau sont, le cas échéant, branchées les unes aux autres. Cette précaution est particulièrement importante dans les zones rurales.



Remarque Le numéro REN (Ringer Equivalence Number) attribué à chaque appareil terminal fournit une indication sur le nombre maximal de terminaux qui peuvent être connectés à une interface téléphonique. La terminaison d'une interface peut se composer de n'importe quelle combinaison d'appareils, à condition que le total des numéros REN ne dépasse pas 5.

Basé sur les résultats de tests FCC Partie 68, le numéro REN de ce produit est 0.0B.

This equipment meets the applicable Industry Canada Terminal Equipment Technical Specifications. This is confirmed by the registration number. The abbreviation IC before the registration number signifies that registration was performed based on a Declaration of Conformity indicating that Industry Canada technical specifications were met. It does not imply that Industry Canada approved the equipment.

Users should ensure for their own protection that the electrical ground connections of the power utility, telephone lines and internal metallic water pipe system, if present, are connected together. This precaution might be particularly important in rural areas.



Note The REN (Ringer Equivalence Number) assigned to each terminal device provides an indication of the maximum number of terminals allowed to be connected to a telephone interface. The termination on an interface might consist of any combination of devices subject only to the requirement that the sum of the Ringer Equivalence Numbers of all the devices does not exceed 5.

The REN for this product is 0.0B, based on FCC Part 68 test results.

Notice to users in the European Economic Area

Notice to users in the European Economic Area



This product is designed to be connected to the analog Switched Telecommunication Networks (PSTN) of the European Economic Area (EEA) countries/regions.

Network compatibility depends on customer selected settings, which must be reset to use the equipment on a telephone network in a country/region other than where the product was purchased. Contact the vendor or Hewlett-Packard Company if additional product support is necessary.

This equipment has been certified by the manufacturer in accordance with Directive 1999/5/EC (annex II) for Pan-European single-terminal connection to the public switched telephone network (PSTN). However, due to differences between the individual PSTNs provided in different countries, the approval does not, of itself, give an unconditional assurance of successful operation on every PSTN network termination point.

In the event of problems, you should contact your equipment supplier in the first instance.

This equipment is designed for DTMF tone dialing and loop disconnect dialing. In the unlikely event of problems with loop disconnect dialing, it is recommended to use this equipment only with the DTMF tone dial setting.

Notice to users of the German telephone network

Hinweis für Benutzer des deutschen Telefonnetzwerks

Dieses HP-Fax ist nur für den Anschluss eines analogen Public Switched Telephone Network (PSTN) gedacht. Schließen Sie den TAE N-Telefonstecker, der im Lieferumfang des HP All-in-One enthalten ist, an die Wandsteckdose (TAE 6) Code N an. Dieses HP-Fax kann als einzelnes Gerät und/oder in Verbindung (mit seriellen Anschluss) mit anderen zugelassenen Endgeräten verwendet werden.

Australia wired fax statement

In Australia, the HP device must be connected to Telecommunication Network through a line cord which meets the requirements of the Technical Standard AS/ACIF S008.

Regulatory information for wireless products

This section contains the following regulatory information pertaining to wireless products:

- [Exposure to radio frequency radiation](#)
- [Notice to users in Brazil](#)
- [Notice to users in Canada](#)
- [Notice to users in Taiwan](#)
- [European Union regulatory notice](#)

Exposure to radio frequency radiation

Exposure to radio frequency radiation



Caution The radiated output power of this device is far below the FCC radio frequency exposure limits. Nevertheless, the device shall be used in such a manner that the potential for human contact during normal operation is minimized. This product and any attached external antenna, if supported, shall be placed in such a manner to minimize the potential for human contact during normal operation. In order to avoid the possibility of exceeding the FCC radio frequency exposure limits, human proximity to the antenna shall not be less than 20 cm (8 inches) during normal operation.

Notice to users in Brazil

Aviso aos usuários no Brasil

Este equipamento opera em caráter secundário, isto é, não tem direito à proteção contra interferência prejudicial, mesmo de estações do mesmo tipo, e não pode causar interferência a sistemas operando em caráter primário. (Res.ANATEL 282/2001).

Notice to users in Canada

Notice to users in Canada/Note à l'attention des utilisateurs canadiens

For Indoor Use. This digital apparatus does not exceed the Class B limits for radio noise emissions from the digital apparatus set out in the Radio Interference Regulations of the Canadian Department of Communications. The internal wireless radio complies with RSS 210 and RSS GEN of Industry Canada.

Utiliser à l'intérieur. Le présent appareil numérique n'émet pas de bruit radioélectrique dépassant les limites applicables aux appareils numériques de la classe B prescrites dans le Règlement sur le brouillage radioélectrique édicté par le ministère des Communications du Canada. Le composant RF interne est conforme à la norme RSS-210 and RSS GEN d'Industrie Canada.

Notice to users in Taiwan

低功率電波輻射性電機管理辦法

第十二條

經型式認證合格之低功率射頻電機，非經許可，公司、商號或使用者均不得擅自變更頻率、加大功率或變更設計之特性及功能。

第十四條

低功率射頻電機之使用不得影響飛航安全及干擾合法通信；經發現有干擾現象時，應立即停用，並改善至無干擾時方得繼續使用。

前項合法通信，指依電信法規定作業之無線電通信。低功率射頻電機須忍受合法通信或工業、科學及醫藥用電波輻射性電機設備之干擾。

European Union regulatory notice

European Union Regulatory Notice

Products bearing the CE marking comply with the following EU Directives:

- Low Voltage Directive 2006/95/EC
- EMC Directive 2004/108/EC

CE compliance of this product is valid only if powered with the correct CE-marked AC adapter provided by HP.

If this product has telecommunications functionality, it also complies with the essential requirements of the following EU Directive:

- R&TTE Directive 1999/5/EC

Compliance with these directives implies conformity to harmonized European standards (European Norms) that are listed in the EU Declaration of Conformity issued by HP for this product or product family. This compliance is indicated by the following conformity marking placed on the product.



The wireless telecommunications functionality of this product may be used in the following EU and EFTA countries:

Austria, Belgium, Bulgaria, Cyprus, Czech Republic, Denmark, Estonia, Finland, France, Germany, Greece, Hungary, Iceland, Ireland, Italy, Latvia, Liechtenstein, Lithuania, Luxembourg, Malta, Netherlands, Norway, Poland, Portugal, Romania, Slovak Republic, Slovenia, Spain, Sweden, Switzerland and United Kingdom.

Products with 2.4-GHz wireless LAN devices

France

For 2.4 GHz Wireless LAN operation of this product certain restrictions apply: This product may be used indoor for the entire 2400-2483.5 MHz frequency band (channels 1-13). For outdoor use, only 2400-2454 MHz frequency band (channels 1-9) may be used. For the latest requirements, see <http://www.art-telecom.fr>.

Italy

License required for use. Verify with your dealer or directly with the General Direction for Frequency Planning and Management (Direzione Generale Pianificazione e Gestione Frequenze).

Warning for Australia and New Zealand with phone handset

Warning! This equipment will be inoperable when main power fails.

Warning! The handset ear cap used with this product may attract dangerous objects like pins, staples, or needles. Take care to avoid harm that might occur from the retention of dangerous objects on the ear piece of the handset.

Regulatory model number

For regulatory identification purposes, your product is assigned Regulatory Model Numbers. The Regulatory Model Numbers for your product are SDGOB-0831, SDGOB-0832, and SDGOB-0833. This regulatory number should not be confused with the marketing name (HP Officejet J4500/J4660/J4680 All-in-One series) or product number.

Declaration of conformity

- [J4500](#)
- [J4660](#)
- [J4680](#)

J4500

	DECLARATION OF CONFORMITY	
according to ISO/IEC 17050-1 and EN 17050-1		
Supplier's Name:	Hewlett-Packard Company	DoC#: SDGOB-0831-rel.1.0
Supplier's Address:	16399 West Bernardo Drive San Diego, CA 92127-1899, USA	
declares, that the product		
Product Name:	HP Officejet J4500 series	
Regulatory Model Number:¹⁾	SDGOB-0831	
Product Options:	All	
Power Adapter:	0957-2242	
conforms to the following Product Specifications and Regulations:		
SAFETY:	IEC 60950-1:2001 / EN60950-1:2001 EN 60825-1 1994+A1:2002+A2: 2001	
EMC:	CISPR 22:2005/ EN 55022: 2006 Class B EN 55024:1998 +A1:2001 + A2:2003 EN 61000-3-2: 2000 + A2: 2005 EN 61000-3-3:1995 +A1: 2001 FCC CFR 47, Part 15 Class B / ICES-003, Issue 4 Class B	
TELECOM:	TBR 21: 1998 ³⁾ FCC Rules and Regulations 47CFR Part 68 TIA-968-A-1 +A-2 +A-3+A-4 Telecommunications – Telephone Terminal Equipment CS-03, Part 1, Issue 9, Feb 2005	
Supplementary Information:		
<ol style="list-style-type: none"> 1. This product is assigned a Regulatory Model Number which stays with the regulatory aspects of the design. The Regulatory Model Number is the main product identifier in the regulatory documentation and test reports, this number should not be confused with the marketing name or the product numbers. 2. This product complies with the requirements of the Low Voltage Directive 2006/95/EC, the EMC Directive 2004/108/EC & the R&TTE Directive 1999/5/EC and carries the CE-marking accordingly. In addition, it complies with the WEEE Directive 2002/96/EC and RoHS Directive 2002/95/EC. 3. This product complies with TBR21:1998, except clause 4.7.1 (DC characteristics), which complies with ES 203 021-3, clause 4.7.1. 4. This Device complies with Part 15 of the FCC Rules. Operation is subject to the following two Conditions: (1) This device may not cause harmful interference, and (2) this device must accept any interference received, including interference that may cause undesired operation. 5. The product was tested in a typical configuration. 		
San Diego, CA, USA July, 2007		
Local contact for regulatory topics only: EMEA: Hewlett-Packard GmbH, HQ-TRE, Herrenberger Strasse 140, 71034 Boeblingen, Germany www.hp.com/go/certificates USA : Hewlett-Packard, 3000 Hanover St., Palo Alto 94304, U.S.A. 650-857-1501		



DECLARATION OF CONFORMITY

according to ISO/IEC 17050-1 and EN 17050-1

Supplier's Name: Hewlett-Packard Company **DoC#:** SDGOB-0832-rel.1.0
Supplier's Address: 16399 West Bernardo Drive
 San Diego, CA 92127-1899, USA

declares, that the product

Product Name: HP Officejet J4660 series
Regulatory Model Number:¹⁾ SDGOB-0832
Product Options: All
Power Adapter: 0957-2242

conforms to the following Product Specifications and Regulations:

SAFETY: IEC 60950-1:2001 / EN60950-1:2001
 EN 60825-1 1994+A1:2002+A2: 2001

EMC: CISPR 22:2005/ EN 55022: 2006 Class B
 EN 55024:1998 +A1:2001 + A2:2003
 EN 61000-3-2: 2000 + A2: 2005
 EN 61000-3-3:1995 +A1: 2001
 FCC CFR 47, Part 15 Class B / ICES-003, Issue 4 Class B

TELECOM: TBR 21: 1998³⁾
 TBR 38: 1998
 FCC Rules and Regulations 47CFR Part 68
 TIA-968-A-1 +A-2 +A-3+A-4 Telecommunications – Telephone Terminal Equipment
 CS-03, Part I, Issue 9, Feb 2005

Supplementary Information:

1. This product is assigned a Regulatory Model Number which stays with the regulatory aspects of the design. The Regulatory Model Number is the main product identifier in the regulatory documentation and test reports, this number should not be confused with the marketing name or the product numbers.
2. This product complies with the requirements of the Low Voltage Directive 2006/95/EC, the EMC Directive 2004/108/EC & the R&TTE Directive 1999/5/EC and carries the CE-marking accordingly. In addition, it complies with the WEEE Directive 2002/96/EC and RoHS Directive 2002/95/EC.
3. This product complies with TBR21:1998, except clause 4.7.1 (DC characteristics), which complies with ES 203 021-3, clause 4.7.1.
4. This Device complies with Part 15 of the FCC Rules. Operation is subject to the following two Conditions: (1) This device may not cause harmful interference, and (2) this device must accept any interference received, including interference that may cause undesired operation.
5. The product was tested in a typical configuration.

San Diego, CA, USA
July, 2007

Local contact for regulatory topics only:

EMEA: Hewlett-Packard GmbH, HQ-TRE, Herrenberger Strasse 140, 71034 Boeblingen, Germany www.hp.com/go/certificates
 USA : Hewlett-Packard, 3000 Hanover St., Palo Alto 94304, U.S.A. 650-857-1501

J4680

		DECLARATION OF CONFORMITY according to ISO/IEC 17050-1 and EN 17050-1
Supplier's Name:	Hewlett-Packard Company	DoC#: SDGOB-0833-rel.2.0
Supplier's Address:	16399 West Bernardo Drive San Diego, CA 92127-1899, USA	
declares, that the product		
Product Name:	HP Officejet J4680 series	
Regulatory Model Number:¹⁾	SDGOB-0833	
Product Options:	All	
Radio Module:	RSVLD-0608	
Power Adapter:	0957-2242	
conforms to the following Product Specifications and Regulations:		
SAFETY:	IEC 60950-1:2001 / EN60950-1:2001 EN 60825-1 1994+A1:2002+A2: 2001	
EMC:	CISPR 22:2005/ EN 55022: 2006 Class B EN 55024:1998 +A1:2001 + A2:2003 EN 61000-3-2: 2000 + A2: 2005 EN 61000-3-3:1995 +A1: 2001 FCC CFR 47, Part 15 Class B / ICES-003, Issue 4 Class B	
TELECOM:	EN 301 489-1 V1.4.1:2002 / EN 301 489-17 V1.2.1:2002 EN 300 328 V1.7.1:2006-05 TBR 21: 1998 ³⁾ FCC Rules and Regulations 47CFR Part 68 TIA-968-A-1 +A-2 +A-3+A-4 Telecommunications – Telephone Terminal Equipment CS-03, Part I, Issue 9, Feb 2005	
HEALTH:	EU: 1999/519/EC	
Supplementary Information:		
<ol style="list-style-type: none"> 1. This product is assigned a Regulatory Model Number which stays with the regulatory aspects of the design. The Regulatory Model Number is the main product identifier in the regulatory documentation and test reports, this number should not be confused with the marketing name or the product numbers. 2. This product complies with the requirements of the Low Voltage Directive 2006/95/EC, the EMC Directive 2004/108/EC & the R&TTE Directive 1999/5/EC and carries the CE-marking accordingly. In addition, it complies with the WEEE Directive 2002/96/EC and RoHS Directive 2002/95/EC. 3. This product complies with TBR21:1998, except clause 4.7.1 (DC characteristics), which complies with ES 203 021-3, clause 4.7.1. 4. This Device complies with Part 15 of the FCC Rules. Operation is subject to the following two Conditions: (1) This device may not cause harmful interference, and (2) this device must accept any interference received, including interference that may cause undesired operation. 5. The product was tested in a typical configuration. 		
San Diego, CA, USA		
October, 2007		
Local contact for regulatory topics only:		
EMEA: Hewlett-Packard GmbH, HQ-TRE, Herrenberger Strasse 140, 71034 Boeblingen, Germany www.hp.com/go/certificates		
USA : Hewlett-Packard, 3000 Hanover St., Palo Alto 94304, U.S.A. 650-857-1501		

Energy Star® notice

This product is designed to reduce power consumption and save natural resources without compromising product performance. It has been designed to reduce total energy consumption both during operation and when the device is not active. This product qualifies for ENERGY STAR® which is a voluntary program established to encourage the development of energy-efficient office products.



ENERGY STAR is a U.S. registered service mark of the U.S. EPA. As an ENERGY STAR partner, HP has determined that this product meets ENERGY STAR guidelines for energy efficiency.

For more information on ENERGY STAR guidelines, go to the following Web site:

www.energystar.gov

Index

Symbols/Numerics

(ADF) automatic document feeder
clean 116
feeding problems, troubleshoot 116

A

accessibility 3
accessories
self-test report 68
warranty 157
acoustic emissions 168
ADF (automatic document feeder)
capacity 21
load originals 21
administrator
settings 64
ADSL, fax setup with
parallel phone systems 74
after the support period 159
align ink cartridges 108
answer ring pattern
change 57
parallel phone systems 76
answering machine
fax tones recorded 147
set up with fax (parallel phone systems) 85
set up with fax and modem 86
automatic document feeder (ADF)
capacity 21
clean 116
feeding problems, troubleshoot 116
load originals 21
automatic fax reduction 52

B

Back button 11, 13
backup fax 49
baud rate 58

black and white pages
copy 38
fax 40
troubleshoot 126
black dots or streaks, troubleshoot
copies 135
scan 132
blank pages, troubleshoot
copy 133
print 121
scan 132
blocked fax numbers
set up 52
borderless printing
Mac OS 30
Windows 29
broadcast faxing
send 44
buttons, device control
panel 11, 13

C

cancel
copy 39
print job 34
scan 37
scheduled fax 44
Cancel button 12, 14
capacity
ADF 21
tray 26
cards
guidelines 22
sizes supported 25
tray supporting 26
clean
automatic document feeder 116
exterior 116
ink cartridge contacts 111
ink cartridge ink nozzle area 112
ink cartridges 110
scanner glass 115

color
fax 45
color copy 38
colored text, and OCR 37
colors
bleeding 127
faded or dull 126
print black and white, troubleshoot 126
troubleshoot 127
wrong 126
computer modem
shared with fax (parallel phone systems) 79
shared with fax and answering machine (parallel phone systems) 86
shared with fax and voice line (parallel phone systems) 81
shared with fax and voice mail (parallel phone systems) 90
confirmation reports, fax 61
connections
features available 14
connectors, locating 11
contrast, fax 47
copy
cancel 39
quality 134
troubleshoot 133
Copy menu 16
correct port test, fax 138
critical error messages 17
custom-sized media
guidelines 23
print on 28
sizes supported 25
customer support
electronic 158
Korea 160
phone support 158
warranty 160
cut-off pages, troubleshoot 122

D

dark images, troubleshoot
 scans 132
 darken
 faxes 47
 Declaration of Conformity (DOC) 179
 default settings
 device control panel 17
 driver 33
 fax 47
 print 33
 deleting faxes from memory 50
 device control panel
 administrator settings 64
 buttons 11, 13
 lights 11, 13
 locating 10
 menus 16
 messages 16
 scan 36
 scan from 35
 send faxes 41
 settings, change 17
 Device Services tab, Toolbox (Windows) 65
 dial tone test, failure 140
 dial type, setting 58
 dial-up modem
 shared with fax (parallel phone systems) 79
 shared with fax and answering machine (parallel phone systems) 86
 shared with fax and voice line (parallel phone systems) 81
 shared with fax and voice mail (parallel phone systems) 90
 distinctive ringing
 change 57
 parallel phone systems 76
 DOC 179
 documentation 8
 dots or streaks, troubleshoot
 copies 135
 dots, troubleshoot
 scan 132
 driver
 settings 33

version 158
 warranty 157
 DSL, fax setup with
 parallel phone systems 74
 duty cycle 165

E

ECM. *See* error correction mode
 edit
 scanned images 36
 text in OCR program 37
 electrical specifications 168
 embedded Web server
 about 66
 opening 66
 pages 66
 system requirements 167
 envelopes
 guidelines 22
 sizes supported 24
 tray supporting 26
 environmental
 specifications 168
 error correction mode 47
 error messages
 device control panel 17
 unable to activate TWIN source 131
 error reports, fax 61
 error-correction mode, fax 57
 event log 68
 EWS. *See* embedded Web server

F

faded copies 134
 faded stripes on copies, troubleshoot 135
 fax
 answer mode 56
 answering machine and modem, shared with (parallel phone systems) 86
 answering machine
 troubleshoot 147
 answering machine, set up (parallel phone systems) 85
 auto answer 56
 backup fax 49
 blocking numbers 52

confirmation reports 61
 contrast 47
 darken or lighten 47
 default settings 47
 deleting from memory 50
 dial tone test, failed 140
 dial type, setting 58
 distinctive ringing setup (parallel phone systems) 76
 distinctive ringing, change pattern 57
 DSL, set up (parallel phone systems) 74
 error correction mode 47
 error reports 61
 error-correction mode 57
 forwarding 51
 header 55
 Internet, over 59
 ISDN line, set up (parallel phone systems) 75
 lighten or darken 47
 line condition test, failed 141
 log, print 62
 manual receive 48
 modem and answering machine, shared with (parallel phone systems) 86
 modem and voice line, shared with (parallel phone systems) 81
 modem and voice mail, shared with (parallel phone systems) 90
 modem, shared with (parallel phone systems) 79
 monitor dialing 43, 44
 paper size 52
 parallel phone systems 69
 PBX system, set up (parallel phone systems) 75
 phone cord connection test, failed 138
 phone cord too short 147
 phone cord type test, failed 139
 photos 45
 poll to receive 50
 receive 48

- receive, troubleshoot 142, 144
- redial options 58
- reduction 52
- reports 60
- reprint 50
- resolution 46
- rings to answer 56
- schedule 44
- send 40
- send to multiple recipients 45
- send, troubleshoot 142, 144, 146
- separate line setup (parallel phone systems) 73
- set up 69
- settings 46
- settings, change 55
- setup types 70
- shared phone line setup (parallel phone systems) 77
- specifications 167
- speed 58
- speed-dial entries, set up 31
- speed-dial groups, set up 31
- test failed 136
- test setup 60
- troubleshoot 136
- voice mail, set up (parallel phone systems) 78
- wall jack test, failed 137

Fax B&W function indicator 12, 14

Fax Color function indicator 12, 14

firewalls, troubleshoot 121

FoIP 59

forwarding faxes 51

G

- glass, scanner
 - clean 115
 - load originals 20
 - locating 10
- grainy or white bands on copies, troubleshoot 135
- graphics
 - ink not filling in 125
 - look different from original scan 132
 - missing lines or dots 127

- groups, speed-dial set up 31

H

- hardware, fax setup test 137
- header, fax 55
- help 156
 - see *also* customer support
- Help button 12, 13
- Hewlett-Packard Company notices 3
- HP Photosmart Software scan 36
- HP Photosmart Studio scan 36
- HP Printer Utility (Mac OS) administrator settings 64 opening 67 panels 67
- HP Solution Center 18
- humidity specifications 168

I

- Information tab, Toolbox (Windows) 65
- ink cartridge door, locating 10
- ink cartridge latch, locating 10
- ink cartridges
 - align 108
 - clean 110
 - clean contacts 111
 - clean ink nozzle area 112
 - handle 105
 - locating 10
 - order online 155
 - part names 105
 - remove 161
 - replace 105
 - status 63
 - supported 104, 165
 - test 68
 - warranty 157
 - yields 165
- ink smearing, troubleshoot 125
- installation
 - software for Mac OS 95
 - software for Windows 93
 - troubleshoot 150
- Internet
 - fax, using 59
- ISDN line, set up with fax parallel phone systems 75

J

- jams
 - clear 152
 - media to avoid 22
 - paper 152, 154
- jobs
 - settings 17
- junk fax mode 52

K

- keypad, device control panel locating 11, 13

L

- language, printer 165
- left navigation button 11, 13
- light images, troubleshoot scans 132
- lighten
 - faxes 47
- lights, device control panel 11, 13
- line condition test, fax 141
- lines
 - copies, troubleshoot 135
 - scans, troubleshoot 132
- load
 - main tray 27
- log, fax print 62
- Low ink indicator 12, 14

M

- Mac OS
 - borderless printing 30
 - HP Photosmart Studio 18
 - HP Printer Utility 67
 - install software 95
 - print on special, or custom-sized media 28
 - print settings 34
 - sharing device 95, 96
 - system requirements 165
 - uninstall software 103
 - wireless communication setup 99
- main tray
 - load media 27
 - media supported 26
- maintenance
 - align ink cartridges 108

Index

- clean ink cartridges 110
- replace ink cartridges 105
- manual faxing
 - receive 48
 - send 41, 43
- margins
 - setting, specifications 26
- media
 - ADF capacity 21
 - borderless printing 29
 - clear jams 152
 - HP, order 155
 - load tray 27
 - print on custom-sized 28
 - selecting 22
 - skewed pages 128
 - specifications 23
 - supported sizes 23
 - troubleshoot feeding 128
 - types and weights
 - supported 26
- memory
 - deleting faxes 50
 - reprint faxes 50
 - save faxes 49
 - specifications 165
- menus, device control panel 16
- missing lines or dots,
 - troubleshoot 127
- missing or incorrect
 - information, troubleshoot 122
- model number 68
- modem
 - shared with fax (parallel phone systems) 79
 - shared with fax and answering machine (parallel phone systems) 86
 - shared with fax and voice line (parallel phone systems) 81
 - shared with fax and voice mail (parallel phone systems) 90
- monitor dialing 43, 44
- monitoring tools 63
- multi-feeds, troubleshoot 128

N

- networks
 - connector illustration 11
 - firewalls, troubleshoot 121

- Mac OS setup 95
- operating systems
 - supported 166
- protocols supported 167
- sharing, Windows 94
- system requirements 167
- wireless communication
 - setup 96
 - wireless settings 97
- noise information 168

O

- OCR
 - edit scanned documents 37
 - troubleshoot 130
- OK button 11, 13
- On button 12, 14
- operating environment
 - specifications 168
- operating systems
 - supported 165
- Original loaded indicator 12, 14
- originals
 - edit scans 36
 - scan 35
- output tray
 - locating 10

P

- packing the device 162
- pages per month (duty cycle) 165
- paper
 - jams 152, 154
 - size, set for fax 52
- Paper jam indicator 12, 14
- paper-feed problems,
 - troubleshoot 127
- parallel phone systems
 - answering machine
 - setup 85
 - countries/regions with 69
 - distinctive ringing setup 76
 - DSL setup 74
 - ISDN setup 75
 - modem and answering machine setup 86
 - modem and voice mail
 - setup 90
 - modem setup 79
 - modem shared with voice line setup 81

- PBX setup 75
- separate line setup 73
- setup types 70
- shared line setup 77
- PBX system, set up with fax
 - parallel phone systems 75
- PC Copy B&W function
 - indicator 12, 14
- PC Copy Color function
 - indicator 12, 14
- PCL 3 support 165
- phone cord
 - connected to correct port
 - test failed 138
 - correct type test failed 139
 - extend 147
 - phone customer support 158
- phone line, answer ring
 - pattern 57
- phone support 159
- phone support period
 - period for support 159
- phone, fax from
 - receive 48
 - send, 41
- photo media
 - guidelines 22
 - sizes supported 25
- photos
 - borderless printing 29
 - edit scans 36
 - fax 45
- Photosmart Software
 - scans 36
- Photosmart Studio
 - scan 36
- poll to receive fax 50
- ports, specifications 165
- power
 - specifications 168
 - troubleshoot 120
- power input, locating 11
- power on button 12, 14
- print
 - cancel 34
 - fax logs 62
 - fax reports 60
 - faxes 50
 - self-test report 68
 - settings 33
 - slow 121
 - speed-dial entries 32
 - troubleshoot 120

- print driver
 - settings 33
 - version 158
 - warranty 157
- print quality
 - troubleshoot 123
- print-carriage access door,
 - locating 10
- printer driver
 - settings 33
 - version 158
 - warranty 157
- processor specifications 165
- pulse dialing 58

- Q**
- quality, troubleshoot
 - copy 134
 - print 123
 - scan 131

- R**
- radio interference
 - reducing 100
 - regulatory information 176
- readme 8
- rear access panel
 - clear jams 152
 - illustration 11
- receive faxes
 - auto answer mode 56
 - automatically 48
 - blocking numbers 52
 - forwarding 51
 - manually 48
 - polling 50
 - rings to answer 56
 - troubleshoot 142, 144
- redial button 14
- redial options, setting 58
- reduce fax 52
- regulatory information 170, 176
- regulatory model number 179
- release notes 8
- remove ink cartridges 161
- replace ink cartridges 105
- report
 - wireless test 100
- reports
 - confirmation, fax 61
 - error, fax 61
 - fax test failed 136

- reprint
 - faxes from memory 50
- resolution, fax 46
- right navigation button 11, 13
- rings to answer 56

- S**
- save
 - default settings 17
 - faxes in memory 49
- scan
 - cancel 37
 - edit images 36
 - error messages 131
 - from a TWAIN- or WIA-compliant program 36
 - from device control panel 35
 - OCR 37
 - perform an action 35
 - quality 131
 - scan specifications 168
 - settings for 37
 - slow 130
 - troubleshoot 129
- Scan function indicator 12, 14
- Scan menu 16
- scanner glass
 - clean 115
 - load originals 20
 - locating 10
- schedule fax 44
- security
 - wireless communication 100
 - wireless settings 98
- self-test report
 - information on 68
 - print 68
- send faxes
 - basic fax 40
 - color fax 45
 - manually 41
 - memory, from 43
 - monitor dialing 43, 44
 - multiple recipients 45
 - schedule 44
 - troubleshoot 142, 144, 146
- send scans
 - for OCR 37
 - troubleshoot 129
- serial number 68
- serial phone systems
 - countries/regions with 69
 - setup types 70

- settings
 - administrator 64
 - device control panel 17
 - driver 33
 - fax 46
 - scan 37
 - speed, fax 58
- setup
 - answering machine
 - (parallel phone systems) 85
 - answering machine and modem (parallel phone systems) 86
 - computer modem (parallel phone systems) 79
 - computer modem and answering machine (parallel phone systems) 86
 - computer modem and voice line (parallel phone systems) 81
 - computer modem and voice mail (parallel phone systems) 90
 - connection types 14
 - distinctive ringing 57
 - distinctive ringing (parallel phone systems) 76
 - DSL (parallel phone systems) 74
 - fax 69
 - fax scenarios 70
 - fax, with parallel phone systems 69
 - ISDN line (parallel phone systems) 75
 - PBX system (parallel phone systems) 75
 - separate fax line (parallel phone systems) 73
 - shared phone line (parallel phone systems) 77
 - test fax 60
 - voice mail (parallel phone systems) 78
 - voice mail and computer modem (parallel phone systems) 90
 - Windows 93
- Setup button 12, 13
- setup poster 8

Index

- sharing 14
 - sharing device
 - Mac OS 95
 - Windows 94
 - shipping the device 161
 - size
 - scans, troubleshoot 132
 - troubleshoot copy 134
 - skew, troubleshoot
 - copy 135
 - print 128
 - scan 131
 - slow print, troubleshoot 121
 - software
 - connection types 14
 - HP Photosmart 18
 - installation on Mac OS 95
 - installation on Windows 93
 - OCR 37
 - uninstall from Mac OS 103
 - uninstall from Windows 102
 - warranty 157
 - Solution Center 18
 - sound pressure 168
 - specifications
 - acoustic emissions 168
 - electrical 168
 - media 23
 - network protocols 167
 - operating environment 168
 - physical 164
 - processor and memory 165
 - storage environment 168
 - system requirements 165
 - speed
 - troubleshoot for
 - scanner 130
 - troubleshoot print 121
 - speed dial
 - fax numbers, set up 31
 - groups, set up 31
 - print and view 32
 - send fax 40
 - speed dial button 14
 - Start button 12, 13
 - status
 - messages 16
 - self-test report 68
 - supplies 63
 - storage environment
 - specifications 168
 - streaks, troubleshoot
 - copies 135
 - scan 132
 - stripes on scans, troubleshoot 132
 - subscriber identification code 55
 - supplies
 - order online 155
 - self-test report 68
 - status 63
 - yields 165
 - support. *See* customer support
 - support process 159
 - system requirements 165
- T**
- technical information
 - fax specifications 167
 - scan specifications 168
 - telephone customer support 158
 - telephone line, answer ring
 - pattern 57
 - telephone wall jack, fax 137
 - telephone, fax from
 - receive 48
 - send 41
 - temperature specifications 168
 - tests, fax
 - dial tone, failed 140
 - failed 136
 - fax line condition 141
 - fax phone cord type test
 - failed 139
 - hardware, failed 137
 - port connection, failed 138
 - setup 60
 - telephone wall jack 137
 - text
 - cannot be edited after
 - scan, troubleshoot 130
 - missing from scan, troubleshoot 130
 - splotchy on copies 135
 - troubleshoot 122, 125, 127
 - unclear on copies, troubleshoot 135
 - unclear scans 132
 - tone dialing 58
 - Toolbox (Windows)
 - about 64
 - administrator settings 64
 - Device Services tab 65
 - Estimated Ink Level tab 65
 - Information tab 65
 - opening 65
 - transparencies 23
 - tray
 - capacity 26
 - media sizes supported 23
 - media types and weights supported 26
 - trays
 - capacities 26
 - clear jams 152
 - load media 27
 - locating 10
 - media sizes supported 23
 - paper guides illustration 10
 - troubleshoot feeding 128
 - troubleshoot
 - answering machines 147
 - blank pages printed 121
 - bleeding colors 127
 - colors 126, 127
 - copy 133
 - copy quality 134
 - cut-off pages, incorrect text or graphics
 - placement 122
 - device control panel
 - messages 16
 - fax 136
 - fax dial tone test failed 140
 - fax hardware test failed 137
 - fax line test failed 141
 - fax phone cord connection
 - test failed 138
 - fax phone cord type test
 - failed 139
 - fax tests 136
 - fax wall jack test, failed 137
 - firewalls 121
 - ink not filling text or graphics 125
 - ink smearing 125
 - installation 150
 - jams, paper 154
 - meaningless characters
 - print 124
 - media not picked up from tray 128
 - missing lines or dots 127
 - missing or incorrect information 122
 - multiple pages are picked 128

- nothing prints 121
- paper-feed problems 127
- power 120
- print 120
- print quality 123
- receive faxes 142, 144
- scan 129
- scan quality 131
- self-test report 68
- send faxes 142, 144, 146
- skewed copies 135
- skewed pages 128
- slow print 121
- tips 119
- TWAIN**
 - scan from 36
 - unable to activate
 - source 131
- U**
 - uninstall software
 - Mac OS 103
 - Windows 102
 - USB connection
 - features available 14
 - port, locating 10, 11
 - setup Mac OS 95
 - specifications 165
- V**
 - vertical stripes on copies,
 - troubleshoot 135
 - view
 - speed-dial entries 32
 - voice mail
 - set up with fax (parallel
 - phone systems) 78
 - set up with fax and
 - computer modem
 - (parallel phone
 - systems) 90
 - voltage specifications 168
- W**
 - wall jack test, fax 137
 - warning messages 17
 - warranty 157, 160
 - Web sites
 - accessibility information 3
 - Apple 96
 - customer support 158
 - order supplies and
 - accessories 155
 - supply yield data sheet 165
 - wireless security 98
 - white bands or stripes,
 - troubleshoot
 - copies 135
 - scans 132
 - WIA (Windows Image
 - Application), scan from 36
 - Windows
 - borderless printing 29
 - HP Photosmart Software 18
 - HP Solution Center 18
 - install software 93
 - print on special or custom-
 - sized media 28
 - print settings 33
 - set up wireless
 - communication 99
 - sharing device 94
 - system requirements 165
 - uninstall software 102
 - Windows Image Application
 - (WIA), scan from 36
 - wireless button 14
 - wireless communication
 - Ethernet setup 99
 - reducing interference 100
 - regulatory information 176
 - security 100
 - set up 96
 - set up on Mac OS 99
 - settings 97
 - turn off 100
 - wizard 98
 - wireless test report
 - print 100

© 2008 Hewlett-Packard Development Company, L.P.

www.hp.com/support

