

HP Officejet Pro L7300/L7500/L7600/L7700 User Guide



HP Officejet Pro L7300/L7500/ L7600/L7700 All-in-One series

User Guide



Copyright information

© 2007 Copyright Hewlett-Packard Development Company, L.P.
Edition 1, 10/2006

Reproduction, adaptation or translation without prior written permission is prohibited, except as allowed under the copyright laws.

The information contained herein is subject to change without notice.

The only warranties for HP products and services are set forth in the express warranty statements accompanying such products and services. Nothing herein should be construed as constituting an additional warranty. HP shall not be liable for technical or editorial errors or omissions contained herein.

Copyright (C) 1991-2, RSA Data Security, Inc. Created 1991. All rights reserved.

License to copy and use this software is granted provided that it is identified as the "RSA Data Security, Inc. MD4 Message-Digest Algorithm" in all material mentioning or referencing this software or this function.

License is also granted to make and use derivative works provided that such works are identified as "derived from the RSA Data Security, Inc. MD4 Message-Digest Algorithm" in all material mentioning or referencing the derived work.

RSA Data Security, Inc. makes no representations concerning either the merchantability of this software or the suitability of this software for any particular purpose. It is provided "as is" without express or implied warranty of any kind.

These notices must be retained in any copies of any part of this documentation and/or software.

Trademarks

Intel®, Pentium® is a registered trademark of Intel Corporation or its subsidiaries in the United States and other countries.

Microsoft®, Windows®, and Windows® XP are U.S. registered trademarks of Microsoft Corporation.



Secure Digital memory card is supported by the product. SD Logo is a trademark of its proprietor.

Copy limitations

It is not lawful in many places to make copies of the following items. When in doubt, check with a legal representative first.

- Governmental paper or documents:
 - Passports
 - Immigration papers
 - Selective service papers
 - Identification badges, cards, or insignias
- Governmental stamps:
 - Postage stamps
 - Food stamps
- Checks or drafts drawn on governmental agencies
- Paper currency, traveler's checks, or money orders
- Certificates of deposit
- Copyrighted works

Safety information



Always follow basic safety precautions when using this product to reduce risk of injury from fire or electric shock.

1. Read and understand all instructions in the documentation that comes with the HP All-in-One.
2. Use only a grounded electrical outlet when connecting this product to a power source. If you do not know whether the outlet is grounded, check with a qualified electrician.
3. Observe all warnings and instructions marked on the product.
4. Unplug this product from wall outlets before cleaning.
5. Do not install or use this product near water, or when you are wet.
6. Install the product securely on a stable surface.
7. Install the product in a protected location where no one can step on or trip over the line cord, and the line cord cannot be damaged.
8. If the product does not operate normally, see [Maintain and troubleshoot](#).
9. There are no user-serviceable parts inside. Refer servicing to qualified service personnel.

Product restricted material

This HP product contains the following material that might require special handling at end-of-life:

Mercury in the fluorescent lamp in the scanner (< 1.5 mg)

For recycling information, contact <http://www.hp.com/go/recycle>, local authorities, or the Electronics Industries Alliance at <http://www.eiae.org>.

For more information, see [Recycling](#).

Contents

1 Get started	
Find other resources for the product	10
Accessibility	11
Understand the HP All-in-One parts	12
Front view	13
Printing supplies area	14
Memory card slots	14
Back view	15
Control panel	15
Control panel buttons and lights	16
Color display	18
Two-line display	19
Connection information	19
2 Install the accessories	
Install the duplexer	21
Install Tray 2	21
Turn on accessories in the print driver	22
To turn on accessories on Windows computers	23
To turn on accessories on Macintosh computers	23
3 Use the all-in-one	
Use control panel menus	24
Control-panel message types	25
Status messages	25
Warning messages	25
Error messages	25
Critical error messages	25
Change device settings	25
Use the HP Solution Center (Windows)	26
Use the HP photo and imaging software	26
Text and symbols	28
Type numbers and text on the control-panel keypad	28
To enter text	28
To enter a space, pause, or symbol	28
To erase a letter, number, or symbol	28
Type text using the visual keyboard (some models only)	29
Available symbols for dialing fax numbers (some models only)	30
Load the originals	30
Load an original in the automatic document feeder (ADF)	30
Load an original on the scanner glass	31

Select print media	32
Tips for selecting and using print media	32
Understand specifications for supported media	33
Understand supported sizes	33
Understand supported media types and weights	36
Set minimum margins	37
Load media	37
Configure trays	40
Print on special and custom-sized media	41
To print on special or custom-sized media (Windows)	41
To print on special or custom-sized media (Mac OS)	41
Print borderless	42
To print a borderless document (Windows)	42
To print a borderless document (Mac OS)	43
Set up speed-dial entries (some models only)	43
Set up fax numbers as speed-dial entries or groups	43
To set up speed-dial entries	44
To set up a speed-dial group	44
Set up network folders as speed-dial entries (some models)	45
To set up speed-dial entries	45
Print and view a list of speed-dial entries	46
To print a list of speed-dial entries	46
To view a list of speed-dial entries	46
4 Print	
Change print settings	47
To change settings from an application for current jobs (Windows)	47
To change default settings for all future jobs (Windows)	47
To change settings (Mac OS)	47
Print on both sides (duplexing)	48
Guidelines for printing on both sides of a page	48
To perform duplexing (Windows)	48
To perform automatic duplexing (Mac OS)	49
Cancel a print job	49
5 Copy	
Make copies from the control panel	50
Change the copy settings	50
Crop an original (color display models only)	50
Cancel a copy job	51
6 Scan	
Scan an original	52
Set up Direct Digital Filing (some models only)	52
Scan an original to a network folder	53
Scan an original to a program on a computer (direct connection)	54
Scan an original to a memory device	55
Use Webscan via embedded Web server	55
Scan from a TWAIN-compliant or a WIA-compliant program	55
To scan from a TWAIN-compliant program	56
To scan from a WIA-compliant program	56

Edit a scanned original	56
Edit a scanned photo or graphic	56
Edit a scanned document using optical character recognition (OCR) software	56
Change scan settings	57
Cancel a scan job	57
7 Work with memory devices (some models only)	
Insert a memory card	58
Connect a digital camera	59
Connect a storage device	61
View photos	62
View photos (color display models only)	62
View photos using your computer	62
Print photos from the control panel	62
Print photos using a proof sheet	62
Print panoramic photos	65
Print passport photos	66
Print video action photos	67
Save photos to your computer	68
8 Fax (some models only)	
Send a fax	70
Send a basic fax	70
Send a fax manually from a phone	71
Send a fax using monitor dialing	72
Send a fax using the broadcast fax option (color display models only)	73
Receive a fax	73
Receive a fax manually	73
Set up backup fax reception	74
Reprint received faxes from memory	75
Forward faxes to another number	76
Block junk fax numbers	77
Set the junk fax mode	77
Add numbers to the junk fax list	77
Remove numbers from the junk fax list	78
View a list of blocked fax numbers	78
Change fax settings	79
Configure the fax header	79
Set the answer mode (Auto answer)	79
Set the number of rings before answering	80
Change the answer ring pattern for distinctive ring	80
Set the fax error correction mode	81
To set the fax error-correction mode	81
Set the dial type	81
To set the dial type	81
Set the redial options	81
To set the redial options	82
Set the fax speed	82
Fax over the Internet	82
Test fax setup	83

Use reports	83
Print fax confirmation reports	84
Print fax error reports	84
Print and view the fax log	85
Cancel a fax	85

9 Configure and manage

Manage the device	86
Overview of management tasks	86
Monitor the device	87
Administer the device	88
Use device management tools	90
Embedded Web server	90
To open the embedded Web server	90
Embedded Web server pages	91
Toolbox (Windows)	91
To open the Toolbox	91
Toolbox tabs	92
HP Printer Utility (Mac OS)	93
To open the HP Printer Utility	93
HP Printer Utility panels	93
Network Printer Setup Utility (Mac OS)	94
HP Web Jetadmin software	94
HP Instant Support	94
Security and privacy	95
To gain access to HP Instant Support	95
myPrintMileage	95
Understand the self-test diagnostic page	96
Understand the network configuration page	98
Channel range definitions	99
Configure network options	99
Change basic network settings	99
Use the Wireless Setup Wizard	100
View and print network settings	100
Turn the wireless radio on and off	100
Change advanced network settings	100
Set link speed	100
To View IP settings	101
To Change IP settings	101

Set up faxing for the device (some models only)	101
Set up faxing (parallel phone systems)	102
Choose the correct fax setup for your home or office	102
Select your fax setup case	104
Case A: Separate fax line (no voice calls received)	105
Case B: Set up the device with DSL	106
Case C: Set up the device with a PBX phone system or an ISDN line	107
Case D: Fax with a distinctive ring service on the same line	108
Case E: Shared voice/fax line	109
Case F: Shared voice/fax line with voice mail	110
Case G: Fax line shared with computer modem (no voice calls received)	111
Case H: Shared voice/fax line with computer modem	113
Case I: Shared voice/fax line with answering machine	117
Case J: Shared voice/fax line with computer modem and answering machine	118
Case K: Shared voice/fax line with computer dial-up modem and voice mail	122
Serial-type fax setup	124
Configure the device (Windows)	125
Direct connection	125
To install the software before connecting the device (recommended)	125
To connect the device before installing the software	126
To share the device on a locally shared network	126
Network connection	127
To install the device on a network	127
To install the device software on client computers	127
To install the printer driver using Add Printer	128
Configure the device (Mac OS)	128
To install the software for network or direct connection	128
To share the device on a locally shared network	129
Set up the device for wireless communication (some models only)	129
Understand 802.11 wireless network settings	130
To set up wireless communication using the control panel with wireless setup wizard ...	131
To set up wireless communication using the installer (Windows)	132
To set up wireless communication using SecureEasySetup (SES)	133
To set up the device on a wireless network (Mac OS)	133
To turn off wireless communication	134
Guidelines for reducing interference on a wireless network	134
Guidelines for ensuring wireless network security	134
To add hardware addresses to a WAP	134
Other guidelines	135
Set up the device for Bluetooth communication	135
To set up the device for Bluetooth communication via the embedded Web server	136
Connect the device with Bluetooth	136
Connecting the device with Bluetooth on Windows	136
Connect the device with Bluetooth on Mac OS	138
Set Bluetooth security for the device	138
Use a passkey to authenticate Bluetooth devices	139
To set the device to be visible or not visible to Bluetooth devices	139
Reset Bluetooth settings via the embedded Web server	140
Uninstall and reinstall the software	140

10 Maintain and troubleshoot

Supported ink cartridges	143
Replace the ink cartridges	144
Maintain the printheads	145
To check printhead health	145
To print the print quality diagnostic page	145
To align the printheads	146
To calibrate the linefeed	147
To clean the printheads	147
To clean the printhead contacts manually	147
To replace the printheads	150
Store printing supplies	152
Store ink cartridges	152
Store printheads	152
Clean the device	152
Clean the scanner glass	153
Clean the automatic document feeder (ADF)	153
Clean the exterior	157
Troubleshooting tips and resources	157
Solve printing problems	158
The device shuts down unexpectedly	158
Error message appears on control-panel display	158
The device is not responding (nothing prints)	158
Device does not accept printhead	159
Device takes a long time to print	160
Blank or partial page printed	160
Something on the page is missing or incorrect	161
Placement of the text or graphics is wrong	161
The device prints half a page, then ejects the paper	162
Poor print quality and unexpected printouts	162
Poor quality printouts	162
Meaningless characters print	163
Ink is smearing	163
Ink is not filling the text or graphics completely	164
Output is faded or dull colored	164
Colors are printing as black and white	164
Wrong colors are printing	164
Printout shows bleeding colors	165
Colors do not line up properly	165
Lines or dots are missing from text or graphics	165
Solve paper-feed problems	165
Optional Tray 2 cannot be inserted	165
Another paper-feed problem is occurring	165

Contents

Solve copy problems	167
No copy came out	167
Copies are blank	167
Wrong original was copied	167
Documents are missing or faded	168
Size is reduced	168
Copy quality is poor	168
Copy defects are apparent	168
Error messages appear	169
The device prints half a page, then ejects the paper	169
Solve scan problems	169
Scanner did nothing	170
Scan takes too long	170
Part of the document did not scan or text is missing	170
Text cannot be edited	171
Error messages appear	171
Scanned image quality is poor	171
Scan defects are apparent	173
Unable to scan to network folder (Direct Digital Filing)	173
Solve fax problems	174
The fax test failed	174
Solve photo (memory card) problems	185
The device cannot read the memory card	186
The device cannot read photos on the memory card	186
Some photos on the memory card will not print, causing the print job to cancel	186
The device prints half a page, then ejects the paper	187
Solve device management problems	187
Embedded Web server cannot be opened	187
Troubleshoot installation issues	188
Hardware installation suggestions	188
Software installation suggestions	188
Solve alignment page problems	189
Solve software installation problems	189
Solve network problems	190
Solve wireless problems	191
Clear jams	192
Clear a jam in the device	193
Clear jams in the ADF	195
Tips for avoiding jams	197
A HP supplies and accessories	
Order printing supplies online	198
Accessories	198
Supplies	198
Ink cartridges	198
Printheads	199
HP media	199
B Support and warranty	
Obtain electronic support	200

Obtain HP telephone support	200
Before you call	200
Telephone support numbers	201
Hewlett-Packard limited warranty statement	203
Prepare the device for shipment	204
Remove the ink cartridges and printheads before shipment	204
Remove the control-panel faceplate	205
Pack the device	206
C Device specifications	208
Physical specifications	208
Product features and capacities	208
Processor and memory specifications	209
System requirements	209
Network protocol specifications	210
Embedded Web server specifications	210
Print specifications	210
Print resolution	210
Copy specifications	211
Fax specifications	211
Scan specifications	212
Direct Digital Filing specifications	212
Environmental specifications	212
Electrical specifications	212
Acoustic emission specifications (print in Draft mode, noise levels per ISO 7779)	212
Supported devices	213
Memory card specifications	213
D Regulatory information	214
FCC statement	214
Shielded cables	214
Exposure to radio frequency radiation (wireless products only)	215
Notice to users of the U.S. telephone network	216
Notice to users of the Canadian telephone network	217
Notice to users in the European Economic Area	218
Other regulatory information	218
EMI statement (Korea)	218
VCCI statement (Japan)	219
Regulatory model number	219
Power cord statement	219
LED classification	219
Regulatory information for wireless products	219
Notice to users in Canada/Note à l'attention des utilisateurs Canadien	220
Notice to users in Brazil/Notificação de Normas de Uso de Dispositivos Sem Fio do Brasil	220
Notice to users in the European Union (English)	221
Notice to users in France	222
Notice to users in Germany	223
Notice to users in Italy	224
Notice to users in Spain	225
Declaration of conformity	226

Contents

Environmental sustainability program	228
Reduction and elimination	228
Power consumption	228
Battery information	228
Material safety data sheets	229
Recycling	229
Product packaging	229
Plastics	229
Disposal of waste equipment by users in private households in the European Union	229
HP products and supplies	229
Index	230

1 Get started

This guide provides details about how to use the device and to resolve problems.

- [Find other resources for the product](#)
- [Accessibility](#)
- [Understand the HP All-in-One parts](#)

Find other resources for the product

You can obtain product information and further troubleshooting resources that are not included in this guide from the following resources:

Resource	Description	Location
Setup poster	Provides illustrated setup information.	A printed version of the document is provided with the device.
Getting started guide	Provides instructions for setting up the device and information about the warranty and safety issues.	A printed version of the document is provided with the device.
Readme file and release notes	Provide late-breaking information and troubleshooting tips.	Included on the Starter CD.
Embedded Web server (network connection)	Allows you to view status information, change settings, and manage the device from any computer on the network. For more information, see Embedded Web server .	Available through any standard Web browser.
Toolbox (Microsoft® Windows®)	Provides information about printhead health and access to maintenance services. For more information, see Toolbox (Windows) .	The Toolbox is typically installed with the device software as an available installation option.
HP Printer Utility (Mac OS)	Contains tools to configure print settings, calibrate the device, clean the printheads, print the configuration page, order supplies online, and find support information from the Web site. You can also configure settings for wireless printing. For more information, see HP Printer Utility (Mac OS) .	The HP Printer Utility is typically installed with the device software.

(continued)

Resource	Description	Location
HP Instant Support	Helps you quickly identify, diagnose, and resolve printing problems. For more information, see HP Instant Support .	Available through any standard Web browser or through the Toolbox (Windows).
Control panel	Provides status, error, and warning information about operations.	For more information, see Control panel .
Logs and reports	Provides information about events that have occurred.	For more information, see Monitor the device .
Self-test diagnostic page	<ul style="list-style-type: none">• Device information:<ul style="list-style-type: none">• Product name• Model number• Serial number• Firmware version number• Accessories installed (for example, the duplexer)• Number of pages printed from the trays and accessories• Ink levels• Printhead health status	For more information, see Understand the self-test diagnostic page .
Network configuration page	Provides network configuration information.	For more information, see Understand the network configuration page .
Print quality diagnostic page	Diagnoses issues that affect print quality and helps you decide whether to run any maintenance tools to improve the print quality of your printouts.	For more information, see To print the print quality diagnostic page .
HP Web sites	Provide the latest printer software, and product and support information.	www.hp.com/support www.hp.com
HP telephone support	Lists information to contact HP. During the warranty period, this support is often free of charge.	For more information, see Obtain HP telephone support .
HP photo and imaging software help	Provides information about using the software.	For more information, see Use the HP photo and imaging software .

Accessibility

The device provides a number of features that make it accessible for people with disabilities.

Visual

The device software is accessible for users with visual impairments or low vision through the use of your operating system's accessibility options and features. It also supports most assistive technology such as screen readers, Braille readers, and voice-to-text applications. For users who are color blind, colored buttons and tabs used in the software and on the control panel have simple text or icon labels that convey the appropriate action.

Mobility

For users with mobility impairments, the device software functions can be executed through keyboard commands. The software also supports Windows accessibility options such as StickyKeys, ToggleKeys, FilterKeys, and MouseKeys. The device doors, buttons, paper trays, and paper guides can be operated by users with limited strength and reach.

Support

For more details about the accessibility of this product and HP's commitment to product accessibility, visit HP's Web site at www.hp.com/accessibility.

For accessibility information for the Mac OS, visit the Apple Web site at www.apple.com/accessibility.

Understand the HP All-in-One parts

- [Front view](#)
- [Printing supplies area](#)
- [Memory card slots](#)
- [Back view](#)
- [Control panel](#)
- [Connection information](#)

Front view

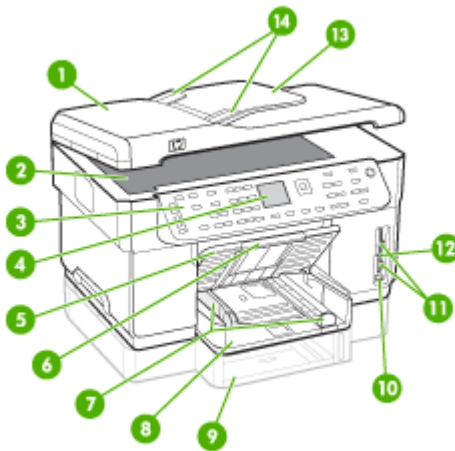

1	Automatic document feeder (ADF)
2	Scanner glass
3	Control panel (differs based on the HP All-in-One model that you have)
4	Display (differs based on the model that you have)
5	Output tray
6	Output tray extension
7	Length/width guides
8	Tray 1
9	Tray 2 (available with some models)
10	Front universal serial bus (USB) port (PictBridge-enabled)
11	Memory card slots
12	Memory device light
13	Document feeder tray
14	Width guides

Printing supplies area

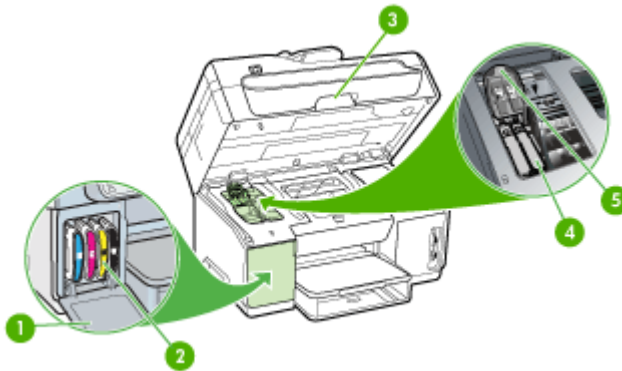

1	Ink cartridge door
2	Ink cartridges
3	Print-carriage access door
4	Printheads
5	Printhead latch

Memory card slots

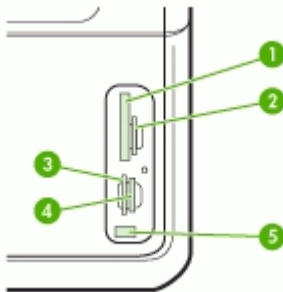

1	CompactFlash (types I and II)
2	Secure Digital, MultimediaCard (MMC), Secure MMC
3	xD
4	Memory Stick, Magic Gate Memory Stick, Memory Stick Duo, Memory Stick Pro
5	Front universal serial bus (USB) port (PictBridge-enabled)

Back view

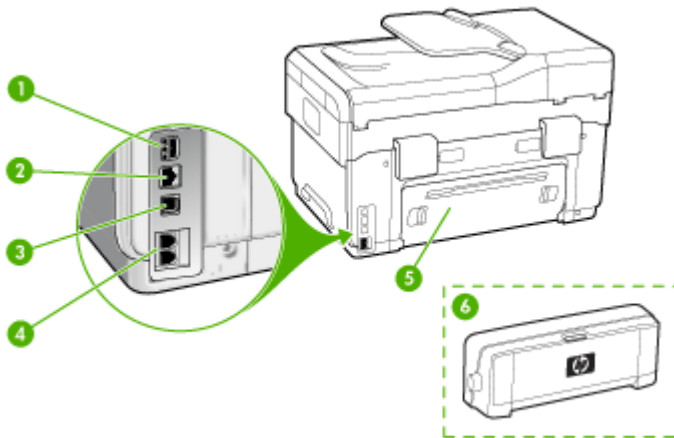

1	Power input
2	Ethernet network port
3	Rear universal serial bus (USB) port
4	Fax ports (1-LINE and 2-EXT) (available on some models)
5	Rear access panel (for models with no duplexer)
6	Automatic two-sided printing accessory (duplexer) (available on some models)

Control panel

The layout and functions available on the control panel depend on which model that you have.

The following sections describe control panel buttons, lights, and displays. Your model might not have all of the features described.

Control panel buttons and lights

The following diagram and related table provide a quick reference to the control panel features.

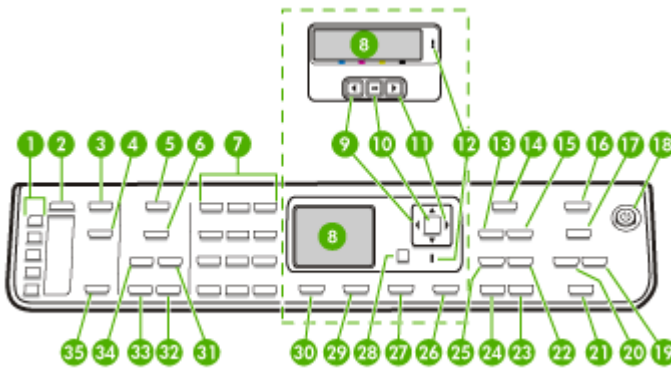

Label	Name and Description
1	One-touch speed-dial buttons: Access the first five speed-dial numbers.
2	Speed Dial: Selects a speed-dial number.
3	Scan Menu: Presents the Scan To menu for selecting a scan destination.
4	Digital Filing: Scans and saves a document to a folder and shares documents with other people on your network.
5	Fax Menu: Presents the Fax menu for selecting options.
6	The button name and functionality depends on the country/region in which the device is sold. Resolution: Adjusts the resolution for the fax you are sending. Junk Fax Blocker: Presents the Junk Fax Blocker Set Up menu for managing unwanted fax calls. You are required to subscribe to a caller ID service to use this feature.
7	Keypad: Enters fax numbers, values, or text.
8	Display: View menus and messages.
9	Left arrow: Decreases values on the display.
10	OK: Selects a menu or a setting on the display.
11	Right arrow: Increases values on the display.
12	Attention light: When blinking, the attention light indicates an error has occurred that requires your attention.
13	Reduce/Enlarge: Changes the size of a copy for printing.
14	Copy Menu: Presents the Copy menu for selecting options.
15	Number of Copies: Select the number of copies to be printed.
16	Photo Menu: Presents the Photo menu for selecting options.

(continued)





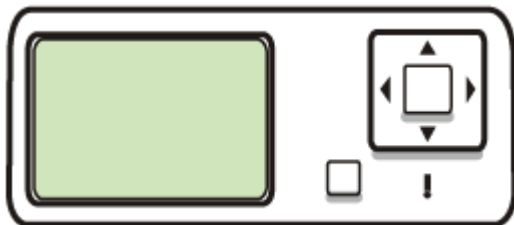

Label	Name and Description
17	<p>The button name and functionality depends on the model and the country/region in which the device is sold.</p> <p>Proof Sheet: Prints a proof sheet when a memory card is inserted in a memory card slot. A proof sheet shows thumbnail views of all the photos on the memory card. You can select photos on the proof sheet, and then print those photos by scanning the proof sheet.</p> <p>Rotate: Rotate the current image on the display. The rotated image can be printed.</p>
18	<p>Power: Turns the device on or off. The Power button is lit when the device is on. The light blinks while performing a job.</p> <p>When the device is turned off, a minimal amount of power is still supplied. To completely disconnect the power supply, turn the device off, and then unplug the power cord.</p>
19	<p>Zoom Out: Reduces the size of the image on the display.</p>
20	<p>Zoom In: Increases the size of the image on the display.</p>
21	<p>PRINT PHOTOS: Selects the photo function. Use this button to print photos from a memory card or storage device, or to save photos to your computer.</p>
22	<p>Quality: Selects Best, Normal, or Fast quality for copying.</p>
23	<p>START COPY Color: Starts a color copy job.</p>
24	<p>START COPY Black: Starts a black-and-white copy job.</p>
25	<p>Collate: Organizes the copies in order so they are ready to use when the copying job finishes.</p>
26	<p>Cancel: Stops a job, exits a menu, or exits settings.</p>
27	<p>Help: Displays the Help menu. You can choose from a list of help topics. When you make a selection, the detailed help information is displayed on the monitor of a connected computer.</p>
28	<p>Back: Moves you one level up in the menu.</p>
29	<p>2-sided: Performs a two-sided copy or fax job.</p>
30	<p>Setup: Presents the Setup Menu for generating reports, changing fax and other maintenance settings, and accessing the Help menu. The topic that you select from the Help menu opens a help window on your computer screen.</p>
31	<p>Auto Answer: When this button is lit, the device automatically answers incoming phone calls. When off, the device does not answer any incoming fax calls.</p>
32	<p>START FAX Color: Starts a color fax.</p>
33	<p>START FAX Black: Starts a black-and-white fax.</p>
34	<p>Redial/Pause: Redials the most recently dialed number, or inserts a 3-second pause in a fax number.</p>
35	<p>START SCAN: Starts a scan job and sends it to the destination you selected using the Scan To button.</p>

Color display



 **NOTE:** This type of display is available on some models.

The following icons appear at the bottom of the color display to provide important information. Some of the icons appear only if your device has network capability. For more information about networking, see [Configure network options](#).

Icon	Purpose
	Shows the amount of ink in the ink cartridge. The color of the icon corresponds to the color of the ink cartridge, and the fill level of the icon corresponds to the fill level of the ink cartridge.
	Shows that an unknown ink cartridge is inserted. This icon might appear if an ink cartridge contains non-HP ink.
	Shows that a wired network connection exists.
	Shows that the device has wireless networking capability, but no wireless network connection exists. This icon is gray when a wireless network signal is not available, and blue when a signal exists. This is for infrastructure mode. (This feature is supported on some models.) For more information, see Set up the device for wireless communication (some models only) .
	Shows that a wireless network connection exists. The signal strength is indicated by the number of curved lines. This is for infrastructure mode. (This feature is supported on some models.) For more information, see Set up the device for wireless communication (some models only) .
	Shows that an ad hoc, or computer-to-computer, wireless network connection exists. (This feature is supported on some models.) For more information, see Set up the device for wireless communication (some models only) .
	Shows that a Bluetooth adapter is installed, and a connection exists. A separate Bluetooth adapter is required. For more information, see Accessories . For more information on setting up Bluetooth, see Guidelines for ensuring wireless network security .

Two-line display

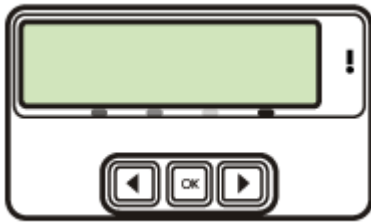

 **NOTE:** This type of display is available on some models.

The two-line display shows status and error messages, menu options, and advisory messages. If you insert a memory card or connect a camera, the display goes into photo state and shows the top of the Photo menu.

Connection information

Description	Recommended number of connected computers for best performance	Supported software features	Setup instructions
USB connection	One computer connected with a USB cable to the rear USB 2.0 high-speed port on the device.	All features are supported, except Webscan. For information, see Use Webscan via embedded Web server.	Follow the getting started guide for detailed instructions.
Ethernet (wired) connection	Up to five computers connected to the device using a hub or router.	All features are supported, including Webscan.	Follow the instructions in the getting started guide, and then see To share the device on a locally shared network in this guide for further instructions.
Printer sharing	Up to five computers. The host computer must be turned on at all times, or the other computers cannot print to the device.	All features resident on the host computer are supported. Only print is supported from the other computers.	Follow the instructions in To share the device on a locally shared network.
802.11 wireless	Up to five computers connected to the device using a hub or router.	All features are supported, including Webscan.	Follow the instructions in Set up the device for wireless communication (some models only).
HP bt300, Printer and PC Adapter with	One Bluetooth device or computer.	Printing from a Bluetooth device such	Follow the instructions in Set up the device for

Description	Recommended number of connected computers for best performance	Supported software features	Setup instructions
Bluetooth® Wireless Technology		as a PDA, camera phone, or Bluetooth-enabled computer.	Bluetooth communication.

2 Install the accessories

This section contains the following topics:

- [Install the duplexer](#)
- [Install Tray 2](#)
- [Turn on accessories in the print driver](#)

Install the duplexer

 **NOTE:** This feature is available with some models of the device.

You can print on both sides of a sheet of paper automatically when the optional automatic two-sided printing accessory (duplexer) is installed. For information on using the duplexer, see [Print on both sides \(duplexing\)](#).

To install the duplexer

1. Push the buttons on the rear access panel and remove the panel from the device.
2. Slide the duplexer into the device until the unit locks into place. Do not press the buttons on either side of the duplexer when installing the unit; use them only for removing the unit from the device.

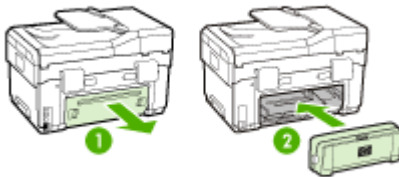

Install Tray 2

 **NOTE:** This feature is available with some models of the device.

Tray 2 can hold up to 350 sheets of plain paper. For ordering information, see [Accessories](#).

To install Tray 2

1. Unpack the tray, remove the packing tapes and materials, and move the tray to the prepared location. The surface must be sturdy and level.

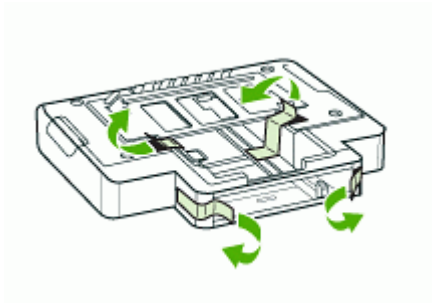

2. Turn off the device, and disconnect the power cord.
3. Set the device on top of the tray.

△ **CAUTION:** Be careful to keep your fingers and hands clear of the bottom of the device.

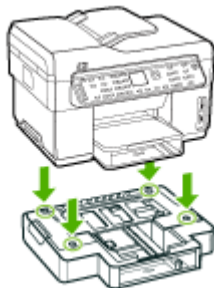

4. Connect the power cord and turn on the device.
5. Enable Tray 2 in the print driver. For more information, see [Turn on accessories in the print driver](#).

Turn on accessories in the print driver

- [To turn on accessories on Windows computers](#)
- [To turn on accessories on Macintosh computers](#)

To turn on accessories on Windows computers

After you install the device software on Windows computers, Tray 2 must be turned on in the print driver in order for it to work with the device. (The duplexer does not need to be turned on.)

1. Click **Start**, point to **Settings**, and then click **Printers** or **Printers and Faxes**.
- Or -
Click **Start**, click **Control Panel**, and then double-click **Printers**.
2. Right-click the printer icon, and then click **Properties**, **Document Defaults**, or **Printing Preferences**.
3. Select one of these tabs: **Configure**, **Device Settings**, or **Device Options**. (The name of the tab depends on the print driver and the operating system.) On the selected tab, click the accessory that you want to turn on, click **Installed** from the drop-down menu, and then click **OK**.

To turn on accessories on Macintosh computers

The Mac OS automatically turns on all accessories in the print driver when you install the device software. If you add a new accessory later, follow these steps:

1. Click the **Printer Setup Utility** icon in the Dock.
2. On the **Printer List** window, click once on the device you want to set up to select it.
3. From the **Printers** menu, select **Show info**.
4. Click the **Names and Location** drop-down menu and select **Installable Options**.
5. Check the accessory that you want to turn on.
6. Click **Apply Changes**.

3 Use the all-in-one

This section contains the following topics:

- [Use control panel menus](#)
- [Control-panel message types](#)
- [Change device settings](#)
- [Use the HP Solution Center \(Windows\)](#)
- [Use the HP photo and imaging software](#)
- [Text and symbols](#)
- [Load the originals](#)
- [Select print media](#)
- [Load media](#)
- [Configure trays](#)
- [Print on special and custom-sized media](#)
- [Print borderless](#)
- [Set up speed-dial entries \(some models only\)](#)

Use control panel menus

The following sections provide a quick reference to top-level menus that appear on the control-panel display. To display a menu, press the menu button for the function you want to use.



NOTE: The type of display on the control panel—color display or two-line display—depends on the model you have.

- **Scan menu:** Presents a list of destinations; for example, HP photo and imaging software. On some models, you can scan and reprint a photo or scan to a memory card.
- **Fax menu:** Allows you to enter a fax or speed-dial number, or display the Fax menu. Menu options include:
 - Modifying resolution
 - Lightening/darkening
 - Sending delayed faxes
 - Setting up new defaults
- **Copy menu:** Menu options include:
 - Selecting copy quantities
 - Reducing/enlarging
 - Selecting media type and size
- **Photo menu:** Menu options include:
 - Selecting print options
 - Using special features
 - Editing

- Transferring to a computer
- Selecting a proof sheet

Control-panel message types

This section contains the following topics:

- [Status messages](#)
- [Warning messages](#)
- [Error messages](#)
- [Critical error messages](#)

Status messages

Status messages reflect the current state of the device. They inform you of normal operation and require no action to clear them. They change as the state of the device changes. Whenever the device is ready, not busy, and has no pending warning messages, the status message **READY** appears if the device is turned on.

Warning messages

Warning messages inform you of events that require your attention, but they do not prevent the device from operating. An example of a warning message is **CYAN INK LOW**. These messages appear until you resolve the condition.

Error messages

Error messages communicate that some action must be performed, such as adding media or clearing a media jam. These messages are usually accompanied by a blinking red Attention light. Take the appropriate action to continue printing.

If the error message shows an error code, press the Power button to turn off the device, and then turn it on again. In most situations, this action solves the problem. If the message persists, your device might need service. Write down the error code, and then go to HP Instant Support to learn more about possible causes for the message. For more information, see [HP Instant Support](#).

Critical error messages

Critical error messages inform you of a device failure. Some of these messages can be cleared by pressing the Power button to turn off the device, and then turning it on again. If a critical error persists, service is required. For more information, see [Support and warranty](#).

Change device settings

You can change the device settings from these places:

- From the control panel.
- From the HP Solution Center (Windows) or HP Device Manager (Mac OS). For more information, see [Use the HP photo and imaging software](#).
- From the embedded Web server. For more information, see [Embedded Web server](#).



NOTE: When you are configuring settings in HP Solution Center or in HP Device Manager, you cannot see the settings that have been configured from the control panel (such as the scan settings).

To change settings from the control panel

1. At the control panel, press the menu button for the function you are using (for example, Copy Menu).
2. To reach the option that you want to change, use one of the following methods:
 - Press a control-panel button, and then use the left or right arrow keys to adjust the value.
 - Select the option from the menu on the control-panel display.
3. Select the value that you want, and then press **OK**.

To change settings from the HP photo and imaging software (Mac OS)

1. Click the **HP Device Manager** icon in the Dock.
2. Select the device in the **Devices** drop-down menu.
3. On the **Information and Settings** menu, click an item that you want to change.

To change settings from the embedded Web server

1. Open the embedded Web server.
2. Select the page with the setting you want to change.
3. Change the setting and then click **Apply**.

Use the HP Solution Center (Windows)

On a Windows computer, the HP Solution Center is the entry point for the HP Photosmart Software. Use the HP Solution Center to change print settings, start the Fax Setup Wizard, order supplies, and access the onscreen Help.

The features available in the HP Solution Center vary depending on the devices you have installed. The HP Solution Center is customized to show icons that are associated with the selected device. If the selected device is not equipped with a particular feature, then the icon for that feature does not appear in the HP Solution Center.

If the HP Solution Center on your computer does not contain any icons, an error might have occurred during the software installation. To correct this, use the Control Panel in Windows to completely uninstall the HP Photosmart Software, and then reinstall the software. For more information, see the onscreen Help that came with the device.

For information about opening the HP Solution Center, see [Use the HP photo and imaging software](#).

Use the HP photo and imaging software

You can use the HP photo and imaging software to access many features that are not available from the control panel.

The software is installed on your computer during setup. For further information, see the setup documentation that came with your device.

Access to the HP photo and imaging software differs by operating system (OS). For example, if you have a Windows computer, the HP photo and imaging software entry point is the HP Photosmart Software window. If you have a Macintosh computer, the HP photo and imaging software entry point is the HP Photosmart Studio window. Regardless, the entry point serves as the launching pad for the HP photo and imaging software and services.

To open the HP Photosmart Software on a Windows computer

1. Do one of the following:
 - On the Windows desktop, double-click the HP Photosmart Software icon.
 - In the system tray at the far right of the Windows taskbar, double-click the **HP Digital Imaging Monitor** icon.
 - On the taskbar, click **Start**, point to **Programs** or **All Programs**, select **HP**, and then click the HP Photosmart Software.
2. If you have more than one HP device installed, select the tab with your product's name.

 **NOTE:** On a Windows computer, the features available in the HP Photosmart Software vary depending on the devices you have installed. The software is customized to show icons that are associated with the selected device. If the selected device is not equipped with a particular feature, then the icon for that feature does not appear in the software.

 **TIP:** If the HP Photosmart Software on your computer does not contain any icons, an error might have occurred during the software installation. To correct this, use the Control Panel in Windows to completely uninstall the HP Photosmart Software; then reinstall the software. For more information, see the Getting Started Guide that came with your device.

To open the HP Photosmart Studio software on a Macintosh computer

1. Click the HP Photosmart Studio icon in the Dock.
The HP Photosmart Studio window appears.
2. In the HP Photosmart Studio task bar, click **Devices**.
The HP Device Manager window appears.
3. Select your device from the **Device** drop-down menu.
From here, you can scan, send faxes, import documents, and perform maintenance procedures such as checking the ink levels for the ink cartridges.

 **NOTE:** On a Macintosh computer, the features available in the HP Photosmart Studio software vary depending on the selected device.

 **TIP:** When the HP Photosmart Studio software is opened, you can gain access to the Dock menu shortcuts by selecting and holding the mouse button over the HP Photosmart Studio icon in the Dock.

Text and symbols

You can use the keypad on the control panel to enter text and symbols. You can also enter text and symbols from the control panel by using the visual keyboard (some models only). The visual keyboard appears automatically on the color display when you set up a wired or wireless network, the fax header, or speed-dial entries.

You can also enter symbols from the keypad when you dial a fax or phone number. When the device dials the number, it interprets the symbol and responds accordingly. For example, if you enter a dash in the fax number, the device will pause before dialing the remainder of the number. A pause is useful if you need to gain access to an outside line before dialing the fax number.

 **NOTE:** If you want to enter a symbol in your fax number, such as a dash, you need to enter the symbol by using the keypad.

Type numbers and text on the control-panel keypad

You can enter text or symbols by using the keypad on the control panel.

After you are done entering text, press **OK** to store your entry.

To enter text

1. Press the keypad numbers that correspond to the letters of a name. For example, the letters a, b, and c correspond to the number 2, as shown on the button below.



 **TIP:** Press a button multiple times to see the available characters. Depending on your language and country/region setting, other characters might be available in addition to the ones shown on the keypad.

2. After the correct letter appears, wait for the cursor to advance automatically to the right, or press the right arrow button. Press the number that corresponds to the next letter in the name. Press the button multiple times until the correct letter appears. The first letter of a word is automatically set to uppercase.

To enter a space, pause, or symbol

- To insert a space, press **Space**.
- To enter a pause, press **Redial/Pause**. A dash appears in the number sequence.
- To enter a symbol, such as @, press the **Symbols** button repeatedly to scroll through the list of available symbols: asterisk (*), dash (-), ampersand (&), period (.), slash (/), parentheses (), apostrophe ('), equals (=), number sign (#), at (@), underscore (_), plus (+), exclamation (!), semicolon (;), question (?), comma (,), colon (:), percent (%), and approximation (~).

To erase a letter, number, or symbol

- ▲ If you make a mistake, press the left arrow button to clear it, and then make the correct entry.

Type text using the visual keyboard (some models only)

You can enter text or symbols by using the visual keyboard that automatically appears on the color display when you must enter text. For example, the visual keyboard automatically appears when you are setting up a wired or wireless network, the fax header, or speed-dial entries.

To enter text by using the visual keyboard

1. To select a letter, number, or symbol using the visual keyboard, press the arrow keys to highlight the appropriate selection.

To enter lowercase letters, uppercase letters, numbers, and symbols

- To enter lowercase letters, select the **abc** button on the visual keyboard, and then press **OK**.
- To enter uppercase letters, select the **ABC** button on the visual keyboard, and then press **OK**.
- To enter numbers and symbols, select the **123** button on the visual keyboard, and then press **OK**.

To add a space

To add a space, press the right arrow button on the visual keyboard, and then press **OK**.

 **NOTE:** Make sure you use the right arrow button on the visual keyboard to add a space. You cannot add a space by using the arrow buttons on the control panel.

2. When you have highlighted the appropriate letter, number, or symbol, press **OK** on the control panel to select it.
The selection appears on the color display.

 **TIP:** To erase a letter, number, or symbol, select **Clear** on the visual keyboard, and then press **OK**.

3. When you are finished entering text, numbers, or symbols, select **Done** on the visual keyboard, and then press **OK**.

Available symbols for dialing fax numbers (some models only)

To enter a symbol, such as *, press **Symbols** repeatedly to scroll through the list of symbols. The following table provides the symbols that you can use in a fax or phone number sequence, fax header information, and speed-dial entries.

Available symbols	Description	Available when entering
*	Displays an asterisk symbol when required for dialing.	Fax header name, speed-dial names, speed-dial numbers, fax or phone numbers, and monitor dial entries
-	When auto-dialing, the device enters a pause in the number sequence.	Fax header name, fax header number, speed-dial names, speed-dial numbers, and fax or phone numbers
()	Displays a left or right parenthesis to separate numbers, such as area codes, for easier reading. These symbols do not affect dialing.	Fax header name, fax header number, speed-dial names, speed-dial numbers, and fax or phone numbers
W	When auto-dialing, W causes the device to wait for a dial tone before continuing to dial.	Speed-dial numbers and fax or phone numbers
R	During auto-dialing, the R functions the same as a Flash button on your telephone.	Speed-dial numbers and fax or phone numbers
+	Displays a plus symbol. This symbol does not affect dialing.	Fax header name, fax header number, speed-dial names, speed-dial numbers, and fax or phone numbers

Load the originals

You can load an original for a copy, fax, or scan job in the automatic document feeder or on the scanner glass. Originals that are loaded in the automatic document feeder are automatically fed into the device.

Load an original in the automatic document feeder (ADF)

You can copy, scan, or fax a one-sided or two-sided, single- or multiple-page, A4- or letter-size document by placing it in the document feeder tray.

 **CAUTION:** Do not load photos in the ADF; this might cause damage to your photos.

 **NOTE:** Two-sided legal-size documents cannot be scanned, copied, or faxed using the ADF. Some features, such as the **Fit to Page** copy feature, do not work when you load your originals in the ADF. You must load your originals on the glass.

The document feeder tray holds a maximum of 50 sheets of plain paper.

To load an original in the document feeder tray

1. Load your original, with the print side up, into the document feeder tray. Place the pages so that the top edge of the document goes in first. Slide the media into the automatic document feeder until you hear a beep or see a message on the display indicating that the loaded pages were detected.

 **TIP:** For more help on loading originals in the automatic document feeder, refer to the diagram engraved in the document feeder tray.

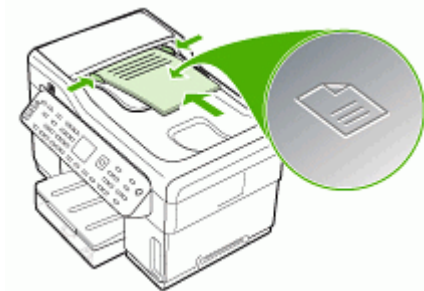

2. Slide the width guides inward until they stop at the left and right edges of the media.

 **NOTE:** Remove all originals from the document feeder tray before lifting the lid on the device.

Load an original on the scanner glass

You can copy, scan, or fax up to letter- or A4-size originals by loading them on the glass. Some models support legal-size originals on the glass. If your original contains multiple full-size pages, load it in the automatic document feeder. If your model does not support legal-size originals on the glass, load legal-size originals in the automatic document feeder.

 **NOTE:** Many of the special features will not work correctly if the glass and lid backing are not clean. For more information, see [Clean the device](#).

To load an original on the scanner glass

1. Remove all originals from the document feeder tray, and then lift the lid.
2. Load your original print side down in the right front corner of the glass.

 **TIP:** For more help on loading an original, refer to the engraved guides along the edge of the glass.



3. Close the lid.

Select print media

The device is designed to work well with most types of office media. It is best to test a variety of print media types before buying large quantities. Use HP media for optimum print quality. Visit the HP Web site at www.hp.com for more information about HP media.

Tips for selecting and using print media

For the best results, observe the following guidelines.

- Always use media that conforms to the device specifications. For more information, see [Understand specifications for supported media](#).
- Load only one type of media at a time into a tray.
- For Tray 1 and Tray 2, load media print-side down and aligned against the right and back edges of the tray. Tray 2 is available with some models. For more information, see [Load media](#).
- Tray 2 is designed to hold only plain paper.
- Do not overload the trays. For more information, see [Understand specifications for supported media](#).
- To prevent jams, poor print quality, and other printing problems, avoid the following media:
 - Multipart forms
 - Media that is damaged, curled, or wrinkled
 - Media with cutouts or perforations
 - Media that is heavily textured, embossed, or does not accept ink well
 - Media that is too lightweight or stretches easily

Cards and envelopes

- Avoid envelopes that have a very slick finish, self-stick adhesives, clasps, or windows. Also avoid cards and envelopes with thick, irregular, or curled edges, or areas that are wrinkled, torn, or otherwise damaged.
- Use tightly constructed envelopes, and make sure the folds are sharply creased.
- Load envelopes with the flaps facing up.

Photo media

- Use the **Best** mode to print photographs. Note that in this mode, printing takes longer and more memory is required from your computer.
- Remove each sheet as it prints and set it aside to dry. Allowing wet media to stack up may cause smearing.

Transparencies

- Insert transparencies with the rough side down and the adhesive strip pointing towards the back of the device.
- Use the **Normal** mode to print transparencies. This mode provides longer drying time and ensures that the ink dries completely before the next page is delivered to the output tray.
- Remove each sheet as it prints and set it aside to dry. Allowing wet media to stack up may cause smearing.

Custom-sized media

- Use only custom-sized media that is supported by the device.
- If your application supports custom-sized media, set the media size in the application before printing the document. If not, set the size in the print driver. You might need to reformat existing documents to print them correctly on custom-sized media.

Understand specifications for supported media

Use the [Understand supported sizes](#) and [Understand supported media types and weights](#) tables to determine the correct media to use with your device, and determine what features will work with your media.

- [Understand supported sizes](#)
- [Understand supported media types and weights](#)

Understand supported sizes

 **NOTE:** Tray 2 and the duplexer are available with some models.

Media size	Tray 1	Tray 2	Duplexer	ADF
Standard media sizes				
U.S. Letter (216 x 279 mm; 8.5 x 11 inches)	✓	✓	✓	✓
8.5 x 13 inches (216 x 330 mm)*	✓	✓		
U.S. Legal (216 x 356 mm; 8.5 x 14 inches)	✓	✓		✓
A4 (210 x 297 mm; 8.3 x 11.7 inches)	✓	✓	✓	✓
U.S. Executive (184 x 267 mm; 7.25 x 10.5 inches)	✓	✓	✓	✓

(continued)

Media size	Tray 1	Tray 2	Duplexer	ADF
U.S. Statement (140 x 216 mm; 5.5 x 8.5 inches)	✓			✓
B5 (182 x 257 mm; 7.17 x 10.12 inches)	✓	✓	✓	✓
A5 (148 x 210 mm; 5.8 x 8.3 inches)	✓		✓	✓
6 x 8 inches*	✓		✓	
Borderless A4 (210 x 297 mm; 8.3 x 11.7 inches)*	✓			
Borderless A5 (148 x 210 mm; 5.8 x 8.3 inches)*	✓			
Borderless B5 (182 x 257 mm; 7.17 x 10.12 inches)*	✓			
Envelopes				
U.S. #10 Envelope (105 x 241 mm; 4.12 x 9.5 inches)*	✓			
Monarch Envelope (98 x 191 mm; 3.88 x 7.5 inches)*	✓			
HP Greeting Card Envelope (111 x 152 mm; 4.38 x 6 inches)*	✓			
A2 Envelope (111 x 146 mm; 4.37 x 5.75 inches)*	✓			
DL Envelope (110 x 220 mm; 4.3 x 8.7 inches)*	✓			
C5 Envelope (162 x 229 mm; 6.4 x 9 inches)*	✓			
C6 Envelope (114 x 162 mm; 4.5 x 6.4 inches)*	✓			
Japanese Envelope Chou #3 (120 x 235 mm; 4.7 x 9.3 inches)*	✓			
Japanese Envelope Chou #4 (90 x 205 mm; 3.5 x 8.1 inches)*	✓			
Cards				
Index card (76.2 x 127 mm; 3 x 5 inches)*	✓			
Index card (102 x 152 mm; 4 x 6 inches)*	✓		✓	
Index card (127 x 203 mm; 5 x 8 inches)*	✓		✓	
A6 card (105 x 148.5 mm; 4.13 x 5.83 inches)*	✓		✓	

(continued)

Media size	Tray 1	Tray 2	Duplexer	ADF
Borderless A6 card (105 x 148.5 mm; 4.13 x 5.83 inches)*	✓			
Hagaki** (100 x 148 mm; 3.9 x 5.8 inches)*	✓			
Photo media				
Photo media (76.2 x 127 mm; 3 x 5 inches)*	✓			
Photo media (102 x 152 mm; 4 x 6 inches)*	✓			
Photo media (5 x 7 inches)*	✓			
Photo media (8 x 10 inches)*	✓			
Photo media (10 x 15 cm)*	✓			
Photo L (89 x 127 mm; 3.5 x 5 inches)*	✓			
Borderless photo media (102 x 152 mm; 4 x 6 inches)*	✓			
Borderless photo media (5 x 7 inches)*	✓			
Borderless photo media (8 x 10 inches)*	✓			
Borderless photo media (8.5 x 11 inches)*	✓			
Borderless photo media (10 x 15 cm)*	✓			
Borderless Photo L (89 x 127 mm; 3.5 x 5 inches)*	✓			
Other media				
Custom-sized media between 76.2 to 216 mm wide and 127 to 356 mm long (3 to 8.5 inches wide and 5 to 14 inches long) *	✓			
Custom-sized media (ADF) between 127 to 216 mm wide and 241 to 305 mm long (5 to 8.5 inches wide and 9.5 to 12 inches long)				✓
Panorama (4 x 10 inches, 4 x 11 inches, and 4 x 12 inches) *	✓			
Borderless panorama (4 x 10 inches, 4 x 11 inches, and 4 x 12 inches) *	✓			

* Not compatible for use with the ADF for single- or double- sided printing

** The device is compatible with plain and inkjet hagaki from Japan Post only. It is not compatible with photo hagaki from Japan Post.

Understand supported media types and weights

 **NOTE:** Tray 2 and the duplexer are available with some models.

Tray	Type	Weight	Capacity
Tray 1	Paper	60 to 105 g/m ² (16 to 28 lb bond)	Up to 250 sheets of plain paper (25 mm or 1 inch stacked)
	Transparencies		Up to 70 sheets (17 mm or 0.67 inch stacked)
	Photo media	280 g/m ² (75 lb bond)	Up to 100 sheets (17 mm or 0.67 inch stacked)
	Labels		Up to 100 sheets (17 mm or 0.67 inch stacked)
	Envelopes	75 to 90 g/m ² (20 to 24 lb bond envelope)	Up to 30 sheets (17 mm or 0.67 inch stacked)
	Cards	Up to 200 g/m ² (110 lb index)	Up to 80 cards
Tray 2	Plain paper only	60 to 105 g/m ² (16 to 28 lb bond)	Up to 350 sheets of plain paper (35 mm or 1.38 inch stacked)
Duplexer	Paper	60 to 105 g/m ² (16 to 28 lb bond)	Not applicable
Output-bin	All supported media		Up to 150 sheets of plain paper (text printing)

Set minimum margins

The document margins must match (or exceed) these margin settings in portrait orientation.

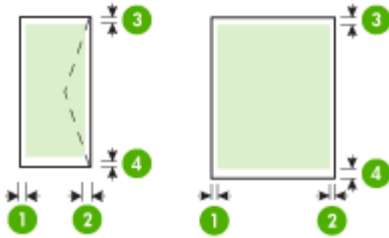

Media	(1) Left margin	(2) Right margin	(3) Top margin	(4) Bottom margin*
U.S. Letter	3.3 mm (0.13 inch)	3.3 mm (0.13 inch)	3.3 mm (0.13 inch)	3.3 mm (0.13 inch)
U.S. Legal				
A4				
U.S. Executive				
U.S. Statement				
8.5 x 13 inch				
B5				
A5				
Cards				
Custom-sized media				
Photo media				
Envelopes	3.3 mm (0.13 inch)	3.3 mm (0.13 inch)	16.5 mm (0.65 inch)	16.5 mm (0.65 inch)

* To achieve this margin setting on a computer running Windows, click the **Advanced** tab in the print driver, and select **Minimize Margins**.

 **NOTE:** If you are using the duplexer (available with some models), the minimum top and bottom margins must match or exceed 12 mm (0.47 inch).

Load media

This section provides instructions for loading media into the device.

 **NOTE:** Tray 2 is available with some models. For ordering information, see [Order printing supplies online](#).

To load Tray 1 (main tray)

1. Lift the output tray.

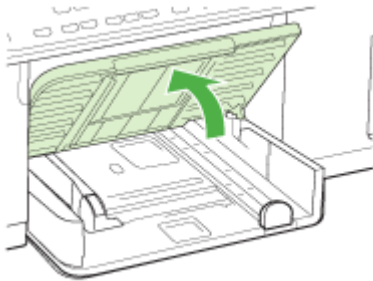

2. Insert the media print-side down along the right of the tray. Make sure the stack of media aligns with the right and back edges of the tray, and does not exceed the line marking in the tray.

 **NOTE:** Do not load paper while the device is printing.

3. Slide the media guides in the tray to adjust them for the media size that you have loaded, and then lower the output tray.

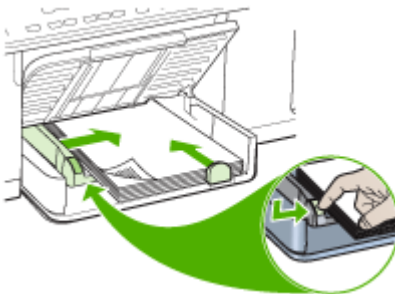

4. Pull out the extension on the output tray.

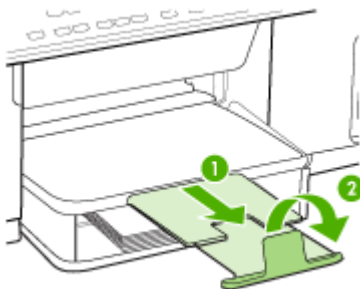

To load Tray 2

1. Pull the tray out of the device by grasping under the front of the tray.



2. Insert the paper print-side down along the right of the tray. Make sure the stack of paper aligns with the right and back edges of the tray, and does not exceed the line marking in the tray.

 **NOTE:** Tray 2 can be loaded only with plain paper.

3. Slide the media guides in the tray to adjust them for the size that you have loaded.

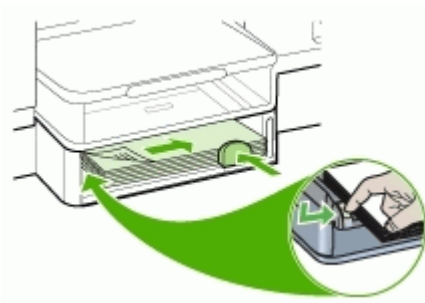

4. Gently reinsert the tray.
5. Pull out the extension on the output tray.

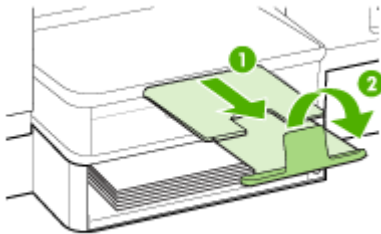

Configure trays

 **NOTE:** Tray 2 is available with some models. For ordering information, see [Order printing supplies online](#).

By default, the device draws media from Tray 1. If Tray 1 is empty, the device draws media from Tray 2 (if it is installed and loaded with media). You can change this default behavior by using the following features:

- **Tray Lock:** Use this feature to protect special media such as letterhead or preprinted media from accidental use. If the device runs out of media while printing a document, it will not use media from a locked tray to complete the print job.
- **Default Tray:** Use this feature to determine the first tray from which the device draws media.

 **NOTE:** To use the tray lock and default tray settings, you must select the automatic tray selection option in the device software. If the device is on a network and you set a default tray, the setting will affect all users of the device.

Tray 2 is designed to hold only plain paper.

The following table lists possible ways you can use the tray settings to meet your printing needs.

I want to...	Follow these steps
Load both trays with the same media, and have the device pick media from one tray if the other one is empty.	<ul style="list-style-type: none"> • Load media in Tray 1 and Tray 2. For more information, see Load media. • Make sure tray lock is disabled.
Have both special media (such as transparencies or letterhead) and plain paper loaded in the trays.	<ul style="list-style-type: none"> • Load special media in Tray 1 and plain paper in Tray 2. • Make sure tray lock is set to Tray 1.
Load media in both trays but have the device pick media from a specific tray first.	<ul style="list-style-type: none"> • Load media in Tray 1 and Tray 2. • Make sure default tray is set to the appropriate tray.

To configure the trays

1. Make sure the device is turned on.
2. Perform one of the following:
 - **Embedded Web server:** Click the **Settings** tab and click **Paper Handling** in the left panel.
 - **Print driver (Windows):** Click the **Printer services** button on either the **Features** or **Color** tab, and then select **Paper Handling**.
 - **Toolbox (Windows):** Click the **Services** tab and click **Paper Handling**.
 - **HP Printer Utility (Mac OS):** Click **Paper Handling** from the **Printer Settings** panel.
 - **Control panel:** Press the **Setup** button, select **Preferences**, and then select **Default Tray** or **Tray Lock**.
3. Click **OK** or **Apply** after changing the desired tray settings.

Print on special and custom-sized media

- [To print on special or custom-sized media \(Windows\)](#)
- [To print on special or custom-sized media \(Mac OS\)](#)

To print on special or custom-sized media (Windows)

1. Load the appropriate media. For more information, see [Load media](#).
2. With a document open, click **Print** on the **File** menu, and then click **Setup**, **Properties**, or **Preferences**.
3. Click the **Paper/Features** tab.
4. Select the media size from the **Size is** drop-down list.

To set a custom media size:

- a. Click the **Custom** button.
 - b. Type a name for the new custom size.
 - c. In the **Width** and **Height** boxes, type the dimensions, and then click **Save**.
 - d. Click **OK** twice to close the properties or preferences dialog box. Open the dialog box again.
 - e. Select the new custom size.
5. To select the media type:
 - a. Click **More** in the **Type is** drop-down list.
 - b. Click the desired media type, and then click **OK**.
 6. Select the media source from the **Source is** drop-down list.
 7. Change any other settings, and then click **OK**.
 8. Print your document.

To print on special or custom-sized media (Mac OS)

1. Load the appropriate media. For more information, see [Load media](#).
2. On the **File** menu, click **Page Setup**.
3. Select the media size.

4. To set a custom media size:
 - a. Click **Manage Custom Sizes** in the **Paper Size** pull-down menu.
 - b. Click **New** and type a name for the size in the **Paper Size Name** box.
 - c. In the **Width** and **Height** boxes, type the dimensions and set the margins, if desired.
 - d. Click **Done** or **OK**, and then click **Save**.
5. On the **File** menu, click **Page Setup**, and then select the new custom size.
6. Click **OK**.
7. On the **File** menu, click **Print**.
8. Open the **Paper Handling** panel.
9. Under **Destination Paper Size**, click the **Scale to fit paper size** tab, and then select the customized paper size.
10. Change any other desired settings, and then click **OK** or **Print**.

Print borderless

Borderless printing lets you print to the edges of certain media types and a range of standard media sizes.



NOTE: Open the file in a software application and assign the image size. Make sure the size corresponds to the media size on which you are printing the image.

You can also gain access to this feature from the **Printing Shortcuts** tab. Open the printer driver, select the **Printing Shortcuts** tab, and select the printing shortcut for this print job drop-down list.

To print a borderless document (Windows)

1. Load the appropriate media. For more information, see [Load media](#).
2. Open the file that you want to print.
3. From the application, open the print driver:
 - a. Click **File**, and then click **Print**.
 - b. Click **Properties** or **Setup**.
4. Click the **Paper/Quality** tab.
5. Select the media size from the **Size is** drop-down list.
6. Select the **Borderless Printing** check box.
7. Select the media source from the **Source is** drop-down list.
8. Select the media type from the **Type is** drop-down list.
9. If you are printing photos, select **Best** from the **Print Quality** drop-down list. Alternatively, select **Maximum dpi**, which provides up to 4800 x 1200 optimized dpi* for optimum print quality.

*Up to 4800 x 1200 optimized dpi for color printing and 1200 input dpi. This setting might temporarily use a large amount of hard disk space (400 MB or more) and will print more slowly.
10. Change any other print settings, and then click **OK**.

11. Print the document.
12. If you printed on photo media with a tear-off tab, remove the tab to make the document completely borderless.

To print a borderless document (Mac OS)

1. Load the appropriate media. For more information, see [Load media](#).
2. Open the file that you want to print.
3. Click **File**, and then click **Page Setup**.
4. Select the borderless media size, and then click **OK**.
5. Click **File**, and then click **Print**.
6. Open the **Paper Type/Quality** panel.
7. Click the **Paper tab**, and then select the media type from the **Paper type** drop-down list.
8. If you are printing photos, select **Best** from the **Quality** drop-down list. Alternatively, select **Maximum** dpi, which provides up to 4800 x 1200 optimized dpi*.
*Up to 4800 x 1200 optimized dpi for color printing and 1200 input dpi. This setting might temporarily use a large amount of hard disk space (400 MB or more) and will print more slowly.
9. Select the media source. If you are printing on thick or photo media, select the manual feed option.
10. Change any other print settings, and then click **Print**.
11. If you printed on photo media with a tear-off tab, remove the tab to make the document completely borderless.

Set up speed-dial entries (some models only)

You can set up frequently used fax numbers and network folders as speed-dial entries. This lets you dial those numbers quickly by using the control panel. The first five entries for each of these destinations are associated with the five speed-dial buttons on the control panel.

Set up fax numbers as speed-dial entries or groups

You can store fax numbers or groups of fax numbers as speed-dial entries. Speed-dial entries 1 through 5 are associated with the corresponding five speed-dial buttons on the control panel.

For information about printing a list of the speed-dial entries that are set up, see [Print and view a list of speed-dial entries](#).

To set up speed-dial entries

- **Embedded Web server (network connection):** Open the embedded Web server, click the **Settings** tab, and then click **Fax Speed-dial** in the left pane.
 - To add an entry: Type the required information in the fields in the **Quick Add Fax Speed-Dial Entry** section.
 - To edit or remove an entry, in the **Fax Speed-dial Address Book** section, select the entry and click either the **Edit** or **Delete** icon.
 - Click **Apply** when you are finished.
- **HP Photosmart Software:** Open the HP Photosmart Software and follow the instructions in the onscreen Help.
- **HP Device Manager (Mac OS):** Launch **HP Device Manager**, click **Information and Settings**, and then select **Fax Speed Dial Settings** from the drop-down list.
- **Control panel:** Press **Setup**, and then select the **Speed Dial Setup** option.
 - To add or change an entry: Select **Individual Speed Dial** or **Group Speed Dial** and press the arrow keys to move to an unused entry number, or type a number on the keypad. Type the fax number, and then press **OK**. Include any pauses or other required numbers, such as an area code, an access code for numbers outside a PBX system (usually a 9 or 0), or a long-distance prefix. Type the name, and then press **OK**.
 - To delete one entry or all entries: Select **Delete Speed Dial**, press the arrow keys to highlight the speed-dial entry that you want to delete, and then press **OK**.

To set up a speed-dial group

If you send information to the same group of fax numbers on a regular basis, you can set up a speed-dial entry for a group in order to simplify the task. The speed-dial entry for a group can be associated with a speed-dial button on the control panel.

A group member must be a member of the speed-dial list before you can add the member to a speed-dial group. You can add up to 20 fax numbers to each group (with up to 50 characters for each fax number).

- **Embedded Web server (network connection):** Open the embedded Web server, click the **Settings** tab, and then click **Fax Speed-dial** in the left pane. Click the link that contains the number for the entry (for example, **26-50**) in the **Fax Speed-dial Address Book**.
 - To add a group, in the **Fax Speed-dial Address Book**, click the **New Group** button, and then select the individual entries from the selection. Enter the appropriate group information and click **Apply**.
 - To edit or remove an entry, in the **Fax Speed-dial Address Book**, select the entry and click either the **Edit** or **Delete** icon.
 - To delete a group: Select the entries and click the **Delete** button.
 - Click **Apply** when you are finished.
- **HP Photosmart Software:** Open the HP Photosmart Software and follow the instructions in the onscreen Help.

- **HP Device Manager (Mac OS):** Launch **HP Device Manager**, click **Information and Settings**, and then select **Fax Speed Dial Settings** from the drop-down list.
- **Control panel:** Press the **Setup** button, and then select the **Speed Dial Setup** option.
 - To add a group: Select **Group Speed Dial**, select an unassigned speed-dial entry, and then press **OK**. Use the arrow keys to highlight a speed-dial entry, and then press **OK** to select it (a check mark appears next to the speed-dial entry). Repeat this step to add additional speed-dial entries to this group. When finished, select the **Done Selecting** option, and then press **OK**. Use the onscreen keyboard to enter a group speed-dial name, and then select **Done**.
 - To add entries to a group: Select **Group Speed Dial**, select the group speed-dial entry that you want to change, and then press **OK**. Use the arrow keys to highlight a speed-dial entry, and then press **OK** to select it (a check mark appears next to the speed-dial entry). Repeat this step to add additional speed-dial entries to this group. When finished, select the **Done Selecting** option, and then press **OK**. Select **Done** at the **Group Name** screen.
 - To delete an entry from a group: Select **Group Speed Dial**, select the group speed-dial entry that you want to change, and then press **OK**. Use the arrow keys to highlight a speed-dial entry, and then press **OK** to select it (the check mark is removed from the speed-dial entry). Repeat this step to remove additional speed-dial entries from this group. When finished, select the **Done Selecting** option, and then press **OK**. Select **Done** at the **Group Name** screen.
 - To delete a group: Select **Delete Speed Dial**, press the arrow keys to highlight the speed-dial entry that you want to delete, and then press **OK**.

Set up network folders as speed-dial entries (some models)

You can store up to ten network folders as speed-dial entries. Five entries are associated with the corresponding five speed-dial buttons on the control panel. You cannot set up group speed-dial entries. The Direct Digital Filing Speed-dial allows you to create folders to scan and store digital documents for speed-dial sending. Use the Friendly Name, Network Path, User Name, Password and Optional PIN fields to add a new Direct Digital Filing speed-dial entry.

For information about printing a list of the speed-dial entries that are set up, see [Print and view a list of speed-dial entries](#).

To set up speed-dial entries

Embedded Web server (network connection): Open the embedded Web server, click the **Settings** tab, and then click **Direct Digital Filing Speed-dial** in the left pane.

- To add or change an entry: Select an entry in the **Direct Digital Filing Speed-dial Address Book**, click the **Edit** button, make necessary changes, and then click **Apply**.
- To delete an entry: Select the entry and then click the **Delete** button.
- Click **Apply** when you are finished.

Print and view a list of speed-dial entries

You can print or view a list of all of the speed-dial entries that have been set up. Each entry in the list contains the following information:

- Speed-dial number (the first five entries correspond to the five speed-dial buttons on the control panel)
- Name associated with the fax number or group of fax numbers
- For the fax speed-dial list, the fax number (or all of the fax numbers for a group)
- For the network folder list, the folder path name

To print a list of speed-dial entries

Embedded Web server: Select the **Settings** tab, select **Fax Speed-dial** from the left pane, and then print the **Fax Speed-dial Address Book** page from your browser.

To view a list of speed-dial entries

- **Embedded Web server (network connection):** Open the embedded Web server, click the **Settings** tab, and then click **Fax Speed-dial** in the left pane.
- **HP Device Manager (Mac OS):** Launch **HP Device Manager**, click **Information and Settings**, and then select **Fax Speed Dial Settings** from the drop-down list.
- **HP Photosmart Software:** Open the HP Photosmart Software and follow the instructions in the onscreen Help.

4 Print

This section contains the following topics:

- [Change print settings](#)
- [Print on both sides \(duplexing\)](#)
- [Cancel a print job](#)

Change print settings

You can change print settings (such as paper size or type) from an application or the printer driver. Changes made from an application take precedence over changes made from the printer driver. However, after the application is closed, the settings return to the defaults configured in the driver.



NOTE: To set print settings for all print jobs, make the changes in the printer driver.

For more information about the features of the Windows printer driver, see the online help for the driver. For more information about printing from a specific application, see the documentation that came with the application.

To change settings from an application for current jobs (Windows)

1. Open the document that you want to print.
2. On the **File** menu, click **Print**, and then click **Setup**, **Properties**, or **Preferences**. (Specific options may vary depending on the application that you are using.)
3. Change the settings that you want, and then click **OK**, **Print**, or a similar command.

To change default settings for all future jobs (Windows)

1. Click **Start**, point to **Settings**, and then click **Printers** or **Printers and Faxes**.
- Or -
Click **Start**, click **Control Panel**, and then double-click **Printers**.
2. Right-click the printer icon, and then click **Properties**, **Document Defaults**, or **Printing Preferences**.
3. Change the settings that you want, and then click **OK**.

To change settings (Mac OS)

1. On the **File** menu, click **Page Setup**.
2. Change the settings that you want (such as paper size), and then click **OK**.
3. On the **File** menu, click **Print** to open the print driver.
4. Change the settings that you want (such as media type), and then click **OK** or **Print**.

Print on both sides (duplexing)

You can print on both sides of a sheet of media, either automatically by using the optional automatic two-sided printing accessory (duplexer), or manually by turning the media over and feeding it into the device again.

- [Guidelines for printing on both sides of a page](#)
- [To perform duplexing \(Windows\)](#)
- [To perform automatic duplexing \(Mac OS\)](#)

Guidelines for printing on both sides of a page

- Always use media that conforms to the device specifications. For more information, see [Understand specifications for supported media](#).
- Specify duplex options in your application or in the printer driver.
- Do not print on both sides of transparencies, envelopes, photo paper, glossy media, or paper lighter than 16 lb bond (60 g/m²) or heavier than 28 lb bond (105 g/m²). Jams might occur with these media types.
- Several kinds of media require a specific orientation when you print on both sides of a page, such as letterhead, preprinted paper, and paper with watermarks and prepunched holes. When you print from a computer running Windows, the device prints the first side of the media first. When you print from a computer using the Mac OS, the device prints the second side first. Load the media with the front side facing down.
- For auto-duplexing, when printing finishes on one side of the media, the device holds the media and pauses while the ink dries. Once the ink dries, the media is pulled back into the device and the second side is printed. When printing is complete, the media is dropped onto the output tray. Do not grab it before printing is complete.
- You can print on both sides of supported custom-sized media by turning the media over and feeding it into the device again. For more information, see [Understand specifications for supported media](#).

To perform duplexing (Windows)

1. Load the appropriate media. For more information, see [Guidelines for printing on both sides of a page](#) and [Load media](#).
2. Make sure the duplexer is properly installed. For more information, see [Install the duplexer](#).
3. With a document open, click **Print** on the **File** menu, and then click **Setup**, **Properties**, or **Preferences**.
4. Click the **Features** tab.
5. Select the **Two-sided printing** drop-down list. For auto-duplexing, ensure that **Automatic** is selected.
6. To automatically resize each page to match the document's onscreen layout, ensure **Preserve Layout** is selected. Clearing this option might result in unwanted page breaks.
7. Select or clear the **Flip Pages Up** check box depending on which way you want the binding. See the graphics in the print driver for examples.

8. Choose a booklet layout from the **Booklet Layout** drop-down list, if you want.
9. Change any other settings, and then click **OK**.
10. Print your document.

To perform automatic duplexing (Mac OS)

1. Load the appropriate media. For more information, see [Guidelines for printing on both sides of a page](#) and [Load media](#).
2. Make sure the duplexer is properly installed. For more information, see [Install the duplexer](#).
3. On the **File** menu, click **Print**.
4. Open the **Two-Sided Printing** panel.
5. Select the option to print on both sides.
6. Select the binding orientation by clicking the appropriate icon.
7. Change any other settings, and then click **Print**.

Cancel a print job

You can cancel a print job using one of the following methods.

Control panel: Press **X** (**Cancel** button). This clears the job that the device is currently processing. It does not affect jobs waiting to be processed.

Windows: Double-click the printer icon that appears in the lower-right corner of the computer screen. Select the print job, and then press the **Delete** key on the keyboard.

Mac OS: Double-click the printer in the **Printer Setup Utility**. Select the print job, click **Hold**, and then click **Delete**.

5 Copy

You can produce high-quality color and grayscale copies on a variety of paper types and sizes.

This section contains the following topics:

- [Make copies from the control panel](#)
- [Change the copy settings](#)
- [Crop an original \(color display models only\)](#)
- [Cancel a copy job](#)

Make copies from the control panel

You can make quality copies from the control panel.

To make a copy from the control panel

1. Make sure you have paper loaded in the input tray.
2. Load your original using the scanner glass or the ADF. For more information, see [Load the originals](#)
3. Do one of the following:
 - Press **START COPY Black** to start a black-and-white copy job.
 - Press **START COPY Color** to start a color copy job.



NOTE: If you have a color original, pressing **START COPY Black** produces a black-and-white copy of the color original, while pressing **START COPY Color** produces a full-color copy of the color original.

Change the copy settings

You can customize the copy settings to handle nearly any task.

When you change copy settings, the changes are for the current copy job only. You must set the changes as defaults for the settings to apply to all future copy jobs.

To save the current settings as defaults for future jobs

1. Make any necessary changes to the settings in the **Copy Menu**.
2. Press **Copy Menu**, and then press the arrow keys until **Set New Defaults** appears.
3. Press the arrow keys to select **Yes**, and then press **OK**.

Crop an original (color display models only)

Before copying an original, you might want to select an area to copy using the **Crop** setting from the **Copy Menu**. Selecting the **Crop** setting starts a scan and shows a preview of the original on the color display.

Cropping changes the dimensions of the image, thus decreasing its physical size.

 **TIP:** You can resize the cropped image by changing the **Reduce/Enlarge** setting. Use **Fit to Page** to make a copy with borders. Enlarging a cropped image might affect print quality depending on the resolution of the image.

To crop an image from the control panel

1. In the Copy area, press **Copy Menu** and then select **Crop**.
2. Use the arrow buttons to set the position of the upper-left corner of the crop area.
3. Press **OK**.
4. Use the arrow buttons to set the position of the lower-right corner of the crop area.
5. Press **OK**.
The cropped image is displayed on the color graphics display.

Cancel a copy job

- ▲ To stop copying, press **Cancel** on the control panel.

6 Scan

You can scan originals and send them to a variety of destinations, such as a folder on the network or a program on a computer. You can use the control panel, the HP photo and imaging software, and TWAIN-compliant or WIA-compliant programs on a computer.

This section contains the following topics:

- [Scan an original](#)
- [Use Webscan via embedded Web server](#)
- [Scan from a TWAIN-compliant or a WIA-compliant program](#)
- [Edit a scanned original](#)
- [Change scan settings](#)
- [Cancel a scan job](#)

Scan an original

You can start a scan from a computer or from the control panel. This section explains how to scan from the control panel only.

 **NOTE:** You can also use the HP Photosmart Software to scan an image, including panorama images. Using this software, you can edit a scanned image and create special projects using a scanned image. For information about how to scan from the computer, and how to adjust, resize, rotate, crop, and sharpen your scans, see the onscreen HP Photosmart Software Help that came with your software.

To use the scan features, your device and computer must be connected and turned on. The printer software must also be installed and running on your computer prior to scanning. To verify that the printer software is running on a computer running Windows, look for the device icon in the system tray at the lower-right side of the screen, near the clock. To verify this on a computer using the Mac OS, open the HP Device Manager, and click **Scan Picture**. If a scanner is available, it will launch the HP ScanPro application. If it is not available, a message appears to let you know that a scanner was not found.

 **NOTE:** Closing the HP Digital Imaging Monitor icon in your Windows system tray can cause your device to lose some of its scan functionality and result in the **No Connection** error message. If this happens, you can restore full functionality by restarting your computer or by starting the HP Photosmart Software.

Set up Direct Digital Filing (some models only)

Direct Digital Filing is a feature that allows you to scan and save a document to a folder and share documents with other people on your network. You can set up Direct Digital Filing speed-dial by using the embedded Web server on your computer.

 **NOTE:** The implementation of Direct Digital Filing requires a basic understanding of networking concepts. Setup of these features should be completed by users with some networking experience.

To set up a network folder

- ▲ Create a folder on your network. This folder is used to store files that are scanned by using the Direct Digital Filing feature.

 **NOTE:** Make sure that all of the people using the network folder have permission to access the folder, including the ability to write and change the contents of the folder. To change the permissions for folders, see the documentation available for your operating system.

To set up a speed-dial entry

1. Open a Web browser and type in the IP Address that is assigned to the device. For example, if the IP address is 123.123.123.123, type the following address into the Web browser: `http://123.123.123.123`

 **NOTE:** The printer must be connected to the network. The IP address of the device can be obtained from the control panel.

2. Click the **Settings** tab.
3. Under **Address Book**, click **Direct Digital Filing Speed-dial**.
4. Enter the information for the speed-dial entry, and then modify any scan settings that you want to change.

 **NOTE:** You can also add a personal identification number (PIN) to help prevent unauthorized people from using this speed-dial. After the PIN is set, the device control panel prompts for the PIN whenever the speed-dial is used. To disable the PIN, leave the PIN field blank.

5. Click **Add**. The entry is added to the Direct Digital Filing Speed-dial Address Book.

Scan an original to a network folder

You can scan originals directly into a network folder without any computer-based software. The shared folder can reside on a file server or on any computer on your network.

Before using this feature, you must set up a folder location in the Direct Digital Filing Speed-dial address book by using the embedded Web server (EWS) as described in

the previous section. For more information, also see [Set up network folders as speed-dial entries \(some models\)](#) or the Getting Started Guide that came with the device.

To send a scan to a network folder

1. Load the original on the scanner glass or in the automatic document feeder (ADF). For more information, see [Load the originals](#).
2. Press **Digital Filing**, and then do one of the following:
 - Select a destination from the speed-dial entries on the display.
 - Select a destination by pressing one of the five speed-dial buttons on the display.



NOTE: If a PIN has been set up for the speed-dial entry, you must enter your PIN before continuing.

3. Press **START SCAN**.



NOTE: The connection might take some time, depending on network traffic and connection speed.

Scan an original to a program on a computer (direct connection)

Use the following steps if your device is directly connected to a computer via a USB cable.

When the scan is complete, the program that you have selected opens and displays the document that you have scanned.

To send a scan to a program on a computer from the HP photo and imaging software

1. At the computer, open the HP photo and imaging software. For more information, see [Use the HP photo and imaging software](#).
2. See the onscreen Help for further instructions.

To send a scan to a program on a computer from the control panel (direct connect)

1. Load the original on the scanner glass or in the ADF. For more information, see [Load the originals](#).
2. Press the **Scan Menu** or **Scan To** button.
3. Press the arrow keys to select the program that you want to use (such as the HP photo and imaging software), and then press **OK**.
4. Press **START SCAN**.

To send a scan to a program on a computer from the control panel (network connection)

1. Load the original on the scanner glass or in the ADF. For more information, see [Load the originals](#).
2. Press the **Scan Menu** or **Scan To** button.
3. Select **Select Computer**.

4. Select a computer name from the list of available computers, and then press **OK**.
5. Press the arrow keys to select the program that you want to use (such as the HP photo and imaging software).
6. Press **OK** or **START SCAN**.

Scan an original to a memory device

You can send the scanned image as a JPEG image or a PDF file to the memory card that is currently inserted, or to a storage device that is currently attached to the front USB port. You also have other scanning options including quality and paper size settings.

To scan to a memory device

1. Load your original print-side down in the right-front corner of the glass or in the ADF.
2. Insert the memory device.
3. Press **START SCAN**.
 - The **Scan Menu** appears, listing various options or destinations. The default destination is whichever one you selected the last time you used this menu.
 - If your device is directly connected to your computer, the **Scan To** menu appears.
4. Press the arrow keys to highlight **Memory Device**, and then press **OK**.

The device scans the image and saves the file to the memory card or storage device.

Use Webscan via embedded Web server

Webscan is a feature of the embedded Web server that lets you scan photos and documents from your device to your computer using a Web browser. This feature is available even if you did not install the device software on your computer.

- ▲ Click the **Information** tab, click **Webscan** in the left pane, make selections for **Image Type** and **Document Size**, and then click **Scan** or **Preview**.

For more information on the embedded Web server, see [Embedded Web server](#).

Scan from a TWAIN-compliant or a WIA-compliant program

The device is TWAIN-compliant and WIA-compliant and works with programs that support TWAIN-compliant and WIA-compliant scanning devices. While you are in a TWAIN-compliant or WIA-compliant program, you can gain access to the scanning feature and scan an image directly into the program.

TWAIN is supported for all Windows and Mac OS operating systems, for both network connections and direct connections.

For Windows operating systems, WIA is supported only for Windows XP direct connections. It is not supported for the Mac OS.

To scan from a TWAIN-compliant program

Generally, a software program is TWAIN-compliant if it has a command such as **Acquire**, **File Acquire**, **Scan**, **Import New Object**, **Insert from**, or **Scanner**. If you are unsure whether the program is compliant or you do not know what the command is called, see the software program Help or documentation.

Start the scan from within the TWAIN-compliant program. See the software program Help or documentation for information about the commands and steps to use.

 **NOTE:** If you start a TWAIN scan while a fax is being received, an error message will be displayed and the scan is not performed. Wait until the fax has been received and then restart the scan.

To scan from a WIA-compliant program

Generally, a software program is WIA-compliant if it has a command such as **Picture/From Scanner or Camera** in the **Insert** or **File** menu. If you are unsure whether the program is compliant or you do not know what the command is called, see the software program Help or documentation.

Start the scan from within the WIA-compliant program. See the software program Help or documentation for information about the commands and steps to use.

Edit a scanned original

You can edit a scanned image using the HP Photosmart Software. You can also edit a scanned document by using your Optical Character Recognition (OCR) software.

Edit a scanned photo or graphic

You can edit a scanned photo or graphic using the HP Photosmart Software. Use this software to adjust the brightness, contrast, color saturation, and more. You can also rotate the image using the HP Photosmart Software.

For more information, see the onscreen HP Photosmart Software Help.

Edit a scanned document using optical character recognition (OCR) software

You can use OCR software to import scanned text into your preferred word-processing program for editing. This allows you to edit faxes, letters, newspaper clippings, and many other documents.

You can specify the word-processing program that you want to use for editing. If the word-processing icon is not present or active, either you do not have word-processing software installed on your computer, or the scanner software did not recognize the program during the installation. See the onscreen Help for the HP photo and imaging software for information about how to create a link to the word-processing program.

The OCR software does not support scanning colored text. Colored text is always converted to black-and-white text before being sent to OCR. Thus, all text in the final document is in black and white, regardless of the original color.

Because of the complexity of some word-processing programs and their interaction with the device, it is sometimes preferable to scan to Wordpad (a Windows

accessory), and then cut and paste the text into the preferred word-processing program.

Change scan settings

To change scan settings

- **HP Device Manager (Mac OS):** Launch **HP Device Manager**, click **Information and Settings**, and then select **Scan Preferences** from the drop-down list.
- **Windows:** Open the device software, select **Settings**, select **Scan Settings and Preferences**, then select from the available options and make your selections.

Cancel a scan job

- ▲ Press **Cancel** on the control panel.

7 Work with memory devices (some models only)

The device comes with a memory card reader that can read several types of digital camera memory cards. You can use the device to save photos from these memory cards. You can also print a proof sheet, which shows thumbnail views of photos that are stored on a memory card.

This section contains the following topics:

- [Insert a memory card](#)
- [Connect a digital camera](#)
- [Connect a storage device](#)
- [View photos](#)
- [Print photos from the control panel](#)
- [Save photos to your computer](#)

Insert a memory card

If your digital camera uses a memory card to store photos, you can insert the memory card into the device to print or save your photos.

△ **CAUTION:** Attempting to remove a memory card while it is being accessed can damage files on the card. You can safely remove a card only when the photo light is not blinking. Also, never insert more than one memory card at a time as this can also damage files on the memory cards.

The device supports the memory cards described below. Each type of memory card can only be inserted in the appropriate slot for that card.

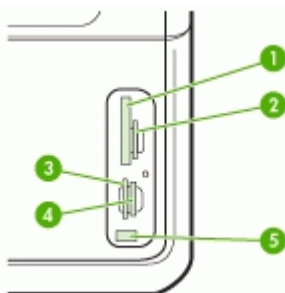

1	CompactFlash (types I and II)
2	Secure Digital, MultimediaCard (MMC), Secure MMC
3	xD
4	Memory Stick, MagicGate Memory Stick, Memory Stick Duo, and Memory Stick Pro

(continued)

5	Front universal serial bus (USB) port (PictBridge-enabled)
---	------------------------------------------------------------

To insert a memory card

1. Turn the memory card so that the label faces left, and the contacts are facing the device.
2. Insert the memory card into the corresponding memory card slot.

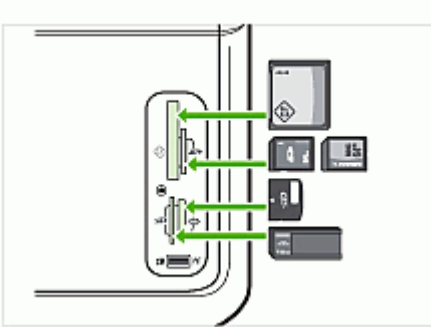

Connect a digital camera

The PictBridge-enabled front USB port is located beneath the memory card slots.

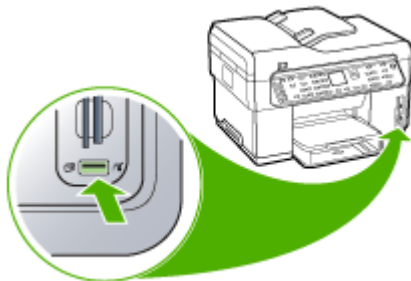

 **NOTE:** If your USB device does not fit into this port due to size limitations, or if the connector on the device is shorter than 11 millimeters, you will need to purchase a USB extension cable in order to use your device with this port.

Camera-selected photos are photos you marked for printing with your digital camera. Depending on your camera, the camera might identify page layout, number of copies, rotation, and other print settings.

The device supports two industry-standard formats, PictBridge and Digital Print Order Format (DPOF) file format 1.1, so you do not have to reselect the photos to print.

- The **PictBridge** standard saves the print instructions on the camera itself. In order to print photos using PictBridge, you need to put the camera into PictBridge mode, and then plug the camera into the front USB port of the device with a USB cable.
- The **DPOF** standard saves the print instructions as a file on your memory card. In order to print photos from a DPOF file, you need to remove the memory card from your camera and then insert the memory card into the appropriate slot on the device.

When you print camera-selected photos, the device print settings do not apply; the PictBridge or DPOF settings for page layout and number of copies override those of the device.

 **NOTE:** Not all digital cameras enable you to tag your photos for printing. See the documentation that came with your digital camera to see if your camera supports the PictBridge standard or DPOF file format 1.1.

To print camera-selected photos using the PictBridge standard

1. Connect your digital camera to the front USB port on the device using the USB cable supplied with your camera.
2. Turn on your camera and make sure it is in PictBridge mode.

 **NOTE:** Check your camera documentation to verify how to change the USB mode to PictBridge. Different cameras use different terms to describe PictBridge mode. For instance, some cameras have a **digital camera** setting and a **disk drive** setting. In this instance, the **digital camera** setting is the PictBridge mode setting.

To print camera-selected photos using the DPOF standard

1. Insert your memory card into the appropriate slot on the device.
2. When prompted, do one of the following:
 - Press **OK** to print all DPOF-tagged photos.
The device prints all DPOF-tagged photos.
 - Press the arrow keys to highlight **No**, and then press **OK**.
This bypasses DPOF printing.

Connect a storage device

You can connect a storage device such as a keychain drive, portable hard drive, or a digital camera in storage mode to the front USB port. The front USB port is located beneath the memory card slots.

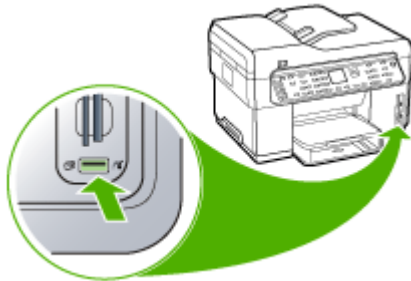

NOTE: Digital cameras that are in storage mode can be attached to the front USB port. The device treats cameras that are in this mode as a normal storage device. Digital cameras in storage mode are referred to as storage devices throughout this section.

If your USB device does not fit into this port due to size limitations, or if the connector on the device is shorter than 11 millimeters, you will need to purchase a USB extension cable in order to use your device with this port. For more information on supported USB devices, see [Supported devices](#).

Check your camera documentation to verify how to change the USB mode to storage mode. Different cameras use different terms to describe the storage mode. For instance, some cameras have a **digital camera** setting and a **disk drive** setting. In this instance, the **disk drive** setting is the storage mode setting. If storage mode does not work on your camera, you might need to upgrade the camera firmware. For more information, see the documentation that came with the camera.

Once you have connected the storage device, you can do the following with the files that are stored on your storage device:

- Transfer the files to your computer
- View photos (color display only)
- Edit photos using the control panel (color display only)
- Print photos

CAUTION: Never attempt to disconnect a storage device while it is being accessed. Doing so can damage files on the storage device. You can safely remove a storage device only when the status light next to the memory card slots is not blinking.

View photos

You can view photos on the color display of your device. You can also view photos using the HP Photosmart Software.

View photos (color display models only)

You can view and select photos on the color display of your device.

To view a photo

1. Insert the memory card into the appropriate slot on your device, or connect a storage device to the front USB port.
2. Press **Photo Menu**.
The **Photosmart Express** menu appears. By default, **View & Print** is highlighted.
3. Press the arrow keys until the photo you want to view appears on the color display.

 **TIP:** You can press and hold down the arrow keys to quickly navigate through all photos.

View photos using your computer

You can view and edit photos using the HP Photosmart Software that came with your device.

For more information, see the onscreen HP Photosmart Software Help.

Print photos from the control panel

The device enables you to print photos directly from your memory card or storage device without first transferring the files to a computer. You can print borderless photos (one per sheet of paper) or you can print multiple photos on a single sheet of paper.

This section contains the following topics:

- [Print photos using a proof sheet](#)
- [Print panoramic photos](#)
- [Print passport photos](#)
- [Print video action photos](#)

Print photos using a proof sheet

A proof sheet is a simple and convenient way to select photos and make prints directly from a memory card or storage device without a computer. A proof sheet (which might be several pages long) shows thumbnail views of the stored photos. The file name, index number, and date appear under each thumbnail.

Proof sheets are also a quick way to create a printed catalog of your photos.



 **NOTE:** From the device, you can only access JPEG and TIFF image files. To print other types of files, transfer the files from your memory card or storage device to your computer and use the HP Photosmart Software.

Printing photos from a proof sheet requires three steps:

- Print a proof sheet of the photos on your memory card or storage device
- Complete the proof sheet
- Scan the proof sheet

To print a proof sheet

1. Insert a memory card into the appropriate slot on the device, or connect a storage device to the front USB port.
2. Choose the appropriate display:

For color display models

- a. Press the **Photo Menu** button, and then select **View & Print**.
When you press **OK**, the most recent photo appears on the display.
- b. Press **OK** to display the Print Menu.
- c. Press the arrow keys to select **Projects**.
- d. Press the arrow keys to select **Proof Sheet**.
- e. Press the arrow keys to select **Print Proof Sheet**, and then press **OK**.
- f. Press the arrow keys to select the appropriate **Paper Size** and **Paper Type**.

For two-line display models

- a. Press the **Photo Menu** button.
A message displays with the number of files found on the card or storage device.
- b. Press the **Proof Sheet** button, press the arrow keys to select **Print**, and then press **OK**.

To complete a proof sheet

1. Select the photos to print by using a dark pen or pencil to fill in the circles located under the thumbnail images on the proof sheet. If you want to print more than one copy of a photo, fill in the second or third circle. You can print up to three copies of each selected photo.

 **TIP:** If you want to print all the photos on the memory card, fill in the **Select All Photos** circle below the layout options in step 2 of the proof sheet. One copy of each photo prints.

2. Select one layout style by filling in a circle in step 2 of the proof sheet.

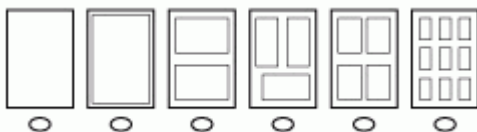

 **NOTE:** If you need more control over print settings than the proof sheet provides, you can print photos directly from the control panel.

3. (Optional) If you want to print a date/time stamp on your photos, fill in the **Date Stamp** circle below the layout options in step 2 of the proof sheet.

To scan a completed proof sheet

1. Load the proof sheet print-side down on the right-front corner of the glass. Make sure the sides of the proof sheet touch the right and front edges. Close the lid.



2. Make sure the same memory card or storage device you used to print the proof sheet is still inserted in the device when you scan that proof sheet.
3. Make sure you have photo media loaded into the device.

4. Press the **Photo Menu** button.
5. Choose the appropriate display:

For color display models

- a. Press the arrow keys to select **View & Print**, and then press **OK**.
- b. Press the arrow keys to select **Projects**, and then select **Proof Sheet**.
- c. Press the arrow keys to select **Scan Proof Sheet**, and then press **OK**.
- d. When prompted, select the paper size and paper type, and then press **OK**.

For two-line display models

- ▲ Press the **Proof Sheet** button, press the arrow keys to select **Scan**, and then press **OK**.

The device scans the proof sheet and prints the selected photos.

Print panoramic photos

The device enables you to select multiple panoramic photos from your memory card or storage device and print them.

 **NOTE:** The device will not stitch multiple photos together to create a panoramic photo, you must use another software application, such as HP Photosmart software.

To print a panoramic photo

1. Insert a memory card into the appropriate slot on the device, or connect a storage device to the front USB port.
2. Press **Photo Menu**.
The **Photosmart Express** menu appears. By default, **View & Print** is highlighted.
3. Press **OK** to select **View & Print**.
When you press **OK**, the most recent photo appears on the display.
4. Press the arrow keys to scroll through the photos on your memory card or storage device.
5. When the photo you want to print appears, press **OK**.
The **Print** menu appears.
6. Press the arrow keys to highlight **Projects**, and then press **OK**.
The **Projects** menu appears.
7. Press the arrow keys to highlight **Panorama Prints**, and then press **OK**.
8. When prompted, load 10 x 30 cm (4 x 12 inch) panorama photo paper in the input tray, and then press **OK**.
When you press **OK**, the selected photo reappears.
9. (Optional) Change print settings or select additional photos to print.

To print more than one copy of the selected photo

- a. Press **OK** to display the selection menu.
- b. Press the arrow keys to highlight **Number of Copies**, and then press **OK**.
- c. Press the arrow keys to increase or decrease the number of copies, and then press **OK**.

To edit the selected photo before printing

- a. Press **OK** to display the selection menu.
- b. Press the arrow keys to highlight **Edit**, and then press **OK**.

To select additional photos for printing

- a. Press the arrow keys to scroll through the photos on your memory card or storage device.
 - b. When the photo you want to print appears, press **OK**.
 - c. Press **OK** to select **Select to Print**.
 - d. Repeat these steps for each photo you want to print.
10. When you are done changing print settings and selecting photos, press **OK** to display the selection menu.
 11. Press the arrow keys to highlight **Done Selecting**, and then press **OK**.
The **Print Summary** screen appears.
 12. Press the arrow keys to highlight one of the following options, and then press **OK**.

Print Options	Enables you to manually specify the type of paper on which you are printing and whether you want to print a date and time stamp on your photo. By default, the Date Stamp setting is set to Off . If you want, you can change the default of this setting with the Set New Defaults option.
Print Preview (color display only)	Displays a preview of what your printed page will look like. This enables you to verify your settings before printing and wasting paper and ink on potential mistakes.
Print Now	Prints your photos with the size and layout you selected.

Print passport photos

You can print your own passport-size photos from your memory card or storage device. If you have questions on guidelines or restrictions for passport photos, contact a local passport service agency.

To print passport photos

1. Insert a memory card into the appropriate slot on the device, or connect a storage device to the front USB port.
The **Photosmart Express** menu appears. By default, **View & Print** is highlighted.
2. Press **OK** to select **View & Print**.
When you press **OK**, the most recent photo appears on the display.
3. Press the arrow keys to scroll through the photos on your memory card or storage device.
4. When the photo you want to print appears, press **OK**.
The **Print** menu appears.
5. Press the arrow keys to highlight **Projects**, and then press **OK**.
The **Projects** menu appears.
6. Press the arrow keys to highlight **Passport Photos**, and then press **OK**.

7. Press the arrow keys to highlight the size you want to print, and then press **OK**. When you press **OK**, the selected photo reappears.
8. (Optional) Change print settings or select additional photos to print.

To print more than one copy of the selected photo

- a. Press **OK** to display the selection menu.
- b. Press the arrow keys to highlight **Number of Copies**, and then press **OK**.
- c. Press the arrow keys to increase or decrease the number of copies, and then press **OK**.

To edit the selected photo before printing

- a. Press **OK** to display the selection menu.
- b. Press the arrow keys to highlight **Edit**, and then press **OK**.

To select additional photos for printing

- a. Press the arrow keys to scroll through the photos on your memory card or storage device.
 - b. When the photo you want to print appears, press **OK**.
 - c. Press **OK** to select **Select to Print**.
 - d. Repeat these steps for each photo you want to print.
9. When you are done changing print settings and selecting photos, press **OK** to display the selection menu.
 10. Press the arrow keys to highlight **Done Selecting**, and then press **OK**. The **Print Summary** screen appears.
 11. Press the arrow keys to highlight one of the following options, and then press **OK**.

Print Options	Enables you to manually specify the type of paper on which you are printing and whether you want to print a date and time stamp on your photo. By default, the Paper Type is set to Plain and the Date Stamp setting is set to Off . If you want, you can change the defaults of these settings with the Set New Defaults option.
Print Preview (color display only)	Displays a preview of what your printed page will look like. This enables you to verify your settings before printing and wasting paper and ink on potential mistakes.
Print Now	Prints your photos with the size and layout you selected.

Print video action photos

You can use the **Video Action Prints** option to print a sequence of photos from a video file on a memory card or a storage device. This option prints nine frames of a

video on one sheet of paper in the order that they appear in the video. The video frames are automatically selected by your device.

To create video action prints

1. Insert a memory card into the appropriate slot on the device, or connect a storage device to the front USB port.
The **Photosmart Express** menu appears. By default, **View & Print** is highlighted.
2. Press **OK** to select **View & Print**.
When you press **OK**, the most recent photo appears on the display.
3. Press the arrow keys to scroll through the photos and videos on your memory card or storage device.
4. When the video you want to print appears, press **OK**.
The **Print** menu appears.
5. Press the arrow keys to highlight **Projects**, and then press **OK**.
The **Projects** menu appears.
6. Press the arrow keys to highlight **Video Action Prints**, and then press **OK**.
7. Press the arrow keys to highlight the size you want to print, and then press **OK**.
8. Press the arrow keys to highlight the type of paper you are printing on, and then press **OK**.
9. The video reappears, press **OK** to continue.
10. (Optional) Edit the video or print the video.

To edit the selected photo before printing

- a. Press **OK** to display the selection menu.
- b. Press the arrow keys to highlight **Edit**, and then press **OK**.

To print now

- ▲ Select **Print Now**, press **OK**.

Save photos to your computer

After you take photos with your digital camera, you can print them immediately or save them to your computer. To save the photos to your computer, remove the memory card from your digital camera and insert it in the appropriate memory card slot on the device.

You can also save photos from a storage device (such as a digital camera or keychain drive) by plugging the device into the front USB port on the device.

To save photos

1. Insert a memory card into the appropriate slot on the device, or connect a storage device to the front USB port.
2. Press **Photo Menu**.
3. Choose the appropriate display:

For color display models

- a. Press the arrow keys and select **Save**.
- b. Press the arrow keys and select **Transfer to computer**, and then select the name of your computer.
- c. Follow the onscreen prompts on your computer to save the photos to your computer.

For two-line display models

- a. Press the arrow keys and select **Photo Transfer**, and then press **OK**.
- b. Press the arrow keys and select **Yes**.
- c. Press the arrow keys and select **Transfer to computer**, and then select the name of your computer.
- d. Follow the onscreen prompts on your computer to save the photos to your computer.

8 Fax (some models only)

You can use the device to send and receive faxes, including color faxes. You can schedule faxes to be sent at a later time and set up speed-dials to send faxes quickly and easily to frequently used numbers. From the control panel, you can also set a number of fax options, such as resolution and the contrast between lightness and darkness on the faxes you send.

If the device is directly connected to a computer, you can use the HP photo and imaging software to perform fax procedures that are not available from the control panel. For more information about using the HP photo and imaging software, see [Use the HP photo and imaging software](#).

 **NOTE:** Before you begin faxing, make sure you have set up the device properly for faxing. You might have already done this as part of the initial setup, by using either the control panel or the software that came with the device. You can verify the fax is set up correctly by running the fax setup test from the control panel. To run the fax test, press **Setup**, select **Tools**, select **Run fax test**, and then press **OK**.

This section contains the following topics:

- [Send a fax](#)
- [Receive a fax](#)
- [Change fax settings](#)
- [Fax over the Internet](#)
- [Test fax setup](#)
- [Use reports](#)
- [Cancel a fax](#)

Send a fax

You can send a fax in a variety of ways. Using the control panel, you can send a black-and-white or color fax. You can also send a fax manually from an attached phone. This allows you to speak with the recipient before sending the fax.

Send a basic fax

You can easily send a single- or multiple-page black-and-white fax by using the control panel.

 **NOTE:** If you need printed confirmation that your faxes were successfully sent, enable fax confirmation **before** sending any faxes.

 **TIP:** You can also send a fax manually from a phone or by using monitor dialing. These features allow you to control the pace of your dialing. They are also useful when you want to use a calling card to charge the call and you have to respond to tone prompts while dialing.

To send a basic fax from the control panel

1. Load your originals. For additional information, see [Load media](#).

 **NOTE:** If you are sending a multiple-page fax, you must load the originals in the document feeder tray. You cannot fax a multiple-page document from the glass.

2. Enter the fax number by using the keypad, press **Speed Dial** or a one-touch speed dial button to select a speed dial, or press **Redial/Pause** to redial the last number dialed.

 **TIP:** To add a pause in the fax number you are entering, press **Redial/Pause**, or press the **Symbols (*)** button repeatedly, until a dash (-) appears on the display.

3. Press **START FAX Black** or **START FAX Color**.

- **If the device detects an original loaded in the automatic document feeder**, it sends the document to the number you entered.
- **If the device does not detect an original loaded in the automatic document feeder**, the **Fax from glass?** prompt appears. Make sure your original is loaded print-side down on the glass, and then select **Yes**.

 **TIP:** If the recipient reports issues with the quality of the fax you sent, you can try changing the resolution or contrast of your fax.

Send a fax manually from a phone

You can send a fax from a telephone on the same phone line if you prefer to use the keypad on your phone, instead of the keypad on the control panel of the device. You can do this by plugging in a phone into the 2-EXT port on the back of the device. When you send a fax manually, you can hear the dial tones, telephone prompts, or other sounds through the handset on your telephone. This makes it easy for you to use a calling card to send your fax.

Depending on how the recipient has their fax machine set up, the recipient might answer the phone, or the fax machine might take the call. If a person answers the phone, you can speak with the recipient before sending the fax. If a fax machine answers the call, you can send the fax directly to the fax machine when you hear the fax tones from the receiving fax machine.

To send a fax manually from a phone

1. Load your originals. For additional information, see [Load media](#).

 **NOTE:** This feature is not supported if you load your originals on the glass. You must load your originals in the document feeder tray.

2. Dial the number by using the keypad on the phone that is connected to the device.

 **NOTE:** Do not use the keypad on the control panel of the device when manually sending a fax. You must use the keypad on your phone to dial the recipient's number.

3. If the recipient answers the telephone, you can engage in a conversation before sending your fax.

 **NOTE:** If a fax machine answers the call, you will hear fax tones from the receiving fax machine. Proceed to the next step to transmit the fax.

4. When you are ready to send the fax, press **START FAX Black** or **START FAX Color**.

 **NOTE:** If prompted, select **Send Fax**, and then press **START FAX Black** or **START FAX Color** again.

If you were speaking with the recipient before sending the fax, inform the recipient that they should press **Start** on their fax machine after they hear fax tones.

The telephone line is silent while the fax is transmitting. At this point, you can hang up the telephone. If you want to continue speaking with the recipient, remain on the line until the fax transmission is complete.

Send a fax using monitor dialing

Monitor dialing allows you to dial a number from the control panel as you would dial a regular telephone. When you send a fax using monitor dialing, you can hear the dial tones, telephone prompts, or other sounds through the speakers on the device. This enables you to respond to prompts while dialing, as well as control the pace of your dialing.

 **TIP:** If you do not enter your calling card PIN fast enough, the device might start sending fax tones too soon and cause your PIN not to be recognized by the calling card service. If this is the case, you can create a speed dial entry to store the PIN for your calling card.

 **NOTE:** Make sure the volume is turned on, or you will not hear a dial tone.

To send a fax using monitor dialing from the control panel

1. Load your originals. For additional information, see [Load media](#).

 **NOTE:** If you are sending a multiple-page fax, you must load the originals print-side up in the document feeder tray. You cannot fax a multiple-page document from the glass. For additional information, see [Load media](#).

2. Press **START FAX Black** or **START FAX Color**.
 - **If the device detects an original loaded in the automatic document feeder**, you will hear a dial tone.
 - **If the device does not detect an original loaded in the automatic document feeder**, the **Fax from glass?** prompt appears. Make sure that your original is loaded on the glass, and then select **Yes**.

3. When you hear the dial tone, enter the number by using the keypad on the control panel.
4. Follow any prompts that might occur.

 **TIP:** If you are using a calling card to send a fax and you have your calling card PIN stored as a speed dial, when prompted to enter your PIN, press **Speed Dial** or a one-touch speed dial button to select the speed dial entry where you have your PIN stored.

Your fax is sent when the receiving fax machine answers.

Send a fax using the broadcast fax option (color display models only)

You can send a fax to multiple recipients without first setting up a group speed dial.

 **NOTE:** The list of recipients you specify for this fax is not saved and only works for sending faxes in black. If you intend to send other faxes to the same recipient list, you should create a group speed dial list. For more information, see [Set up fax numbers as speed-dial entries or groups](#)

To broadcast a fax to multiple recipients from the control panel

1. Press **Fax Menu** and select **Broadcast Fax**.
2. Enter a fax number by using the keypad, or use the arrow keys to access speed dials.

 **NOTE:** You can add up to 20 individual fax numbers.

3. Press **START FAX Black**.
4. When prompted, load your originals print side up and top first in the center of the document feeder tray. For additional information, see [Load media](#).
5. Press **START FAX Black** again.

Receive a fax

You can receive faxes automatically or manually. If you turn off the **Auto Answer** option, you must receive faxes manually. If you turn on the **Auto Answer** option (the default setting), the device automatically answers incoming calls and receives faxes after the number of rings that are specified by the **Rings to Answer** setting. (The default **Rings to Answer** setting is five rings.)

If you receive a legal-size fax and the device is not currently set to use legal-size paper, the device reduces the fax so that it fits on the paper that is loaded. If you have disabled the **Automatic Reduction** feature, the device prints the fax on two pages.

Receive a fax manually

When you are on the phone, the person you are speaking with can send you a fax while you are still connected. This is referred to as manual faxing. Use the instructions in this section to receive a manual fax.

You can receive faxes manually from a phone that is:

- Directly connected to the device (on the 2-EXT port)
- On the same phone line, but not directly connected to the device

To receive a fax manually

1. Make sure the device is turned on and you have paper loaded in the input tray.
2. Remove any originals from the document feeder tray.
3. Set the **Rings to Answer** setting to a high number to allow you to answer the incoming call before the device answers. Or, turn off the **Auto Answer** setting so that the device does not automatically answer incoming calls.
4. If you are currently on the phone with the sender, instruct the sender to press **Start** on their fax machine.
5. When you hear fax tones from a sending fax machine, do the following:
 - a. Press **START FAX Black** or **START FAX Color** on the control panel.
 - b. When prompted, select **Fax Receive**.
 - c. After the device begins to receive the fax, you can hang up the phone or remain on the line. The phone line is silent during fax transmission.

Set up backup fax reception

Depending on your preference and security requirements, you can set up the device to store all the faxes it receives, only the faxes it receives while the device is in an error condition, or none of the faxes it receives.

The following **Backup Fax Reception** modes are available:

On	<p>The default setting. When Backup Fax Reception is On, the device stores all received faxes in memory. This enables you to reprint up to eight of the most recently printed faxes if they are still saved in memory.</p> <hr/> <p>NOTE: When device memory is low, it overwrites the oldest, printed faxes as it receives new faxes. If the memory becomes full of unprinted faxes, the device stops answering incoming fax calls.</p> <hr/> <p>NOTE: If you receive a fax that is too large, such as a very detailed color photo, it might not be stored in memory due to memory limitations.</p> <hr/>
On Error Only	<p>Causes the device to store faxes in memory only if an error condition exists that prevents the device from printing the faxes (for example, if the device runs out of paper). The device continues to store incoming faxes as long as there is memory available. (If the memory becomes full, the device stops answering incoming fax calls.) When the error condition is resolved, the faxes stored in memory print automatically, and then they are deleted from memory.</p>
Off	<p>Faxes are never stored in memory. For example, you might want to turn off Backup Fax Reception for security purposes. If an error condition occurs that prevents the device from printing (for example, the device runs out of paper), the device stops answering incoming fax calls.</p>

 **NOTE:** If **Backup Fax Reception** is enabled and you turn off the device, all faxes stored in memory are deleted, including any unprinted faxes that you might have received while the device was in an error condition. You must contact the senders to ask them to resend any unprinted faxes. For a list of the faxes you have received, print the **Fax Log**. The **Fax Log** is not deleted when the device is turned off.

To set backup fax reception from the control panel

1. Press **Setup**.
2. Select **Advance Fax Setup**, and then select **Backup Fax Reception**.
3. Press the right arrow button to select **On**, **On Error Only**, or **Off**.
4. Press **OK**.

To set backup fax reception via the embedded Web server

- ▲ Select the **Settings** tab, select **Fax** from the left pane, select the **Advanced** sub-tab, and then select **On** in the **Backup Fax Reception** drop-down menu.

Reprint received faxes from memory

If you set the **Backup Fax Reception** mode to **On**, the received faxes are stored in memory, whether the device has an error condition or not.

 **NOTE:** After the memory becomes full, the oldest, printed faxes are overwritten as new faxes are received. If all the stored faxes are unprinted, the device does not receive any fax calls until you print or delete the faxes from memory. You might also want to delete the faxes in memory for security or privacy purposes.

Depending on the sizes of the faxes in memory, you can reprint up to eight of the most recently printed faxes, if they are still in memory. For example, you might need to reprint your faxes if you lost the copy of your last printout.

To reprint faxes in memory from the control panel

1. Make sure you have paper loaded in the input tray.
2. Press **Setup**.
3. Select **Tools**, and then select **Reprint Faxes in Memory**.
The faxes are printed in the reverse order from which they were received with the most recently received fax printed first, and so on.
4. If you want to stop reprinting the faxes in memory, press **Cancel**.

To delete all the faxes in memory from the control panel

- ▲ Depending on the model you have, do one of the following:
 - **Two-line display:** Turn off the device by pressing the **Power** button. All faxes stored in memory are deleted from memory when you turn off the power.
 - **Color display:** Press **Setup**, select **Tools**, and then select **Clear Fax Log**.

To clear fax logs via the embedded Web server

- ▲ Select the **Settings** tab, select **Fax** from the left pane, select the **Options** sub-tab, and then click the **Clear** button under the **Clear Fax Logs** heading.

Forward faxes to another number

You can set up the device to forward your faxes to another fax number. A received color fax is forwarded in black and white.

HP recommends that you verify the number you are forwarding to is a working fax line. Send a test fax to make sure the fax machine is able to receive your forwarded faxes.

To forward faxes from the control panel

1. Press **Setup**.
2. Select **Advance Fax Setup**, and then select **Fax Forwarding Black Only**.
3. Press the right arrow button until **On-Forward** or **On-Print & Forward** appears, and then press **OK**.
 - Choose **On-Forward** if you want to forward the fax to another number without printing a backup copy on the device.

 **NOTE:** If the device is not able to forward the fax to the designated fax machine (for example, if it is not turned on), the device prints the fax. If you set up the device to print error reports for received faxes, it will also print an error report.

- Choose **On-Print & Forward** to print a backup copy of your received fax while forwarding the fax to another number.
4. At the prompt, enter the number of the fax machine that will receive the forwarded faxes.
 5. At the prompt, enter a start time and date and a stop time and date.
 6. Press **OK**.

Fax Forwarding appears on the control-panel display.

If the device loses power when **Fax Forwarding** is set up, it saves the **Fax Forwarding** setting and phone number. When power is restored to the device, the **Fax Forwarding** setting is still **On**.

 **NOTE:** You can cancel fax forwarding by pressing **Cancel** on the control panel when the **Fax Forwarding** message is visible on the display, or you can select **Off** from the **Fax Forwarding Black Only** menu.

To forward faxes using the embedded Web server

1. Click the **Settings** tab, click **Fax** in the left pane, and then click the **Options** sub-tab.
2. Select **On — Print and Forward** or **On — Forward** from the **Fax Forwarding** drop-down menu.
3. Type a **Fax Forward Number** in the box, and then click **Apply**.

Block junk fax numbers

If you subscribe to a caller ID service through your phone provider, you can block specific fax numbers so the device does not print faxes received from those numbers. When an incoming fax call is received, the device compares the number to the list of junk fax numbers to determine if the call should be blocked. If the number matches a number in the blocked fax numbers list, the fax is not printed. (The maximum number of fax numbers you can block varies by model.)



NOTE: This feature is not supported in all countries/regions. If it is not supported in your country/region, **Junk Fax Blocker Set Up** does not appear in the **Basic Fax Setup** menu.

Set the junk fax mode

By default, **Block Junk Fax** mode is turned **On**. If you do not subscribe to a caller ID service through your phone provider, or do not want to use this feature, you can turn off this setting.

To set the junk fax mode

- ▲ Some models have a **Block Junk Fax** button. Depending on the model you have, do one of the following:
 - **Block Junk Fax button:** Press the **Junk Fax Blocker** button, select the **Block Junk Fax** option, and then select **On** or **Off**.
 - **Color display menu:** Press **Setup**, select **Basic Fax Menu**, select **Junk Fax Blocker Setup**, select **Block Junk Fax**, and then select **On** or **Off**.

Add numbers to the junk fax list

There are two ways to add a number to your junk list. You can select numbers from your caller ID history, or you can enter new numbers. The numbers in your junk list are blocked if **Block Junk Fax** mode is set to **On**.

To select a number from the caller ID list

1. Press **Setup**.
2. Press **Basic Fax Setup**, and then press **Junk Fax Blocker Setup**.
3. Press **Add number to Junk List**, and then press **Select Number**.
4. Press the right arrow button to scroll through the numbers from which you have received faxes. When the number you want to block appears, press **OK** to select it.
5. When the **Select Another?** prompt appears, do one of the following:
 - **If you want to add another number to the list of junk fax numbers**, press **Yes**, and then repeat step 4 for each number you want to block.
 - **If you are done**, press **No**.

To manually enter a number to block

1. Press **Setup**.
2. Press **Basic Fax Setup**, and then press **Junk Fax Blocker Setup**.
3. Press **Add number to Junk List**, and then press **Enter Number**.

4. Use the keypad to enter a fax number to block, and then press **OK**.
Make sure you enter the fax number as it appears on the control-panel display, and not the fax number that appears on the fax header of the received fax, as these numbers can be different.
5. When the **Enter Another?** prompt appears, do one of the following:
 - **If you want to add another number to the list of junk fax numbers**, press **Yes**, and then repeat step 4 for each number you want to block.
 - **If you are done**, press **No**.

To enter numbers to block via the embedded Web server

- ▲ Select the **Settings** tab, select **Fax** from the left pane, select the **Blocked Fax** sub-tab, and then enter numbers to block in the **Fax Number** fields. Click the **Apply** button.

Remove numbers from the junk fax list

If you no longer want to block a fax number, you can remove a number from your junk fax list.

To remove numbers from the list of junk fax numbers

1. Press **Setup**.
2. Press **Basic Fax Setup**, and then press **Junk Fax Blocker Setup**.
3. Press **Remove Number from Junk List**.
4. Press the right arrow button to scroll through the numbers you have blocked. When the number you want to remove appears, press **OK** to select it.
5. When the **Delete Another?** prompt appears, do one of the following:
 - **If you want to remove another number from the list of junk fax numbers**, press **Yes**, and then repeat step 4 for each number you want to block.
 - **If you are done**, press **No**.

To remove numbers from the list of junk fax numbers via the embedded Web server

- ▲ Open the embedded Web server. For more information, see [To open the embedded Web server](#). Click the **Settings** tab, select **Fax** from the left pane, click the **Junk Fax Blocker** sub-tab, add or remove numbers to block in the **Fax Number** fields, and then click **Apply**.

View a list of blocked fax numbers

You can view a list of blocked fax numbers only from the embedded Web server, which requires a network connection.

To view a list of blocked numbers via the embedded Web server

- ▲ Open the embedded Web server. For more information, see [To open the embedded Web server](#). Click the **Settings** tab, select **Fax** from the left pane, and then click the **Junk Fax Blocker** sub-tab.

Change fax settings

After completing the steps in the getting started guide that came with the device, use the following steps to change the initial settings or to configure other options for faxing.

Configure the fax header

The fax header prints your name and fax number on the top of every fax you send. HP recommends that you set up the fax header by using the software that you installed with the device. You can also set up the fax header from the control panel, as described here.



NOTE: In some countries/regions, the fax header information is a legal requirement.

To set or change the fax header

1. Press **Setup**.
2. Press **Basic Fax Setup**, and then press **Fax Header**.
3. Enter your personal or company name using the numeric keypad, and then press **OK**.
4. Enter your fax number by using the numeric keypad, and then press **OK**.

To set or change the fax header via the embedded Web server

- ▲ Select the **Settings** tab, select **Fax** from the left pane, select the **Basic** sub-tab, and then enter the **Fax Header Name** and **Fax Number**. Click the **Apply** button.

Set the answer mode (Auto answer)

The answer mode determines whether the device answers incoming calls.

- Turn on the **Auto Answer** setting if you want the device to answer faxes **automatically**. The device answers all incoming calls and faxes.
- Turn off the **Auto Answer** setting if you want to receive faxes **manually**. You must be available to respond in person to the incoming fax call or the device does not receive faxes.

To set the answer mode to manual or automatic via the control panel

- ▲ Press **Auto Answer** to turn the light on or off, as appropriate for your setup. When the **Auto Answer** light is on, the device answers calls automatically. When the light is off, the it does not answer calls.

To set the answer mode to manual or automatic via the embedded Web server

1. Open the embedded Web server, click the **Settings** tab, click **Fax** in the left pane, and then click the **Basic** sub-tab.
2. Select **On** or **Off** in the **Auto Answer** drop-down menu in the **Other Basic Fax Settings** section.

Set the number of rings before answering

If you turn on the **Auto Answer** setting, you can specify how many rings occur before incoming calls are automatically answered.

The **Rings to Answer** setting is important if you have an answering machine on the same phone line as the device, because you want the answering machine to answer the phone before the device does. The number of rings to answer for the device should be greater than the number of rings to answer for the answering machine.

For example, set your answering machine to a low number of rings and the device to answer in the maximum number of rings. (The maximum number of rings varies by country/region.) In this setup, the answering machine answers the call and the device monitors the line. If the device detects fax tones, it receives the fax. If the call is a voice call, the answering machine records the incoming message.

To set the number of rings before answering via the control panel

1. Press **Setup**.
2. Press **Basic Fax Setup**, and then press **Rings to Answer**.
3. Enter the appropriate number of rings by using the keypad, or press the left or right arrow button to change the number of rings.
4. Press **OK** to accept the setting.

To set the number of rings before answering via the embedded Web server

1. Open the embedded Web server, click the **Settings** tab, click **Fax** in the left pane and then click the **Basic** sub-tab.
2. Select a number in the **Rings-to-answer** drop-down menu in the **Other Basic Fax Settings** section.

Change the answer ring pattern for distinctive ring

Many phone companies offer a distinctive ring feature that allows you to have several phone numbers on one phone line. When you subscribe to this service, each number is assigned a different ring pattern. You can set up the device to answer incoming calls that have a specific ring pattern.

If you connect the device to a line with distinctive ring, have your telephone company assign one ring pattern to voice calls and another ring pattern to fax calls. HP recommends that you request double or triple rings for a fax number. When the device detects the specified ring pattern, it answers the call and receives the fax.

If you do not have a distinctive ring service, use the default ring pattern, which is **All Rings**.

To change the answer ring pattern for distinctive ring via the control panel

1. Verify that the device is set to answer fax calls automatically.
2. Press **Setup**.
3. Press **Advance Fax Setup**, and then press **Distinctive Ring**.
4. Press the right arrow button to select an option, and then press **OK**.
When the phone rings with the ring pattern assigned to your fax line, the device answers the call and receives the fax.

To set the answer ring pattern via the embedded Web server

- ▲ Click the **Settings** tab, click **Fax** in the left pane, click the **Advanced** sub-tab, select a ring pattern in the **Distinctive Ring** drop-down menu, and then click the **Apply** button.

Set the fax error correction mode

Typically, the device monitors the signals on the phone line while it is sending or receiving a fax. If it detects an error signal during the transmission and the error-correction setting is on, the device can request that a portion of the fax be resent.

Turn off error correction only if you are having trouble sending or receiving a fax, and you want to accept the errors in the transmission. Turning off the setting might be useful when you are trying to send a fax to another country/region or receive a fax from another country/region, or if you are using a satellite phone connection.

To set the fax error-correction mode

- **Embedded Web server (network connection):** Open the embedded Web server, click the **Settings** tab, click **Fax** in the left pane, click the **Advanced** tab, select **On** or **Off** in the **Error Correction Mode** drop-down menu, and then click the **Apply** button.
- **Control panel:** Press **Fax Menu**, open the **Advance Fax Setup** menu, and then use the **Error correction mode** option.

Set the dial type

Use this procedure to set tone-dialing or pulse-dialing mode. The factory-set default is **Tone**. Do not change the setting unless you know that your phone line cannot use tone dialing.

 **NOTE:** The pulse-dialing option is not available in all countries/regions.

To set the dial type

- **Embedded Web server (network connection):** Open the embedded Web server, click the **Settings** tab, click **Fax** in the left pane, click the **Basic** tab, make a selection in the **Tone or Pulse Dialing** drop-down menu, and then click the **Apply** button.
- **Control panel:** Press **Setup**, press **Basic Fax Setup**, and then use the **Tone or Pulse Dialing** option.

Set the redial options

If the device was unable to send a fax because the receiving fax machine did not answer or was busy, the device attempts to redial based on the settings for the busy-redial and no-answer-redial options. Use the following procedure to turn the options on or off.

- **Busy redial:** If this option is turned on, the device redials automatically if it receives a busy signal. The factory-set default for this option is **ON**.
- **No answer redial:** If this option is turned on, the device redials automatically if the receiving fax machine does not answer. The factory-set default for this option is **OFF**.

To set the redial options

- **Embedded Web server (network connection):** Open the embedded Web server, click the **Settings** tab, click **Fax** in the left pane, and then click the **Advanced** tab.
- **Control panel:** Press **Setup**, press **Advance Fax Setup**, and then use the **Busy Redial** or **No Answer Redial** options.

Set the fax speed

You can set the fax speed used to communicate between your device and other fax machines when sending and receiving faxes. The default fax speed is **Fast**.

If you use one of the following, setting the fax speed to a slower speed might be required:

- An Internet phone service
- A PBX system
- Fax over Internet Protocol (FoIP)
- An integrated services digital network (ISDN) service

If you experience problems sending and receiving faxes, you might want to try setting the **Fax Speed** setting to **Medium** or **Slow**. The following table provides the available fax speed settings.

Fax speed setting	Fax speed
Fast	v.34 (33600 baud)
Medium	v.17 (14400 baud)
Slow	v.29 (9600 baud)

To set the fax speed from the control panel

1. Press **Setup**.
2. Select **Advanced Fax Setup**, and then press **Fax Speed**.
3. Select an option using the arrow keys, and then press **OK**.

Fax over the Internet

You may subscribe to a low cost phone service that allows you to send and receive faxes with your device by using the Internet. This method is called Fax over Internet Protocol (FoIP). You probably use a FoIP service (provided by your telephone company) if you:

- Dial a special access code along with the fax number, or
- Have an IP converter box that connects to the Internet and provides analog phone ports for the fax connection.

 **NOTE:** You can only send and receive faxes by connecting a phone cord to the port labeled "1-LINE" on the device and not from the Ethernet port. This means that your connection to the Internet must be done either through a converter box (which supplies regular analog phone jacks for fax connections) or your telephone company.

Some Internet faxing services do not work properly when the device is sending and receiving faxes at high speed (33600bps). If you experience problems sending and receiving faxes while using an Internet fax service, use a slower fax speed. You can do this by changing the **Fax Speed** setting from **High** (the default) to **Medium**. For information on changing this setting, see [Set the fax speed](#).

You should also check with your telephone company to make sure their Internet faxing service supports faxing.

Test fax setup

You can test your fax setup to check the status of the device and to make sure it is set up properly for faxing. Perform this test after you have completed setting up the device for faxing. The test does the following:

- Tests the fax hardware
- Verifies the correct type of phone cord is connected to the device
- Checks that the phone cord is plugged into the correct port
- Checks for a dial tone
- Checks for an active phone line
- Tests the status of your phone line connection

The device prints a report with the results of the test. If the test fails, review the report for information on how to fix the problem and rerun the test.

To test fax setup

1. Set up the device for faxing according to your particular home or office setup instructions.
2. Make sure the ink cartridges and printheads are installed, and that full-size paper is loaded in the input tray before starting the test.
3. From the control panel, press **Setup**.
4. Select **Tools**, and then select **Run Fax Test**.
The device displays the status of the test on the display and prints a report.
5. Review the report.
 - If the test passes and you are still having problems faxing, check the fax settings listed in the report to verify the settings are correct. A blank or incorrect fax setting can cause problems faxing.
 - If the test fails, review the report for more information on how to fix any problems found.

Use reports

You can set up the device to print error reports and confirmation reports automatically for each fax you send and receive. You can also manually print system reports as required; these reports provide useful system information about the device.

By default, the device is set to print a report only if there is a problem sending or receiving a fax. A confirmation message that indicates whether a fax was successfully sent appears briefly on the control-panel display after each transaction.

Print fax confirmation reports

If you require printed confirmation that your faxes were successfully sent, follow these instructions to enable fax confirmation **before** sending any faxes. Select either **On Fax Send** or **Send & Receive**.

The default fax confirmation setting is **Off**. This means that a confirmation report is not printed for each fax sent or received. A confirmation message indicating whether a fax was successfully sent appears briefly on the control-panel display after each transaction.

To enable fax confirmation

1. Press **Setup**.
2. Press **Print Report**, and then **Fax Confirmation**.
3. Press the right arrow button to select one of the following, and then press **OK**.

Off	Does not print a fax confirmation report when you send and receive faxes successfully. This is the default setting.
On Fax Send	Prints a fax confirmation report for every fax you send.
On Fax Receive	Prints a fax confirmation report for every fax you receive.
Send & Receive	Prints a fax confirmation report for every fax you send and receive.

 **TIP:** If you choose **On Fax Send** or **Send & Receive**, and scan your fax to send from memory, you can include an image of the first page of the fax on the **Fax Sent Confirmation** report. Press **Setup**, press **Fax Confirmation**, and then press **On Fax Send** again. Select **On** from the **Image on Fax Send Report** menu.

Print fax error reports

You can configure the device so that it automatically prints a report when there is an error during transmission or reception.

To set the device to print fax error reports automatically

1. Press **Setup**.
2. Press **Print Report**, and then press **Fax Error Report**.
3. Press the right arrow button to select one of the following, and then press **OK**.

Send & Receive	Prints whenever a fax error occurs. This is the default setting.
Off	Does not print any fax error reports.
On Fax Send	Prints whenever a transmission error occurs.
On Fax Receive	Prints whenever a receiving error occurs.

Print and view the fax log

You can print a log of faxes that have been received and sent by the device. Each entry in the log contains the following information:

- Transmission date and time
- Type (whether received or sent)
- Fax number
- Duration
- Number of pages
- Result (status) of transmission

The logs list faxes that have been sent from the control panel and all faxes that have been received.

To view the fax log from the embedded Web server

- ▲ On the **Information** tab, click **Log** in the left pane, then click the **Fax Log** sub-tab.

The log lists faxes that have been sent from the HP photo and imaging software and all faxes that have been received.

To view the fax log from the HP photo and imaging software

1. At the computer, open the HP photo and imaging software. For more information, see [Use the HP photo and imaging software](#).
2. See the onscreen Help for the HP photo and imaging software for further instructions.

The log lists faxes that have been sent from the control panel and the HP photo and imaging software and all faxes that have been received.

To print the fax log from the control panel

1. On the control panel, press **Setup**.
2. Press the arrow key to move down to **Print Report**, and then press **OK**.
3. Press the arrow key to move down to **Fax Log**, and then press **OK**.
4. Press **OK** again to print the log.

Cancel a fax

You can cancel a fax you are sending or receiving at any time.

To cancel a fax

- ▲ Press **Cancel** on the control panel to stop a fax you are sending or receiving. If the device does not stop faxing, press **Cancel** again.
The device prints any pages it has already started printing and then cancels the remainder of the fax. This can take a few moments.

To cancel a number you are dialing

- ▲ Press **Cancel** to cancel a number you are currently dialing.

9 Configure and manage

This section is intended for the administrator or individual who is responsible for managing the device. This section contains information about the following topics.

- [Manage the device](#)
- [Use device management tools](#)
- [Understand the self-test diagnostic page](#)
- [Understand the network configuration page](#)
- [Configure network options](#)
- [Set up faxing for the device \(some models only\)](#)
- [Configure the device \(Windows\)](#)
- [Configure the device \(Mac OS\)](#)
- [Set up the device for wireless communication \(some models only\)](#)
- [Set up the device for Bluetooth communication](#)
- [Uninstall and reinstall the software](#)

Manage the device

- [Overview of management tasks](#)
- [Monitor the device](#)
- [Administer the device](#)

Overview of management tasks

The following table lists common tools that can be used to manage the device. Specific procedures might include other methods. For information about accessing and using the tools, see [Use device management tools](#).

 **NOTE:** Mac OS users can use the control panel, the embedded Web server, and the HP Printer Utility. Windows users can use the control panel, the embedded Web server, the printer driver, the Toolbox, the HP Web Jetadmin, and myPrintMileage.

For more information about the HP Web Jetadmin software, open the HP Web Jetadmin software and see its documentation. For more information about myPrintMileage, visit the myPrintMileage Web site.

If you want to...	use these tools...					
	Control panel parts	Embedded Web server	Toolbox (Windows)	HP Printer Utility (Mac OS)	HP Web Jetadmin software	myPrint-Mileage *
Monitor the device						
Status of supplies	✓	✓	✓	✓	✓	✓

(continued)

If you want to...	use these tools...					
Usage of supplies and media		✓		✓		✓
Operation and status	✓	✓	✓		✓	
Administer the device						
Device maintenance	✓	✓	✓	✓		
Device security		✓			✓	
Scanner bulb time	✓	✓				
Tray settings	✓	✓	✓	✓		
Device volume or control button volume settings	✓				✓	
Alerts and notifications					✓	

* Available if myPrintMileage is installed.

Monitor the device

This section provides instructions for monitoring the device.

Use this tool...	to obtain the following information....
Control panel	Obtain information about the status of jobs that are being processed, the operating status of the device, and the status of ink cartridges and printheads.
Embedded Web server	<ul style="list-style-type: none">• Printer status information: Click the Information tab, and then click an option available on the left pane.• Ink cartridge and printhead status: Click the Information tab, and then click Ink Supplies in the left pane.• Accumulated ink and media usage: Click the Information tab, and then click Usage in the left pane.
Toolbox (Windows)	Ink cartridge information: Click the Estimated Ink Levels tab to view the ink-level information, and then scroll to display the Cartridge Details button. Click the Cartridge Details button to view information

(continued)

Use this tool...	to obtain the following information....
	about replacement ink cartridges and expirations dates. NOTE: The ink levels shown are an estimate only. Actual ink volumes may vary.
HP Printer Utility (Mac OS)	Ink cartridge information: Open the Information and Support panel and click Supplies Status .

Administer the device

This section provides information about administering the device and modifying settings.

Use this tool...	to do the following...
Control panel	<ul style="list-style-type: none"> • Language and country/region: Press Setup, and then open the Preferences menu. • Control panel volume: Press Setup, and then open the Preferences menu. • Fax sound volume: Press Setup, and then select Fax Sound Volume. • Automatic report printing: Press Setup, and then open the Advance Fax Setup menu. • Set the dial type: Press Setup, and then open the Basic Fax Setup menu. • Set up redial options: Press Setup, and then open the Advance Fax Setup menu. • View the IP address of the device (see Change advanced network settings). • Set the date and time: Press Setup, press Tools, and then press Date and Time. • Set the scanner bulb time: Press Setup, select Preferences, and then select Set Bulb Time.
Embedded Web server	<ul style="list-style-type: none"> • Set embedded Web server password: Click the Settings tab, and then click Security in the left pane. • Change tray settings: Click the Settings tab, and then click Paper Handling in the left pane. • Perform device maintenance tasks: Click the Settings tab, and then click Device Services in the left pane. • Language and country/region: Click the Settings tab, and then click International in the left pane. • Fax sound volume: Click the Settings tab, click Fax in the left pane, and then adjust the Fax Sound Volume option.

(continued)

Use this tool...	to do the following...
	<ul style="list-style-type: none">• Configure network settings: Click the Networking tab, and then click an option in the left pane.• Set a static IP address: Click the Networking tab, and then click either Wired 802.3 or Wireless 802.11. In the IP Address Configuration section, select Manual IP and enter the static IP address. Enter the Manual Subnet Mask and Manual Default Gateway, if necessary, and then click Apply. For more information, see Troubleshooting tips and resources. <hr/> <p>NOTE: It is not recommended that you assign a static IP address to the device. However, a static IP address might resolve certain setup and printing problems, such as a conflict with a personal firewall.</p> <hr/> <ul style="list-style-type: none">• Configure Direct Digital Filing settings: Click the Settings tab, and then click Direct Digital Filing Speed-dial.• Automatic fax report printing: Click the Settings tab, and then click Fax in the left pane. Then click the Advanced tab.• Setting up the dial type: Click the Settings tab, and then click Fax in the left pane. Then click the Basic tab.• Setting up redial options: Click the Settings tab, and then click Fax. Click the Advanced tab.• Order supplies: On any tab, click the Order Supplies button, and then follow the onscreen instructions.• Support: On any tab, click the Support button, and then select a support option.• Configure Bluetooth settings: Click the Bluetooth tab.• Set the date and time: Click the Settings tab, click Time Services in the left pane, type the necessary values in the fields, and then click Apply.
Toolbox (Windows)	<ul style="list-style-type: none">• Change tray settings: Click Paper Handling on the Services tab.• Perform device maintenance tasks: Click the Services tab.
HP Printer Utility (Mac OS)	<ul style="list-style-type: none">• Change tray settings: Click Paper Handling from the Printer Settings panel.• Perform device maintenance tasks: Open the Information and Support panel, and then click the option for the task that you want to perform.

Use device management tools

- [Embedded Web server](#)
- [Toolbox \(Windows\)](#)
- [HP Printer Utility \(Mac OS\)](#)
- [Network Printer Setup Utility \(Mac OS\)](#)
- [HP Web Jetadmin software](#)
- [HP Instant Support](#)
- [myPrintMileage](#)

Embedded Web server

When the device is connected to a network, you can use the embedded Web server to view status information, change settings, and manage it from your computer.

 **NOTE:** For a list of system requirements for the embedded Web server, see [Embedded Web server specifications](#).

Some settings might be restricted by the requirement for a password.

You can open and use the embedded Web server without being connected to the Internet; however, some features will not be available.

To open the embedded Web server

You can open the embedded Web server by using these methods:

 **NOTE:** To open the embedded Web server from the printer driver (Windows), or the HP Printer Utility (Mac OS), the device must be on a network and must have an IP address.

- **Web browser:** In a supported Web browser on your computer, type the IP address that has been assigned to the device.
For example, if the IP address is 123.123.123.123, type the following address into the Web browser: `http://123.123.123.123`
The IP address for the device is listed on the self-test diagnostic page. For more information, see [Understand the network configuration page](#).
After opening the embedded Web server, you can bookmark it so that you can return to it quickly in the future.
- **HP Printer Utility (Mac OS):** On the **Printer Settings** panel, click **Additional Settings**, and then click the **Open Embedded Web Server** button.

Embedded Web server pages

The embedded Web server contains pages that you can use to view product information and change device settings. The pages also contain links to other e-services.

Pages/buttons	Contents
Information page	Shows status information about the device, its ink supplies and usage, and a log of device events (such as errors).
Settings page	Shows the settings that have been configured for the device and gives you the ability to change these settings.
Networking page	Shows network status and the network settings that have been configured for the device. These pages only appear if the device is connected to a network. For more information, see Configure network options .
Bluetooth page	Shows the Bluetooth settings that have been configured for the device and gives you the ability to change these settings.
Support and Order Supplies buttons	Support provides a number of support services, including e-services such as HP Instant Support, myPrintMileage. For more information, see HP Instant Support and myPrintMileage . Order Supplies connects you to online ordering of supplies.

Toolbox (Windows)

The Toolbox provides maintenance information about the device.

 **NOTE:** The Toolbox can be installed from the Starter CD by selecting the full installation option if the computer meets the system requirements.

To open the Toolbox

- From the HP Solution Center, click the **Settings** menu, point to **Print Settings**, and then click **Printer Toolbox**.
- Right-click the HP Digital Imaging Monitor in the tray, point to **Printer Model Name** and then click **Display Printer Toolbox**.

Toolbox tabs

The Toolbox contains the following tabs.

Tabs	Contents
Estimated Ink Level	<ul style="list-style-type: none"> • Ink Level Information: Shows estimated ink level for each cartridge. <hr/> <p>NOTE: The ink levels shown are an estimate only. Actual ink volumes may vary.</p> <hr/> <ul style="list-style-type: none"> • Shop Online: Provides access to a Web site from which you can order printing supplies for the device online. • Order by Phone: Shows telephone numbers that you can call to order supplies for the device. Telephone numbers are not available for all countries/regions. • Cartridge Details: Shows order numbers and expiration dates of the installed ink cartridges.
Information	<p>Printer Information: Provides a link to myPrintMileage and shows the device hardware and printhead health information. Information tab options include:</p> <ul style="list-style-type: none"> • Hardware information • myPrintmileage (if installed) • HP Instant Support • HP printhead health
Services	<ul style="list-style-type: none"> • Print PQ (print quality) Diagnostic Page: Allows you to diagnose issues affecting the print quality of the device. For more information, see To print the print quality diagnostic page. • Print Self-Test Diagnostic Page: Allows you to print the self-test diagnostic page of the device. This page contains information about the device and the supplies. For more information, see Understand the self-test diagnostic page. • Align Printheads: Guides you through aligning the printheads. For more information, see To align the printheads. • Clean Printheads: Guides you through cleaning the printheads. For more information, see To clean the printheads. • Calibrate Linefeed: Allows you to perform linefeed calibration. For more information, see To calibrate the linefeed. • Paper Handling: Allows you to set the tray lock and select a default tray (if Tray 2 is installed). For more information, see Configure trays.

HP Printer Utility (Mac OS)

The HP Printer Utility contains tools to configure print settings, calibrate the device, clean the printheads, print the self-test diagnostic page, order supplies online, and find Web site support information.

To open the HP Printer Utility

1. From the **Finder**, select **Computer** from the **Go** menu.
2. Select **Library**, and then select **Printers**.
3. Select **hp**, select **Utilities**, and then select **HP Printer Selector**.
4. Select the device and click **Launch Utility**.

HP Printer Utility panels

Information and Support panel

- **Supplies Status:** Shows the information about currently installed printheads and ink cartridges.
- **Supply Info:** Shows the ink cartridge replacement options.
- **Device Information:** Displays information about the model and serial number. Also allows you to print the self-test diagnostic page of the device. This page contains information about the device and the supplies. For more information, see [Understand the self-test diagnostic page](#).
- **Print Quality Diagnostics:** Allows you to diagnose issues affecting the print quality of the device. For more information, see [To print the print quality diagnostic page](#).
- **Clean:** Guides you through cleaning the printheads. For more information, see [To clean the printheads](#).
- **Align:** Guides you through aligning the printheads. For more information, see [To align the printheads](#).
- **Calibrate Linefeed:** Allows you to perform linefeed calibration. For more information, see [To calibrate the linefeed](#).
- **HP Support:** Gain access to HP Web site where you can find support for the device, register the device, and find information about returning and recycling used printing supplies.

Printer Settings panel

- **Trays Configuration:** Set the default media type and size for a tray, and set the tray priority. For more information, see [Configure trays](#).
- **Additional Settings:** Launch the embedded Web server to change network settings. Configure IP settings for network connectivity.

Network Printer Setup Utility (Mac OS)

This tool allows you to configure network settings for the device. You can configure wireless settings such as network location name and wireless mode, and wired settings such as TCP/IP address, router, and subnet mask.

To open the Network Printer Setup Utility

1. From the **Finder**, select **Computer** from the **Go** menu.
2. Select **Library**, and then select **Printers**.
3. Select **hp**, select **Utilities**, and then select **Network Printer Setup Utility**.
4. Follow the onscreen instructions to configure network settings for the device.

HP Web Jetadmin software

The HP Web Jetadmin software is a Web-based management solution for remotely installing, configuring (both individually or in batch mode), monitoring status (including levels for supplies), conducting remote diagnostics, and troubleshooting a wide variety of HP and non-HP network peripherals.

After the software is installed, you can gain access to it from anywhere within your intranet by using a standard Web browser. To get more information or to download the software, go to www.hp.com/go/webjetadmin.

HP Instant Support

HP Instant Support is a suite of Web-based troubleshooting tools. It helps you quickly identify, diagnose, and resolve printing problems.

HP Instant Support provides the following information about your device:

- **Easy access to troubleshooting tips:** Provides tips that are customized for your device.
- **Resolution of specific device errors:** Provides immediate access to information that can help you resolve error messages specific to your device. To see a description of the problem, as well as recommendations for solving or preventing the problem, click the link within the message.
- **Notification of print driver updates:** Alerts you when there is an update for the printer driver. A message appears on the HP Instant Support homepage; click the link within the message to go directly to the download section of the HP Web site.
- **Obtaining support services:** Provides a list of the support services that are available for your device.
- **Managing ink and media usage (myPrintMileage):** Helps you manage and forecast device supplies usage.
- **Self diagnostic testing for your device:** Runs a diagnostic test of your device. Select **Printer** on the **Self Help** menu on the Instant Support page to start diagnosing the devices. HP Instant Support checks the computer, and a list of configured devices appears. When you select the device that you want to diagnose, HP Instant Support can help you with tasks.

- **HP expert help online (Active Chat):** Provides personalized help from an HP support expert over the Web at any time through real-time chat. Simply submit a question or a description of your problem. Your recent device history, system configuration, and any actions that you have attempted are automatically forwarded to HP (upon your approval) so that you will not need to describe the problem again.
- **Knowledge database:** Use the HP knowledge database to quickly find answers to your questions.

Security and privacy

When you use HP Instant Support, detailed device information, such as the serial number, error conditions, and status, is sent to HP. HP respects your privacy and manages this information according to the guidelines that are outlined in the HP Online Privacy Statement (welcome.hp.com/country/us/en/privacy.html).

 **NOTE:** To view all the data that is sent to HP, select **Source** (for Internet Explorer and Opera) or **Page Source** (for Netscape and Mozilla Firefox) from the **View** menu in your Web browser.

To gain access to HP Instant Support

- **Toolbox (Windows):** Click the **Information** tab, and then click **HP Instant Support**.
- **Embedded Web server:** Click the **Support** button, then click **HP Instant Support**.

 **NOTE:** The **Support** button is available in all pages.

 **NOTE:** Do not bookmark the Web pages that are used to open HP Instant Support. If you bookmark the site and connect to it by using the bookmark, the pages do not contain the current information.

myPrintMileage

myPrintMileage is a service that HP provides to help you track and forecast your device usage and plan the purchase of supplies.

To use myPrintMileage, you must have the following:

- Internet connection
- Device connected

On the myPrintMileage Web site, you can see the print analysis, such as the amount of ink you have used, whether you use more black or color ink, and the estimated number of pages you can print with the remaining amount of ink

To gain access to myPrintMileage

- **Embedded Web server:** Click the **Support** button, and then click **myPrintMileage**.

 **NOTE:** The **Support** button is available in all pages.

- **Toolbox (Windows):** Click the **Information** tab, and then click **myPrintMileage** and follow the onscreen instructions.
- **Windows taskbar:** Right-click the **HP Digital Imaging** icon in the Windows taskbar, choose the device you wish to view, and then click **myPrintMileage**.

 **NOTE:** Do not bookmark the Web pages that are used to open myPrintMileage. If you bookmark the site and connect to it by using the bookmark, the pages do not contain the current information.

Understand the self-test diagnostic page

Use the self-test diagnostic page to:

- View current device information, ink cartridge status, and printhead health status
- Help troubleshoot problems
- Verify installation of optional accessories, such as the duplexer

The self-test diagnostic page also contains a log of recent events.

If you need to call HP, it is often useful to print the self-test diagnostic page before calling.

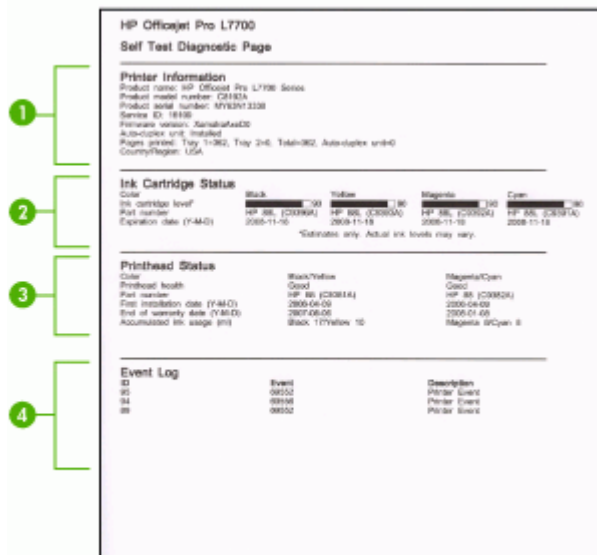

- 1. Printer Information:** Shows device information (such as the product name, model number, serial number, and firmware version number), the accessories that are installed (such as the duplexer), and the number of pages printed from the trays and accessories.
- 2. Ink Cartridge Status:** Shows the estimated ink levels (represented in graphical form as gauges) and the part numbers and expiration dates of the ink cartridges.

 **NOTE:** The ink levels shown are an estimate only. Actual ink volumes may vary.

- 3. Printhead Status:** Shows the status of the printhead health and the part numbers, first-installation dates, and end-of-warranty dates of the printheads, as well as the accumulated ink usage. The status options for the printhead are: good, fair, and replace. If the status is 'fair,' then the print quality must be monitored, but the printhead does not need to be replaced. If the status is 'replace,' then the printhead should be replaced, as the device will not function until it is.
- 4. Event Log:** Shows a log of recent events that have occurred.

To print the Self-Test Diagnostic Page

- **Control panel:** Press **Setup**, select **Print Report**, select **Self-Test Report**, and then press **OK**.
- **Toolbox (Windows):** Click the **Services** tab, and then click **Print Self-test Diagnostic Page**.
- **HP Printer Utility (Mac OS):** Click **Device Information** from the **Information and Support** panel, and then click **Print Configuration Page**.

Understand the network configuration page

If the device is connected to a network, you can print a network configuration page to view the network settings for the device. You can use the network configuration page to help troubleshoot network connectivity problems. If you need to call HP, it is often useful to print this page before calling.

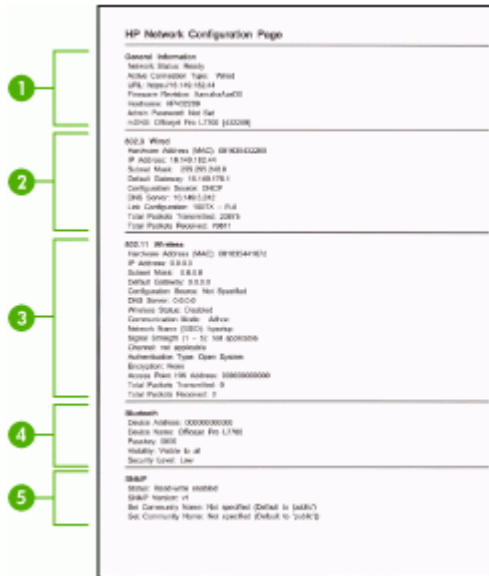

Network Configuration Page

- 1. General Information:** Shows information about the current status and active connection type of the network, and other information, such as the URL of the embedded Web server.
- 2. 802.3 Wired:** Shows information about the active wired network connection, such as the IP address, subnet mask, default gateway, as well as the hardware address of the device.
- 3. 802.11 Wireless:** Shows information about the active wireless network connection, such as the IP address, the communication mode, the network name, authentication type, and signal strength.
- 4. Bluetooth:** Shows information about the active Bluetooth wireless connection, such as the device name and address, as well as the passkey.
- 5. SNMP:** Shows information about the current SNMP settings and status, including the community name settings.

To print the network configuration page from the control panel

- If the device has a two-line display: Press the **Setup** button, select **Network Setup**, select **Print Network Settings**, and then press **OK**.
- If the device has a color display: Press the **Setup** button, select **Network**, select **View Network Settings**, select **Print Network Configuration Page**, and then press **OK**.

Channel range definitions

The following table lists the 802.11 Wireless channel range definitions.

The first digit stands for Locale Number	
Locale 0: Channels 1-11: <ul style="list-style-type: none">• high-power 802.11b• low-power 802.11g	
Locale 1: Channels 1-13: <ul style="list-style-type: none">• low-power 802.11b• low-power 802.11g	
Locale 2: Channels 1-14: <ul style="list-style-type: none">• low-power 802.11b• low-power 802.11g	
NOTE: 802.11g is not allowed on channel 14.	
The second digit stands for Ad-Hoc Compatibility Mode	0: Ad-Hoc connection status nominal 1: Ad-Hoc always appears connected
The third digit stands for Infrastructure Rate Restriction	0: 802.11b or 802.11g 1: 802.11b only
The fourth digit stands for Ad-Hoc Rate Restriction	0: 802.11b or 802.11g 1: 802.11b only

Configure network options

You can manage network settings for the device through the control panel as described in the next section. Additional advanced settings are available in the embedded Web server, a configuration and status tool you access from your Web browser using an existing network connection to the device. For more information, see [Embedded Web server](#).

Change basic network settings

The control-panel options enable you to set up and manage a wireless connection and to perform a variety of network management tasks. This includes viewing the network settings, restoring the network defaults, turning the wireless radio on and off, and changing the network settings.

Use the Wireless Setup Wizard

The Wireless Setup Wizard provides an easy way to set up and manage a wireless connection to your device. For more information on setting up a wireless connection and the Wireless Setup Wizard, see [Set up the device for wireless communication \(some models only\)](#).

View and print network settings

You can display a summary of the network settings on the control panel, or you can print a more detailed network configuration page. The network configuration page lists all of the important network settings such as the IP address, link speed, DNS, and mDNS. For information on the network settings, see [Understand the network configuration page](#).

1. Press the **Setup** button.
2. Press the arrow keys until **Network** is highlighted, and then press **OK**.
3. Do one of the following:
 - To display wired (Ethernet) network settings, select **View Network Settings**, and then select **Display Wired Summary**.
 - To display wireless network settings, select **View Network Settings**, and then select **Display Wireless Summary**.
 - To print the network configuration page, select **View Network Settings**, and then select **Print Network Configuration Page**.

Turn the wireless radio on and off

The wireless radio is on by default, as indicated by the blue light on the front of the device. In order to stay connected to a wireless network, the radio must stay on. However, if your device is connected to a wired network or you have a USB connection, the radio is not used. In this case you might want to turn the radio off.

1. Press the **Setup** button.
2. Press the arrow keys until **Network** is highlighted, and then press **OK**.
3. Select **Wireless Radio**, and then select **Yes** to turn the radio on, or **No** to turn the radio off.

Change advanced network settings

The advanced network settings are provided for your convenience. However, unless you are an advanced user, you should not change any of these settings. The advanced settings include **Link Speed**, **IP Settings**, and **Memory Card Security**.

Set link speed

You can change the speed at which data is transmitted over the network. The default is **Automatic**.

1. Press the **Setup** button.
2. Press the arrow keys until **Network** is highlighted, then press **OK**.

3. Select **Advanced Setup**, then select **Link Speed**.
4. Press the number next to the link speed that matches your network hardware:
 - **1. Automatic**
 - **2. 10-Full**
 - **3. 10-Half**
 - **4. 100-Full**
 - **5. 100-Half**

To View IP settings

- Color display: To view the IP address of the device from the control panel, press the **Setup** button, select **Network**, select **View Network Settings**, and then select either **Display Wired Summary** or **Display Wireless Summary**.
- Two-line display: To view the IP address of the device, you must print the network configuration page. For more information, see [Understand the network configuration page](#).

To Change IP settings

The default IP setting for the IP settings is **Automatic**, which sets the IP settings automatically. However, if you are an advanced user, you might want to manually change the IP address, subnet mask, or the default gateway.

△ **CAUTION:** Be careful when manually assigning an IP address. If you enter an invalid IP address during the installation, your network components will not be able to connect with the device.

1. Press the **Setup** button.
2. Press the arrow keys until **Network** is highlighted, and then press **OK**.
3. Select **Advanced Setup**, select **IP Settings**, and then select **Manual IP Settings**.
4. Press the number next to the IP setting:
 - **1. IP Address**
 - **2. Subnet Mask**
 - **3. Default Gateway**
5. Enter your changes, and then press **OK**.

Set up faxing for the device (some models only)

After completing all the steps in the getting started guide, use the instructions in this section to complete your fax setup. Keep your getting started guide for later use.

In this section, you will learn how to set up the device so that faxing works successfully with equipment and services you might already have on the same phone line.

💡 **TIP:** You can also use the Fax Setup Wizard (Windows) or HP Fax Setup Utility (Mac OS) to help you quickly set up some important fax settings such as the answer mode and fax header information. You can access the Fax Setup Wizard (Windows) or HP Fax Setup Utility (Mac OS) through the software you installed with the device. After you run the Fax Setup Wizard (Windows) or HP Fax Setup Utility (Mac OS), follow the procedures in this section to complete your fax setup.

Set up faxing (parallel phone systems)

Before you begin setting up the device for faxing, determine which kind of phone system your country/region uses. The instructions for fax setup differ depending on whether you have a serial- or parallel-type phone system.

- If you do not see your country/region listed in the table below, you probably have a serial-type phone system. In a serial-type phone system, the connector type on your shared telephone equipment (modems, phones, and answering machines) does not allow a physical connection to the "2-EXT" port on the device. Instead, all equipment must be connected at the telephone wall jack.

 **NOTE:** In some countries/regions that use serial-type phone systems, the phone cord that came with the device might have an additional wall plug attached to it. This enables you to connect other telecom devices to the wall jack where you plug in the device.

- If your country/region is listed in the table below, you probably have a parallel-type telephone system. In a parallel-type phone system, you are able to connect shared telephone equipment to the phone line by using the "2-EXT" port on the back of the device.

 **NOTE:** If you have a parallel-type phone system, HP recommends you use the 2-wire phone cord supplied with the device to connect it to the telephone wall jack.

Table 9-1 Countries/regions with a parallel-type phone system

Argentina	Australia	Brazil
Canada	Chile	China
Colombia	Greece	India
Indonesia	Ireland	Japan
Korea	Latin America	Malaysia
Mexico	Philippines	Poland
Portugal	Russia	Saudi Arabia
Singapore	Spain	Taiwan
Thailand	USA	Venezuela
Vietnam		

If you are unsure which kind of telephone system you have (serial or parallel), check with your telephone company.

Choose the correct fax setup for your home or office

To fax successfully, you need to know what types of equipment and services (if any) share the same phone line with the device. This is important because you might need

to connect some of your existing office equipment directly to the device, and you might also need to change some fax settings before you can fax successfully.

To determine the best way to set up the device in your home or office, first read through the questions in this section and record your answers. Next, refer to the table in the following section and choose the recommended setup case based on your answers.

Make sure to read and answer the following questions in the order they are presented.

1. Do you have a digital subscriber line (DSL) service through your telephone company? (DSL might be called ADSL in your country/region.)
If you answered Yes, proceed directly to [Case B: Set up the device with DSL](#). You do not need to continue answering questions.
If you answered No, continue answering questions.
2. Do you have a private branch exchange (PBX) phone system or an integrated services digital network (ISDN) system?
If you answered Yes, proceed directly to [Case C: Set up the device with a PBX phone system or an ISDN line](#). You do not need to continue answering questions.
If you answered No, continue answering questions.
3. Do you subscribe to a distinctive ring service through your telephone company that provides multiple phone numbers with different ring patterns?
If you answered Yes, proceed directly to [Case D: Fax with a distinctive ring service on the same line](#). You do not need to continue answering questions.
If you answered No, continue answering questions.
Are you unsure if you have distinctive ring? Many phone companies offer a distinctive ring feature that allows you to have several phone numbers on one phone line.
When you subscribe to this service, each phone number will have a different ring pattern. For example, you can have single, double, and triple rings for the different numbers. You might assign one phone number with a single ring to your voice calls, and another phone number with double rings to your fax calls. This allows you to tell the difference between voice and fax calls when the phone rings.
4. Do you receive voice calls at the same phone number you will use for fax calls on the device?
Continue answering questions.
5. Do you have a computer dial-up modem on the same phone line as the device?
Are you unsure if you use a computer dial-up modem? If you answer Yes to any of the following questions, you are using a computer dial-up modem:
 - Do you send and receive faxes directly to and from your computer software applications through a dial-up connection?
 - Do you send and receive e-mail messages on your computer through a dial-up connection?
 - Do you access the Internet from your computer through a dial-up connection?Continue answering questions.

6. Do you have an answering machine that answers voice calls at the same phone number you will use for fax calls on the device?
Continue answering questions.
7. Do you subscribe to a voice mail service through your telephone company at the same phone number you will use for fax calls on the device?
After you have completed answering the questions, proceed to the next section to select your fax setup case.

Select your fax setup case

Now that you have answered all the questions about the equipment and services that share the phone line with the device, you are ready to choose the best setup case for your home or office.

From the first column in the following table, choose the combination of equipment and services applicable to your home or office setting. Then look up the appropriate setup case in the second or third column based on your phone system. Step-by-step instructions are included for each case in the sections that follow.

If you have answered all the questions in the previous section and have none of the described equipment or services, choose "None" from the first column in the table.

 **NOTE:** If your home or office setup is not described in this section, set up the device as you would a regular analog phone. Make sure you use the phone cord supplied in the box to connect one end to your telephone wall jack and the other end to the port labeled 1-LINE on the back of the device. If you use another phone cord, you might experience problems sending and receiving faxes.

Other equipment/services sharing your fax line	Recommended fax setup for parallel-type phone systems	Recommended fax setup for serial-type phone systems
None (You answered No to all questions.)	Case A: Separate fax line (no voice calls received)	Refer to your country in Serial-type fax setup
DSL service (You answered Yes to question 1 only.)	Case B: Set up the device with DSL	Refer to your country in Serial-type fax setup
PBX or ISDN system (You answered Yes to question 2 only.)	Case C: Set up the device with a PBX phone system or an ISDN line	Refer to your country in Serial-type fax setup
Distinctive ring service (You answered Yes to question 3 only.)	Case D: Fax with a distinctive ring service on the same line	Refer to your country in Serial-type fax setup
Voice calls (You answered Yes to question 4 only.)	Case E: Shared voice/fax line	Refer to your country in Serial-type fax setup
Voice calls and voice mail service	Case F: Shared voice/fax line with voice mail	Refer to your country in Serial-type fax setup

(continued)

Other equipment/services sharing your fax line	Recommended fax setup for parallel-type phone systems	Recommended fax setup for serial-type phone systems
(You answered Yes to questions 4 and 7 only.)		
Computer dial-up modem (You answered Yes to question 5 only.)	Case G: Fax line shared with computer modem (no voice calls received)	Not applicable.
Voice calls and computer dial-up modem (You answered Yes to questions 4 and 5 only.)	Case H: Shared voice/fax line with computer modem	Not applicable.
Voice calls and answering machine (You answered Yes to questions 4 and 6 only.)	Case I: Shared voice/fax line with answering machine	Not applicable.
Voice calls, computer dial-up modem, and answering machine (You answered Yes to questions 4, 5, and 6 only.)	Case J: Shared voice/fax line with computer modem and answering machine	Not applicable.
Voice calls, computer dial-up modem, and voice mail service (You answered Yes to questions 4, 5, and 7 only.)	Case K: Shared voice/fax line with computer dial-up modem and voice mail	Not applicable.

Case A: Separate fax line (no voice calls received)

If you have a separate phone line on which you receive no voice calls, and you have no other equipment connected on this phone line, set up the device as described in this section.

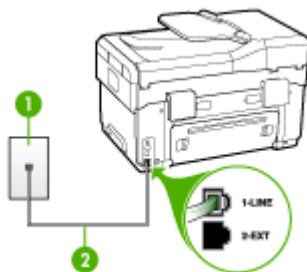



Figure 9-1 Back view of the device

1	Telephone wall jack
2	Use the phone cord supplied in the box with the device to connect to the 1-LINE port

To set up the device with a separate fax line

- Using the phone cord supplied in the box with the device, connect one end to your telephone wall jack, then connect the other end to the port labeled 1-LINE on the back of the device.

 **NOTE:** If you do not use the supplied cord to connect from the telephone wall jack to the device, you might not be able to fax successfully. This special phone cord is different from the phone cords you might already have in your home or office.

- Turn on the **Auto Answer** setting.
- (Optional) Change the **Rings to Answer** setting to the lowest setting (two rings).
- Run a fax test.

When the phone rings, the device answers automatically after the number of rings you set in the **Rings to Answer** setting. The device begins emitting fax reception tones to the sending fax machine and receives the fax.

Case B: Set up the device with DSL

If you have a DSL service through your telephone company, and do not connect any equipment to the device, use the instructions in this section to connect a DSL filter between the telephone wall jack and the device. The DSL filter removes the digital signal that can interfere with the device, so the device can communicate properly with the phone line. (DSL might be called ADSL in your country/region.)

 **NOTE:** If you have a DSL line and you do not connect the DSL filter, you will not be able to send and receive faxes with the device.

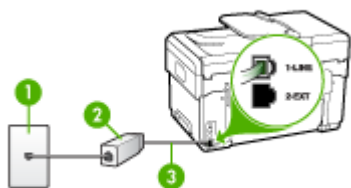

Figure 9-2 Back view of the device

1	Telephone wall jack
2	DSL (or ADSL) filter and cord supplied by your DSL provider

(continued)

3	Use the phone cord supplied in the box with the device to connect to the 1-LINE port
---	--------------------------------------------------------------------------------------

To set up the device with DSL

1. Obtain a DSL filter from your DSL provider.
2. Using the phone cord supplied in the box with the device, connect one end to the open port on the DSL filter, and then connect the other end to the port labeled 1-LINE on the back of the device.

 **NOTE:** If you do not use the supplied cord to connect from the DSL filter to the device, you might not be able to fax successfully. This special phone cord is different from the phone cords you might already have in your home or office. As only one phone cord is supplied, you may will need to obtain additional phone cords for this setup.

3. Connect an additional phone cord from the DSL filter to the telephone wall jack.
4. Run a fax test.

Case C: Set up the device with a PBX phone system or an ISDN line

If you are using either a PBX phone system or an ISDN converter/terminal adapter, make sure you do the following:

- If you are using either a PBX or an ISDN converter/terminal adaptor, connect the device to the port that is designated for fax and phone use. Also, make sure that the terminal adapter is set to the correct switch type for your country/region, if possible.

 **NOTE:** Some ISDN systems allow you to configure the ports for specific phone equipment. For example, you might have assigned one port for telephone and Group 3 fax and another port for multiple purposes. If you have problems when connected to the fax/phone port of your ISDN converter, try using the port designated for multiple purposes; it might be labeled "multi-combi" or something similar.

- If you are using a PBX phone system, set the call waiting tone to "off."

 **NOTE:** Many digital PBX systems include a call-waiting tone that is set to "on" by default. The call waiting tone will interfere with any fax transmission, and you will not be able to send or receive faxes with the device. Refer to the documentation that came with your PBX phone system for instructions on how to turn off the call-waiting tone.

- If you are using a PBX phone system, dial the number for an outside line before dialing the fax number.
- Make sure you use the supplied cord to connect from the telephone wall jack to the device. If you do not, you might not be able to fax successfully. This special phone cord is different from the phone cords you might already have in your home or office. If the supplied phone cord is too short, you can purchase a coupler from your local electronics store and extend it.

Case D: Fax with a distinctive ring service on the same line

If you subscribe to a distinctive ring service (through your telephone company) that allows you to have multiple phone numbers on one phone line, each with a different ring pattern, set up the device as described in this section.

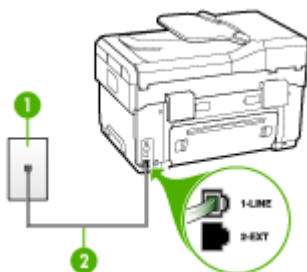



Figure 9-3 Back view of the device

1	Telephone wall jack
2	Use the phone cord supplied in the box with the device to connect to the 1-LINE port

To set up the device with a distinctive ring service

- Using the phone cord supplied in the box with the device, connect one end to your telephone wall jack, then connect the other end to the port labeled 1-LINE on the back of the device.

 **NOTE:** If you do not use the supplied cord to connect from the telephone wall jack to the device, you might not be able to fax successfully. This special phone cord is different from the phone cords you might already have in your home or office.

- Turn on the **Auto Answer** setting.
- Change the **Distinctive Ring** setting to match the pattern that the telephone company assigned to your fax number.

 **NOTE:** By default, the device is set to answer all ring patterns. If you do not set the **Distinctive Ring** to match the ring pattern assigned to your fax number, the device might answer both voice calls and fax calls or it might not answer at all.

- (Optional) Change the **Rings to Answer** setting to the lowest setting (two rings).
- Run a fax test.

The device automatically answers incoming calls that have the ring pattern you selected (**Distinctive Ring** setting) after the number of rings you selected (**Rings to Answer** setting). The device begins emitting fax reception tones to the sending fax machine and receives the fax.

Case E: Shared voice/fax line

If you receive both voice calls and fax calls at the same phone number, and you have no other office equipment (or voice mail) on this phone line, set up the device as described in this section.



Figure 9-4 Back view of the device

1	Telephone wall jack
2	Use the phone cord supplied in the box with the device to connect to the 1-LINE port
3	Telephone (optional)

To set up the device with a shared voice/fax line

1. Using the phone cord supplied in the box with the device, connect one end to your telephone wall jack, then connect the other end to the port labeled 1-LINE on the back of the device.

 **NOTE:** If you do not use the supplied cord to connect from the telephone wall jack to the device, you might not be able to fax successfully. This special phone cord is different from the phone cords you might already have in your home or office.

2. Do one of the following:
 - If you have a parallel-type phone system, remove the white plug from the port labeled 2-EXT on the back of the device, and then connect a phone to this port.
 - If you have a serial-type phone system, you might plug your phone directly on top of the device cable which has a wall plug attached to it.

3. Now you need to decide how you want the device to answer calls, automatically or manually:
 - If you set up the device to answer calls **automatically**, it answers all incoming calls and receives faxes. The device will not be able to distinguish between fax and voice calls in this case; if you suspect the call is a voice call, you will need to answer it before the device answers the call. To set up the device to answer calls automatically, turn on the **Auto Answer** setting.
 - If you set up the device to answer faxes **manually**, you must be available to respond in person to incoming fax calls or the device cannot receive faxes. To set up the device to answer calls manually, turn off the **Auto Answer** setting.
4. Run a fax test.

If you pick up the phone before the device answers the call and hear fax tones from a sending fax machine, you will need to answer the fax call manually.

Case F: Shared voice/fax line with voice mail

If you receive both voice calls and fax calls at the same phone number, and you also subscribe to a voice mail service through your telephone company, set up the device as described in this section.

 **NOTE:** You cannot receive faxes automatically if you have a voice mail service at the same phone number you use for fax calls. You must receive faxes manually; this means you must be available to respond in person to incoming fax calls. If you want to receive faxes automatically instead, contact your telephone company to subscribe to a distinctive ring service, or to obtain a separate phone line for faxing.

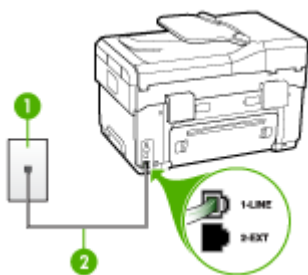



Figure 9-5 Back view of the device

1	Telephone wall jack
2	Use the phone cord supplied in the box with the device to connect to the "1-LINE" port

To set up the device with voice mail

1. Using the phone cord supplied in the box with the device, connect one end to your telephone wall jack, then connect the other end to the port labeled 1-LINE on the back of the device.

 **NOTE:** If you do not use the supplied cord to connect from the telephone wall jack to the device, you might not be able to fax successfully. This special phone cord is different from the phone cords you might already have in your home or office.

2. Turn off the **Auto Answer** setting.
3. Run a fax test.

You must be available to respond in person to incoming fax calls, or the device cannot receive faxes.

Case G: Fax line shared with computer modem (no voice calls received)

If you have a fax line on which you receive no voice calls, and you also have a computer modem connected on this line, set up the device as described in this section.

 **NOTE:** If you have a computer dial-up modem, your computer dial-up modem shares the phone line with the device. You will not be able to use both your modem and the device simultaneously. For example, you cannot use the device for faxing while you are using your computer dial-up modem to send an e-mail or access the Internet.

- [Set up the device with a computer dial-up modem](#)
- [Set up the device with a computer DSL/ADSL modem](#)

Set up the device with a computer dial-up modem

If you are using the same phone line for sending faxes and for a computer dial-up modem, follow these directions for setting up the device.

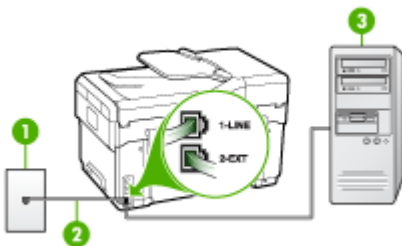



Figure 9-6 Back view of the device

1	Telephone wall jack
2	Use the phone cord supplied in the box with the device to connect to the "1-LINE" port
3	Computer with modem

To set up the device with a computer dial-up modem

1. Remove the white plug from the port labeled 2-EXT on the back of the device.
2. Find the phone cord that connects from the back of your computer (your computer dial-up modem) to a telephone wall jack. Disconnect the cord from the telephone wall jack and plug it into the port labeled 2-EXT on the back of the device.
3. Using the phone cord supplied in the box with the device, connect one end to your telephone wall jack, then connect the other end to the port labeled 1-LINE on the back of the device.

 **NOTE:** If you do not use the supplied cord to connect from the telephone wall jack to the device, you might not be able to fax successfully. This special phone cord is different from the phone cords you might already have in your home or office.

4. If your modem software is set to receive faxes to your computer automatically, turn off that setting.

 **NOTE:** If you do not turn off the automatic fax reception setting in your modem software, the device will not be able to receive faxes.

5. Turn on the **Auto Answer** setting.
6. (Optional) Change the **Rings to Answer** setting to the lowest setting (two rings).
7. Run a fax test.

When the phone rings, the device automatically answers after the number of rings you set in the **Rings to Answer** setting. The device begins emitting fax reception tones to the sending fax machine and receives the fax.

Set up the device with a computer DSL/ADSL modem

If you have a DSL line and use that phone line to send faxes, follow these instructions to set up your fax.

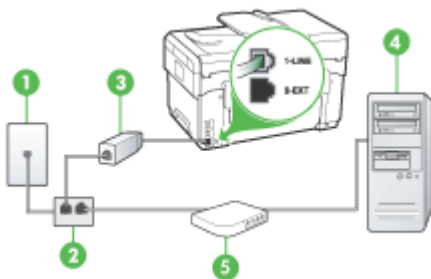

1	Telephone wall jack
2	Parallel splitter
3	DSL/ADSL splitter Connect one end of the phone jack that was supplied with the device to connect to the 1-LINE port on the back of the device. Connect the other end of the cord to the DSL/ADSL filter.
4	Computer
5	Computer DSL/ADSL modem

 **NOTE:** You will need to purchase a parallel splitter (also called a coupler). A parallel splitter has one RJ-11 port on the front and two RJ-11 ports on the back. Do not use a 2-line phone splitter, a serial splitter, or a parallel splitter which has two RJ-11 ports on the front and a plug on the back.



To set up the device with a computer DSL/ADSL modem

1. Obtain a DSL filter from your DSL provider.
2. Using the phone cord provided in the box with the device, connect one end to the DSL filter, and then connect the other end to the port labeled 1-LINE on the back of the device.

 **NOTE:** If you do not use the supplied cord to connect from the DSL filter to the back of the device, you might not be able to fax successfully. This special phone cord is different from the phone cords you might already have in your home or office.

3. Connect the DSL filter to the parallel splitter.
4. Connect the DSL modem to the parallel splitter.
5. Connect the parallel splitter to the wall jack.
6. Run a fax test.

When the phone rings, the device automatically answers after the number of rings you set in the **Rings to Answer** setting. The device begins emitting fax reception tones to the sending fax machine and receives the fax.

Case H: Shared voice/fax line with computer modem

If you receive both voice calls and fax calls at the same phone number, and you also have a computer modem connected on this phone line, set up the device as described in this section.

NOTE: Since your computer modem shares the phone line with the device, you cannot use both your modem and the device simultaneously. For example, you cannot use the device for faxing while you are using your computer modem to send an e-mail or access the Internet.

- [Shared voice/fax with computer dial-up modem](#)
- [Shared voice/fax with computer DSL/ADSL modem](#)

Shared voice/fax with computer dial-up modem

If you use your phone line for both fax and telephone calls, use these instructions to set up your fax.

There are two different ways to set up the device with your computer based on the number of phone ports on your computer. Before you begin, check your computer to see if it has one or two phone ports.

- If your computer has only one phone port, you will need to purchase a parallel splitter (also called a coupler), as shown below. (A parallel splitter has one RJ-11 port on the front and two RJ-11 ports on the back. Do not use a two-line phone splitter, a serial splitter, or a parallel splitter which has two RJ-11 ports on the front and a plug on the back.)



Figure 9-7 Example of a parallel splitter

- If your computer has one phone port, set up the device as described below.

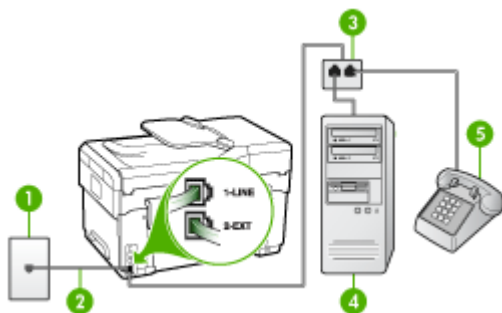



Figure 9-8 Back view of the device

1	Telephone wall jack
2	Phone cord provided with the device plugged into the 1-LINE port on the back of the device
3	Parallel splitter

4	Computer
5	Telephone

To set up the device on the same phone line as a computer with one phone port

1. Remove the white plug from the port labeled 2-EXT on the back of the device.
2. Find the phone cord that connects from the back of your computer (your computer dial-up modem) to a telephone wall jack. Disconnect the cord from the telephone wall jack and plug it into the parallel splitter.
3. Connect a phone cord from the parallel splitter to the port labeled 2-EXT on the back of the device.
4. Connect a phone to the parallel splitter.
5. Using the phone cord supplied in the box with the device, connect one end to your telephone wall jack, then connect the other end to the port labeled 1-LINE on the back of the device.

 **NOTE:** If you do not use the supplied cord to connect from the telephone wall jack to the device, you might not be able to fax successfully. This special phone cord is different from the phone cords you might already have in your home or office.

6. If your modem software is set to receive faxes to your computer automatically, turn off that setting.

 **NOTE:** If you do not turn off the automatic fax reception setting in your modem software, the device will not be able to receive faxes.

7. Now you need to decide how you want the device to answer calls, automatically or manually:
 - If you set up the device to answer calls **automatically**, it answers all incoming calls and receives faxes. The device will not be able to distinguish between fax and voice calls in this case; if you suspect the call is a voice call, you will need to answer it before the device answers the call. To set up the device to answer calls automatically, turn on the **Auto Answer** setting.
 - If you set up the device to answer faxes **manually**, you must be available to respond in person to incoming fax calls or the device cannot receive faxes. To set up the device to answer calls manually, turn off the **Auto Answer** setting.

8. Run a fax test.

 **NOTE:** If your computer has two telephone ports on the back, you do not need to use a parallel splitter. You can plug the telephone into the “OUT” port on the computer dial-up modem.

If you pick up the phone before the device answers the call and hear fax tones from a sending fax machine, you will need to answer the fax call manually.

If you use your phone line for voice, fax, and your computer dial-up modem, follow these directions to set up your fax.

Shared voice/fax with computer DSL/ADSL modem

Use these instructions if your computer has a DSL/ADSL modem

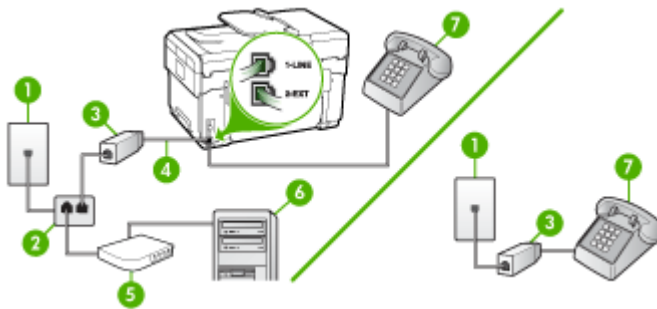

1	Telephone wall jack
2	Parallel splitter
3	DSL/ADSL filter
4	Phone cord supplied with the device
5	DSL/ADSL modem
6	Computer
7	Telephone

NOTE: You will need to purchase a parallel splitter (also called a coupler). A parallel splitter has one RJ-11 port on the front and two RJ-11 ports on the back. Do not use a 2-line phone splitter, a serial splitter, or a parallel splitter which has two RJ-11 ports on the front and a plug on the back.



To set up the device with a computer DSL/ADSL modem

1. Obtain a DSL filter from your DSL provider.

 **NOTE:** Phones in other parts of the home/office sharing the same phone number with DSL service will need to be connected to additional DSL filters, otherwise you will experience noise when making voice calls.

2. Using the phone cord supplied in the box with the devices, connect one end to the DSL filter, then connect the other end to the port labeled 1-LINE on the back of the device.

 **NOTE:** If you do not use the supplied cord to connect from the DSL filter to the device, you might not be able to fax successfully. This special phone cord is different from phone cords you might already have in your home or office.

3. If you have a parallel-type phone system, remove the white plug from the port labeled 2-EXT on the back of the device, and then connect a phone to this port.
4. Connect the DSL filter to the parallel splitter.
5. Connect the DSL modem to the parallel splitter.
6. Connect the parallel splitter to the wall jack.
7. Run a fax test.

When the phone rings, the device automatically answers after the number of rings you set in the **Rings to Answer** setting. The device begins emitting fax reception tones to the sending fax machine and receives the fax.

Case I: Shared voice/fax line with answering machine

If you receive both voice calls and fax calls at the same phone number, and you also have an answering machine that answers voice calls at this phone number, set up the device as described in this section.



Figure 9-9 Back view of the device

1	Telephone wall jack
2	Use the phone cord provided to connect to the 1-LINE port on the back of the device
3	Answering machine
4	Telephone (optional)

To set up the device with a shared voice/fax line with answering machine

1. Remove the white plug from the port labeled 2-EXT on the back of the device.
2. Unplug your answering machine from the telephone wall jack, and connect it to the port labeled 2-EXT on the back of the device.

 **NOTE:** If you do not connect your answering machine directly to the device, fax tones from a sending fax machine might be recorded on your answering machine, and you probably will not be able to receive faxes with the device.

3. Using the phone cord supplied in the box with the device, connect one end to your telephone wall jack, then connect the other end to the port labeled 1-LINE on the back of the device.

 **NOTE:** If you do not use the supplied cord to connect from the telephone wall jack to the device, you might not be able to fax successfully. This special phone cord is different from the phone cords you might already have in your home or office.

4. (Optional) If your answering machine does not have a built-in phone, for convenience you might want to connect a phone to the back of your answering machine at the "OUT" port.

 **NOTE:** If your answering machine does not let you connect an external phone, you can purchase and use a parallel splitter (also known as a coupler) to connect both the answering machine and telephone to the device. You can use standard phone cords for these connections.

5. Turn on the **Auto Answer** setting.
6. Set your answering machine to answer after a low number of rings.
7. Change the **Rings to Answer** setting on the device to the maximum number of rings supported by your device. (The maximum number of rings varies by country/region.)
8. Run a fax test.

When the phone rings, your answering machine answers after the number of rings you have set, and then plays your recorded greeting. The device monitors the call during this time, "listening" for fax tones. If incoming fax tones are detected, the device emits fax reception tones and receives the fax; if there are no fax tones, the device stops monitoring the line and your answering machine can record a voice message.

Case J: Shared voice/fax line with computer modem and answering machine

If you receive both voice calls and fax calls at the same phone number, and you also have a computer modem and answering machine connected on this phone line, set up the device as described in this section.

 **NOTE:** Since your computer dial-up modem shares the phone line with the device, you cannot use both your modem and the device simultaneously. For example, you cannot use the device for faxing while you are using your computer dial-up modem to send an e-mail or access the Internet.

- [Shared voice/fax line with computer dial-up modem and answering machine](#)
- [Shared voice/fax line with computer DSL/ADSL modem and answering machine](#)

Shared voice/fax line with computer dial-up modem and answering machine

There are two different ways to set the device with your computer based on the number of phone ports on your computer. Before you begin, check your computer to see if it has one or two phone ports.

- If your computer has only one phone port, you will need to purchase a parallel splitter (also called a coupler), as shown below. (A parallel splitter has one RJ-11 port on the front and two RJ-11 ports on the back. Do not use a two-line phone splitter, a serial splitter, or a parallel splitter which has two RJ-11 ports on the front and a plug on the back.)



Figure 9-10 Example of a parallel splitter

- If your computer has one phone port, set up the device as described below.

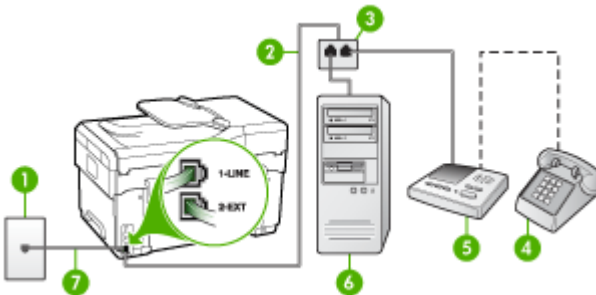

Figure 9-11 Back view of the device

1	Telephone wall jack
2	Telephone cord connected to the parallel splitter
3	Parallel splitter
4	Telephone (optional)
5	Answering machine
6	Computer with modem

To set up the device on the same phone line as a computer with one phone port

1. Remove the white plug from the port labeled 2-EXT on the back of the device.
2. Find the phone cord that connects from the back of your computer (your computer dial-up modem) to a telephone wall jack. Disconnect the cord from the telephone wall jack and plug it into the port labeled 2-EXT on the back of the device.
3. Unplug your answering machine from the telephone wall jack, and connect it to the port labeled 2-EXT on the back of the device.



NOTE: If you do not connect your answering machine directly to the device, fax tones from a sending fax machine might be recorded on your answering machine, and you probably will not be able to receive faxes with the device.

4. Using the phone cord supplied in the box with the device, connect one end to your telephone wall jack, then connect the other end to the port labeled 1-LINE on the back of the device.



NOTE: If you do not use the supplied cord to connect from the telephone wall jack to the device, you might not be able to fax successfully. This special phone cord is different from the phone cords you might already have in your home or office.

5. (Optional) If your answering machine does not have a built-in phone, for convenience you might want to connect a phone to the back of your answering machine at the "OUT" port.



NOTE: If your answering machine does not let you connect an external phone, you can purchase and use a parallel splitter (also known as a coupler) to connect both the answering machine and telephone to the device. You can use standard phone cords for these connections.

6. If your modem software is set to receive faxes to your computer automatically, turn off that setting.



NOTE: If you do not turn off the automatic fax reception setting in your modem software, the device will not be able to receive faxes.

7. Turn on the **Auto Answer** setting.
8. Set your answering machine to answer after a low number of rings.
9. Change the **Rings to Answer** setting on the device to the maximum number of rings supported by your device. (The maximum number of rings varies by country/region.)
10. Run a fax test.



NOTE: If you are using a computer with two telephone ports, you do not need a parallel splitter. You can plug the answering machine into the "OUT" port on the back of the computer.

When the phone rings, your answering machine answers after the number of rings you have set, and then plays your recorded greeting. The device monitors the call during this time, "listening" for fax tones. If incoming fax tones are detected, the device emits fax reception tones and receives the fax; if there are no fax tones, the device stops monitoring the line and your answering machine can record a voice message.

Shared voice/fax line with computer DSL/ADSL modem and answering machine

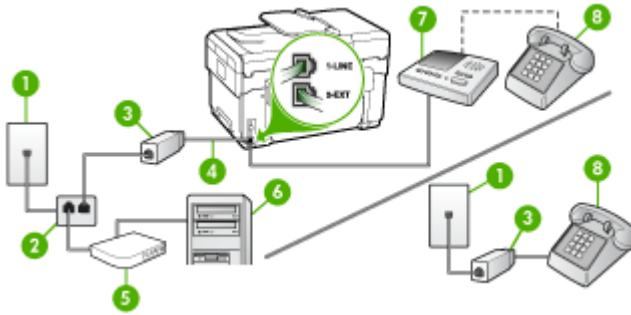

1	Telephone wall jack
2	Parallel splitter
3	DSL/ADSL filter
4	Phone cord provided with the device connected to the 1-LINE port on the back of the device
5	DSL/ADSL modem
6	Computer
7	Answering machine
8	Telephone (optional)

NOTE: You will need to purchase a parallel splitter (also called a coupler). A parallel splitter has one RJ-11 port on the front and two RJ-11 ports on the back. Do not use a 2-line phone splitter, a serial splitter, or a parallel splitter which has two RJ-11 ports on the front and a plug on the back.



To set up the device with a computer DSL/ADSL modem

1. Obtain a DSL/ADSL filter from your DSL/ADSL provider.

 **NOTE:** Phones in other parts of the home/office sharing the same phone number with DSL/ADSL service will need to be connected to additional DSL/ADSL filters, otherwise you will experience noise when making voice calls.

2. Using the phone cord supplied in the box with the device, connect one end to the DSL/ADSL filter, then connect the other end to the port labeled 1-LINE on the back of the device.

 **NOTE:** If you do not use the supplied cord to connect from the DSL/ADSL filter to the device, you might not be able to fax successfully. This special phone cord is different from the phone cords you might already have in your home or office.

3. Connect the DSL/ADSL filter to the splitter.
4. Unplug the answering machine from the telephone wall jack, and connect it to the port labeled 2-EXT on the back of the device.

 **NOTE:** If you do not connect your answering machine directly to the device, fax tones from a sending fax machine might be recorded on your answering machine, and you probably will not be able to receive faxes with the device.

5. Connect the DSL modem to the parallel splitter.
6. Connect the parallel splitter to the wall jack.
7. Set your answering machine to answer after a low number of rings.
8. Change your **Rings to Answer** setting on the device to the maximum number of rings supported by the device.

 **NOTE:** The maximum number of rings varies by country/region

9. Run a fax test.

When the phone rings, your answering machine will answer after the number of rings you have set, and then play your recorded greeting. The device monitors the call during this time, “listening” for fax tones. If incoming fax tones are detected, the device will emit fax reception tones and receive the fax; if there are no fax tones, the device stops monitoring the line and your answering machine can record a voice message.

If you use the same phone line for telephone, fax, and have a computer DSL modem, follow these instructions to set up your fax.

Case K: Shared voice/fax line with computer dial-up modem and voice mail

If you receive both voice calls and fax calls at the same phone number, use a computer dial-up modem on the same phone line, and subscribe to a voice mail service through your telephone company, set up the device as described in this section.

 **NOTE:** You cannot receive faxes automatically if you have a voice mail service at the same phone number you use for fax calls. You must receive faxes manually; this means you must be available to respond in person to incoming fax calls. If you want to receive faxes automatically instead, contact your telephone company to subscribe to a distinctive ring service, or to obtain a separate phone line for faxing.

Since your computer dial-up modem shares the phone line with the device, you cannot use both your modem and the device simultaneously. For example, you cannot use the device for faxing if you are using your computer dial-up modem to send an e-mail or access the Internet.

There are two different ways to set up the device with your computer based on the number of phone ports on your computer. Before you begin, check your computer to see if it has one or two phone ports.

- If your computer has only one phone port, you will need to purchase a parallel splitter (also called a coupler), as shown below. (A parallel splitter has one RJ-11 port on the front and two RJ-11 ports on the back. Do not use a two-line phone splitter, a serial splitter, or a parallel splitter which has two RJ-11 ports on the front and a plug on the back.)



Figure 9-12 Example of a parallel splitter

- If your computer has two phone ports, set up the device as described below.



Figure 9-13 Back view of the device

1	Telephone wall jack
2	Use the phone cord supplied in the box with the device to connect to the 1-LINE port
3	Computer with modem
4	Telephone

To set up the device on the same phone line as a computer with two phone ports

1. Remove the white plug from the port labeled 2-EXT on the back of the device.
2. Find the phone cord that connects from the back of your computer (your computer dial-up modem) to a telephone wall jack. Disconnect the cord from the telephone wall jack and plug it into the port labeled 2-EXT on the back of the device.
3. Connect a phone to the "OUT" port on the back of your computer dial-up modem.
4. Using the phone cord supplied in the box with the device, connect one end to your telephone wall jack, then connect the other end to the port labeled 1-LINE on the back of the device.

 **NOTE:** If you do not use the supplied cord to connect from the telephone wall jack to the device, you might not be able to fax successfully. This special phone cord is different from the phone cords you might already have in your home or office.

5. If your modem software is set to receive faxes to your computer automatically, turn off that setting.

 **NOTE:** If you do not turn off the automatic fax reception setting in your modem software, the device will not be able to receive faxes.

6. Turn off the **Auto Answer** setting.
7. Run a fax test.

You must be available to respond in person to incoming fax calls, or the device cannot receive faxes.

Serial-type fax setup

For information on setting up the device for faxing using a serial-type phone system, see the Fax Configuration Web site for your country/region.

Austria	www.hp.com/at/faxconfig
Germany	www.hp.com/de/faxconfig
Switzerland (French)	www.hp.com/ch/fr/faxconfig
Switzerland (German)	www.hp.com/ch/de/faxconfig
United Kingdom	www.hp.com/uk/faxconfig
Finland	www.hp.fi/faxconfig
Denmark	www.hp.dk/faxconfig
Sweden	www.hp.se/faxconfig
Norway	www.hp.no/faxconfig
Netherlands	www.hp.nl/faxconfig
Belgium (Dutch)	www.hp.be/nl/faxconfig
Belgium (French)	www.hp.be/fr/faxconfig
Portugal	www.hp.pt/faxconfig

(continued)

Spain	www.hp.es/faxconfig
France	www.hp.com/fr/faxconfig
Ireland	www.hp.com/ie/faxconfig
Italy	www.hp.com/it/faxconfig

Configure the device (Windows)

You can connect the device directly to a computer, or you can share the device among other users on a network.

 **NOTE:** Microsoft Internet Explorer 6.0 must be installed on the computer system to run the installation program.

Also, you must have administrator privileges to install a printer driver on Windows 2000, Windows XP, or Windows Server 2003.

When setting up the device, HP recommends that you connect it after you install the software because the installation program is designed to provide you with the easiest setup experience. However, if you have connected the cable first, see [To connect the device before installing the software](#).

Direct connection

You can connect the device directly to your computer using a USB cable.

 **NOTE:** If you install the device software and connect the device to a computer running Windows, you can connect additional devices to the same computer with USB cables without reinstalling the device software.

When setting up the device, HP recommends that you connect the device after you install the software because the installation program is designed to provide you with the easiest setup experience. However, if you have connected the cable first, see [To connect the device before installing the software](#).

To install the software before connecting the device (recommended)

1. Close any applications that are running.
2. Insert the Starter CD into the CD drive. The CD menu runs automatically. If the CD menu does not start automatically, double-click the setup icon on the Starter CD..
3. On the CD menu, click **Install** and follow the onscreen instructions.
4. When prompted, turn on the device and connect it to the computer using a USB cable. The **Found New Hardware** wizard appears on the computer screen, and the device icon is created in the Printers folder.

 **NOTE:** You may connect the USB cable at a later time when you need to use the device.

You can also share the device with other computers using a simple form of networking known as locally shared networking. For more information, see [To share the device on a locally shared network](#).

To connect the device before installing the software

If you connected the device to the computer before installing the device software, the **Found New Hardware** wizard displays on the computer screen.

 **NOTE:** If you turned on the device, do not turn it off or unplug the cable from the device while the installation program is running. If you do so, the installation program will not finish.

1. In the **Found New Hardware** dialog box that displays methods for locating the printer driver, select the Advanced option, and then click **Next**.

 **NOTE:** Do not allow the **Found New Hardware** wizard to perform an automatic search for the printer driver.

2. Select the check box for specifying the driver location, and ensure that the other check boxes are clear.
3. Insert the Starter CD into the CD drive. If the CD menu appears, close it.
4. Browse to locate the root directory on the Starter CD (for example, D), and then click **OK**.
5. Click **Next** and follow the onscreen instructions.
6. Click **Finish** to close the **Found New Hardware** wizard. The wizard automatically starts the installation program (this might take a short while).
7. Complete the installation process.

 **NOTE:** You can also share the device with other computers using a simple form of networking known as locally shared networking. For more information, see [To share the device on a locally shared network](#).

To share the device on a locally shared network

In a locally shared network, the device is connected directly to the USB connector of a selected computer (known as the server) and is shared by other computers (clients).

 **NOTE:** When sharing a directly connected device, use the computer with the newest operating system as the server. For example, if you have a computer running Windows XP and another computer running an older version of Windows, use the computer running Windows XP as the server.

Use this configuration only in small groups or when usage is low. The connected computer is slowed down when many users print to the device.

Only the printing function is shared. Scan, Copy, and Fax functions are not shared.

1. Click **Start**, point to **Settings**, and then click **Printers** or **Printers and Faxes**.
- Or -
Click **Start**, click **Control Panel**, and then double-click **Printers**.
2. Right-click the device icon, click **Properties**, and then click the **Sharing** tab.
3. Click the option to share the device, and give it a share name.
4. To share the device with client computers that use other versions of Windows, click **Additional Drivers** to install those drivers as a convenience to the users. You must have the Starter CD in your CD drive.

Network connection

If the device has network capability, it can be shared in a network environment by connecting it directly to the network. This type of connection offers the ability to manage the device using the embedded Web server from any computer on the network.

 **NOTE:** Microsoft Internet Explorer 6.0 must be installed on the computer system to run the installation program.

Choose the installation option for the type of network you have:

- **Client/server network:** If your network has a computer acting as a dedicated print server, install the device software on the server, and then install the device software on the client computers. For more information see [To install the device on a network](#) and [To install the device software on client computers](#). This method does not allow you to share the full functionality of the device. Client computers can only print from the device.
- **Peer-to-peer network:** If you have a peer-to-peer network (a network without a dedicated print server), install the software on the computers that will be using the device. For more information, see [To install the device on a network](#).

In addition, you can connect to a network printer on both types of networks using the **Add Printer** wizard in Windows. For more information, see [To install the printer driver using Add Printer](#).

To install the device on a network

Use the following steps to install the device software in the following networking scenarios:

You have a peer-to-peer network (a network without a dedicated print server)

1. Remove the protective cover from the device's network port and connect the device to the network.
2. Close any third-party firewall and any applications that are running on the computer system that are acting as the print server.
3. Insert the Starter CD into the CD drive. The CD menu starts automatically. If the CD menu does not start automatically, browse to the CD drive of the computer and double-click **Setup.exe**.
4. On the CD menu, click **Install**, and then follow the onscreen instructions.
5. On the **Connection Type** screen, select **Wired network/Wireless**, and then click **Next**.
6. Follow the onscreen instructions to complete the installation.

 **NOTE:** To share the device with Windows client computers, see [To install the device software on client computers](#) and [To share the device on a locally shared network](#).

To install the device software on client computers

After printer drivers are installed on the computer that is acting as the print server, the printing functionality can be shared. Individual Windows users who want to use the network device must install the software on their computers (clients).

A client computer can connect to the device in the following ways:

- In the Printers folder, double-click the **Add Printer** icon and follow the instructions for a network installation. For more information, see [To install the printer driver using Add Printer](#).
- On the network, browse to the device and drag it to your Printers folder.
- Add the device and install the software from the INF file on your network. On the Starter CD, the INF files are stored in the root directory of the CD.

To install the printer driver using Add Printer

1. Click **Start**, point to **Settings**, and then click **Printers** or **Printers and Faxes**.
- Or -
Click **Start**, click **Control Panel**, and then double-click **Printers**.
2. Double-click **Add Printer**, and then click **Next**.
3. Select **Network Printer** or **Network Printer Server**.
4. Click **Next**.
5. Do one of the following:
Type in the network path or queue name of the shared device, and then click **Next**.
Click **Have Disk** when prompted to select the device model.
Click **Next** and locate the device in the list of shared printers.
6. Click **Next** and follow the onscreen instructions to complete the installation.

Configure the device (Mac OS)

You can use the device with a single Macintosh computer using a USB cable, or you can share it among other users on a network.

This section contains the following topics:

- [To install the software for network or direct connection](#)
- [To share the device on a locally shared network](#)

To install the software for network or direct connection

1. Connect the device to your computer with a USB cable.
2. Insert the Starter CD into the CD drive. Double-click the CD icon on the desktop, and then double-click the setup icon. Also, you can locate the Installer folder on the Starter CD.
3. Click **Install Software** and follow the onscreen instructions.
4. If necessary, share the device with other Macintosh computer users.
 - **Direct connection:** Share the device with the other Macintosh computer users. For more information, see [To share the device on a locally shared network](#).
 - **Network connection:** Individual Macintosh computer users who want to use the device on the network must install the device software on their computers.

To share the device on a locally shared network

When you connect the device directly, you can share it with other computers using a simple form of networking known as locally shared networking. Use this configuration only in small groups or when usage is low. The connected computer is slowed down when many users print to the device.

Basic requirements for sharing in the Mac OS environment include the following items:

- The Macintosh computers must be communicating on the network using TCP/IP, and they must have IP addresses. (AppleTalk is not supported.)
- The device that is being shared must be connected to a built-in USB port on the host Macintosh computer.
- Both the host Macintosh computer and the client Macintosh computers that are using the shared device must have device sharing software installed, and the driver or PPD for the device that is installed. (You can run the installation program to install the device sharing software and associated Help files.)

For more information about USB device sharing, see the support information on the Apple Web site (www.apple.com) or the Apple Macintosh Help on the computer.

To share the device among computers running Mac OS

1. Turn on printer sharing on all Macintosh computers (host and clients) that are connected to the printer. Depending on the OS version you are using, do one of the following:
 - **Mac OS 10.3:** Open **System Preferences**, click **Print & Fax**, and then check the box next to **Share my printers with other computers**.
 - **Mac OS 10.4:** Open **System Preferences**, click **Print & Fax**, click the **Sharing** tab, check the box next to **Share these printers with other computers**, and then select the printer to be shared.
2. To print from the other Macintosh computers (the clients) on the network, do the following:
 - a. Click **File**, and then select **Page Setup** in the document you want to print.
 - b. In the drop-down menu next to **Format for**, select **Shared Printers**, and then select your device.
 - c. Select the **Paper Size**, and then click **OK**.
 - d. In the document, click **File**, and then select **Print**.
 - e. From the drop-down menu next to **Printer**, select **Shared Printers**, and then select your device.
 - f. Make additional settings, if necessary, and then click **Print**.

Set up the device for wireless communication (some models only)

You may set up the device for wireless communication using one of the following ways:

Wireless communication mode	Infrastructure	Ad hoc*
Control panel	✓	✓

(continued)

Network cable For more information, see To set up the device on a wireless network (Mac OS) or To set up wireless communication using the installer (Windows) .	✓	✓
SecureEasySetup (SES) For more information, see To set up wireless communication using SecureEasySetup (SES) .	✓	

* An ad hoc network can be set up using the Wireless Connection Utility on the Starter CD.



NOTE: If you encounter problems, see [Solve wireless problems](#).

To use the device with any wireless connection, you must run the installation program at least once from the Starter CD and create a wireless connection.

Make sure the device is not connected to the network using a network cable.

The sending device must have built-in 802.11 capabilities or an 802.11 wireless card installed.

The device and the computers that use it must be on the same subnet.

Before installing the device software, you may wish to find out the settings of your network. Obtain the information from your system administrators, or complete the following tasks:

- Obtain your network's network name or Service Set Identifier (SSID) and communication mode (infrastructure or ad hoc) from the configuration utility for the network's wireless access point (WAP) or the computer's network card.
- Find out the type of encryption your network uses, such as Wired Equivalent Privacy (WEP).
- Find out the security password or encryption key of the wireless device.

Understand 802.11 wireless network settings

Network name (SSID)

By default, the device looks for the wireless network name or SSID named "hpsetup." Your network may have a different SSID.

Communication mode

There are two communication mode options:

- **Ad hoc:** On an ad hoc network, the device is set to ad hoc communication mode and communicates directly with other wireless devices without the use of a WAP. All devices on the ad hoc network must:
 - Be 802.11 compatible
 - Have ad hoc as the communication mode
 - Have the same network name (SSID)

- Be on the same subnet and same channel
- Have the same 802.11 security settings
- **Infrastructure (recommended):** On an infrastructure network, the device is set to infrastructure communication mode and communicates with other devices on the network, whether the devices are wired or wireless, through a WAP. WAPs commonly act as routers or gateways on small networks.

Security settings

 **NOTE:** For the available settings for the device, see [Understand the network configuration page](#).

For more information on wireless security, visit www.weca.net/opensection/pdf/whitepaper_wi-fi_security4-29-03.pdf.

- **Network authentication:** The device's factory default setting is 'Open,' which does not require security for authorization or encryption. The other possible values are 'OpenThenShared,' 'Shared,' and 'WPA-PSK' (Wi-Fi® Protected Access Pre-Shared Key).

WPA increases the level of over-the-air data protection and access control on existing and future Wi-Fi networks. It addresses all known weaknesses of WEP, the original native security mechanism in the 802.11 standard.

WPA2 is the second generation of WPA security; it provides enterprise and consumer Wi-Fi users with a high level of assurance that only authorized users can access their wireless networks.

- **Data encryption:**
 - Wired Equivalent Privacy (WEP) provides security by encrypting data sent over radio waves from one wireless device to another wireless device. Devices on a WEP-enabled network use WEP keys to encode data. If your network uses WEP, you must know the WEP key(s) it uses.
 - WPA uses the Temporal Key Integrity Protocol (TKIP) for encryption and employs 802.1X authentication with one of the standard Extensible Authentication Protocol (EAP) types available today.
 - WPA2 provides a new encryption scheme, the Advanced Encryption Standard (AES). AES is defined in counter cipher-block chaining mode (CCM) and supports the Independent Basic Service Set (IBSS) to enable security between client workstations operating in ad hoc mode.

To set up wireless communication using the control panel with wireless setup wizard

The Wireless Setup Wizard provides an easy way to set up and manage a wireless connection to your device.

 **NOTE:** To use this method, you must have a wireless network set up and running.

1. Set up the device hardware (see the getting started guide or the setup poster that came with your device).
2. On the control panel, press the **Setup** button.
3. Press an arrow button to move to **Network**, and then press **OK**.

4. Press an arrow button to move to **Wizard**, and then press **OK**.
5. Follow the display instructions to complete the setup.

To set up wireless communication using the installer (Windows)

For this method, you will need to have a network set up and running.

1. Set up the device hardware (see the getting started guide).
2. Remove the protective cover from the device's network port.
3. Close any applications that are running on your computer system.
4. Insert the Starter CD into the CD drive. The CD menu runs automatically. If the CD menu does not start automatically, double-click the setup icon on the Starter CD.
5. On the CD menu, click **Install** and follow the onscreen instructions.
6. On the **Connection Type** screen, select **Wireless**, and then click **Next**.

 **NOTE:** If the device cannot be found, you will have the option to temporarily use a network cable to communicate with the device and configure its wireless settings.

Complete the following steps to temporarily connect the printer to your network if you are unable to establish wireless communication.

- a. Temporarily connect the device to the network with an Ethernet cable.

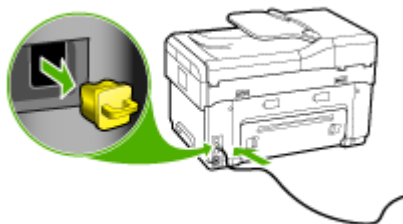

- b. Follow the onscreen instructions and disconnect the cable when prompted.
7. On the **Select a Network Name (SSID)** screen, click **Select a detected Wireless Network Name (SSID)** to select the wireless network, or click **Specify a wireless network** to enter a new network name.
8. If you chose to enter a new network name, enter it on the control panel, and then press **Done**.

 **NOTE:** If the SSID that you entered is not found, you will be asked to provide security information. If the network does not use encryption, setup will attempt to verify the SSID before continuing.

9. If the device cannot connect to the network name, supply the appropriate WEP key or WPA passphrase on the keypad when prompted, and then press **Done**.

 **NOTE:** Be sure to unplug the Ethernet cable when you are done.

To set up wireless communication using SecureEasySetup (SES)

If your wireless router is SES compatible, see the following instructions to set up using SES.

 **NOTE:** You will need a wireless access point with SecureEasySetup to use this method. Set your access point to SecureEasySetup mode. Refer to your access point documentation for more instructions.

1. Press the SES button on the wireless router.



2. Within 2 minutes, press **Setup**. If the device has a two-line display, select **Network**, select **Wireless Setup Wizard**, select **SecureEasySetup**, and then follow the onscreen instructions.
3. Wait about 2 minutes, print the device's self-test diagnostic page, and verify that the SES settings match the router's wireless settings.

 **NOTE:** If the connection fails, you might need to reset the device's network settings or modify the wireless settings and repeat the steps. For more information, see [Solve wireless problems](#).

4. Close any applications that are running on your computer system.
5. Insert the Starter CD into the CD drive. The CD menu runs automatically. If the CD menu does not start automatically, double-click the setup icon on the Starter CD.
6. On the CD menu, click **Install** and follow the onscreen instructions.
7. At the **Connection Type** dialog, select **Wired network/Wireless** and follow the onscreen instructions.

To set up the device on a wireless network (Mac OS)

1. Set up the device hardware (see the getting started guide).
2. Ensure an AirPort card is installed on the computer.
3. Close any applications that are running on your computer system.
4. Open the **AirPort Setup Assistant** from the Utilities folder. Refer to the AirPort documentation for details on setting up on wireless networks.

5. For ad hoc networks, click the **AirPort** icon on the menu bar and select "hpsetup" under **Computer to Computer Networks**. For wireless networks, click the **AirPort** icon, and then click **Other** to join the network.
6. Insert the Starter CD into the CD drive. The CD menu runs automatically. If the CD menu does not start automatically, double-click the setup icon on the Starter CD.
7. On the CD menu, click **Install Software** and follow the onscreen instructions.
8. On the **Connection Type** screen, select the wireless network option, and then click **Done**.
9. Follow the onscreen instructions in the **Network Printer Setup Utility**, which starts running automatically, to install the printer driver.

To turn off wireless communication

On the control panel, press **Setup**, then select **Network Menu**, then select **Wireless Radio**, and then select either **On** or **Off**.

Guidelines for reducing interference on a wireless network

The following tips will help reduce the chances for interference in a wireless network:

- Keep the wireless devices away from large metal objects, such as filing cabinets, and other electromagnetic devices, such as microwaves and cordless telephones, as these objects can disrupt radio signals.
- Keep the wireless devices away from large masonry structures and other building structures as these objects can absorb radio waves and lower signal strength.
- For an infrastructure network, position the WAP in a central location in line of sight with the wireless devices on the network.
- Keep all wireless devices on the network within range of one another.

Guidelines for ensuring wireless network security

- [To add hardware addresses to a WAP](#)
- [Other guidelines](#)

To add hardware addresses to a WAP

MAC filtering is a security feature in which a WAP is configured with a list of MAC addresses (also called "hardware addresses") of devices that are allowed to gain access to the network through the WAP.

If the WAP does not have the hardware address of a device attempting to access the network, the WAP denies the device access to the network.

If the WAP filters MAC addresses, then the device's MAC address must be added to the WAP's list of accepted MAC addresses.

1. Print the network configuration page. For information on the network configuration page, see [Understand the network configuration page](#).
2. Open the WAP's configuration utility, and add the device's hardware address to the list of accepted MAC addresses.

Other guidelines

To keep the wireless network secure, follow these guidelines:

- Use a password with at least 20 random characters. You can use up to 63 characters in a WPA password.
- Avoid any common words or phrases, easy sequences of characters (such as all 1s), and personally-identifiable information for passwords. Always use random strings composed of uppercase and lowercase letters, numbers, and if allowed, special characters such as punctuation.
- Change the password periodically.
- Change the default password provided by the manufacturer for administrator access to the access point or wireless router. Some routers let you change the administrator name as well.
- Place the access point or router in the center of a room and not near a window.
- Turn off administrative access over wireless if possible. If you do this, you need to connect to the router with a wired Ethernet connection when you want to make configuration changes.
- Turn off remote administrative access over the Internet on your router, if possible. You can use Remote Desktop to make an encrypted connection to a computer running behind your router and make configuration changes from the local computer you are accessing over the Internet.
- To avoid accidentally connecting to another party's wireless network, turn off the setting to automatically connect to non-preferred networks. This is disabled by default in Windows XP.

Set up the device for Bluetooth communication

The HP Bluetooth Wireless Printer Adapter allows you to print documents from Bluetooth devices without a cable connection. Simply insert the HP Bluetooth adapter into the front USB port and print from a Bluetooth device such as a PDA or camera phone. You can also use Bluetooth technology to print from a computer to the device.

To set up the device for Bluetooth communication from the control panel

1. Insert the HP Bluetooth Adapter into the front USB port (shown in the graphic below).

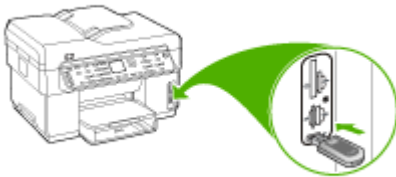

2. Some Bluetooth devices exchange addresses when they communicate with each other and establish a connection. Also, some Bluetooth devices display the name of the other device when connected. If you do not want the default name displayed as the name of your device, you can change the device name.

Do the following, as appropriate:

To find out the address of the device

- a. Press **Setup**.
- b. Select **Bluetooth**, and then select **Device Address**. The device address is displayed, which is read only.
- c. To enter the address into your all-in-one, follow the instructions that came with your Bluetooth device.

To change the name of the device from the default

- a. Press **Setup**.
- b. Select **Bluetooth**, and then select **Device Name**.

 **NOTE:** The device ships with the predefined name of "**Officejet L7XXX Series.**"

- c. Use the keypad to enter a new name.
 - d. When you have finished entering a name for the device, press **OK**.
The name you entered will appear on your Bluetooth device when you connect to the device to print.
3. Press **OK** to exit the Setup menu.

To set up the device for Bluetooth communication via the embedded Web server

- ▲ Open the embedded Web server, click the **Bluetooth** tab, complete the required fields in each section, and then click **Apply**.

To change the device name from the default via the embedded Web server

- ▲ Open the embedded Web server, click the **Bluetooth** tab, type a new name in the **Device Name** field, and then click **Apply**.

Connect the device with Bluetooth

With a Bluetooth connection you can access many of the same printing features as with a USB connection. For example, you can check the device status, as well as the estimated amount of ink remaining in your ink cartridges.

 **NOTE:** The only software functionality available with a Bluetooth connection is printing. Scanning and software-based faxing cannot be done over a Bluetooth connection. However, stand-alone copy and fax functions are still available.

Connecting the device with Bluetooth on Windows

You must have Windows XP and either the Microsoft Bluetooth Protocol Stack or the Widcomm/Broadcom Bluetooth Protocol Stack installed in order to connect the device.

It is possible to have both the Microsoft Stack and the Widcomm/Broadcom Stack on your computer, but use only one of them to connect the device.

- **Microsoft stack:** If you have Windows XP with Service Pack 2 installed on your computer, then your computer has the Microsoft Bluetooth Protocol Stack. The Microsoft stack allows you to install an external Bluetooth adapter automatically. If your Bluetooth adapter supports the Microsoft stack but it does not install automatically, then you do not have the Microsoft stack on your computer. Check the documentation that came with the Bluetooth adapter to see if it supports the Microsoft stack.
- **Widcomm/Broadcom stack:** If you have an HP computer with Bluetooth built in, or if you have installed an HP Bluetooth adapter, then your computer has the Widcomm/Broadcom stack. If you have an HP computer and plug in an HP Bluetooth adapter, it will install automatically using the Widcomm/Broadcom stack.

To install and print using the Microsoft stack

 **NOTE:** Make sure that you have installed the device software on the computer. The purpose of installing the software is to make sure the printer driver is available for the Bluetooth connection. Therefore, if you have already installed the software, you do not need to reinstall it. If you want both a USB and a Bluetooth connection to the device, install the USB connection first. For more information, see [Direct connection](#). However, if you do not want a USB connection, select **Directly to the computer** on the **Connection Type** screen. Also, on the **Connect Your Device Now** screen, select the check box next to **If you are unable to connect your device now...** at the bottom of the screen.

1. Attach an HP Bluetooth adapter to the front USB port of the device.
2. If you are using an external Bluetooth adapter for your computer, make sure your computer is started and then attach the Bluetooth adapter to a USB port on the computer. If you have Windows XP with Service Pack 2 installed, the Bluetooth drivers are installed automatically. If you are prompted to select a Bluetooth profile, select **HCRP**.
If your computer has Bluetooth built in, just make sure the computer is started.
3. On the Windows taskbar, click **Start**, and then click **Printers and Faxes**.
4. Double-click the **Add Printer** icon.
5. Click **Next**, and then select **A Bluetooth Printer**.
6. Follow the onscreen instructions to finish the installation.
7. Print as you would to any printer.

To install and print using the Widcomm/Broadcom stack

1. Make sure that you have installed the device software on the computer.
2. Attach an HP Bluetooth adapter to the front USB port.
3. Click the **My Bluetooth Places** icon on the desktop or in the taskbar.
4. Click **View devices in range**.
5. Once the available devices are discovered, double-click the name of the device to finish the installation.
6. Print as you would to any device.

Connect the device with Bluetooth on Mac OS

You can connect the device to a Mac that has Bluetooth built in, or you can install an external Bluetooth adapter.

To install and print using Bluetooth

 **NOTE:** Mac Bluetooth must be enabled in the OS. To verify, open **System Preferences**, click on **Network**, select **Network Port Configurations**, and then assure that **Bluetooth** is checked.

1. Make sure that you have installed the device software on the computer.
2. Attach an HP Bluetooth Adapter to the front USB port of the device.
3. Press the **Power** button on the control panel to turn the device off, and press it again to turn it on.
4. Attach an HP Bluetooth adapter to the computer and turn it on. Make sure that you have installed the software that came with the adapter. Or, if your computer has Bluetooth built in, just turn on your computer.
5. Open the **Printer Setup Utility**.
6. In the **Printer List**, click **Add**.
The computer searches for the device.
7. Depending on the Mac OS version you are using, do one of the following:
 - ▲ **Mac OS 10.3:** Select **Bluetooth** from the pull-down menu.
 - ▲ **Mac OS 10.4:** Assure that connection type **Bluetooth** is selected in the **Default Browser** tab.
8. Select **Bluetooth** from the pull-down menu. Select the all-in-one and click **Add**.
The all-in-one is added to the device list.
9. Print as you would to any device.

Set Bluetooth security for the device

You can enable the following device security settings either through the control panel menu or the embedded Web server:

- Require passkey authentication prior to someone printing to the device from a Bluetooth device.
- Make the device visible or invisible to Bluetooth devices that are within range.

Use a passkey to authenticate Bluetooth devices

You can set the security level of the device to either **High** or **Low**.

- **Low:** The device does not require a passkey. Any Bluetooth device within range can print to it.

 **NOTE:** The default security setting is **Low**. Low level security does not require authentication.

- **High:** The device requires a passkey from the Bluetooth device before allowing it to send a print job to it. The passkey must be 1 to 4 characters long, and can only consist of numbers.

 **NOTE:** The device ships with a predefined passkey that is set to four zeroes "0000".

To set the device to require passkey authentication via the control panel

1. Press **Setup**.
2. Select **Bluetooth**, and then select **Passkey**.
3. Use the keypad to enter a new passkey.
4. When you have finished entering your passkey, press **OK**.
5. Select **Security Level**, and then select **High**.
6. Press **OK**.
High level security requires authentication.
Passkey authentication is now set for the device.

To set the device to require passkey authentication via the embedded Web server

- ▲ Open the embedded Web server, click the **Bluetooth** tab, enter a new passkey in the Passkey section, click **High** in the Security Level section, and then click **Apply**.

To set the device to be visible or not visible to Bluetooth devices

You can set the device to be either visible to Bluetooth devices (public) or not visible to any (private).

- **Visible:** Any Bluetooth device within range can print to the device.
- **Not visible:** Only Bluetooth devices that have stored the device address of the all-in-one can print to it.

 **NOTE:** The device ships with a default accessibility level of **Visible**.

To set the device to be not visible from the control panel

1. Press **Setup** on the control panel.
2. Press **Bluetooth**, and then press **Visibility**.
3. Use the arrow buttons to select **Not Visible**, and then press **OK**.
The all-in-one is inaccessible to Bluetooth devices that have not stored its device address.

To set the device to be not visible from the embedded Web server

- ▲ Open the embedded Web server, click the **Bluetooth** tab, select **Not Visible** in the **Visibility** section, and then click **Apply**.

Reset Bluetooth settings via the embedded Web server

To reset Bluetooth settings on the device to the factory defaults:

1. Open the embedded Web server, and then click the **Bluetooth** tab.
2. Click **Reset Bluetooth** in the Reset Bluetooth section, and then click **Apply**.

Uninstall and reinstall the software

If your installation is incomplete, or if you connected the USB cable to the computer before prompted by the software installation screen, you might need to uninstall and then reinstall the software. Do not simply delete the device application files from your computer. Make sure to remove them properly using the uninstall utility provided when you installed the software that came with the device.

There are three methods to uninstall the software on a Windows computer, and one method to uninstall on a Macintosh computer.

To uninstall from a Windows computer, method 1

1. Disconnect the device from your computer. Do not connect it to your computer until after you have reinstalled the software.
2. Press the **Power** button to turn off the device.
3. On the Windows taskbar, click **Start**, select **Programs** or **All Programs**, select **HP**, select **Officejet Pro L7XXX Series**, and then click **Uninstall**.
4. Follow the onscreen instructions.
5. If you are asked whether you would like to remove shared files, click **No**. Other programs that use these files might not work properly if the files are deleted.
6. Restart your computer.
7. To reinstall the software, insert the device Starter CD into your computer's CD-ROM drive, follow the onscreen instructions, and also see [To install the software before connecting the device \(recommended\)](#).
8. After the software is installed, connect the device to your computer.
9. Press the **Power** button to turn the device on. After connecting and turning on the device, you might have to wait several minutes for all of the Plug and Play events to complete.
10. Follow the onscreen instructions.

When the software installation is complete, the **HP Digital Imaging Monitor** icon appears in the Windows system tray.

To uninstall from a Windows computer, method 2



NOTE: Use this method if **Uninstall** is not available in the Windows Start menu.

1. On the Windows taskbar, click **Start**, select **Settings**, select **Control Panel**, and then click **Add/Remove Programs**.
- Or -
Click **Start**, click **Control Panel**, and then double-click **Programs and Features**.
2. Select **HP Officejet Pro All-in-One Series**, and then click **Change/Remove or Uninstall/Change**.
Follow the onscreen instructions.
3. Disconnect the device from your computer.
4. Restart your computer.

 **NOTE:** It is important that you disconnect the device before restarting your computer. Do not connect the device to your computer until after you have reinstalled the software.

5. Insert the device Starter CD into your computer's CD-ROM drive and then start the Setup program.
6. Follow the onscreen instructions and also see [To install the software before connecting the device \(recommended\)](#).

To uninstall from a Windows computer, method 3

 **NOTE:** Use this method if **Uninstall** is not available in the Windows Start menu.

1. Insert the device Starter CD into your computer's CD-ROM drive, and then start the Setup program.
2. Disconnect the device from your computer.
3. Select **Uninstall** and follow the onscreen directions.
4. Restart your computer.

 **NOTE:** It is important that you disconnect the device before restarting your computer. Do not connect the device to your computer until after you have reinstalled the software.

5. Start the Setup program for the device again.
6. Select **Install**.
7. Follow the onscreen instructions and also see [To install the software before connecting the device \(recommended\)](#).

To uninstall from a Macintosh computer

1. Launch **HP Device Manager**.
2. Click **Information and Settings**.
3. Select **Uninstall HP AiO Software** from the pull-down menu.
Follow the onscreen instructions.
4. After the software is uninstalled, restart your computer.
5. To reinstall the software, insert the device Starter CD into your computer's CD-ROM drive.

6. On the desktop, open the CD-ROM, and then double-click **HP All-in-One Installer**.
7. Follow the onscreen instructions and also see [To install the software before connecting the device \(recommended\)](#).

10 Maintain and troubleshoot

This section contains the following topics:

- [Supported ink cartridges](#)
- [Replace the ink cartridges](#)
- [Maintain the printheads](#)
- [Store printing supplies](#)
- [Clean the device](#)
- [Troubleshooting tips and resources](#)
- [Solve printing problems](#)
- [Poor print quality and unexpected printouts](#)
- [Solve paper-feed problems](#)
- [Solve copy problems](#)
- [Solve scan problems](#)
- [Solve fax problems](#)
- [Solve photo \(memory card\) problems](#)
- [Solve device management problems](#)
- [Troubleshoot installation issues](#)
- [Clear jams](#)

Supported ink cartridges

The availability of ink cartridges varies by country/region. The ink cartridges might come in different sizes. To obtain a list of supported ink cartridges for your device, print the self-test diagnostic page and read the information in the ink cartridge status section. [For more information, see [Understand the self-test diagnostic page](#) .]

You can find the ink cartridge number in the following places:

- On the self-test diagnostic page (see [Understand the self-test diagnostic page](#)).
- On the label of the ink cartridge you are replacing.
- **Windows:** From the **Toolbox**, if you have bidirectional communication, click the **Estimated Ink Levels** tab, scroll to display the **Cartridge Details** button, and then click **Cartridge Details**.
- **Mac OS:** From the **HP Printer Utility**, click **Supply Info** from the **Information and Support** panel, and then click **Retail Supplies Information**.

 **NOTE:** Ink from the cartridges is used in the printing process in a number of different ways, including in the initialization process, which prepares the device and cartridges for printing, and in printhead servicing, which keeps print nozzles clear and ink flowing smoothly. In addition, some residual ink is left in the cartridge after it is used. For more information see www.hp.com/go/inkusage.

Replace the ink cartridges

You can check the estimated ink levels from the Toolbox (Windows), the HP Printer Utility (Mac OS), or the embedded Web server. For information about using these tools, see [Use device management tools](#). You can also print the self-test diagnostic page to view this information (see [Understand the self-test diagnostic page](#)).

 **NOTE:** The ink levels shown are an estimate only. Actual ink volumes may vary.

After removing a cartridge from its package, install it right away. Do not remove a cartridge from the device for long periods of time.

To find out which ink cartridges work with your device, see [Supplies](#).

To replace the ink cartridges

1. Gently pull open the ink cartridge cover.

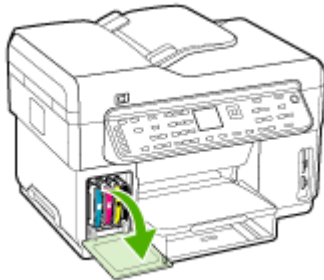

2. Remove the ink cartridge that requires replacement by grasping it between your thumb and forefinger and pulling it firmly toward you.

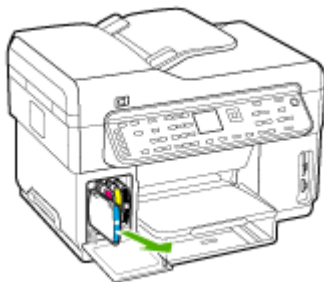

3. Remove the new ink cartridge from its package.
4. Align the cartridge with its color-coded slot and insert the cartridge into the slot. Press down firmly on the cartridge to ensure proper contact.
5. Close the ink cartridge cover.

Maintain the printheads

If printed characters are incomplete, or dots or lines are missing from printouts, ink nozzles might be clogged and you might need to clean the printheads.

When the quality of printouts deteriorates, complete the relevant steps based on the following sequence:

1. Check the health of the printheads. For more information, see [To check printhead health](#).
2. Print the print quality diagnostic page on a clean sheet of white paper. Evaluate any problem areas, and perform the recommended actions. For more information, see [To print the print quality diagnostic page](#).
3. Manually clean the printhead contacts. For more information, see [To clean the printheads](#).
4. Replace the printheads if the problems persist after cleaning. For more information, see [To replace the printheads](#).

△ **CAUTION:** HP is not responsible for damage to the device that results from modifying the printheads.

To check printhead health

Use one of the following means to check the printhead health. If the status of any printhead is not good or fair, then perform one or more of the maintenance functions, or clean or replace the printhead.

- **Self-Test Diagnostic page:** Print the self-test diagnostic page on a clean sheet of white paper, and check the printhead health section. For more information, see [Understand the self-test diagnostic page](#).
- **Embedded Web server:** Open the embedded Web server. For more information, see [To open the embedded Web server](#). Click the **Information** tab, and then click **Ink Supplies** in the left pane.
- **Toolbox (Windows):** Open the Toolbox. For more information, see [To open the Toolbox](#). Click the **Information** tab, and then click **Printhead Health**.

To print the print quality diagnostic page

Use the print quality diagnostic page to diagnose issues affecting the print quality. This will help you decide whether to run any maintenance tools to improve the print quality of your printouts. You can also view the ink level information, and the printhead health status on the page.

- **Control panel:** Press the **Setup** button, select **Print Report**, select **Print Quality Page**, and then press **OK**.
- **Embedded Web server:** Click the **Settings** tab, click **Device Services** in the left pane, select **Print PQ (print quality) diagnostic page** from the drop-down list in the **Print Quality** section, and then click **Run Diagnostic**.
- **Toolbox (Windows):** Click the **Services** tab, and then click **Print PQ (print quality) diagnostic page** and follow the onscreen instructions.
- **HP Printer Utility (Mac OS):** Click **Print Quality Diagnostics** from the **Information and Support** panel.

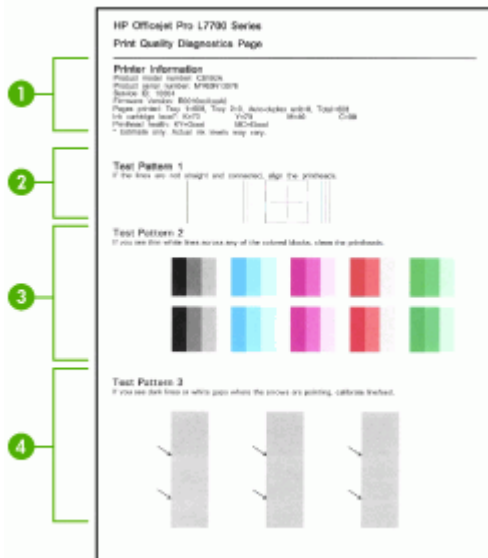

1	Printer Information: Shows device information (such as the product model number, serial number, and firmware version number), the number of pages printed from the trays and duplexer, the ink level information, and the printhead health status.
2	Test Pattern 1: If the lines are not straight and connected, align the printheads. For more information, see To align the printheads .
3	Test Pattern 2: If there are thin white lines across any of the colored blocks, clean the printheads. For more information, see To clean the printheads .
4	Test Pattern 3: If there are dark lines or white gaps where the arrows are pointing, calibrate the linefeed. For more information, see To calibrate the linefeed .

To align the printheads

Whenever you replace a printhead, the device automatically aligns the printheads to ensure the best print quality. However, if the appearance of your printed pages indicates that the printheads are misaligned, you can start the alignment process manually.

- **Control panel:** Press the **Setup** button, select **Tools**, select **Align Printer**, and then press **OK**. Press **OK** when the alignment is done to continue.
- **Embedded Web server:** Click the **Settings** tab, click **Device Services** in the left pane, select **Align Printheads** from the drop-down list in the **Print Quality** section, and then click **Run Diagnostic**.
- **Toolbox (Windows):** Click the **Services** tab, and then click **Align Printheads** and follow the onscreen instructions.
- **HP Printer Utility (Mac OS):** Click **Align** from the **Information and Support** panel.

To calibrate the linefeed

- **Control panel:** Press the **Setup** button, select **Tools**, select **Calibrate Linefeed**, and then press **OK**.
- **Embedded Web server:** Click the **Settings** tab, click **Device Services** in the left pane, select **Calibrate Linefeed** from the drop-down list in the **Print Quality** section, and then click **Run Diagnostic**.
- **Toolbox (Windows):** Click the **Services** tab, and then click **Calibrate Linefeed** and follow the onscreen instructions.
- **HP Printer Utility (Mac OS):** Click **Calibrate Linefeed** from the **Information and Support** panel.

To clean the printheads



NOTE: Cleaning uses ink, so clean the printheads only when necessary.

The cleaning process takes up to 3.5 minutes. Some noise might be generated in the process.

- **Control panel:** Press the **Setup** button, select **Tools**, and then select **Clean Printhead**.
- **Embedded Web server:** Click the **Device Settings** tab, click **Device Services** in the left pane, select **Clean printheads** from the drop-down list in the **Print Quality** section, and then click **Run Diagnostic**.
- **Toolbox (Windows):** Click the **Services** tab, and then click **Clean Printheads** and follow the onscreen instructions.
- **HP Printer Utility (Mac OS):** Click **Clean** from the **Information and Support** panel.

To clean the printhead contacts manually

After the printheads are installed, you might get a control panel message telling you the device will not print. If you receive this message, you might need to clean the electrical contacts on the printheads and in the device.

△ **CAUTION:** Clean the electrical contacts only after you have attempted to clean the printheads. Electrical contacts contain sensitive electronic components that can be damaged easily. For more information, see [To clean the printheads](#).

1. Open the top cover.
2. If the carriage does not move to the left automatically, press and hold the **OK** button for five seconds. Wait for the carriage to stop moving, and then unplug the power cord from the printer.

3. Lift the printhead latch.



4. Lift the handle of the printhead (which corresponds to the control panel message) and use it to pull the printhead out of its slot.

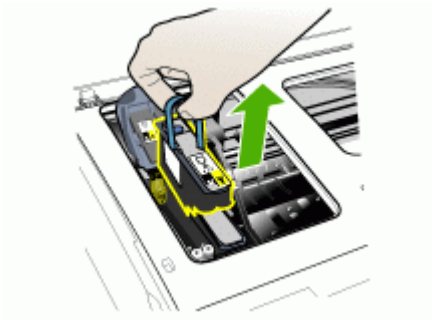

5. Obtain clean, dry, soft and lint-free cleaning material. Suitable materials include paper coffee filters and eyeglass lens cleaning paper.

△ **CAUTION:** Do not use water.

6. Wipe the electrical contacts on the printhead but do not touch the nozzles.

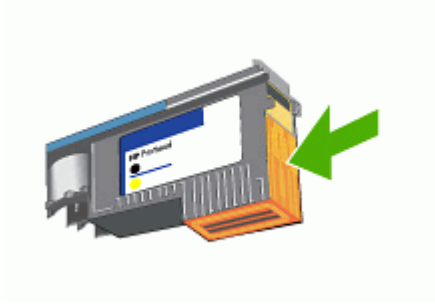

 **NOTE:** The electrical contacts are small copper-color squares, grouped on one face of the printhead.

The nozzles are on a different face of the printhead. Ink will be visible on the nozzles.

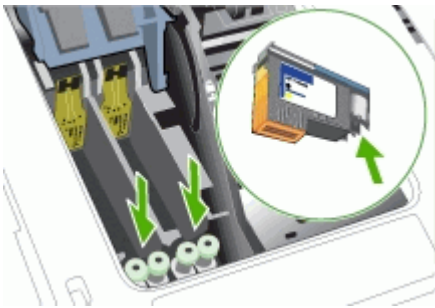

 **CAUTION:** Touching the nozzles can cause permanent nozzle damage. Also, ink can permanently mark clothing.

7. After cleaning, place the printhead on a sheet of paper or paper towel. Make sure the nozzles are facing up and are not in contact with the paper.

8. Clean the electrical contacts in the printhead slot inside the device with a clean, dry, soft and lint-free cloth.

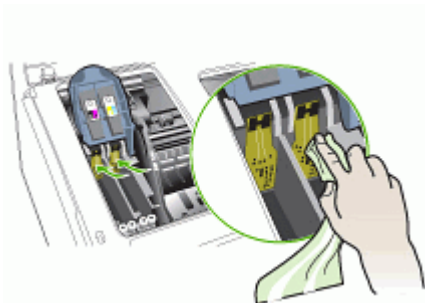

9. Plug in the power cord and turn on the device. The control panel should indicate that the printhead is missing.
10. Insert the printhead into its color-coded slot (the label on the printhead must match the label on the printhead latch). Press down firmly on the printhead to ensure proper contact.
11. Pull the printhead latch all the way forward, and then press down to ensure that the latch is properly engaged. You might have to apply some pressure to engage the latch.
12. Where necessary, repeat the above steps for the remaining printhead.
13. Close the top cover.
14. If the control panel message remains, repeat the cleaning procedure described above for the printhead which corresponds to the message.
15. If the control panel message remains, replace the printhead which corresponds to the message.
16. Wait while the device initializes the printheads and prints the alignment pages. If the device does not print the pages, start the alignment process manually. For more information, see [To align the printheads](#).

To replace the printheads

 **NOTE:** To find out which printheads work with your printer, see [Supplies](#).

1. Open the top cover.
2. If the carriage does not move to the left automatically, press and hold the **OK** button for 5 seconds. Wait for the carriage to stop moving.

3. Lift the printhead latch.



4. Lift the handle of a printhead and use it to pull the printhead out of its slot.

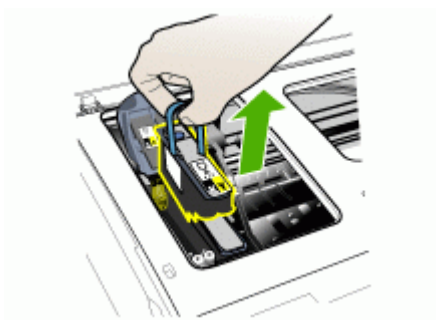

5. Before installing a printhead, shake the printhead up and down at least six times while the printhead is still in its packaging.



6. Remove the new printhead from its package, and then remove its orange protective caps.



△ **CAUTION:** Do not shake printheads after the caps are removed.

7. Insert the printhead into its color-coded slot (the label on the printhead must match the label on the printhead latch). Press down firmly on the printhead to ensure proper contact.
8. Pull the printhead latch all the way forward, and then press down to ensure that the latch is properly engaged. You might have to apply some pressure to engage the latch.
9. Close the top cover.
10. Wait while the device initializes the printheads and prints the alignment pages. If the device does not print the pages, start the alignment process manually. For more information, see [To align the printheads](#).

Store printing supplies

This section covers the following topics:

- [Store ink cartridges](#)
- [Store printheads](#)

Store ink cartridges

Ink cartridges can be left in the device for extended periods of time. If you remove the ink cartridges, place them in an airtight container, such as a resealable plastic bag.

Store printheads

Printheads can be left in the device for extended periods of time. If you remove the printheads, place them in an airtight container, such as a resealable plastic bag.

Clean the device

This section provides instructions for keeping the device in top working condition. Perform these maintenance procedures as necessary.

Dust or dirt on the scanner glass, ADF lid backing, or ADF frame can slow down performance, degrade the quality of scans, and affect the accuracy of special features such as fitting copies to a certain page size.

Clean the scanner glass

To clean the scanner glass

1. Turn off the device.
2. Lift the ADF.
3. Clean the glass by using a soft, lint-free cloth that has been sprayed with a mild glass cleaner. Dry the glass with a dry, soft, lint-free cloth.



△ **CAUTION:** Use only glass cleaner to clean the scanner glass. Avoid cleaners that contain abrasives, acetone, benzene, and carbon tetrachloride, all of which can damage the scanner glass. Avoid isopropyl alcohol because it can leave streaks on the glass.

CAUTION: Do not spray the glass cleaner directly on the glass. If too much glass cleaner is applied, the cleaner could leak under the glass and damage the scanner.

4. Close the ADF, and turn on the device.

Clean the automatic document feeder (ADF)

The ADF requires periodic cleaning depending on the amount of use and the type of paper that is fed through it. If you use the ADF several times per week, monthly cleaning is recommended. Set up a cleaning routine that is appropriate for the device.

If streaks exist on scanned documents, cleaning the ADF frame might solve the problem.

To clean the ADF

1. Turn off the device.
2. Lift the ADF.



3. Locate the ADF frame on the underside of the ADF.

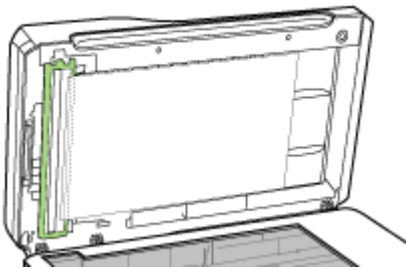

4. Press the ADF frame release.

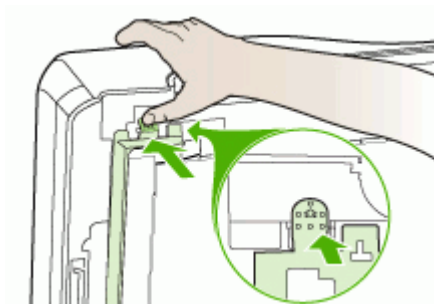

5. Unhook and remove the ADF frame.

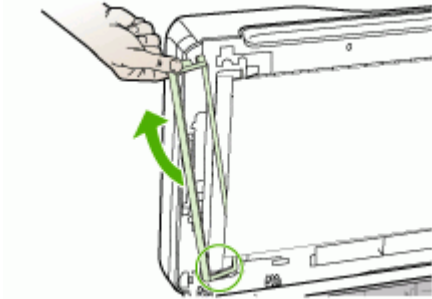

6. Clean the ADF frame by using a soft, lint-free cloth that has been sprayed with a mild glass cleaner. Clean both sides of the transparent film, including the white strip on the inside of the ADF frame.



△ **CAUTION:** Use only glass cleaner. Avoid cleaners that contain abrasives, acetone, benzene, and carbon tetrachloride, all of which can damage the ADF frame. Avoid isopropyl alcohol because it can leave streaks.

7. Follow these steps to replace the ADF frame:
 - a. Lift the ADF lid backing, and then hook the ADF frame into the ADF lid.

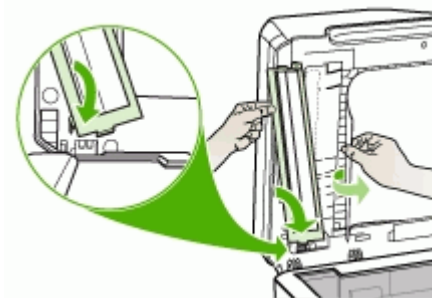

- b. Slide the ADF frame under the backing, and then snap it into place.

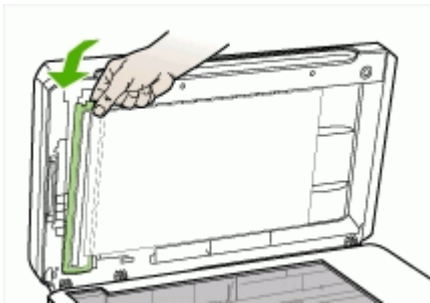

△ **CAUTION:** ADF frame must be under the backing for ADF to function.

- 8. Close the ADF and then turn on the device.

To clean the ADF lid backing

- 1. Turn off the device.
- 2. Lift the ADF.
- 3. Clean the white ADF lid backing by using a soft, lint-free cloth that has been sprayed with a mild glass cleaner. Wash the backing gently to loosen debris; do not scrub the backing.



- 4. Dry the backing with a dry, soft, lint-free cloth.

△ **CAUTION:** Do not use paper-based wipes, because these might scratch the backing.

- 5. If this does not clean the backing thoroughly, repeat the previous steps using isopropyl (rubbing) alcohol. Wipe the backing with a damp cloth to remove any residual alcohol, and then dry the backing with a dry, soft, lint-free cloth.
- 6. Close the ADF and then turn on the device.

Clean the exterior



NOTE: Before cleaning the device, turn off the power and unplug the power cord from the electrical socket.

Use a soft, damp, lint-free cloth to wipe dust, smudges, and stains off of the case. The exterior of the device does not require cleaning. Keep fluids away from the interior of the device, as well as from the control panel.

Troubleshooting tips and resources

Use the following tips and resources to resolve printing problems.

- For a paper jam, see [Clear a jam in the device](#).
- For paper-feed problems, such as the paper skew and paper pick, see [Solve paper-feed problems](#).
- Power light is on and not blinking. When the device is turned on for the first time, it takes approximately 12 minutes to initialize it after the printheads are installed.
- No error messages appear on the computer screen.
- Power cord and other cables are working, and are firmly connected to the device. Make sure the device is connected firmly to a functioning alternating current (AC) power outlet, and is turned on. For voltage requirements, see [Electrical specifications](#).
- Media is loaded correctly in the tray and is not jammed in the device.
- Printheads and ink cartridges are properly installed in their correct color-coded slots. Press down firmly on each one to ensure proper contact. Ensure you have removed the orange protective caps from each printhead.
- Printhead latch and all covers are closed.
- The rear access panel or optional duplexer is locked into place.
- All packing tapes and materials are removed.
- The device can print a self-test diagnostic page. For more information, see [Understand the self-test diagnostic page](#).
- The device is set as the current or default printer. For Windows, set it as the default in the Printers folder. For the Mac OS, set it as the default in the Printer Setup Utility. See your computer's documentation for more information.
- **Pause Printing** is not selected if you are using a computer running Windows.
- You are not running too many programs when you are performing a task. Close programs that you are not using or restart the computer before attempting the task again.
- You can have a static IP address for wired networking, and have a dynamic IP address for wireless networking, and vice versa. For more information, see [To Change IP settings](#).

To set a static IP address

1. Open the embedded Web server, click the **Networking** tab, click **Wired (802.3)** or **Wireless (802.11)** in the left pane, and then click the **IP Configuration** sub-tab.
2. Select **Manual IP**, and then type the static IP address in the **Manual IP Address** box.
3. Enter the **Manual Subnet Mask** and the **Manual Default Gateway**, if necessary, and then click **Apply**.

△ **CAUTION:** Changing the IP address can disrupt the current connection to the embedded Web server.

Solve printing problems

- [The device shuts down unexpectedly](#)
- [Error message appears on control-panel display](#)
- [The device is not responding \(nothing prints\)](#)
- [Device does not accept printhead](#)
- [Device takes a long time to print](#)
- [Blank or partial page printed](#)
- [Something on the page is missing or incorrect](#)
- [Placement of the text or graphics is wrong](#)
- [The device prints half a page, then ejects the paper](#)

The device shuts down unexpectedly

Check the power and power connections

Make sure the device is connected firmly to a functioning alternating current (AC) power outlet. For voltage requirements, see [Electrical specifications](#).

Error message appears on control-panel display

A non-recoverable error has occurred

Disconnect all cables (such as power cord, network cable, and USB cable), wait about 20 seconds, and reconnect the cables. If the problem persists, visit the HP Web site (www.hp.com/support) for the latest troubleshooting information, or product fixes and updates.

The device is not responding (nothing prints)

If the device supports wireless communication, see also [Solve wireless problems](#).

Check the device setup

For more information, see [Troubleshooting tips and resources](#).

Check the printhead initialization

When printheads are installed or replaced, the device automatically prints a few alignment pages to align the printheads. This process takes about 12 minutes. Until this process is complete, only the automatic alignment pages can be printed.

Check the device software installation

If the device is turned off when printing, an alert message should appear on your computer screen; otherwise, the device software might not be installed correctly. To resolve this, uninstall the software completely, and then reinstall the device software. For more information, see [Uninstall and reinstall the software](#).

Check the cable connections

- Make sure both ends of the network/USB cable are secure.
- If the device is connected to a network, check the following:
 - Check the Link light on the back of the device.
 - Make sure you are not using a phone cord to connect the device.
 - The network hub, switch, or router is turned on and working properly.

Check the device setup for a network environment

Ensure the correct device driver and printer driver port are being used. For more information about network connections, see [Configure the device \(Windows\)](#), [Configure the device \(Mac OS\)](#), or the documentation provided by your network vendors.

Check any personal firewall software installed on the computer

The personal software firewall is a security program that protects a computer from intrusion. However, the firewall might block communication between the computer and the device. If there is a problem communicating with the device, try temporarily disabling the firewall. If the problem persists, the firewall is not the source of the communication problem. Re-enable the firewall.

If disabling the firewall allows you to communicate with the device, you might want to assign a static IP address to the device and re-enable the firewall. For more information, see [To Change IP settings](#).

Device does not accept printhead

Check the printhead latch

Make sure the printhead latch is properly closed.

Check the printhead

- Make sure the printhead is inserted into its correct color-coded slot. For more information, see [To replace the printheads](#).
- Remove the printhead, and check to make sure the orange protective caps have been removed from the printhead.

Clean the printhead

Complete the printhead cleaning procedure. For more information, see [Maintain the printheads](#).

Turn off the device after removing the printhead

After removing the printhead, turn off the device, wait about 20 seconds, and turn it on again without the printhead installed. After the device has restarted, reinsert the printhead.

Device takes a long time to print

Check the system configuration

Make sure the computer meets the minimum system requirements for the device. For more information, see [System requirements](#).

Check the device software settings

Print speed is slower when **Best** or **Maximum dpi** is selected as the print quality. To increase the print speed, select different print settings in the device driver. For more information, see [Change print settings](#).

Check for radio interference

If the device is connected using wireless communication and is printing slowly, then the radio signal might be weak. For more information, see [Guidelines for reducing interference on a wireless network](#).

Blank or partial page printed

Check for empty ink cartridges

Check the control panel to see which cartridge is low or empty. The Toolbox (Windows), HP Printer Utility (Mac OS), and the self-test diagnostic page (see [Understand the self-test diagnostic page](#)) provide information about ink levels. If you are printing black text and a blank page prints, the black cartridge might be empty. For more information, see [Replace the ink cartridges](#).

Check the printhead latch

Make sure the printhead latch is properly closed.

Check the printhead

- Make sure the printhead is inserted into its correct color-coded slot. For more information, see [To replace the printheads](#).
- Remove the printhead, and check to make sure the orange protective caps have been removed from the printhead.

Clean the printhead

Complete the printhead cleaning procedure. For more information, see [Maintain the printheads](#).

Turn off the device after removing the printhead

After removing the printhead, turn off the device, wait about 20 seconds, and turn it on again without the printhead installed. After it has restarted, reinsert the printhead.

Something on the page is missing or incorrect

Check the printheads

Print the print quality diagnostic page on a clean sheet of white paper. Evaluate any problem areas, and perform the recommended actions. For more information, see [To print the print quality diagnostic page](#).

Check the margin settings

Make sure the margin settings for the document do not exceed the printable area of the device. For more information, see [Set minimum margins](#).

Check the color print settings

Make sure **Print in Grayscale** is not selected in the print driver.

Check the device location and length of USB cable

High electromagnetic fields (such as those generated by USB cables) can sometimes cause slight distortions to printouts. Move the device away from the source of the electromagnetic fields. Also, it is recommended that you use a USB cable that is less than 3 meters (9.8 feet) long to minimize the effects of these electromagnetic fields.

Placement of the text or graphics is wrong

Check how the media is loaded

Make sure the media width and length guides fit snugly against the edges of the stack of media, and make sure the trays are not overloaded. For more information, see [Load media](#).

Check the media size

- Content on a page might be cut off if the document size is larger than the media that you are using.
- Make sure the media size selected in the printer driver match the size of media loaded in the tray.

Check the margin settings

If the text or graphics are cut off at the edges of the page, make sure the margin settings for the document do not exceed the printable area of your device. For more information, see [Set minimum margins](#).

Check the page-orientation setting

Make sure the media size and page orientation selected in the application match the settings in the printer driver. For more information, see [Change print settings](#).

Check the device location and length of USB cable

High electromagnetic fields (such as those generated by USB cables) can sometimes cause slight distortions to printouts. Move the device away from the source of the electromagnetic fields. Also, it is recommended that you use a USB cable that is less than 3 meters (9.8 feet) long to minimize the effects of these electromagnetic fields.

If the above solutions do not work, the problem may be caused by the inability of the application to interpret print settings properly. See the release notes for known software conflicts, refer to the application's documentation, or contact the software manufacturer for specific help.

The device prints half a page, then ejects the paper

Check the ink cartridges

The ink cartridges may have run out of ink, and the print job was cancelled. Replace the ink cartridges, and then resend the print job to the device. For more information, see [Replace the ink cartridges](#).

Poor print quality and unexpected printouts

- [Poor quality printouts](#)
- [Meaningless characters print](#)
- [Ink is smearing](#)
- [Ink is not filling the text or graphics completely](#)
- [Output is faded or dull colored](#)
- [Colors are printing as black and white](#)
- [Wrong colors are printing](#)
- [Printout shows bleeding colors](#)
- [Colors do not line up properly](#)
- [Lines or dots are missing from text or graphics](#)

Poor quality printouts

Check the printheads and ink cartridges

Print the print quality diagnostic page on a clean sheet of white paper. Evaluate any problem areas, and perform the recommended actions. For more information, see [To print the print quality diagnostic page](#).

Check the paper quality

The paper might be too moist or too rough. Make sure the media meets HP specifications, and try to print again. For more information, see [Select print media](#).

Check the type of media loaded in the device

- Make sure the tray supports the type of media you have loaded. For more information, see [Understand specifications for supported media](#).
- Make sure you have selected the tray in the print driver that contains the media that you want to use.

Check the device location and length of USB cable

High electromagnetic fields (such as those generated by USB cables) can sometimes cause slight distortions to printouts. Move the device away from the source of the electromagnetic fields. Also, it is recommended that you use a USB cable that is less than 3 meters (9.8 feet) long to minimize the effects of these electromagnetic fields.

Meaningless characters print

If an interruption occurs to a job that is printing, the device might not recognize the rest of the job.

Cancel the print job and wait for the device to return to the ready state. If the device does not return to the ready state, cancel all jobs and wait again. When the device is ready, resend the job. If prompted by the computer to retry the job, click **Cancel**.

Check the cable connections

If the device and computer are connected with a USB cable, the problem may be due to a poor cable connection.

Make sure the cable connections at both ends are secure. If the problem persists, turn off the device, disconnect the cable from the device, turn on the device without connecting the cable, and delete any remaining jobs from the print spooler. When the Power light is on and not flashing, reconnect the cable.

Check the document file

The document file may be damaged. If you can print other documents from the same application, try printing a backup copy of your document, if available.

Ink is smearing

Check the print settings

- When you print documents that use much ink, allow more time to dry before handling the printouts. This is especially true for transparencies. In the printer driver, select the **Best** print quality, and also increase the ink drying time and reduce the ink saturation using the ink volume under the advanced features (Windows) or ink features (Mac OS). However, note that decreasing ink saturation might give printouts a "washed-out" quality.
- Color documents that have rich, blended colors can wrinkle or smear when printed using the **Best** print quality. Try using another print mode, such as **Normal**, to reduce ink, or use HP Premium Paper designed for printing vivid color documents. For more information, see [Change print settings](#).

Check the media type

Some types of media do not accept ink well. For these types of media, ink will dry more slowly and smearing may occur. For more information, see [Select print media](#).

Ink is not filling the text or graphics completely

Check the media type

Some media types are not suitable for use with the device. For more information, see [Select print media](#).

Check the printheads

Print the print quality diagnostic page on a clean sheet of white paper. Evaluate any problem areas, and perform the recommended actions. For more information, see [To print the print quality diagnostic page](#).

Output is faded or dull colored

Check the print mode

The **Draft** or **Fast** mode in the printer driver allows you to print at a faster rate, which is good for printing drafts. To get better results, select **Normal** or **Best**. For more information, see [Change print settings](#).

Check the paper type setting

When printing on transparencies or other special media, select the corresponding media type in the print driver. For more information, see [To print on special or custom-sized media \(Windows\)](#).

Colors are printing as black and white

Check the print settings

Make sure **Print in Grayscale** is not selected in the printer driver.

Wrong colors are printing

Check the print settings

Make sure **Print in Grayscale** is not selected in the printer driver.

Check the printheads

Print the print quality diagnostic page on a clean sheet of white paper. Evaluate any problem areas, and perform the recommended actions. For more information, see [To print the print quality diagnostic page](#).

Printout shows bleeding colors

Check the ink cartridges

Make sure ink cartridges have not been tampered with. Refilling processes and the use of incompatible inks can disrupt the intricate printing system and result in reduced print quality and damage to the device or printhead. HP does not guarantee or support refilled ink cartridges. For ordering information, see [HP supplies and accessories](#).

Check the printheads

Print the print quality diagnostic page on a clean sheet of white paper. Evaluate any problem areas, and perform the recommended actions. For more information, see [To print the print quality diagnostic page](#).

Colors do not line up properly

Check the printheads

Print the print quality diagnostic page on a clean sheet of white paper. Evaluate any problem areas, and perform the recommended actions. For more information, see [To print the print quality diagnostic page](#).

Check the graphics placement

Use the zoom or print preview feature of your software to check for gaps in the placement of graphics on the page.

Lines or dots are missing from text or graphics

Check the printheads

Print the print quality diagnostic page on a clean sheet of white paper. Evaluate any problem areas, and perform the recommended actions. For more information, see [To print the print quality diagnostic page](#).

Solve paper-feed problems

For information on resolving jams, see [Clear a jam in the device](#).

Optional Tray 2 cannot be inserted

- Reinsert the tray. Make sure it is aligned with the device opening.
- Check for a paper jam. For more information, see [Clear a jam in the device](#).

Another paper-feed problem is occurring

Media is not supported for the printer or tray

Use only media that is supported for the device and the tray being used. For more information, see [Understand specifications for supported media](#).

Media is not picked up from a tray

- Make sure media is loaded in the tray. For more information, see [Load media](#). Fan the media before loading.
- Make sure the paper guides are set to the correct markings in the tray for the media size you are loading. Also make sure the guides are snug, but not tight, against the stack.
- Make sure media in the tray is not curled. Uncurl paper by bending it in the opposite direction of the curl.
- Make sure that the tray is completely loaded. If you are using special media that is only available in small quantities, try placing the special media on top of other paper of the same size to help fill the tray. (Some media is picked up more easily if the tray is full.)
- Make sure Tray 2 (optional) is inserted properly.

Media is not coming out correctly

- Make sure the output tray extension is extended; otherwise, printed pages may fall off the device.

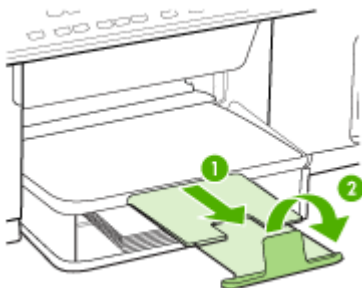

- Remove excess media from the output tray. There is a limit to the number of sheets the tray can hold.

Pages are skewing

- Make sure the media loaded in the trays is aligned to the paper guides. If needed, pull out the trays from the device and reload the media properly, making sure that the paper guides are properly aligned.
- Make sure the rear access panel or duplexer is properly installed.
- Load media into the device only when it is not printing.

Multiple pages are being picked up

- Fan the media before loading.
- Make sure the paper guides are set to the correct markings in the tray for the media size you are loading. Also make sure the guides are snug, but not tight, against the stack.
- Make sure the tray is not overloaded with paper.

- Make sure that the tray is completely loaded. If you are using special media that is only available in small quantities, try placing the special media on top of other paper of the same size to help fill the tray. (Some media is picked up more easily if the tray is full.)
- When reinserting Tray 2 (optional) into the device, do so gently. Forceful insertion with a full stack of paper may cause sheets to slide up within the device, causing the device to jam or pick multiple sheets at one time.
- Use HP media for optimum performance and efficiency.

Solve copy problems

If the following topics do not help, see [Support and warranty](#) for information about HP support.

No copy came out

- **Check the power**
Make sure that the power cord is securely connected, and the device turned on.
- **Check the status of the device**
 - The device might be busy with another job. Check the control-panel display for information about the status of jobs. Wait for any job that is processing to finish.
 - The device might be jammed. Check for jams. See [Clear jams](#).
- **Check the trays**
Make sure that media is loaded. See [Load media](#) for more information.

Copies are blank

- **Check the trays**
 - If you are copying from the ADF, make sure that the originals have been loaded correctly. For more information, see [Load an original in the automatic document feeder \(ADF\)](#).
 - If you are copying from the scanner glass, make sure that the ADF is empty.
- **Check the media**
The media might not meet Hewlett-Packard media specifications (for example, the media is too moist or too rough). See [Select print media](#) for more information.
- **Check the settings**
The contrast setting might be set too light. Use the **Copy** button on the control panel to create darker copies.

Wrong original was copied

Check the trays

If you are copying from the scanner glass, make sure that the ADF is empty.

Documents are missing or faded

- **Check the media**

The media might not meet Hewlett-Packard media specifications (for example, the media is too moist or too rough). See [Select print media](#) for more information.
- **Check the settings**

The quality setting of **Fast** (which produces draft-quality copies) might be responsible for the missing or faded documents. Change to the **Normal** or **Best** setting.
- **Check the original**
 - The accuracy of the copy depends on the quality and size of the original. Use the **Copy** menu to adjust the brightness of the copy. If the original is too light, the copy might not be able to compensate, even if you adjust the contrast.
 - Colored backgrounds might cause images in the foreground to blend into the background, or the background might appear in a different shade.

Size is reduced

- The reduce/enlarge or other copy feature might have been set from the control panel to reduce the scanned image. Check the settings for the copy job to make sure that they are for normal size.
- The HP photo and imaging software settings might be set to reduce the scanned image. Change the settings, if needed. See the onscreen Help for the HP photo and imaging software for more information.

Copy quality is poor

- **Take steps to improve the copy quality**
 - Use quality originals.
 - Load the media correctly. If the media is loaded incorrectly, it might skew, causing unclear images. See [Select print media](#) for more information.
 - Use or make a carrier sheet to protect your originals.
- **Check the device**
 - The ADF might not be closed properly.
 - The scanner glass, ADF lid backing, or ADF window might need cleaning. See [Clean the device](#) for more information.

Copy defects are apparent

- **Vertical white or faded stripes**

The media might not meet Hewlett-Packard media specifications (for example, the media is too moist or too rough). See [Select print media](#) for more information.
- **Too light or dark**

Try adjusting the contrast and copy-quality settings.
- **Unwanted lines**

The scanner glass, ADF lid backing, or ADF frame might need cleaning. See [Clean the device](#) for more information.

- **Black dots or streaks**
Ink, glue, correction fluid, or an unwanted substance might be on the scanner glass or ADF lid backing. Try cleaning the device. See [Clean the device](#) for more information.
- **Unclear text**
 - Try adjusting the contrast and copy-quality settings.
 - The default enhancement setting might not be suitable for the job. Check the setting and change it to enhance text or photographs, if needed. For more information, see [Change the copy settings](#).
- **Incompletely filled text or graphics**
Try adjusting the contrast and copy-quality settings.
- Copy is slanted or skewed
 - Make sure that the ADF input tray is not too full.
 - Make sure that the ADF width adjusters are snug against the sides of the media.
- **Large, black typefaces look splotchy (not smooth)**
The default enhancement setting might not be suitable for the job. Check the setting and change it to enhance text or photographs, if needed. For more information, see [Change the copy settings](#).
- **Horizontal grainy or white bands in light-gray to medium-gray areas**
The default enhancement setting might not be suitable for the job. Check the setting and change it to enhance text or photographs, if needed. For more information, see [Change the copy settings](#).

Error messages appear

“Reload document and then reload job”

Press the **OK** button, and then reload the remaining documents (up to 50 pages) in the ADF. For more information see [Load media](#).

The device prints half a page, then ejects the paper

Check the ink cartridges

The ink cartridges may have run out of ink, and the print job was cancelled. Replace the ink cartridges, and then resend the print job to the device. For more information, see [Replace the ink cartridges](#).

Solve scan problems

If the following topics do not help, see [Support and warranty](#) for information about HP support.

 **NOTE:** If you are starting the scan from a computer, see the software Help for troubleshooting information.

Scanner did nothing

- **Check the original**

Make sure that the original is loaded correctly. For more information, see [Load an original on the scanner glass](#).

- **Check the device**

The device might be coming out of PowerSave mode after a period of inactivity, which delays processing a short while. Wait until the device reaches the **READY** state.

Scan takes too long

- **Check the settings**

- If you set the resolution too high, the scan job takes longer and results in larger files. To obtain good results when scanning or copying, do not use a resolution that is higher than needed. You can lower the resolution to scan more quickly.
- If you acquire an image through TWAIN, you can change the settings so that the original scans in black and white. See the onscreen Help for the TWAIN program for information.

- **Check the status of the device**

If you sent a print or copy job before you tried to scan, the scan starts if the scanner is not busy. However, the printing and scanning processes share memory, which means that the scan might be slower.

Part of the document did not scan or text is missing

- **Check the original**

- Make sure that you loaded the original correctly. For more information, see [Load the originals](#).
- If you scanned the document from the ADF, try scanning the document directly from the scanner glass. For more information, see [Load an original on the scanner glass](#).
- Colored backgrounds can cause images in the foreground to blend into the background. Try adjusting the settings before you scan the original, or try enhancing the image after you scan the original.

- **Check the settings**

- Make sure that the input media size is large enough for the original that you are scanning.
- If you are using the HP photo and imaging software, the default settings in the HP photo and imaging software might be set to automatically perform a specific task other than the one that you are attempting. See the onscreen Help for the HP photo and imaging software for instructions about changing the properties.

Text cannot be edited

- **Check the settings**
 - Make sure that the OCR software is set to edit text.
 - When you scan the original, make sure that you select a document type that creates editable text. If text is classified as a graphic, it is not converted to text.
 - Your OCR program might be linked to a word-processing program that does not perform OCR tasks. See the product software Help for more information about linking programs.
- **Check the originals**
 - For OCR, the original must be loaded into the ADF with the top forward and face-up. Make sure that you loaded the original correctly. For more information, see [Load the originals](#).
 - The OCR program might not recognize text that is tightly spaced. For example, if the text that the OCR program converts has missing or combined characters, "rn" might appear as "m."
 - The accuracy of the OCR program depends on the image quality, text size, and structure of the original and the quality of the scan itself. Make sure that your original has good image quality.
 - Colored backgrounds can cause images in the foreground to blend too much. Try adjusting the settings before you scan the original, or try enhancing the image after you scan the original. If you are performing an OCR operation on an original, any colored text on the original does not scan well, if at all.

Error messages appear

- **"Unable to activate TWAIN source" or "An error occurred while acquiring the image"**
 - If you are acquiring an image from another device, such as a digital camera or another scanner, make sure that the other device is TWAIN-compliant. Devices that are not TWAIN-compliant do not work with the device software.
 - Make sure that you have connected the USB Device Cable to the correct port on the back of your computer.
 - Verify that the correct TWAIN source is selected. In the software, check the TWAIN source by selecting **Select Scanner** on the **File** menu.
- **"Reload document and then restart job"**

Press the **OK** button, and then reload the remaining documents (up to 50 pages) in the ADF. For more information see [Load media](#).

Scanned image quality is poor

The original is a second-generation photo or picture

Reprinted photographs, such as those in newspapers or magazines, are printed by using tiny dots of ink that make an interpretation of the original photograph, which degrades the quality. Often, the ink dots form unwanted patterns that can be detected when the image is scanned or printed or when the image appears on a screen. If the

following suggestions do not solve the problem, you might need to use a better-quality version of the original.

- To eliminate the patterns, try reducing the size of the image after scanning.
- Print the scanned image to see if the quality is better.
- Make sure that the resolution and color settings are correct for the type of scan job.
- For best results, use the flatbed scanner for scanning rather than the ADF.
- **Text or images on the back of a two-sided original appear in the scan**
Two-sided originals can "bleed" text or images from the back side to the scan if the originals are printed on media that is too thin or too transparent.
- **The image quality is better when printed**
The image that appears on the screen is not always an accurate representation of the quality of the scan.
 - Try adjusting your computer monitor settings to use more colors (or levels of gray). On Windows computers, you typically make this adjustment by opening **Display** on the Windows control panel.
 - Try adjusting the resolution and color settings.
- **The scanned image is skewed (crooked)**
The original might have been loaded incorrectly. Be sure to use the media guides when you load the originals into the ADF. For more information, see [Load the originals](#).
- **The scanned image shows blots, lines, vertical white stripes, or other defects**
 - If the scanner glass is dirty, the image produced does not have optimum clarity. See [Clean the device](#) for cleaning instructions.
 - The defects might be on the original and not a result of the scanning process.
- **Graphics look different from the original**
The graphics settings might not be suitable for the type of scan job that you are performing. Try changing the graphics settings.
- **Take steps to improve the scan quality**
 - Use the flatbed scanner to scan rather than the ADF.
 - Use high-quality originals.
 - Load the media correctly. If the media is loaded incorrectly, it might skew, which causes unclear images. For more information, see [Load the originals](#).
 - Adjust the software settings according to how you plan to use the scanned page.
 - Use or make a carrier sheet to protect your originals.
 - Clean the scanner glass. See [Clean the scanner glass](#) for more information.

Scan defects are apparent

- **Blank pages**
 - The original might have been loaded upside down. Make sure that you loaded the original correctly. For more information, see [Load the originals](#).
 - If you are producing blank pages when you scan from the flatbed scanner, make sure that the original document is loaded correctly. Place the original document face down on the flatbed scanner with the top-left corner of the document located in the lower-right corner of the scanner glass. Also, make sure that the ADF is empty.
- **Too light or dark**
 - Try adjusting the settings. Be sure to use the correct resolution and color settings.
 - The original image might be very light or dark or might be printed on colored paper.
- **Unwanted lines**

Ink, glue, correction fluid, or an unwanted substance might be on the scanner glass. Try cleaning the scanner glass. See [Clean the device](#) for more information.
- **Black dots or streaks**
 - Ink, glue, correction fluid, or an unwanted substance might be on the scanner glass, the scanner glass might be dirty or scratched, or the ADF lid backing might be dirty. Try cleaning the scanner glass and lid backing. See [Clean the device](#) for more information. If cleaning does not correct the problem, the scanner glass or ADF lid backing might need to be replaced.
 - The defects might be on the original and not a result of the scanning process.
- **Unclear text**

Try adjusting the settings. Make sure that the resolution and color settings are correct.
- **Size is reduced**

The HP software settings might be set to reduce the scanned image. See the product software Help for more information about changing the settings.

Unable to scan to network folder (Direct Digital Filing)

 **NOTE:** The Direct Digital Filing feature does not support Windows Active Directory.

- **The device is not set up correctly on the network**

Make sure that the device is set up properly and connected to the network. PING the device and make sure that it is responding.
- **The network folder has not been set up correctly**
 - Make sure the folder is created on the server. For more information, see the documentation available for your operating system.
 - Make sure the folder name uses only the letters A through Z (uppercase or lowercase) and the numbers 1 through 9.
 - Some common punctuation marks are also supported. However, do not use accented or special characters in the folder name.

- Make sure the folder has been shared and that users can both read and write to the folder. For more information, see the documentation available for your operating system.
- Make sure the folder name is entered in the correct format in the EWS and that the username and password are entered correctly. For more information, see the information in the EWS.
- **The disk is full**
Make sure the server containing the folder has enough disk space available.
- **The device cannot create a unique filename using the assigned prefix and suffix**
The device can create up to 9,999 files using the same prefix and suffix. If you have scanned many files to a folder, change the prefix.
- **The filename prefix has not been set up correctly**
Make sure the folder name and filename prefix uses only the letters A through Z, uppercase or lowercase; the numbers 1 through 9. Some common punctuation marks are also supported. However, do not use accented or special characters in the folder name. If unsupported characters are used in filename prefixes, they will not appear correctly when the file is created.
- **The server name cannot be resolved**
Sending to network folder might fail if the server name provided during setup cannot be resolved to specific IP addresses. When setting up the Direct Digital Filing feature, be sure to do the following:
 - Try to use fully qualified DNS names.
 - Make sure the DNS server is set up correctly on the device.

 -  **TIP:** If you have recently changed the DNS settings, turn off and then turn on the all-in-one.

Solve fax problems

This section contains fax setup troubleshooting information for the device. If the device is not set up properly for faxing, you might experience problems when sending faxes, receiving faxes, or both.

If you are having faxing problems, you can print a fax test report to check the status of the device. The test will fail if the device is not set up properly for faxing. Perform this test after you have completed setting up the device for faxing. For more information, see [Test fax setup](#).

If the test fails, review the report for information on how to fix any problems found. For more information, see [The fax test failed](#).

The fax test failed

If you ran a fax test and the test failed, review the report for basic information about the error. For more detailed information, check the report to see which part of the test failed, and then review the appropriate topic in this section for solutions to try.

- [The "Fax Hardware Test" failed](#)
- [The "Fax Connected to Active Telephone Wall Jack" test failed](#)

- [The "Phone Cord Connected to Correct Port on Fax" test failed](#)
- [The "Using Correct Type of Phone Cord with Fax" test failed](#)
- [The "Dial Tone Detection" test failed](#)
- [The "Fax Line Condition" test failed](#)

The "Fax Hardware Test" failed

Solution:

- Turn off the device by using the **Power** button located on the control panel and then unplug the power cord from the back of the device. After a few seconds, plug the power cord in again, and then turn the power on. Run the test again. If the test fails again, continue reviewing the troubleshooting information in this section.
- Try to send or receive a test fax. If you can send or receive a fax successfully, there might not be a problem.
- If you are running the test from the **Fax Setup Wizard** (Windows) or **HP Fax Setup Utility** (Mac OS), make sure the device is not busy completing another task, such as receiving a fax or making a copy. Check the display for a message indicating that the device is busy. If it is busy, wait until it is finished and in the idle state before running the test.
- Make sure you use the phone cord that came with the device. If you do not use the supplied phone cord to connect from the telephone wall jack to the device, you might not be able to send or receive faxes. After you plug in the phone cord that came with the device, run the fax test again.
- If you are using a phone splitter, this can cause faxing problems. (A splitter is a two-cord connector that plugs into a telephone wall jack.) Try removing the splitter and connecting the device directly to the telephone wall jack.

After you resolve any problems found, run the fax test again to make sure it passes and the device is ready for faxing. If the **Fax Hardware Test** continues to fail and you experience problems faxing, contact HP Support. Go to www.hp.com/support. If prompted, choose your country/region, and then click **Contact HP** for information on calling for technical support.

The "Fax Connected to Active Telephone Wall Jack" test failed

Solution:

- Check the connection between the telephone wall jack and the device to make sure the phone cord is secure.
- Make sure you use the phone cord that came with the device. If you do not use the supplied phone cord to connect from the telephone wall jack to the device, you might not be able to send or receive faxes. After you plug in the phone cord that came with the device, run the fax test again.

- Make sure you have correctly connected the device to the telephone wall jack. Using the phone cord supplied in the box with the device, connect one end to your telephone wall jack, then connect the other end to the port labeled 1-LINE on the back of the device. For more information on setting up the device for faxing, see [Set up faxing for the device \(some models only\)](#).
- If you are using a phone splitter, this can cause faxing problems. (A splitter is a two-cord connector that plugs into a telephone wall jack.) Try removing the splitter and connecting the device directly to the telephone wall jack.
- Try connecting a working phone and phone cord to the telephone wall jack that you are using for the device and check for a dial tone. If you do not hear a dial tone, contact your telephone company and have them check the line.
- Try to send or receive a test fax. If you can send or receive a fax successfully, there might not be a problem.

After you resolve any problems found, run the fax test again to make sure it passes and the device is ready for faxing.

The "Phone Cord Connected to Correct Port on Fax" test failed

Solution: Plug the phone cord into the correct port.

1. Using the phone cord supplied in the box with the device, connect one end to your telephone wall jack, then connect the other end to the port labeled 1-LINE on the back of the device.

 **NOTE:** If you use the 2-EXT port to connect to the telephone wall jack, you will not be able to send or receive faxes. The 2-EXT port should only be used to connect other equipment, such as an answering machine or a telephone.

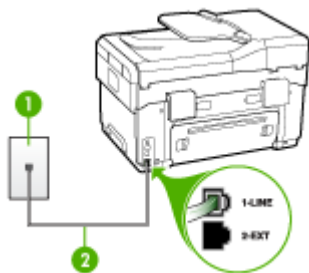

Figure 10-1 Back view of the device

1	Telephone wall jack
2	Use the phone cord supplied in the box with the device to connect to the "1-LINE" port

2. After you have connected the phone cord to the port labeled 1-LINE, run the fax test again to make sure it passes and the device is ready for faxing.
3. Try to send or receive a test fax.
 - Make sure you use the phone cord that came with the device. If you do not use the supplied phone cord to connect from the telephone wall jack to the device, you might not be able to send or receive faxes. After you plug in the phone cord that came with the device, run the fax test again.
 - If you are using a phone splitter, this can cause faxing problems. (A splitter is a two-cord connector that plugs into a telephone wall jack.) Try removing the splitter and connecting the device directly to the telephone wall jack.

The "Using Correct Type of Phone Cord with Fax" test failed

Solution:

- Make sure you used the phone cord supplied in the box with the device to connect to the telephone wall jack. One end of the phone cord should be connected to the port labeled 1-LINE on the back of the device, and the other end to your telephone wall jack, as shown below.

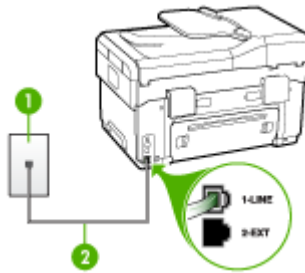

1	Telephone wall jack
2	Use the phone cord supplied in the box with the device to connect to the "1-LINE" port

If the phone cord that came with the device is not long enough, you can use a coupler to extend the length. You can purchase a coupler at an electronics store that carries phone accessories. You will also need another phone cord, which can be a standard phone cord that you might already have in your home or office.

- Check the connection between the telephone wall jack and the device to make sure the phone cord is secure.

- Make sure you use the phone cord that came with the device. If you do not use the supplied phone cord to connect from the telephone wall jack to the device, you might not be able to send or receive faxes. After you plug in the phone cord that came with the device, run the fax test again.
 - If you are using a phone splitter, this can cause faxing problems. (A splitter is a two-cord connector that plugs into a telephone wall jack.) Try removing the splitter and connecting the device directly to the telephone wall jack.
-

The "Dial Tone Detection" test failed

Solution:

- Other equipment, which uses the same phone line as the device, might be causing the test to fail. To find out if other equipment is causing a problem, disconnect everything from the phone line, and then run the test again. If the **Dial Tone Detection Test** passes without the other equipment, then one or more pieces of the equipment is causing problems; try adding them back one at a time and rerunning the test each time, until you identify which piece of equipment is causing the problem.
- Try connecting a working phone and phone cord to the telephone wall jack that you are using for the device and check for a dial tone. If you do not hear a dial tone, contact your telephone company and have them check the line.
- Make sure you have correctly connected the device to the telephone wall jack. Using the phone cord supplied in the box with the device, connect one end to your telephone wall jack, then connect the other end to the port labeled 1-LINE on the back of the device.
- If you are using a phone splitter, this can cause faxing problems. (A splitter is a two-cord connector that plugs into a telephone wall jack.) Try removing the splitter and connecting the device directly to the telephone wall jack.
- If your telephone system is not using a standard dial tone, such as some PBX systems, this might cause the test to fail. This will not cause a problem sending or receiving faxes. Try sending or receiving a test fax.
- Check to make sure the country/region setting is set appropriately for your country/region. If the country/region setting is not set or is set incorrectly, the test might fail and you might have problems sending and receiving faxes.
- Make sure you connect the device to an analog phone line or you will not be able to send or receive faxes. To check if your phone line is digital, connect a regular analog phone to the line and listen for a dial tone. If you do not hear a normal sounding dial tone, it might be a phone line set up for digital phones. Connect the device to an analog phone line and try sending or receiving a fax.
- Make sure you use the phone cord that came with the device. If you do not use the supplied phone cord to connect from the telephone wall jack to the device, you might not be able to send or receive faxes. After you plug in the phone cord that came with the device, run the fax test again.

After you resolve any problems found, run the fax test again to make sure it passes and the device is ready for faxing. If the **Dial Tone Detection test**

continues to fail, contact your telephone company and have them check the phone line.

The "Fax Line Condition" test failed

Solution:

- Make sure you connect the device to an analog phone line or you will not be able to send or receive faxes. To check if your phone line is digital, connect a regular analog phone to the line and listen for a dial tone. If you do not hear a normal sounding dial tone, it might be a phone line set up for digital phones. Connect the device to an analog phone line and try sending or receiving a fax.
- Check the connection between the telephone wall jack and the device to make sure the phone cord is secure.
- Make sure you have correctly connected the device to the telephone wall jack. Using the phone cord supplied in the box with the device, connect one end to your telephone wall jack, then connect the other end to the port labeled 1-LINE on the back of the device.
- Other equipment, which uses the same phone line as the device, might be causing the test to fail. To find out if other equipment is causing a problem, disconnect everything from the phone line, and then run the test again.
 - If the **Fax Line Condition Test** passes without the other equipment, then one or more pieces of the equipment is causing problems; try adding them back one at a time and rerunning the test each time, until you identify which piece of equipment is causing the problem.
 - If the **Fax Line Condition Test** fails without the other equipment, connect the device to a working phone line and continue reviewing the troubleshooting information in this section.
- If you are using a phone splitter, this can cause faxing problems. (A splitter is a two-cord connector that plugs into a telephone wall jack.) Try removing the splitter and connecting the device directly to the telephone wall jack.
- Make sure you use the phone cord that came with the device. If you do not use the supplied phone cord to connect from the telephone wall jack to the device, you might not be able to send or receive faxes. After you plug in the phone cord that came with the device, run the fax test again.

After you resolve any problems found, run the fax test again to make sure it passes and the device is ready for faxing. If the **Fax Line Condition** test continues to fail and you experience problems faxing, contact your telephone company and have them check the phone line.

The display always shows Phone Off Hook

Solution: You are using the wrong type of phone cord. Make sure you are using the phone cord that came with the device to connect the device to your phone line. If the phone cord that came with the device is not long enough, you can use a coupler to extend the length. You can purchase a coupler at an electronics store

that carries phone accessories. You will also need another phone cord, which can be a standard phone cord that you might already have in your home or office.

Solution: Other equipment that uses the same phone line as the device might be in use. Make sure extension phones (phones on the same phone line, but not connected to the device) or other equipment are not in use or off the hook. For example, you cannot use the device for faxing if an extension phone is off the hook, or if you are using a computer dial-up modem to send e-mail or access the Internet.

The device is having problems sending and receiving faxes

Solution: Make sure the device is turned on. Look at the display on the device. If the display is blank and the **Power** light is not lit, the device is turned off. Make sure the power cord is firmly connected to the device and plugged into a power outlet. Press the **Power** button to turn on the device.

After turning on the device, HP recommends you wait five minutes before sending or receiving a fax. The device cannot send or receive faxes while it is initializing after being turned on.

Solution:

- Make sure you used the phone cord supplied in the box with the device to connect to the telephone wall jack. One end of the phone cord should be connected to the port labeled 1-LINE on the back of the device and the other end to your telephone wall jack, as shown below.

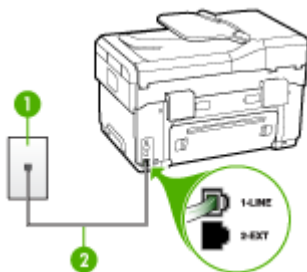

1	Telephone wall jack
2	Use the phone cord supplied in the box with the device to connect to the "1-LINE" port

If the phone cord that came with the device is not long enough, you can use a coupler to extend the length. You can purchase a coupler at an electronics store that carries phone accessories. You will also need another phone cord,

which can be a standard phone cord that you might already have in your home or office..

- Try connecting a working phone and phone cord to the telephone wall jack that you are using for the device and check for a dial tone. If you do not hear a dial tone, call your local telephone company for service.
- Other equipment, which uses the same phone line as the device, might be in use. For example, you cannot use the device for faxing if an extension phone is off the hook, or if you are using a computer dial-up modem to send an e-mail or access the Internet.
- Check to see if another process has caused an error. Check the display or your computer for an error message providing information about the problem and how to solve it. If there is an error, the device will not send or receive a fax until the error condition is resolved.
- The phone line connection might be noisy. Phone lines with poor sound quality (noise) can cause faxing problems. Check the sound quality of the phone line by plugging a phone into the telephone wall jack and listening for static or other noise. If you hear noise, turn **Error Correction Mode (ECM)** off and try faxing again. For information about changing ECM, see the onscreen Help. If the problem persists, contact your telephone company.
- If you are using a digital subscriber line (DSL) service, make sure that you have a DSL filter connected or you will not be able to fax successfully. For more information, see [Case B: Set up the device with DSL](#).
- Make sure the device is not connected to a telephone wall jack that is set up for digital phones. To check if your phone line is digital, connect a regular analog phone to the line and listen for a dial tone. If you do not hear a normal sounding dial tone, it might be a phone line set up for digital phones.
- If you are using either a private branch exchange (PBX) or an integrated services digital network (ISDN) converter/terminal adapter, make sure the device is connected to the correct port and the terminal adapter is set to the correct switch type for your country/region, if possible. For more information, see [Case C: Set up the device with a PBX phone system or an ISDN line](#).
- If the device shares the same phone line with a DSL service, the DSL modem might not be properly grounded. If the DSL modem is not properly grounded, it can create noise on the phone line. Phone lines with poor sound quality (noise) can cause faxing problems. You can check the sound quality of the phone line by plugging a phone into the telephone wall jack and listening for static or other noise. If you hear noise, turn off your DSL modem and completely remove power for at least 15 minutes. Turn the DSL modem back on and listen to the dial tone again.



NOTE: You might notice static on the phone line again in the future. If the device stops sending and receiving faxes, repeat this process.

If the phone line is still noisy, contact your telephone company. For information on turning your DSL modem off, contact your DSL provider for support.

- If you are using a phone splitter, this can cause faxing problems. (A splitter is a two-cord connector that plugs into a telephone wall jack.) Try removing the splitter and connecting the device directly to the telephone wall jack.

The device is having problems sending a manual fax

Solution:

 **NOTE:** This possible solution applies only in the countries/regions that receive a 2-wire phone cord in the box with the device, including: Argentina, Australia, Brazil, Canada, Chile, China, Colombia, Greece, India, Indonesia, Ireland, Japan, Korea, Latin America, Malaysia, Mexico, Philippines, Poland, Portugal, Russia, Saudi Arabia, Singapore, Spain, Taiwan, Thailand, USA, Venezuela, and Vietnam.

- Make sure the telephone you use to initiate the fax call is connected directly to the device. To send a fax manually, the telephone must be connected directly to the port labeled 2-EXT on the device, as shown below.



1	Telephone wall jack
2	Use the phone cord supplied in the box with the device to connect to the "1-LINE" port
3	Telephone

- If you are sending a fax manually from your phone that is connected directly to the device, you must use the keypad on the telephone to send the fax. You cannot use the keypad on the control panel of the device.

 **NOTE:** If using a serial-type phone system, please connect your phone directly on top of the device cable which has a wall plug attached to it.

The device cannot receive faxes, but can send faxes

Solution:

- If you are not using a distinctive ring service, check to make sure that the **Distinctive Ring** feature on the device is set to **All Rings**. For more information, see [Change the answer ring pattern for distinctive ring](#).
- If **Auto Answer** is set to **Off**, you will need to receive faxes manually; otherwise, the device will not receive the fax. For information on receiving faxes manually, see [Receive a fax manually](#).

- If you have a voice mail service at the same phone number you use for fax calls, you must receive faxes manually, not automatically. This means that you must be available to respond in person to incoming fax calls. For information on setting up the device when you have a voice mail service, see [Case F: Shared voice/fax line with voice mail](#). For information on receiving faxes manually, see [Receive a fax manually](#).
- If you have a computer dial-up modem on the same phone line with the device, check to make sure that the software that came with your modem is not set to receive faxes automatically. Modems that are set up to receive faxes automatically take over the phone line to receive all incoming faxes, which prevents the device from receiving fax calls.
- If you have an answering machine on the same phone line with the device, you might have one of the following problems:
 - Your answering machine might not be set up properly with the device.
 - Your outgoing message might be too long or too loud to allow the device to detect fax tones, and the sending fax machine might disconnect.
 - Your answering machine might not have enough quiet time after your outgoing message to allow the device to detect fax tones. This problem is most common with digital answering machines.

The following actions might help solve these problems:

- When you have an answering machine on the same phone line you use for fax calls, try connecting the answering machine directly to the device as described in [Case I: Shared voice/fax line with answering machine](#).
- Make sure the device is set to receive faxes automatically. For information on setting up the device to receive faxes automatically, see [Receive a fax](#).
- Make sure the **Rings to Answer** setting is set to a greater number of rings than the answering machine. For more information, see [Set the number of rings before answering](#).
- Disconnect the answering machine and then try receiving a fax. If faxing is successful without the answering machine, the answering machine might be causing the problem.
- Reconnect the answering machine and record your outgoing message again. Record a message that is approximately 10 seconds in duration. Speak slowly and at a low volume when recording your message. Leave at least 5 seconds of silence at the end of the voice message. There should be no background noise when recording this silent time. Try to receive a fax again.

 **NOTE:** Some digital answering machines might not retain the recorded silence at the end of your outgoing message. Play back your outgoing message to check.

- If the device shares the same phone line with other types of phone equipment, such as an answering machine, a computer dial-up modem, or a multi-port switch box, the fax signal level might be reduced. The signal level can also be reduced if you use a splitter or connect extra cables to extend the length of your phone. A reduced fax signal can cause problems during fax reception. To find out if other equipment is causing a problem, disconnect everything except the device from the phone line, and then try to receive a fax. If you can receive faxes successfully without the other equipment, one or more pieces of the other equipment is causing problems; try adding them back one at a time and receiving a fax each time, until you identify which equipment is causing the problem.
 - If you have a special ring pattern for your fax phone number (using a distinctive ring service through your telephone company), make sure that the **Distinctive Ring** feature on the device is set to match. For more information, see [Change the answer ring pattern for distinctive ring](#).
-

The device cannot send faxes, but can receive faxes

Solution:

- The device might be dialing too fast or too soon. You might need to insert some pauses in the number sequence. For example, if you need to access an outside line before dialing the phone number, insert a pause following the access number. If your number is 95555555, and 9 accesses an outside line, you might insert pauses as follows: 9-555-5555. To enter a pause in the fax number you are typing, press **Redial/Pause**, or press the **Space (#)** button repeatedly, until a dash (-) appears on the display.
You can also send the fax using monitor dialing. This enables you to listen to the phone line as you dial. You can set the pace of your dialing and respond to prompts as you dial. For more information, see [Send a fax using monitor dialing](#).
 - The number you entered when sending the fax is not in the proper format or the receiving fax machine is having problems. To check this, try calling the fax number from a telephone and listen for fax tones. If you cannot hear fax tones, the receiving fax machine might not be turned on or connected, or a voice mail service could be interfering with the recipient's phone line. You can also ask the recipient to check the receiving fax machine for any problems.
-

Fax tones are recorded on my answering machine

Solution:

- When you have an answering machine on the same phone line you use for fax calls, try connecting the answering machine directly to the device as described in [Case I: Shared voice/fax line with answering machine](#). If you do not connect the answering machine as recommended, fax tones might be recorded on your answering machine.
 - Make sure the device is set to receive faxes automatically and that the **Rings to Answer** setting is correct. The number of rings to answer for the device should be greater than the number of rings to answer for the answering machine. If the answering machine and the device are set to the same number of rings to answer, both devices answer the call and fax tones are recorded on the answering machine.
 - Set your answering machine to a low number of rings and the device to answer in the maximum number of rings supported. (The maximum number of rings varies by country/region.) In this setup, the answering machine answers the call and the device monitors the line. If the device detects fax tones, the device receives the fax. If the call is a voice call, the answering machine records the incoming message. For more information, see [Set the number of rings before answering](#).
-

The phone cord that came with my device is not long enough

Solution: If the phone cord that came with the device is not long enough, you can use a coupler to extend the length. You can purchase a coupler at an electronics store that carries phone accessories. You will also need another phone cord, which can be a standard phone cord that you might already have in your home or office.

 **TIP:** If the device came with a 2-wire phone cord adaptor, you can use it with a 4-wire phone cord to extend the length. For information on using the 2-wire phone cord adaptor, see the documentation that came with it.

To extend your phone cord

1. Using the phone cord supplied in the box with the device, connect one end to the coupler, then connect the other end to the port labeled 1-LINE on the back of the device.
 2. Connect another phone cord to the open port on the coupler and to the telephone wall jack.
-

Solve photo (memory card) problems

If the following topics do not help, see [Support and warranty](#) for information about HP support.



NOTE: If you are starting a memory card operation from a computer, see the software Help for troubleshooting information.

The device cannot read the memory card

- **Check the memory card**
 - Make sure that the memory card is one of the supported types. For Compact Flash II - solid state memory only. For more information, see [Insert a memory card](#).
 - Some memory cards have a switch that controls how they can be used. Make sure that the switch is set so that the memory card can be read.
 - Inspect the ends of the memory card for dirt or material that closes a hole or spoils a metal contact. Clean the contacts with a lint-free cloth and small amounts of isopropyl alcohol.
 - Assure that the memory card is working properly by testing it with other devices.
- **Check the memory card slot**
 - Make sure that the memory card is fully inserted into the correct slot. For more information, see [Insert a memory card](#).
 - Remove the memory card (when the light is not blinking) and shine a flashlight into the empty slot. See if any of the small pins inside are bent. When the computer is off, you can straighten slightly bent pins by using the tip of a thin, retracted ballpoint pen. If a pin has bent in such a way that it touches another pin, replace the memory card reader or have the device serviced. For more information, see [Support and warranty](#).
 - Make sure that only one memory card has been inserted at a time in the slots. An error message should appear on the control-panel display if more than one memory card is inserted.

The device cannot read photos on the memory card

Check the memory card

- The memory card might be corrupt.
- The photos might be in a format that is not recognized. An error message should appear on the control-panel display if the format is unrecognizable. Use the procedure for printing photos from the control panel, because more formats might be recognized. For more information, see [Print photos from the control panel](#). If the device is connected to a computer, you can save the photos from the memory card to your computer and then print them from a software program.

Some photos on the memory card will not print, causing the print job to cancel

Check the photo files

Print a proof sheet and note which photos are corrupt. Set up the print job so that it does not include the corrupted photos. For more information, see [Print photos using a proof sheet](#).

The device prints half a page, then ejects the paper

Check the ink cartridges

The ink cartridges may have run out of ink, and the print job was cancelled. Replace the ink cartridges, and then resend the print job to the device. For more information, see [Replace the ink cartridges](#).

Solve device management problems

This section provide solutions to common problems that involve managing the device. This section contains the following topic:

[Embedded Web server cannot be opened](#)

Embedded Web server cannot be opened

Check your network setup

- Make sure you are not using a phone cord or a cross cable to connect the device to the network. For more information, see [Configure the device \(Windows\)](#) or [Configure the device \(Mac OS\)](#).
- Make sure the network cable is securely connected to the device.
- Make sure the network hub, switch, or router is turned on and working properly.

Check the computer

Make sure the computer that you are using is connected to the network.

Check your Web browser

Make sure the Web browser meets the minimum system requirements. For more information, see [System requirements](#).

Check the device IP address

- To check the IP address of the device from the control panel (color display models only), press the **Setup** button, select **Network**, select **View Network Settings**, and then select either **Display Wired Summary** or **Display Wireless Summary**. For devices with a two-line display, the user must obtain the IP address by printing a network configuration page. Press the **Setup** button, select **Network**, select **Network Settings**, and then select **Print Network Configuration Page**.
- Ping the device using the IP address from the command prompt.
For example, if the IP address is 123.123.123.123, type the following at the MS-DOS prompt:
`C:\>Ping 123.123.123.123`
If a reply appears, the IP address is correct. If a time-out response appears, the IP address is incorrect.

Troubleshoot installation issues

If the following topics do not help, see [Support and warranty](#) for information about HP support.

- [Hardware installation suggestions](#)
- [Software installation suggestions](#)
- [Solve alignment page problems](#)
- [Solve software installation problems](#)
- [Solve network problems](#)
- [Solve wireless problems](#)

Hardware installation suggestions

Check the device

- Make sure that all packing tape and material have been removed from outside and inside the device.
- Make sure that the device is loaded with paper.
- Make sure that no lights are on or blinking except the Ready light, which should be on. If the Attention light is blinking, check for messages on the control panel.
- Make sure that the device can print a self-test diagnostic page.

Check the hardware connections

- Make sure that any cords and cables that you are using are in good working order.
- Make sure that the power cord is connected securely to both the device and to a working power outlet.
- Make sure that the phone cord is connected to the 1-LINE port.

Check the printheads and ink cartridges

- Make sure that you have removed the orange caps from the printheads.
- Make sure that all of the printheads and ink cartridges are firmly installed in their correct, colorcoded slot. Press down firmly on each one to ensure proper contact. The device cannot work if they are not all installed.
- Make sure that the printhead latch is closed properly.
- If the display shows a printhead error message, clean the contacts on the printheads.

Software installation suggestions

Check the computer system

- Make sure that your computer is running one of the supported operating systems.
- Make sure that the computer meets at least the minimum system requirements.

Verify installation preliminaries

- Make sure to use the Starter CD that contains the correct installation software for your operating system.
- Before installing software, make sure that all other programs are closed.
- If the computer does not recognize the path to the CD-ROM drive that you type, make sure that you are specifying the correct drive letter.
- If the computer cannot recognize the Starter CD in the CD-ROM drive, inspect the Starter CD for damage. You can download the device driver from the HP Web site (www.hp.com/support).

Solve alignment page problems

Check the device to ensure the following:

- Power light is on and not blinking. When the device is first turned on, it takes approximately 45 seconds to warm up.
- The device is in the Ready state, and no other lights on the control panel are lit or blinking. If lights are lit or blinking, see the message on the control panel.
- Ensure power cord and other cables are working, and are firmly connected to the device.
- All packing tapes and materials are removed from the device.
- Rear access panel or duplexer is locked into place.
- Paper is loaded correctly in the tray, and is not jammed in the device.
- Ensure the orange protective caps have been removed from each printhead.
- Printheads and ink cartridges are properly installed in their correct color-coded slots. Press down firmly on each one to ensure proper contact.
- Printhead latch and all covers are closed.

Solve software installation problems

Check or perform the following:

- Make sure the computer meets the system requirements.
- Before installing software on a Windows computer, ensure all other programs are closed.
- If the computer does not recognize the path to the CD drive that you typed, ensure you are specifying the correct drive letter.
- If the computer cannot recognize the Starter CD in the CD drive, inspect the CD for damage. You can download the device driver from the HP Web site (www.hp.com/support).
- In the Windows device manager, make sure that the USB drivers have not been disabled.
- If you are using a computer running Windows, and the computer cannot detect the device, run the uninstallation utility (util\ccc\uninstall.bat on the Starter CD) to perform a clean uninstallation of the device driver. Restart your computer, and reinstall the device driver.

Solve network problems



NOTE: After correcting any of the following, run the installation program again.

General network troubleshooting

- If you are unable to install the device software, verify that:
 - All cable connections to the computer and the device are secure.
 - The network is operational and the network hub is turned on.
 - All applications, including virus protection programs, spyware protection programs, and firewalls, are closed or disabled for computers running Windows.
 - Make sure the device is installed on the same subnet as the computers that will be using the device.
 - If the installation program cannot discover the device, print the network configuration page, and enter the IP address manually in the installation program. For more information, see [Understand the network configuration page](#)
- If you are using a computer running Windows, make sure that the network ports created in the device driver match the device IP address:
 - Print the device's network configuration page.
 - Click **Start**, point to **Settings**, and then click **Printers** or **Printers and Faxes**.
- Or -
Click **Start**, click **Control Panel**, and then double-click **Printers**.
 - Right-click the device icon, click **Properties**, and then click the **Ports** tab.
 - Select the TCP/IP port for the device, and then click **Configure Port**.
 - Compare the IP address listed in the dialog box and make sure it matches the IP address listed on the network configuration page. If the IP addresses are different, change the IP address in the dialog box to match the address on the network configuration page.
 - Click **OK** twice to save the settings and close the dialog boxes.

Problems connecting to a wired network

- If the Link light on the network connector does not turn on, make sure that all of the "General network troubleshooting" conditions are met.
- Though it is not recommended that you assign the device with a static IP address, you might resolve some installation problems (such as a conflict with a personal firewall) by doing so.

Solve wireless problems

If the device is unable to communicate with the network after completing the wireless setup and software installation, perform one or more of the following tasks.

Check the wireless communication settings

- Make sure the computer's wireless card is set to the correct wireless profile. A wireless profile is a set of network settings unique to a given network. A single wireless card might have several wireless profiles (for example, one for a home network and one for an office network). Open the Configuration utility for the network card installed on your computer, and ensure that the profile selected is the profile for the device's network.
- Make sure the device's network settings match those of your network. Do one of the following to find the settings for your network:
 - **Infrastructure communication:** Open the wireless access point's (WAP) Configuration utility.
 - **Ad hoc communication:** Open the Configuration utility for the network card installed in your computer.
- Compare the network's settings to those on the device's network configuration page, and note any differences. For more information, see [Understand the network configuration page](#). Possible problems include the following:
 - The WAP filters hardware addresses (MAC addresses).
 - One of these settings in the device might be incorrect: communication mode, network name (SSID), channel (ad hoc networks only), authentication type, encryption.
 - Print a document. If the document still does not print, then reset the device's network settings and reinstall the device software.

If the wireless network settings are correct, the computer might be associated with another wireless network. Ensure that the computer is associated with the same wireless network as that of the device.

Users can ensure this by checking the wireless settings on their respective computers. In addition, ensure that the computers have access to the wireless network.

If the wireless network settings are incorrect, follow these steps to correct the device's settings:

1. Connect the device to your network with a network cable or to the computer using the network cable.
2. Open the device's embedded Web server.
3. Click the **Networking** tab, and then click **Wireless (802.11)** in the left pane.
4. Use the Wireless Setup wizard on the Wireless Setup tab to change the device's settings to match the settings of the network.
5. Close the device's embedded Web server, and then disconnect the network cable from the device.
6. Uninstall the device software completely, and then reinstall the software.

Add hardware addresses to a wireless access point (WAP)

MAC filtering is a security feature in which a wireless access point (WAP) is configured with a list of MAC addresses (also called “hardware addresses”) of devices that are allowed to gain access to the network through the WAP. If the WAP does not have the hardware address of a device attempting to access the network, the WAP denies the device access to the network. If the WAP filters MAC addresses, then the device’s MAC address must be added to the WAP’s list of accepted MAC addresses.

- Print the network configuration page. For more information, see [Understand the network configuration page](#).
- Open the WAP’s configuration utility, and add the device’s hardware address to the list of accepted MAC addresses.

Reset network configuration settings

If the device is still unable to communicate with the network, reset the device’s network settings.

- Press **Setup**. Press an arrow button to move to **Network**, and then press **OK**.
- Press an arrow button to move to **Restore Network Defaults**, and then press **OK**.
- Print the network configuration page and verify that the network settings have been reset. For more information, see [Understand the network configuration page](#). By default, the network name (SSID) is “hpsetup” and the communication mode is “ad hoc.”

Clear jams

Occasionally, media becomes jammed during a job. Try the following remedies before you attempt to clear the jam.

- Make sure that you are printing with media that meets specifications. For more information, see [Select print media](#).
- Make sure that you are printing with media that is not wrinkled, folded, or damaged.
- Make sure that the device is clean. For more information, see [Clean the device](#).
- Make sure that the input trays are loaded correctly and are not too full. For more information, see [Load media](#).

Clear a jam in the device

To clear a jam

1. Remove all media from the output tray.
2. Check the rear access panel or the duplexer.
 - a. Push the button on either side of the rear access panel or the duplexer, and then remove the panel or unit.

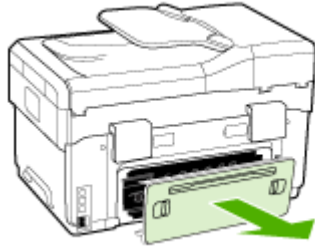

- b. Locate any jammed media inside the device, grasp it with both hands and then pull it towards you.
- c. If the jam is not there, push the latch on the top of the duplexer and lower its cover. If the jam is inside, carefully remove it. Close the cover.

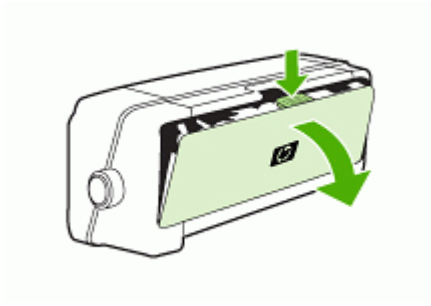

- d. Reinsert the rear access panel or the duplexer into the device.

3. If you cannot locate the jam, lift the output tray and check for a jam in Tray 1. If media is jammed in the tray, do the following:
 - a. Raise the output tray.
 - b. Pull the paper towards you.



- c. Lower the output tray.
4. If you have not found the jam and have Tray 2 installed, pull out the tray and remove the jammed media, if possible. If not, do the following:
 - a. Ensure the device is turned off and disconnect the power cord.
 - b. Lift the device off Tray 2.
 - c. Remove the jammed media from the bottom of the device or from Tray 2.
 - d. Reposition the device on top of Tray 2.
5. Open the print carriage access door. If there is paper remaining inside the device, ensure the carriage has moved to the right of the device, free any paper scraps or wrinkled media, and pull the media towards you through the top of the device.

⚠ WARNING! Do not reach into the device when it is on and the carriage is stuck. When you open the print carriage access door, the carriage should return to its position on the right side of the device. If it does not move to the right, turn off the device before you remove any jam.

6. After clearing the jam, close all covers, turn on the device (if you turned it off) and resend the print job.

Clear jams in the ADF

If media is jammed in the ADF, use the following instructions below to clear the jam. For information about how to avoid jams, see [Tips for avoiding jams](#).

To clear a jam in the ADF

1. If a page is sticking out of an area, gently try to remove it without tearing the page. If you feel resistance, continue with the following steps.
2. Remove the document feeder and open the ADF cover.

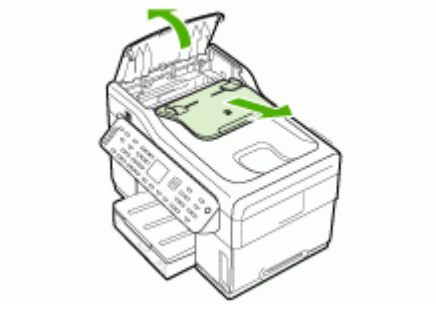

3. Remove the jam cleanout part. Using both hands, lift up on the two handles until the part unsnaps. Rotate and lift out the cleanout and set it aside.

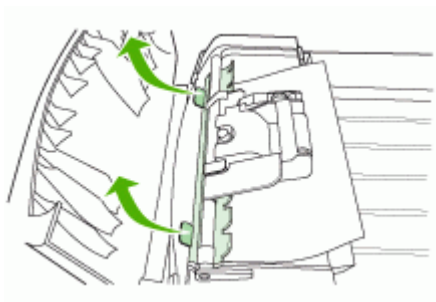

4. While lifting the green lever, rotate the pick mechanism until it stays open.

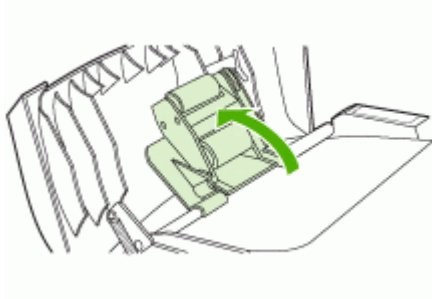

5. Gently try to remove the page without tearing it. If you feel resistance, continue with the next step.

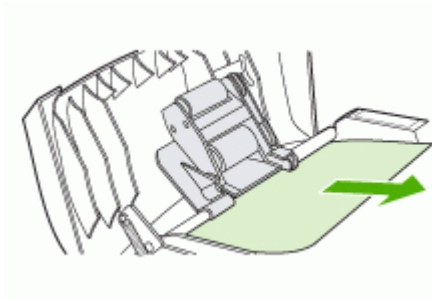

6. Open the ADF and gently loosen the media by using both hands.
7. When the media is free, gently pull it out.
8. Close the ADF.
9. Lower the green lever.
10. Reinstall the jam cleanout part by inserting it as shown. Push down on the two tabs until the part snaps into place.

 **NOTE:** If the cleanout part is not replaced correctly, future jamming might occur.

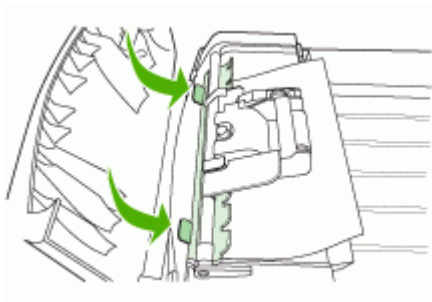

11. Close the ADF and replace the document feeder tray.

Tips for avoiding jams

- Make sure that nothing is blocking the paper path.
- Do not overload the trays. For more information, see [Understand specifications for supported media](#).
- Load paper properly and when the device is not printing. For more information, see [Load media](#) and [Load an original in the automatic document feeder \(ADF\)](#).
- When reinserting Tray 2 (optional) into the device, do so gently. Forceful insertion with a full stack of paper may cause sheets to slide up within the device, causing it to jam or pick multiple sheets at one time.
- Do not use media that is curled or crumpled.
- Always use media that conforms with specifications. For more information, see [Select print media](#).
- Make sure the output tray is not overly full.
- Make sure media is aligned against the right side of a tray.
- Make sure the media length and width guides are adjusted snugly against the media, but do not crinkle or bend it.

A HP supplies and accessories

This section provides information on HP supplies and accessories for the device. The information is subject to changes, visit the HP Web site (www.hpshopping.com) for the latest updates. You may also make purchases through the Web site.

- [Order printing supplies online](#)
- [Accessories](#)
- [Supplies](#)

Order printing supplies online

Besides the HP Web site, you may order printing supplies using the following tools:

- **Embedded Web server:** Click the **Order Supplies** button from any page in the embedded Web server.
- **Toolbox (Windows):** On the **Estimated Ink Level** tab, click **Shop Online**.
- **HP Printer Utility (Mac OS):** Click **Supplies Status** from the **Information and Support** panel, click the **Shop for HP Supplies** drop-down menu, and then choose **Online**.

Accessories

HP automatic two-sided printing accessory	C9278A	Auto-duplexer allowing printing on both sides of a sheet of paper automatically
350-sheet input tray	CB007A	Optional second tray for up to 350 pages of plain paper
HP Jetdirect 175x Print Server-Fast Ethernet*	J6035C	External print server (USB 1.0)
HP Jetdirect en3700 Fast Ethernet Print Server*	J7942A	External print server (USB 2.0)
HP Jetdirect ew2400 802.11g Wireless Print Server*	J7951A	Wireless or wired external print server
HP bt300, Bluetooth Wireless Printer Adapter	Q3395A	Bluetooth compatible USB adapter

*Only supports print functionality.

Supplies

- [Ink cartridges](#)
- [Printheads](#)
- [HP media](#)

Ink cartridges

Use only the replacement cartridges that have the same cartridge number as the ink cartridge you are replacing. You can find the cartridge number in the following places:

- On the self-test diagnostic page. For more information, see [Understand the self-test diagnostic page](#).
- On the label of the ink cartridge you are replacing.

- **Embedded Web server:** Click the **Information** tab, and then click **Ink Supplies** in the left pane.
- **Toolbox (Windows):** Click the **Estimated Ink Level** tab, and then click the **Cartridge Details** button to view information about replacement ink cartridges.
- **HP Printer Utility (Mac OS):** Open the **Information and Support** panel, and then click **Supply Info**.

 **NOTE:** The availability of ink cartridges varies by country/region. If you live in Europe, go to www.hp.com/eu/hard-to-find-supplies to locate information on HP ink cartridges.

Printheads

HP 88 Black and Yellow	C9381A
HP 88 Magenta and Cyan	C9382A

HP media

To order media such as HP Premium Plus Photo Paper or HP Premium Paper, go to www.hp.com. Choose your country/region, and then select **Buy** or **Shopping**.

B Support and warranty

The information in [Maintain and troubleshoot](#) suggests solutions to common problems. If your device is not operating correctly and those suggestions did not solve your problem, try using one of the following support services to obtain assistance.

This section contains the following topics:

- [Obtain electronic support](#)
- [Obtain HP telephone support](#)
- [Hewlett-Packard limited warranty statement](#)
- [Prepare the device for shipment](#)
- [Pack the device](#)

Obtain electronic support

To find support and warranty information, go to the HP Web site at www.hp.com/support. If prompted, choose your country/region, and then click **Contact HP** for information on calling for technical support.

This Web site also offers technical support, drivers, supplies, ordering information and other options such as:

- Access online support pages.
- Send HP an e-mail message for answers to your questions.
- Connect with an HP technician by using online chat.
- Check for software updates.

You can also obtain support from HP from the following electronic sources:

- **Toolbox (Windows):** The Toolbox provides easy, step-by-step solutions to common printing problems. For more information, see [Toolbox \(Windows\)](#).
- **Embedded Web server:** When the device is connected to a network, you can use the embedded Web server to view status information, change settings, and manage the device at your computer. For more information, see [Embedded Web server](#).

Support options and availability vary by product, country/region, and language.

Obtain HP telephone support

During the warranty period, you may obtain assistance from the HP Customer Care Center.

This section contains the following topics:

- [Before you call](#)
- [Telephone support numbers](#)

Before you call

Visit the HP Web site (www.hp.com/support) for the latest troubleshooting information, or product fixes and updates.

To assist our Customer Care Center representatives to serve you better, prepare the following information if you need to call HP.

1. Print the self-test diagnostic page of the device. For more information, see [Understand the self-test diagnostic page](#). If the device does not print, get the following information ready:
 - Device model
 - Model number and serial number (check the back of the device)
2. Check the operating system that you are using, such as Windows XP.
3. If the device is connected to the network, check the network operating system.

4. Note how the device is connected to your system, such as through USB or network connection.
5. Obtain the version number of the printer software, such as HP Officejet Pro L7500 Series Version: 60.52.213.0. (To find the version number of the printer driver, open the printer settings or properties dialog box, and click the **About** tab.)
6. If you have a problem printing from a particular application, note the application and version number.

Telephone support numbers

In many locations, HP provides toll free telephone support during the warranty period. However, some of the support numbers listed below may not be toll free.

For the most current list of telephone support numbers, see www.hp.com/support.



021 672 280	الجزائر
Argentina (Buenos Aires)	54-11-4708-1600
Argentina	0-800-955-5000
Australia	1300 721 147
Australia (out-of-warranty)	1902 910 910
Österreich	+43 0820 87 4417
17212049	البحرين
België	+32 070 300 005
Belgique	+32 070 300 004
Brazil (São Paulo)	55-11-4004-7751
Brazil	0-800-709-7751
Canada	1-(800)-474-6836 (1-800 hp invent)
Central America & The Caribbean	www.hp.com/support
Chile	800-360-999
中国	021-3881 4518 800-810-3888
Colombia (Bogotá)	57 1-606-9 19 1
Colombia	01-8000-51-4746-6366
Costa Rica	0-800-011-1046
Česká republika	810 222 222
Danmark	+45 70 202 845
Ecuador (Andinetel)	1-999-119 800-711-2884
Ecuador (Pacifitel)	1-800-225-528 800-711-2884
(02) 6910602	مصر
El Salvador	800-6160
España	+34 902 010 059
France	+33 0892 69 60 22
Deutschland	+49 01805 652 180
Ελλάδα (από το εξωτερικό)	+ 30 210 6073603
Ελλάδα (εντός Ελλάδας)	801 11 75400
Ελλάδα (από Κύπρο)	800 9 2654
Guatemala	1-800-711-2884
香港特别行政区	(852) 2802 4098
Magyarország	06 40 200 629
India	1-800-425-7737 91-80-28526900
Indonesia	+62 (21) 350 3408
+971 4 224 9 189	العراق
+971 4 224 9 189	الكويت
+971 4 224 9 189	لبنان
+971 4 224 9 189	قطر
+971 4 224 9 189	البحرين
Ireland	+353 1890 923 902
1-700-503-048	Україна
Italia	+39 848 800 871
Jamaica	1-800-711-2884

日本	0570-000511
日本 (携帯番号の場合)	03-3335-9800
0800 222 47	الأردن
한국	1588-3003
Luxembourg	+352 900 40 006
Luxemburg	+352 900 40 007
Malaysia	1800 88 8588
Mauritius	(262) 262 210 404
México (Ciudad de México)	55-5258-9922
México	01-800-472-68368
081 005 010	عمان
Nederland	+31 0900 2020 165
New Zealand	0800 441 147
Nigeria	(01) 271 2320
Norge	+47 815 62 070
24791773	مصر
Panamá	1-800-711-2884
Paraguay	009 800 54 1 0006
Perú	0-800-10111
Philippines	2 867 3551
Polska	22 5666 000
Portugal	+351 808 201 492
Puerto Rico	1-877-232-0589
República Dominicana	1-800-711-2884
Reunion	0820 890 323
România	0801 033 390
Россия (Москва)	095 777 3284
Россия (Санкт-Петербург)	812 332 4240
800 897 1415	السعودية
Singapore	6 272 5300
Slovensko	0850 111 256
South Africa (international)	+ 27 11 2589301
South Africa (RSA)	0860 104 771
Rest of West Africa	+ 351 213 17 63 80
Suomi	+358 0 203 66 767
Sverige	+46 077 120 4765
Switzerland	+41 0848 672 672
臺灣	02-8722-8000
ไทย	+66 (2) 353 9000
071 891 391	تونس
Trinidad & Tobago	1-800-711-2884
Türkiye	+90 0212 444 0307
Україна	(044) 230-51-06
600 54 47 47	الإمارات العربية المتحدة
United Kingdom	+44 0870 010 4320
United States	1-(800)-474-6836
Uruguay	0004-054-177
Venezuela (Caracas)	58-212-278-8666
Venezuela	0-800-474-68368
Viet Nam	+84 88234530

Hewlett-Packard limited warranty statement

HP product	Duration of limited warranty
Software Media	90 days
Printer	1 year
Print or Ink cartridges	Until the HP ink is depleted or the "end of warranty" date printed on the cartridge has been reached, whichever occurs first. This warranty does not cover HP ink products that have been refilled, remanufactured, refurbished, misused, or tampered with.
Printheads	1 year
Accessories	1 year

A. Extent of limited warranty

- Hewlett-Packard (HP) warrants to the end-user customer that the HP products specified above will be free from defects in materials and workmanship for the duration specified above, which duration begins on the date of purchase by the customer.
- For software products, HP's limited warranty applies only to a failure to execute programming instructions. HP does not warrant that the operation of any product will be interrupted or error free.
- HP's limited warranty covers only those defects that arise as a result of normal use of the product, and does not cover any other problems, including those that arise as a result of:
 - Improper maintenance or modification;
 - Software, media, parts, or supplies not provided or supported by HP;
 - Operation outside the product's specifications;
 - Unauthorized modification or misuse.
- For HP printer products, the use of a non-HP cartridge or a refilled cartridge does not affect either the warranty to the customer or any HP support contract with the customer. However, if printer failure or damage is attributable to the use of a non-HP or refilled cartridge or an expired ink cartridge, HP will charge its standard time and materials charges to service the printer for the particular failure or damage.
- If HP receives, during the applicable warranty period, notice of a defect in any product which is covered by HP's warranty, HP shall either repair or replace the product, at HP's option.
- If HP is unable to repair or replace, as applicable, a defective product which is covered by HP's warranty, HP shall, within a reasonable time after being notified of the defect, refund the purchase price for the product.
- HP shall have no obligation to repair, replace, or refund until the customer returns the defective product to HP.
- Any replacement product may be either new or like-new, provided that it has functionality at least equal to that of the product being replaced.
- HP products may contain remanufactured parts, components, or materials equivalent to new in performance.
- HP's Limited Warranty Statement is valid in any country where the covered HP product is distributed by HP. Contracts for additional warranty services, such as on-site service, may be available from any authorized HP service facility in countries where the product is distributed by HP or by an authorized importer.

B. Limitations of warranty

TO THE EXTENT ALLOWED BY LOCAL LAW, NEITHER HP NOR ITS THIRD PARTY SUPPLIERS MAKES ANY OTHER WARRANTY OR CONDITION OF ANY KIND, WHETHER EXPRESS OR IMPLIED WARRANTIES OR CONDITIONS OF MERCHANTABILITY, SATISFACTORY QUALITY, AND FITNESS FOR A PARTICULAR PURPOSE.

C. Limitations of liability

- To the extent allowed by local law, the remedies provided in this Warranty Statement are the customer's sole and exclusive remedies.
- TO THE EXTENT ALLOWED BY LOCAL LAW, EXCEPT FOR THE OBLIGATIONS SPECIFICALLY SET FORTH IN THIS WARRANTY STATEMENT, IN NO EVENT SHALL HP OR ITS THIRD PARTY SUPPLIERS BE LIABLE FOR DIRECT, INDIRECT, SPECIAL, INCIDENTAL, OR CONSEQUENTIAL DAMAGES, WHETHER BASED ON CONTRACT, TORT, OR ANY OTHER LEGAL THEORY AND WHETHER ADVISED OF THE POSSIBILITY OF SUCH DAMAGES.

D. Local law

- This Warranty Statement gives the customer specific legal rights. The customer may also have other rights which vary from state to state in the United States, from province to province in Canada, and from country to country elsewhere in the world.
- To the extent that this Warranty Statement is inconsistent with local law, this Warranty Statement shall be deemed modified to be consistent with such local law. Under such local law, certain disclaimers and limitations of this Warranty Statement may not apply to the customer. For example, some states in the United States, as well as some governments outside the United States (including provinces in Canada), may:
 - Preclude the disclaimers and limitations in this Warranty Statement from limiting the statutory rights of a consumer (e.g., the United Kingdom);
 - Otherwise restrict the ability of a manufacturer to enforce such disclaimers or limitations; or
 - Grant the customer additional warranty rights, specify the duration of implied warranties which the manufacturer cannot disclaim, or allow limitations on the duration of implied warranties.
- THE TERMS IN THIS WARRANTY STATEMENT, EXCEPT TO THE EXTENT LAWFULLY PERMITTED, DO NOT EXCLUDE, RESTRICT, OR MODIFY, AND ARE IN ADDITION TO, THE MANDATORY STATUTORY RIGHTS APPLICABLE TO THE SALE OF THE HP PRODUCTS TO SUCH CUSTOMERS.

HP Limited Warranty

Dear Customer,

You will find below the name and address of the HP entity responsible for the performance of the HP Limited Warranty in your country.

You may have additional statutory rights against the seller based on your purchase agreement. Those rights are not in any way affected by this HP Limited Warranty.

Ireland: Hewlett-Packard Ireland Ltd. 30 Herbert Street IRL-Dublin 2

United Kingdom: Hewlett-Packard Ltd, Cain Road, Bracknell, GB-Berks RG12 1HN

Prepare the device for shipment

If after contacting HP Customer Support or returning to the point of purchase, you are requested to send the device in for service, make sure you remove and keep the following items before returning your device:

- The ink cartridges and printheads
- The control-panel faceplate
- The power cord, USB cable, and any other cable connected to the device
- Any paper loaded in the input tray
- Remove any originals you might have loaded in the device

This section contains the following topics:

- [Remove the ink cartridges and printheads before shipment](#)
- [Remove the control-panel faceplate](#)

Remove the ink cartridges and printheads before shipment

Before you return the device, make sure you remove your ink cartridges and printheads.

 **NOTE:** This information does not apply to customers in Japan.

To remove ink cartridges before shipment

1. Turn on the device and wait until the print carriage is idle and silent. If the device will not turn on, skip this step and go to step 2.

 **NOTE:** If the device does not turn on, you can unplug the power cord and then manually slide the print carriage to the far right side to remove the ink cartridges.

2. Gently pull open the ink cartridge cover.



3. Remove the ink cartridges from their slots by grasping each between your thumb and forefinger and pulling it firmly toward you.

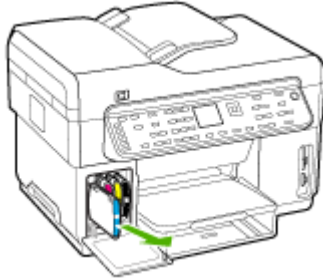

4. Place the ink cartridges in an airtight plastic container so they will not dry out, and put them aside. Do not send them with the device unless the HP customer support call agent instructs you to.
5. Close the ink cartridge door and wait a few minutes for the print carriage to move back to its home position (on the left side).
6. After the scanner is idle and has returned to its parked position, press the **Power** button to turn off the device.

To remove printheads before shipment

1. Open the top cover.
2. If the carriage does not move to the left automatically, press and hold the **OK** button for 5 seconds. Wait for the carriage to stop moving.
3. Lift the printhead latch.
4. Lift the handle of a printhead and use it to pull the printhead out of its slot.
5. Place the printheads in an airtight plastic container so they will not dry out, and put them aside. Do not send them with the device unless the HP customer support call agent instructs you to.
6. Close the top cover.
7. After the scanner is idle and has returned to its parked position, press the **Power** button to turn off the device.

Remove the control-panel faceplate

Complete the following steps once you have removed the ink cartridges and printheads.

 **NOTE:** This information does not apply to customers in Japan.

 **CAUTION:** The device must be unplugged before following these steps.

CAUTION: The replacement device will not be shipped with a power cord. Store the power cord in a safe place until the replacement arrives.

To remove the control-panel faceplate

1. Press the **Power** button to turn off the device.
2. Unplug the power cord, and then disconnect it from the device. Do not return the power cord with the device.

3. Remove the control-panel faceplate as follows:
 - a. Lift the ADF lid.



- b. Use either your finger or insert a thin object in the tab on the upper right corner of the control-panel faceplate to pry the control-panel faceplate off.

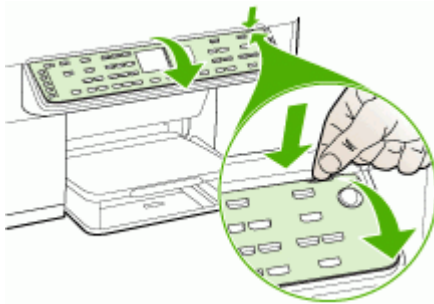

4. Retain the control-panel faceplate. Do not return the control-panel faceplate with the HP All-in-One.

△ **CAUTION:** The replacement device might not come with a control-panel faceplate. Store your control-panel faceplate in a safe place, and when the replacement device arrives, reattach your control-panel faceplate. You must attach your control-panel faceplate to use the control-panel functions on the replacement device.

📄 **NOTE:** See the setup poster that came with the device for instructions on how to attach your control-panel faceplate. The replacement device might come with instructions for setting up your device.

Pack the device

Complete the following steps after you have prepared the device for shipment.

To pack the device

1. If available, pack the device for shipment by using the original packaging materials, or use the packaging materials that came with your replacement device.

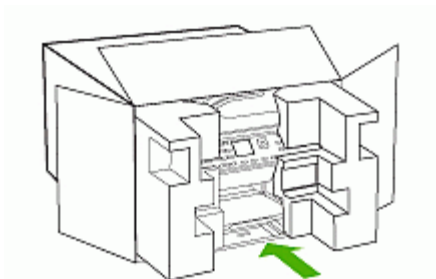

If you do not have the original packaging materials, please use other adequate packaging materials. Shipping damage caused by improper packaging and/or improper transportation is not covered under the warranty.

2. Place the return shipping label on the outside of the box.
3. Include the following items in the box:
 - A complete description of symptoms for service personnel (samples of print quality problems are helpful).
 - A copy of the sales slip or other proof of purchase to establish the warranty coverage period.
 - Your name, address, and a phone number where you can be reached during the day.

C Device specifications

For media and media-handling specifications, see [Understand specifications for supported media](#).

Physical specifications

Size (width x depth x height)

- **Device with A4/Letter-size scanner glass (L7300, L7500):** 505 x 402 x 356 mm (19.9 x 15.8 x 14 inches)
- **Device with Legal-size scanner glass (L7600, L7700):** 531 x 465 x 356 mm (20.9 x 18.3 x 14 inches)
- **With Duplexer:** Adds 64 mm (2.5 inches) to the rear of the device.
- **With Tray 2:** Adds 76 mm (3 inches) to the height of the device.

Device weight (does not include printheads or ink cartridges)

- **Device with A4/Letter-size scanner glass (L7300, L7500):** 14.2 kg (31.3 lb)
- **Device with Legal-size scanner glass (L7600, L7700):** 14.76 kg (32.5 lb)
- **With Duplexer:** Adds 0.95 kg (2.0 lb)
- **With Tray 2:** Adds 2.5 kg (5.5 lb)

Product features and capacities

Feature	Capacity
Connectivity	<ul style="list-style-type: none">• USB 2.0-compliant high speed• USB host connector is only supported up to full speed.• Fast Ethernet 10/100Base-TX for wired network connection (some models only)• 802.11b/g wireless network (some models only)
Print method	Drop-on-demand thermal inkjet printing
Ink cartridges	Four ink cartridges (one each for black, cyan, magenta, and yellow)
Printheads	Two printheads (one black and yellow, and one magenta and cyan)
Supply yields	Visit www.hp.com/pageyield/ for more information on estimated ink cartridge yields.
Device languages	HP PCL 3 enhanced
Font support	US fonts: CG Times, CG Times Italic, Universe, Universe Italic, Courier, Courier Italic, Letter Gothic, Letter Gothic Italic.
Duty cycle	Up to 7500 pages per month
Control panel language support Language availability varies by country/region.	Bulgarian, Croatian, Czech, Danish, Dutch, English, Finnish, French, German, Greek,

Feature	Capacity
	Hungarian, Italian, Japanese, Korean, Norwegian, Polish, Portuguese, Romanian, Russian, Simplified Chinese, Slovak, Slovenian, Spanish, Swedish, Traditional Chinese, Turkish, Ukrainian.

Processor and memory specifications

Device processor

192 MHz ARM946ES, ETM9 (medium)

Device memory

- L7300/L7500: 64 MB built-in RAM, 16 MB built-in MROM + 2 MB built-in Flash ROM
- L7600: 64 MB built-in RAM, 16 MB built-in MROM + 4 MB built-in Flash ROM
- L7700: 64 + 32 MB built-in RAM, 16 MB built-in MROM + 4 MB built-in Flash ROM

System requirements

 **NOTE:** For the most current information about supported operating systems and system requirements, visit <http://www.hp.com/support/>

Operating system compatibility

- Windows 2000, Windows XP, Windows XP x64* (Professional and Home Editions)
- Mac OS X (10.3, 10.4)
- Linux

 **NOTE:** Printer and scanner drivers for Windows Server 2003 (both 32-bit and 64-bit versions) require a minimum of an Intel® Pentium® II or Intel Celeron® processor, 128 MB RAM, 200 MB free hard disk space. The drivers are available at <http://www.hp.com/support/>.

Minimum requirements

- **Windows 2000:** Intel Pentium II or Celeron processor, 128 MB RAM, 280 MB free hard disk space
- **Windows XP (32-bit):** Intel Pentium II or Celeron processor, 128 MB RAM, 280 MB free hard disk space
- **Windows XP x64:** Intel Pentium II or Celeron processor, 128 MB RAM, 280 MB free hard disk space
- **Mac OS X (10.3.8, 10.4.x):** 400 MHz Power PC G3 (v10.3.8 and v10.4.x) or 1.83 GHz Intel Core Duo (v10.4.x), 128 MB memory, 300 MB free hard disk space
- **Microsoft Internet Explorer 6.0**

Recommended requirements

- **Windows 2000:** Intel Pentium III or higher processor, 256 MB RAM, 500 MB free hard disk space
- **Windows XP (32-bit):** Intel Pentium III or higher processor, 256 MB RAM, 500 MB free hard disk space
- **Windows XP x64:** Intel Pentium III or higher processor, 256 MB RAM, 500 MB free hard disk space

- **Mac OS X (10.3.8, 10.4.x):** 400 MHz Power PC G3 (v10.3.8 and v10.4.x) or 1.83 GHz Intel Core Duo (v10.4.x), 256 MB memory, 600 MB free hard disk space
- **Microsoft Internet Explorer 6.0 or later**

Network protocol specifications

Network operating system compatibility

- Windows 2000, Windows XP (32-bit), Windows XP x64 (Professional and Home Editions)
- Mac OS X (10.3, 10.4)
- Microsoft Windows 2000 Server Terminal Services with Citrix Metaframe XP with Feature Release 3
- Microsoft Windows 2000 Server Terminal Services with Citrix Presentation Server 4.0
- Microsoft Windows 2000 Server Terminal Services
- Microsoft Windows 2003 Server Terminal Services
- Microsoft Windows 2003 Server Terminal Services with Citrix Presentation Server 4.0
- Microsoft Windows 2003 Server Terminal Services with Citrix Metaframe XP with Feature Release 3
- Novell Netware 6, 6.5, Open Enterprise Server 6.5

Compatible network protocols

TCP/IP

Network management

- HP Web Jetadmin plug-ins
- Embedded Web server Features
 - Ability to remotely configure and manage network devices
 - myPrintMileage

Embedded Web server specifications

Requirements

- A TCP/IP-based network (IPX/SPX-based networks are not supported)
- A Web browser (either Microsoft Internet Explorer 5.5, Netscape 7.0, Opera 7.54, Mozilla Firefox 1.0, or Safari 1.2, or later)
- A network connection (you cannot use the embedded Web server connected directly to a computer with a USB cable)
- An Internet connection (required for some features)



NOTE: You can open the embedded Web server without being connected to the Internet. However, some features will not be available.

- It must be on the same side of a firewall as the device.

Print specifications

Print resolution

Black

Up to 1200 dpi with pigmented black ink

Color

HP enhanced photo quality with Viverna inks (up to 4800 by 1200 dpi Optimized on HP Premium Plus photo papers with 1200 by 1200 input dpi)

Copy specifications

- Digital image processing
- Up to 100 copies from original (varies by model)
- Digital zoom: from 25 to 400% (varies by model)
- Fit to page, pre-scan
- Copy speed: up to 30 copies per minute black; 24 copies per minute color (varies by model)
- Copy speeds vary according to the complexity of the document

Mode	Type	Speed (ppm)	Scan resolution (dpi) ¹
Best	Black	up to 0.8	up to 600 x 1200
	Color	up to 0.8	up to 600 x 1200
Normal	Black	up to 8.5	up to 300 x 300
	Color	up to 5.1	up to 300 x 300
Fast	Black	up to 30	up to 300 x 300
	Color	up to 24	up to 300 x 300

¹ Maximum at 400% scaling.

Fax specifications

- Walk-up black-and-white and color fax capability.
- Up to 110 speed dials (varies by model).
- Up to 120-page memory (varies by model, based on ITU-T Test Image #1 at standard resolution). More complicated pages or higher resolution takes longer and uses more memory.
- Manual fax send and receive.
- Automatic busy redial up to five times (varies by model).
- Automatic no-answer redial one time (varies by model).
- Confirmation and activity reports.
- CCITT/ITU Group 3 fax with Error Correction Mode.
- 33.6 Kbps transmission.
- 3 seconds per page speed at 33.6 Kbps (based on ITU-T Test Image #1 at standard resolution). More complicated pages or higher resolution take longer and use more memory.
- Ring detect with automatic fax/answering machine switching.

	Photo (dpi)	Very Fine (dpi)	Fine (dpi)	Standard (dpi)
Black	196 x 203 (8-bit grayscale)	300 x 300	196 x 203	196 x 98
Color	200 x 200	200 x 200	200 x 200	200 x 200

Scan specifications

- Image editor included
- Integrated OCR software automatically converts scanned text to editable text
- Scan speeds vary according to the complexity of the document
- Twain-compliant interface
- Resolution: 2400 x 4800 ppi optical, up to 19,200 ppi enhanced
- Color: 16-bit per RGB color, 48-bit total
- Maximum scan size from glass: 216 x 297 mm (8.5 x 11.7 inches)

Direct Digital Filing specifications

- Scan a hardcopy original from the ADF or scanner glass to create a digital document (with network connection) that is placed in a network folder
- Supports pre-programmed network folder path
- Supports Digital Filing Speed-dials
- Resolution: 75 dpi, 200 dpi, 300 dpi, 600 dpi
- Supported file formats: PDF, JPG
- Supported network configuration: TCP/IP network

Environmental specifications

Operating environment

Operating temperature: 5° to 40° C (41° to 104° F)

Recommended operating conditions: 15° to 32° C (59° to 90° F)

Recommended relative humidity: 25 to 75% noncondensing

Storage environment

Storage temperature: -40° to 60° C (-40° to 140° F)

Storage relative humidity: Up to 90% noncondensing at a temperature of 65° C (150° F)

Electrical specifications

Power supply

Universal power adapter (external)

Power requirements

Input voltage: 100 to 240 VAC ($\pm 10\%$), 50/60 Hz ($\pm 3\text{Hz}$)

Output voltage: 32 Vdc, 2500 mA

Power consumption

- L7300/L7500: 32 watts printing; 35 watts faxing or copying
- L7600/L7700: 33 watts printing; 37 watts faxing or copying

Acoustic emission specifications (print in Draft mode, noise levels per ISO 7779)

Sound pressure (bystander position)

LpAd 55 (dBA)

Sound power

LwAd 6.9 (BA)

Supported devices

USB flash drives

HP has fully tested the following USB flash drives with the device:

- **SanDisk Cruzer Micro:** High-speed, 0120-256, 256 MB
- **Imega Micro Mini:** Full-speed, 064-0417450-YCAE032171, 128 MB
- **Kingston DataTraveler II:** High-speed, KF112504 f5274-006, 128 MB and 256 MB
- **Sony Microvault:** High-speed, D04825AB, 256 MB
- **Lexar Media JumpDrive:** 256 MB

Note: You might be able to use other USB flash drives with the device. However, HP cannot guarantee that they will function properly with the device because they have not been fully tested.

Memory card specifications

- Maximum recommended number of files on a memory card: 1,000
- Maximum recommended individual file size: 12 megapixel maximum, 8 MB maximum
- Maximum recommended memory card size: 1 GB (solid state only)



NOTE: Approaching any of the recommended maximums on a memory card might cause the performance of the device to be slower than expected.

Supported memory card types

- CompactFlash
- Memory Stick
- Memory Stick Duo
- Memory Stick Pro
- Secure Digital
- MultiMediaCard (MMC)
- xD-Picture Card

Other memory cards, including Memory Stick Magic Gate Duo, Memory Stick Duo, and Secure Multimedia Card, are supported with the use of an adapter. See the instructions that came with your memory card for more information.

D Regulatory information

This section contains the following topics:

- [FCC statement](#)
- [Notice to users of the Canadian telephone network](#)
- [Notice to users in the European Economic Area](#)
- [Other regulatory information](#)
- [Regulatory information for wireless products](#)
- [Declaration of conformity](#)
- [Environmental sustainability program](#)

FCC statement

The United States Federal Communications Commission (in 47 cfr 15.105) has specified that the following notices be brought to the attention of users of this product. This device complies with part 15 of the FCC rules. Operation is subject to the following two conditions: (1) This device may not cause harmful interference, and (2) this device must accept any interference received, including interference that may cause undesired operation.

Shielded cables

Use of a shielded data cable is required to comply with the Class B limits of Part 15 of the FCC Rules.

Pursuant to Part 15.21 of the FCC Rules, any changes or modifications to this equipment not expressly approved by the Hewlett-Packard Company, may cause harmful interference and void the FCC authorization to operate this equipment.

This equipment has been tested and found to comply with the limits for a Class B digital device, pursuant to Part 15 of the FCC Rules. These limits are designed to provide reasonable protection against harmful interference in a residential installation. This equipment generates, uses and can radiate radio frequency energy and, if not installed and used in accordance with the instructions, may cause harmful interference to radio communications. However, there is no guarantee that interference will not occur in a particular installation. If this equipment does cause harmful interference to radio or television reception, which can be determined by turning the equipment off and on, the user is encouraged to try to correct the interference by one or more of the following measures:

- Reorient or relocate the receiving antenna.
- Increase the separation between the equipment and receiver.
- Connect the equipment into an outlet on a circuit different from that to which the receiver is connected.
- Consult the dealer or an experienced radio/TV technician for help.

For further information, contact:

Manager of Corporate Product Regulations
Hewlett-Packard Company
3000 Hanover Street
Palo Alto, CA 94304
(650) 857-1501

Exposure to radio frequency radiation (wireless products only)

Exposure to radio frequency radiation

Caution The radiated output power of this device is far below the FCC radio frequency exposure limits. Nevertheless, the device shall be used in such a manner that the potential for human contact during normal operation is minimized. This product and any attached external antenna, if supported, shall be placed in such a manner to minimize the potential for human contact during normal operation. In order to avoid the possibility of exceeding the FCC radio frequency exposure limits, human proximity to the antenna shall not be less than 20 cm (8 inches) during normal operation.

Notice to users of the U.S. telephone network

Notice to users of the U.S. telephone network: FCC requirements

This equipment complies with FCC rules, Part 68. On this equipment is a label that contains, among other information, the FCC Registration Number and Ringer Equivalent Number (REN) for this equipment. If requested, provide this information to your telephone company.

An FCC compliant telephone cord and modular plug is provided with this equipment. This equipment is designed to be connected to the telephone network or premises wiring using a compatible modular jack which is Part 68 compliant. This equipment connects to the telephone network through the following standard network interface jack: USOC RJ-11C.

The REN is useful to determine the quantity of devices you may connect to your telephone line and still have all of those devices ring when your number is called. Too many devices on one line might result in failure to ring in response to an incoming call. In most, but not all, areas the sum of the RENs of all devices should not exceed five (5). To be certain of the number of devices you may connect to your line, as determined by the REN, you should call your local telephone company to determine the maximum REN for your calling area.

If this equipment causes harm to the telephone network, your telephone company might discontinue your service temporarily. If possible, they will notify you in advance. If advance notice is not practical, you will be notified as soon as possible. You will also be advised of your right to file a complaint with the FCC. Your telephone company might make changes in its facilities, equipment, operations, or procedures that could affect the proper operation of your equipment. If they do, you will be given advance notice so you will have the opportunity to maintain uninterrupted service. If you experience trouble with this equipment, please contact the manufacturer, or look elsewhere in this manual, for warranty or repair information. Your telephone company might ask you to disconnect this equipment from the network until the problem has been corrected or until you are sure that the equipment is not malfunctioning.

This equipment may not be used on coin service provided by the telephone company.

Connection to party lines is subject to state tariffs. Contact your state public utility commission, public service commission, or corporation commission for more information.

This equipment includes automatic dialing capability. When programming and/or making testcalls to emergency numbers:

- Remain on the line and explain to the dispatcher the reason for the call.
- Perform such activities in the off-peak hours, such as early morning or late evening.

Note The FCC hearing aid compatibility rules for telephones are not applicable to this equipment.

The Telephone Consumer Protection Act of 1991 makes it unlawful for any person to use a computer or other electronic device, including fax machines, to send any message unless such message clearly contains in a margin at the top or bottom of each transmitted page or on the first page of transmission, the date and time it is sent and an identification of the business, other entity, or other individual sending the message and the telephone number of the sending machine or such business, other entity, or individual. (The telephone number provided might not be a 900 number or any other number for which charges exceed local or long-distance transmission charges.) In order to program this information into your fax machine, you should complete the steps described in the software.

Notice to users of the Canadian telephone network

Note à l'attention des utilisateurs du réseau téléphonique Canadien/notice to users of the Canadian telephone network

Cet appareil est conforme aux spécifications techniques des équipements terminaux d'Industrie Canada. Le numéro d'enregistrement atteste de la conformité de l'appareil. L'abréviation IC qui précède le numéro d'enregistrement indique que l'enregistrement a été effectué dans le cadre d'une Déclaration de conformité stipulant que les spécifications techniques d'Industrie Canada ont été respectées. Néanmoins, cette abréviation ne signifie en aucun cas que l'appareil a été validé par Industrie Canada.

Pour leur propre sécurité, les utilisateurs doivent s'assurer que les prises électriques reliées à la terre de la source d'alimentation, des lignes téléphoniques et du circuit métallique d'alimentation en eau sont, le cas échéant, branchées les unes aux autres. Cette précaution est particulièrement importante dans les zones rurales.

Le numéro REN (Ringer Equivalence Number) attribué à chaque appareil terminal fournit une indication sur le nombre maximal de terminaux qui peuvent être connectés à une interface téléphonique. La terminaison d'une interface peut se composer de n'importe quelle combinaison d'appareils, à condition que le total des numéros REN ne dépasse pas 5.

Basé sur les résultats de tests FCC Partie 68, le numéro REN de ce produit est 0.0B.

This equipment meets the applicable Industry Canada Terminal Equipment Technical Specifications. This is confirmed by the registration number. The abbreviation IC before the registration number signifies that registration was performed based on a Declaration of Conformity indicating that Industry Canada technical specifications were met. It does not imply that Industry Canada approved the equipment.

Users should ensure for their own protection that the electrical ground connections of the power utility, telephone lines and internal metallic water pipe system, if present, are connected together. This precaution might be particularly important in rural areas.

Note The Ringer Equivalence Number (REN) assigned to each terminal device provides an indication of the maximum number of terminals allowed to be connected to a telephone interface. The termination on an interface might consist of any combination of devices subject only to the requirement that the sum of the Ringer Equivalence Numbers of all the devices does not exceed 5. The REN for this product is 0.0B, based on FCC Part 68 test results.

Notice to users in the European Economic Area

Notice to users in the European Economic Area



This product is designed to be connected to the analog Switched Telecommunication Networks (PSTN) of the European Economic Area (EEA) countries/regions.

Network compatibility depends on customer selected settings, which must be reset to use the equipment on a telephone network in a country/region other than where the product was purchased. Contact the vendor or Hewlett-Packard Company if additional product support is necessary.

This equipment has been certified by the manufacturer in accordance with Directive 1999/5/EC (annex II) for Pan-European single-terminal connection to the public switched telephone network (PSTN). However, due to differences between the individual PSTNs provided in different countries, the approval does not, of itself, give an unconditional assurance of successful operation on every PSTN network termination point.

In the event of problems, you should contact your equipment supplier in the first instance.

This equipment is designed for DTMF tone dialing and loop disconnect dialing. In the unlikely event of problems with loop disconnect dialing, it is recommended to use this equipment only with the DTMF tone dial setting.

Notice to users of the German telephone network

This HP fax product is designed to connect only to the analogue public-switched telephone network (PSTN). Please connect the TAE N telephone connector plug, provided with the HP All-in-One into the wall socket (TAE 6) code N. This HP fax product can be used as a single device and/or in combination (in serial connection) with other approved terminal equipment.

Other regulatory information

- [EMI statement \(Korea\)](#)
- [VCCI statement \(Japan\)](#)
- [Regulatory model number](#)
- [Power cord statement](#)
- [LED classification](#)

EMI statement (Korea)

<p>사용자 안내문 (B 급기기)</p> <p>이 기기는 비업무용으로 전자파 장애검정을 받은 기기로서, 주거지역에서는 물론 모든 지역에서 사용할 수 있습니다.</p>

VCCI statement (Japan)

この装置は、情報処理装置等電波障害自主規制協議会（VCCI）の基準に基づくクラスB情報技術装置です。この装置は、家庭環境で使用することを目的としていますが、この装置がラジオやテレビジョン受信機に近接して使用されると受信障害を引き起こすことがあります。
取り扱い説明書に従って正しい取り扱いをして下さい。

Regulatory model number

For regulatory identification purposes, your product is assigned a Regulatory Model Number. The Regulatory Model Number for your product is SNPRC-0602-01 or SNPRC-0602-02. This regulatory number should not be confused with the marketing name (HP Officejet Pro L7300/L7500/L7600/L7700) or product number (CB778A, C8157A, C8158A, C8159A).

Power cord statement

The power cord cannot be repaired. If it is defective, it should be discarded or returned to the supplier.

製品には、同梱された電源コードをお使い下さい。
同梱された電源コードは、他の製品では使用出来ません。

LED classification

CLASS 1 LED PRODUCT
LED KLASSE 1
APPARECCHIO LED DI CLASSE 1
PRODUCT CLASSY 1 Z DIODAMI (EWHECYCMILED)
Appareil à Diode Electrluminescente de Classe 1
ZARIZENI LED TRIY 1
KLASS 1 LED APPARAT
LUOKAN 1 LED

Regulatory information for wireless products

- [Notice to users in Canada/Note à l'attention des utilisateurs Canadien](#)
- [Notice to users in Brazil/Notificação de Normas de Uso de Dispositivos Sem Fio do Brasil](#)
- [Notice to users in the European Union \(English\)](#)
- [Notice to users in France](#)
- [Notice to users in Germany](#)
- [Notice to users in Italy](#)
- [Notice to users in Spain](#)

Notice to users in Canada/Note à l'attention des utilisateurs Canadien

Notice to users in Canada

Note à l'attention des utilisateurs canadiens/notice to users in Canada For Indoor Use.

This digital apparatus does not exceed the Class B limits for radio noise emissions from the digital apparatus set out in the Radio Interference Regulations of the Canadian Department of Communications. The internal wireless radio complies with RSS 210 and RSS GEN of Industry Canada.

For Indoor Use. Le présent appareil numérique n'émet pas de bruit radioélectrique dépassant les limites applicables aux appareils numériques de la classe B prescrites dans le Règlement sur le brouillage radioélectrique édicté par le ministère des Communications du Canada. Le composant RF interne est conforme à la norme RSS-210 and RSS GEN d'Industrie Canada.

Notice to users in Brazil/Notificação de Normas de Uso de Dispositivos Sem Fio do Brasil

Notice to users in Brazil

Este equipamento opera em caráter secundário, isto é, não tem direito à proteção contra interferência prejudicial, mesmo de estações do mesmo tipo, e não pode causar interferência a sistemas operando em caráter primário. (Res. ANATEL 282/2001)

Notice to users in the European Union (English)

European Union Regulatory Notice

Products bearing the CE marking comply with the following EU Directives:

- Low Voltage Directive 73/23/EEC
- EMC Directive 89/336/EEC

CE compliance of this product is valid only if powered with the correct CE-marked AC adapter provided by HP.

If this product has telecommunications functionality, it also complies with the essential requirements of the following EU Directive:

- R&TTE Directive 1999/5/EC

Compliance with these directives implies conformity to harmonized European standards (European Norms) that are listed in the EU Declaration of Conformity issued by HP for this product or product family. This compliance is indicated by the following conformity marking placed on the product.



The wireless telecommunications functionality of this product may be used in the following EU and EFTA countries:

Austria, Belgium, Cyprus, Czech Republic, Denmark, Estonia, Finland, France, Germany, Greece, Hungary, Iceland, Ireland, Italy, Latvia, Liechtenstein, Lithuania, Luxembourg, Malta, Netherlands, Norway, Poland, Portugal, Slovak Republic, Slovenia, Spain, Sweden, Switzerland, and United Kingdom.

Products with 2.4-GHz wireless LAN devices

France

For 2.4 GHz Wireless LAN operation of this product certain restrictions apply: This product may be used indoor for the entire 2400-2483.5 MHz frequency band (channels 1-13). For outdoor use, only 2400-2454 MHz frequency band (channels 1-9) may be used. For the latest requirements, see <http://www.art-telecom.fr>.

Italy

License required for use. Verify with your dealer or directly with the General Direction for Frequency Planning and Management (Direzione Generale Pianificazione e Gestione Frequenze).

Notice to users in France

Avis réglementaire concernant l'Union européenne

Les produits portant le marquage CE respectent les directives CE suivantes :

- Directive basse tension 73/23/CEE
- Directive CEM 89/336/CEE

Ce produit ne peut être considéré comme respectant les directives CE que s'il est alimenté par l'adaptateur CA portant le marquage CE fourni par HP. Si ce produit dispose d'une fonction télécommunications, il respecte également les exigences essentielles de la directive CE suivante :

- Directive RTTE 1999/5/CE

Le respect de ces directives suppose la conformité aux normes européennes harmonisées (Normes européennes) répertoriées dans la Déclaration de conformité CE publiée par HP pour ce produit ou cette gamme de produits. Les produits aux normes portent le marquage suivant.



La fonction télécommunications de ce produit peut être utilisée dans les pays de l'UE et de l'AELE suivants :

Allemagne, Autriche, Belgique, Chypre, Danemark, Espagne, Estonie, Finlande, France, Grèce, Hongrie, Irlande, Islande, Italie, Lettonie, Liechtenstein, Lituanie, Luxembourg, Malte, Norvège, Pays-Bas, Pologne, Portugal, République tchèque, Royaume-Uni, Slovaquie, Slovénie, Suède et Suisse.

Produits équipés de périphériques LAN sans fil 2,4 GHz

France

L'utilisation de cet équipement (2.4GHz Wireless LAN) est soumise à certaines restrictions : Cet équipement peut être utilisé à l'intérieur d'un bâtiment en utilisant toutes les fréquences de 2400 à 2483.5MHz (Chaîne 1-13). Pour une utilisation en environnement extérieur, vous devez utiliser les fréquences comprises entre 2400-2454 MHz (Chaîne 1-9). Pour les dernières restrictions, voir <http://www.art-telecom.fr>

Italie

Une licence est requise pour ce type de périphériques. Pour l'obtenir, adressez-vous à votre revendeur ou directement à la Direction générale de la planification et de la gestion des fréquences (Direzione Generale Pianificazione e Gestione Frequenze).

Notice to users in Germany

Rechtlicher Hinweis für die Europäische Union

Produkte mit der CE-Kennzeichnung entsprechen den folgenden EU-Richtlinien:

- Niederspannungsrichtlinie 73/23/EEC
- EMC-Richtlinie 89/336/EEC

Die Erfüllung der CE-Richtlinien dieses Produkts ist nur gewährleistet, sofern die Stromversorgung über den ordnungsgemäßen Wechselstromadapter mit der CE-Kennzeichnung erfolgt, der von HP zur Verfügung gestellt wird. Falls dieses Produkt Telekommunikationsfunktionen aufweist, erfüllt es zudem die erforderlichen Anforderungen der folgenden EU-Richtlinie:

- R&TTE-Richtlinie 1999/5/EC

Die Erfüllung dieser Richtlinien impliziert die Konformität mit den harmonisierten europäischen Standards (Europäische Normen), die in der von HP für dieses Produkt oder die entsprechende Produktfamilie herausgegebenen EU-Konformitätserklärung aufgeführt sind. Eine entsprechende Erfüllung ist durch folgende Konformitätskennzeichnung auf dem Produkt erkennbar.



Die drahtlose Telekommunikationsfunktion dieses Produkts kann in folgenden EU- und EFTA-Ländern verwendet werden:

Österreich, Belgien, Zypern, Tschechische Republik, Dänemark, Estland, Finnland, Frankreich, Deutschland, Griechenland, Ungarn, Island, Irland, Italien, Lettland, Liechtenstein, Litauen, Luxemburg, Malta, Niederlande, Norwegen, Polen, Portugal, Slowakei, Slowenien, Spanien, Schweden, Schweiz und Vereinigtes Königreich.

Produkte mit drahtlosen LAN-Geräten mit 2,4-GHz

Frankreich

Für den 2,4 GHz Wireless LAN-Betrieb dieses Produkts gelten bestimmte Einschränkungen: Dieses Produkt kann in Innenräumen mit der gesamten Frequenzbandbreite von 2400-2483,5 MHz (Kanäle 1-13) verwendet werden. Für die Nutzung in Außenräumen ist nur die Verwendung innerhalb der Bandbreite von 2400-2454 MHz (Kanäle 1-9) zulässig. Die aktuellen Einschränkungen finden Sie unter <http://www.art-telecom.fr>.

Italien

Es ist eine Lizenz für die Nutzung erforderlich. Prüfen Sie dies zusammen mit Ihrem Händler oder direkt mit der General Direction for Frequency Planning and Management (Generaldirektion für Frequenzplanung und -verwaltung).

Notice to users in Italy

Avviso relativo alle normative dell'Unione Europea

I prodotti con il marchio CE sono conformi alle seguenti direttive UE:

- Direttiva Bassa Tensione 73/23/CEE
- Direttiva CEM 89/336/CEE

La conformità CE di questo prodotto è valida unicamente se il prodotto viene alimentato con il corretto adattatore CA dotato di marchio CE e fornito da HP. Se questo prodotto è dotato di funzionalità per le telecomunicazioni, è inoltre conforme alle disposizioni essenziali della seguente direttiva UE:

- Direttiva R&TTE 1999/5/CE

La conformità a queste direttive implica conformità alle norme europee armonizzate (Norme europee) elencate nella Dichiarazione di conformità UE pubblicata da HP per questo prodotto o per questa gamma di prodotti. Tale conformità viene indicata dal seguente marchio di conformità collocato sul prodotto.



La funzionalità per le telecomunicazioni wireless di questo prodotto può essere utilizzata nei seguenti Paesi dell'Unione Europea e dell'AELS:

Austria, Belgio, Cipro, Repubblica Ceca, Danimarca, Estonia, Finlandia, Francia, Germania, Grecia, Ungheria, Islanda, Irlanda, Italia, Lettonia, Liechtenstein, Lituania, Lussemburgo, Malta, Paesi Bassi, Norvegia, Polonia, Portogallo, Repubblica Slovacca, Slovenia, Spagna, Svezia, Svizzera e Regno Unito.

Prodotti con periferiche di rete wireless a 2,4-GHz

Francia

Il funzionamento di questo prodotto in reti wireless a 2,4 GHz comporta determinate limitazioni: questo prodotto può essere utilizzato all'interno di un edificio per l'intera banda di frequenza da 2400 a 2483,5 MHz (canali da 1 a 13); per l'uso in ambienti esterni, è possibile utilizzare unicamente la banda di frequenza da 2400 a 2454 MHz (canali da 1 a 9). Per informazioni più aggiornate sui requisiti, vedere il sito <http://www.art-telecom.fr>.

Italia

È necessaria una concessione ministeriale anche per l'uso del prodotto. Verificare con il proprio distributore o direttamente presso la Direzione Generale Pianificazione e Gestione Frequenze.

Notice to users in Spain

Avisos de la Unión Europea

Los productos que llevan el marcado CE acatan las siguientes Directivas de la UE:

- Directiva de Baja Tensión 73/23/CEE
- Directiva CEM 89/336/CEE

La conformidad CE de este producto es válida, únicamente, si funciona con un adaptador de CA suministrado por HP con el marcado CE correcto. Si este producto incluye la funcionalidad de telecomunicación, también deberá cumplir con los requisitos esenciales que se incluyen a continuación.

Directiva UE:

- R&TTE 1999/5/CE

La conformidad con estas Directivas implica el cumplimiento de los estándares europeos armonizados (normas europeas) que se enumeran en la declaración de conformidad UE emitida por HP para este producto o grupo de productos. Viene representada por el siguiente marcado de conformidad incluido en el producto.



La funcionalidad de telecomunicación de este producto puede utilizarse en los siguientes países pertenecientes a la UE y a la AELC:

Austria, Bélgica, Chipre, República Checa, Dinamarca, Estonia, Finlandia, Francia, Alemania, Grecia, Hungría, Islandia, Irlanda, Italia, Latvia, Liechtenstein, Lituania, Luxemburgo, Malta, Países Bajos, Noruega, Polonia, Portugal, Eslovaquia, Eslovenia, España, Suecia, Suiza, y Reino Unido.

Productos con dispositivos LAN inalámbricos de 2,4 GHz

Francia

Se aplican determinadas restricciones al uso de este producto con redes LAN inalámbricas de 2,4 GHz: puede utilizarse en el interior para toda la banda de frecuencias que abarca de 2.400 a 2.483,5 MHz (canales 1-13). En el exterior, puede utilizarse, únicamente, para la banda de frecuencias entre 2.400 y 2.454 MHz (canales 1-9). Para conocer los últimos requisitos, consulte <http://www.art-telecom.fr>.

Italia

Se exige licencia de uso. Verifique esta información con su proveedor o directamente con la dirección general para la planificación y gestión de frecuencias (Direzione Generale Pianificazione e Gestione Frequenze).

Declaration of conformity

HP Officejet Pro L7500/L7600



DECLARATION OF CONFORMITY

according to ISO/IEC Guide 22 and EN 45014

Manufacturer's Name: Hewlett-Packard Singapore (Pte) Ltd

Manufacturer's Address: Imaging and Printing Manufacturing Operations
60 Alexandra Terrace, #07-01, The Comtech
Singapore 118502.

declares, that the product

Product Name: HP Officejet Pro L7500 series
HP Officejet Pro L7600 series

Regulatory Model Number ⁽¹⁾: SNPRC-0602-01

Product Accessory Number: CB007A - 250-sheet Tray 2
C8255A - Duplexer

Product Options: All

conforms to the following Product Specifications:

Safety: IEC 60950-1: 2001 / EN 60950-1:2001
EN 60825-1:1994 + A1:2002 +A2:2001 Class 1 for LEDs

EMC: CISPR 22: 1993 + A1 +A2/ EN 55022:1994 +A1 + A2 Class B ⁽²⁾
CISPR 24:1997 + A1 + A2 / EN 55024: 1998 + A1 + A2

IEC 61000-3-2: 2000 / EN 61000-3-2: 2000
IEC 61000-3-3:1994 +A1: 2001 / EN 61000-3-3:1995 + A1:2001

FCC Title 47 CFR, Part 15 Class B ⁽²⁾
ICES-003, Issue 4 Class B ⁽²⁾

Telecom: TBR 21:1998

Supplementary Information:

The product herewith complies with the requirements of the Low Voltage Directive 73/23/EEC, EMC Directive 89/336/EEC and the R&TTE Directive 1999/5/EC (Annex II) and carries the CE marking accordingly.

(1)This product is assigned a Regulatory model number that stays with the regulatory aspects of the design. The Regulatory Model Number is the main product identifier in the regulatory documentation and test reports, this number should not be confused with the marketing name or the product numbers.

(2)The product was tested in a typical configuration with Hewlett Packard personal computer systems.

05 May 2006

**Chan Kum Yew
Director, Quality**

Local Contact for regulatory topics only:

European Contact: Hewlett-Packard GmbH, HQ-TRE, Herrenberger Strasse 140, 71034 Boeblingen, Germany

USA Contact: Hewlett-Packard Company, HPCC, 20555 S.H. 249 Houston, Texas, 77070

Australia Contact: Hewlett Packard Australia Ltd, Product Regulations Manager, 31-41 Joseph Street, Blackburn, Victoria 3130, Australia.



DECLARATION OF CONFORMITY

according to ISO/IEC Guide 22 and EN 45014

Manufacturer's Name: Hewlett-Packard Singapore (Pte) Ltd
Manufacturer's Address: Imaging and Printing Manufacturing Operations
60 Alexandra Terrace, #07-01, The Comtech
Singapore 118502.

declares, that the product

Product Name: HP Officejet Pro L7700 series

Regulatory Model Number ⁽¹⁾: SNPRC-0602-02

Radio Module Number: RSVLD-0506

Product Accessory Number: CB007A - 250-sheet Tray 2
C8255A - Duplexer

Product Options: All

conforms to the following Product Specifications:

Safety: IEC 60950-1: 2001 / EN 60950-1:2001
EN 60825-1:1994 + A1:2002 +A2:2001 Class 1 for LEDs

EMC: CISPR 22: 1993 + A1 +A2/ EN 55022:1994 +A1 + A2 Class B ⁽²⁾
CISPR 24:1997 + A1 + A2 / EN 55024: 1998 + A1 + A2
IEC 61000-3-2: 2000 / EN 61000-3-2: 2000
IEC 61000-3-3:1994 +A1: 2001 / EN 61000-3-3:1995 + A1:2001
FCC Title 47 CFR, Part 15 Class B ⁽²⁾
ICES-003, Issue 4 Class B ⁽²⁾

Telecom: TBR 21:1998
EN 301 489-1: 2002
EN 301 489-17: 2002
EN 300 328:2004-11

Health: EU:1999/519/EC

Supplementary Information:

The product herewith complies with the requirements of the Low Voltage Directive 73/23/EEC, EMC Directive 89/336/EEC and the R&TTE Directive 1999/5/EC (Annex II) and carries the CE marking accordingly.

(1) This product is assigned a Regulatory model number that stays with the regulatory aspects of the design. The Regulatory Model Number is the main product identifier in the regulatory documentation and test reports, this number should not be confused with the marketing name or the product numbers.

(2) The product was tested in a typical configuration with Hewlett Packard personal computer systems.

05 May 2006

**Chan Kum Yew
Director, Quality**

Local Contact for regulatory topics only:

European Contact: Hewlett-Packard GmbH, HQ-TRE, Herrenberger Strasse 140, 71034 Boeblingen, Germany

USA Contact: Hewlett-Packard Company, HPCC, 20555 S.H. 249 Houston, Texas, 77070

Australia Contact: Hewlett Packard Australia Ltd, Product Regulations Manager, 31-41 Joseph Street, Blackburn, Victoria 3130, Australia.

Environmental sustainability program

Hewlett-Packard is committed to providing quality products in an environmentally sound manner. HP continuously improves the design processes of its products to minimize the negative impact on the office environment and on the communities where devices are manufactured, shipped, and used. HP has also developed processes to minimize the negative impact of the disposal of the device at the end of its printing life.

For more information about HP's environmental sustainability program, see www.hp.com/hpinfo/globalcitizenship/environment/index.html.

Reduction and elimination

Paper use

This product's two-sided (duplex) printing and N-up printing feature (which allows you to print multiple pages of a document on one sheet of paper) can reduce paper usage and the resulting demands on natural resources. See this guide for more information about using these features.

Ink use

This product's draft mode uses less ink, which might extend the life of the cartridges. See the print driver's online Help for more information.

Ozone-depleting chemicals

Ozone-depleting chemicals, such as chlorofluorocarbons (CFCs), have been eliminated from HP manufacturing processes.

Power consumption



Power usage drops significantly while in PowerSave/Sleep mode, which saves natural resources and saves money without affecting the high performance of this product.

Battery information

This device contains the following, mercury-free battery:

Specification	Value
Battery part number	1420-0887
Battery material	Lithium polycarbon monfluoride
Battery type	Button/coin cell battery
Quantity per product	1
Weight	2.50 grams (0.09 ounces)
Battery manufacturer	Panasonic, Japan

 **NOTE:** The battery might require recycling or proper disposal at end-of-life.

 Batterij niet weggooien, maar inleveren als KCA. 	<p>Dit HP Product bevat een lithium-manganees-dioxide batterij. Deze bevindt zich op de hoofdprintplaat. Wanneer deze batterij leeg is, moet deze volgens de geldende regels worden afgevoerd.</p>
--------------------------------------------------------------------------------------------------------------------------------------------------------------------------------------------------------------------------	----------------------------------------------------------------------------------------------------------------------------------------------------------------------------------------------------

Material safety data sheets

Material safety data sheets (MSDSs) can be obtained from the following HP Web site:
www.hp.com/go/msds.

Recycling

Design for recycling has been incorporated into this device:

- The number of materials has been kept to a minimum while ensuring proper functionality and reliability.
- Dissimilar materials have been designed to separate easily.
- Fasteners and other connections are easy to locate, access, and remove using common tools.
- High-priority parts have been designed so that they can be accessed quickly for efficient disassembly and repair.

Product packaging

The packaging materials for this device have been selected to provide maximum protection for the least cost possible, while attempting to minimize environmental impact and facilitate recycling. The rugged design of the device assists in minimizing both packaging materials and damage rates.

Plastics

Plastic parts over 25 grams are marked according to international standards that enhance the ability to identify plastics for recycling purposes at the end of the product's life.

Disposal of waste equipment by users in private households in the European Union



This symbol on the product or on its packaging indicates that this product must not be disposed of with your other household waste. Instead, it is your responsibility to dispose of your waste equipment by handing it over to a designated collection point for the recycling of waste electrical and electronic equipment. The separate collection and recycling of your waste equipment at the time of disposal will help to conserve natural resources and ensure that it is recycled in a manner that protects human health and the environment. For more information about where you can drop off your waste equipment for recycling, please contact your local city office, your household waste disposal service or the shop where you purchased the product.

HP products and supplies

HP's Planet Partners™ recycling service provides an easy way to recycle any brand of computer equipment or HP printing supplies. HP's state-of-the-art processes ensure that your unwanted hardware or HP printing supply is recycled in a way that conserves resources.

For more information, see www.hp.com/recycle.

Index

- A**
- accessibility 11
 - accessories
 - installation 21
 - order 198
 - self-test diagnostic page 97
 - turn on and off in driver 22
 - warranty 203
 - acoustic emissions 212
 - Add Printer installation 128
 - ADF (automatic document feeder)
 - capacity 30
 - clean 153
 - clear jams 195
 - load originals 30
 - media sizes supported 33
 - administrator
 - management tools 86
 - settings 88
 - ADSL, fax setup with
 - parallel phone systems 106
 - aligning printheads 146
 - answer ring pattern
 - change 80
 - parallel phone systems 108
 - answering machine
 - fax tones recorded 185
 - set up with fax (parallel phone systems) 117
 - set up with fax and modem 118
 - Attention light 16
 - Auto Answer button 17
 - automatic document feeder (ADF)
 - capacity 30
 - clean 153
 - clear jams 195
 - load originals 30
 - media sizes supported 33
- B**
- Back button 17
 - backup fax reception 74
 - baud rate 82
 - black and white pages
 - copy 50
 - fax 70
 - troubleshoot 164
 - black dots or streaks, troubleshoot
 - copies 169
 - scan 173
 - blank pages, troubleshoot
 - copy 167
 - print 160
 - scan 173
 - blocked fax numbers
 - control panel button 16
 - set up 77
 - view list 78
 - Bluetooth
 - color display icon 18
 - connect devices 136
 - dongle, order online 198
 - features available 20
 - Mac OS, print from 138
 - security settings 138
 - setup 135
 - Windows, print from 136
 - borderless printing
 - Mac OS 43
 - Windows 42
 - both sides, print on 48
 - broadcast faxing
 - send 73
 - buttons, control panel 16
- C**
- cables
 - order USB 198
 - regulatory compliance 214
 - calibrate linefeed 147
 - cameras
 - connect 59, 61
 - control panel display mode 19
 - insert memory cards 58
 - port, locating 14, 59
 - print DPOF files 59
 - save photos to computer 68
 - cancel
 - copy 51
 - print job 49
 - scan 57
 - Cancel button 17
 - capacity
 - ADF 30
 - trays 36
 - cards
 - guidelines 32
 - sizes supported 34
 - tray supporting 36
 - cartridges. *See* ink cartridges
 - chlorofluorocarbons (CFCs) 228
 - clean
 - ADF 153
 - exterior 157
 - printheads 147
 - scanner glass 152
 - color copy 50
 - colored text, and OCR 56
 - colors
 - bleeding 165
 - faded or dull 164
 - print black and white, troubleshoot 164
 - specifications 210
 - troubleshoot 165
 - wrong 164
 - CompactFlash memory card
 - insert 58
 - slot, locating 14
 - computer modem
 - shared with fax (parallel phone systems) 111
 - shared with fax and answering machine (parallel phone systems) 118
 - shared with fax and voice line (parallel phone systems) 113
 - shared with fax and voice mail (parallel phone systems) 122
 - confirmation reports, fax 84

Index

- connections
 - Bluetooth 135
 - features available 19
 - connectors, locating 15
 - control panel
 - administrator settings 88
 - buttons 16
 - copy from 50
 - crop images 51
 - display 19
 - enter text and symbols 28
 - faceplate, removing 205
 - lights 16
 - locating 13
 - manage device 86
 - menus 24
 - messages 25
 - network settings 99
 - print photos 62
 - scan from 52
 - send faxes 71
 - send scans to
 - programs 54
 - settings, change 25
 - status icons 18
 - copy
 - cancel 51
 - crop originals 50
 - from the control panel 50
 - quality 168
 - settings 50
 - specifications 211
 - troubleshoot 167
 - Copy button 16
 - Copy menu 24
 - correct port test, fax 176
 - critical error messages 25
 - crop originals 50
 - custom-sized media
 - guidelines 33
 - print on 41
 - sizes supported 35
 - customer support
 - electronic 200
 - HP Instant Support 94
 - phone support 200
 - cut-off pages, troubleshoot 161
- D**
- dark images, troubleshoot
 - copies 168
 - scans 173
 - Declaration of Conformity (DOC) 226
 - default settings
 - control panel 25
 - copy 50
 - driver 47
 - print 47
 - deleting faxes from memory 75
 - dial tone test, failure 178
 - dial type, setting 81
 - dial-up modem
 - shared with fax (parallel phone systems) 111
 - shared with fax and answering machine (parallel phone systems) 118
 - shared with fax and voice line (parallel phone systems) 113
 - shared with fax and voice mail (parallel phone systems) 122
 - digital cameras
 - connect 59, 61
 - control panel display mode 19
 - insert memory cards 58
 - port, locating 14, 59
 - print DPOF files 59
 - save photos to computer 68
 - Digital Filing
 - scan to 54
 - digital filing
 - set up 52
 - Digital Filing button 16
 - display, control panel 19
 - distinctive ringing
 - change 80
 - parallel phone systems 108
 - DOC 226
 - documentation 10
 - dots or streaks, troubleshoot
 - copies 169
 - dots per inch (dpi)
 - fax 16
 - print 210
 - dots, troubleshoot
 - scan 173
 - double-sided printing 48
 - DPOF files 59
 - driver
 - accessories settings 22
 - settings 47
 - version 201
 - warranty 203
 - DSL, fax setup with
 - parallel phone systems 106
 - duplex printing accessory
 - order online 198
 - duplexer
 - clear jams 192
 - installation 21
 - locating 15
 - margins, minimum 37
 - media sizes supported 33
 - media types and weights supported 36
 - turn on and off in driver 22
 - using 48
 - duty cycle 208
- E**
- edit
 - scanned images 56
 - text in OCR program 56
 - electrical specifications 212
 - embedded Web server
 - about 90
 - administrator settings 88
 - answer ring pattern, fax 81
 - backup fax reception, set up 75
 - blocked fax numbers, view 78
 - clear fax log 76
 - fax header, setting 79
 - fax log, view 85
 - features 86
 - forwarding faxes 76
 - opening 90
 - pages 91
 - system requirements 210
 - troubleshoot, cannot be opened 187
 - Webscan 55
 - envelopes
 - guidelines 32
 - sizes supported 34
 - tray supporting 36
 - environmental
 - specifications 212
 - environmental sustainability program 228

- error messages
 - control panel 25
 - unable to activate TWAIN
 - source 171
- error reports, fax 84
- error-correction mode, fax 81
- Ethernet connections 19
- Ethernet network port,
 - locating 15
- European Union waste
 - disposal 229
- event log 97
- EWS. *See* embedded Web
 - server

F

- faded copies 168
- faded stripes on copies,
 - troubleshoot 168
- fax
 - answer mode 79
 - answering machine and
 - modem, shared with
 - (parallel phone
 - systems) 118
 - answering machine
 - troubleshoot 185
 - answering machine, set up
 - (parallel phone
 - systems) 117
 - auto answer 17, 79
 - backup fax reception 74
 - block numbers 16
 - blocking numbers 77
 - clear log 76
 - confirmation reports 84
 - deleting from memory 75
 - dial tone test, failed 178
 - dial type, setting 81
 - distinctive ringing setup
 - (parallel phone
 - systems) 108
 - distinctive ringing, change
 - pattern 80
 - DSL, set up (parallel phone
 - systems) 106
 - enter text and symbols 28
 - error reports 84
 - error-correction mode 81
 - forwarding 76
 - header 79
 - Internet, over 82

- ISDN line, set up (parallel
 - phone systems) 107
- line condition test, failed 179
- log, print 85
- manual receive 73
- modem and answering
 - machine, shared with
 - (parallel phone
 - systems) 118
- modem and voice line,
 - shared with (parallel
 - phone systems) 113
- modem and voice mail,
 - shared with (parallel
 - phone systems) 122
- modem, shared with
 - (parallel phone
 - systems) 111
- monitor dialing 72, 73
- network folder speed-dial
 - entries 45
- parallel phone systems 102
- pause 28
- PBX system, set up
 - (parallel phone
 - systems) 107
- phone cord connection test,
 - failed 176
- phone cord too short 185
- phone cord type test,
 - failed 177
- receive 73
- receive, troubleshoot 180,
 - 182
- redial options 81
- Redial/Pause button 17
- reports 83
- reprint 75
- rings to answer 80
- scan 17
- send 70
- send, troubleshoot 180,
 - 182, 184
- separate line setup (parallel
 - phone systems) 105
- set up 101
- settings, change 79
- setup types 102
- shared phone line setup
 - (parallel phone
 - systems) 109
- specifications 211
- speed 82

- speed-dial entries, set up 43
- speed-dial groups, set up 44
- test failed 174
- test setup 83
- troubleshoot 174
- voice mail, set up (parallel
 - phone systems) 110
- wall jack test, failed 175
- Fax menu 24
- Fax Menu button 16
- fax port, locating 15
- FCC statement 214
- firewalls, troubleshoot 159
- FoIP 82
- fonts supported 208
- forwarding faxes 76

G

- getting started guide 10
- glass, scanner
 - clean 152
 - load originals 31
 - locating 13
- grainy or white bands on
 - copies, troubleshoot 169
- graphics
 - incompletely filled on
 - copies 169
 - ink not filling in 164
 - look different from original
 - scan 172
 - missing lines or dots 165
- groups, speed-dial
 - set up 44

H

- hardware, fax setup test 175
- header, fax 79
- help
 - HP Instant Support 94
 - see also* customer support
- Help button 17
- HP Instant Support
 - about 94
 - accessing 95
 - myPrintMileage 94
 - security and privacy 95
- HP Photosmart Software
 - send scans to programs 54
- HP Photosmart Studio
 - send scans to programs 54
- HP Planet Partners 229

Index

- HP Printer Utility (Mac OS)
 - administrator settings 89
 - features 86
 - opening 93
 - panels 93
- HP Solution Center 26
- HP Web Jetadmin
 - about 94
 - features 86
- humidity specifications 212
- I**
- Information tab, Toolbox (Windows) 92
- ink cartridge door, locating 14
- ink cartridges
 - expiration dates 97
 - locating 14
 - order online 198
 - part numbers 97, 198
 - remove 204
 - replace 144
 - status 87, 97
 - supported 143, 208
 - warranty 203
 - yields 208
- ink level icons 18
- ink smearing, troubleshoot 163
- installation
 - accessories 21
 - Add Printer, Windows 128
 - duplexer 21
 - ink cartridges 144
 - software for Mac OS 128
 - software for Windows 125
 - tray 2 21
 - troubleshoot 188
 - Windows network software 127
- Internet
 - fax, using 82
- IP address
 - checking for device 187
 - static, setting 158
- IP settings 101
- ISDN line, set up with fax
 - parallel phone systems 107
- J**
- jams
 - ADF 195
 - clear 192
 - media to avoid 32
 - prevent 197
- Japanese VCCI statement 219
- jobs
 - settings 25
- Junk Fax Blocker button 16
- junk fax mode 77
- K**
- keypad, control panel
 - enter text and symbols 28
 - locating 16
- Korean EMI statement 218
- L**
- language, printer 208
- LED classification statement 219
- left arrow 16
- light images, troubleshoot
 - copies 168
 - scans 173
- lights, control panel 16
- line condition test, fax 179
- linefeed, calibrate 147
- lines
 - copies, troubleshoot 168
 - scans, troubleshoot 172, 173
- link speed, setting 100
- load
 - originals in ADF (automatic document feeder) 30
 - tray 1 38
 - tray 2 39
- locking trays 40
- log, clear fax 76
- log, fax
 - print 85
 - view 85
- M**
- Mac OS
 - Bluetooth 138
 - borderless printing 43
 - duplexing 49
 - HP Photosmart Studio 26
 - HP Printer Utility 93
 - install software 128
 - Network Printer Setup Utility 94
 - print on special, or custom-sized media 41
 - print settings 47
 - sharing device 129
 - system requirements 209
 - turn accessories on and off in driver 22
 - uninstall software 141
 - wireless communication setup 133
- management tools 86
- manual faxing
 - receive 73
 - send 71, 72
- margins
 - duplexer 37
 - setting, specifications 37
- material safety data sheets (MSDSs) 229
- media
 - ADF capacity 30
 - borderless printing 42
 - clear jams 192
 - duplexing 48
 - HP, order 199
 - load tray 1 37
 - load tray 2 39
 - locking trays 40
 - print on custom-sized 41
 - selecting 32
 - skewed pages 166
 - specifications 33
 - supported sizes 33
 - troubleshoot feeding 166
 - types and weights supported 36
 - usage 87
- memory
 - deleting faxes 75
 - reprint faxes 75
 - save faxes 74
 - specifications 209
- memory cards
 - control panel display mode 19
 - fax 17
 - insert 58
 - print DPOF files 59
 - print photos 62
 - proof sheets 62
 - save photos to computer 68
 - scan to 55
 - slots, locating 14

- specifications 213
- troubleshoot 186
- memory device light, locating 13
- Memory Stick cards
 - insert 58
 - slot, locating 14, 58
- menus, control panel 24
- missing lines or dots,
 - troubleshoot 165
- missing or incorrect information, troubleshoot 161
- MMC memory card
 - insert 58
 - slot, locating 14
- model number 97
- modem
 - shared with fax (parallel phone systems) 111
 - shared with fax and answering machine (parallel phone systems) 118
 - shared with fax and voice line (parallel phone systems) 113
 - shared with fax and voice mail (parallel phone systems) 122
- monitor dialing 72, 73
- monitoring tools 87
- multi-feeds, troubleshoot 166
- myPrintMileage
 - about 95
 - accessing 96
 - features 86

N

- network folders
 - scan to 53
 - troubleshoot 173
- network folders, as speed-dial entries 45
- Network Printer Setup Utility (Mac OS) 94
- networks
 - advanced settings 100
 - connector illustration 15
 - Digital Filing button 16
 - Ethernet connections 19
 - firewalls, troubleshoot 159
 - HP Web Jetadmin 94
 - IP settings 101
 - link speed 100

- Mac OS setup 128
- operating systems
 - supported 210
- protocols supported 210
- self-test diagnostic page 96
- settings, change 99
- sharing, Windows 126
- static IP address,
 - setting 158
- system requirements 210
- view and printsettings 100
- Windows setup 127
- wireless communication
 - setup 129
 - wireless settings 98, 130
 - Wireless Setup Wizard 100
- noise information 212
- Number of Copies button 16

O

- OCR
 - edit scanned documents 56
 - troubleshoot 171
- OK button 16
- On button 17
- one-touch speed dial buttons 16
- operating environment
 - specifications 212
- operating systems
 - supported 209
- originals
 - crop 50
 - edit scans 56
 - load ADF (automatic document feeder) 30
 - scan 52
- output tray
 - locating 13
 - media supported 36
- ozone-depleting chemicals 228

P

- packing the device 206
- pages per month (duty cycle) 208
- panoramic photos 65
- paper. *See* media
- paper-feed problems,
 - troubleshoot 165
- parallel phone systems
 - answering machine
 - setup 117

- countries/regions with 102
- distinctive ringing setup 108
- DSL setup 106
- ISDN setup 107
- modem and answering machine setup 118
- modem and voice mail
 - setup 122
- modem setup 111
- modem shared with voice line setup 113
- PBX setup 107
- separate line setup 105
- setup types 102
- shared line setup 109
- part numbers, supplies and accessories 198
- passkey authentication, Bluetooth 138
- passport photos 66
- PBX system, set up with fax
 - parallel phone systems 107
- PCL 3 support 208
- phone cord
 - connected to correct port
 - test failed 176
 - correct type test failed 177
 - extend 185
- phone customer support 200
- phone line, answer ring pattern 80
- phone, fax from
 - receive 73
 - send, 71
- photo media
 - guidelines 33
 - sizes supported 35
- Photo menu 24
- Photo Menu button 16
- photos
 - borderless printing 42
 - connect a PictBridge camera 59
 - connect storage device 61
 - edit scans 56
 - insert memory cards 58
 - panoramic 65
 - passport 66
 - print from control panel 82
 - print from DPOF files 59
 - proof sheets 62
 - save to computer 68

Index

- troubleshoot memory
 - cards 186
 - video action prints 67
 - view 62
 - Photosmart Software
 - send scans to programs 54
 - Photosmart Studio
 - send scans to programs 54
 - PictBridge mode 59, 60
 - PictBridge-enabled digital
 - camera port, locating 14, 59
 - ports, specifications 208
 - power
 - consumption 228
 - specifications 212
 - troubleshoot 158
 - power cord statement 219
 - power input, locating 15
 - power on button 17
 - print
 - Bluetooth 135
 - cancel 49
 - double-sided 48
 - fax logs 85
 - fax reports 83
 - faxes 75
 - panoramic photos 65
 - passport photos 66
 - photos from DPOF file 59
 - photos from memory card 62
 - proof sheets 62
 - self-test diagnostic page 97
 - settings 47
 - slow 160
 - speed-dial entries 46
 - troubleshoot 158
 - video action photos 67
 - print cartridges. *See* ink cartridges
 - print driver
 - accessories settings 22
 - settings 47
 - version 201
 - warranty 203
 - print quality
 - diagnostic page 145
 - troubleshoot 162
 - Print quality diagnostic page 145
 - print-carriage access door, locating 14
 - printer driver
 - accessories settings 22
 - settings 47
 - version 201
 - warranty 203
 - printhead latch, locating 14
 - printheads
 - aligning 146
 - clean 147
 - clean contacts manually 147
 - health, check 145
 - locating 14
 - maintaining 145
 - order online 198
 - part numbers 199
 - remove 204
 - replace 150
 - status 87, 97, 145
 - supported 208
 - troubleshoot 159
 - warranty 203
 - privacy, HP Instant Support 95
 - processor specifications 209
 - Proof Sheet button
 - control panel button 17
 - proof sheet button 17
 - proof sheets
 - fill in 64
 - print 62
 - scan 64
 - pulse dialing 81
- Q**
- Quality button 17
 - quality, troubleshoot
 - copy 168
 - diagnostic page 145
 - print 162
 - scan 171
- R**
- radio frequency radiation 215
 - radio interference
 - reducing 134
 - regulatory information 219
 - radio, turn off 100
 - readme 10
 - rear access panel
 - clear jams 192
 - illustration 15
 - receive faxes
 - auto answer mode 79
 - automatically 73
 - blocking numbers 77
 - forwarding 76
 - manually 73
 - rings to answer 80
 - troubleshoot 180, 182
 - recycling 229
 - redial options, setting 81
 - Redial/Pause button 17
 - Reduce/Enlarge button 16
 - regulatory information 214, 219
 - regulatory model number 219
 - release notes 10
 - remove ink cartridges and printheads 204
 - replace
 - ink cartridges 144
 - printheads 150
 - reports
 - confirmation, fax 84
 - error, fax 84
 - fax test failed 174
 - reprint
 - faxes from memory 75
 - resolution
 - fax 16, 17
 - print 210
 - Resolution button 16
 - Right arrow 16
 - rings to answer 80
 - Rotate button 17
- S**
- save
 - default settings 25
 - faxes in memory 74
 - photos to computer 68
 - scan
 - cancel 57
 - Direct Digital Filing 52
 - edit images 56
 - error messages 171
 - from a TWAIN- or WIA-compliant program 55
 - from control panel 52
 - from Webscan 55
 - OCR 56
 - proof sheets 64
 - quality 171
 - Scan Menu button 16
 - scan specifications 212
 - send to a program 54
 - settings for 57
 - slow 170
 - Start Color Photo button 17

- Start Color Scan button 17
- to memory card 55
- troubleshoot 169
- Scan menu 24
- Scan Menu button 16
- scanner glass
 - clean 152
 - load originals 31
 - locating 13
- Secure Digital memory card
 - insert 58
 - slot, locating 14
- Secure MMC memory card
 - slot, locating 14
- SecureEasySetup (SES),
 - wireless communication 133
- security
 - Bluetooth 138
 - HP Instant Support 95
 - manage 87
 - wireless communication 134
 - wireless settings 131
- self-test diagnostic page
 - information on 96
 - print 97
- send faxes
 - basic fax 70
 - manually 71
 - monitor dialing 72, 73
 - troubleshoot 180, 182, 184
- send scans
 - for OCR 56
 - to a program 54
 - troubleshoot 169
- serial number 97
- serial phone systems
 - countries/regions with 102
 - setup types 102
- Services tab, Toolbox (Windows) 92
- settings
 - administrator 88
 - control panel 25
 - copy 50
 - driver 47
 - network 99
 - scan 57
 - speed, fax 82
- setup
 - answering machine (parallel phone systems) 117
 - answering machine and modem (parallel phone systems) 118
 - Bluetooth 135
 - computer modem (parallel phone systems) 111
 - computer modem and answering machine (parallel phone systems) 118
 - computer modem and voice line (parallel phone systems) 113
 - computer modem and voice mail (parallel phone systems) 122
 - connection types 19
 - distinctive ringing 80
 - distinctive ringing (parallel phone systems) 108
 - DSL (parallel phone systems) 106
 - fax 101
 - fax scenarios 102
 - fax, with parallel phone systems 102
 - ISDN line (parallel phone systems) 107
 - PBX system (parallel phone systems) 107
 - separate fax line (parallel phone systems) 105
 - shared phone line (parallel phone systems) 109
 - test fax 83
 - voice mail (parallel phone systems) 110
 - voice mail and computer modem (parallel phone systems) 122
 - Windows 125
 - Windows networks 127
- Setup button 17
- setup poster 10
- sharing 19
- sharing device
 - Mac OS 129
 - Windows 126
- shipping the device 204
- size
 - scans, troubleshoot 173
 - troubleshoot copy 168
- skew, troubleshoot
 - copy 169
 - print 166
 - scan 172
- slow print, troubleshoot 160
- software
 - accessories settings 22
 - connection types 19
 - HP Photosmart 26
 - installation on Mac OS 128
 - installation on Windows 125
 - management tools 86
 - OCR 56
 - uninstall from Mac OS 141
 - uninstall from Windows 140
 - warranty 203
 - Webscan 55
- Solution Center 26
- sound pressure 212
- specifications
 - acoustic emissions 212
 - electrical 212
 - media 33
 - network protocols 210
 - operating environment 212
 - physical 208
 - processor and memory 209
 - storage environment 212
 - system requirements 209
- speed
 - troubleshoot for
 - scanner 170
 - troubleshoot print 160
- speed dial
 - buttons 16
 - Digital Filing 53
 - fax numbers, set up 43
 - groups, set up 44
 - network folders 45
 - one-touch buttons 16
 - print and view 46
 - send fax 70
- Start Color Photo button 17
- Start Color Scan button 17
- Start Copy buttons
 - black 17
 - color 17
- Start Fax buttons
 - black 17
 - color 17
- static IP address, setting 158
- status
 - messages 25

- network configuration
 - page 98
 - self-test diagnostic page 97
 - supplies 86, 87
 - status icons 18
 - storage devices
 - connect 61
 - USB flash drives
 - supported 213
 - storage environment
 - specifications 212
 - streaks, troubleshoot
 - copies 169
 - scan 173
 - stripes on scans,
 - troubleshoot 172
 - subscriber identification code 79
 - supplies
 - myPrintMileage 95
 - order online 198
 - self-test diagnostic page 97
 - status 86, 87
 - yields 208
 - support. *See* customer support
 - symbols, enter 28
 - system requirements 209
- T**
- technical information
 - copy specifications 211
 - fax specifications 211
 - memory card
 - specifications 213
 - scan specifications 212
 - telephone customer support 200
 - telephone line, answer ring
 - pattern 80
 - telephone wall jack, fax 175
 - telephone, fax from
 - receive 73
 - send 71
 - temperature specifications 212
 - tests, fax
 - dial tone, failed 178
 - failed 174
 - fax line condition 179
 - fax phone cord type test
 - failed 177
 - hardware, failed 175
 - port connection, failed 176
 - setup 83
 - telephone wall jack 175
 - text
 - cannot be edited after
 - scan, troubleshoot 171
 - enter from control panel 28
 - incompletely filled on
 - copies 169
 - missing from scan,
 - troubleshoot 170
 - plotchy on copies 169
 - troubleshoot 161, 164, 165
 - unclear on copies,
 - troubleshoot 169
 - unclear scans 173
 - tone dialing 81
 - Toolbox (Windows)
 - about 91
 - administrator settings 89
 - Estimated Ink Level tab 92
 - features 86
 - Information tab 92
 - opening 91
 - Services tab 92
 - transparencies 33
 - tray 1
 - capacity 36
 - load media 38
 - locating 13
 - media sizes supported 33
 - media types and weights
 - supported 36
 - tray 2
 - capacity 36
 - installation 21
 - load media 39
 - locating 13
 - media sizes supported 33
 - media types and weights
 - supported 36
 - order online 198
 - troubleshoot installation 165
 - turn on and off in driver 22
 - trays
 - capacities 36
 - clear jams 192
 - installation tray 2 21
 - load media 37
 - locating 13
 - locking 40
 - management tools 87
 - media sizes supported 33
 - media types and weights
 - supported 36
 - paper guides illustration 13
 - setting default 40
 - troubleshoot feeding 166
 - turn on and off in driver 22
 - troubleshoot
 - answering machines 185
 - blank pages printed 160
 - bleeding colors 165
 - colors 164, 165
 - control panel messages 25
 - copy 167
 - copy quality 168
 - cut-off pages, incorrect text
 - or graphics
 - placement 161
 - embedded Web server 187
 - fax 174
 - fax dial tone test failed 178
 - fax hardware test failed 175
 - fax line test failed 179
 - fax phone cord connection
 - test failed 176
 - fax phone cord type test
 - failed 177
 - fax tests 174
 - fax wall jack test, failed 175
 - firewalls 159
 - HP Instant Support 94
 - ink not filling text or
 - graphics 164
 - ink smearing 163
 - installation 188
 - meaningless characters
 - print 163
 - media not picked up from
 - tray 166
 - memory cards 186
 - missing lines or dots 165
 - missing or incorrect
 - information 161
 - multiple pages are
 - picked 166
 - network configuration
 - page 98
 - nothing prints 158
 - paper-feed problems 165
 - power 158
 - print 158
 - print quality 162
 - printheads 159
 - receive faxes 180, 182
 - scan 169
 - scan quality 171
 - self-test diagnostic page 96

- send faxes 180, 182, 184
- skewed copies 169
- skewed pages 166
- slow print 160
- tips 157
- tray 2 installation 165

TWAIN

- scan from 55
- unable to activate
 - source 171

two-line display, control panel 19

Two-sided button 17

two-sided printing 48

two-sided printing accessory.
See duplexer

U

- uninstall software
 - Mac OS 141
 - Windows 140
- USB cable, order 198
- USB connection
 - Bluetooth adapter 135
 - digital cameras 59
 - features available 19
 - port, locating 13, 15
 - setup Mac OS 128
 - setup Windows 125
 - specifications 208
- USB flash drives 213

V

- vertical stripes on copies, troubleshoot 168
- videos
 - print action photos 67
- view
 - blocked fax numbers 78
 - fax log 85
 - network settings 100
 - photos 62
 - speed-dial entries 46
- voice mail
 - set up with fax (parallel phone systems) 110
 - set up with fax and computer modem (parallel phone systems) 122
- voltage specifications 212

W

- wall jack test, fax 175
- warning messages 25
- warranty 203
- Web sites
 - accessibility information 12
 - Apple 129
 - customer support 200
 - environmental programs 228
 - European ink cartridges 199
 - HP Web Jetadmin 94
 - material safety data sheets 229
 - order supplies and accessories 198
 - recycling 229
 - supply yield data sheet 208
 - wireless security 131
- Webscan 55
- white bands or stripes, troubleshoot
 - copies 168, 169
 - scans 172
- WIA (Windows Image Application), scan from 55
- Windows
 - Add Printer installation 128
 - Bluetooth 136
 - borderless printing 42
 - duplexing 48
 - HP Photosmart Software 26
 - HP Solution Center 26
 - install software 125
 - network setup 127
 - print on special or custom-sized media 41
 - print settings 47
 - set up wireless
 - communication 132
 - sharing device 126
 - system requirements 209
 - turn accessories on and off in driver 22
 - uninstall software 140
- Windows Image Application (WIA), scan from 55
- wireless communication
 - Bluetooth 135
 - Ethernet setup 132
 - radio, turn off 100
 - reducing interference 134
 - regulatory information 219

- SecureEasySetup (SES) 133
- security 134
- set up 129
- set up on Mac OS 133
- settings 130
- turn off 134
- wizard 131

wireless connection icons

- ad hoc 18
- no connection exists 18

Wireless Setup Wizard 100

X

- xD-Picture memory card
 - insert 58
 - slot, locating 14, 58

Z

- Zoom in button 17
- Zoom out button 17

© 2007 Hewlett-Packard Development Company, L.P.

www.hp.com

