

Honeywell

RTH8500D Touch Screen Programmable Thermostat

OWNER'S GUIDE

The RTH8500D Thermostat provides electronic control of 24 Vac heating and cooling systems or 750 mV heating systems.



For assistance with your Honeywell product, please visit www.honeywell.com/yourhome or call Honeywell Customer Care toll free at 1-800-468-1502.

Read and Save these Instructions

U.S. Pat. 6,595,430
Other Patents Pending
® U.S. Registered Trademark
© 2004 Honeywell International Inc.
All Rights Reserved



69-1725-1

Contents

Prepare for Installation.....	3
Follow Important Instructions.....	5
Remove Old Thermostat.....	6
Follow Special Instructions.....	7
Label Old Thermostat Wires.....	10
Mount New Wallplate to Wall.....	11
Connect Wires to New Wallplate.....	15
Install Batteries.....	22
Attach New Thermostat to Wallplate.....	23
Set the Calendar.....	24
Configure Installer Setup.....	26
Get to Know Your Thermostat Display.....	38
Set System Setting.....	40
Program Your Heating and Cooling Schedule.....	42
Cancel a Schedule Period.....	46
Set Time.....	47
Set Temperature Overrides.....	48
Clean Your Thermostat Screen.....	51
Use Your Filter Timer.....	52
Understanding Temperature Recovery Feature.....	53
Replace Batteries.....	54
Review Battery Tips.....	57
Built-in Compressor Protection.....	58
Troubleshooting Tips.....	59
Customer Assistance.....	62
Limited One-Year Warranty.....	63

Step 1. Prepare for Installation

1. Check that the following items are included:

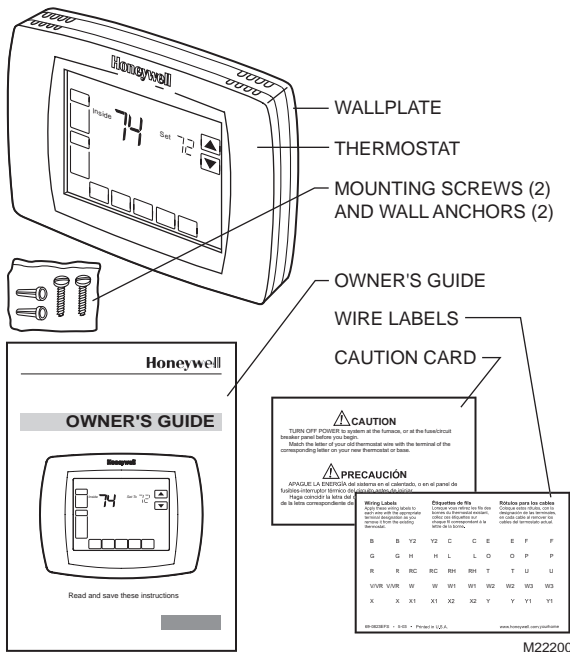

If any of the items shown above are missing, call Honeywell Customer Care at 1-800-468-1502 before returning the thermostat to the store.

Step 1. Prepare for Installation (Cont)

2. Check that you have everything required for the installation:
 - Three AAA alkaline batteries
 - No. 2 Phillips screwdriver and standard pocket screwdriver
 - Drill
 - Drill bit — use 3/16 in. for drywall; use 7/32 in. for plaster
 - Level (optional)
 - Hammer
 - Pencil
 - Electrical tape

Step 2. Follow Important Instructions

1. Do not connect the wires to the new thermostat based on wire color because damage can occur to the heating and/or cooling system.

These Installation Instructions explain later how to use the enclosed wire labels to correctly mark the wires connected to your old thermostat.

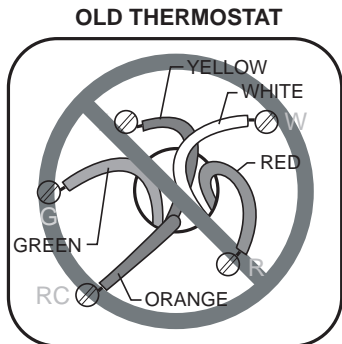

**DO NOT WIRE
NEW THERMOSTAT
BASED ON
WIRE COLOR.**

M22034

Step 3. Remove Old Thermostat

1. Turn off power at the heating and/or cooling system or fuse/circuit breaker panel.
2. Remove the cover from the old thermostat.
3. Remove the old thermostat from the wall or wallplate. Do not remove the wires.

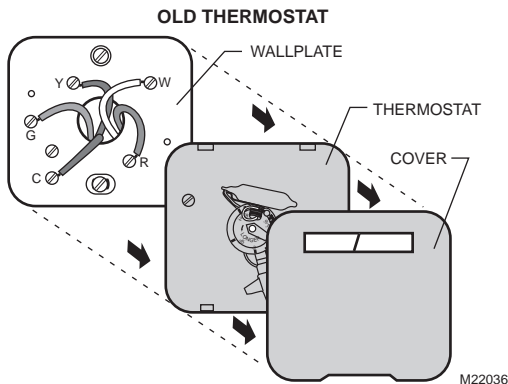

MERCURY NOTICE

If you are replacing a thermostat that contains mercury in a sealed tube, do not place your old thermostat in the trash.

Contact your local waste management authority for instructions regarding recycling and the proper disposal of an old thermostat containing mercury in a sealed tube.

Step 4. Follow Special Instructions

1. If you have **two** C and/or C1 wires connected to your old thermostat, do not connect them to your new thermostat.
2. Disconnect the C and/or C1 wires. Make sure they do not touch each other or any other wires.
3. Wrap the bare end of each C and/or C1 wire with electrical tape.

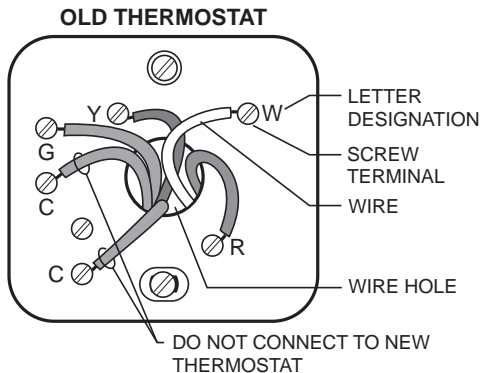

M22201

Step 4. Follow Special Instructions (Cont)

- If you have only **one** C and/or C1 wire connected to your old thermostat, connect this wire to C on the new thermostat.

Visit www.honeywell.com/yourhome or call Honeywell Customer Care at 1-800-468-1502 before returning the thermostat to the store.

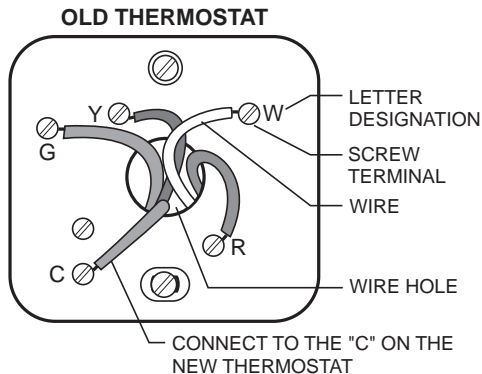

M22223

Step 4. Follow Special Instructions (Cont)

5. If you find any wires not connected to your old thermostat, do not connect them to your new thermostat.
6. Wrap the end of the wires that are not connected with electrical tape.

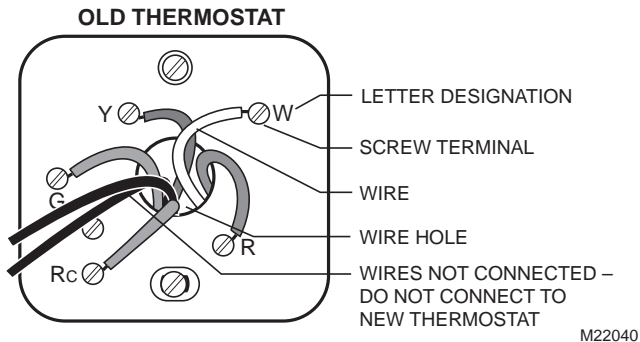

Step 5. Label Old Thermostat Wires

1. As you disconnect each wire, use the enclosed wire labels to wrap a wire label around each wire that matches the letter designation. Do not allow the wires to fall into the wall opening after the wires are disconnected.
2. Remove any remaining part of the old thermostat from the wall.

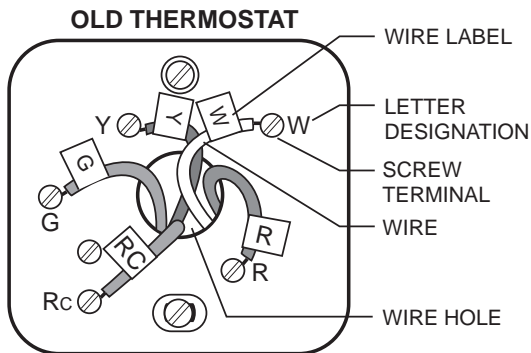

M22039



When connecting the wires to the new thermostat, refer to the wire labels. Do not connect wires to your new thermostat based on the color of the wire.

Step 6. Mount New Wallplate to Wall

1. Separate the wallplate from the thermostat as shown.

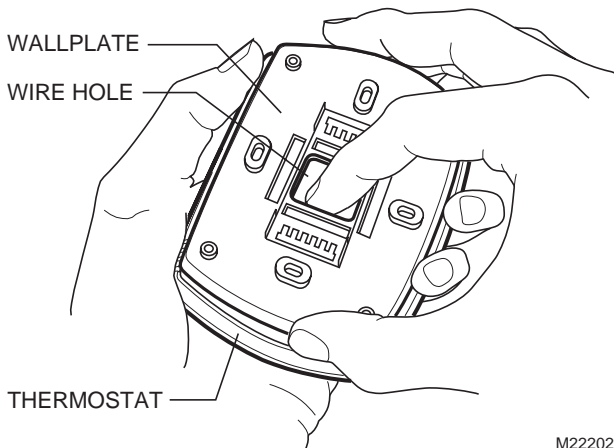

M22202

Step 6. Mount New Wallplate to Wall (Cont)

2. Pass the labeled wires through the wire hole on the wallplate.

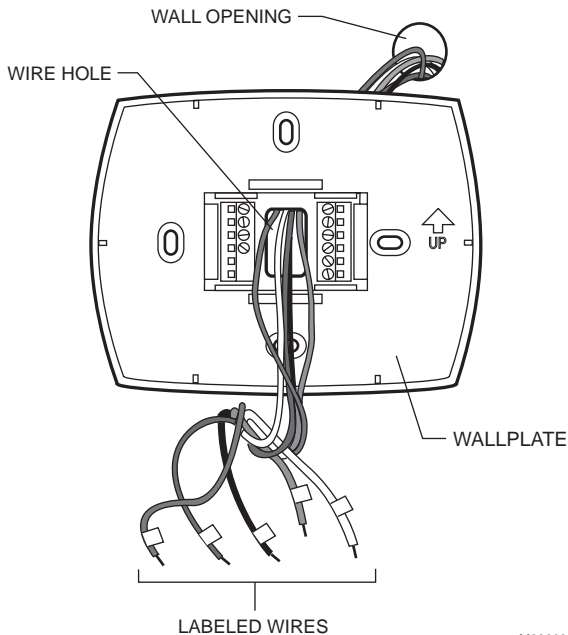

M22203

Step 6. Mount New Wallplate to Wall (Cont)

3. Position the wallplate on the wall with the arrow pointing up. Level the wallplate (for appearance only) and mark the two mounting holes with a pencil.

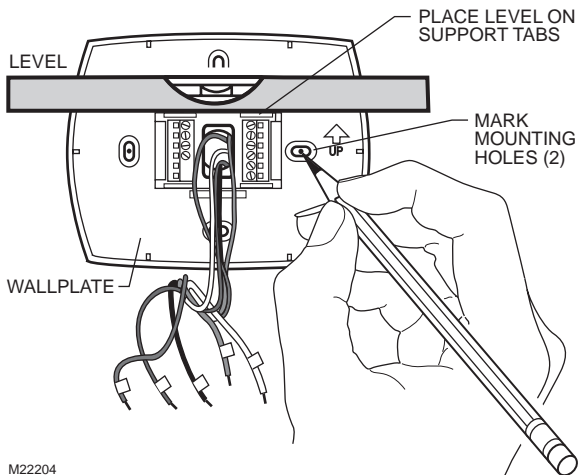

M22204

Step 6. Mount New Wallplate to Wall (Cont)

4. Move the wallplate aside and drill holes at the locations marked on the wall. Drill 3/16 in. holes for drywall or 7/32 in. holes for plaster.
5. Tap the wall anchors into the drilled holes until even with the wall surface.

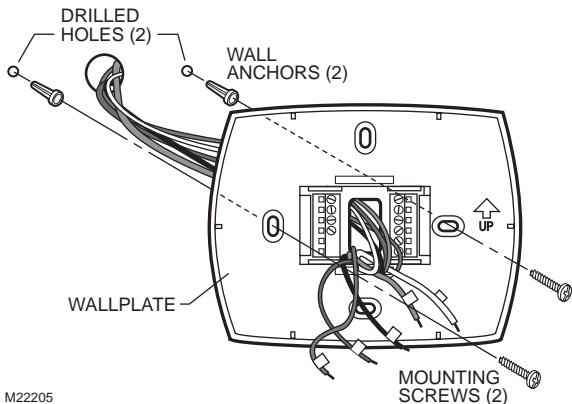

6. Position the wallplate over the wall anchors.
7. Insert the mounting screws into the wall anchors. Check leveling, if desired, and tighten the mounting screws.

Step 7. Connect Wires to New Wallplate

1. Match the labeled wires to the letter designations on the wallplate.
2. Select the correct letter designations to follow for your system. If you have a standard heating and/or cooling system, use the **CONVENTIONAL** letter designations. If you have a heat pump system, use the **HEAT PUMP** letter designations to wire the new thermostat.

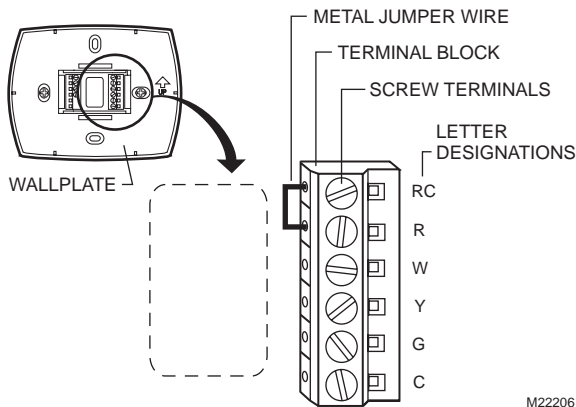

M22206

3. If wires are to be connected to both Rc and R, loosen the Rc and R screw terminals and remove the metal jumper wire.
4. If only one of the terminals, Rc or R, is to be connected, leave the metal jumper wire in place.



See table on page 29 to help you determine if you have a **CONVENTIONAL** or **HEAT PUMP** system.

Step 7. Connect Wires to New Wallplate (Cont)

- Loosen the screw terminals. Insert the labeled wires into the holes on the side of the terminal block that match the letter designations. Tighten the screw terminals.
- If any of the labeled wires do not match the letter designations, see next page for wire connections.

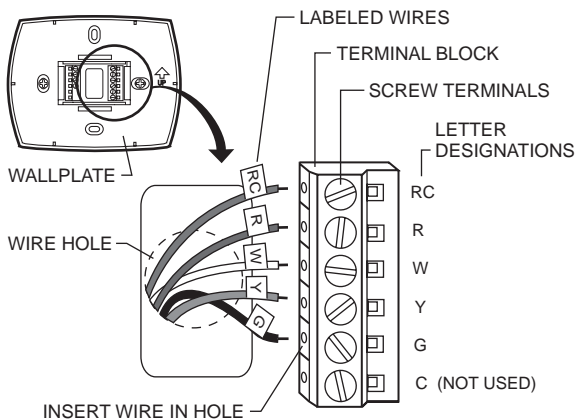

M22207

Step 7. Connect Wires to New Wallplate (Cont)

7. Compare letter designations on your old and new thermostats. Use the information below if you are wiring a **CONVENTIONAL** System. Use the information on page 20 if you are wiring a Heat Pump System.

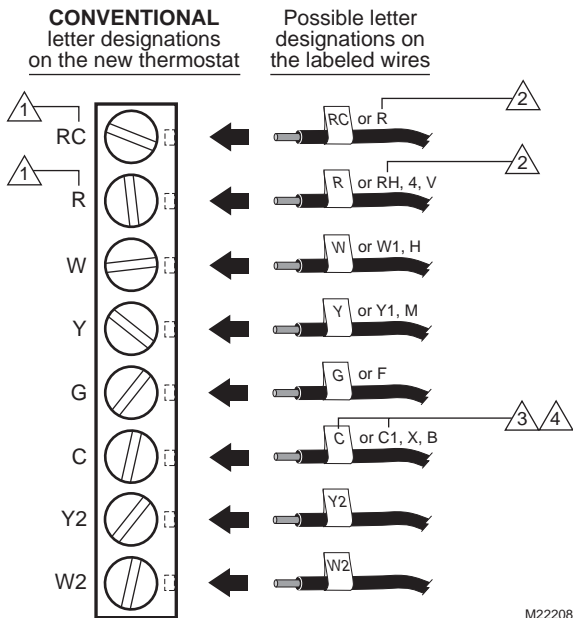

M22208



Do not connect more than one wire to each terminal. Be sure to read the notes referenced in the numbered triangles above. These numbered notes appear on the next page.

Step 7. Connect Wires to New Wallplate (Cont)

NOTES FOR CONVENTIONAL HEATING AND COOLING SYSTEMS

- 1 If wires will be connected to both RC and R on the new thermostat, remove metal jumper wire between RC and R. Leave metal jumper wire in place if only one of the terminals, RC or R, will be connected on the new thermostat.
- 2 If wires were connected to both R and RH terminals on the old thermostat, remove metal jumper wire between RC and R on the new thermostat. Connect the old R to the new RC and the old RH to the new R.
- 3 If **two** C and/or C1 wires were connected to the old thermostat, do not connect them to the new thermostat. Wrap the bare end of each wire separately with electrical tape and do not use.
- 4 If **one** C and/or C1 wire was connected to the old thermostat, the wire should be connected to the "C" letter designation on the new thermostat.

M22246

Step 7. Connect Wires to New Wallplate (Cont)

8. Compare letter designations on your old and new thermostats. Use the information below if you are wiring a **HEAT PUMP** System.

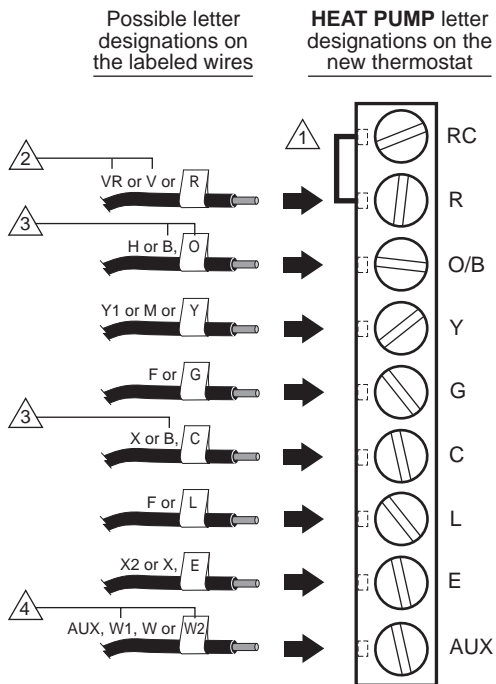

M22210



Be sure to read the note referenced in the numbered triangles above. These numbered notes appear on the next page.

Step 7. Connect Wires to New Wallplate (Cont)

NOTES FOR HEAT PUMP SYSTEMS

- 1 Leave metal jumper wire between RC and R in place.
- 2 If the old thermostat had separate wires on both the V and VR, some system modification is required. Call your local heating and cooling contractor for assistance.
- 3 If the old thermostat had wires on both O and B, be sure to attach the B wire to the C letter designation on the new thermostat. If another wire is already matched to the C, contact Honeywell.
- 4 If the old thermostat had wires on W1, Y1 and W2, some system modification is required. Call your local heating and cooling contractor for assistance.

M22245

Step 7. Connect Wires to New Wallplate (Cont)

9. Push excess wire back into the wall opening. Keep wires in the shaded area.

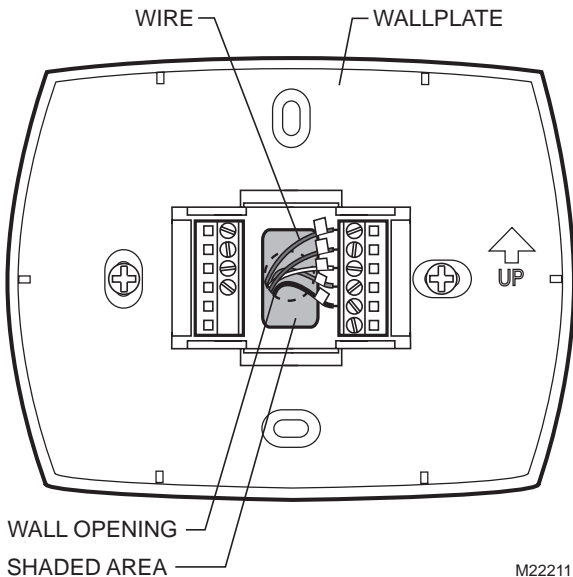

M22211

Step 8. Install Batteries

1. Install three fresh AAA alkaline batteries on the back of the thermostat as marked on the thermostat.

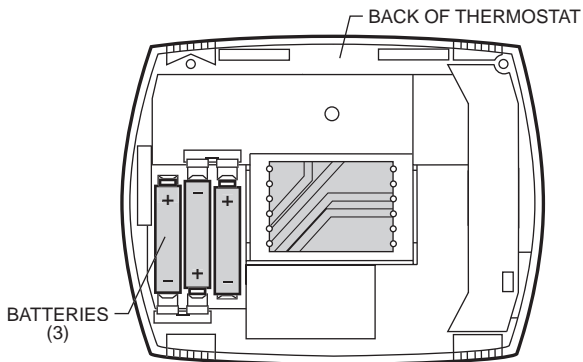

M22212

2. Remove the tab labeled "Remove during installation" in the lower right corner of the thermostat back.

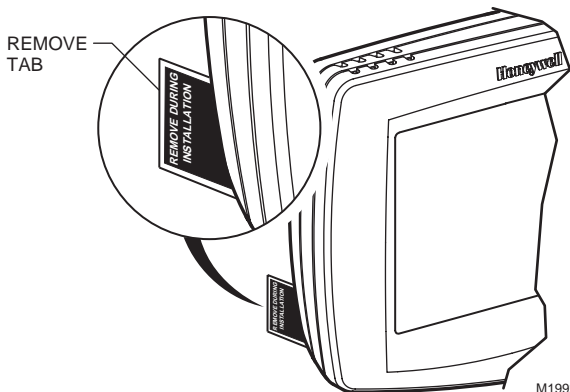

M19920

Step 9. Attach New Thermostat to Wallplate

1. Align the screw blocks with the pins on the back of the thermostat.

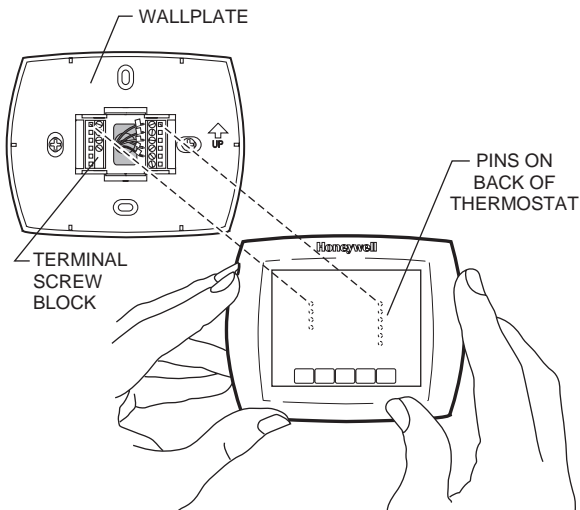

M22213

2. Push the thermostat straight onto the wallplate until it snaps into place.
3. Turn on the power at the heating and/or cooling system or fuse/circuit breaker panel.



If the wires interfere with mounting the thermostat to the wallplate, push the excess wire back into the wall opening.

Step 10. Set the Calendar

This thermostat is designed to automatically keep current time and day in memory for up to ten years, under normal use, once the calendar is set. When the thermostat is first powered, the display is ready to set the calendar.

1. Use the arrow keys to set the year, month and day.
2. Press the Done key.

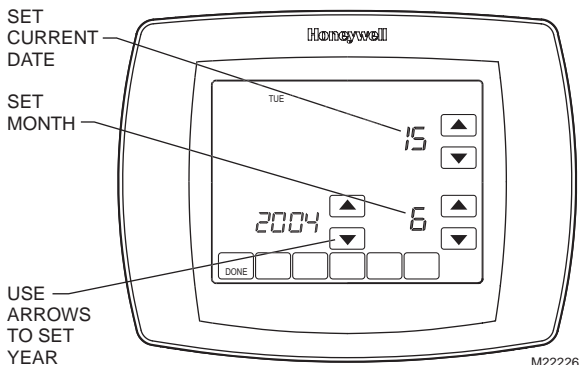

The calendar can be set any time. See Step 11, Configure Installer Setup, for instructions.

Step 10. Set the Calendar (Cont)

3. Use the arrow keys to set the current time.
4. Press the Done key.

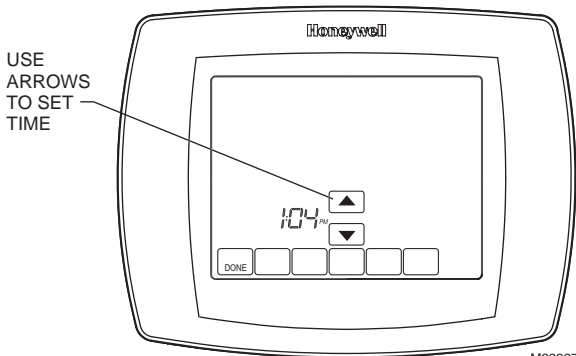

Step 11. Configure Installer Setup

1. Use the Installer Setup Menu to match your new thermostat to your heating and/or cooling system. Follow the steps in this section to set up your thermostat.
2. Press and release the System key.

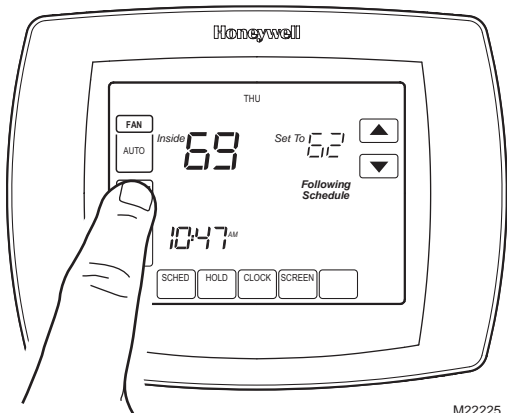

M22225

Step 11. Configure Installer Setup (Cont)

3. Press and hold the center blank key for approximately five seconds, until the screen changes.

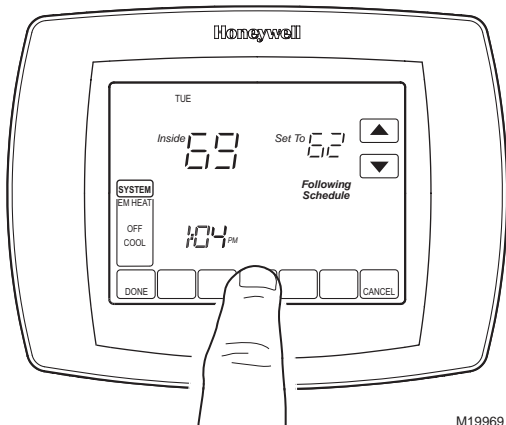

M19969

4. Release the center key when the display on your thermostat matches the display below.

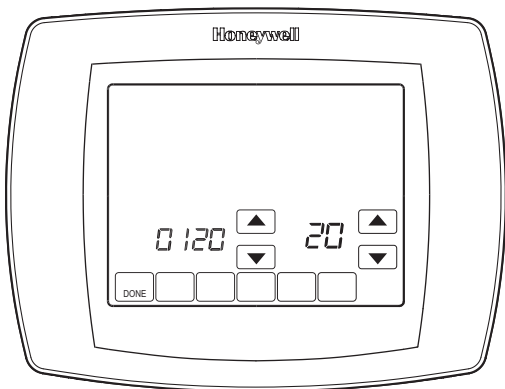

M22214

11. Configure Installer Setup (Cont)

- Press the Up or Down arrows to the right of the two-digit number in the lower right corner of the screen to select your setting for Installer Setup Number 0120 below.
- After you select your setting, press the Up arrow key to the right of 0120 to go to the next Installer Setup Number.
- Follow steps 5 and 6 to set Installer Setup Numbers 0130, 0140 and 0150 to complete setting the calendar.

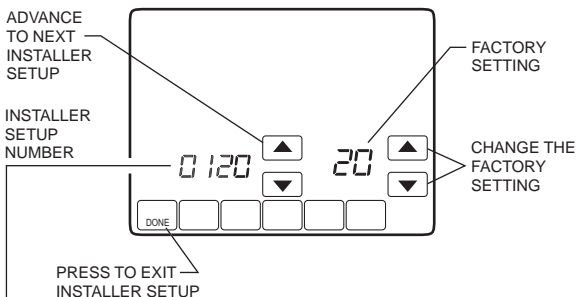

Installer Setup Number	Installer Setup Name	(Select Your Setting) Settings
0120	Date (Year Upper)	Select first two digits of current calendar year (20 for year 2005, etc).
0130	Date (Year Lower)	Select last two digits of current calendar year (05 for year 2005, etc).
0140	Date (Month)	Select number that represents current calendar month.
0150	Date (Day)	Select number that represents current calendar date.

M22215

Step 11. Configure Installer Setup (Cont)

- Press the Up or Down arrows to select your setting for Installer Setup Number 0170.
- After you select your setting, press the Up arrow to go to the next Installer Setup Number.

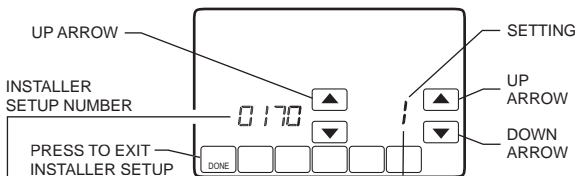

Installer Setup Number	Installer Setup Name	(Select Your Setting) Settings
0170	System Type Selection	<ol style="list-style-type: none"> 1 - Heating and Cooling (Conventional) -- Gas, oil or electric heating with central air conditioning. 2 - Single-stage Heat Pump with no back-up or auxiliary heat -- the compressor runs in both heating and cooling. 3 - Heat Only with no fan (Conventional) -- Gas, oil or electric heating without central air conditioning. No wire on the G terminal on new thermostat. 4 - Heat Only with fan (Conventional) -- Gas, oil or electric heating without central air conditioning. Typically wires are R, W and G on new thermostat. 5 - Hot Water Heat Only (Conventional) -- Gas or Oil hot water heat with three wires connected to new thermostat or for normally open hot water valves with wires connected to R and Y on new thermostat. 6 - Cool Only (Conventional) -- Central air conditioning only. 7 - Multistage Heat Pumps -- heat pump with auxiliary or back-up heat. 8 - Multistage Conventional Heating and Cooling -- 2 stages of Heat (wires on W and W2) and 2 stages of Cool (wires on Y and Y2). 9 - Multistage Conventional Heating and Cooling -- 2 stages of heat (wires on W and W2) and 1 stage of Cool (wire on Y). 10 - Multistage Conventional Heating and Cooling -- 1 stage of heat (wire on W) and 2 stages of Cool (wires on Y and Y2).

M22216

Step 11. Configure Installer Setup (Cont)

10. If you do not have a number 0180 on the left side of your display, go to the next page.
11. If you have a number 0180 on the left side of your display, press the Up or Down arrow to select your setting for Installer Setup Number 0180.
12. After you select your setting, press the Up arrow key to go to the next Installer Setup Number.

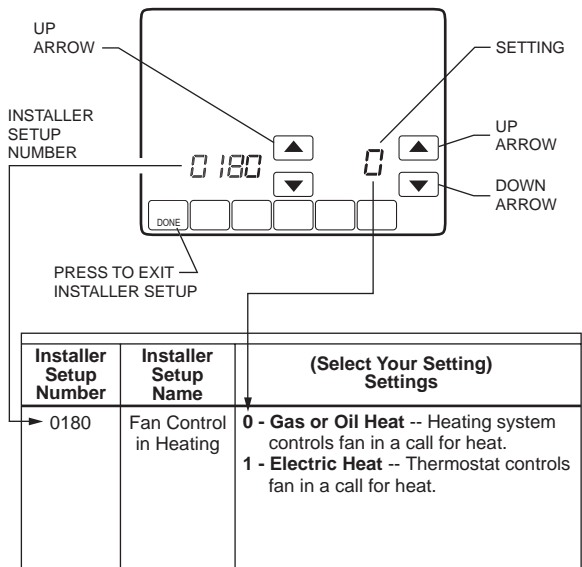

M22217

Step 11. Configure Installer Setup (Cont)

- If you do not have a number 0190 on the left side of your display, go to the next page.
- If you have a number 0190 on the left side of your display, press the Up or Down arrow to select your setting for Installer Setup Number 0190.
- After you select your setting, press the Up arrow key to go to the next Installer Setup Number.

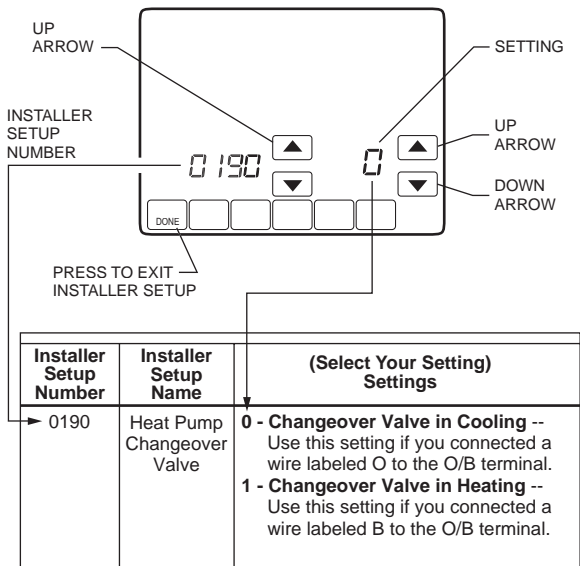

M22228

Step 11. Configure Installer Setup (Cont)

16. If you do not have a number 0240 on the left side of your display, go to the next page.
17. If you have a number 0240 on the left side of your display, press the Up or Down arrow to select your setting for Installer Setup Number 0240.
18. After you select your setting, press the Up arrow key to go to the next Installer Setup Number.

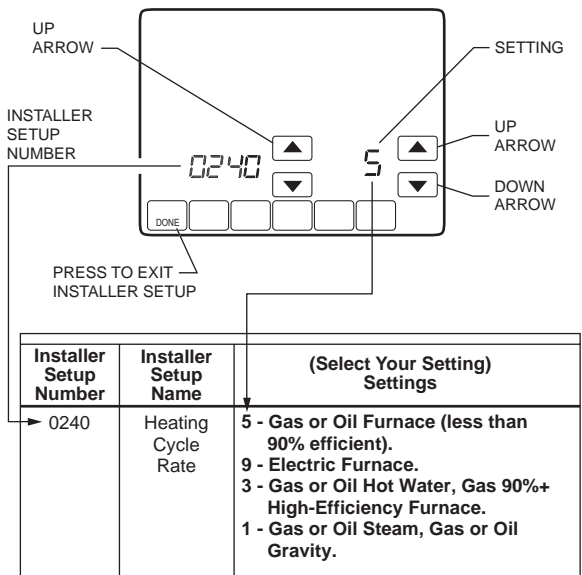

M22342

Step 11. Configure Installer Setup (Cont)

- Press the Up or Down arrow to select your setting for Installer Setup Number 0320.
- After you select your setting, press the Up arrow to go to the next Installer Setup Number.

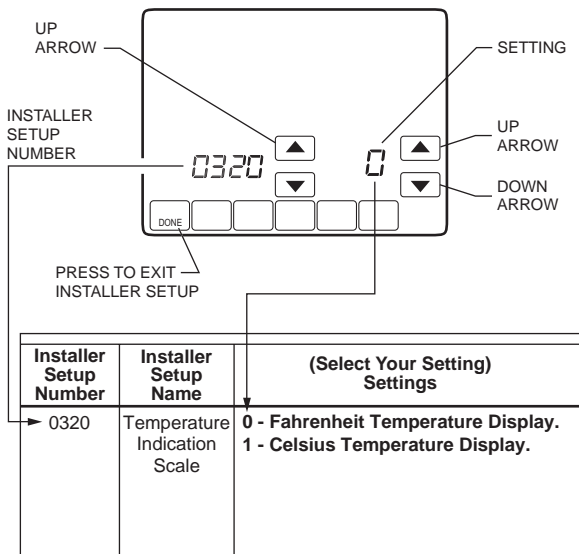

M22218

Step 11. Configure Installer Setup (Cont)

21. Press the Up or Down arrow to select your setting for Installer Setup Number 0330.
22. After you select your setting, press the Up arrow to go to the next Installer Setup Number.

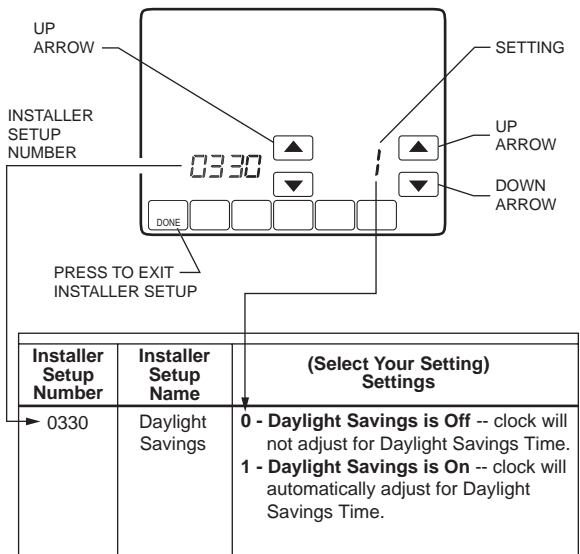

M22219

Step 11. Configure Installer Setup (Cont)

23. Press the Up or Down arrow to select your setting for Installer Setup Number 0500.
24. After you select your setting, press the Up arrow to go to the next Installer Setup Number.

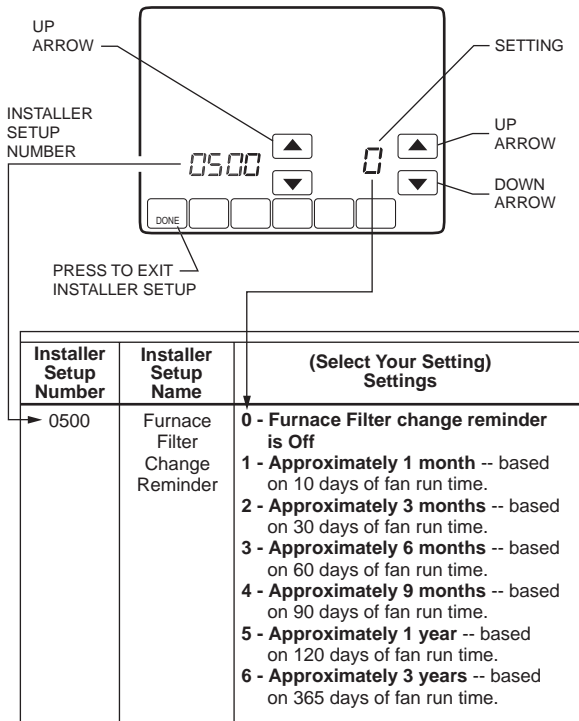

M22220

Step 11. Configure Installer Setup (Cont)

25. Press the Up or Down arrow to select your setting for Installer Setup Number 0530.
26. After you select your setting, press the Up arrow to go to the next Installer Setup Number.

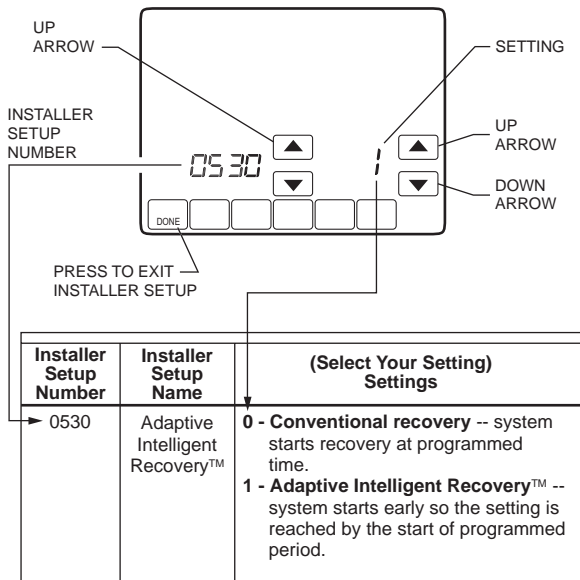

M22221

Step 11. Configure Installer Setup (Cont)

27. Press the Up or Down arrow to select your setting for Installer Setup Number 0640.
28. After you select your setting, press the Done key to exit the Installer Setup and save your settings.
29. Congratulations! The installation of the thermostat is complete.

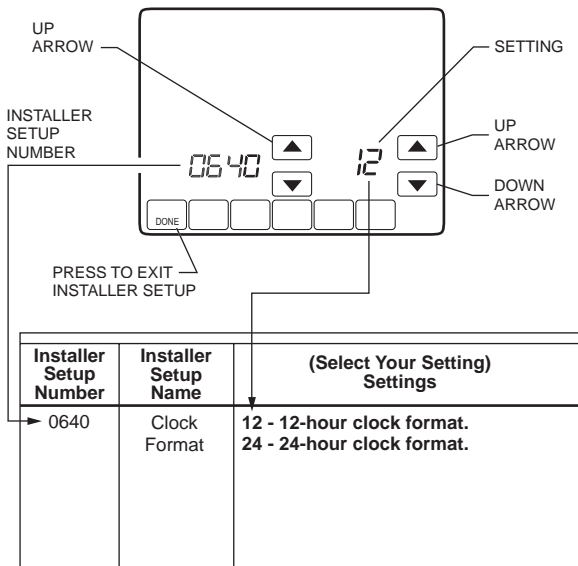

M22222

Get to Know Your Thermostat Display

Thermostat

SYSTEM

SELECTS EM.
HEAT/HEAT/OFF/COOL

FAN

SELECTS
ON/AUTO

DOWN ARROW

LOWERS TEMPERATURE
SETTING

UP ARROW

RAISES
TEMPERATURE
SETTING

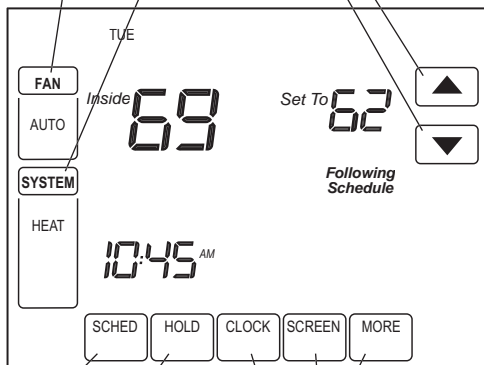

SCHED

ENTERS
SCHEDULING
MODE

CLOCK

SETS THE
TIME
FORWARD
OR BACK

MORE

SHOWS FURNACE
FILTER CHANGE
REMINDER

HOLD

SETS A PERMANENT
HOLD AND ACTIVITIES
VACATION HOLD

SCREEN

LOCKS OUT THE
SCREEN TO ALLOW
FOR CLEANING

M22238

Get to Know Your Thermostat Display (Cont)

Display

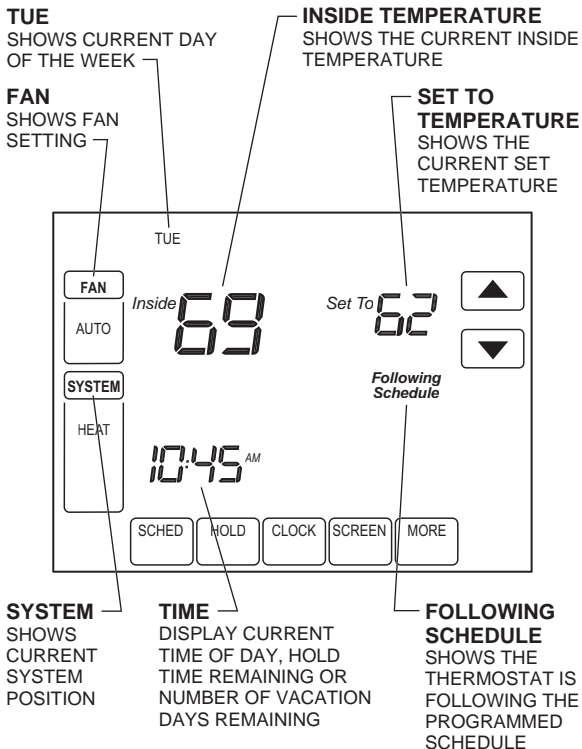

M22239

Set System Setting

Set System Setting

Press the System button to select Heat, Off or Cool:

Heat—Thermostat controls the heating system.

Off—Both the heating and cooling systems are off.

Cool—Thermostat controls the cooling system.

Em. Heat (Heat Pump Systems with Auxiliary Heat)—Thermostat controls emergency heat and auxiliary heat, if needed. Heat Pump compressor is not operational.



CAUTION

Equipment Damage Hazard.

Air conditioning compressor damage possible.

Do not operate cooling system when outdoor temperature is below 50 °F (10 °C).

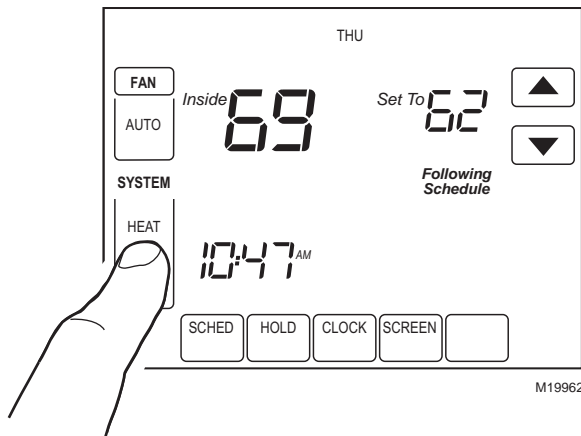

Set System Setting (Cont)

Set Fan Setting

Press the Fan button to select Auto or On:

Auto—Normal setting for most homes. The fan runs only when the heating or cooling system is on.

On—The fan runs continuously. Use this setting for improved air circulation or for more efficient air cleaning.

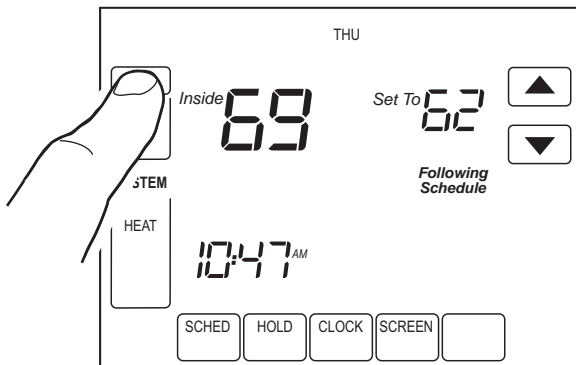

M22262

Program Your Heating and Cooling Schedule

Your thermostat can control up to four different schedule periods per day:

Wake—Period when you awaken and want your home at a comfortable temperature.

Leave—Period when you are away from home and want an energy-saving temperature.

Return—Period when you return home and want your home back to a comfortable temperature.

Sleep—Period when you are asleep and want an energy-saving temperature.

Edit Schedule

1. Press Sched key.

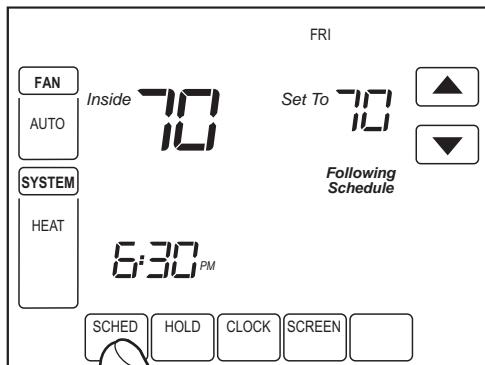

M22445

Program Your Heating and Cooling Schedule (Cont)

2. Press Edit key.

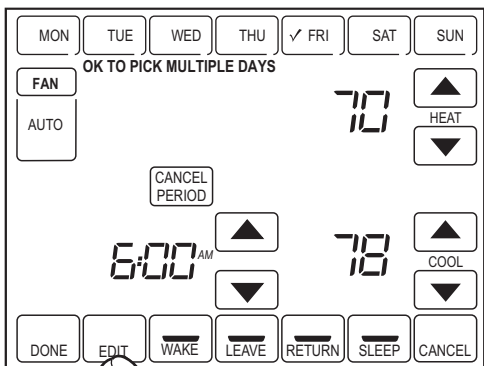

M22553

Program Your Heating and Cooling Schedule (Cont)

3. It is *OK to pick multiple days*. Select any combination of days to edit. These days are scheduled with the same times and temperatures. Check marks appear next to days selected.

✓ MON	✓ TUE	✓ WED	✓ THU	✓ FRI	SAT	SUN
OK TO PICK MULTIPLE DAYS						
FAN				70	▲	HEAT
AUTO					▼	
		CANCEL PERIOD				
			▲	78	▲	COOL
			▼		▼	
DONE		WAKE	LEAVE	RETURN	SLEEP	CANCEL

M22300

4. Press Wake key. Once pressed, Wake flashes to show it is selected.
5. Press Up and Down keys to modify time and heat and cool temperatures from this screen.
6. Press Leave key and repeat step 5.
7. Press Return key and repeat step 5.
8. Press Sleep key and repeat step 5.

Program Your Heating and Cooling Schedule (Cont)

9. When complete, press Done key. “Saving Changes” appears on the screen to indicate changes are being saved to the day(s) modified.

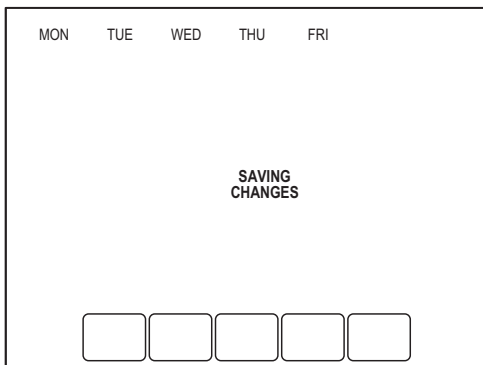

M19956

10. To set a Program Schedule for the remaining days of the week, repeat steps 1-9. Example: If Mon-Fri was selected first, go back and repeat steps 1-9 for Sat and Sun.



To exit schedule without saving changes, press Cancel key any time.

Cancel a Schedule Period

NOTE: You may want to cancel a period to match your lifestyle; for example, if someone is always home during the day on Tuesday, you can cancel the Leave and Return periods (the thermostat would then control to the Wake temperature until the Sleep period).

1. Press Sched key.
2. Press Edit key.
3. Select the Day(s) of the week desired.
4. Press schedule period you want to cancel (Wake, Leave, Return or Sleep). Once selected, the period flashes.
5. Press Cancel Period key. The time, temperature(s) and fan setting disappear. The bar above the selected period is removed, indicating the scheduled period was cancelled.

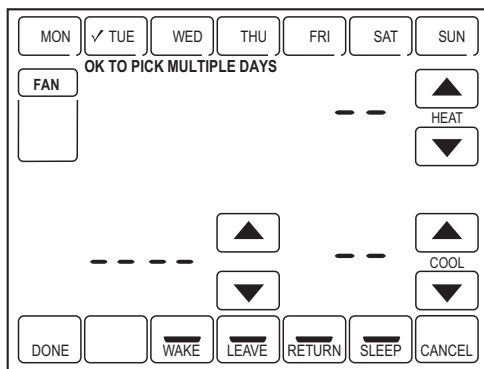

M19957

6. Press Done key.



To reinstate a schedule period, press arrow keys to set desired time and temperatures.

Set Time

Set Time

1. Press Clock.
2. Use the arrows to set the current time.

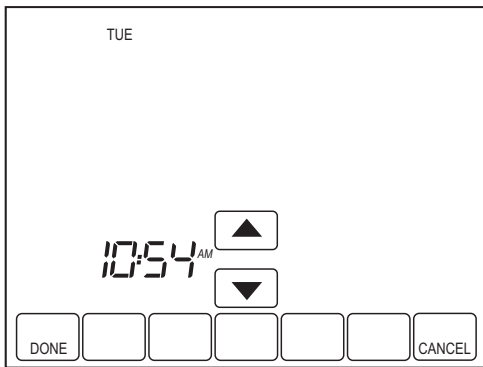

M19958

3. Press the Done key.



The current day of the week should already be set correctly. If not, see Step 11, Configure Installer Setup.

Set Temperature Overrides

Hold Temperature Until (Temporary Hold)

Hold temperature temporarily until the next scheduled period time or until the time the user sets.

1. Press the Up or Down arrow next to the temperature you want to adjust. "Hold Temperature Until" time appears on the screen. The Hold Temperature Until time defaults to the start time of the next scheduled period.
2. Press the Up or Down arrow next to the Time key to set the desired time for the thermostat to resume the schedule.

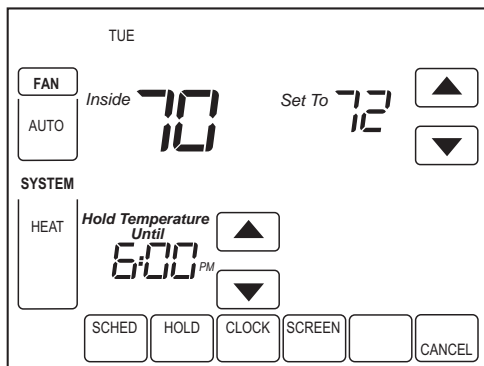

M19959

3. Press the Cancel or Sched key to cancel "Hold Temperature Until" and resume schedule. "Following Schedule" appears on the screen to indicate that the "Temporary Hold" has ended.



The Time Up and Down arrows are shown for approximately seven seconds. Pressing on the screen time (where the Hold Temperature Until time is shown) allows the arrows to reappear.

Set Temperature Overrides (Cont)

Permanent Hold

Permanent Hold changes the temperature setting until Permanent Hold is cancelled.

1. Press the Hold key. “Permanent Hold” appears on the screen.
2. Press the Up or Down arrow next to the temperature you want to set during “Hold.”

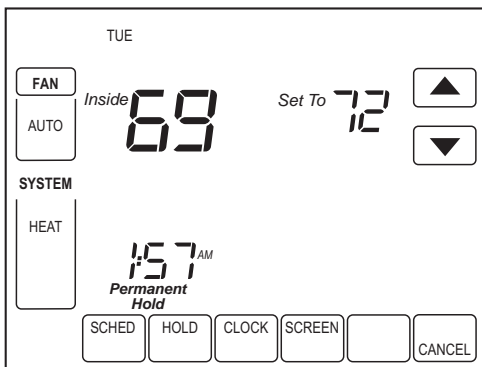

M19960

3. Press the Cancel key to cancel “Permanent Hold” and resume the schedule.



The screen shows Permanent Hold until it is cancelled.

Set Temperature Overrides (Cont)

Vacation Hold

Changes temperature setting for a designated number of days.

1. Press the Up and Down arrow keys to set the desired temperature while away on vacation. Notice that “Hold Temperature Until” time is shown on the screen. (This is the time the Vacation Hold override expires after the number of days you selected ends.)
2. Press the Hold key twice. Screen shows “Hold Temperature Until” 1 day.
3. Press the Up and Down arrow keys to change the number of Days you desire the thermostat to override the schedule.

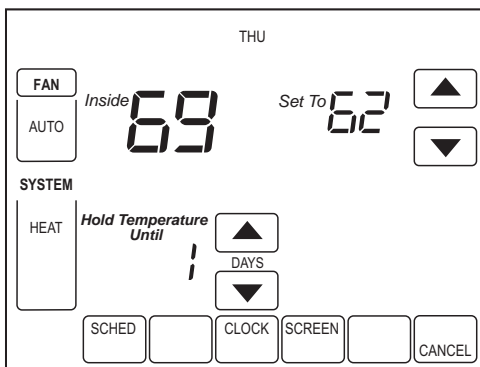

M19961

4. To cancel Vacation Hold override early, press the Cancel key.



When the number of days of Vacation Hold expires, the screen shows “Following Schedule” to indicate that Vacation Hold has ended.

Clean Your Thermostat Screen

1. Press the Screen key. The thermostat locks out all touch keys for 30 seconds to allow for cleaning.

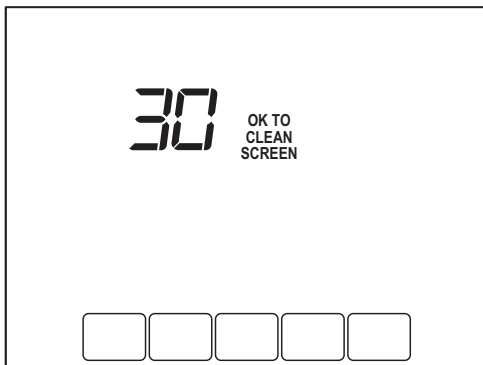

M19964

2. Use a damp cloth slightly moistened with water or household glass cleaner to clean the screen.
3. Repeat the above steps, as necessary.
4. Press the Done key to return to the Home Screen and normal operation.



Tip

Do not spray any type of liquid directly onto the thermostat itself. If using household glass cleaner, spray the cleaner on a cloth. Then use the cloth to clean the thermostat screen.

Use Your Filter Timer

The Filter Timer notifies you when to change your furnace filter.

Reset Filter Timer

1. “Change Filter” appears on the screen when the filter timer expires.
2. Press the Reset key to restart the filter timer.

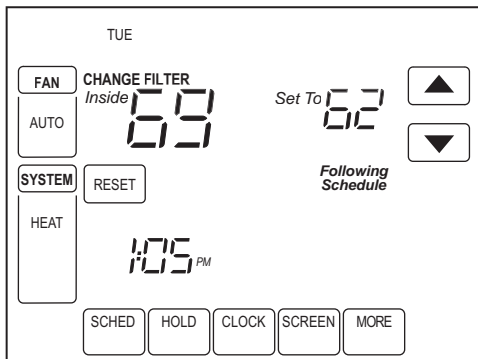

M19975

View or Reset Timer Settings Before They Expire

1. Press the More key until the Filter Timer appears on the screen.
2. Press the Edit key to change the Timer reload value. Use the Up or Down arrow keys to change the number of run Time Days. See Configure Installer Setup Number 0500, for approximate calendar days.
3. Press the Done key to go back to viewing the filter timer.
4. Press the Reset key to reset the timer to the timer reload value. (This is the setting you set in the Installer Setup or the new reload value you selected in step 2.)
5. Press the Done key.

Understanding Temperature Recovery Feature

Your thermostat comes with a feature called Adaptive Intelligent Recovery™, which eliminates all guesswork when setting your schedule. How long does it take the furnace to warm your house in the morning before you get out of bed or how long does it take the air conditioner to cool your house in the afternoon before you return from work? No problem. The thermostat determines that for you.

Simply set your program schedule to the time you want the house to be at your comfort temperature. The thermostat then turns on the heating or cooling at just the right time to have your home reach your scheduled temperature at your scheduled time.

For example—you get out of bed at 6:00 AM and want the temperature to be 70°F. Set the Wake period for 6:00 AM and 70°F. The thermostat then turns on the heat before 6:00 AM to raise the temperature to 70°F by 6:00 AM.

The thermostat alerts that the heating or cooling system is coming on before a scheduled time when “Recovery” shows on the screen.

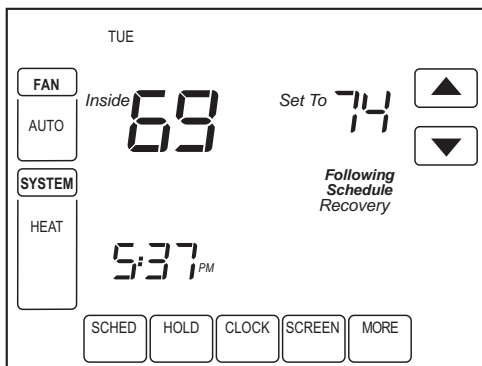

M22301



Tip

It takes about a week for the thermostat to adjust to local weather, your schedule, the construction of your home and your heating and/or cooling system. Each day it adjusts the next day's recovery start time accordingly.

Replace Batteries

1. When the LO Battery indicator is flashing, replace the batteries promptly with three fresh AAA alkaline batteries

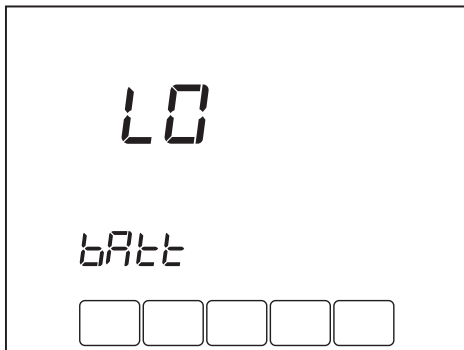

M19963

2. Remove thermostat from the wallplate by pulling straight out.

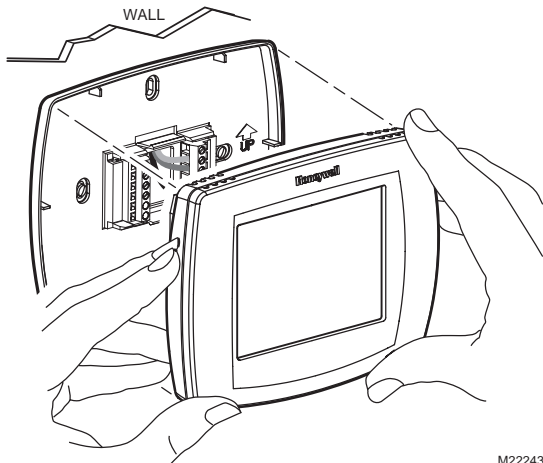

M22243

Replace Batteries (Cont)

3. Remove the old batteries and insert three fresh AAA alkaline batteries, as marked on the thermostat.

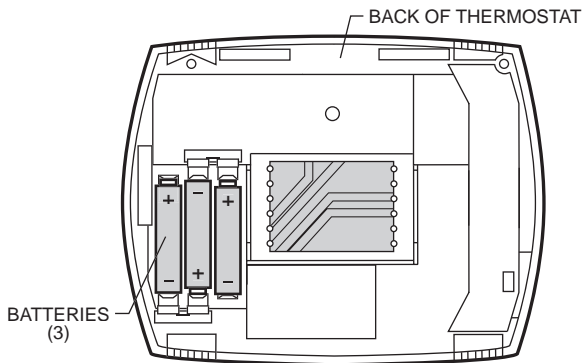

M22212

Replace Batteries (Cont)

4. Align the screw blocks with the pins on the back of the thermostat.

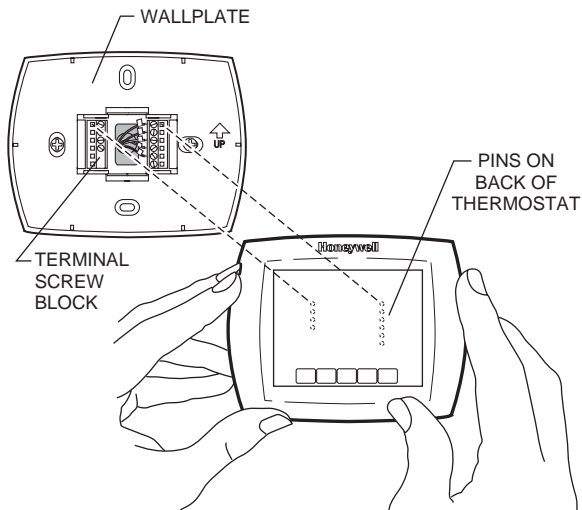

M22213

5. Push the thermostat straight onto the wallplate until it snaps into place.

Review Battery Tips

1. Replace the batteries as soon as LO Batt flashes in the display. The LO Battery indicator flashes in the display one month before the batteries run down completely.
2. Always use fresh AAA alkaline batteries. Non-alkaline batteries do not last as long and can leak, causing thermostat damage.
3. Although the thermostat has a Low Battery indicator, replace the batteries once a year to prevent the thermostat and heating/cooling system from shutting down due to lack of battery power.
4. As a precaution, replace the batteries when leaving your home for more than a month to prevent your heating/cooling system from shutting down if the batteries run down completely.

Built-in Compressor Protection

The RTH8500D Thermostat has built-in compressor protection (minimum-off timer) that prevents the compressor from restarting too early after a shutdown.

The minimum-off timer is activated after the compressor turns off.

If there is a call during the minimum-off timer, the thermostat shows “Wait” in the display.

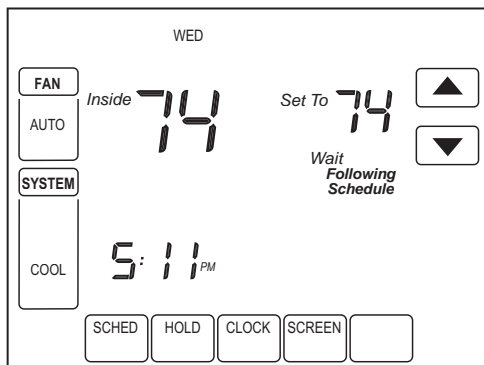

M22244

When the minimum-off timer expires, “Cool On” or “Heat On”^a appears solidly in the display and the compressor and fan turn on.

^aHeat Pumps only.

Troubleshooting Tips

If . . .	Then . . .
Key to the right of the Screen key is blank.	Verify that this key remains blank unless you set the Furnace Filter Change Reminder. See Installer Setup Number 0500 in Step 11.
Display is blank.	Check that fresh AAA alkaline batteries are installed as marked on the thermostat.
Temperature settings do not change.	Check that the temperature settings are: <ul style="list-style-type: none"> • Heating 40°F to 90°F (4.5°C to 32°C). • Cooling 50°F to 99°F (10°C to 37°C).
Heating system does not turn on.	<ul style="list-style-type: none"> • Set the system to Heat by pressing the System key. • Check the heat temperature setting to be sure it is set above the room temperature and “Heat On” shows solidly in the display. • Check the circuit breaker to be sure it is not tripped. • Check power switch at heating and/or cooling system to be sure it is on. • Check the furnace door to be sure it is closed securely. • Wait five minutes for the heating system to respond. • If all of this was checked, contact your local heating and cooling contractor.
Cooling system does not turn on.	<ul style="list-style-type: none"> • Set the system to Cool by pressing the System key. • Check the cool temperature setting to be sure it is set below the room temperature and “Cool On” shows solidly in the display. • Check the circuit breaker to be sure it is not tripped. • Check the power switch at the heating and/or cooling system to be sure it is on. • Check the furnace door to be sure it is closed securely. • Wait five minutes for the cooling system to respond. • If all of this was checked, contact your local heating and cooling contractor.

Troubleshooting Tips (Continued)

If . . .	Then . . .
Cannot set System setting to Cool.	Check Installer Setup Number 0170, Heating and/or Cooling System Type; make sure the setting matches the installed heating and/or cooling system.
“Heat On” is not shown in the display.	Set the System setting to Heat and set the temperature setting above the room temperature. If “Heat On” is shown solidly in the display, but the heating system does not turn on, see “Heating system does not turn on” in the Troubleshooting Tips.
“Cool On” is not shown in the display.	Set the System setting to Cool and set the temperature setting below the room temperature. If “Cool On” is shown solidly in the display, but the cooling system does not turn on, see “Cooling system does not turn on” in the Troubleshooting Tips.
“Wait” shows in the display.	Compressor minimum-off timer is active. Wait up to five minutes for the cooling or heating system to turn on.
Fan does not turn on in a call for heat (electric furnaces only).	Check Installer Setup Number 0180, Fan Control in Heating, and make sure it is set to Electric Heat.
Heat pump puts out cool air in the heat mode and warm air in the cool mode (heat pumps only).	Check Installer Setup Number 0190, Heat Pump Changeover Valve, and make sure the setting matches the changeover required by the installed heat pump.
Both the heating and cooling systems are running at the same time.	Check Installer Setup Number 0170, Heating and/or Cooling System Type, and make sure the setting matches the installed heating and/or cooling system.
	Check and make sure the bare portions of the wires are not touching.

Troubleshooting Tips (Continued)

If . . .	Then . . .
Heating system is running in cool mode.	Check Installer Setup Number 0170, Heating and/or Cooling System Type, and make sure the setting matches the installed heating and/or cooling system.
Heating system does not turn off and the heat temperature setting is set below the room temperature ("Heat On" is not shown in display).	Check Installer Setup Number 0170, Heating and/or Cooling System Type, and make sure the setting matches the installed heating and/or cooling system.
Red LED is on in the upper right corner and the Heat Pump is not working.	A system monitor is wired to the thermostat L terminal. See Heating or Cooling system does not turn on in the Troubleshooting Tips.

Customer Assistance

For assistance with your Honeywell product, please visit www.honeywell.com/yourhome or call Honeywell Customer Care toll free at 1-800-468-1502.

Limited One-Year Warranty

Honeywell warrants this product, excluding battery, to be free from defects in the workmanship or materials, under normal use and service, for a period of one (1) year from the date of purchase by the consumer. If, at any time during the warranty period, the product is defective or malfunctions, Honeywell shall repair or replace it (at Honeywell's option) within a reasonable period of time.

If the product is defective,

- (i) return it, with a bill of sale or other dated proof of purchase, to the retailer from which you purchased it, or
- (ii) package it carefully, along with proof of purchase (including date of purchase) and a short description of the malfunction, and mail it, postage prepaid, to the following address:

Honeywell Return Goods
Dock 4 MN10-3860
1885 Douglas Dr N
Golden Valley, MN 55422

This warranty does not cover removal or reinstallation costs. This warranty shall not apply if it is shown by Honeywell that the defect or malfunction was caused by damage which occurred while the product was in the possession of a consumer.

Honeywell's sole responsibility shall be to repair or replace the product within the terms stated above. HONEYWELL SHALL NOT BE LIABLE FOR ANY LOSS OR DAMAGE OF ANY KIND, INCLUDING ANY INCIDENTAL OR CONSEQUENTIAL DAMAGES RESULTING, DIRECTLY OR INDIRECTLY, FROM ANY BREACH OF ANY WARRANTY, EXPRESS OR IMPLIED, OR ANY OTHER FAILURE OF THIS PRODUCT. Some states do not allow the exclusion or limitation of incidental or consequential damages, so this limitation may not apply to you.

THIS WARRANTY IS THE ONLY EXPRESS WARRANTY HONEYWELL MAKES ON THIS PRODUCT. THE DURATION OF ANY IMPLIED WARRANTIES, INCLUDING THE WARRANTIES OF MERCHANTABILITY AND FITNESS FOR A PARTICULAR PURPOSE, IS HEREBY LIMITED TO THE ONE-YEAR DURATION OF THIS WARRANTY. Some states do not allow limitations on how long an implied warranty lasts, so the above limitation may not apply to you.

This warranty gives you specific legal rights, and you may have other rights which vary from state to state.

If you have any questions concerning this warranty, please write Honeywell Customer Relations, 1885 Douglas Dr, Golden Valley, MN 55422 or call 1-800-468-1502. In Canada, write Retail Products ON15-02H, Honeywell Limited/Honeywell Limitée, 35 Dynamic Drive, Scarborough, Ontario M1V4Z9.



Honeywell

Automation and Control Solutions

Honeywell International Inc.
1985 Douglas Drive North
Golden Valley, MN 55422

Honeywell Limited-Honeywell Limitée
35 Dynamic Drive
Scarborough, Ontario
M1V 4Z9



Printed in U.S.A. on recycled
paper containing at least 10%
post-consumer paper fibers.