

# Honeywell

## T4, T4R & T4M Thermostat

EN

User Guide



**T4**

Programmable Thermostat

**T4M**

Programmable Modulating  
Thermostat

















**T4R**

Wireless  
Programmable  
Thermostat



# Contents

Thermostat Interface.....	4
Status Icons.....	4
Menu & Navigation Icons.....	5
Navigating the menu .....	5
 Menu.....	6
 Heating Schedule .....	6
 Clock .....	8
 Date.....	8
 Keypad lock .....	8
 Optimisation.....	9
 OpenTherm® boiler alerts (T4M only).....	10
 Standby mode.....	10
 Away mode.....	10
Schedule Override.....	11
  Temporary Override.....	11
  Timed Override .....	11
 Turn Schedule Off.....	11
Changing the Batteries (T4 & T4R only) .....	12
Wireless Receiver Box (T4R only).....	13
Troubleshooting.....	14

# Thermostat Interface

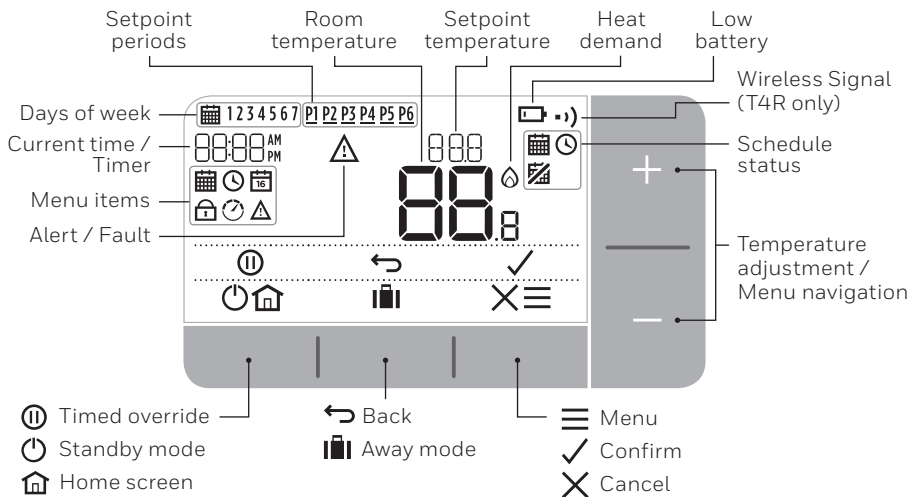

## Status Icons



**Schedule On:** Programmed schedule is active.



**Schedule Override:** Active until next scheduled period starts or the timed override duration has ended.



**Schedule Off:** Programmed schedule is turned off.



**Low Battery:** Power has reached approximately 10% - flashes when critically low (see Changing the Batteries).

















**Heat Demand:** Room temperature is below setpoint - indicating there is a demand for heating (boiler activity might occur).











**Wireless Signal:** Thermostat (T4R only) is connected to the Receiver Box.

## Menu & Navigation Icons

-  **Menu:** Options and settings of your Thermostat:
  -  Heating schedule
  -  Clock
  -  Date
  -  Keypad lock
  -  Optimisation
  -  OpenTherm® boiler alerts (T4M only)
-  **Back:** Return to the previous screen/menu.
-  **Confirm:** Confirm a change or selection.
-  **Cancel:** Reject a change without saving.
-  **Timed override:** Set a timed duration for the override.
-  **Standby:** Turns the heating on or off.
-  **Away mode:** Turns the heating off for a set number of days.
-  **Home:** Returns you directly back to the home screen.

## Navigating the menu

- Press  button to enter the main menu.
- Press  or  buttons to select a menu item - the selected item will flash.
- Press  to confirm the selection.
- Press  or  to adjust a setting and
  - press  to save change or advance to next selection.
  - press  to go back to previous selection.
  - press  to save change and return to home screen.

# ☰ Menu

## 📅 Heating schedule

Your Thermostat comes with the following default schedule. Follow the next steps to adjust the programmed schedule.

Period	Days 1 to 5 (Mon to Fri)		Days 6 & 7 (Sat & Sun)	
	Time	°C	Time	°C
<b>P1</b>	6:30 - 8:00	19 °C	8:00 - 10:00	19 °C
<b>P2</b>	8:00 - 18:00	16 °C	10:00 - 17:00	16 °C
<b>P3</b>	18:00 - 22:30	21 °C	17:00 - 23:00	21 °C
<b>P4</b>	22:30 - 6:30	16 °C	23:00 - 8:00	16 °C

1. Press ☰ to enter the main menu.

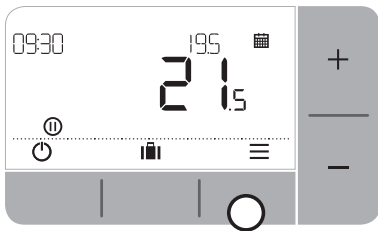

2. Press + or - to select the schedule menu 📅 and press ✓

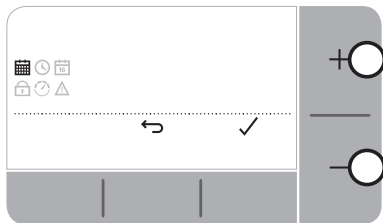

3. Press + or - to select EDIT and press ✓

4. Press + or – to select the day to be adjusted and press ✓

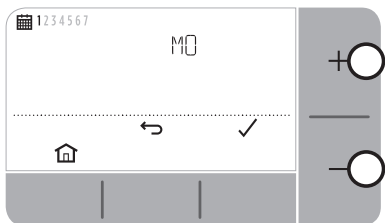

5. Press + or – to select the period to be adjusted and press ✓

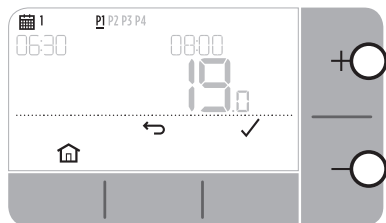

6. Press + or – to adjust the **start time** and press ✓

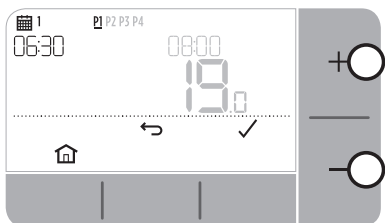

7. Press + or – to adjust the **end time** and press ✓

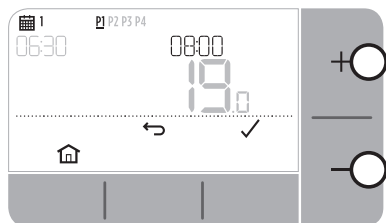

8. Press + or – to adjust the **temperature** and press ✓

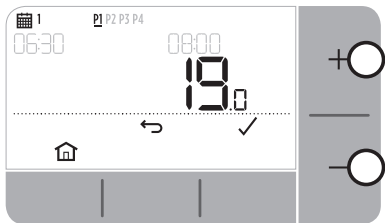

9. Repeat these steps to make adjustments to the remaining periods and days - or press  to save changes and return to the home screen.

# ☰ Menu

## 🕒 Clock

To make adjustments to the clock format or time.

1. Press ☰ to enter the main menu.
2. Press + or - to select the Clock menu 🕒 and press ✓
3. Press + or - to change the clock format and press ✓
4. Press + or - to adjust the time and press ✓

## 📅 Date

To make adjustments to the date - Year/Month/Day.

1. Press ☰ to enter the main menu.
2. Press + or - to select the Date menu 📅 and press ✓
3. Press + or - to adjust **year** and press ✓
4. Press + or - to adjust **month** and press ✓
5. Press + or - to adjust **day** and press ✓

## 🔒 Keypad lock

You can lock the keypad to prevent unnecessary adjustments to the Thermostat.

1. Press ☰ to enter the main menu.
2. Press + or - to select the Keypad lock 🔒 and press ✓ to activate it.
3. To unlock the Keypad press and hold the **Left** and **Right** buttons for **5 sec**.
4. To lock the Keypad repeat step 2.

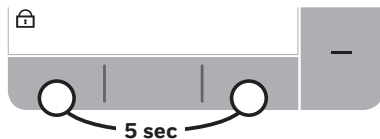



# ☰ Menu

## 🔄 Optimisation

Your Thermostat has optimisation functions that aim to save energy while maintaining suitable comfort levels. The Thermostat displays 🔄 during the optimisation period if set.

- **Optimum Start** learns how long it takes your home to reach a set temperature and then turns the heating on a bit earlier to achieve that temperature at the programmed time.
- **Delayed Start** saves energy by slightly delaying the start of heating depending on the difference between the set temperature and the room temperature. The closer these temperatures are the longer it will delay the start.
- **Optimum Stop** saves energy by switching off a little bit earlier than the programmed time. If your home is up to temperature, you will not notice the effect on the temperature, but you should see a difference in your fuel bill.

To enable or disable an optimisation function:

1. Press ☰ to enter the main menu.
2. Press + or – to select the Optimisation menu 🔄 and press ✓
3. Press + or – to select an option and press ✓
  - 0:0P for **Optimum Start** or **Delayed Start**
  - 0:95 for **Optimum Stop**
4. Press + or – to change the optimisation function and press ✓
  - 0:0P **0** = Optimum Start disabled
  - 0:0P **1** = Optimum Start enabled
  - 0:0P **2** = Delayed Start enabled
  - 0:95 **0** = Optimum Stop disabled
  - 0:95 **1** = Optimum Stop enabled
5. Press 🏠 to save changes and return to the home screen.

## ☰ Menu

### ⚠ OpenTherm® boiler alerts (T4M only)

If you have T4M Thermostat fitted to an OpenTherm® boiler, you can view alerts received from the boiler about your heating system.

1. Press ☰ to enter the main menu.
2. Press + or – to select the OpenTherm alerts menu ⚠ and press ✓
3. Press + or – to cycle through the list of boiler alerts.
4. Press 🏠 to return to the home screen.

## 🔌 Standby mode (with frost protect)

Save energy by switching the heating off when not required – e.g. during warmer summer months, or when doors and windows are open for extended periods of time. If the temperature drops to 5°C the heating will come on to prevent the heating pipes freezing.

1. Press 🔌 to switch the heating off – the display will show ☐FF.
2. Press 🔌 again to switch the heating on – the display will show 🗄.

## 🏠 Away mode

Save energy by switching the heating off for a set period of time while you are away from home – and back on again in time for your return.

1. Press 🏠 to enter the away mode menu.
2. Press + or – to select the **number of days** you will be away and press ✓
3. Press + or – to set the **temperature** while you are away and press ✓
4. To cancel Away mode press 🏠 again from the home screen.

# Schedule Override

During normal use your Thermostat will follow the programmed schedule - indicated by the  icon. There are a few ways you can override the schedule to suit your current needs.



## Temporary Override

Set until next programmed setpoint is reached.

1. Press **+** or **-** to set the new desired temperature. The programmed schedule will resume at the next programmed setpoint.





## Timed Override (1 or 2 hours)

Can be used to *Boost* (increase) the heating for a short period or as an *Economy* (decreased) setting if leaving the house for a short period.

1. Press **+** or **-** to set the new desired temperature and press  to activate the timer.
2. Press **+** or **-** to select **1** or **2 Hours** and press 
3. To cancel the timed override press  again from the home screen.



## Turn Schedule Off (Manual Mode)

Turn the heating schedule off and permanently follow a single (adjustable) temperature - until the schedule is turned on again.

1. Press **+** or **-** to select the schedule menu  and press 
2. Press **+** or **-** to select **OFF** and press 
3. Press **+** or **-** to adjust the permanent temperature.
4. Repeat above steps and choose  to follow the schedule.

# Changing the Batteries (T4 & T4R only)

The Thermostat is powered by batteries, although a battery icon is not shown on the display during normal use. The only time you will see the battery icon is when they get low on power.

-  is displayed when battery power has reached approximately 10% - you should be prepared to change them soon.
-  +  will flash when battery power has become critically low - you should **change them immediately** to make sure there is no disruption to your heating system.
- Replace with 2 new **1.5V LR6 AA Alkaline** batteries only - which should last approximately 2 years depending on Thermostat use.

1. Pull Thermostat off the wall bracket or table stand.

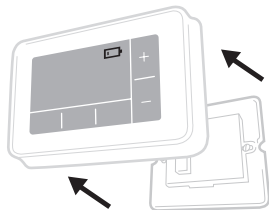

2. Remove old batteries and insert new ones.

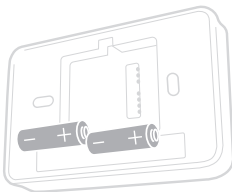

3. Clip Thermostat onto wall bracket or table stand.

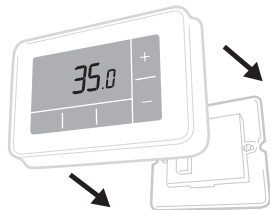

Please help to protect the environment by recycling old batteries in accordance with local regulations.

# Wireless Receiver Box (T4R only)

The T4R Thermostat communicates wirelessly to the Receiver Box which is wired to the boiler. If the Thermostat loses wireless communication or becomes faulty, the boiler can be switched on or off manually using the button on the Receiver Box

- **••)** is displayed on the Thermostat when the wireless signal is good - The receiver box **••)** LED will be solid GREEN.
- **△ + ••)** will flash on the Thermostat when the wireless signal is lost - The Receiver Box **••)** LED will flash RED.
- If communication is lost move the Thermostat to another location to try and restore communication.

To manually override the boiler using the Receiver Box:

1. Press the button **once** to switch the boiler ON or OFF. The button LED should be:
  - Solid YELLOW when the boiler is ON.
  - Off when the boiler is OFF.

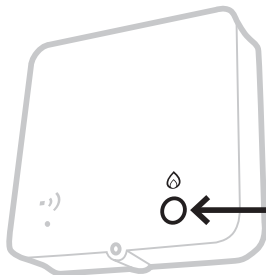

Press the button **once** to toggle boiler ON or OFF.













**Do not press the small reset 'pinhole' button** as this will clear the receiver box binding data and disrupt the operation of the heating system.

# Troubleshooting

If you have difficulty with your Thermostat, try these suggestions.

Most problems can be corrected quickly and easily.

<b>All models</b>	
Screen is blank	Replace the batteries (T4 & T4R only). Check the OpenTherm boiler has power (T4M only). Contact installer.
Thermostat shows 	Batteries have less than 10% power and need to be replaced soon.
Thermostat is flashing 	Batteries are critically low and need to be replaced immediately - see 'Changing the Batteries'.
Thermostat shows  but the boiler does not switch on.	The boiler cycles on and off as it controls the temperature, and sometimes the  icon will be displayed when the boiler has cycled off. If the boiler doesn't switch on after a long period of time contact your installer
Heating system does not respond to temperature adjustments.	Make sure the set temperature is higher than the actual room temperature. Check the heating system is powered on. Check the Receiver Box is powered and the Thermostat has a wireless signal (T4R only).
Thermostat shows 	The temperature sensor of your Thermostat is faulty, contact your installer to repair or replace the Thermostat.

<b>T4R (Wireless) Thermostat &amp; Receiver Box only</b>	
Thermostat is flashing  and Receiver Box  LED is flashing RED.	Wireless signal lost - Move the Thermostat to another location to try and restore communication.
Thermostat is flashing  and Receiver Box  LED is off.	Check Receiver Box has power by pressing the button to switch boiler on.  If Receiver Box has power then no wireless binding data stored - Follow binding procedure in the installation guide or contact your installer.
Receiver Box  LED is flashing ORANGE.	Receiver Box is in binding mode - will time out of this mode after 3 minutes.

<b>T4M (OpenTherm) Thermostat only</b>			
An OpenTherm boiler can report alerts back to the Thermostat which can be useful when contacting an installer or maintenance engineer. You can view these in the 'OpenTherm® boiler alerts' menu.			
Description	ID	Error code	OT Reading
Service request	001	01SR	0 = service not required 1 = service required
Low water pressure	002	02WP	0 = no WP fault 1 = WP fault
Gas/flame fault	003	03GF	0 = no GF fault 1 = GS fault
Air pressure fault	004	04AF	0 = no AP fault 1 = AP fault
Water Over Temperature	005	05WT	0 = no OVT fault 1 = OVT fault
OEM specific	006	06OS	Boiler manufacturer specific code

# Honeywell

**T4**

Programmable Thermostat

**T4R**

Wireless Programmable Thermostat

**T4M**

Programmable Modulating Thermostat



*Institut*  
**Automatització, S.L.**

c\ Gomis, 29-33, 08023 BARCELONA

Tel.: 93 454 20 06  
Fax: 93 323 70 59

iac@instauto.com  
www.instauto.com

www.  
**TODO-  
CONTROL**.com  
SOLUCIONES PARA AUTOMATIZACIÓN Y CLIMATIZACIÓN