

Honeywell

Installation Guide



PRO *TH3210D*

Non-programmable Digital Thermostat



69-1775

Product Application

This thermostat provides electronic control of 24 VAC heat pump systems with auxiliary heat (2 heat/1 cool).

Power Type

- Battery power
- Common wire
- Common wire with battery backup

System Settings

- Heat, Off, Cool, Em Heat

Fan Settings

- Auto, On

Must be installed by a trained, experienced technician

- Read these instructions carefully. Failure to follow these instructions can damage the product or cause a hazardous condition.
- Check the ratings in this booklet to verify that this product is suitable for your application (see page 11).
- Always test for proper operation after installation (see pages 7-8).



CAUTION: ELECTRICAL HAZARD

Can cause electrical shock or equipment damage. Disconnect power before beginning installation.



MERCURY NOTICE

If this product is replacing a control that contains mercury in a sealed tube, do not place the old control in the trash. Contact your local waste management authority for instructions regarding recycling and proper disposal.

Table of contents

Installation

Pre-installation checklist2
Wallplate installation3
Wiring.....4
Wiring diagrams5

Installer Setup

Battery installation6
Thermostat mounting6
Installer setup.....7
Installer system test7

Appendices

Quick reference to controls.....9
Quick reference to display.....9
Compressor protection9
In case of difficulty10
Accessories.....11
Specifications11

Installation tips

Install the thermostat about 5 feet (1.5m) above the floor in an area with good air circulation at average temperature.

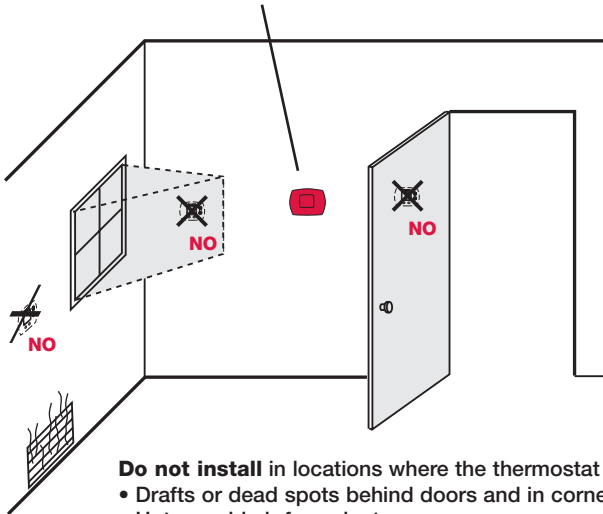

- Do not install** in locations where the thermostat can be affected by:
- Drafts or dead spots behind doors and in corners
 - Hot or cold air from ducts
 - Sunlight or radiant heat from appliances
 - Concealed pipes or chimneys
 - Unheated/uncooled areas such as an outside wall behind the thermostat

Pre-installation checklist

Package contents

Check to make sure your package includes the following items:

- PRO TH3210D digital thermostat (wallplate attached to back)
- Operating manual
- Wall anchors and mounting screws (2 each)
- AA alkaline batteries (2)

Required tools & supplies

- No. 2 Phillips screwdriver
- Small pocket screwdriver
- Drill
- Drill bit (3/16" for drywall, 7/32" for plaster)
- Hammer
- Pencil
- Electrical tape
- Level (optional)

Wallplate installation

Grasp top and bottom of wallplate and pull to remove from thermostat.

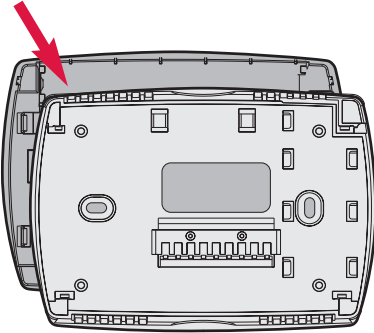

Remove the wallplate from the thermostat as shown at left, then follow directions below for mounting.

- 1 Pull wires through wire hole.
- 2 Position wallplate on wall, level and mark hole positions with pencil.
- 3 Drill holes at marked positions as shown below, then tap in supplied wall anchors.
- 4 Place wallplate over anchors, insert and tighten mounting screws.

Drill 3/16" holes for drywall.
Drill 7/32" holes for plaster.

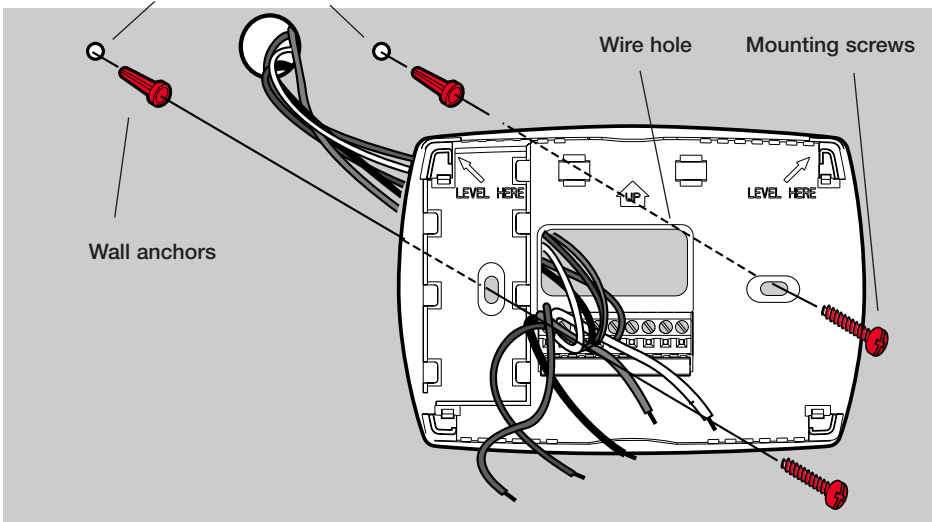

Wiring



CAUTION: ELECTRICAL HAZARD. Can cause electrical shock or equipment damage. Disconnect power before wiring.

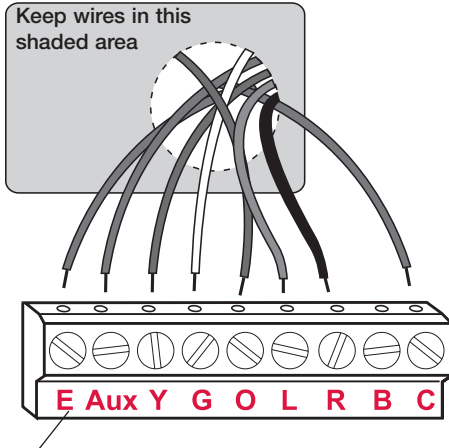

Terminal block

NOTES

C terminal

The C (common wire) terminal is optional when thermostat is powered by batteries.

L terminal

Heat pump reset. L terminal is powered continuously when thermostat is set to Em Heat.

Wire specifications

Use 18- to 22-gauge thermostat wire. Shielded cable is not required.

Wiring

- 1 Loosen screw terminals, insert wires into terminal block, then re-tighten screws.
- 2 Push excess wire back into the wall opening. Keep wires in shaded area as shown at left.
- 3 Plug the wall opening with non-flammable insulation to prevent drafts from affecting thermostat operation.

Terminal Designations

- E** Emergency heat relay.
- Aux** Auxiliary heat relay.
- Y** Compressor contactor.
- G** Fan relay.
- O** Heat pump changeover valve energized in cooling.
- L** Heat pump reset.
- R** Power wire from secondary side of system transformer.
- B** Heat pump changeover valve energized in heating.
- C** Common wire from secondary side of system transformer.

Wiring diagram

- 1 Power supply. Provide disconnect means and overload protection as required.
- 2 Optional 24 VAC common connection.
- 3 Use either **O** or **B** terminals for changeover valve.
- 4 L terminal is powered continuously when thermostat is set to Em Heat.
- 5 Install field jumper between E and Aux if there is no emergency heat relay.

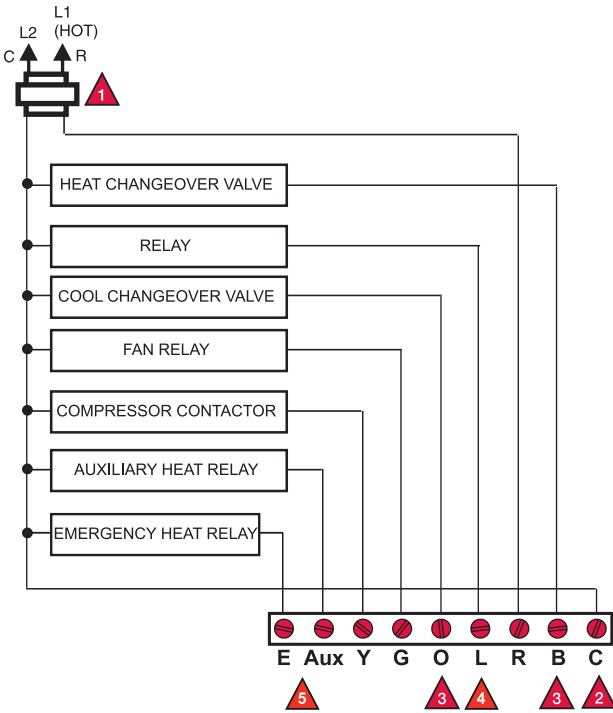

Power options & mounting

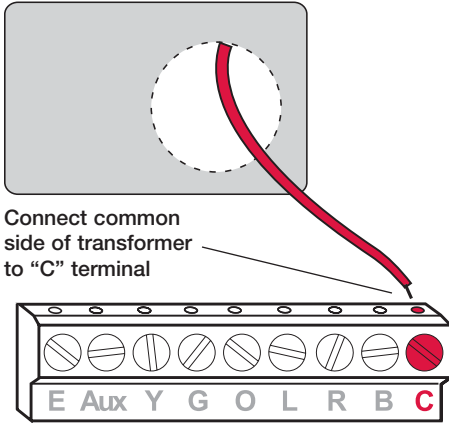

AC Power

The thermostat can be powered by 24 VAC power, or by batteries.

To wire the thermostat for AC power, connect the common side of the transformer to the "C" terminal as shown at left.

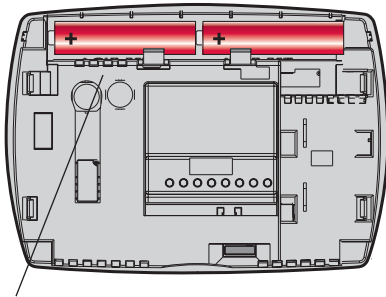

Install batteries in back of thermostat (optional if AC powered).

Battery Power

The thermostat can be powered by batteries alone or, if used with AC power, can provide backup power to the display during power interruptions.

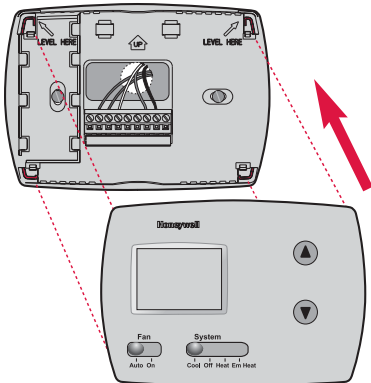

To Mount Thermostat

Align the 4 tabs on the wallplate with corresponding slots on the back of the thermostat, then push gently until the thermostat snaps in place.

Installer setup

Follow the procedure below to configure the thermostat to match the installed heating/cooling system, and customize feature operation as desired.

Press and hold both buttons

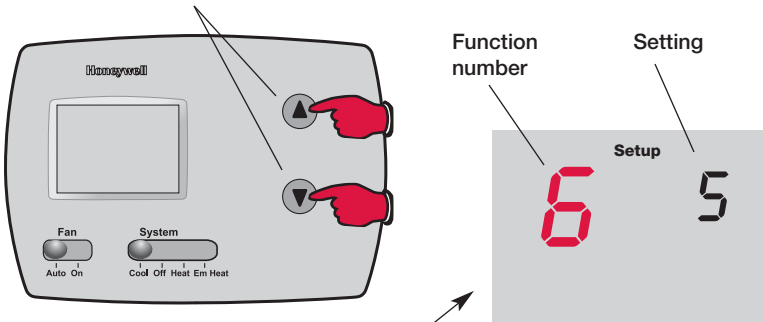

To begin, press and hold the ▲ and ▼ buttons until the display changes

- Press ▼ to change settings
- Press ▲ to advance to next function
- Press and hold ▼▲ to exit and save settings

Setup Function

- 6 Auxiliary heat cycle rate (CPH)**
- 8 Emergency heat cycle rate (CPH)**
- 9 Compressor cycle rate (CPH)**
- 14 Temperature display**
- 15 Compressor protection**

Settings & Options

- 5 For gas or oil furnaces of less than 90% efficiency**
 - 1 For steam or gravity systems
 - 3 For hot water systems & furnaces of over 90% efficiency
 - 9 For electric furnaces
 - [Other cycle rate options: 2, 4, 6, 7, 8, 10, 11 or 12 CPH]
- 9 For electric furnaces**
 - 1 For steam or gravity systems
 - 3 For hot water systems & furnaces of over 90% efficiency
 - 5 For gas or oil furnaces of less than 90% efficiency
 - [Other cycle rate options: 2, 4, 6, 7, 8, 10, 11 or 12 CPH]
- 3 Recommended for most compressors**
 - [Other cycle rate options: 1, 2, 4, 5 or 6 CPH]
- 0 Fahrenheit**
 - 1 Celsius
- 5 Five-minute compressor off time ****See page 9****
 - [Other options: 0, 1, 2, 3 or 4-minute off time]

Installer system test

After completing the installer setup above, press the ▲ button again to begin a system test (see next page).

Installer system test

Follow the procedure below to test the heating and cooling system.

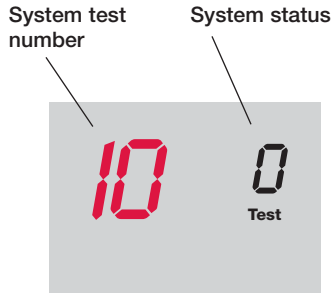
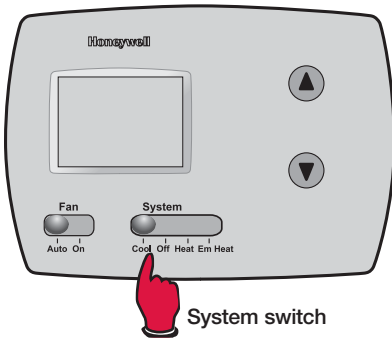

- 1 Set **SYSTEM** switch to Heat.
- 2 Press ▼ to turn on and check systems (see table, below).
- 3 Press ▼ until systems turn off.
- 4 Set **SYSTEM** switch to Em Heat and repeat steps 2-3 above.
- 5 Set **SYSTEM** switch to Cool and repeat steps 2-3 above.
- 5 Press and hold ▼ ▲ to terminate test at any time.

System Test

10 Heating system

20 Emergency heat

30 Cooling system

70 Thermostat information (for reference only)

System Status

0 Compressor and fan turn off.
1 Compressor and fan turn on.
2 Auxiliary heat turns on.

0 Heat and fan turn off.
1 Heat and fan turn on.
2 Auxiliary heat turns on.

0 Compressor and fan turn off.
1 Compressor and fan turn on.

71 Software revision number (major revisions)
72 Software revision number (minor revisions)
73 Configuration identification code (major)
74 Configuration identification code (minor)
75 Production configuration date code (week)
76 Production configuration date code (year)



CAUTION: EQUIPMENT DAMAGE HAZARD

Compressor protection (minimum off time) is bypassed during testing. To prevent equipment damage, avoid cycling the compressor quickly.

Quick reference to controls

Digital display screen

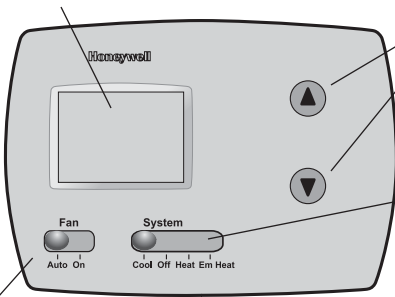

Fan switch

On: Fan runs continuously.

Auto: Fan runs only when heating or cooling system is on.

Temperature buttons

Press to adjust temperature settings

System switch

- **Cool:** Thermostat controls only the cooling system.
- **Heat:** Thermostat controls only the heating system.
- **Off:** Heating and cooling systems are off.
- **Em Heat:** Thermostat controls emergency and auxiliary heat. Compressor is locked out.

Quick reference to display screen

Current inside temperature

Low battery warning

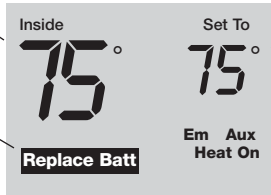

Temperature setting

System status

Em: Emergency heat on
Aux: Auxiliary heat on
Heat On/Cool On: (Flashes when waiting for compressor restart)

Built-in compressor protection (Setup Function 15)

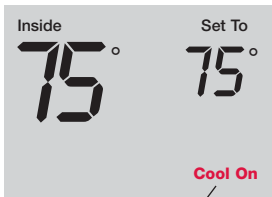

Message flashes until safe restart time has elapsed

This feature helps prevent damage to the compressor.

Damage can occur if the compressor is restarted too soon after shutdown. This feature forces the compressor to wait for a few minutes before restarting.

During the wait time, the message Cool On or Heat On will flash on the display. When the safe wait time has elapsed, the message stops flashing and the compressor turns on.

In case of difficulty

If you have difficulty with your thermostat, please try the suggestions below. Most problems can be corrected quickly and easily.

- Display is blank**
- Check circuit breaker and reset if necessary.
 - Make sure heating & cooling power switches are on.
 - Make sure equipment door is securely closed.
 - If battery powered, make sure fresh AA alkaline batteries are installed.
- Temperature settings do not change**
- Make sure heating and cooling temperatures are set to acceptable ranges:
- Heat: 40° to 90°F (4.5° to 32°C).
 - Cool: 50° to 99°F (10° to 37°C).
- Heating system does not respond (“Heat On” appears on screen)**
- Check for 24 Vac at the equipment on the secondary side of the transformer between power and common. If voltage is not present, check the heating equipment to find the cause of the problem.
 - Check for 24 Vac between the heat terminal (Y) and the transformer common. If 24 Vac is present, the thermostat is functional. Check the heating equipment to find the cause of the problem.
 - Check for loose or broken wires between the thermostat and the heating equipment.
- Cooling system does not respond (“Cool On” appears on screen)**
- Check for 24 Vac at the equipment on the secondary side of the transformer between power and common. If voltage is not present, check the cooling equipment to find the cause of the problem
 - Check for 24 Vac between the cooling terminal (Y) and the transformer common. If 24 Vac is present, the thermostat is functional. Check the cooling system to find the cause of the problem.
 - Check for loose or broken wires between the thermostat and the cooling equipment.
- “Cool On” or “Heat On” is flashing**
- Compressor protection timeout is engaged. Wait 5 minutes for the system to restart safely, without damage to the compressor.
- “Heat On” is not displayed**
- Set the System switch to Heat, and set the temperature level above the current room temperature.
- “Cool On” is not displayed**
- Set the System switch to Cool, and set the temperature level below the current room temperature.

Accessories

Please contact your distributor to order accessories.

Cover plate assemblyPart Number 50002883-001
(Used to cover marks left by old thermostats.)

Specifications

Temperature Ranges

- Heat: 40° to 90°F (4.5° to 32°C)
- Cool: 50° to 99°F (10° to 37°C)

Operating Ambient Temperature

- 32° to 120°F (0° to 48.9°C)

Shipping Temperature

- -20° to 120°F (-28.9° to 48.9°C)

Operating Relative Humidity

- 5% to 90% (non-condensing)

Physical Dimensions

- 3-13/16" H x 5-3/8" W x 1-1/4" D
- 97 mm H x 137 mm W x 32 mm D

Electrical Ratings

System	Voltage (50/60Hz)	Running Current
Heat (1 st stage)	20-30 Vac	0.02-1.0 A
Emergency heat	20-30 Vac	0.02-1.0 A
Auxiliary heat	20-30 Vac	0.02-1.0 A
Cooling	20-30 Vac	0.02-1.0 A

Automation and Control Solutions

Honeywell International Inc.

1985 Douglas Drive North

Golden Valley, MN 55422

<http://yourhome.honeywell.com>

Honeywell Limited-Honeywell Limitée

35 Dynamic Drive

Scarborough, Ontario M1V 4Z9



Printed in U.S.A. on recycled paper containing at least 10% post-consumer paper fibers.

© U.S. Registered Trademark.
© 2005 Honeywell International Inc.
Patents pending. All rights reserved.
69-1775 • 06-2005

Honeywell