

48" 1080p 60Hz LED TV

55" 1080p 60Hz LED TV

NS-48D510NA17/NS-55D510NA17/NS-55D510MX17

INSIGNIA™

Contents

CHILD SAFETY	1
Important Safety Instructions	2
WARNING	2
CAUTION	3
Introduction	4
INlink	4
DTS Sound™	4
Game mode	4
Installing the stands or wall-mount bracket	4
Installing the stands	4
Installing a wall-mount bracket	6
TV components	8
Package contents	8
Front	8
Side jacks	9
Remote control	10
What connection should I use?	11
Connecting a cable or satellite box	12
HDMI (best)	12
AV (good)	13
Coaxial (good).....	14
Connecting an antenna or cable TV (no box)	15
Connecting a DVD or Blu-ray player	16
HDMI (best)	16
AV (good)	17
Connecting a game console	18
HDMI (best)	18
AV (good)	19
Connecting a computer	20
Connecting a USB flash drive	21
Connecting headphones	22
Connecting external speakers or a soundbar	23
Digital audio	23
Analog audio.....	24

- Connecting a home theater system with multiple devices 25
- Connecting power 26
- Using the remote control 27
 - Installing remote control batteries 27
 - Aiming the remote control 27
 - Programming universal remote controls 28
 - Viewing universal remote control codes 28
- Turning on your TV for the first time 29
- Understanding the basics 31
 - Turning your TV on or off 31
 - Selecting the video input source 31
 - On-screen menu overview 32
 - Navigating the menus 33
 - Selecting a channel 33
 - Adjusting the volume 33
 - Viewing channel information 33
- Using INlink 34
 - Turning INlink on or off 34
 - Turning Device Auto Power Off on or off 34
 - Turning TV Auto Power On on or off 35
 - Turning Audio Receiver on or off 35
 - Displaying a list of INlink-compatible devices 36
 - Selecting an INlink-compatible device 36
- Using a USB flash drive 37
 - Switching to USB mode 37
 - Browsing photos 37
 - Viewing photos in a slideshow 38
- Adjusting the picture 38
 - Adjusting the TV picture 38
 - Automatically adjusting the aspect ratio 40
 - Setting the power on picture mode 40
- Adjusting the sound 40
 - Adjusting sound settings 40
 - Selecting the audio out mode 41
 - Playing TV audio only 42
- Changing channel settings 42
 - Automatically scanning for channels 42
 - Hiding channels 43
 - Setting up a favorite channel list 44
 - Viewing a favorite channel 44
 - Adding or changing a channel label 44
 - Checking the digital signal strength 45

Setting parental controls	45
Setting or changing the password	45
Blocking unrated TV	46
Setting parental control levels	47
Downloading rating information	48
Locking the power button on your TV	49
Using closed captioning	49
Turning closed captioning on or off	49
Selecting the analog closed captioning mode	50
Selecting the digital closed captioning mode	50
Customizing digital closed captioning settings	51
Adjusting time settings	51
Setting the clock	51
Setting the sleep timer	52
Adjusting menu settings	53
Selecting the menu language	53
Turning Input Sensor on or off	53
Labeling an input source	53
Maintaining	54
Cleaning the TV cabinet	54
Cleaning the TV screen	54
Troubleshooting	54
Viewing system information	54
Learning more about your TV	54
Updating the TV firmware	55
Customizing TV settings	55
Testing the TV speakers	56
Restoring settings to the defaults	56
Video and audio	57
Remote control	60
General	60
INlink (CEC-compatible) device	61
Specifications	63
Legal notices	64
One-year limited warranty - Insignia Televisions—US and Canada	65
One-year limited warranty - Insignia Televisions—Mexico	66

CHILD SAFETY

PROPER TELEVISION PLACEMENT MATTERS



THE CONSUMER ELECTRONICS INDUSTRY CARES

- Manufacturers, retailers and the rest of the consumer electronics industry are committed to making home entertainment safe and enjoyable.
- As you enjoy your television, please note that all televisions - new and old- must be supported on proper stands or installed according to the manufacturer's recommendations. Televisions that are inappropriately situated on dressers, bookcases, shelves, desks, speakers, chests, carts, etc., may fall over, resulting in injury.

TUNE IN TO SAFETY

- **ALWAYS** follow the manufacturer's recommendations for the safe installation of your television.
- **ALWAYS** read and follow all instructions for proper use of your television.
- **NEVER** allow children to climb on or play on the television or the furniture on which the television is placed.
- **NEVER** place the television on furniture that can easily be used as steps, such as a chest of drawers.
- **ALWAYS** install the television where it cannot be pushed, pulled over or knocked down.
- **ALWAYS** route cords and cables connected to the television so that they cannot be tripped over, pulled or grabbed.

WALL OR CEILING MOUNT YOUR TELEVISION

- **ALWAYS** contact your retailer about professional installation if you have any doubts about your ability to safely mount your television.
- **ALWAYS** use a mount that has been recommended by the television manufacturer and has a safety certification by an independent laboratory (such as UL, CSA, ETL).
- **ALWAYS** follow all instructions supplied by the television and mount manufacturers.
- **ALWAYS** make sure that the wall or ceiling where you are mounting the television is appropriate. Some mounts are not designed to be mounted to walls and ceilings with steel studs or cinder block construction. If you are unsure, contact a professional installer.
- Televisions can be heavy. A minimum of two people is required for a wall or ceiling mount installation.

MOVING AN OLDER TELEVISION TO A NEW PLACE IN YOUR HOME

- Many new television buyers move their older CRT televisions into a secondary room after the purchase of a flat-panel television. Special care should be made in the placement of older CRT televisions.
- **ALWAYS** place your older CRT television on furniture that is sturdy and appropriate for its size and weight.
- **NEVER** place your older CRT television on a dresser where children may be tempted to use the drawers to climb.
- **ALWAYS** make sure your older CRT television does not hang over the edge of your furniture.

Important Safety Instructions



This symbol indicates that dangerous voltage constituting a risk of electric shock is present within your TV. This label is located on the back of your TV.



This symbol indicates that there are important operating and maintenance instructions in the literature accompanying your TV.

- 1 Read these instructions.
- 2 Keep these instructions.
- 3 Heed all warnings.
- 4 Follow all instructions.
- 5 Do not use this apparatus near water.
- 6 Clean only with dry cloth.
- 7 Do not block any ventilation openings. Install in accordance with the manufacturer's instructions.
- 8 Do not install near any heat sources such as radiators, heat registers, stoves, or other apparatus (including amplifiers) that produce heat.
- 9 Do not defeat the safety purpose of the polarized or grounding-type plug. A polarized plug has two blades with one wider than the other. A grounding type plug has two blades and a third grounding prong. The wide blade or the third prong are provided for your safety. If the provided plug does not fit into your outlet, consult an electrician for replacement of the obsolete outlet.
- 10 Protect the power cord from being walked on or pinched particularly at plugs, convenience receptacles, and the point where they exit from the apparatus.
- 11 Only use attachments/accessories specified by the manufacturer.
- 12 Use only with the cart, stand, tripod, bracket, or table specified by the manufacturer, or sold with the apparatus. When a cart is used, use caution when moving the cart/apparatus combination to avoid injury from tip-over.
- 13 Unplug this apparatus during lightning storms or when unused for long periods of time.



- 14 Refer all servicing to qualified service personnel. Servicing is required when the apparatus has been damaged in any way, such as power-supply cord or plug is damaged, liquid has been spilled or objects have fallen into the apparatus, the apparatus has been exposed to rain or moisture, does not operate normally, or has been dropped.
- 15 The *wall plug* is the disconnecting device. The plug must remain readily operable.
- 16 Remote control batteries should not be exposed to excessive heat such as sunshine, fire, or the like.
- 17 The apparatus should not be exposed to dripping or splashing, and no objects filled with liquids, such as vases, should be placed on the apparatus.
- 18 Your TV has four VESA mounting holes on the back. If you attach a wall-mount bracket or TV stand to the back of your TV, **the bracket or stand must be securely attached using all four holes.** If you do not use all four mounting holes, your TV may fall and cause property damage or personal injury. See the documentation that came with your wall mount or TV stand for complete mounting instructions.

WARNING

Electric shock hazard

To reduce the risk of fire or electric shock, do not remove any cover or expose the device to rain or moisture. No user-serviceable parts are inside. Refer servicing to qualified service technicians.

Lightning

For added protection for your device receiver during a lightning storm, or when it is left unattended and unused for long periods of time, unplug it from the power outlet and disconnect any antenna or cable system. This helps prevent property damage and personal injury from lightning and power line surges.

Power lines

An outside antenna system should not be located in the vicinity of overhead power lines or other electric light or power circuits, or where it can fall into such power lines or circuits. When installing an outside antenna system, take extreme care to keep from touching such power lines or circuits as contact with them might be fatal.

Handling the LCD panel

- Your TV's screen is made of glass. Do not drop your TV or hit, jolt, or press hard against the LCD panel. If the screen breaks, be careful of broken glass.
- If the LCD panel is broken, make absolutely sure that you do not touch the liquid in the panel. This may cause skin inflammation.
- If the liquid gets in your mouth, immediately gargle, rinse, and consult with your doctor. Also, if the liquid gets in your eyes or touches your skin, consult with your doctor after rinsing for at least 15 minutes or longer in clean water.

Replacement parts

When replacement parts are required, make sure that the service technician uses replacement parts specified by the manufacturer that have the same characteristics as the original part. Unauthorized substitutions may result in fire, electric shock, personal injury, or other hazards.

Safety check

After completing any service or repair to this device, ask the service technician to perform routine safety checks to determine that your TV is in correct operating condition.

Power source

Operate your TV only from the type of power source indicated on the marking label. If you are not sure of the type of power supplied to your home, consult an electrician or your local power company.

Servicing

These servicing instructions are for use by qualified service personnel only. To reduce the risk of electric shock, do not perform any servicing other than that contained in the operating instructions unless you are qualified to do so.

CAUTION

Damage requiring service

- Unplug this TV from the power outlet and refer servicing to qualified service personnel under the following conditions:
- When the power supply cord or plug is damaged or frayed.
 - If liquid has been spilled or objects have fallen into your TV.
 - If your TV has been exposed to rain or water.
 - If your TV does not operate normally by following the operating instructions. Adjust only those controls covered by the operating instructions because incorrect adjustment of other controls may result in damage and will often require extensive work by a qualified technician to restore your TV to its normal operation.
 - If your TV has been dropped or damaged in any way.
 - When your TV exhibits a distinct change in performance.

Outdoor antenna grounding

If an outside antenna or cable system is connected to your TV, make sure that the antenna or cable system is grounded to provide some protection against voltage surges and built-up static charges. Article 810 of the National Electrical Code, ANSI/NFPA No. 70, provides information with respect to correct grounding of the mast and supporting structure, grounding of the lead-in wire to an antenna discharge unit, size of grounding conductors, location of the antenna-discharge unit, connection to grounding electrodes, and requirements for the grounding electrode.

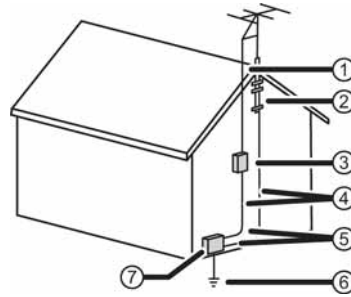

- 1 Antenna lead-in wire
- 2 Grounding clamp
- 3 Antenna discharge unit
- 4 Grounding conductors
- 5 Ground clamps
- 6 Power service grounding electrode system
- 7 Electric service equipment

Note to CATV system installer

Article 820 of the National Electrical Code, ANSI/NFPA No. 40 provides guidance for correct grounding. Specifically, it states that the cable ground must be connected to the grounding system of the building as close to the point of cable entry as practical.

Condensation

Moisture will form on the TV if the TV is brought from cool surroundings into a warm room or if the temperature of the room rises suddenly. When this happens, the TV's performance may be impaired. To prevent this, let the TV stand in its new surroundings for about an hour before switching it on, or make sure that the room temperature rises gradually. Condensation may also form during the summer if the TV is exposed to the breeze from an air conditioner. In such cases, change the location of the TV.

Mobile telephone warning

To avoid interference with your TV picture and sound, operating problems, or even damage, keep your cordless and cellular telephones away from the TV.

End of life directives

Your TV may contain materials that are regulated for environmental reasons. Your TV also contains materials that can be recycled and reused. To help protect the environment, contact your local authorities for information about disposal or recycling and about finding a recycler in your area before you dispose of your TV.

Non-active pixels

The LCD panel contains almost 3 million thin film transistors, which provide exceptionally sharp video quality. Occasionally, a few non-active pixels may appear on the screen as a fixed blue, green, or red point. These non-active pixels do not adversely affect the performance of your TV, and are not considered defects.

48"/55" 1080p 60Hz LED TV

Introduction

Congratulations on your purchase of a high-quality Insignia product. Your NS-48D510NA17, NS-55D510NA17, or NS-55D510MX17 represents the state of the art in LED TV design and is designed for reliable and trouble-free performance.

INlink

Enjoy the benefit of having HDMI CEC compatible products plug and play! No setup is needed! CEC technology lets different devices discover and communicate with each other. (See page 34 for instructions on how to use INlink.)

Installing the stands or wall-mount bracket

- If you want to place your TV on a table or in an entertainment center, go to [Installing the stands](#).
- If you want to mount your TV on a wall, go to [Installing a wall-mount bracket](#).

Notes

- If you plan to wall-mount your TV, do not install the stands.
- Store the stands and stand screws in case you decide to use the stands in the future.

Installing the stands

- 1 Carefully place your TV face-down on a cushioned, clean surface to protect the screen.

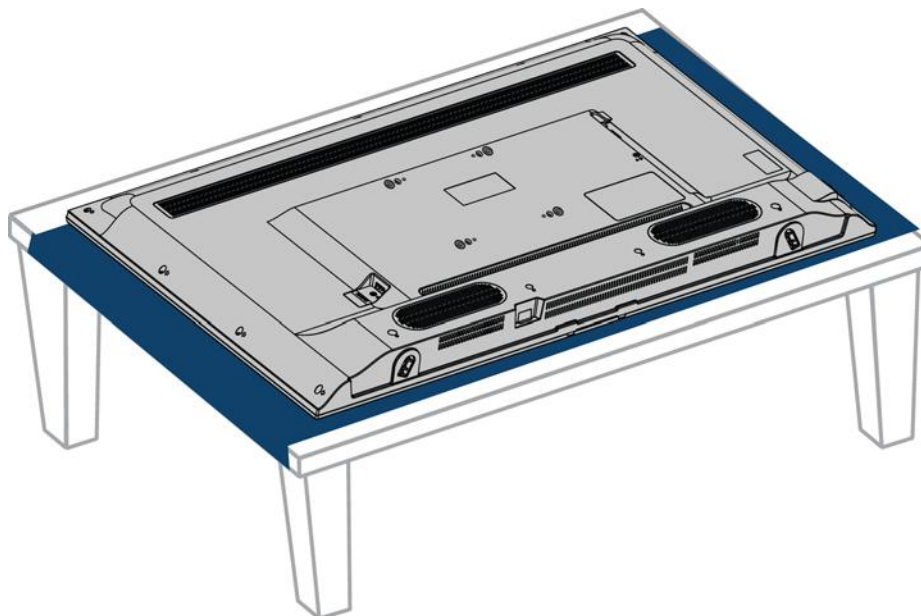

- 2 Make sure that the arrows on the bottoms of the stands point toward the front of the TV. Align the screw holes on the TV stands with the holes on the bottom of your TV, then secure each stand with two of the provided screws.

Screw type	Screw length	# of screws
M4	20 mm	4

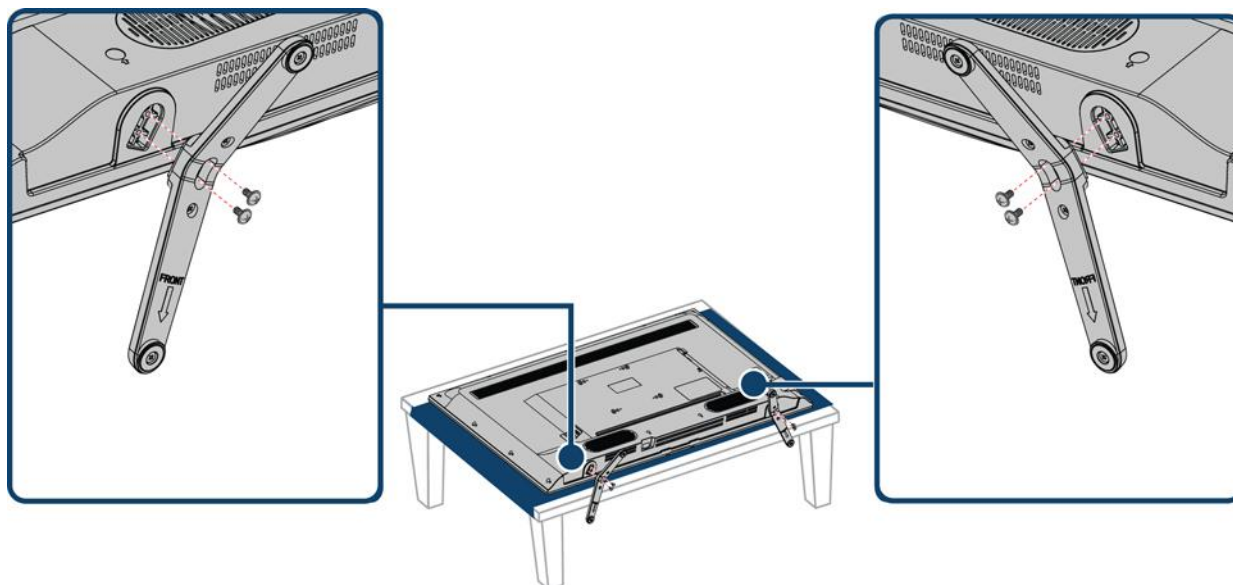

Installing a wall-mount bracket

Warnings

- Your TV has four VESA mounting holes on the back. If you attach a wall-mount bracket to the back of your TV, **the bracket must be securely attached, using all four holes.** If you do not use all four mounting holes, your TV may fall and cause property damage or personal injury. See the documentation that came with your wall mount for complete mounting instructions.
- This TV is intended to be supported by a UL Listed wall mount bracket with suitable weight/load. (See [Miscellaneous \(both models\)](#) on page 64.)

- 1 Carefully place your TV face-down on a cushioned, clean surface to protect the screen.

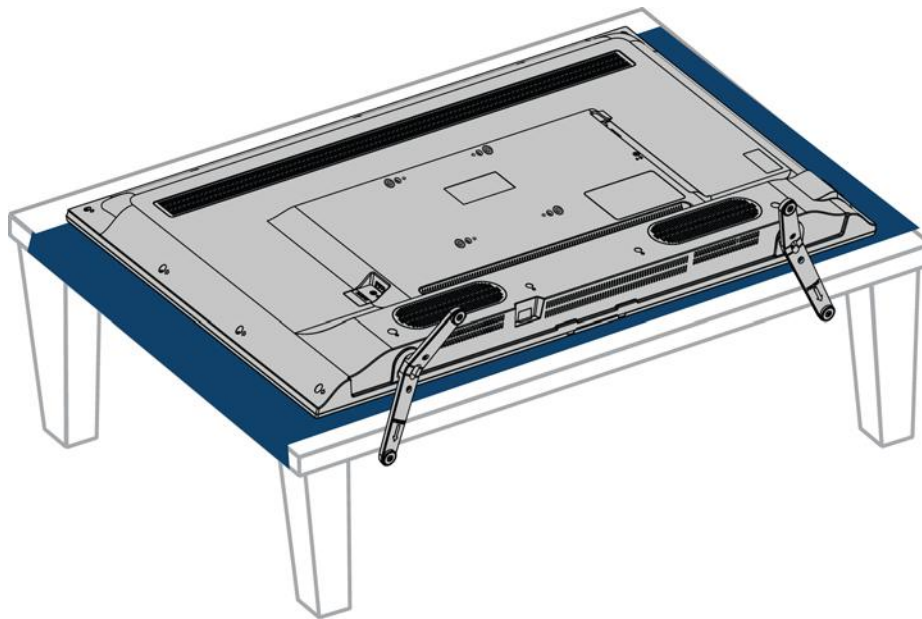

- 2 If the TV stands are installed, remove the four screws that secure the stands to your TV.

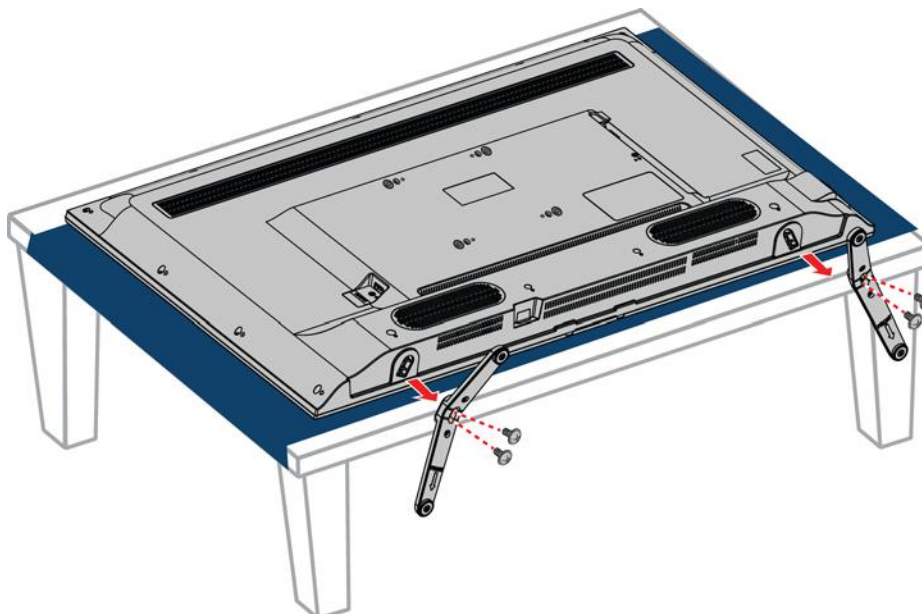

- 3 Attach the wall-mount bracket to your TV using the mounting holes on the back of your TV. See the instructions that came with the wall-mount bracket for information about which screws to use and how to correctly hang your TV.

Notes

- The length of the wall-mount screws vary depending on the wall-mount bracket you purchased. See the instructions that came with the wall-mount bracket for screw lengths.
- Make sure that the screws you use are the correct length. The threaded parts of the screws that are inserted into the back of your TV must be at least 9.5 mm in length and not more than 11.5 mm in length. If the screws are too short, your TV may fall off the wall-mount bracket. If the screws are too long, they may damage components inside your TV. For more information, see the instructions that came with the wall-mount bracket.
- The mounting holes on the back of your TV take type M6 screws.

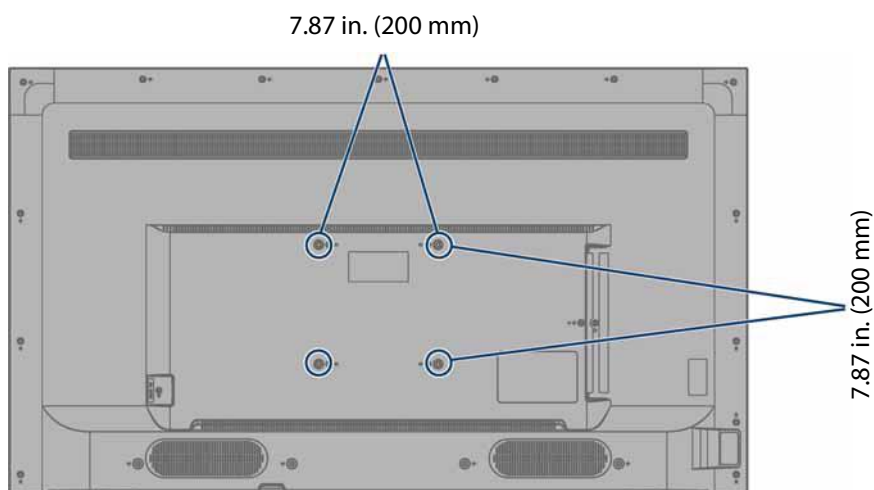

TV components

Your TV has several sets of jacks for connecting devices to your TV.

This section contains information about:

- [Package contents](#)
- [Side jacks](#)
- [Remote control](#)

Package contents

- 48" or 55" LED TV
- Remote control and batteries (2 AAA)
- TV stands and screws (4 pcs)
- Power cord
- *User Guide* (for NS-55D510MX17)
- *Quick Setup Guide*
- *Important Information*

Front



#	Item	Description
1	Remote control sensor	Receives signals from the remote control. Do not block.
2	Power indicator	Turns off when your TV is on. Lights red when your TV is off (standby mode).

Side jacks

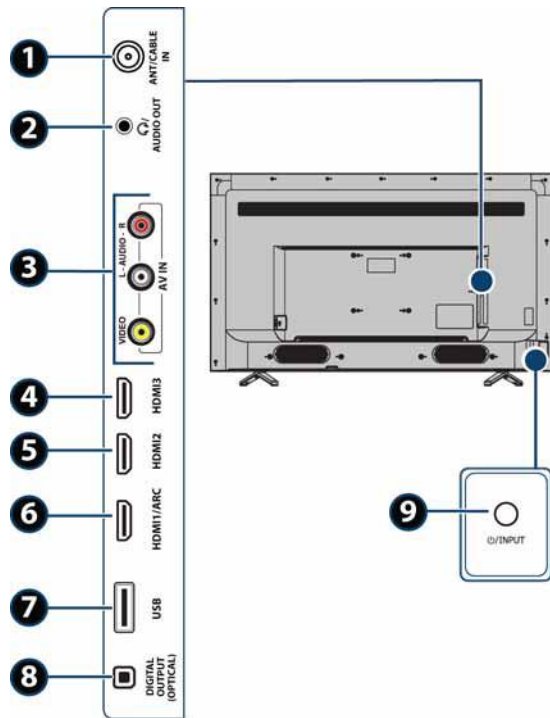

#	Item	Description
1	ANT/CABLE IN	Connect an antenna or cable TV to this jack. For more information, see Coaxial (good) on page 14 or Connecting an antenna or cable TV (no box) on page 15.
2	AUDIO OUT	Connect headphones, a soundbar, analog speaker system, or a home theater system to this jack to listen to TV audio through external speakers. For more information, see Connecting headphones on page 22 or Analog audio on page 24.
3	VIDEO and L and R AUDIO	Connect the video and audio for an AV device to these jacks. For more information, see AV (good) on page 13, 17, or 19.
4	HDMI3	Connect an HDMI device to this jack. For more information, see HDMI (best) on pages 12, 16, or 18 or Connecting a computer on page 20.
5	HDMI2	Connect an HDMI device to this jack. For more information, see HDMI (best) on pages 12, 16, or 18 or Connecting a computer on page 20.

#	Item	Description
6	HDMI1/ARC	Connect an HDMI device to this jack. For more information, see HDMI (best) on pages 12, 16, or 18 or Connecting a computer on page 20. OR Connect an ARC-enabled home theater receiver to this jack.
7	USB	Connect a USB flash drive to this jack to view compatible JPEG picture files. For more information, see Connecting a USB flash drive on page 21 and Using a USB flash drive on page 37.
8	DIGITAL OUTPUT (OPTICAL)	Connect a soundbar, digital speaker system, or home theater system to this jack to listen to TV audio through external speakers. For more information, see Digital audio on page 23. ⏻—Press to turn on your TV when your TV is off (in standby mode). Press and hold to turn off your TV when TV is on. Warning: When your TV is off, power still flows through it. To completely disconnect power, unplug the power cord. INPUT —Quickly press and release to open the <i>INPUT SOURCE</i> list, press one or more times to select a video input source, then wait a few seconds. Your TV switches to the source you selected. For more information, see Selecting the video input source on page 31.
9	⏻/INPUT	

Remote control

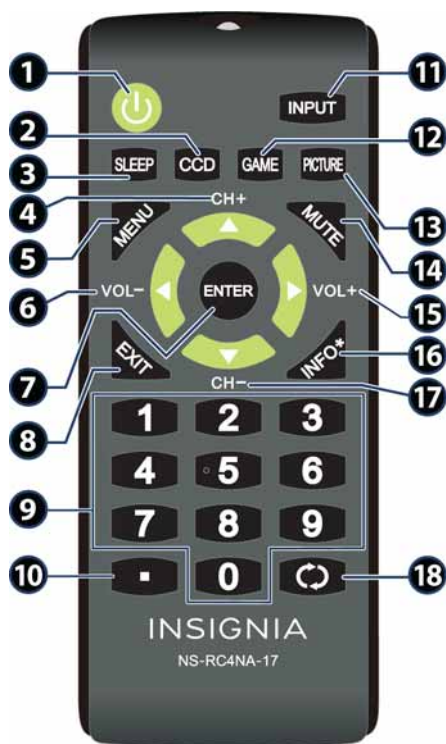



#	Button	Press to...
12	GAME	Change the picture mode to Game mode.
13	PICTURE	Select the picture mode. You can select Vivid , Standard , Energy Savings , Movie , Game , or Custom . See the Picture Mode option in Adjusting the TV picture on page 38.
14	MUTE	Mute or un-mute the sound.
15	VOL+ / ►	TV: Increase the volume. TV menu: Navigate right. USB: Control a photo slideshow.
16	INFO*	Display TV status information, such as the channel number, channel name (if available), or signal source. See Viewing channel information on page 33.
17	CH- / ▼	TV: Change to the next lower channel in the channel list. TV menu: Navigate down. USB: Control a photo slideshow.
18	↻ (return)	Return to the previous channel.

#	Button	Press to...
1	⏻ (power)	Turn your TV on or off (standby mode). Warning: When your TV is off, power still flows through it. To disconnect power, unplug the power cord.
2	CCD	TV: Turn closed captioning on or off. You can select CC Off , CC On , or CC On when mute . See Turning closed captioning on or off on page 50. USB: Zoom when displaying a photo.
3	SLEEP	Set the sleep timer. You can select Off , 5 , 10 , 15 , 30 , 60 , 90 , 120 , 180 , or 240 minutes. See Setting the sleep timer on page 53.
4	CH+ / ▲	TV: Change to the next higher channel in the channel list. TV menu: Navigate up. USB: Control a photo slideshow.
5	MENU	Open the on-screen menu.
6	VOL- / ◀	TV: Decrease the volume. TV menu: Navigate left. USB: Control a photo slideshow.
7	ENTER	Confirm selections or changes in TV menus.
8	EXIT	Close the on-screen TV menu.
9	Numbers	Enter channel numbers and the parental control password.
10	■	Enter a digital sub-channel number. See Selecting a channel on page 33.
11	INPUT	Open the INPUT SOURCE list. Press ▲ or ▼ to select the video input source, then press ENTER . See Selecting the video input source on page 31.

What connection should I use?

Your TV has several connection types for connecting devices to your TV. For the best video quality, you should connect a device to the best available connection. Use the following tables to identify cables:

Video quality	Connection type and jack	Cable connector
Best (use this if your devices have HDMI)	HDMI video/audio	
Better than coaxial	AV (composite video) (requires an audio connection)	
Good	Coaxial video/audio	

Connection type and jack	Cable connector
--------------------------	-----------------

Optical digital audio output



Analog audio input



3.5mm analog audio output



Cautions

- Check the jacks for position and type before making any connections.
- Loose connections can cause poor audio or video quality. Make sure that all connections are tight and secure.
- The external audio/video devices shown may be different from your devices. If you have questions, refer to the documentation that came with your devices.
- Always unplug the power cord when connecting devices.

Connecting a cable or satellite box

Many cable or satellite TV boxes have more than one connection type. To get the best video, you should use the best connection type available. For more information, see [What connection should I use?](#) on page 11.

You can connect your cable or satellite box using:

- HDMI (best)
- AV (good)
- Coaxial (good)

HDMI (best)

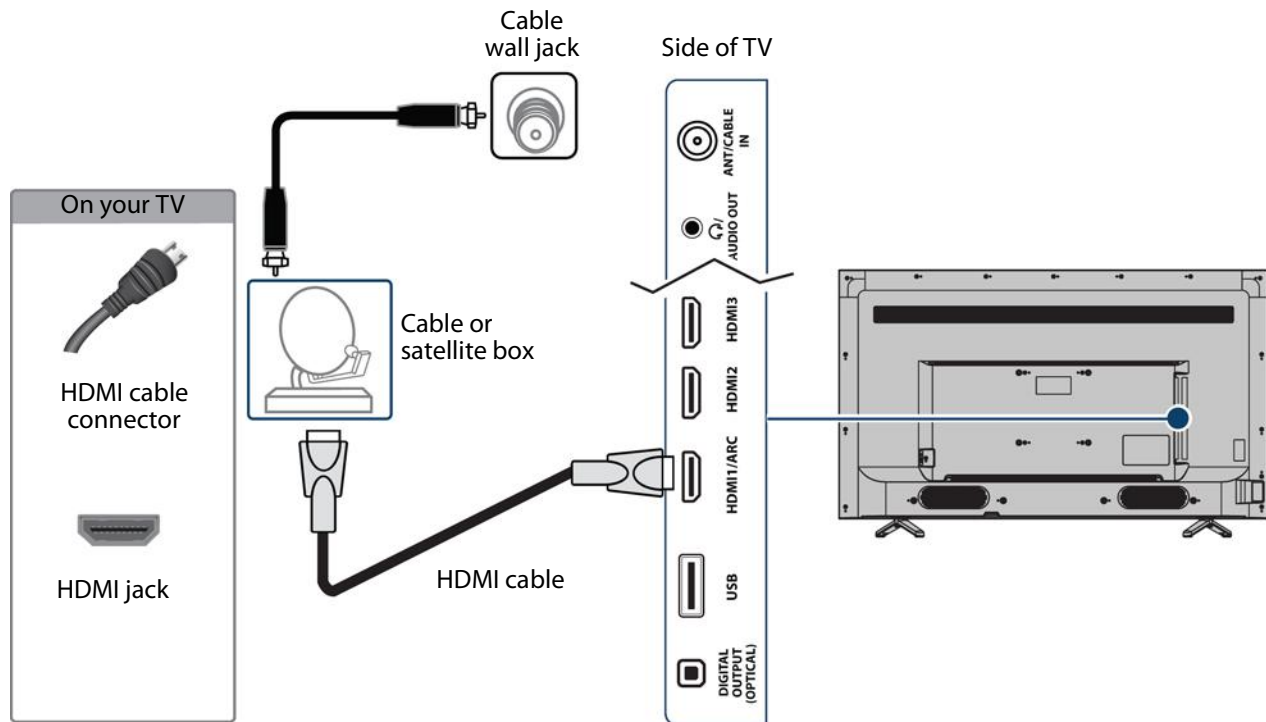

- 1 Make sure that your TV's power cord is unplugged and all connected devices are turned off.
- 2 Connect the incoming cable from the cable wall jack to the cable-in jack on the cable or satellite box.
- 3 Connect an HDMI cable (not provided) to an **HDMI** jack on your TV and to the **HDMI OUT** jack on the cable or satellite box.
- 4 Plug your TV's power cord into a power outlet, turn on your TV, then turn on the cable or satellite box.
- 5 Press **INPUT** to open the *INPUT SOURCE* list.
- 6 Press **▲** or **▼** to highlight **HDMI1**, **HDMI2**, or **HDMI3**, then press **ENTER**.

Note

An HDMI cable carries both audio and video. You do not need to use any audio cables.

AV (good)

Note

Cables are often color-coded to match color-coded jacks.

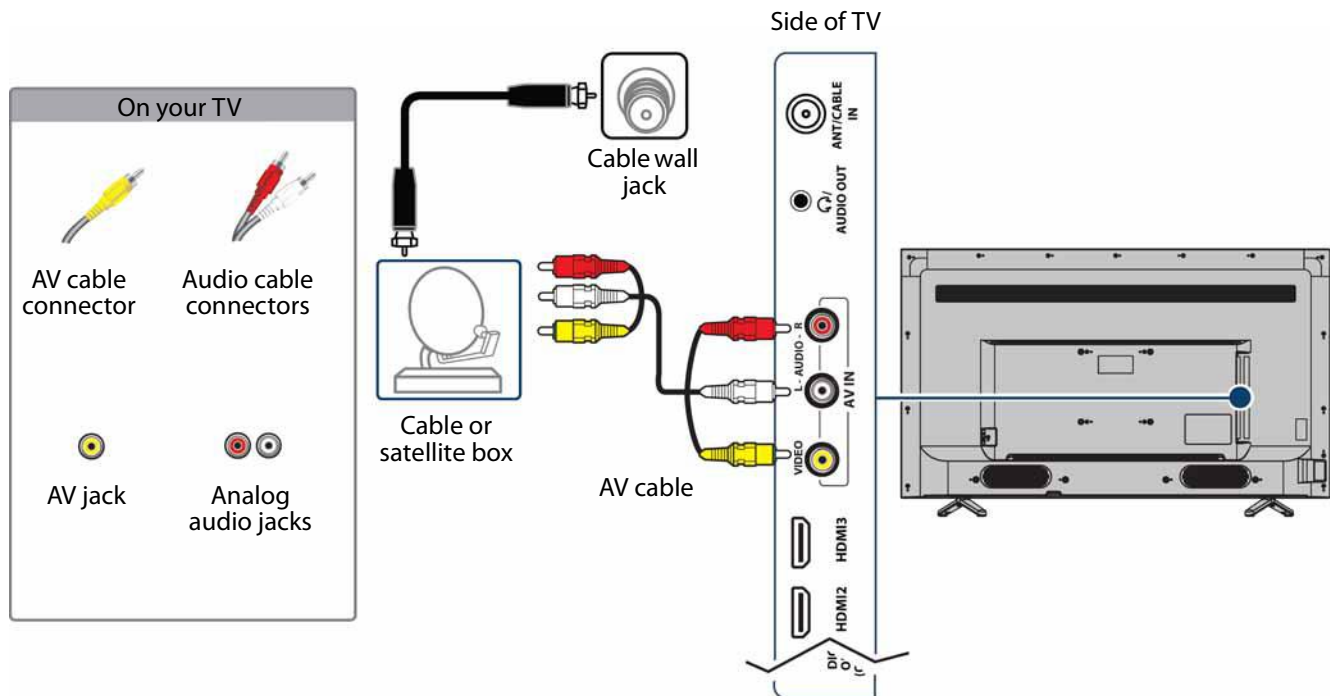

- 1 Make sure that your TV's power cord is unplugged and all connected devices are turned off.
- 2 Connect the incoming cable from the cable wall jack to the cable-in jack on the cable or satellite box.
- 3 Connect an AV cable (not provided) to the **VIDEO** jack and **L** and **R AUDIO** jacks on your TV and to the AV and audio out jacks on the cable or satellite box.

Important

When you connect the audio using the **L** and **R AUDIO** jacks, the audio output is analog.

- 4 Plug your TV's power cord into a power outlet, turn on your TV, then turn on the cable or satellite box.
- 5 Press **INPUT** to open the *INPUT SOURCE* list.
- 6 Press **▲** or **▼** to highlight **AV**, then press **ENTER**.

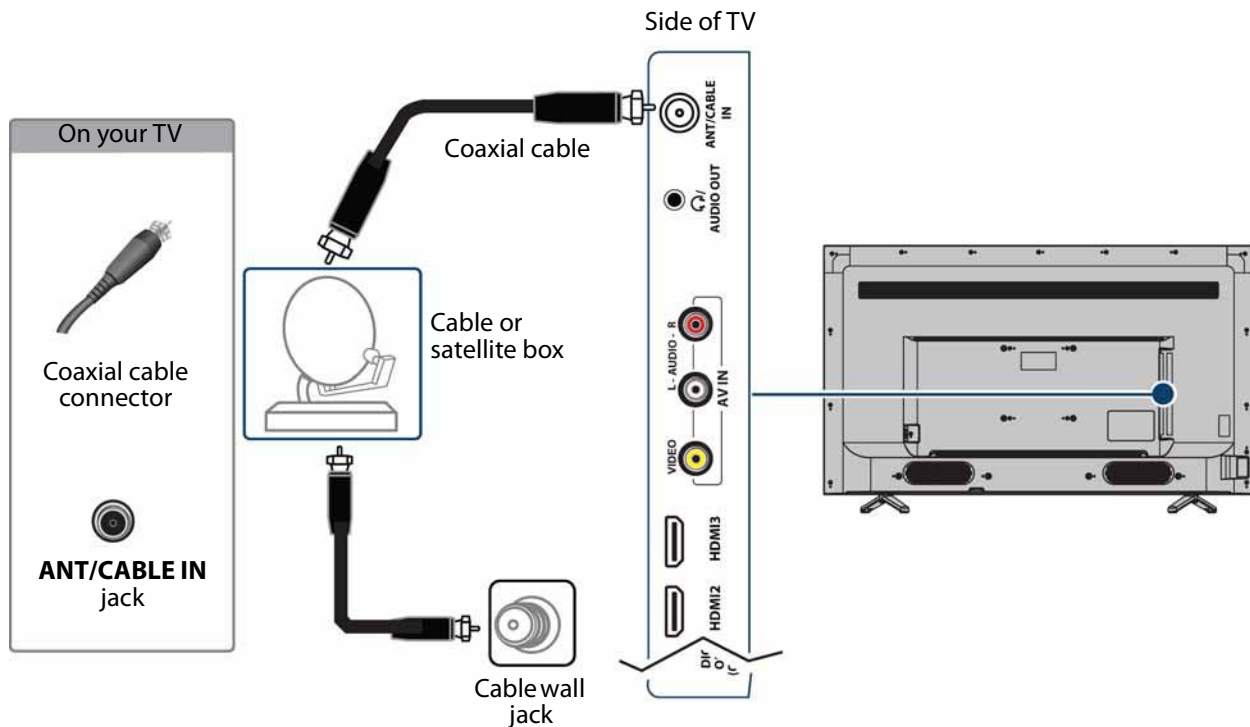
Coaxial (good)

- 1 Make sure that your TV's power cord is unplugged and all connected devices are turned off.
- 2 Connect the incoming cable from the cable wall jack to the cable-in jack on the cable or satellite box.
- 3 Connect a coaxial cable (not provided) to the **ANT/CABLE IN** jack on your TV and to the coaxial out jack on the cable or satellite box.
- 4 Plug your TV's power cord into a power outlet, turn on your TV, then turn on the cable or satellite box.
- 5 Press **INPUT** to open the *INPUT SOURCE* list.
- 6 Press **▲** or **▼** to highlight **TV**, then press **ENTER**.
- 7 If you cannot tune to channels you know exist, scan for channels. See [Automatically scanning for channels](#) on page 42.

Notes

- Use a coaxial cable to eliminate interference and noise from radio waves.
- Do not bundle the coaxial cable with the power cord or other cables.

Connecting an antenna or cable TV (no box)

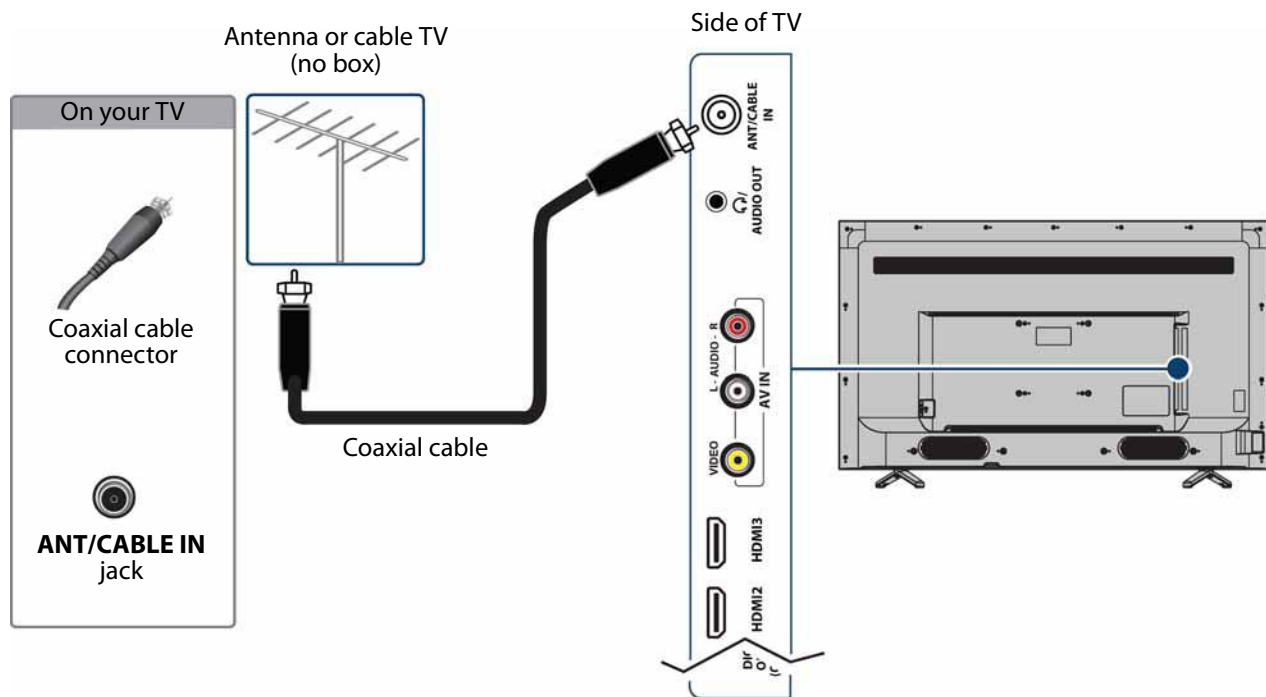

- 1 Make sure that your TV's power cord is unplugged and all connected devices are turned off.
- 2 Connect a coaxial cable (not provided) to the **ANT/CABLE IN** jack on your TV and to the antenna or cable TV wall jack.
- 3 Plug your TV's power cord into a power outlet, then turn on your TV.
- 4 Press **INPUT** to open the *INPUT SOURCE* list.
- 5 Press **▲** or **▼** to highlight **TV**, then press **ENTER**.
- 6 If you cannot tune to channels you know exist, scan for channels. See [Automatically scanning for channels](#) on page 42.

Notes

- Use a coaxial cable to eliminate interference and noise from radio waves.
- Do not bundle the coaxial cable with the power cord or other cables.
- If the antenna is not installed correctly, contact qualified service personnel to correct the problem.
- If the signal level for a channel is weak, the picture may be distorted. Adjust the antenna or use a highly directional outdoor or set-top antenna with a built-in amplifier.
- If the picture quality is good on some channels and poor on others, the problem may be caused by a poor or weak signal from the broadcaster or cable TV provider.
- If you connect to cable TV without a set-top box and experience poor picture quality, you may need to install a set-top box to improve signal reception and picture quality. Contact your cable TV provider about upgrading to a set-top box.
- Many high-definition (HD) channels upscale standard-definition (SD) content. The picture displayed on your TV is still displayed as SD, thus the picture quality will not be as clear or crisp as it would be if the content was originally recorded in HD.

Connecting a DVD or Blu-ray player

Many DVD or Blu-ray players have more than one connection type. To get the best video, you should use the best connection type available. For more information, see [What connection should I use?](#) on page 11.

You can connect a DVD or Blu-ray player using:

- [HDMI \(best\)](#)
- [AV \(good\)](#)

HDMI (best)

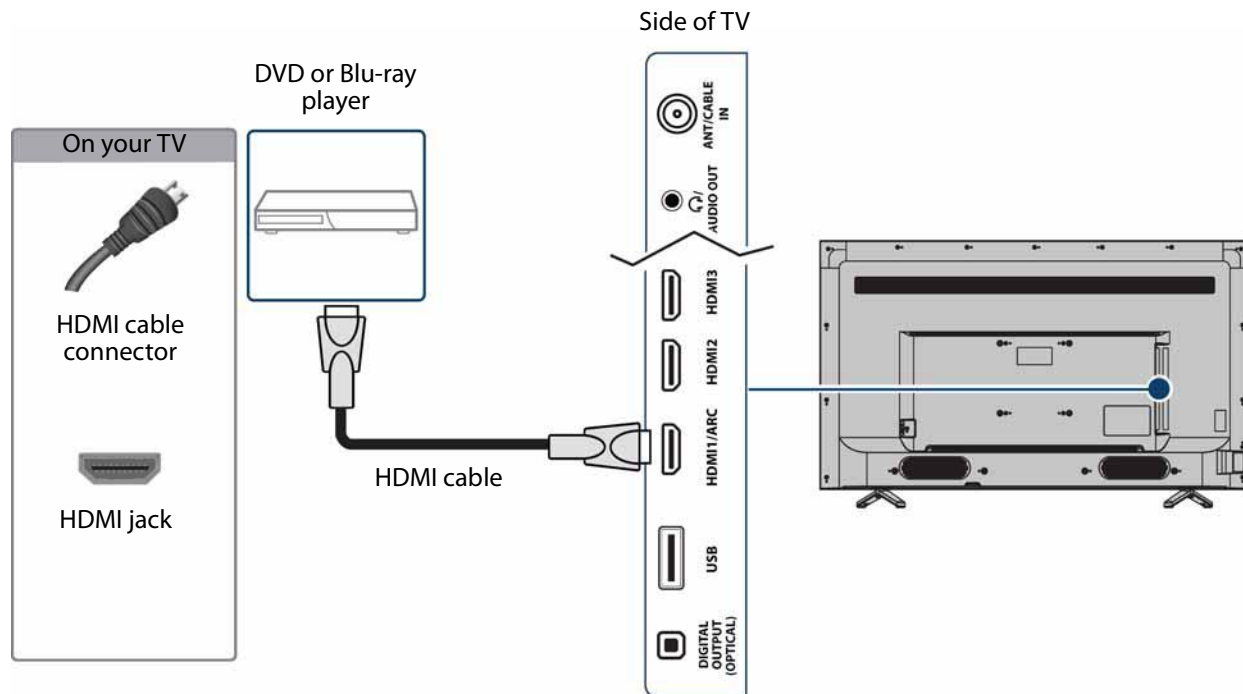

- 1 Make sure that your TV's power cord is unplugged and the DVD or Blu-ray player is turned off.
- 2 Connect an HDMI cable (not provided) to an **HDMI** jack on your TV and to the **HDMI OUT** jack on the DVD or Blu-ray player.
- 3 Plug your TV's power cord into a power outlet, then turn on your TV and DVD or Blu-ray player.
- 4 Press **INPUT** to open the *INPUT SOURCE* list.
- 5 Press **▲** or **▼** to highlight **HDMI1**, **HDMI2**, or **HDMI3**, then press **ENTER**.

Note

An HDMI cable carries both audio and video. You do not need to use any audio cables.

AV (good)

Notes

Cables are often color-coded to match color-coded jacks.

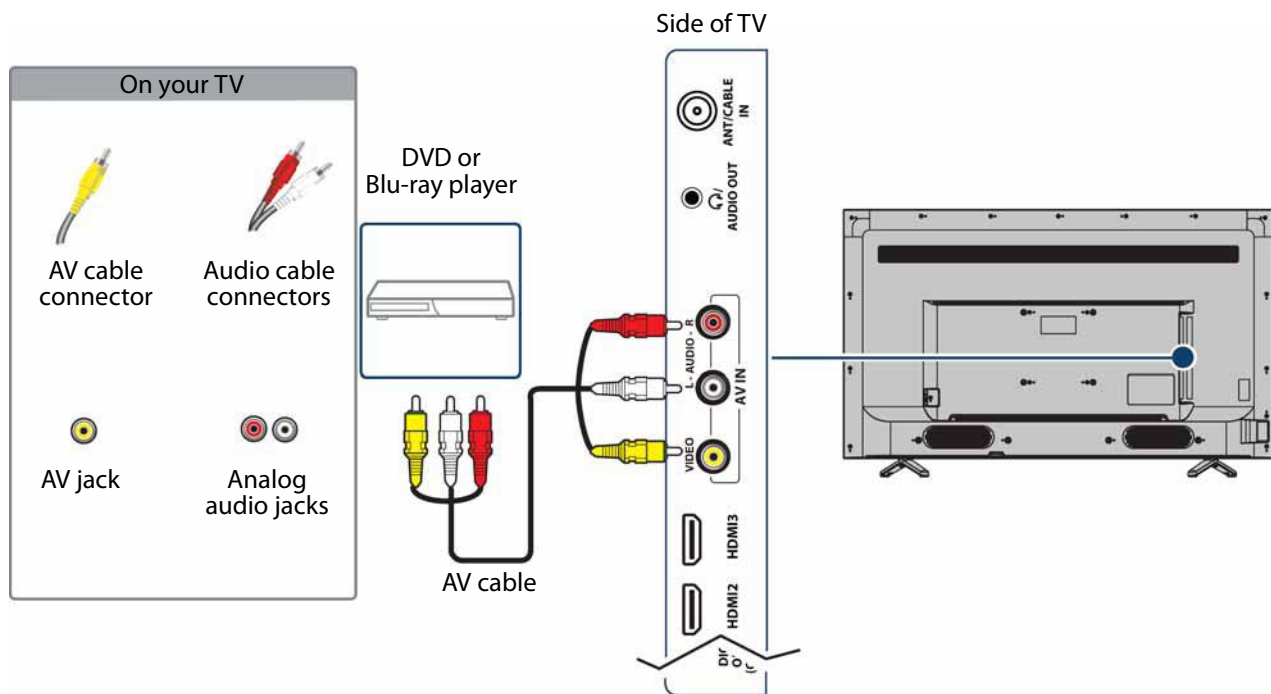

- 1 Make sure that your TV's power cord is unplugged and the DVD or Blu-ray player is turned off.
- 2 Connect an AV cable (not provided) to the **VIDEO** jack and **L** and **R AUDIO** jacks on your TV and to the **AV OUT** jacks on the DVD or Blu-ray player.

Important

When you connect the audio using the **L** and **R AUDIO** jacks, the audio output is analog.

- 3 Plug your TV's power cord into a power outlet, then turn on your TV and DVD or Blu-ray player.
- 4 Press **INPUT** to open the **INPUT SOURCE** list.
- 5 Press **▲** or **▼** to select **AV**, then press **ENTER**.

Connecting a game console

You can connect a game console using:

- HDMI (best)
- AV (good)

HDMI (best)

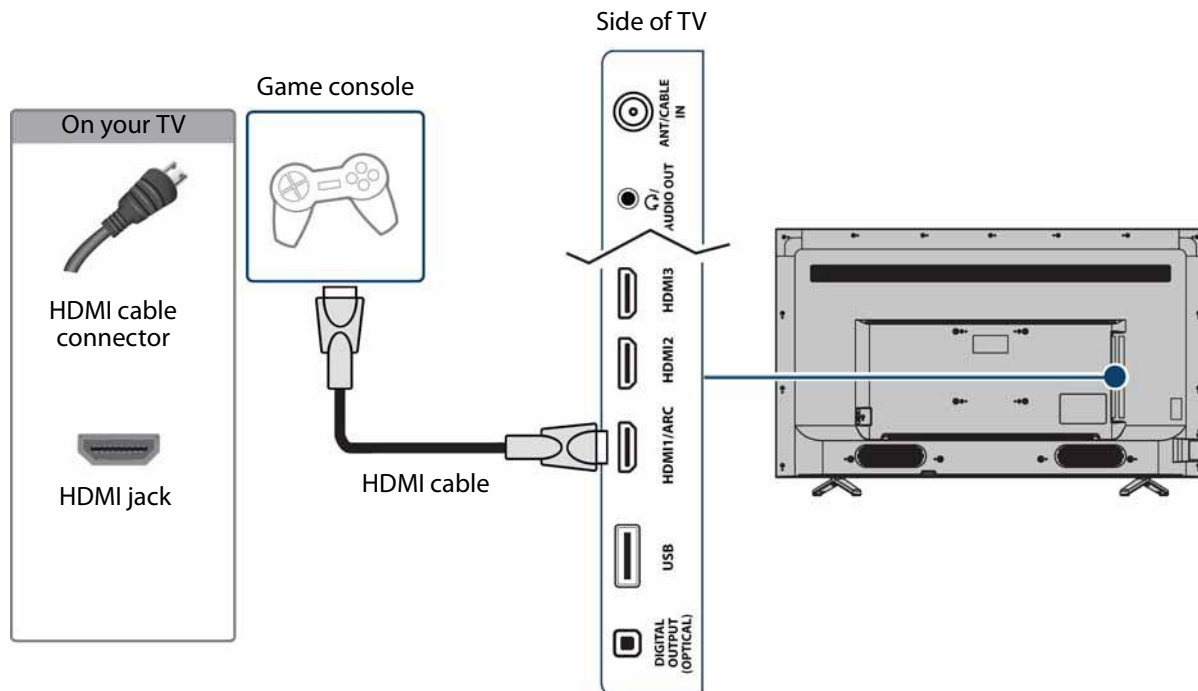

- 1 Make sure that your TV's power cord is unplugged and the game console is turned off.
- 2 Connect an HDMI cable (not provided) to an **HDMI** jack on your TV and to the **HDMI OUT** jack on the game console.
- 3 Plug your TV's power cord into a power outlet, then turn on your TV and the game console.
- 4 Press **INPUT** to open the *INPUT SOURCE* list.
- 5 Press **▲** or **▼** to highlight **HDMI1**, **HDMI2**, or **HDMI3**, then press **ENTER**.

Note

An HDMI cable carries both audio and video. You do not need to use any audio cables.

AV (good)

Notes

Cables are often color-coded to match color-coded jacks.

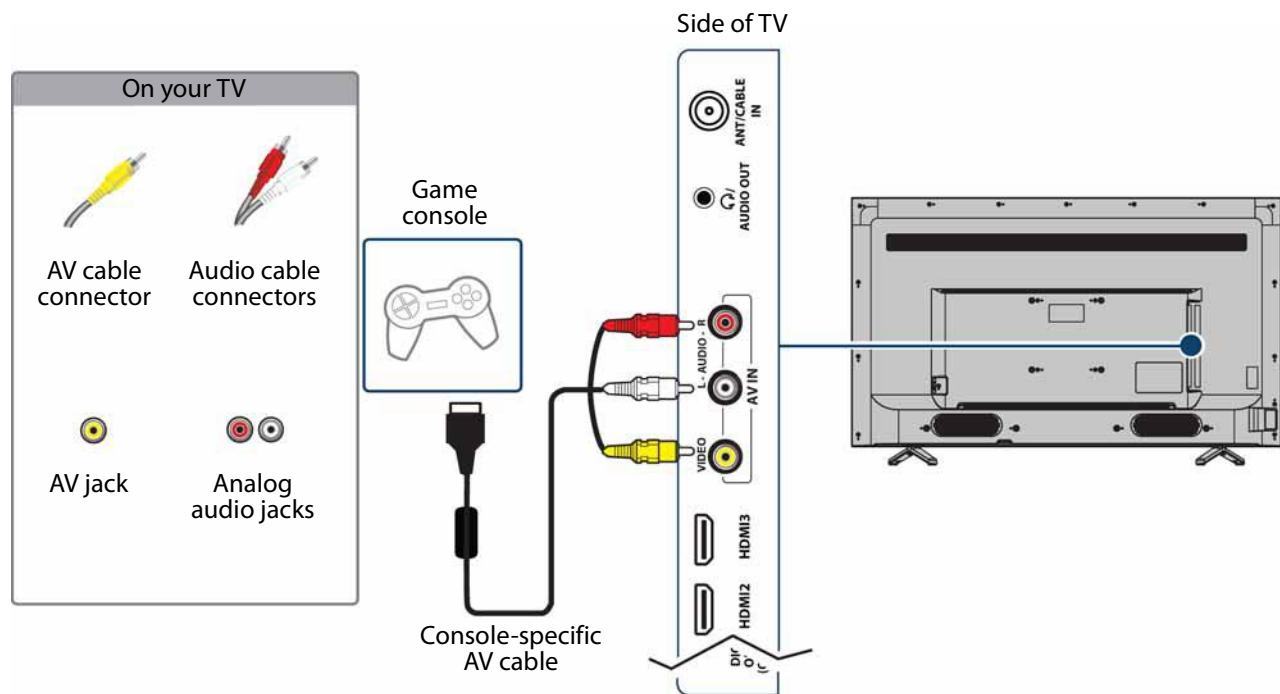

- 1 Make sure that your TV's power cord is unplugged and the game console is turned off.
- 2 Connect the video and audio connectors on the game console's AV cable (not provided) to the **VIDEO** jack and **L** and **R AUDIO** jacks on your TV and to the composite jack(s) on the game console.

Important

- Some older game consoles come with a special AV cable. See the documentation that came with your game console or check the manufacturer's website.
- When you connect the audio using the **L** and **R AUDIO** jacks, the audio output is analog.

- 3 Plug your TV's power cord into a power outlet, then turn on your TV and the game console.
- 4 Press **INPUT** to open the *INPUT SOURCE* list.
- 5 Press **▲** or **▼** to select **AV**, then press **ENTER**.

Connecting a computer

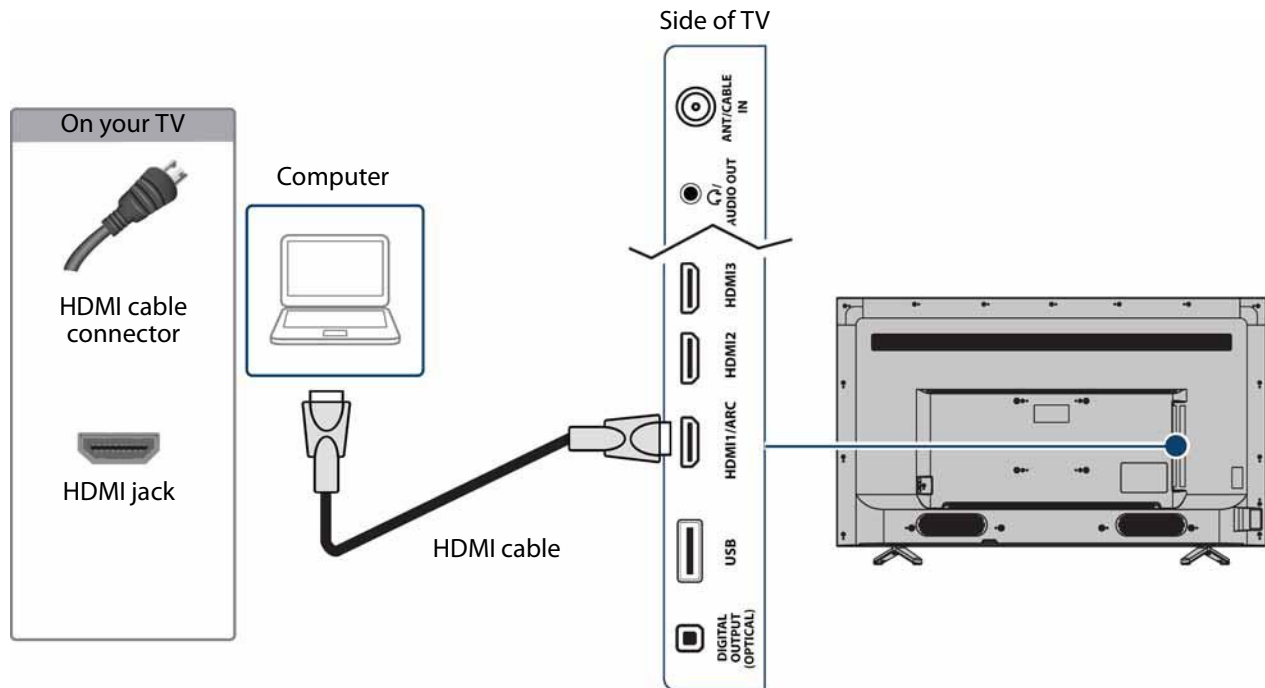

- 1 Make sure that your TV's power cord is unplugged and the computer is turned off.
- 2 Connect an HDMI cable (not provided) to an **HDMI** jack on your TV and to the **HDMI OUT** jack on the computer.
- 3 Plug your TV's power cord into a power outlet, then turn on your TV and the computer.
- 4 Press **INPUT** to open the *INPUT SOURCE* list.
- 5 Press **▲** or **▼** to highlight **HDMI1**, **HDMI2**, or **HDMI3**, then press **ENTER**.
- 6 Adjust the display properties on the computer, if necessary.

Connecting a USB flash drive

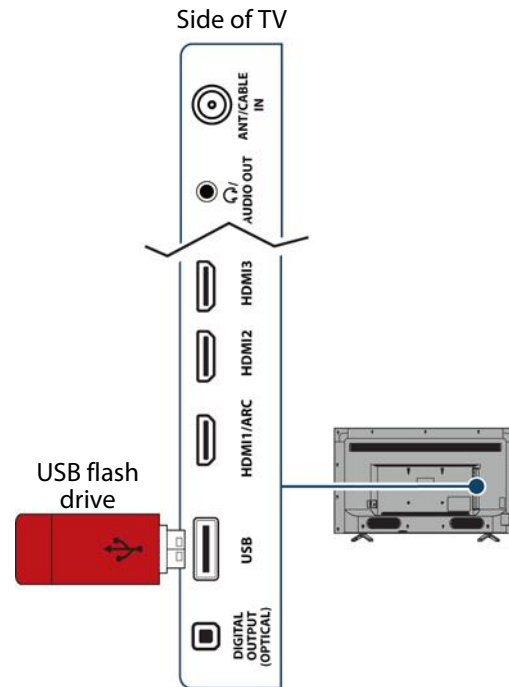

- 1 Plug a USB flash drive into the **USB** port on your TV.

Caution

Do not remove the USB flash drive or turn off the TV while using the USB flash drive. You may lose data or damage the USB flash drive.

- 2 Press **▲** or **▼** to select **Yes** in the message that appears. The *PHOTOS* menu opens.
OR

If you switch to a different video input source after you connect the USB flash drive and want to switch back to the drive, press **INPUT** to open the *INPUT SOURCE* list, press **▲** or **▼** to select **USB(Photos)**, then press **ENTER**. The *PHOTOS* menu opens.

Note

The **Photos** viewer only supports JPEG format images (with ".jpg" file extensions) and not all JPEG files are compatible with your TV. For more information, see [Using a USB flash drive](#) on page 37.

Connecting headphones

When you connect headphones, the TV speakers are muted.

Warning

Loud noise can damage your hearing. When using headphones, use the lowest volume setting on your headphones that still lets you hear the sound.

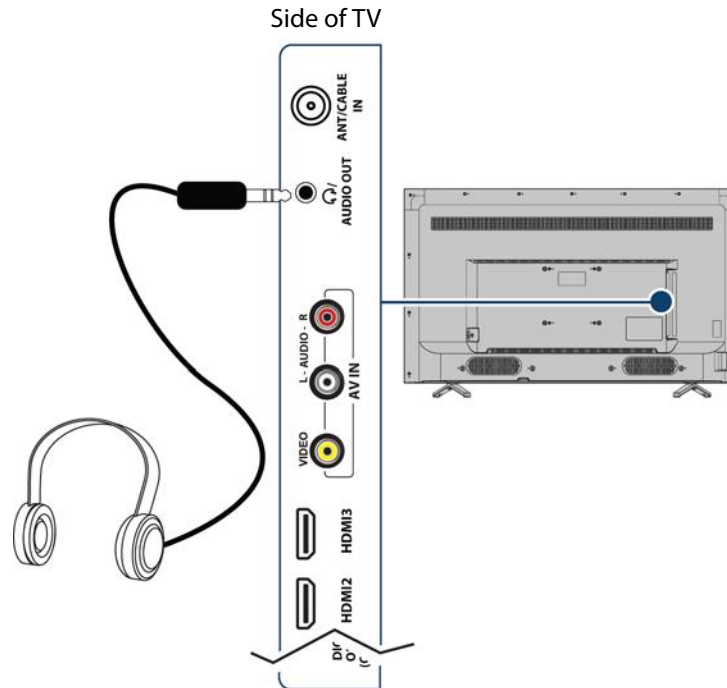

- 1 Connect the headphones to the /AUDIO OUT jack on your TV.
- 2 In the screen that opens, press or to highlight **Headphones / Audio Out Variable**, then press **ENTER**. For more information, see [Selecting the audio out mode](#) on page 42.

Notes

- If you connect headphones when your TV is turned off, then you turn on your TV, the TV speakers are muted and the audio plays through the headphones.
- You can also connect a home theater system, soundbar, or external speaker system to the /AUDIO OUT jack.

Connecting external speakers or a soundbar

You can connect external speakers using:

- Digital audio
- Analog audio

Digital audio

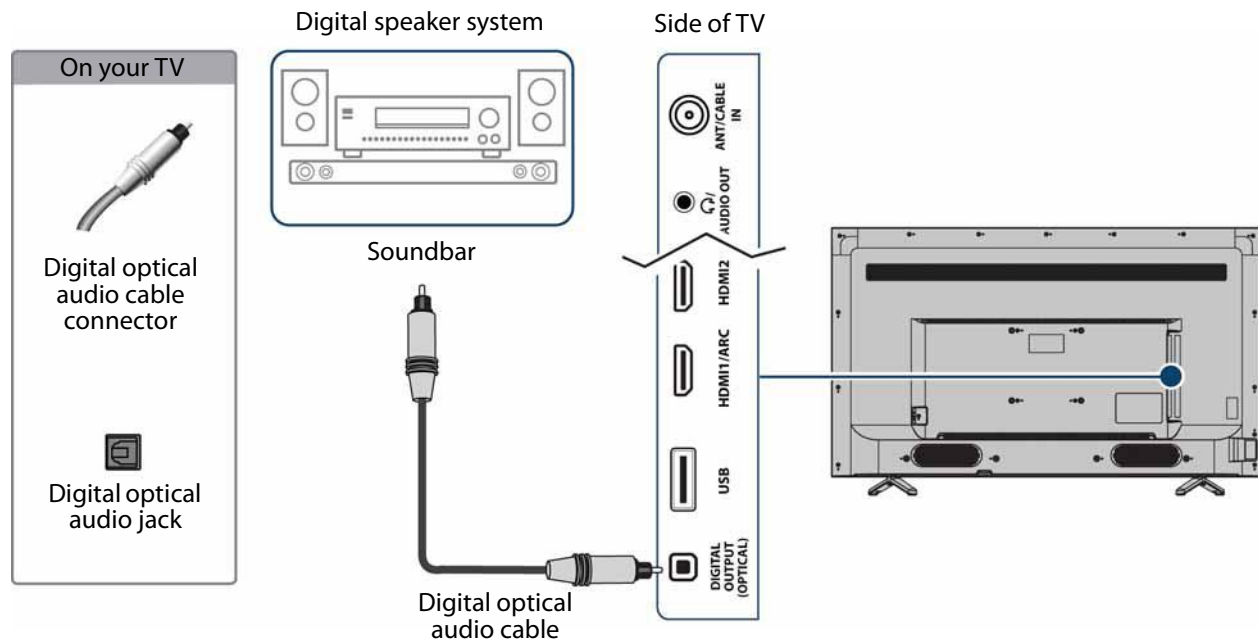



- 1 Make sure that your TV's power cord is unplugged and the digital speaker system or soundbar is turned off.
- 2 Connect a digital optical audio cable (not provided) to the **DIGITAL OUTPUT (OPTICAL)** jack on your TV and to the optical **AUDIO IN** jack on the digital speaker system or soundbar.
- 3 Plug your TV's power cord into a power outlet, then turn on your TV.
- 4 Turn on the digital speaker system or soundbar, then set it to the correct source. For more information, see the documentation that came with the digital speaker system or soundbar.
- 5 On your TV's *Audio* menu, highlight **Digital Audio Format/Audio Delay**, then press **ENTER** or **▶**. Set the **Audio Format** option to **PCM**. See the **Digital Audio Format/Audio Delay** option in [Adjusting sound settings](#) on page 40.

Analog audio

Note

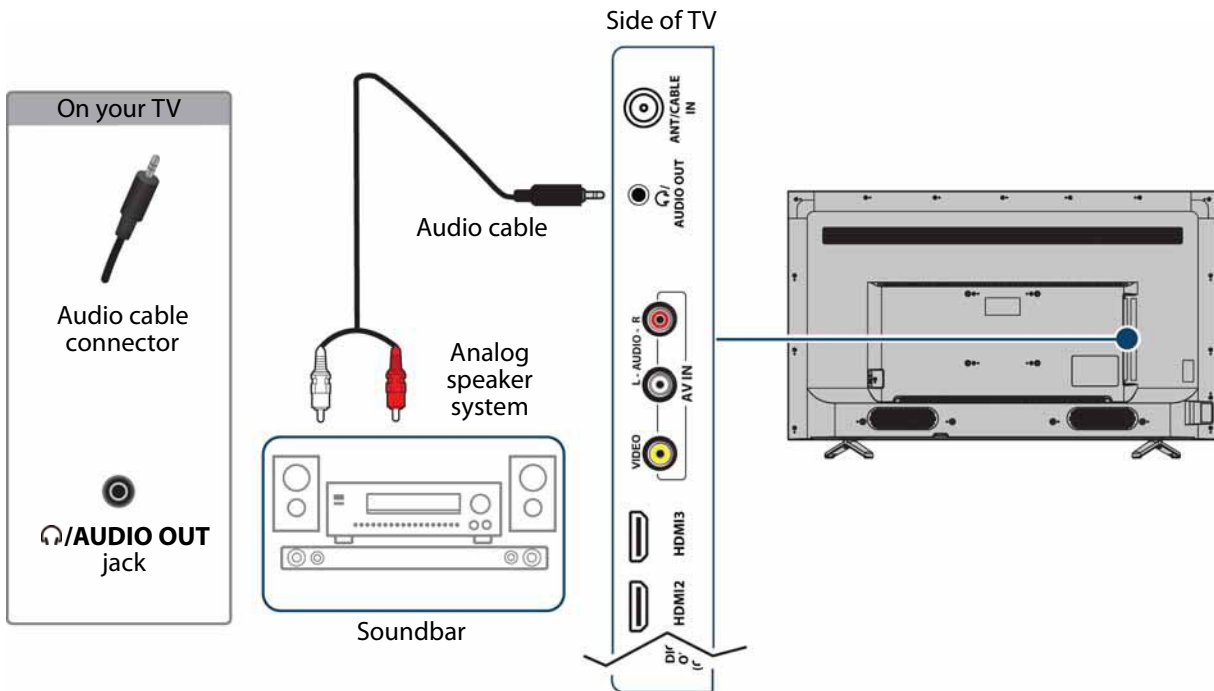
When you connect an analog system or soundbar to the /AUDIO OUT jack, the TV speakers are muted.



- 1 Make sure that your TV's power cord is unplugged and the analog speaker system or soundbar is turned off.
- 2 Connect an audio cable (not provided) to the /AUDIO OUT jack on your TV and to the **AUDIO IN** jacks on the analog speaker system or soundbar.
- 3 Plug your TV's power cord into a power outlet, then turn on your TV.
- 4 Turn on the analog speaker system or soundbar, then set it to the correct source. For more information, see the documentation that came with the analog speaker system or soundbar.
- 5 On your TV, set the **Headphone / Audio Out** option on the *Audio* menu to **Headphones / Audio Out Variable** or **Audio Out Fixed**. See the **Headphone / Audio Out** option in [Adjusting sound settings](#) on page 40.

Connecting a home theater system with multiple devices

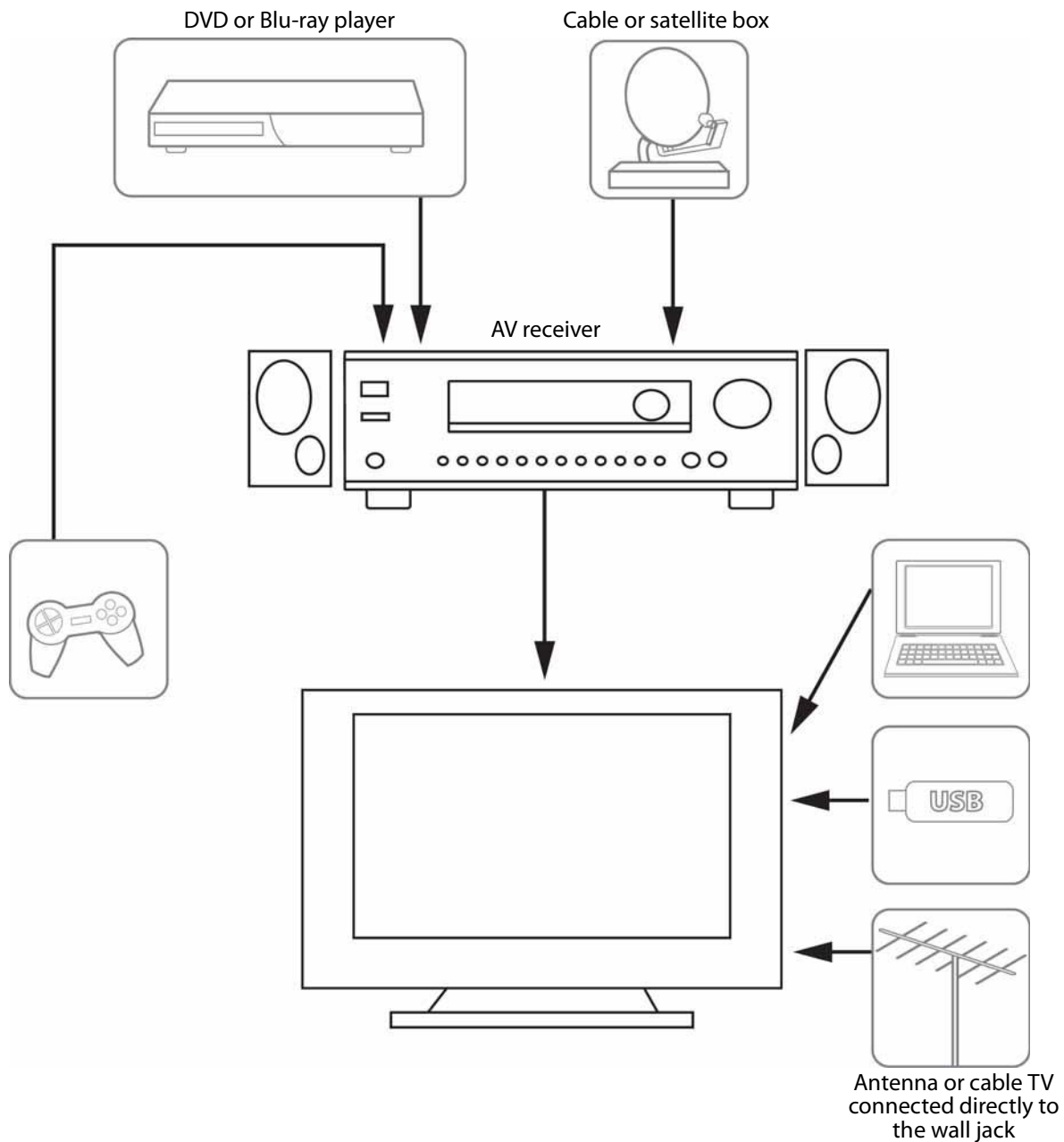

The connections you make depend on the video and audio jacks available on your devices. Refer to the documentation that came with your devices for connection information.

Just remember to use the best connection types available for the best picture and sound. For information about connection types, see [What connection should I use?](#) on page 11.

Connecting power

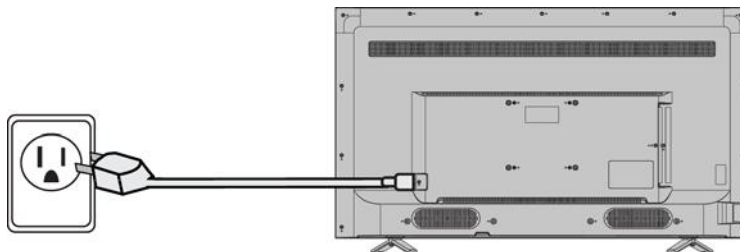

- 1 Connect one end of the power cord to the power connector on the back of your TV.
- 2 Connect the other end of the cord to a power outlet.

Caution

- Your TV should only be operated from the power source indicated on the label.
- Always unplug the power cord from the power outlet when you will not be using your TV for an extended period of time.

Using the remote control

This section covers:

- [Installing remote control batteries](#)
- [Aiming the remote control](#)
- [Programming universal remote controls](#)
- [Viewing universal remote control codes](#)

Installing remote control batteries

- 1 While pressing the release latch on the back of the remote control, lift the battery compartment cover off of the remote control.

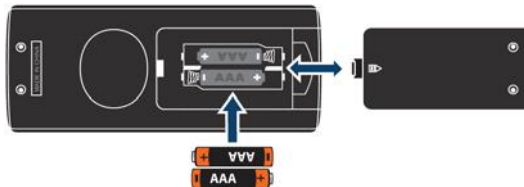

- 2 Insert two AAA batteries into the battery compartment. Make sure that you match the + and - symbols on the batteries with the + and - symbols in the battery compartment.
- 3 Replace the battery compartment cover.

Cautions

- Batteries should not be exposed to excessive heat, such as sunshine, heat registers, or fire.
- Battery chemicals can cause a rash. If the batteries leak, clean the battery compartment with a cloth. If chemicals touch your skin, wash immediately.
- Make sure that batteries are disposed of correctly. Do not burn or incinerate.

Notes

- Do not mix batteries of different types.
- Do not mix old and new batteries.
- Remove batteries when the charge is depleted.
- If the remote control is not going to be used for an extended period of time, remove the batteries.

Aiming the remote control

- Point the remote control towards the remote sensor on the front of your TV.

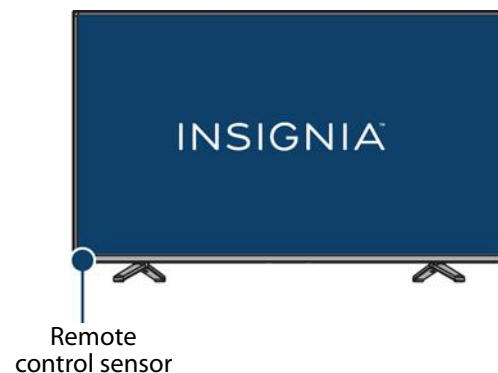

Programming universal remote controls

You can operate your Insignia TV with a new or existing universal remote control.

- 1 See [Viewing universal remote control codes](#) on page 28 for common codes. If you have problems programming your remote or need a different remote control code:
 - Contact the universal remote control or cable/satellite company of the remote control you are trying to program.
 - Visit www.insigniaproducts.com/remotecodes for the latest remote control code information.
 - Call the Insignia Customer Care Center at 1-877-467-4289.
- 2 Follow your universal remote control's instructions to enter the TV code you found in Step 1.

Tips

- If your universal remote control has a code search feature, run a code search to identify a code that matches your TV. See your universal remote control's instructions for details.
- If your universal remote control has a "Learn" feature, you can manually program it using the Insignia TV remote to "teach" the commands one at a time. See your universal remote control's instructions for details.

Viewing universal remote control codes

You can view a list of universal remote control codes in the on-screen menu.

Tips

- The brand name is often visible on the front of the universal remote control, and the model number is often visible on the back.
- If your universal remote control isn't listed on the chart, refer to your universal remote control's instructions and try codes for the brands Orion, Emerson, Memorex, Sansui, Sylvania, or Zenith. You may need to try several codes before finding a match.

- 1 Press **MENU**.
- 2 Press **◀** or **▶** to highlight **HELP**, then press **▼** or **ENTER**.



- 3 Press **▲** or **▼** to highlight **Learn More**, then press **ENTER**.
- 4 Press **▲** or **▼** to highlight **Remote control codes**, then press **ENTER**. Your TV displays information about the universal remote codes that you can use to make your TV work with a universal remote.
- 5 Press **ENTER** or **▶**. Your TV displays a list of remote control codes for various brands of universal remote controls.
- 6 Press **MENU** to return to the previous menu, or press **EXIT** to close the menu.

Note:

You can also find codes for other remote controls at: <http://www.insigniaproducts.com/remotecodes>
Or, check with your cable or satellite TV provider for the remote control code.

Turning on your TV for the first time

The first time you turn on your TV, the *Easy Setup* wizard opens. The wizard guides you through setting up basic settings including the menu language, time setting, picture mode, TV signal source, and the channel list.

- 1 Make sure that you have:
 - Installed the remote control batteries. (See page 27.)
 - Connected an antenna, cable TV, or satellite TV. (See page 12 through 15.)
 - Connected the power cord. (See page 26.)
- 2 Press **⏻** (power) to turn on your TV. The *Easy Setup* wizard begins.



- 3 Press **▲** or **▼** to highlight a language, then press **ENTER**.

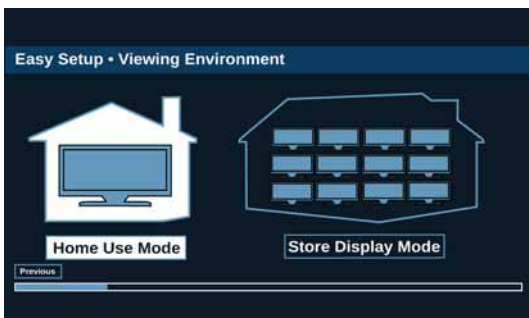

- 4 Press **◀** or **▶** to highlight **Home Use Mode** or **Store Display Mode**, then press **ENTER**.
If you selected **Store Display Mode**, a message asks if you are sure you want this mode. Select **OK** to continue using **Store Display Mode**, or select **Cancel** to automatically change to **Home Use Mode**. **Store Display Mode** is not an energy savings mode and displays a retail banner.



- 5 Press **◀** or **▶** to highlight an option, then press **ENTER**. You can select:
 - **Watch TV** to skip the customization options. You can press **MENU** later to customize settings. Go to [Finish the wizard](#) on page 30.
 - **Customize my TV** to set viewing options to maximize your viewing experience. Go to [Customize my TV](#) on page 29.

Customize my TV



- 6 Press **▲** or **▼** to highlight a time zone, then press **ENTER**.

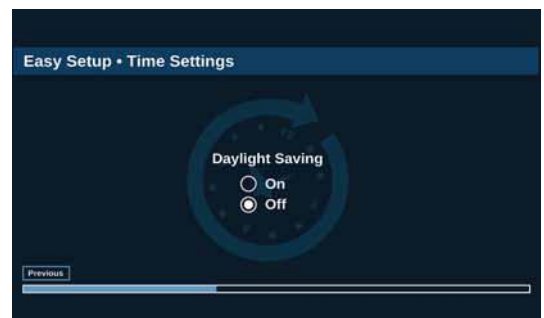

- 7 Press ▲ or ▼ to select **On** (if your viewing area observes Daylight Saving Time) or **Off** (if your viewing area does not observe Daylight Saving Time), then press **ENTER**.

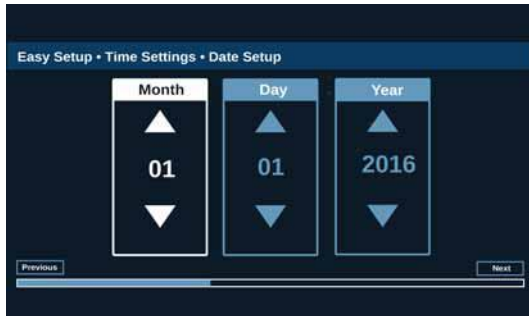

- 8 Press ◀ or ▶ to highlight **Month**, **Day**, or **Year**, press ▲ or ▼ to adjust the setting. When you have finished setting the date, press **ENTER** one or more times to highlight **Next**, then press **ENTER** again.

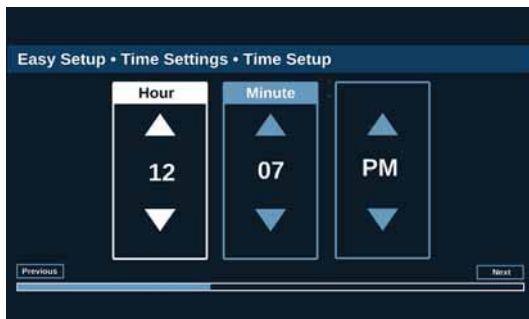

- 9 Press ◀ or ▶ to highlight **Hour**, **Minute**, or the **AM/PM** field, press ▲ or ▼ to adjust the setting. When you have finished setting the time, press **ENTER** one or more times to highlight **Next**, then press **ENTER** again.

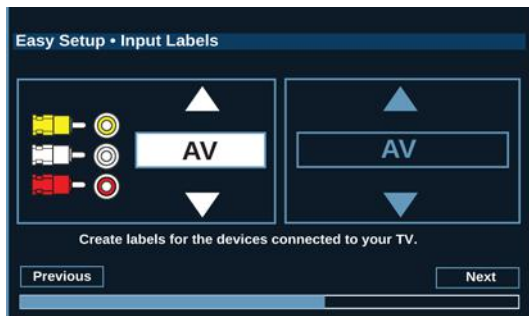

- 10 Press ▲ or ▼ to highlight a video input source, then press ▶ to move to the label area.
11 Press ▲ or ▼ to highlight a preset label or **Custom**.

- 12 If you select a preset label, press ▶ to highlight **Next**, then press **ENTER**.

OR

If you select **Custom**, press **ENTER**, then press ▲ or ▼ to enter the first character in your custom label. Press ◀ or ▶ to move to the previous or next character position. Use the arrow buttons to enter additional characters. You can enter 12 characters (letters or numbers). When you have finished creating your label, press **ENTER** to save it. Press ▶ twice to highlight **Next**, then press **ENTER** again. Your custom label appears on the **INPUT SOURCE** list when you press **INPUT**.

Finish the wizard

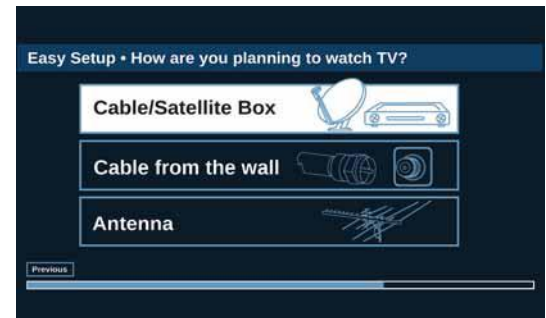

- 13 Press ▲ or ▼ to highlight **Cable/Satellite Box**, **Cable from the wall**, or **Antenna**, then press **ENTER**.
- If you select **Cable/Satellite Box**, a screen opens that shows you the ways you can connect the box.

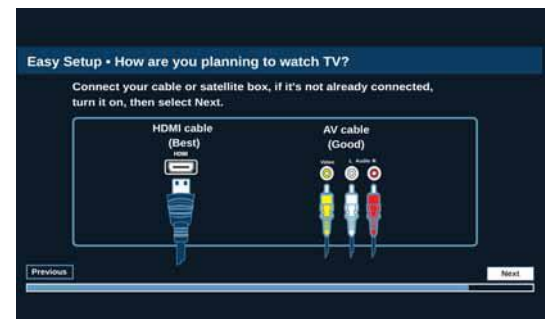

Press **ENTER**.



- If you select **Cable from the wall** or **Antenna**, your TV starts scanning for channels and displays a progress screen.

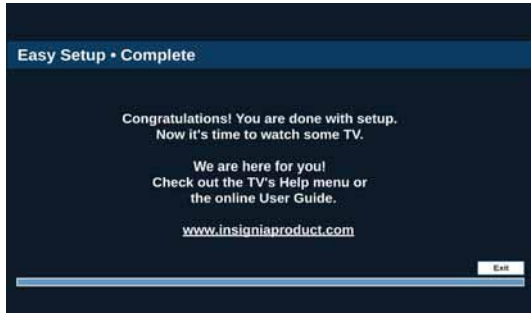

Note

You can press **EXIT** to stop the auto channel search, but you will need to run the auto channel search again to create a channel list.

- 14 Press **ENTER** to close the wizard. If you selected:
- **Cable from the wall** or **Antenna**, your TV tunes to the first channel it found in the scan.
 - **Cable/Satellite box**, press **INPUT** to open the *INPUT SOURCE* list, press **▲** or **▼** to select the video input (**HDMI** or **AV**) you connected the box to, then press **ENTER**. Your TV switches to the input you selected.

Understanding the basics

This section covers basic information for:

- [Turning your TV on or off](#)
- [Selecting the video input source](#)
- [On-screen menu overview](#)
- [Navigating the menus](#)
- [Selecting a channel](#)
- [Adjusting the volume](#)
- [Viewing channel information](#)

Turning your TV on or off

- 1 Make sure that the power cord is connected to a power outlet.
- 2 Press **⏻** (power) to turn on your TV. The power indicator turns off.
- 3 Press **⏻** (power) again to turn off your TV. Your TV enters standby mode, and the power indicator turns red.

Warning

When your TV is in standby mode, it is still receiving power. To completely disconnect power, unplug the power cord.

Note

If your TV does not receive an input signal for several minutes, it automatically goes into standby mode.

Selecting the video input source

Note

Your TV automatically detects and displays which video jacks have devices connected to them when the devices are turned on. You can turn this feature off to always display all inputs. For more information, see [Turning Input Sensor on or off](#) on page 54.

- 1 Turn on your TV.
- 2 If you want to use a device connected to a video input (such as a DVD or Blu-ray player), turn on the device.
- 3 Press **INPUT**.



- 4 Press **▲** or **▼** to select a video input source, then press **ENTER**.

On-screen menu overview

Notes

- Depending on the signal source selected, you may see different options on your screen.
- Menu items that are not selectable are grayed out.

Picture menu (TV mode)



Audio menu (TV mode)

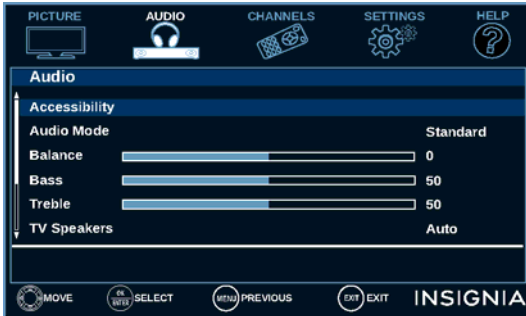

Channels menu (TV mode)

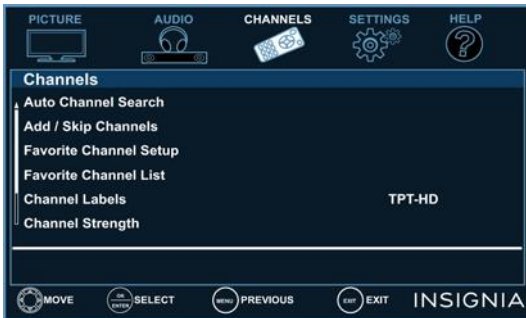

Settings menu (TV mode)



Help menu



PHOTOS menu (USB mode)



Navigating the menus

Note

To turn on audio narration for menus, see Adjusting sound settings on page 40.

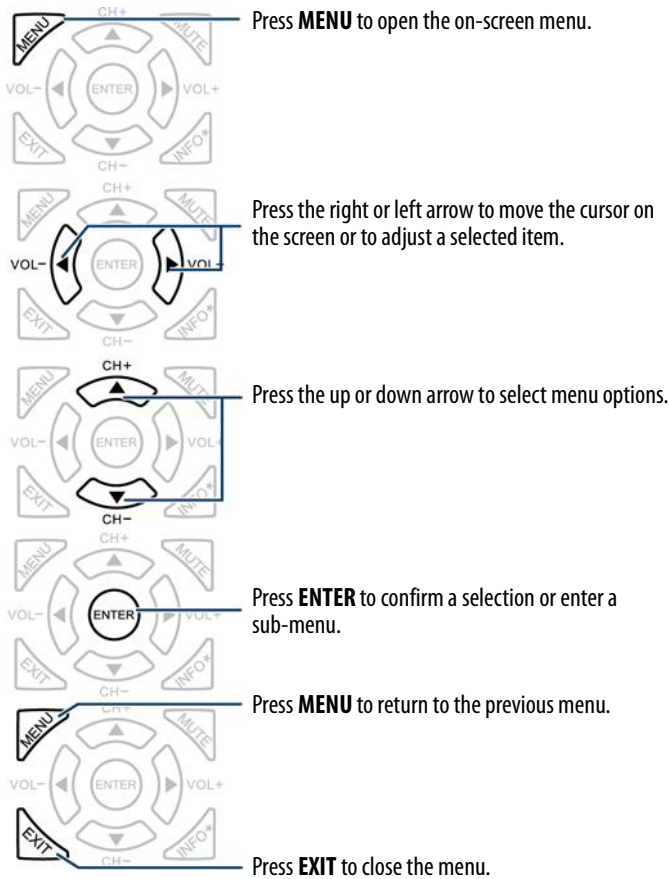

Selecting a channel

- Press **CH+** or **CH-** to go to the next or previous channel on the memorized channel list.
- Press the number buttons to enter the channel number you want, then wait for the channel to change or press **ENTER** to immediately change the channel.
- To select a digital sub-channel, press the number buttons to select the main digital channel, press **■** (sub-channel), then press the number button for the sub-channel. Wait for the channel to change, or press **ENTER** to immediately change the channel. For example, to tune to channel 5.1, press **5**, **■** (sub-channel), then **1**.

Note

Button presses must be within three seconds of each other.

- Press **↶** (return) to go to the last viewed channel.

Adjusting the volume

- Press **VOL+** or **VOL-** to increase or decrease the volume.
- Press **MUTE** to turn off the sound. Press **MUTE** again to turn the sound back on.

Viewing channel information

- Press **INFO*** to view an information banner. The information banner shows the current program information such as channel number, video input source, and resolution.
 - Digital channel information—Displays the channel number, station name, channel label, broadcast program name, TV rating, signal type, audio information, resolution, current time, signal strength, day of the week, date and current program start and end times, if provided by the broadcaster.
 - Analog channel information—Displays channel number, channel label (if present), signal type, audio information, day of the week, and date, if provided by the broadcaster.

Using INlink

INlink lets you control HDMI CEC-compatible devices connected to the HDMI jacks on your TV using the remote control that came with your TV.

Note

After you switch to an INlink device, use the remote control that came with the device to control playback.

To use INlink, you must set the **INlink Control** setting on the *INlink* menu to **On**.

Notes

- HDMI cables must be used to connect HDMI CEC-compatible devices to your TV.
- The connected device's HDMI CEC feature must be turned on.
- If you connect an HDMI device that is not HDMI CEC-compatible, none of the **INlink Control** features work.
- Depending on the connected HDMI device, some **INlink Control** features may not work.

This section covers:

- [Turning INlink on or off](#)
- [Turning Device Auto Power Off on or off](#)
- [Turning TV Auto Power On on or off](#)
- [Turning Audio Receiver on or off](#)
- [Displaying a list of INlink-compatible devices](#)
- [Selecting an INlink-compatible device](#)

Turning INlink on or off

- 1 Press **MENU**.
- 2 Press **◀** or **▶** to highlight **SETTINGS**, then press **▼** or **ENTER**.



- 3 Press **▲** or **▼** to highlight **INlink**, then press **ENTER** or **▶**.



- 4 Press **▲** or **▼** to highlight **INlink Control**, then press **ENTER** or **▶**.
- 5 Press **▲** or **▼** to highlight **On** or **Off**, then press **ENTER**.
- 6 Press **MENU** to return to the previous menu, or press **EXIT** to close the menu.

Turning Device Auto Power Off on or off

When INlink is set to **On**, **Device Auto Power Off** automatically turns off HDMI CEC devices when you turn off your TV.

- 1 Press **MENU**.
- 2 Press **◀** or **▶** to highlight **SETTINGS**, then press **▼** or **ENTER**.



- 3 Press **▲** or **▼** to highlight **INlink**, then press **ENTER** or **▶**.



- 4 Press **▲** or **▼** to highlight **Device Auto Power Off**, then press **ENTER** or **▶**.
- 5 Press **▲** or **▼** to highlight **On** (turns off the connected devices when you turn off your TV) or **Off** (does not turn off the connected devices when you turn off your TV), then press **ENTER**.
- 6 Press **MENU** to return to the previous menu, or press **EXIT** to close the menu.

Turning TV Auto Power On on or off

TV Auto Power On automatically turns on your TV when an HDMI CEC device is turned on, if the device has this feature.

- 1 Press **MENU**.
- 2 Press **◀** or **▶** to highlight **SETTINGS**, then press **▼** or **ENTER**.



- 3 Press **▲** or **▼** to highlight **INlink**, then press **ENTER** or **▶**.



- 4 Press **▲** or **▼** to highlight **TV Auto Power On**, then press **ENTER** or **▶**.
- 5 Press **▲** or **▼** to highlight **On** (turns on your TV when you turn on the connected device) or **Off** (does not turn on your TV when you turn on the connected device), then press **ENTER**.
- 6 Press **MENU** to return to the previous menu, or press **EXIT** to close the menu.

Turning Audio Receiver on or off

When INlink is turned on and you have connected an HDMI CEC-compatible audio receiver to your TV, turning on **Audio Receiver** lets you use your TV's remote control to control the volume on the audio receiver.

- 1 Press **MENU**.
- 2 Press **◀** or **▶** to highlight **SETTINGS**, then press **▼** or **ENTER**.



- 3 Press **▲** or **▼** to highlight **INlink**, then press **ENTER** or **▶**.



- 4 Press **▲** or **▼** to highlight **Audio Receiver**, then press **ENTER** or **▶**.
- 5 Press **▲** or **▼** to highlight **On** (your TV's remote control controls the connected audio receiver's volume) or **Off** (your TV's remote control does not control the connected audio receiver's volume), then press **ENTER**.
- 6 Press **MENU** to return to the previous menu, or press **EXIT** to close the menu.

Displaying a list of INlink-compatible devices

You can display a list of HDMI CEC devices that are connected to your TV.

- 1 Press **MENU**.
- 2 Press **◀** or **▶** to highlight **SETTINGS**, then press **▼** or **ENTER**.



- 3 Press **▲** or **▼** to highlight **INlink**, then press **ENTER** or **▶**.



- 4 Press **▲** or **▼** to highlight **INlink Device List**, then press **ENTER** or **▶**. A list of the HDMI CEC-compatible devices you have connected opens.
- 5 Press **MENU** to return to the previous menu, or press **EXIT** to close the menu.

Selecting an INlink-compatible device

When you have more than one INlink-compatible device connected, you can select the device you want to use.

- 1 Press **MENU**.
- 2 Press **◀** or **▶** to highlight **SETTINGS**, then press **▼** or **ENTER**.



- 3 Press **▲** or **▼** to highlight **INlink**, then press **ENTER** or **▶**.



- 4 Press **▲** or **▼** to highlight **Connect**, then press **ENTER** or **▶**. A list of HDMI CEC-compatible devices you have connected opens.
- 5 Press **▲** or **▼** to highlight the device you want to connect to, then press **ENTER**.
- 6 Press **MENU** to return to the previous menu, or press **EXIT** to close the menu.

Using a USB flash drive

You can connect a USB flash drive to your TV to view compatible JPEG pictures.

Notes

- Never remove the USB flash drive or turn off your TV while viewing JPEG pictures.
- The JPEG picture viewer only supports JPEG format images (with ".jpg" file extensions) and not all JPEG files are compatible with your TV.

This section covers:

- [Switching to USB mode](#)
- [Browsing photos](#)
- [Viewing photos in a slideshow](#)

Switching to USB mode

- 1 Make sure that you have connected the USB flash drive to the USB port on your TV.
- 2 Press **▲** or **▼** to highlight **Yes** in the message that appears, then press **ENTER**.
OR

If you connected the USB flash drive, then changed to a different video input source, press **INPUT** to open the *INPUT SOURCE* list, press **▲** or **▼** to highlight **USB(Photos)**, then press **ENTER**.

Note

To exit USB mode, press **INPUT** to open the *INPUT SOURCE* list, then select another input source.

Browsing photos

- 1 Switch to USB mode. See [Switching to USB mode](#) on page 37.

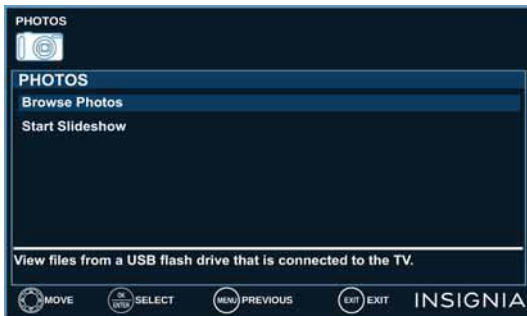

- 2 Press **▲** or **▼** to highlight **Browse Photos**, then press **ENTER** or **▶**. The screen displays folder names and photo files stored on the USB flash drive in a thumbnail index with the first folder or file highlighted. A control bar appears at the bottom of the screen.

Note

Photos are shown in the order they appear on the USB flash drive. They may not be listed in file name order.



- 3 To navigate the thumbnail index screen, press:
 - **▲ ▼ ◀ ▶** to browse through the files and folders.
 - **ENTER** to view a highlighted photo full-screen or open a highlighted folder.
 - **MENU** or **EXIT** to open the *PHOTOS* menu.

When a photo is displayed full-screen, a control bar appears at the bottom of the photo. The file name, picture resolution, size, and date are displayed on the bottom of the control bar. If you do not press a button within 8 seconds, the control bar closes. Press **INFO*** to open the control bar again.



- 4 To navigate on the photo screen, press:
 - **◀** to go to the previous photo.
 - **▶** to go to the next photo.
 - **ENTER** to rotate the photo clockwise.
 - **CCD** one or more times to enlarge the image by 2x, or 4x or to select **Fill** (to fill the screen). You can press **▲ ▼ ◀ ▶** to pan the photo.
 - **EXIT** to return to the thumbnail index.
 - **MENU** to return to the *PHOTOS* menu.

Viewing photos in a slideshow

You can view your photos in a slideshow.

- 1 Switch to USB mode. See [Switching to USB mode](#) on page 37.
- 2 If the photos you want to view are in a folder on the USB flash drive, select the folder. For information about selecting a folder, see [Browsing photos](#) on page 37.
- 3 Press **MENU**.



- 4 Press **▲** or **▼** to highlight **Start Slideshow**, then press **ENTER** or **▶**. A slideshow starts with the first photo in the current folder.
- 5 To control the slideshow:

Press...	To...
MENU	Open the <i>PHOTOS</i> menu.
ENTER	Pause the slideshow. Press again to resume the slideshow.
EXIT	Stop the slideshow and return to the thumbnail index.

- 2 Press **▼** or **ENTER** to access the menu.
- 3 Press **▲** or **▼** to highlight an option, then press **ENTER** or **▶** to access the option. You can select:
 - **Picture Mode**—Selects the picture mode. You can select:
 - **Vivid**—(a bright and vivid picture). Significantly increases the contrast, brightness, and sharpness. This selection is good for video games, animation, and in bright light environments.
 - **Standard**—(a standard picture). Moderately increases the contrast, brightness, and sharpness. This selection is good for standard TV broadcasts.
 - **Energy Savings**—(the backlight brightness is decreased). Your TV has a backlight that provides light for displaying a picture. By reducing the amount of light, your TV uses less energy.
 - **Movie**—(a finely detailed picture). Adjusts the brightness and contrast and lowers the sharpness for a more realistic picture. This selection is good for watching the highest quality video such as Blu-ray Discs, DVDs, and HDTV.
 - **Game**—Adjusts the picture for the ultimate gaming experience.

Note

- You can also press **GAME** to select game mode.
- **Game** is only available when the video input is set to **HDMI** or **AV**.

- **Custom**—(customized picture). Lets you manually adjust picture settings such as brightness, contrast, and sharpness.

Note

You can also press **PICTURE** to select the picture mode.

- **Advanced Settings**—Opens the *Advanced Settings* menu where you can adjust additional video options.



Adjusting the picture

This section covers:

- [Adjusting the TV picture](#)
- [Automatically adjusting the aspect ratio](#)
- [Setting the power on picture mode](#)





Adjusting the TV picture

You can adjust various settings to improve the quality of the TV picture. Also, you can reset all picture settings to the factory default.

- 1 Press **MENU**.



- **Aspect Ratio**—Adjusts how the picture fills the screen. You can select:

Aspect ratio options	Example
<p>Normal: Displays the image in the original aspect ratio. You may see black bars if the original content is not widescreen (16:9).</p>	
<p>Zoom: Expands the image to fill the screen. The top and bottom of the image may be cropped.</p>	
<p>Wide: Use this option to view content recorded in a widescreen (16:9) aspect ratio.</p>	
<p>Cinema: Stretches the image at the edges, but keeps a clear image in the center.</p>	
<p>Auto: Automatically adjusts the image based on the screen size and the TV program. Select this option if you do not know which aspect ratio to choose.</p> <p>Note: Auto is only available when Auto Aspect Ratio in the Channels menu is set to On.</p>	

- **Overscan**—Extends text and images past the screen edges to hide edge artifacts. You can select **On** or **Off**.
 - **Dynamic Backlight (DCR)**—Enhances the contrast ratio between light and dark areas of the picture. You can select **Off**, **Low**, or **High**.
 - **Color Temperature**—Selects the color temperature. You can select **Cool** (to enhance the blues), **Normal**, or **Warm** (to enhance the reds).
 - **Noise Reduction**—Selects the noise reduction mode to reduce picture noise (snow). You can select **Off**, **Low**, **Middle**, or **High**.
 - **Adaptive Contrast**—Automatically adjusts picture detail and brightness. You can select **On** or **Off**.
- 4 Press ◀ or ▶ to adjust the option, or press ▲ or ▼ to select a setting.
 - 5 Press **MENU** to return to the previous menu, or press **EXIT** to close the menu.
- **Backlight**—Sets the overall brilliance of the screen.
 - **Brightness**—Adjusts the brightness of the dark areas of the picture.
 - **Contrast**—Adjusts the brightness of the light areas of the picture.
 - **Color**—Adjusts the color intensity of the picture. A low setting may make the color look faded. A high setting may make the color look artificial.
 - **Tint**—Adjusts the color balance of the picture. Use this control to make skin tones look more natural.
 - **Sharpness**—Adjusts the color detail of images. If you set this control too high, dark images may appear with light or white edges.
 - **Reset Picture Settings**—Resets all picture settings to factory mode.

Automatically adjusting the aspect ratio

Auto Aspect Ratio automatically changes how the picture looks on the screen (aspect ratio) based on the TV program you are viewing.

- 1 Press **MENU**.
- 2 Press ◀ or ▶ to highlight **CHANNELS**, then press ▼ or **ENTER**.



- 3 Press ▲ or ▼ to highlight **Auto Aspect Ratio**, then press **ENTER** or ▶.
- 4 Press ▲ or ▼ to select **On** (automatically adjust the aspect ratio) or **Off** (does not automatically adjust the aspect ratio), then press **ENTER**.
- 5 Press **MENU** to return to the previous menu, or press **EXIT** to close the menu.

Setting the power on picture mode

You can set the picture mode your TV uses when you turn it on.

- 1 Press **MENU**.
- 2 Press ◀ or ▶ to highlight **HELP**, then press ▼ or **ENTER**.



- 3 Press ▲ or ▼ to highlight **Power on in Vivid Mode**, then press **ENTER** or ▶.
- 4 Press ▲ or ▼ to highlight **On** (when you turn on your TV, it will be in **Vivid** picture mode) or **Off** (when you turn on your TV, it will be in the picture mode it was in before you turned it off), then press **ENTER**.
- 5 Press **MENU** to return to the previous menu, or press **EXIT** to close the menu.

Adjusting the sound

This section covers:

- [Adjusting sound settings](#)
- [Selecting the audio out mode](#)
- [Playing TV audio only](#)

Adjusting sound settings

You can adjust sound settings to improve the sound quality. You also can reset all sound settings to the factory default.

- 1 Press **MENU**.
- 2 Press ◀ or ▶ to highlight **AUDIO**, then press ▼ or **ENTER**.

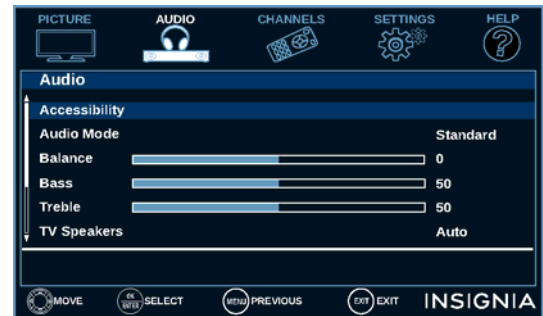











- 3 Press ▲ or ▼ to highlight an option, then press **ENTER** or ▶ to access the option. You can select:
 - **Accessibility**—Turns audio narration on or off. You can select:
 - **Voice Guide**—Audibly narrates menu selections and some remote control functions.
 - **Video Description**—Audibly narrates key visual elements in TV programs (not available on all broadcasts).

Note

- The **Accessibility** menu is only available on TVs manufactured after December 20, 2016. Check the manufacturing date on the back of your TV.
- For more information about accessibility, call Customer Care at 877-467-4289 (U.S. and Canada) or 01800-926-3000 (Mexico).



- **Audio Mode**—Selects the sound mode. You can select:
 - **Standard**—Balances treble and bass. This setting is good for watching standard TV broadcasts.
 - **Theater**—Enhances treble and bass for a rich sound experience. This setting is good for watching DVDs, Blu-ray discs, and HDTV.
 - **Music**—Preserves the original sound. This setting is good for listening to music.
 - **News**—Enhances vocals for TV audio. This setting is good for watching news broadcasts.
 - **Custom**—Lets you manually adjust sound settings.
- **Balance**—Adjusts the balance between the left and right audio channels.
- **Bass**—Adjusts the low sounds.
- **Treble**—Adjusts the high sounds.
- **TV Speakers**—Selects where to play TV audio. When you connect headphones to your TV, audio plays through both the headphones and the TV speakers. You can select:
 - **Auto** (default setting)—Automatically turns off the TV speakers when you connect a device to the /AUDIO OUT jack. When you disconnect the device, the TV speakers turn on automatically.
 - **On**—Always plays the audio through the TV speakers. If a device is connected to the /AUDIO OUT jack, the audio is played through both the TV speakers and the device.
 - **Off**—Turns off the TV speakers and plays the audio only through the device connected to the /AUDIO OUT jack. If you disconnect the device, the TV speakers remain turned off.
- **Digital Audio Format/Audio Delay**—Adjusts the digital audio sent to an external audio system. You can select:
 - **Audio Format**—Selects the digital audio format sent to an external audio system. You can select:
 - **Pass Thru** (to pass through the original digital audio sound).
 - **PCM** (to output audio in 2-channel stereo).
 - **Audio Delay**—Fine tunes the audio when it is not in sync with the video.
- **MTS/SAP**—(Analog channels only) Selects the audio mode. You can select:
 - **Mono**—Select this option if there is noise or static on weak stereo broadcasts.
 - **Stereo**—Select this option for programs broadcast in stereo.
 - **SAP**—Select this option to listen to a secondary audio program, if available.
- **Audio Language**—(Digital channels only) Selects an alternate audio language, if available.





- **Headphones / Audio Out**—You can use the /AUDIO OUT jack on your TV to connect headphones, a home theater system, soundbar, or external speaker system. When a device is connected to the /AUDIO OUT jack, the TV speakers are muted. You can select:
 - **Headphones/Audio Out Variable**—Select this option to use the remote control that came with your TV to control the audio from headphones, a home theater system, a soundbar, or an external speaker system you connected to the /AUDIO OUT jack.
 - **Audio Out Fixed**—Select this option to use the remote control that came with the home theater system, soundbar, or external speaker system you connected to the /AUDIO OUT jack to control the audio.
 - **Reset Audio Settings**—Reset all audio settings to factory defaults.
- 4 Press    or  to adjust the option or select a setting.
 - 5 Press **MENU** to return to the previous menu, or press **EXIT** to close the menu.

Selecting the audio out mode

If your TV is on when you connect a device to the /AUDIO OUT jack on your TV, a screen opens where you select which audio out mode you want to use.



- 1 Connect headphones, a home theater system, soundbar, or external speaker system to the /AUDIO OUT jack on your TV.









- 2 Press  or  to highlight the audio out mode you want to use, then press **ENTER**. You can select:
 - **Headphones / Audio Out Variable**—Select this option to use the remote control that came with your TV to control the audio from headphones, a home theater system, or a soundbar you connected to the /AUDIO OUT jack.
 - **Audio Out Fixed**—Select this option to use the remote control that came with the home theater system, soundbar, or external speaker system you connected to the /AUDIO OUT jack to control the audio.

Playing TV audio only

You can turn off the picture on your TV and listen to the program audio only.

- 1 Press **MENU**.
- 2 Press  or  to highlight **CHANNELS**, then press  or **ENTER**.



- 3 Press  or  to highlight **Audio Only**, then press **ENTER** or .
- 4 Press  or  to select **On**.
- 5 Press **MENU**, **ENTER**, or  to return to the previous menu, or press **EXIT** to close the menu.

Notes

- The picture turns off in about five seconds.
- **Audio Only** works only when the input source is TV, and your TV is receiving a broadcast signal.
- To exit audio only mode, press any button. When you exit audio only mode, the **Audio Only** option is automatically reset to **Off**.

Changing channel settings

This section covers:

- [Automatically scanning for channels](#)
- [Hiding channels](#)
- [Setting up a favorite channel list](#)
- [Viewing a favorite channel](#)
- [Adding or changing a channel label](#)
- [Checking the digital signal strength](#)

Automatically scanning for channels

When you scan for channels, your TV searches for channels with signals and stores the channel information in the channel list. When you press **CH+** or **CH-**, your TV goes to the next or previous channel in the channel list.

If the TV signal source changes, for example you change from an outdoor antenna to cable TV (no box), you need to scan for channels.

- 1 Press **MENU**.
- 2 Press **◀** or **▶** to highlight **CHANNELS**, then press **▼** or **ENTER**.

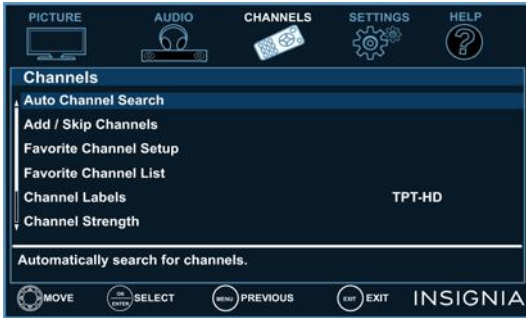

- 3 Press **▲** or **▼** to highlight **Auto Channel Search**, then press **ENTER** or **▶**.



- 4 Press **▲** or **▼** to highlight **Cable/Satellite Box**, **Cable from the wall**, or **Antenna**, then press **ENTER**.

A If you select **Cable/Satellite Box**, a screen opens that shows you all the ways you can connect a box to your TV.

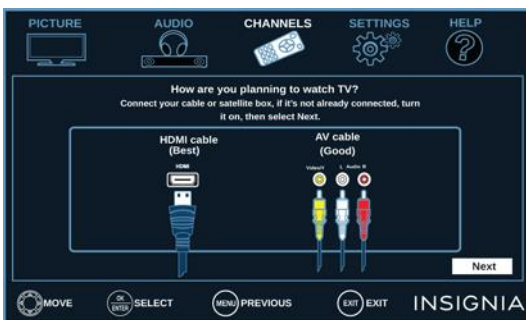

Press **ENTER**. When a message tells you setup is complete, press **EXIT** to close the menu.

Press **INPUT** to open the *INPUT SOURCE* list, then press **▲** or **▼** to select the video input source you connected your TV to and press **ENTER**. Your TV switches to the input source you selected.

- B** If you select **Cable from the wall** your TV scans for available channels. The scan may take several minutes.



When the scan is complete, the first channel your TV found plays in the background.

Note

You can press **EXIT** to stop the auto channel search, but you will need to run the auto channel search again to create a channel list.

- C** If you select **Antenna**, your TV scans for available channels. The scan may take several minutes.



When the scan is complete, press **ENTER** or **EXIT** to close the menu. The first channel your TV found plays in the background.

Note

You can press **EXIT** to stop the auto channel search, but you will need to run the auto channel search again to create a channel list.

Hiding channels

You can hide channels in the channel list. When you press **CH+** or **CH-**, your TV skips the hidden channels. You can still tune to a hidden channel by pressing the number buttons for the channel.

- 1 Press **MENU**.
- 2 Press **◀** or **▶** to highlight **CHANNELS**, then press **▼** or **ENTER**.

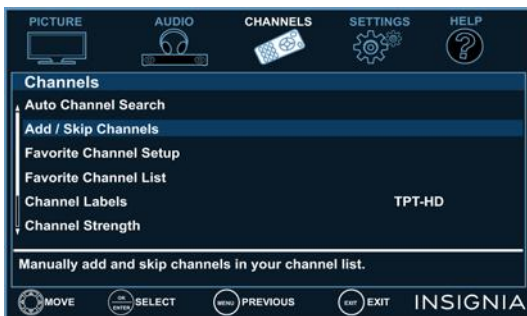

- 3 Press **▲** or **▼** to highlight **Add / Skip Channels**, then press **ENTER** or **▶**.



- 4 Press **▲ ▼ ◀ ▶** to highlight the channel you want to hide, then press **ENTER**. Each channel has a circle to the left. When you hide a channel the circle is empty.

Notes

- If you highlight a channel in the list, your TV displays the channel in the background.
- A channel with a filled circle to the left is not hidden. A channel with an empty circle to the left is hidden.
- If the list has more than one page, press **▲** or **▼** to scroll through the pages.

- 5 Press **MENU** to return to the previous menu, or press **EXIT** to close the menu.

Setting up a favorite channel list

You can create a favorite channel list so you can quickly browse through your favorite channels, then selecting a channel from the favorite channel list.

- 1 Press **MENU**.
- 2 Press **◀** or **▶** to highlight **CHANNELS**, then press **▼** or **ENTER**.

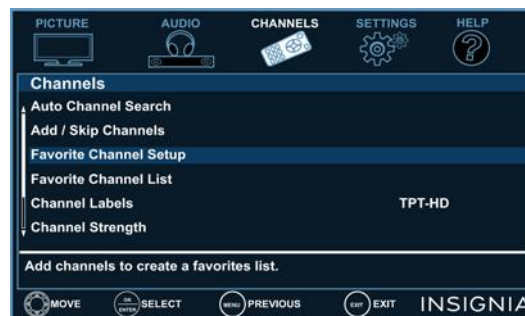

- 3 Press **▲** or **▼** to highlight **Favorite Channel Setup**, then press **ENTER** or **▶**.



- 4 Press **▲ ▼ ◀ ▶** to highlight the channel you want to add to the favorites list, then press **ENTER**. Each channel has a circle to the left. When you add a channel to the *Favorite List*, the circle is filled.

Notes

- If you highlight a channel in the list, your TV displays the channel in the background.
- To remove a channel from the favorites list, highlight the channel, then press **ENTER**. The filled circle is replaced with an empty circle and the channel is removed from the list.
- If the list has more than one page, press **▲** or **▼** to scroll through the pages.

- 5 Press **MENU** to return to the previous menu, or press **EXIT** to close the menu.

Viewing a favorite channel

- 1 Press **MENU**.
- 2 Press ◀ or ▶ to highlight **CHANNELS**, then press ▼ or **ENTER**.



- 3 Press ▲ or ▼ to highlight **Favorite Channel List**, then press **ENTER** or ▶. The *Favorite List* opens.
- 4 Press ▲ or ▼ to highlight a channel, then press **ENTER**.

Adding or changing a channel label

If a channel is not already labeled, you can label the channel to make it easier to identify. You can also relabel a channel that is already labeled.

- 1 Press **MENU**.
- 2 Press ◀ or ▶ to highlight **CHANNELS**, then press ▼ or **ENTER**.



- 3 Press ▲ or ▼ to highlight **Channel Labels**, then press **ENTER** or ▶.



- 4 Press ▲ or ▼ to select the channel you want to label, then press ▶ to move to the channel label field.



- 5 Press ▲ or ▼ to select a character, then press ◀ or ▶ to move to the previous or next character position. Repeat this step to enter additional characters. You can enter as many as 11 characters (letters, numbers, or symbols).
- 6 When you have completed the label, press **ENTER** or **MENU** to save your label and return to the *Channels* menu.
- 7 Press **EXIT** to close the menu.

Checking the digital signal strength

You can check the digital signal strength to determine if you need to adjust your antenna or digital cable input. The higher the signal strength, the less likely you are to experience picture degradation.

- 1 Press **MENU**.
- 2 Press ◀ or ▶ to highlight **CHANNELS**, then press ▼ or **ENTER**.



- 3 Press ▲ or ▼ to highlight **Channel Strength**, then press **ENTER** or ▶.



- 4 Press **MENU** to return to the previous menu, or press **EXIT** to close the menu.

Setting parental controls

Parental controls let you prevent your children from watching inappropriate material on TV. When set, parental controls read the rating of the program (with some exceptions, such as news and sports) and deny access to programs that exceed the ratings level you select. To watch programs that exceed the selected rating, you must enter a password.

Parental controls include:

- Setting or changing the password
- Blocking unrated TV
- Setting parental control levels
- Downloading rating information
- Locking the power button on your TV

Setting or changing the password

- 1 Press **MENU**.
- 2 Press **◀** or **▶** to highlight **SETTINGS**, then press **▼** or **ENTER**.



- 3 Press **▲** or **▼** to highlight **Parental Controls**, then press **ENTER** or **▶**.



- 4 Press the number buttons to enter the four-digit password. The default password is **0000**. You should change the password to a number you can remember.



- 5 Press **▲** or **▼** to highlight **Change Password**, then press **ENTER** or **▶**.



- 6 Press the number buttons to enter a password, then enter the password again. A message tells you that the password has been changed.

Note

If you forget your password, enter **9999**.

- 7 Press **MENU** to return to the previous menu, or press **EXIT** to close the menu.

Blocking unrated TV

Some TV programs, such as news and sports shows are not rated. When **Block Unrated TV** is turned on, TV programs that do not have ratings are blocked. When you try to watch a blocked program, you are prompted to enter the parental controls password.

- 1 Press **MENU**.
- 2 Press **◀** or **▶** to highlight **SETTINGS**, then press **▼** or **ENTER**.



- 3 Press **▲** or **▼** to highlight **Parental Controls**, then press **ENTER** or **▶**.



- 4 Press the number buttons to enter the four-digit password.



- 5 Press **▲** or **▼** to highlight **Block Unrated TV**, then press **ENTER** or **▶**.
- 6 Press **▲** or **▼** to select **On** (to block unrated TV) or **Off** (to unblock unrated TV).
- 7 Press **ENTER**, **MENU**, or **◀** to return to the previous menu, or press **EXIT** to close the menu.

Setting parental control levels

You can set parental controls for the U.S. and Canada.

U.S. rating levels

U.S. TV ratings	
NONE	Not rated
TV-Y	All children
TV-Y7	Suitable for children 7 and older
TV-G	General audiences
TV-PG	Parental guidance suggested
TV-14	Parental guidance strongly suggested
TV-MA	Mature audiences only

Some of the age-based TV Parental Guidelines ratings also have content-based ratings.

U.S. TV content ratings	
All	All ratings are blocked
FV	Fantasy violence
L	Strong language
S	Sexual situations
V	Violence
D	Suggestive dialog

U.S. movie (MPAA) ratings	
None	Movie not rated
G	General audiences
PG	Parental guidance suggested
PG-13	Suitable for children 13 and older
R	Parental guidance suggested for children under 17
NC-17	Not suitable for children under 17
X	Adults only

Canadian rating levels

Canadian English ratings	
E	Exempt programming
C	Suitable for all children
C8+	Suitable for children 8 and older
G	General audiences
PG	Parental guidance suggested
14+	Suitable for children 14 and older
18+	Adult only

Canadian French ratings

E	Exempt programming
G	General audiences
8 ans+	Suitable for children 8 and older
13 ans+	Suitable for children 13 and older
16 ans+	Suitable for children 16 and older
18 ans+	Adult only

- 1 Press **MENU**.
- 2 Press **◀** or **▶** to highlight **SETTINGS**, then press **▼** or **ENTER**.



- 3 Press **▲** or **▼** to highlight **Parental Controls**, then press **ENTER** or **▶**.



- 4 Press the number buttons to enter the four-digit password.



- 5 Press **▲** or **▼** to highlight **USA Parental Locks**, then press **ENTER**. (To set Canadian ratings, select **Canadian Parental Locks**.)

USA Parental Locks



Canadian Parental Locks



- 6 Press **◀** or **▶** to highlight:
 - **Movie Ratings** or **TV Ratings** for USA ratings.
 - **Canadian English** or **Canadian French** for Canadian ratings.
- 7 Press **▲** or **▼** to select the rating. If a rating has sub-ratings, press **◀** or **▶** to highlight a sub-rating.

Note
When you block a rating, that rating and all higher ratings are blocked.

- 8 Press **ENTER** to confirm. The circle next to the rating changes to a lock symbol.
- 9 Press **MENU** to return to the previous menu, or press **EXIT** to close the menu.

Downloading rating information

If the program you are viewing has downloadable rating information, you can download the information to use when setting parental controls.

Note

If the program you are viewing does not have RRT5 rating information, RRT5 is grayed on the *Settings · Parental Controls* menu and cannot be selected.

- 1 Press **MENU**.
- 2 Press **◀** or **▶** to highlight **SETTINGS**, then press **▼** or **ENTER**.



- 3 Press **▲** or **▼** to highlight **Parental Controls**, then press **ENTER** or **▶**.



- 4 Press the number buttons to enter the four-digit password.



- 5 Press **▲** or **▼** to highlight **RRT5**, then press **ENTER**. The screen that opens may vary depending on the broadcaster.

- 6 Press **▲ ▼ ◀ ▶** to select the program and content types you want to block, then press **ENTER**.



- 7 To reset the RRT5 information to the factory default, press **▲** or **▼** to highlight **Reset RRT5**.



- 8 Press **ENTER**.
- 9 Press **▲** or **▼** to highlight **OK** or **Cancel**, then press **ENTER**.
- 10 Press **MENU** to return to the previous menu, or press **EXIT** to close the menu.

Locking the power button on your TV

When the button lock is turned **On**, the **⏻/INPUT** button on your TV is locked, and you can only turn your TV on or off or change the video input source using the remote control.

- 1 Press **MENU**.
- 2 Press **◀** or **▶** to highlight **SETTINGS**, then press **▼** or **ENTER**.



- 3 Press **▲** or **▼** to highlight **Button Lock**, then press **ENTER** or **▶**.
- 4 Press **▲** or **▼** to select **On** (locks the **⏻/INPUT** button) or **Off** (unlocks the **⏻/INPUT** button).
- 5 Press **MENU** to return to the previous menu, or press **EXIT** to close the menu.

- 6 Press **ENTER**, **MENU**, or **◀** to return to the previous menu, or press **EXIT** to close the menu.

Note

You can also press **CCD** to turn closed captioning on or off.

Using closed captioning

Closed captioning displays a text version of the TV program audio or displays information provided by the broadcaster.

Closed caption controls include:

- Turning closed captioning on or off
- Selecting the analog closed captioning mode
- Selecting the digital closed captioning mode
- Customizing digital closed captioning settings

Turning closed captioning on or off

- 1 Press **MENU**.
- 2 Press **◀** or **▶** to highlight **SETTINGS**, then press **▼** or **ENTER**.



- 3 Press **▲** or **▼** to highlight **Closed Caption**, then press **ENTER** or **▶**.



- 4 Press **▲** or **▼** to highlight **Caption Control**, then press **ENTER** or **▶**.
- 5 Press **▲** or **▼** to select **CC Off** (turns off closed captioning), **CC On** (turns on closed captioning), or **CC on when mute** (turns on closed captioning when the sound is muted).

Selecting the analog closed captioning mode

Analog channels usually have one or more closed captioning modes. The CC1 mode usually displays a text version of the TV program audio in a small banner. The other CC modes display information provided by the broadcaster. The Text modes display information in a box that covers half of the screen.

- 1 Press **MENU**.
- 2 Press **◀** or **▶** to highlight **SETTINGS**, then press **▼** or **ENTER**.



- 3 Press **▲** or **▼** to highlight **Closed Caption**, then press **ENTER** or **▶**.



- 4 Press **▲** or **▼** to highlight **Analog Caption**, then press **ENTER** or **▶**.
- 5 Press **▲** or **▼** to select an analog caption setting. You can select:
 - **CC1** through **CC4**—Closed captioning appears in a small banner across the bottom of the screen. **CC1** is usually the “printed” version of the audio. **CC2** through **CC4** display content provided by the broadcaster.
 - **Text1** through **Text4**—Closed captioning covers half or all of the screen. **Text1** through **Text4** display content provided by the broadcaster.
- 6 Press **ENTER**, **MENU**, or **◀** to return to the previous menu, or press **EXIT** to close the menu.

Selecting the digital closed captioning mode

Digital channels usually have one or more closed captioning modes. The CC1 mode usually displays a text version of the TV program audio in a small banner. The other CC modes display information provided by the broadcaster. CS1 mode displays a text version of the audio in the same language as the audio.

- 1 Press **MENU**.
- 2 Press **◀** or **▶** to highlight **SETTINGS**, then press **▼** or **ENTER**.



- 3 Press **▲** or **▼** to highlight **Closed Caption**, then press **ENTER** or **▶**.



- 4 Press **▲** or **▼** to highlight **Digital Caption**, then press **ENTER** or **▶**.
- 5 Press **▲** or **▼** to select a digital caption setting. You can select:
 - **CS1** through **CS6**—CS1 is usually the “printed” version of the audio. CS2 through CS6 display content provided by the broadcaster. You can change the way digital closed captioning is displayed on the screen. For more information, see [Customizing digital closed captioning settings](#) on page 51.
 - **CC1** through **CC4**—Closed captioning appears in a small banner across the bottom of the screen. **CC1** is usually the “printed” version of the audio. **CC2** through **CC4** display content provided by the broadcaster.
- 6 Press **ENTER**, **MENU**, or **◀** to return to the previous menu, or press **EXIT** to close the menu.

Customizing digital closed captioning settings

- 1 Press **MENU**.
- 2 Press **◀** or **▶** to highlight **SETTINGS**, then press **▼** or **ENTER**.



- 3 Press **▲** or **▼** to highlight **Closed Caption**, then press **ENTER** or **▶**.



- 4 Press **▲** or **▼** to highlight **Digital CC Settings**, then press **ENTER** or **▶**.



- 5 Press **ENTER**, press **▲** or **▼** to select **Custom**, then press **ENTER**.

- 6 Press **▲** or **▼** to highlight an option, then press **ENTER** or **▶**. You can select:
 - **Size**—Selects the font size.
 - **Font**—Selects the font style.
 - **Text Color**—Selects the color for the words.
 - **Text Opacity**—Selects the opacity level for the words.
 - **Background Color**—Selects the color for the background.
 - **Background Opacity**—Selects the opacity level for the background.
 - **Edge Effect**—Selects the style of the letter edge.
 - **Edge Color**—Selects the color of the letter edge.
- 7 Press **▲** or **▼** to adjust the setting, then press **ENTER**.
- 8 Press **MENU** to return to the previous menu, or press **EXIT** to close the menu.

Adjusting time settings

This section includes:

- [Setting the clock](#)
- [Setting the sleep timer](#)

Setting the clock

If you skipped the steps in the *Easy Setup* wizard for setting the date and time or if you move your TV to a different time zone, you need to reset the clock to the correct time.

- 1 Press **MENU**.
- 2 Press **◀** or **▶** to highlight **SETTINGS**, then press **▼** or **ENTER**.



- 3 Press **▲** or **▼** to highlight **Time**, then press **ENTER** or **▶**.



- 4 Press **▲** or **▼** to highlight **Date / Time**, then press **ENTER**.



- 5 Press **▲** or **▼** to highlight **Mode**, then press **ENTER** or **▶**.
- 6 Press **▲** or **▼** to highlight **Manual** (to set the options manually) or **Auto** (the options are automatically set by the TV signal source), then press **ENTER**.
- 7 Press **▲** or **▼** to highlight **Time Zone**, then press **ENTER** or **▶**.
- 8 Press **▲** or **▼** to select your time zone, then press **MENU**. You can select **Eastern, Central, Mountain, Pacific, Alaska, Hawaii, Atlantic, or Newfoundland**.
- 9 If your viewing area observes Daylight Saving Time, press **▲** or **▼** to highlight **Daylight Saving**, then press **ENTER**.
- 10 Press **▲** or **▼** to select **On** or **Off**, then press **MENU** to close the menu.
- 11 If you selected **Manual** for **Mode**, press **▲** or **▼** to highlight **Date**, then press **ENTER**. Press **◀** or **▶** to highlight **Month, Day, or Year**. Press **▲** or **▼** to adjust the setting, then press **MENU**.
- 12 If you selected **Manual** for **Mode**, press **▲** or **▼** to highlight **Time**, then press **ENTER**. Press **◀** or **▶** to highlight the **Hour, Minute, or the AM/PM field**. Press **▲** or **▼** to adjust the setting. When you are finished, press **MENU**.
- 13 Press **MENU** to return to the previous menu, or press **EXIT** to close the menu.

Setting the sleep timer

You can specify the amount of time before your TV automatically turns off.

- 1 Press **MENU**.
- 2 Press ◀ or ▶ to highlight **SETTINGS**, then press ▼ or **ENTER**.



- 3 Press ▲ or ▼ to highlight **Time**, then press **ENTER** or ▶.



- 4 Press ▲ or ▼ to highlight **Sleep Timer**, then press **ENTER** or ▶.
- 5 Press ▲ or ▼ to select the amount of time before your TV turns off automatically. You can select **Off**, **5**, **10**, **15**, **30**, **60**, **90**, **120**, **180**, or **240** minutes. To turn off the sleep timer, select **Off**.
- 6 Press **ENTER**, **MENU**, or ◀ to return to the previous menu, or press **EXIT** to close the menu.

Note

You can also press **SLEEP** to set the sleep timer.

Adjusting menu settings

You can adjust how the TV menus look by:

- [Selecting the menu language](#)
- [Turning Input Sensor on or off](#)
- [Labeling an input source](#)

Note

To turn audio narration for menus on or off, see [Adjusting sound settings](#) on page 40.

Selecting the menu language

Your TV can display the on-screen menu in English, French, or Spanish. When you set up your TV for the first time, you selected the language. You can change the menu language to a different language.

- 1 Press **MENU**.
- 2 Press ◀ or ▶ to highlight **SETTINGS**, then press ▼ or **ENTER**.



- 3 Press ▲ or ▼ to highlight **Menu Language**, then press **ENTER** or ▶.
- 4 Press ▲ or ▼ to highlight a language, then press **ENTER**. You can select **English**, **Français**, or **Español**.
- 5 Press **MENU** to return to the previous menu, or press **EXIT** to close the menu.

Turning Input Sensor on or off

When the Input Sensor feature is turned on, your TV automatically detects which video jacks have devices connected to them and turned on. Your TV uses this information to determine what options you can select on the *INPUT SOURCE* list when you press **INPUT**.

- 1 Press **MENU**.
- 2 Press **◀** or **▶** to highlight **SETTINGS**, then press **▼** or **ENTER**.



- 3 Press **▲** or **▼** to highlight **Auto Input Sensing**, then press **ENTER** or **▶**.
- 4 Press **▲** or **▼** to select **On** (turns on the input sensor) or **Off** (turns off the input sensor).
- 5 Press **ENTER**, **MENU**, or **◀** to return to the previous menu, or press **EXIT** to close the menu.

Labeling an input source

You can add a label to an input source to make it easier to identify.

- 1 Press **MENU**.
- 2 Press **◀** or **▶** to highlight **SETTINGS**, then press **▼** or **ENTER**.



- 3 Press **▲** or **▼** to highlight **Input Labels**, then press **ENTER** or **▶**.

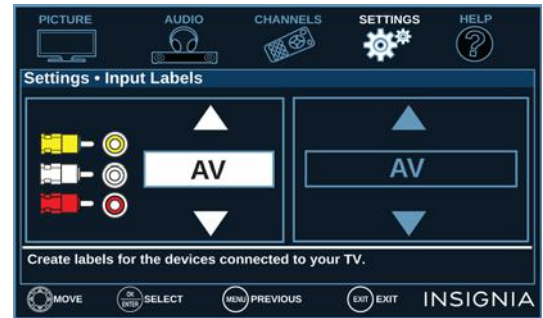

- 4 Press **▲** or **▼** to select the input source you want to label, then press **▶** to move to the label field.

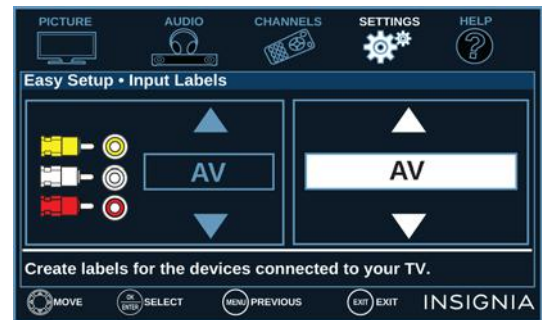

- 5 Press **▲** or **▼** to select a preset label or select **Custom** to create your own label.
- 6 If you select **Custom**, press **ENTER**, then **▲** or **▼** to select characters (letters or numbers) and **◀** or **▶** to move character to character.
- 7 When you have completed the label, press **ENTER** to save your label. The next time you press **INPUT**, your label appears in the *INPUT SOURCE* list.
- 8 Press **MENU** to return to the previous menu, or press **EXIT** to close the menu.

Maintaining

- Do not use your TV in areas that are too hot or too cold, because the cabinet may warp or the screen may malfunction. Your TV works best in temperatures that are comfortable to you.
- Storage temperatures are 32° to 122°F (0° to 50°C).
- Working temperatures are 41° to 104°F (5° to 40°C).
- Do not place your TV in direct sunlight or near a heat source.

Cleaning the TV cabinet

Clean the cabinet with a soft, lint-free cloth. If the cabinet is especially dirty, moisten a soft, lint-free cloth in a weak detergent solution, squeeze the excess moisture from the cloth, then wipe the cabinet with the cloth. Use a clean cloth to dry the cabinet.

Cleaning the TV screen

Clean the screen with a soft, lint-free cloth.

Troubleshooting

Warning

Do not try to repair your TV yourself. Contact authorized service personnel.

Troubleshooting topics include:

- [Viewing system information](#)
- [Learning more about your TV](#)
- [Updating the TV firmware](#)
- [Customizing TV settings](#)
- [Testing the TV speakers](#)
- [Restoring settings to the defaults](#)
- [Video and audio problems](#)
- [Remote control problems](#)
- [General problems](#)
- [INlink \(CEC-compatible\) device problems](#)

Viewing system information

You may need to view system information during troubleshooting.

- 1 Press **MENU**.
- 2 Press **◀** or **▶** to highlight **HELP**, then press **▼** or **ENTER**.



- 3 Press **▲** or **▼** to highlight **System Info**, then press **ENTER** or **▶**.
- 4 If your TV uses open source code, press **ENTER** to display the open source code information.
- 5 Press **MENU** to return to the previous menu, or press **EXIT** to close the menu.

Learning more about your TV

You can learn more about remote control codes and connecting a soundbar.

- 1 Press **MENU**.
- 2 Press **◀** or **▶** to highlight **HELP**, then press **▼** or **ENTER**.



- 3 Press **▲** or **▼** to highlight **Learn More**, then press **ENTER** or **▶**.

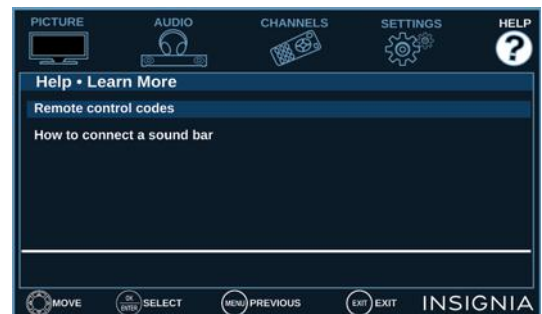

- 4 Press **▲** or **▼** to highlight a topic, then press **ENTER**. Your TV displays information about the topic you selected.
- 5 Press **MENU** to return to the previous menu, or press **EXIT** to close the menu.

Updating the TV firmware

If your TV is behaving oddly and you have tried all the solutions in the troubleshooting pages, you may need to update the TV firmware.

Cautions

- Make sure that you have tried all other solutions before you upgrade the firmware.
- While the firmware is updating, do not turn off your TV.

Note

To update the TV firmware, you need a:

- Computer with an available USB port
- High-speed Internet connection
- USB flash drive

- 1 On the *Help* menu, select **System Info**, then write down your model, revision, and firmware information. See [Viewing system information](#) on page 55.
- 2 On a computer, go to www.insigniaproducts.com, then click **Support & Service/Product Support**. Enter *NS-32D311NA17* in the box under **Product Information**, then click **ENTER**. The support page for your TV opens.
- 3 Follow the instructions in the *Firmware Installation Guide* on the Insignia website to download the firmware update and copy it to a USB flash drive.
- 4 Plug the USB flash drive into the **USB** port on your TV.
- 5 Press **MENU**.
- 6 Press **◀** or **▶** to highlight **HELP**, then press **▼** or **ENTER**.



- 7 On the *Help* menu, press **▲** or **▼** to highlight **Update Firmware**, then press **ENTER** or **▶**. A message asks if you want to update the TV firmware.

- 8 Highlight **OK**, then press **ENTER**.

While your TV installs the firmware update, your TV displays a status screen. **Do not turn off your TV until the update is complete.**

- 9 When the update is complete, unplug the USB flash drive, then press **ENTER**. Your TV turns off then on to complete the update.
- 10 If the channel list has been deleted, you need to scan for channels. For more information, see [Automatically scanning for channels](#) on page 42.

Note

- If you see a message that says the firmware file is incorrect, make sure that you have downloaded the correct file for your model.
- If you see a message that says the update failed or the TV screen is blank and the power LED is blinking red then blue, turn off your TV, turn it back on, then run the upgrade again.

Customizing TV settings

If you did not complete the customization part of the *Easy Setup* wizard the first time you turned on your TV, you can run the wizard again to customize settings.

- 1 Press **MENU**.
- 2 Press **◀** or **▶** to highlight **HELP**, then press **▼** or **ENTER**.



- 3 Press **▲** or **▼** to highlight **Customize my TV**, then press **ENTER** or **▶**. A message asks if you want to run the *Easy Setup* wizard.
- 4 Press **▲** or **▼** to select **OK** (to reset) or **Cancel** (to not reset), then press **ENTER**.

If you select **OK**, your TV turns off, then turns on again. Go through the *Easy Setup* wizard. For more information, see [Turning on your TV for the first time](#) on page 29.

OR

If you select **Cancel** or press **MENU**, your TV returns to the *Help* menu without making any changes.

OR

If you press **EXIT**, the on-screen menu closes without making any changes.

Testing the TV speakers

You can test your TV's speakers to make sure they are working correctly.

- 1 Press **MENU**.
- 2 Press ◀ or ▶ to highlight **HELP**, then press ▼ or **ENTER**.



- 3 Press ▲ or ▼ to highlight **TV Speaker Test**, then press **ENTER** or ▶.



- 4 Press **ENTER**. Your TV tests the left speaker, then the right speaker. You hear a tone, and as each speaker is tested, its icon turns yellow.

If one or both of the speakers fail the test, see the [Video and audio](#) on page 58.

Restoring settings to the defaults

When you restore default settings, all the settings you have customized (except parental controls) are reset.

- 1 Press **MENU**.
- 2 Press ◀ or ▶ to highlight **HELP**, then press ▼ or **ENTER**.

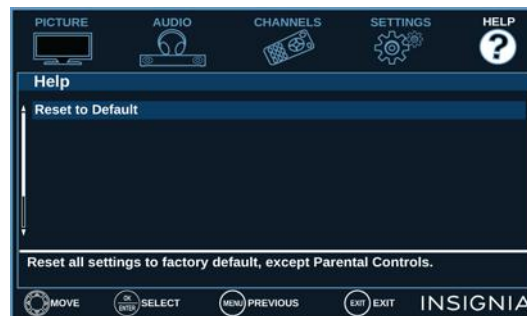

- 3 Press ▲ or ▼ to highlight **Reset to Default**, then press **ENTER** or ▶.

- 4 Press ▲ or ▼ to select **OK** (to reset) or **Cancel** (to not reset), then press **ENTER**.

If you select **OK**, your TV turns off, then turns on again. Go through the *Easy Setup* wizard. For more information, see [Turning on your TV for the first time](#) on page 29.

OR

If you select **Cancel** or press **MENU**, your TV returns to the *Help* menu without making any changes.

OR

If you press **EXIT**, the on-screen menu closes without making any changes.

Video and audio

Problem	Solution
Picture does not fill the screen. There are black bars around the picture.	<ul style="list-style-type: none"> Change the aspect ratio. See the Aspect Ratio option in Adjusting the TV picture on page 38.
No picture (screen is not lit) and no sound.	<ul style="list-style-type: none"> Press ⏻ on the TV or the remote control. Make sure that the Audio Only option is set to Off. See Playing TV audio only on page 42. Make sure that the video cables are connected correctly and securely to your TV. Adjust the contrast and brightness. See Adjusting the TV picture on page 38. Make sure that the power cord is plugged into a working outlet. Press INPUT and make sure that the correct video input source is selected. See Selecting the video input source on page 31. Try another channel. The station may be experiencing problems. Make sure that the incoming signal is compatible. Make sure that the antenna or cable TV is connected correctly and securely. See Connecting a cable or satellite box on page 12 or Connecting an antenna or cable TV (no box) on page 15. Check the closed caption settings. Some TEXT modes can block the screen. See Using closed captioning on page 50.

Problem	Solution
Dark, poor, or no picture (screen is lit), but sound is good.	<ul style="list-style-type: none"> Try another channel. The station may be experiencing problems. Make sure that the antenna or cable TV is connected correctly and securely. See Connecting a cable or satellite box on page 12 or Connecting an antenna or cable TV (no box) on page 15. Adjust the brightness. See Adjusting the TV picture on page 38. Press PICTURE to change to a different picture mode. See Adjusting the TV picture on page 38. If you are using an antenna, the digital channel signal may be low. To check the digital channel signal strength, see Checking the digital signal strength on page 45. If you are using an antenna and the signal strength is low, adjust the antenna or use a highly directional outdoor antenna or set-top antenna with a built-in amplifier. Make sure that the video cables are connected correctly and securely to your TV. The video cable(s) you are using may be bad. Try a new set.
No color, dark picture, or color is not correct.	<ul style="list-style-type: none"> Try another channel. The station may be experiencing problems. Adjust the color settings. See Adjusting the TV picture on page 38. Make sure that the video cables are connected correctly and securely to your TV. Make sure that the antenna or cable TV is connected correctly and securely. See Connecting a cable or satellite box on page 12 or Connecting an antenna or cable TV (no box) on page 15. If you are using an antenna, the digital channel signal may be low. To check the digital channel signal strength, see Checking the digital signal strength on page 45. If you are using an antenna and the signal strength is low, adjust the antenna or use a highly directional outdoor antenna or set-top antenna with a built-in amplifier.

Problem	Solution
Only snow (noise) appears on the screen.	<ul style="list-style-type: none"> • Try another channel. The station may be experiencing problems. • Make sure that the antenna or cable TV is connected correctly and securely. See Connecting a cable or satellite box on page 12 or Connecting an antenna or cable TV (no box) on page 15. • If you are using an antenna, the digital channel signal may be low. To check the digital channel signal strength, see Checking the digital signal strength on page 45. • If you are using an antenna and the signal strength is low, adjust the antenna or use a highly directional outdoor antenna or set-top antenna with a built-in amplifier.
Picture quality is good on some channels and poor on others. Sound is good.	<ul style="list-style-type: none"> • The problem may be caused by a poor or weak signal from the broadcaster or cable TV provider. • If you connect to cable TV without a set-top box and experience poor picture quality, you may need to install a set-top box to improve signal reception and picture quality. Contact your cable TV provider about upgrading to a set-top box.

Problem	Solution
Dotted lines or stripes appear on the screen.	<ul style="list-style-type: none"> • Make sure that the antenna or cable TV is connected correctly and securely. See Connecting a cable or satellite box on page 12 or Connecting an antenna or cable TV (no box) on page 15. • If you are using an antenna, the digital channel signal may be low. To check the digital channel signal strength, see Checking the digital signal strength on page 45. • If you are using an antenna and the signal strength is low, adjust the antenna or use a highly directional outdoor antenna or set-top antenna with a built-in amplifier. • Make sure that the video cables are connected correctly and securely to your TV. • The video cable(s) you are using may be bad. Try a new set. • Other devices (for example, a surround sound receiver, external speakers, fans, or hair dryers) may be interfering with your TV. Try turning off one device at a time to determine which device is causing interference. After you have determined which device is causing interference, move it further from the TV to eliminate the interference.
Double images.	<ul style="list-style-type: none"> • Use a highly directional outdoor antenna or use a cable or satellite box.
The picture has a few bright or dark spots.	<ul style="list-style-type: none"> • A few bright or dark spots on an LCD screen is normal. It does not affect the operation of your TV.
Video description or voice guide does not work.	<ul style="list-style-type: none"> • Make sure that your TV is not muted and the volume is turned up. • Make sure that the options listed under the Accessibility menu are turned on. See Adjusting sound settings on page 40. • Video descriptions are not available on all broadcasts. • Some remote functions are not narrated.

Problem	Solution
Good picture, but no sound.	<ul style="list-style-type: none"> • Increase the volume. • Make sure that the sound is not muted. • Make sure that you do not have headphones connected. When headphones are connected, no sound comes from the TV speakers. • Change to a different audio mode. See the Audio Mode option in Adjusting sound settings on page 40. • If you are using a home theater system, soundbar, or external speaker system, make sure it is turned on and is not muted. • If you are using a home theater system, soundbar, or external speaker system, make sure that you have selected the correct output mode. • If you are using a home theater system, soundbar, or external speaker system and have connected it with a digital audio cable, select Digital Audio Format/Audio Delay on the <i>Audio</i> menu, then set Audio Format to PCM. See the Digital Audio Format/Audio Delay option in Adjusting sound settings on page 40. • Make sure that the audio cables are connected correctly and securely to your TV. • Make sure that the antenna or cable TV is connected correctly and securely. See Connecting a cable or satellite box on page 12 or Connecting an antenna or cable TV (no box) on page 15. • If you are using an antenna, the digital channel signal may be low. To check the digital channel signal strength, see Checking the digital signal strength on page 45. • If you are using an antenna and the signal strength is low, adjust the antenna or use a highly directional outdoor antenna or set-top antenna with a built-in amplifier. • The audio cables you are using may be bad. Try a new set.

Problem	Solution
Poor picture.	<ul style="list-style-type: none"> • Make sure that the room is not too bright. Light reflecting off the screen can make the picture difficult to see. • If an S-VHS camera or a camcorder is connected while another connected device is turned on, the picture may be poor. Turn off one or more devices.
Good sound, but poor color.	<ul style="list-style-type: none"> • Adjust the contrast, color, and brightness settings. See Adjusting the TV picture on page 38.
Audio noise.	<ul style="list-style-type: none"> • Other devices (for example, a surround sound receiver, external speakers, fans, or hair dryers) may be interfering with your TV. Try turning off one device at a time to determine which device is causing interference. After you have determined which device is causing interference, move it further from the TV to eliminate the interference.
No output from one of the speakers.	<ul style="list-style-type: none"> • Adjust the audio balance. See Adjusting sound settings on page 40. • Test the TV's speakers. See Testing the TV speakers on page 57. If one or both of the speakers fails, try one of the following solutions: <ul style="list-style-type: none"> • Make sure that the audio cables are connected correctly and securely to your TV. • Make sure that the audio cables are connected to the AUDIO OUT jacks on the connected device. • Try a different set of audio cables. • Make sure that the sound on the connected device is not muted. • Try connecting the device to a different TV. If you do not hear sound, the problem is with the device.
After images appear.	<ul style="list-style-type: none"> • Do not display a still image, such as a logo, game, or computer image, for an extended period of time. This can cause a permanent after-image to be burned into the screen. This type of damage is not covered by your warranty.

Remote control

Problem	Solution
Remote control does not work.	<ul style="list-style-type: none"> • Make sure that the power cord is plugged into a working outlet. • Make sure that there are no obstructions between the remote control and the remote control sensor on the front of the TV. • Point the remote control directly at the remote control sensor on your TV. See Aiming the remote control on page 27. • The supplied batteries are wrapped tightly in clear plastic. Make sure that you have removed this plastic from the batteries. • Make sure that the batteries are installed correctly. See Installing remote control batteries on page 27. • Replace dead batteries with new batteries. See Installing remote control batteries on page 27.
Trouble programming your existing universal remote control.	<ul style="list-style-type: none"> • See instructions in Programming universal remote controls on page 28. • Codes are subject to change. For up-to-date codes, go to Viewing universal remote control codes on page 28 or visit www.insigniaproducts.com/remotecodes • Replace dead batteries with new batteries. • Refer to the User Guide that accompanied your universal remote control and contact the manufacturer if problems persist.

General

Problem	Solution
No power.	<ul style="list-style-type: none"> • Make sure that the power cord is plugged into a working outlet. • Unplug the power cord, wait 60 seconds, then plug the cord back in and turn on your TV. • Other devices (for example, a surround sound receiver, external speakers, fans, or hair dryers) may be interfering with your TV. Try turning off one device at a time to determine which device is causing interference. After you have determined which device is causing interference, move it further from the TV to eliminate the interference.
"No signal" error message is displayed.	<ul style="list-style-type: none"> • Press INPUT and make sure that you have selected the correct input for the device or service you are trying to use. • If you are using a cable or satellite box, use the remote that came with that box to change channels.

Problem	Solution
After Auto Channel Search, there are no channels.	<ul style="list-style-type: none"> • Reception can vary by channel depending on the broadcast power level of a given station. Contact your cable or satellite TV provider. • Make sure that the antenna or cable/satellite TV is connected securely to your TV. • Try replacing the cable between the antenna/cable or cable/satellite box and your TV.
When I press INPUT , I cannot select my device (it is grayed out).	<ul style="list-style-type: none"> • Turn on the device. Your TV automatically detects and displays which video jacks have devices connected to them when the devices are turned on. • Turn off Auto Input Sensing. See Turning Input Sensor on or off on page 54.
One or more channels do not display.	<ul style="list-style-type: none"> • Make sure that the channels are not blocked. See Setting parental control levels on page 47. • Make sure that the channels are not hidden. The channel may have been deleted from the channel list. You can tune to the channel by pressing the number buttons or you can add the channel back to the channel list. See Hiding channels on page 44. • If you are using a cable or satellite box, use the remote that came with that box to change channels. • Press INPUT and make sure that you have selected the correct input for the device or service you are trying to use. • If you are using an antenna, the digital channel signal may be low. To check the digital channel signal strength, see Checking the digital signal strength on page 45.
Password is lost.	<ul style="list-style-type: none"> • Enter 9999 to access parental controls, then set a new password. See Setting or changing the password on page 46.
Some settings cannot be accessed.	<ul style="list-style-type: none"> • If a setting is grayed, the setting is not available in the current video input mode (for example TV mode). Change to a different video input source. See Selecting the video input source on page 31.
TV cabinet creaks.	<ul style="list-style-type: none"> • When the TV is in use, the temperature rises naturally and may cause the cabinet to expand or contract which can cause a creaking noise. This is not a malfunction.

Problem	Solution
⏻/INPUT button does not work.	<ul style="list-style-type: none"> Make sure that the Button Lock option is set to Off. See Locking the power button on your TV on page 49. Unplug the power cord, wait a few seconds, then plug the cord back in and turn on your TV.
TV keeps turning off.	<ul style="list-style-type: none"> Make sure that the sleep timer is not turned on. See Setting the sleep timer on page 53.
A retail banner is displayed.	<ul style="list-style-type: none"> You selected Store Display Mode when you ran the <i>Easy Setup</i> wizard. Run the <i>Easy Setup</i> wizard and select Home User Mode on the <i>Viewing Environment</i> screen. See Customizing TV settings on page 56.

INlink (CEC-compatible) device

Problem	Solution
My TV is not displaying the video from the connected CEC device.	<ul style="list-style-type: none"> Make sure that the HDMI cable is connected securely to your TV and the device. Make sure that the device is connected to your TV with an HDMI cable. Make sure that the device is a CEC device. See the documentation that came with the device for more information. Press INPUT and make sure that the correct video input source is selected. See Selecting the video input source on page 31. Make sure that the INlink feature is turned on. See Turning INlink on or off on page 34. Try adjusting the TV picture. See Adjusting the TV picture on page 38.

Problem	Solution
My TV is not playing the audio from the connected CEC device.	<ul style="list-style-type: none"> Make sure that the HDMI cable is connected securely to your TV and the device. Make sure that the device is connected to your TV with an HDMI cable. Make sure that the device is a CEC device. See the documentation that came with the device. Make sure that the TV volume is turned up and not muted. Try adjusting the TV sound. See Adjusting sound settings on page 40. Make sure that the TV speakers are turned on and not muted. See Adjusting sound settings on page 40. Make sure that the INlink feature is turned on. See Turning INlink on or off on page 34. If you have connected an HDMI CEC audio receiver, adjust the volume on the receiver. When your TV detects an audio receiver, the TV speakers turn off and sound plays through receiver speakers only. If you are using a home theater system, soundbar, or external speaker system, make sure that it is turned on and is not muted. If you are using a home theater system, soundbar, or external speaker system, make sure that you have selected the correct output mode. If you are using a home theater system, soundbar, or external speaker system and have connected it with a digital audio cable, select Digital Audio Format/Audio Delay on the <i>Audio</i> menu, then set Audio Format to PCM. See the Digital Audio Format/Audio Delay option in Adjusting sound settings on page 40.

Problem	Solution
My TV's remote control does not control the device.	<ul style="list-style-type: none"> • Make sure that there are no obstructions between the remote control and the remote control sensors on your TV and the device. • Depending on the device, all the buttons may not work. • After you switch to an INlink device, use the remote control that came with the device to control playback. • Make sure that the INlink feature is turned on. See Turning INlink on or off on page 34. • If you are trying to control the volume on an HDMI CEC audio receiver using your TV remote control, make sure that the TV Speakers option on the <i>INlink</i> menu is set to On. See Adjusting sound settings on page 40. • If you are trying to control the volume on an HDMI CEC audio receiver using your TV remote control, make sure that the Audio Receiver option on the <i>INlink</i> menu is set to On. See Turning Audio Receiver on or off on page 35. • The device may not support this feature. See the documentation that came with the device for more information.
The device does not show up in the INlink Device list.	<ul style="list-style-type: none"> • Make sure that the device is turned on. • Make sure that the HDMI cable is connected securely to your TV and the device. • Make sure that the device is connected to your TV with an HDMI cable. • Make sure that the INlink feature is turned on. See Turning INlink on or off on page 34. • Make sure that the device is a CEC device. See the documentation that came with the device.
My device does not turn off when I turn off my TV.	<ul style="list-style-type: none"> • Make sure that the INlink feature is turned on. See Turning INlink on or off on page 34. • Make sure that Device Auto Power Off is set to On on the <i>INlink</i> menu. See Turning Device Auto Power Off on or off on page 34. • The device may not support this feature. See the documentation that came with the device for more information.

Problem	Solution
My TV does not turn on when I turn on my device.	<ul style="list-style-type: none"> • Make sure that the INlink feature is turned on. See Turning INlink on or off on page 34. • Make sure that TV Auto Power On is set to On on the <i>INlink</i> menu. See Turning TV Auto Power On on or off on page 35. • The device may not support this feature. See the documentation that came with the device for more information.
The Audio Receiver setting on the <i>INlink</i> menu keeps turning back on after it is turned off.	<ul style="list-style-type: none"> • When Audio Receiver is set to Off and INlink Control is set to On and you make an adjustment to the audio receiver (for example, turn the volume knob or press a button), Audio Receiver is automatically set to On. To prevent this from happening, turn off the INlink feature. See Turning INlink on or off on page 34.
Two volume bars appear when adjusting the volume.	<ul style="list-style-type: none"> • When you adjust the volume on the audio receiver or with the TV remote control, a double volume bar appears, one for the TV volume and one for the audio receiver volume.

Note

If the problem is not solved by using these troubleshooting instructions, turn off your TV, then turn it on again.

Specifications

Specifications are subject to change without notice.

Dimensions and weight

	NS-48D510NA17	NS-55D510NA17 NS-55D510MX17
Without stand	42.6 × 24.8 × 3.3 in. (108.2 × 62.9 × 8.3 cm) 26.5 lbs. (12 kg)	48.8 × 28.2 × 3.3 in. (123.9 × 71.7 × 8.3 cm) 36.4 lbs. (16.5 kg)
With stand	42.6 × 26.8 × 9.7 in. (108.2 × 68 × 24.6 cm) 27.1 lbs. (12.3 kg)	48.8 × 30.4 × 10.6 in. (123.9 × 77.1 × 26.9 cm) 37.5 lbs. (17.0 kg)

Screen

	NS-48D510NA17	NS-55D510NA17 NS-55D510MX17
Screen size measured diagonally	47.6 in.	54.6 in.
Panel	LCD	LCD
Panel backlight type	LED	LED
Screen refresh rate	60Hz	60Hz
Display resolution	1080p	1080p
Panel resolution	1920 (H) × 1080 (V)	1920 (H) × 1080 (V)
Aspect ratio	16:9	16:9
Contrast ratio (typical)—panel	3,000:1	4,000:1
TV Brightness (minimum) cd/m²	240 nits	240 nits
Comb filter	3d y/c digital	3d y/c digital
Response time	8 ms	6.5 ms
Horizontal viewing angle	178°	178°
Vertical viewing angle	178°	178°

Display resolutions (both models)

HDMI suggested resolutions	1080p, 1080i, 720p, 480p, 480i
-----------------------------------	--------------------------------

Tuner (both models)

Analog	NTSC
Digital	ATSC, 8-VSB, Clear-QAM

Inputs (both models)

HDMI	3 (side) EDID compliant HDCP compliant
Component video	No
Composite video	1 (side)
USB	1 (side) Supports JPEG
Antenna/Cable	1 (side)
Analog audio	1 (side)

Outputs (both models)

Video	No
Analog audio/Headphone	1 (side)
Digital audio	1 (optical) (side)
WiFi	No
Ethernet	No

Audio

	NS-48D510NA17	NS-55D510NA17 NS-55D510MX17
DTS Tuning Package	DTS Sound	DTS Sound
Speakers	Number: 2 Watts per channel: 8W	Number: 2 Watts per channel: 10W

Power

	NS-48D510NA17	NS-55D510NA17 NS-55D510MX17
Power consumption	On: 108W Standby: <0.5W	On: 144W Standby: <0.5W
Power input	AC 120 V, 60Hz	AC 120 V, 60Hz

Miscellaneous (both models)

OSD languages	English, French, Spanish
INlink	Yes
Game Mode	Yes
ENERGY STAR qualified	No
Internet connectable	No
TV base screws	M4 type (20 mm length) (4 pcs)
V-Chip (version 2.0)	Yes
Sleep timer	Yes
Channel labeling	Yes
VESA mount (mm) (horizontal × vertical)	200 × 200
VESA mount screws	M6 type

Note

The length of the wall-mount screws vary depending on the wall-mount bracket you purchased. See the instructions that came with the wall-mount bracket for screw lengths.

Legal notices

FCC Statement

This device complies with Part 15 of the FCC Rules. Operation is subject to the following two conditions: (1) this device may not cause harmful interference, and (2) this device must accept any interference received, including interference that may cause undesired operation.

This equipment has been tested and found to comply with the limits for a Class B digital device, pursuant to Part 15 of the FCC Rules. These limits are designed to provide reasonable protection against harmful interference in a residential installation. This equipment generates, uses and can radiate radio frequency energy and, if not installed and used in accordance with the instructions, may cause harmful interference to radio communications. However, there is no guarantee that interference will not occur in a particular installation. If this equipment does cause harmful interference to radio or television reception, which can be determined by turning the equipment off and on, the user is encouraged to try to correct the interference by one or more of the following measures:

- Reorient or relocate the receiving antenna.
- Increase the separation between the equipment and receiver.
- Connect the equipment into an outlet on a circuit different from that to which the receiver is connected.
- Consult the dealer or an experienced radio/TV technician for help.

Warning

Changes or modifications not expressly approved by the party responsible for compliance could void the user's authority to operate the equipment.

Cables

Connections to this device must be made with shielded cables with metallic RF/EMI connector hoods to maintain compliance with FCC Rules and Regulations.

IC Statement

This device complies with Industry Canada licence—exempt RSS standard(s).

Operation is subject to the following two conditions: (1) this device may not cause interference, and (2) this device must accept any interference, including interference that may cause undesired operation of the device.

This equipment complies with IC radiation exposure limits set forth for an uncontrolled environment.

Dolby License Notice and Trademark Acknowledgement

 **DOLBY AUDIO**™ Manufactured under license from Dolby Laboratories. Dolby, Dolby Audio, and the double-D symbol are trademarks of Dolby Laboratories.

HDMI

 **HDMI**™ The terms HDMI and HDMI High-Definition Multimedia Interface, and the HDMI Logo are trademarks or registered trademarks of HDMI Licensing LLC in the United States and other countries.

DTS Sound™

 **dts**™ For DTS Patents, see <http://patents.dts.com>. Manufactured under license from DTS Licensing Limited. DTS, the Symbol, & DTS and the Symbol together are registered trademarks and DTS Sound is a trademark of DTS, Inc. © DTS, Inc. All Rights Reserved.

Open Source

Font name: Arimo

Version 1.23

Copyright 2013 Steve Matteson

Licensed under the Apache License, Version 2.0 (the "License"); you may not use this file except in compliance with the License. You may obtain a copy of the License at <http://www.apache.org/licenses/LICENSE-2.0>

Unless required by applicable law or agreed to in writing, software distributed under the License is distributed on an "AS IS" BASIS, WITHOUT WARRANTIES OR CONDITIONS OF ANY KIND, either express or implied. See the License for the specific language governing permissions and limitations under the License.

If you require additional information please call the Insignia support line at 1-877-467-4289.

One-year limited warranty - Insignia Televisions—US and Canada

Definitions:

Insignia Products ("Insignia") warrants to you, the original purchaser of this new Insignia-branded television ("Product"), that the Product shall be free of defects in the original manufacture of the material or workmanship for a period of one (1) year from the date of your purchase of the Product ("Warranty Period"). For this warranty to apply, your Product must be purchased in the United States or Canada from a Best Buy authorized dealer of Insignia brand products only that are packaged with this warranty statement.

How long does the coverage last?

The Warranty Period lasts for 1 year (365 days) from the date you purchased the Product. Your purchase date is printed on the receipt you received with the Product.

What does this warranty cover?

During the Warranty Period, if the original manufacture of the material or workmanship of the Product is determined to be defective by an authorized Insignia repair center or store personnel, Insignia will (at its sole option): (1) repair the Product with new or rebuilt parts; or (2) replace the Product at no charge with new or rebuilt comparable products or parts. Products and parts replaced under this warranty become the property of Insignia and are not returned to you. If service of Products or parts are required after the Warranty Period expires, you must pay all labor and parts charges. This warranty lasts as long as you own your Insignia Product during the Warranty Period. Warranty coverage terminates if you sell or otherwise transfer the Product.

How to obtain warranty service?

If you purchased the Product at a Best Buy retail store location and your television Product has a screen size of less than 42 inches, please take your original receipt and the Product to any Best Buy store. Make sure that you place the Product in its original packaging or packaging that provides the same amount of protection as the original packaging. If you purchased the Product from a Best Buy online web site, mail your original receipt and the Product to the address listed on the web site. Make sure that you put the Product in its original packaging or packaging that provides the same amount of protection as the original packaging.

To obtain in-home warranty service for a television with a screen 42 inches or larger, in the United States call 1-888-BESTBUY or in Canada call 1-866-BESTBUY. Call agents will diagnose and correct the issue over the phone or will have an Insignia-approved repair technician dispatched to your home.

Where is the warranty valid?

This warranty is valid only in the United States and Canada at Best Buy branded retail stores or websites to the original purchaser of the product in the country where the original purchase was made.

What does the warranty not cover?

This warranty does not cover:

- Customer instruction/education
- Installation
- Set up adjustments
- Cosmetic damage
- Damage due to acts of God, such as power surges
- Accident(s)
- Misuse, unintentional or intentional
- Abuse, unintentional or intentional
- Negligence
- Commercial purposes/use, including but not limited to use in a place of business or in communal areas of a multiple dwelling condominium or apartment complex, or otherwise used in a place of other than a private home.

- Modification of any part of the Product, including the antenna
- Plasma display panel damaged by static (non-moving) images applied for lengthy periods (burn-in).
- Damage due to incorrect operation or maintenance
- Connection to an incorrect voltage or power supply
- Outages, static or other problems with over-the-air reception of television broadcast signals.
- Attempted repair by any person not authorized by Insignia to service the Product
- Products sold "as is" or "with all faults"
- Consumables, including but not limited to batteries (i.e. AA, AAA, C etc.)
- Products where the factory applied serial number has been altered or removed
- Loss or Theft of this product or any part of the product
- Failures or Damage caused by any contact including but not limited to liquids, gels or pastes.
- Up to three (3) pixel failures (dots that are dark or incorrectly illuminated) grouped in an area smaller than one tenth (1/10) of the display size or up to five (5) pixel failures throughout the display. (Pixel based displays may contain a limited number of pixels that may not function normally.)
- Problems with delay in motion or action of video images while playing first-person style video games.

REPAIR REPLACEMENT AS PROVIDED UNDER THIS WARRANTY IS YOUR EXCLUSIVE REMEDY FOR BREACH OF WARRANTY. INSIGNIA SHALL NOT BE LIABLE FOR ANY INCIDENTAL OR CONSEQUENTIAL DAMAGES FOR THE BREACH OF ANY EXPRESS OR IMPLIED WARRANTY ON THIS PRODUCT, INCLUDING, BUT NOT LIMITED TO, LOST DATA, LOSS OF USE OF YOUR PRODUCT, LOST BUSINESS OR LOST PROFITS. INSIGNIA PRODUCTS MAKES NO OTHER EXPRESS WARRANTIES WITH RESPECT TO THE PRODUCT, ALL EXPRESS AND IMPLIED WARRANTIES FOR THE PRODUCT, INCLUDING, BUT NOT LIMITED TO, ANY IMPLIED WARRANTIES OF AND CONDITIONS OF MERCHANTABILITY AND FITNESS FOR A PARTICULAR PURPOSE, ARE LIMITED IN DURATION TO THE WARRANTY PERIOD SET FORTH ABOVE AND NO WARRANTIES, WHETHER EXPRESS OR IMPLIED, WILL APPLY AFTER THE WARRANTY PERIOD. SOME STATES, PROVINCES AND JURISDICTIONS DO NOT ALLOW LIMITATIONS ON HOW LONG AN IMPLIED WARRANTY LASTS, SO THE ABOVE LIMITATION MAY NOT APPLY TO YOU. THIS WARRANTY GIVES YOU SPECIFIC LEGAL RIGHTS, AND YOU MAY ALSO HAVE OTHER RIGHTS, WHICH VARY FROM STATE TO STATE OR PROVINCE TO PROVINCE.

Contact Insignia:

1-877-467-4289

www.insigniaproducts.com

INSIGNIA is a trademark of Best Buy and its affiliated companies.

Distributed by Best Buy Purchasing, LLC

©2017 Best Buy. All rights reserved.

Made in China

One-year limited warranty - Insignia Televisions—Mexico

Esta póliza de garantía, expedida por Best Buy Imports, S. de R.L. de C.V. (Best Buy), con domicilio en Av. Santa Fe No.440 Piso 2 OFNA 202 y 203 P3 y P4, Col. Santa Fe Cuajimalpa, C.P. 05348, Del. Cuajimalpa de Morelos, México, Distrito Federal, teléfono (01) (52) (55) 88-50-20-00 para productos de la marca **INSIGNIA, DYNEX, ROCKETFISH, PLATINUM** y **MODAL** (el "Producto" o los "Productos") establece las normas y condiciones de garantía para el Producto que se describe en la siguiente tabla de Productos adquiridos por el cliente (cómo se define más adelante) en tiendas Best Buy localizadas dentro de la República Mexicana.

El tiempo de garantía aplicable a cada producto será marcado con una "x" por el vendedor en el listado que antecede al momento de su venta. El tiempo de garantía correspondiente empieza a correr a partir de la **Fecha de compra y recepción** * que se coloca al momento de su venta.

DYNEX	
ACCESORIOS DE COMPUTO	1 AÑO
ACCESORIOS PARA LAPTOPS	1 AÑO
CABLES	1 AÑO / LIMITADO DE POR VIDA
LIMPIEZA DE AV	1 AÑO
RATONES	1 AÑO
SOPORTES DE TV	3 AÑOS
SUPRESORES DE PICOS	1 AÑO
TECLADOS	1 AÑO
OTROS ACCESORIOS	1 AÑO
OTROS PRODUCTOS HARDWARE	1 AÑO
ROCKETFISH	
ACCESORIOS PARA LAPTOPS	1 AÑO
ACCESORIOS PARA VIDEOJUEGOS	90 DÍAS
ADAPTADORES	1 AÑO
ADAPTADORES LAPTOPS	3 AÑOS
ALIMENTACIÓN CPU	1 AÑO
AMPLIFICADORES DE CABLES	1 AÑO
AUDÍFONOS PARA CELULAR	1 AÑO
BOCINAS	1 AÑO
CABLES	1 AÑO / LIMITADO DE POR VIDA
CARGADORES	1 AÑO
CONECTORES	1 AÑO
REGULADORES DE CORRIENTE	1 AÑO
SELECTOR DE BOCINAS	1 AÑO
SOPORTES DE TV	5 AÑOS
OTROS ACCESORIOS	LIMITADO DE POR VIDA
OTROS PRODUCTOS HARDWARE	1 AÑO
MODAL	
ACCESORIOS	LIMITADO DE POR VIDA
PRODUCTOS HARDWARE	1 AÑO

INSIGNIA	
ACCESORIOS AUDIO PORTÁTIL	90 DÍAS
ACCESORIOS DE COMPUTO	1 AÑO
ACCESORIOS PARA LAPTOPS	1 AÑO
ACCESORIOS PARA VIDEOJUEGOS	90 DÍAS
ADAPTADORES	1 AÑO
ADAPTADORES LAPTOPS	1 AÑO/3 AÑOS
BOCINAS	90 DÍAS / 1 AÑO
BOCINAS DE COMPUTO	1 AÑO
BOOM BOXES / GRABADORAS	90 DÍAS
CABLES	1 AÑO / LIMITADO DE POR VIDA
CARGADORES	1 AÑO
CONECTORES	1 AÑO
DVD PORTÁTIL	90 DÍAS / 1 AÑO
LIMPIEZA DE AV	1 AÑO
MUEBLES	1 AÑO
RADIO RELOJ	90 DÍAS
RATONES	1 AÑO
RECEPTORES	1 AÑO
SISTEMAS COMPACTOS	90 DÍAS
TABLETAS	90 DÍAS
TEATRO EN CASA	1 AÑO
TECLADOS	1 AÑO
TELEVISIONES	1 AÑO
TRIPES Y MONOPIES	1 AÑO
OTROS ACCESORIOS	1 AÑO
OTROS PRODUCTOS HARDWARE	1 AÑO

PLATINUM	
MALETINES	1 AÑO
ESTUCHES PARA CÁMARAS	1 AÑO
OTROS ACCESORIOS	LIMITADO DE POR VIDA
OTROS PRODUCTOS HARDWARE	1 AÑO

Para efectos de esta Póliza, se entenderá como Cliente, aquellos que adquieran con carácter de usuario final, cualesquiera de los Productos vendidos en las tiendas Best Buy, localizadas dentro de los Estados Unidos Mexicanos ("México").

CONCEPTOS

Mediante esta garantía, Best Buy se compromete a respaldar el Producto contra cualquier defecto de los materiales y/o mano de obra empleados en la fabricación del Producto. Asimismo, la presente garantía ampara todas las piezas y componentes de este producto. Best Buy reparará el Producto en caso de estar defectuoso, y reemplazará la pieza o componente defectuosos, sin costo para el Cliente, incluyendo la mano de obra y los gastos de transportación derivados de su cumplimiento en nuestra red de servicio que más adelante se detallará.

CONDICIONES

1. Notificación de las reclamaciones.

Solamente será necesario para ejercer la garantía, presentar el Producto y la póliza de garantía debidamente sellada por el establecimiento de Best Buy que lo vendió o se puede presentar la factura, o recibo, o el comprobante en el que consten los datos específicos del producto adquirido.

Garantía de Servicio: Si el Cliente identifica que el Producto tiene partes, componentes o materiales defectuosos, o defectos por mano de obra, deberá dar aviso con prontitud y una explicación de la reclamación a la tienda Best Buy donde adquirió su Producto y/o al centro de servicio especializado señalado en esta póliza. Todas las reclamaciones para efectos de la presente garantía deberán hacerse dentro de la vigencia de la misma. El personal especializado del centro de servicio, realizará una inspección al Producto con el fin de determinar la procedencia de la garantía. Ninguna reparación o reposición de cualquier Producto o parte del mismo se hará sin cargo fuera de la vigencia de la garantía del Producto. La garantía sobre la reparación de una falla específica así como de las partes empleadas para la misma, estará vigente por el período restante de la garantía del Producto o por un período de 90 (noventa) días contados a partir de la fecha de reparación del Producto o instalación de los repuestos, lo que resulte mayor. Durante el período de garantía, para reparar el Producto defectuoso, el Cliente podrá llevarlo a la tienda Best Buy en que lo adquirió, o al centro de servicio especializado señalado en esta póliza. El Cliente deberá presentar el Producto defectuoso con la póliza de garantía debidamente sellada por la tienda Best Buy. Una vez reparado, Best Buy, o sus representantes, entregarán el Producto al Cliente, en la misma tienda Best Buy en la que fue reclamada la garantía. Best Buy no está obligado a proporcionar al Cliente un Producto sustituto durante el período de evaluación y en su caso de reparación en que el Producto defectuoso se encuentre en el centro de servicio autorizado.

2. Recurso exclusivo.

Aceptación: El recurso exclusivo del Cliente y la única obligación de Best Buy consiste en realizar todos los trabajos necesarios para reparar cualquier Producto que se determine como defectuoso dentro del periodo de esta garantía y proporcionar, sin cargo extra para el Cliente, los repuestos de las partes defectuosas. [En el caso de que la reparación del Producto o el reemplazo de partes no solucione el defecto, o que hayan transcurrido 30 días posteriores a la recepción del Producto para su reparación, o se hayan realizado 3 (tres) reparaciones consecutivas sobre la misma falla e incurra en una cuarta entonces y sólo en dichos casos, Best Buy substituirá el Producto defectuoso por otro igual ó de similares características, o reembolsará al Cliente el precio de adquisición de dicho Producto, en la fecha en que fue adquirido]

3. Excepciones de la Garantía Limitada:

Best Buy no tendrá responsabilidad ni obligación ante el Cliente y por lo tanto se exime de hacer efectiva la garantía en los siguientes casos: (i) cuando el Producto se hubiese utilizado en condiciones distintas a las normales; (ii) cuando el Producto no hubiese sido operado de acuerdo con el instructivo de uso que se le acompaña; y (iii) cuando el Producto hubiese sido alterado o reparado por personas no autorizadas por Best Buy. Best Buy excluye también todos aquellos Productos que no hayan sido vendidos por Best Buy en cualquiera de sus tiendas localizadas dentro de la República Mexicana. No están cubiertas por la presente garantía las partes consumibles del Producto. Esta garantía cubrirá defectos y/o fallos dentro del período de garantía derivado de cualquier defecto de los materiales en la fabricación del Producto.

4. Validez territorial: La presente póliza de garantía es válida únicamente en la República Mexicana.

RENUNCIA DE LA GARANTIA:

Excepto por la garantía aquí estipulada, la cual cumple con lo dispuesto por la NOM-024-SCFI-2013, Best Buy excluye expresamente del alcance de la presente garantía cualquier otra garantía explícita o implícita incluyendo, sin limitar, todas o cualquier declaración o garantías de comerciabilidad y/o aplicación o uso del Producto para propósitos específicos. Best Buy excluye expresamente, a toda y cualesquiera garantía relativas a que su Producto sea compatible con cualquier otro Producto o combinación de productos diferentes a los Productos de la marca INSIGNIA, DYNEX, ROCKETFISH, PLATINUM y MODAL a los que el Cliente decida conectar el Producto.

DATOS DEL PRODUCTO ADQUIRIDO:

Modelo: _____

No. de serie: _____

Tienda donde se adquirió: _____

Dirección de la tienda:

Calle _____ no _____

Col. _____ C.P. _____

Delegación/Municipio _____ Ciudad/ Estado _____

Las Tiendas Best Buy en la Republica Mexicana, son los establecimientos donde se puede hacer efectiva la garantía donde se pueden obtener componentes, consumibles y accesorios del Producto: Centro de Servicio (y/o red de servicio):

- BEST BUY MUNDO E: Bvd. Manuel Ávila Camacho, No. 1007, San Lucas Tepetlatalco, Tlalnepantla, C.P. 54055, Estado de México.
- BEST BUY INTERLOMAS: Boulevard Magnocentro 35, Col. Centro Urbano San Fernando la Herradura C.P 52784 Huixquilucan, Estado de México.
- BEST BUY ACOXPA: Avenida Acoxpa 430 Col. Ex Hacienda Coapa, Del. Tlalpan, C.P 14300, México D.F.
- BEST BUY POLANCO: Francisco Petrarca 202 Col. Polanco, Del. Miguel Hidalgo, C.P. 11570, México D.F.
- BEST BUY CIUADADELA: Calle Labna 1437, Col. Ciudad del Sol, C.P. 45071, Zapopan, Jalisco.
- BEST BUY GALERIAS: Av. Rafael Sanzio 150, Sub Ancla 3, Col. La Estancia, C.P. 45030, Zapopan, Jalisco.
- BEST BUY TLAQUEPAQUE: Boulevard Marcelino García Barragán, N° 2077 y 2377, Col. Prados del Nilo, C.P. 44840, Guadalajara, Jalisco.
- BEST BUY CUAUTITLAN: Av. Primero de Mayo, S/N, Manzana C-34-C', Col. Centro Urbano, Cuautitlán Izcalli, Estado de México.
- BEST BUY MORELIA: Avenida Montaña Monarca Norte N° 1000, Col. Desarrollo Montaña Monarca C.P. 58350, Morelia, Michoacán.
- BEST BUY PEDREGAL: Calle de Ladera no. 16 Col. Jardines del Pedregal de San Ángel, C.P. 04500, Del. Coyoacán México, D.F.
- BEST BUY MONTERREY: Av. Batallón de San Patricio No. 1000 Col. Residencial San Agustín, C.P. 66260, San Pedro Garza García, Nuevo León, Monterrey.
- BEST BUY ANDARES: Blvd. Puerta de Hierro no. 4965 Fracc. Plaza Andares, C.P. 45116, Zapopan, Jalisco

También consulte el listado de los nuevos establecimientos en <http://www.bestbuy.com.mx/tiendas>

Sello del establecimiento que vendió el Producto:

(O puede presentar la factura, o recibo, o el comprobante en el que consten los datos específicos del producto adquirido)

Fecha de compra y recepción*

DÍA	MES	AÑO
-----	-----	-----

Fecha de Instalación (en caso de ser aplicable)

_____/_____/_____

Centro de atención telefónica para D.F. e interior de la República:

01-800 BESTBUY (2378289)

<http://www.bestbuy.com.mx/>

INSIGNIA™

If the power cord is damaged, it must be replaced by the manufacturer or its service agent or qualified personnel to avoid risk.

For product inquiries or accessibility assistance, please contact us with the information below:

www.insigniaproducts.com

U.S. and Canada:

1-877-467-4289

INSIGNIA is a trademark of Best Buy and its affiliated companies.

Distributed by Best Buy Purchasing, LLC

7601 Penn Ave South, Richfield, MN 55423 U.S.A.

©2017 Best Buy. All rights reserved.

Made in China

Mexico:

01800-926-3000

Best Buy Imports S. DE R.L. DE C.V.

Avenida Santa Fe No. 440 Piso 2 Ofna 202 Y 203 P3 Y P4

Colonia Santa Fe Cuajimalpa, C.P. 05348, Delegación Cuajimalpa De Morelos,
Mexico, Ciudad De México

©2017 Best Buy. All rights reserved.

Made in China