



CINEMA SB200

powered soundbar speaker



QUICK-START GUIDE

THANK YOU FOR CHOOSING THIS JBL® PRODUCT

The JBL Cinema SB200 powered soundbar speaker is a complete, integrated sound system that will dramatically improve the sound of programs you watch on your television. It can mount on a wall or sit on a shelf and includes all of the cables you need to connect it to your TV and your cable/satellite tuner or disc player.

We're confident that this JBL system will provide every note of enjoyment that you expect – and that when you think about purchasing additional audio equipment for your home, car or office, you will once again choose JBL products.

This quick-start guide contains all the information you need to set up, connect and adjust your new speaker system. For more in-depth information, go to our Web site: www.jbl.com.

INCLUDED ITEMS

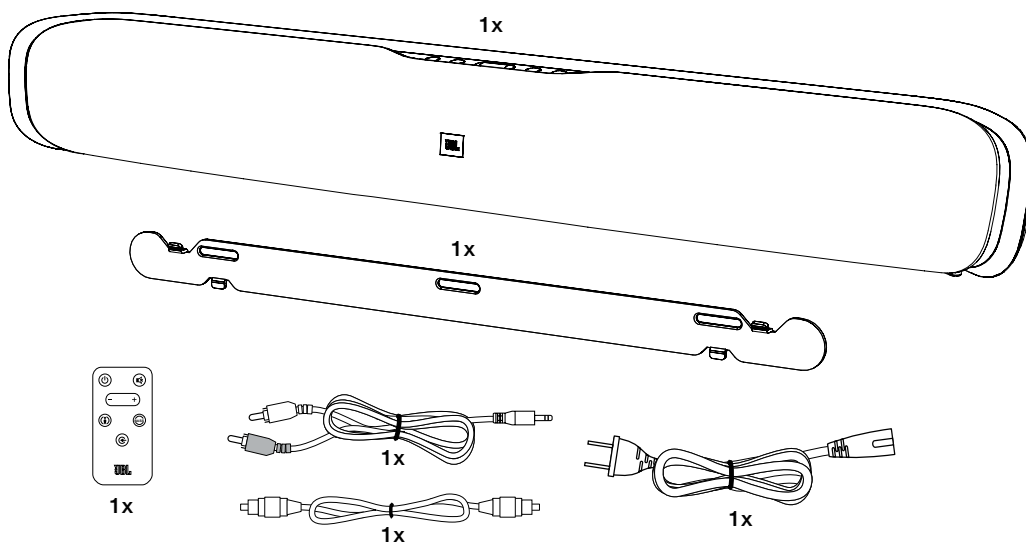

SOUNDBAR REAR-PANEL CONTROLS AND CONNECTIONS

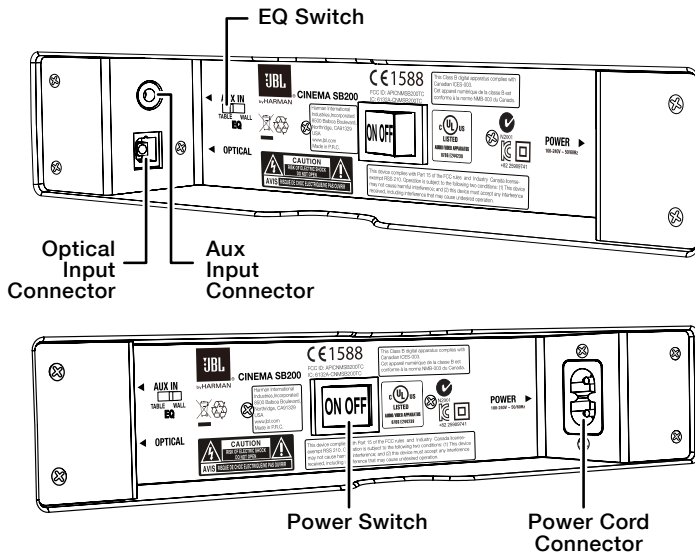

EQ switch: Use this switch to adjust the soundbar's bass for either wall or table mounting. If you're mounting the soundbar on a wall with the included wall-mount bracket, set the EQ switch to the "Wall" position for the most natural-sounding bass performance. If you are placing the soundbar on a table, set the EQ switch to the "Table" position for the most natural-sounding bass performance.

Optical Input connector (digital): If your TV, disc player or cable/satellite tuner has an optical digital output, use the included optical cable to connect it here.

NOTE: You can connect different source components to the analog and digital connections.

Aux Input connection (analog): Use the included stereo 3.5mm to stereo RCA audio cable to connect the stereo analog outputs of your TV, disc player or cable/satellite tuner here.

Power switch: Set this switch to the "On" position to activate the soundbar. In normal operation, this switch will be left in the "On" position. See *Turning the Soundbar On and Off*, on page 5, for more information.

Power Cord connector: Connect the included power cord here. See *Power Connections*, on page 5, for more information.

IMPORTANT: Do not connect the power cord to an AC outlet until you have made and verified all other connections.

If you will not be using the soundbar for an extended period – for instance, if you're going on vacation – set the Power switch to the "Off" position.

SOUNDBAR TOP-PANEL CONTROLS AND REMOTE CONTROL

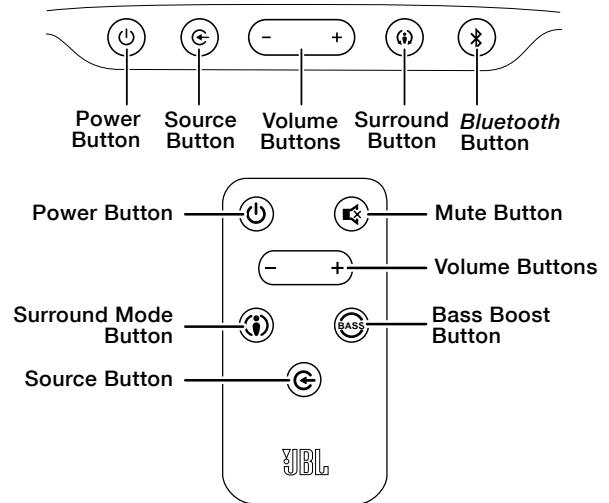

Power button: To turn the soundbar on when it is in the Standby mode, press the Power button on either the soundbar or the remote. (The Power indicator will turn white.) To put the soundbar in the Standby mode, press either Power button while the system is on. (The Power indicator will turn amber.) If you do not press the Power button, the soundbar will automatically go into the Standby mode approximately 10 minutes after the audio signal ceases.

NOTE: If you put the soundbar into the Standby mode by pressing the Power button, you must manually turn it on by pressing the Power button again.

Mute button (remote control only): Press the Mute button to mute the soundbar. (The Volume +/- indicators both illuminate white.) While the system is muted, press the Mute button again or either Volume button to restore the sound.

NOTE: Pressing both of the soundbar's Volume buttons at the same time while the system is on will mute the system. Pressing either Volume button while the system is muted will restore the sound.

Surround Mode button: This button turns the soundbar's HARMAN Display Surround processing on and off. The Surround button indicator turns amber when HARMAN Display Surround is active, and turns white when HARMAN Display Surround is not active (normal stereo sound). See *Surround Mode Buttons*, on page 6, for more information.

Volume Up/Down buttons: Press the "+" button to increase the volume; press the "-" button to decrease the volume. The buttons illuminate white for a few seconds after being pressed.

Source Selector button: This button switches between the sources connected to the Aux (analog) and Optical (digital) inputs. When the Aux input is active, the Source indicator turns white; when the Optical input is active, the Source indicator turns amber.

Bluetooth button (soundbar only): Press this button to play the audio stream from a paired *Bluetooth* device through the soundbar. (The button LED will illuminate blue when a paired *Bluetooth* device is the active source.) Press and hold this button to force the soundbar into the *Bluetooth* pairing mode. See *Bluetooth Operation*, on page 5, for more information.

Bass Boost button (remote control only): Press the remote's Bass Boost button to enhance low-frequency performance. Pressing the Bass Boost button again will return the soundbar's normal low-frequency performance.

SOUNDBAR PLACEMENT

PLACING THE SOUNDBAR ON A TABLE

If your TV is placed on a table, you can place the soundbar on the table directly in front of the TV stand, centered with the TV screen. As long as the surface of the table is flat, the soundbar will rest on its rubber bumpers.

- Set the soundbar's EQ switch in the "Table" position. See *Soundbar Rear-Panel Controls and Connections*, on page 2.

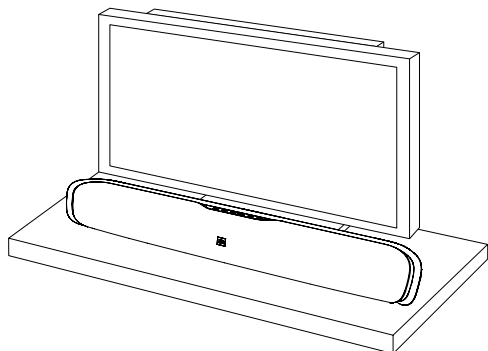

WALL-MOUNTING THE SOUNDBAR

If your TV is attached to a wall, you can use the included wall-mount bracket to mount the soundbar on the wall directly below the TV screen.

1. Determine the location for the soundbar on the wall. Make sure that the top of the soundbar will not block your view of the TV screen when it is mounted on the wall.
2. Hold the bracket against the wall as a template and mark the locations of the soundbar wall-mount bracket holes on the wall. The three holes should be evenly spaced 7-1/16" (18cm) apart, and the bracket slots are designed to accept 4mm screws. Make sure that the holes are at the same height. See the illustration below.

Mark Three Bracket Hole Locations
7-1/16" (18cm) Apart

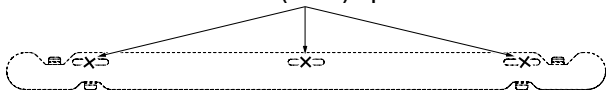

3. Making sure that the bracket's flat side is against the wall, attach the wall-mount bracket to the wall at the locations you marked, using hardware that is appropriate for the wall's construction and materials. Note that the soundbar weighs 7.5 lb (3.4kg). Be sure to use hardware that can support this weight.

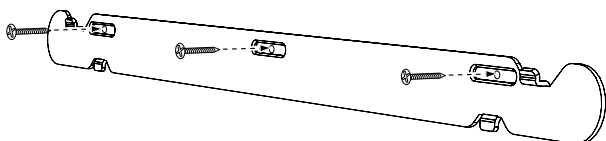

4. After reading the *Connections* section on page 4, connect all cables to the soundbar.

IMPORTANT: Do NOT plug the soundbar's power cord into an AC outlet at this time.

- Set the soundbar's EQ switch in the "Wall" position, and set the soundbar's Power switch in the "On" position. See *Soundbar Rear-Panel Controls and Connections*, on page 2.
5. Attach the soundbar to the bracket by sliding the bracket's upper tabs into the slots on the back of the soundbar. The soundbar's slots allow you to adjust the soundbar's angle on the wall to ensure that it is level.

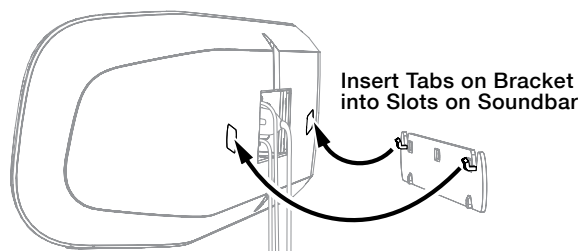

CONNECTIONS

SOURCE CONNECTIONS

Analog: Use the supplied stereo audio cable to connect the soundbar's Aux (analog) input to your TV's stereo audio output. If your TV has two sets of audio output jacks, use the set that has a fixed (not variable) output level. This will let you turn your TV's speakers all the way off while the TV still supplies a constant audio signal to the soundbar.

Digital: If your disc player, cable tuner or satellite tuner has an optical digital output, you can use the supplied optical digital audio cable to connect it to the soundbar's Optical (digital) input.

NOTE: If your disc player, cable tuner or satellite tuner does not have an optical digital output, you can connect its analog audio output to your TV. The TV will send its audio signal to the soundbar through the analog connection described above.

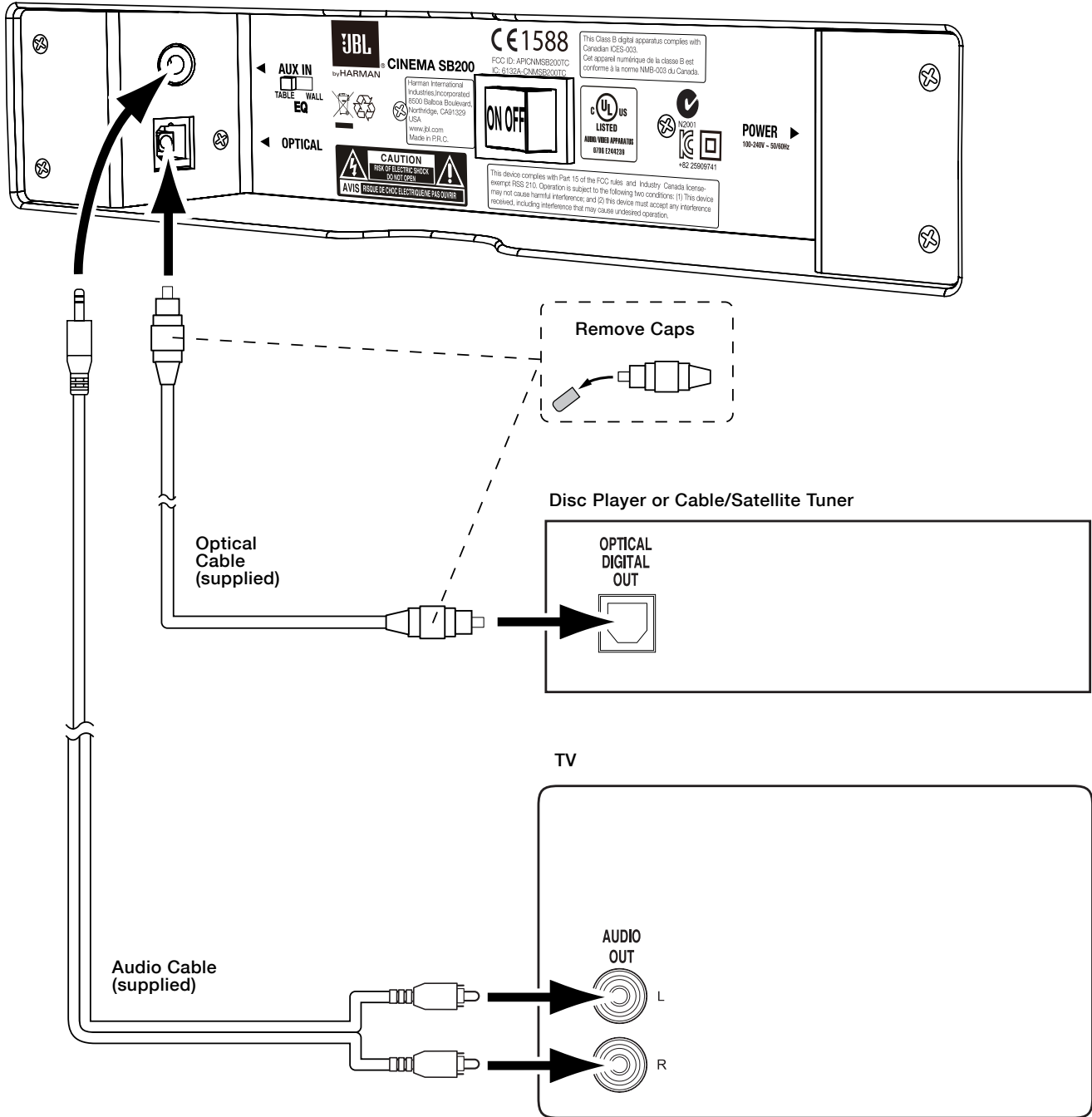

POWER CONNECTIONS

After verifying that all of the source connections have been made properly, plug the supplied power cord into the soundbar's Power Cord connector, and plug the other end into an active, *unswitched* AC outlet. Do NOT plug this cord into the accessory outlet found on some audio components.

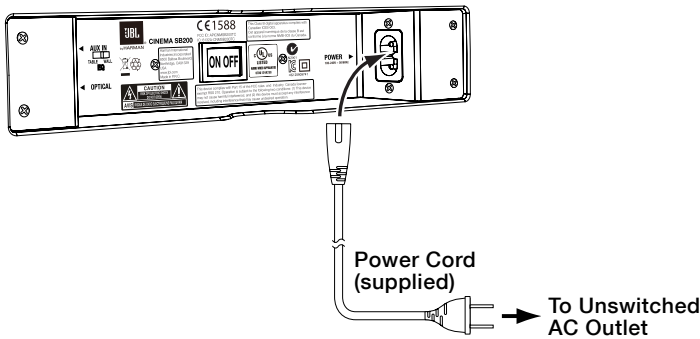

USING YOUR SOUNDBAR SYSTEM

TURNING THE SOUNDBAR ON AND OFF

Set the soundbar's Power switch to the "On" position.

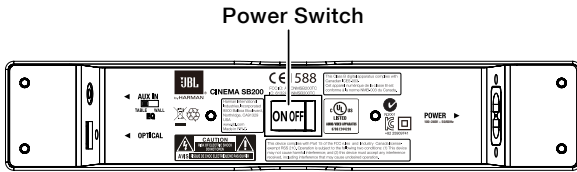

Press the Power button on either the soundbar or the remote to turn the soundbar on. To put the soundbar in the Standby mode, press either Power button while the soundbar is on.

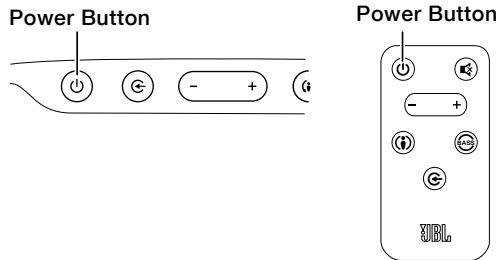

If you do not press the Power button, the soundbar will automatically go into the Standby mode approximately 10 minutes after the audio signal ceases. NOTE: If you have put the soundbar into the Standby mode by pressing the Power button, you must manually turn it on by pressing the Power button again. If the soundbar has automatically gone into the Standby mode 10 minutes after the audio signal has ceased, it will automatically turn itself on when it receives an audio signal at either input connection.

If you will be away from home for an extended period of time, or if you will not be using the soundbar for an extended period, set the soundbar's Power switch to the "Off" position.

BLUETOOTH OPERATION

To wirelessly stream audio to the soundbar from a *Bluetooth*-enabled device:

1. Confirm that the soundbar is in the *Bluetooth* pairing mode (the *Bluetooth* button LED will be flashing blue). If the LED is not flashing blue, press and hold the *Bluetooth* button until its LED begins to flash blue.

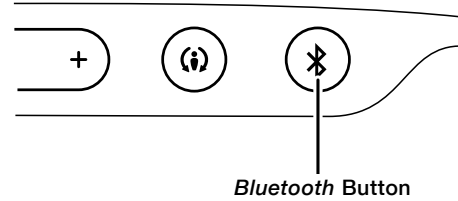

2. Place the device in the pairing mode. Use the device's *Bluetooth* pairing menu to pair it with the soundbar. (The soundbar will appear as "SB200" in the device's menu.) If the device requires a passcode, use 0000.
3. When the soundbar's *Bluetooth* button LED illuminates constantly, it is paired with the device and you can stream audio via *Bluetooth* from the device to the soundbar.

To disconnect the *Bluetooth* device, press and hold the soundbar's *Bluetooth* button until the LED begins flashing. To pair the soundbar with a different *Bluetooth*-enabled device, repeat Steps 1 – 3 with the new device.

Notes on *Bluetooth* operation:

- You can manually switch sources to the paired *Bluetooth* device by pressing the soundbar's *Bluetooth* button.
- If you switch the soundbar to a different source while a paired *Bluetooth* device is streaming to the soundbar, the soundbar will send a Stop command and the *Bluetooth* device will stop streaming.

SWITCHING SOURCES

Press the soundbar's or remote's Source button to switch between the devices you connected to the Aux input and Optical input and a device streaming audio via *Bluetooth*. When the Aux input is active the soundbar's Source indicator will illuminate white; when the Optical input is active the soundbar's Source indicator will illuminate amber.

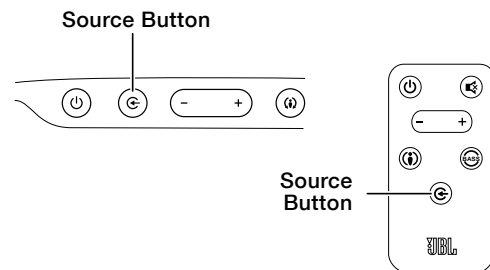

ADJUSTING THE SYSTEM'S VOLUME

Press the soundbar's or remote's Volume + and - buttons to raise and lower the system's volume one step at a time. Hold down the buttons to continuously raise or lower the volume.

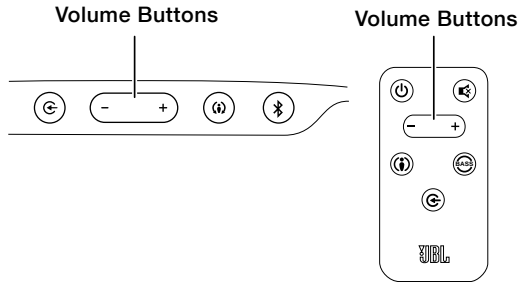

For the best sound, we recommend turning your TV's built-in speakers off. Consult your TV's owner's manual to find out how to do this.

MUTING THE SYSTEM

Momentarily press both of the soundbar's Volume buttons at the same time, or press the remote's Mute button to mute the system. (Both Volume indicators illuminate.) Momentarily press either of the soundbar's Volume buttons or press the remote's Mute button again to un-mute the system. (The Volume indicators turn off.)

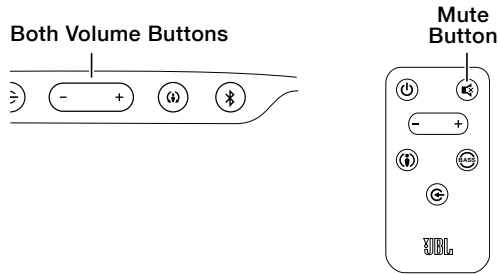

CHANGING THE SURROUND MODE

Press the soundbar's or remote's Surround Mode indicator to switch the sound between normal stereo (the Surround Mode indicator lights white) and HARMAN Display Surround (the Surround Mode indicator lights amber). The HARMAN Display Surround setting will produce a complete surround-sound experience for anyone sitting in front of and several feet away from the soundbar. Although it is particularly effective when watching movies, you can also try the HARMAN Display Surround setting for music.

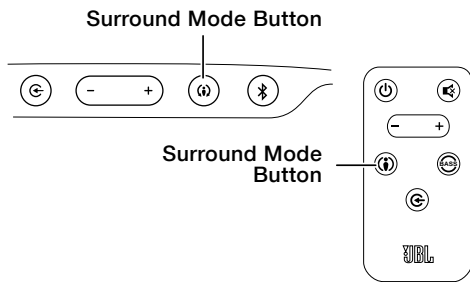

BOOSTING THE BASS

Press the remote's Bass Boost button to enhance low-frequency performance, resulting in bass with more impact, which you may prefer while watching movies or listening to music. There is no harm in experimenting with this control. Pressing the Bass Boost button again will return the soundbar's normal low-frequency performance.

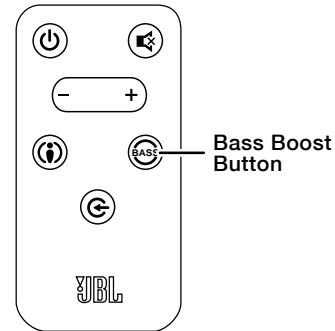

LEARNING YOUR TV REMOTE'S VOLUME AND MUTE COMMANDS

You can program the soundbar so it will respond to your TV remote's volume up, volume down and mute commands. This will let you control both the soundbar and your TV with a single remote. Before you begin to program the soundbar, have your TV remote in hand.

1. Press and hold the soundbar's Surround button until the button begins flashing amber.

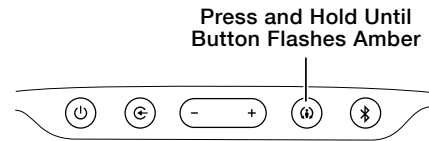

2. Hold your TV's remote approximately 12" (30cm) from the front of the soundbar and aim the remote directly at the soundbar:

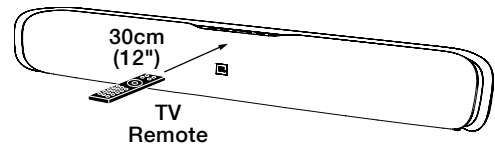

- Press the TV remote's volume up button while pressing and holding the soundbar's Volume + button. If the programming was successful the soundbar's Surround button will change from amber to solid white for one second, then will return to flashing amber.

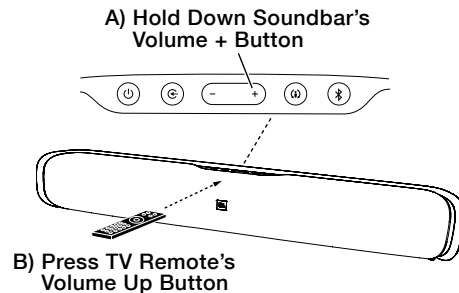

- Press the TV remote's volume down button while pressing and holding the soundbar's Volume – button. If the programming was successful the soundbar's Surround button will change from amber to solid white for one second, then will return to flashing amber.

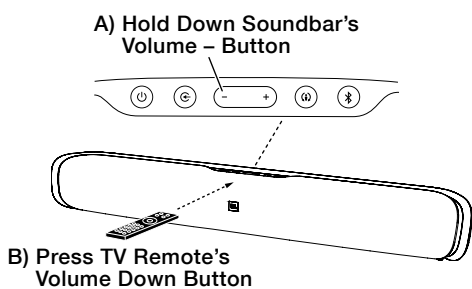

- Press the TV remote's mute button while pressing and holding the soundbar's Volume + and Volume – buttons at the same time. If the programming was successful the soundbar's Surround button will change from amber to solid white for one second, then will return to flashing amber.

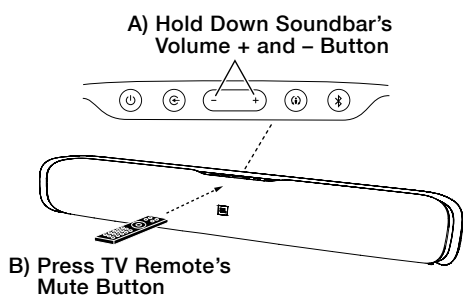

3. When you're finished, press and hold the soundbar's Surround button until the button stops flashing amber.

The soundbar will now respond to your TV remote's volume and mute commands.

SPECIFICATIONS

CINEMA SB200 POWERED SOUNDBAR SPEAKER

Low-frequency transducer:	One 3-1/2" (89mm) cone per channel
High-frequency transducer:	One 1" (25mm) dome per channel
Amplifier power:	60 watts peak per channel
Frequency response:	55Hz – 23kHz (-6dB)
Power requirement:	100V – 240V, 50Hz/60Hz, 60W
Power consumption:	<0.5W (standby); 60W (maximum)
Dimensions (H x W x D):	4-9/16" x 35-1/2" x 4-1/16" (116mm x 901mm x 103mm)
Weight (shipping):	11.5 lb (5.1kg)



HARMAN HARMAN International Industries, Incorporated
8500 Balboa Boulevard, Northridge, CA 91329 USA

© 2012 HARMAN International Industries, Incorporated. All rights reserved. JBL is a trademark of HARMAN International Industries, Incorporated, registered in the United States and/or other countries.

The *Bluetooth* word mark and logo are registered trademarks and are owned by the *Bluetooth* SIG, Inc., and any use of such marks by HARMAN International Industries, Incorporated, is under license.

All Rights Reserved. Features, specifications and appearance are subject to change without notice.

Part No. 950-0471-001 Rev: A

www.jbl.com