

3-25-85

**108, 111, 112L,
116, and 116H
Lawn Tractors**

(Identification No. 315,001-)



**OPERATOR'S
MANUAL**



** Note See Inside Cover*

**John Deere Horicon Works
OM-M88424 Issue J4**

LITHO IN USA

DEALER'S RECORD

Owner's Name _____

Date Sold _____

Address _____

Lawn Tractor Model _____

City _____

Product Identification Number _____

State _____ Zip _____

Engine Serial Number _____

A98; M21;;DLJ 01 130784

PREDELIVERY CHECKLIST

Check the following before you deliver the lawn tractor to the customer.

- 1. Guards and shields fastened in place.
- 2. Decals fastened and legible.
- 3. Tire pressure.
- 4. Mower level.
- 5. Lubrication points.
- 6. Transmission oil level.
- 7. Engine oil level.
- 8. Air cleaner.
- 9. Battery terminal cover fastened over positive (+) terminal.
- 10. Battery electrolyte level.

- 11. Battery charge.
- 12. Add fuel. Start engine. Test drive.
- 13. Break-in PTO clutch: Run engine at half throttle. Turn PTO switch on and off 10 times at 5 second intervals at no load.
- 14. Check neutral-start switch and PTO safety-start switch.
- 15. Steering.
- 16. Brakes.
- 17. Controls.
- 18. Touch up scratches in tractor and mower finish.
- 19. Clean and polish tractor and mower.

Date Set Up _____

Signature _____

** when putting on mower Deck Release Tensioner ON Right Side of Deck*

A98; M21;;DLJ 02 271083

DELIVERY CHECKLIST

Review the operator's manual with the customer.

Explain the following:

- | | |
|--|--|
| <input type="checkbox"/> 1. John Deere warranty. | <input type="checkbox"/> 9. Servicing the tractor and mower regularly and correctly. |
| <input type="checkbox"/> 2. Safe operation and service. | <input type="checkbox"/> 10. John Deere parts and service. |
| <input type="checkbox"/> 3. How to use controls. | <input type="checkbox"/> 11. Have the customer write machine numbers in the Specification section. |
| <input type="checkbox"/> 4. Operating the machine correctly. | <input type="checkbox"/> 12. Remove and file this page. |
| <input type="checkbox"/> 5. Transporting the tractor and mower on a trailer. | <input type="checkbox"/> 13. Give the customer the operator's manual. Encourage the customer to read the manual. |
| <input type="checkbox"/> 6. Correct fuel and lubricants. | |
| <input type="checkbox"/> 7. Daily and periodic inspections. | |
| <input type="checkbox"/> 8. Changing engine oil (and filter) after first 5 hours of operation. | |

Date Delivered

Signature

A98; M21;;DLJ 03 170784

Contents

	Page
Safety	2
Controls	10
Prestarting Checks	13
Operating the Engine	14
Driving the Tractor	20
Operating the Mower	24
Transporting	37
Fuels and Lubricants	39
Troubleshooting	42
Periodic Service	47
Service	
Before Each Use	50
10-Hours	54
25-Hours	55
50-Hours	63
100-Hours	64
Yearly	66
As Necessary	69
Storage	79
Crime Prevention Tips	82
Assembly	84
Specifications	87
Index	90

Safety

CERTIFICATION

This OPEI seal on your mower means:

—Your model lawn tractor with mower has been certified by an independent laboratory for meeting American National Standard B71.1, 1980, "Safety Specifications for Power Lawn Mowers, Lawn and Garden Tractors, and Lawn Tractors".



A98;M35175 M21;;SAJ 19 170784

READ SPECIAL MESSAGES

A "CAUTION" means that you may be injured if you do not follow instructions. When you see the caution symbol at the right, obey the safety message to avoid personal injury.

An "IMPORTANT" message means that your machine may be damaged if you do not do what the message tells you.

A "NOTE" gives you helpful information.



A98;T81389 M21;;SAJ 20 170784

READ SAFETY SIGNS

Carefully read and follow all **DANGER** and **CAUTION** safety signs.

Keep safety signs in good condition. Replace any damaged or missing safety signs.



M24364



M24365

Mower Safety Signs

A98;M24364, M24365 M21;;SAJ 21 170784

M65;P02 040884

Fender Deck Safety Sign



CAUTION

AVOID BODILY INJURY

- READ OPERATOR'S MANUAL
- Know location and function of controls
- Keep all shields in place
- Stay clear of power driven parts
- Never carry riders
- Keep people and pets a safe distance away from mower

BEFORE DISMOUNTING OR SERVICING

- Shut off engine and remove key
- Lock brake for park

A98;M35097 M21;;SAJ 22 170784

Fuel Safety Sign



CAUTION

FUEL MAY EXPAND AND OVERFLOW

- Fill only to bottom of neck
- Read operator's manual

A98;M35098 M21;;SAJ 23 170784

LEARN TRACTOR AND MOWER SAFETY

Carefully read this manual and manuals furnished with attachments. Learn how to operate the tractor and mower correctly.

Unauthorized modifications to the machine may impair the function and/or safety and affect machine life. Use only approved attachments on the tractor and mower.

Do not let anyone operate the tractor and mower without proper instruction.



A98;M35176 M21;;SAJ 24 170784

PROTECT CHILDREN

Keep children and pets out of the area where you are using the tractor and mower.

Do not let children operate or ride on the tractor or mower.



A98;M35112 M21;;SAJ 25 170784

HANDLE FUEL SAFELY—AVOID FIRES

Handle gasoline with care: it is highly flammable. Use an approved gasoline container.

Fill the fuel tank outdoors.

Do not fill fuel tank above the "FULL LEVEL" mark.

Do not smoke while you fill fuel tank or service fuel system.



A98;M35113 M21;;SAJ 26 170784

Do not remove gas cap or add gasoline to tank if engine is running.

Clean up spilled gasoline.

Keep engine compartment clean: remove grass, leaves, oil, or dirt.

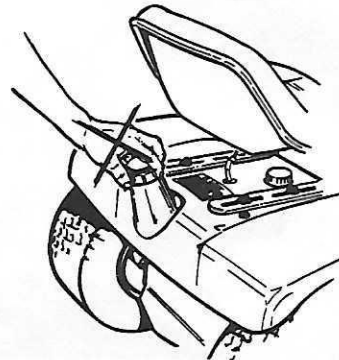

A98;M35124 M21;;SAJ 27 170784

CHECK GROUND CONDITIONS

Clear the mowing area of objects that might be picked up and thrown.

Consider the type of area you plan to mow. Set up a safe mowing pattern. Do not mow under conditions in which traction or stability is doubtful: first test drive the area with PTO switch in "OFF" position and mower in the down position.

Travel slowly over rough ground.



A98;M33725 M21;;SAJ 28 170784

AVOID INJURY FROM MOVING PARTS

Put PTO switch in "OFF" position:

- when you are not using the mower.
- when you are driving between mowing jobs.
- before you cross a gravel road or path, a sidewalk, or a road.

Keep hands, feet, and clothing away from mower deck and discharge chute when blades are turning.

DO NOT adjust mower wheels or level mower while the engine is running. If these adjustments are to be made, STOP the engine and remove the key.

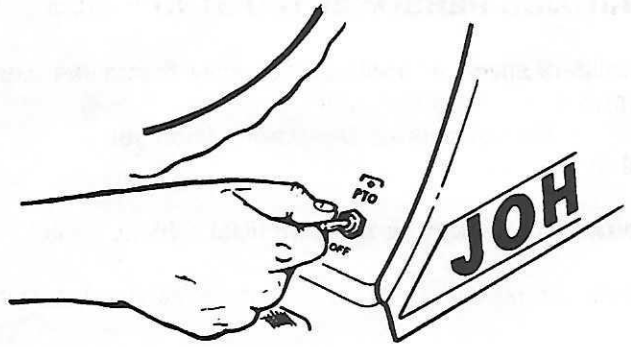

A98;M35130 M21;;SAJ 29 170784

AVOID TIPPING

Before you make a sharp turn, slow down.

Do not operate near edge of a ditch or bank.

Keep away from drop-offs. Avoid holes, rocks, and roots.

Watch for hidden hazards.

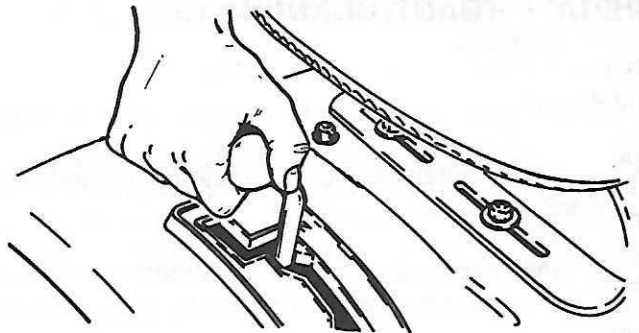

A98;M35131 M21;;SAJ 30 170784

OPERATE SAFELY ON SLOPES

Operate up and down—not across—slopes. Back up steep slopes with PTO off. Mow only on the way down.

Avoid sudden starts and stops on slopes.

Be especially careful when you change directions on a slope: slow down.

Avoid parking tractor and mower on a slope. Park on a level surface, if possible.



A98;M35132 M21;;SAJ 31 170784

PRACTICE PERSONAL SAFETY

Wear hard shoes or boots and clothing that is not loose.

Be alert. Do not operate equipment when you are tired or ill.

Mow only in daylight or good artificial light.

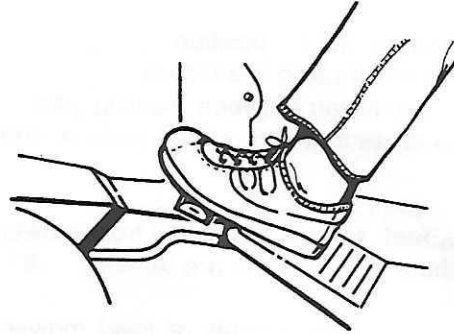

A98;M35133 M21;;SAJ 32 170784

BACK UP SAFELY

Do not mow in reverse unless it is very necessary—and then only after you look carefully behind the tractor.

Be very careful when you back the tractor, especially if the PTO is engaged.



A98;M35143 M21;;SAJ 33 170784

OPERATE TRACTOR AND MOWER ONLY IN OPEN AREAS

Do not run engine indoors unless there is enough ventilation.

Let the engine cool before you store the tractor and mower in an enclosed place.

Do not drive tractor and mower on streets or highways. Watch for traffic when you cross roads or operate near roads.

Learn the correct way to stop in an emergency.



A98;M35415 M21;;SAJ 34 170784

AVOID CREEP IN NEUTRAL POSITION

The tractor may creep forward or back when:

- Engine is running.
- Speed control lever is in neutral position.
- Park brake is unlocked.

Move speed control lever forward or back in neutral position to stop creep.

Then lock the park brake.

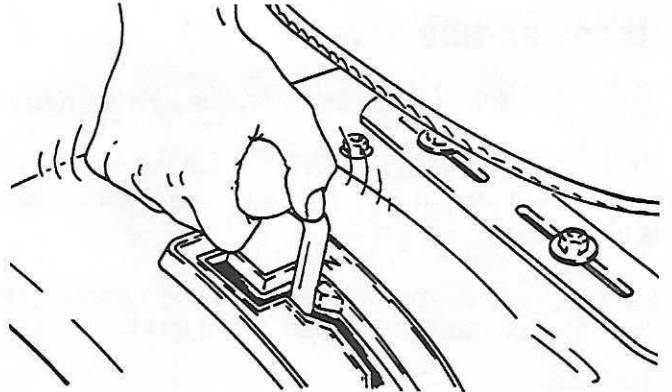

A98;M32801 M21;;SAJ 10 170784

PRACTICE SAFE MAINTENANCE

Keep all parts in good condition and fastened in place.

Fix damage immediately. Replace worn or broken parts.

If you hit an object, stop the tractor and mower. Fix the damage before you operate again.

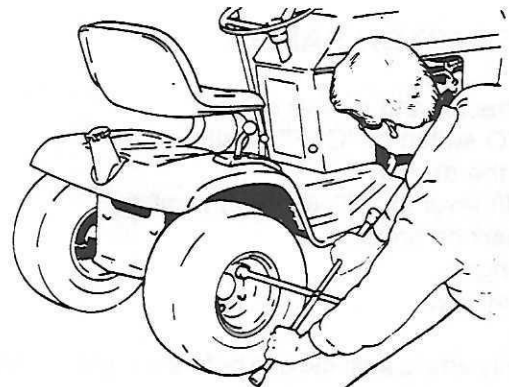

A98;M32807 M21;;SAJ 16 170784

SERVICE TRACTOR AND MOWER SAFELY

Disconnect battery ground cable (—) before a service, if starting engine could possibly injure operator.

Do not change engine governor setting or overspeed engine.

Keep tractor and mower clean.

Before you service or remove parts, let the engine and hydraulic system cool.

Do not work on your machine while it is being operated.

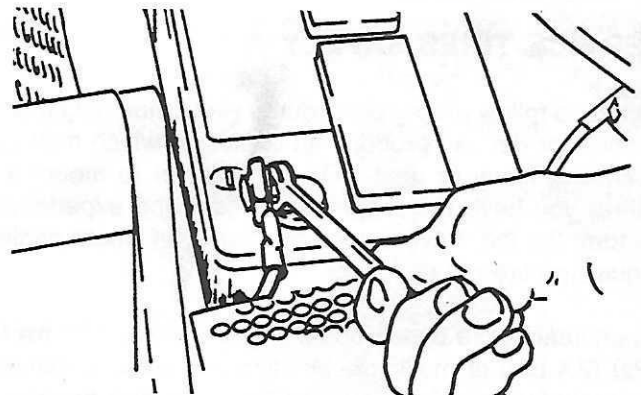

A98;M32808 M21;;SAJ 17 170784

INSPECT TRACTOR AND MOWER CAREFULLY

Inspect the tractor carefully before you operate it. Follow the checks in the Prestarting Checks section.

Guards and shields must be in place.

Keep nuts, bolts, and screws tight.

Use correct weights if necessary.



A98;M35416 M21;;SAJ 35 170784

START ENGINE SAFELY

AVOID possible injury or death from machinery runaway.

DO NOT start engine by shorting across starter terminals. Machine will start in gear and will move if normal circuitry is by-passed.

Start engine only from operator's seat with transmission in "N" (neutral) position and park brake locked.

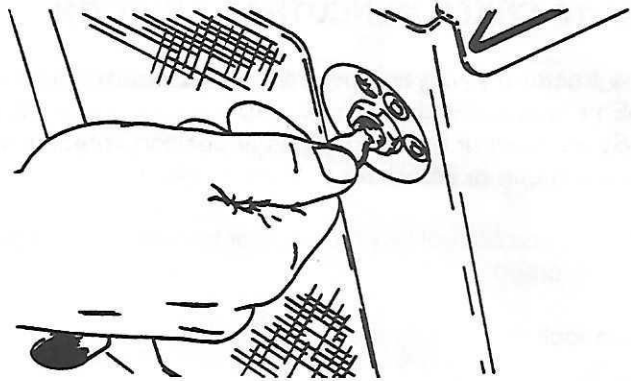

A98;M32800 M21;;SAJ 09 170784

PARK TRACTOR SAFELY

To park tractor and mower safely:

- Put PTO switch in "OFF" position.
- Lower the mower.
- Put shift lever in "N" (neutral) position.
- Lock parking brake.
- Stop engine.
- Remove key.

Wait for all parts to stop moving before you get off the tractor.

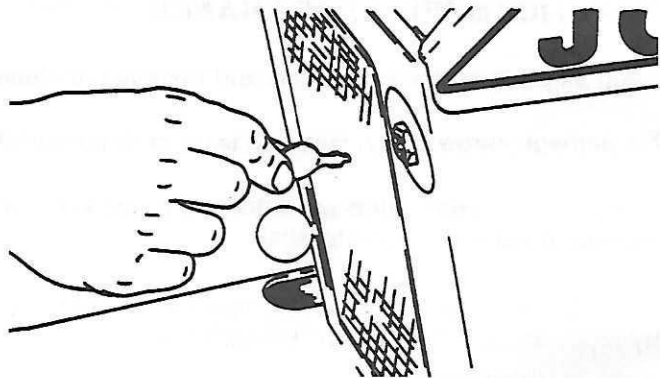

A98;M32805 M21;;SAJ 14 170784

SERVICE TIRES SAFELY

Failure to follow proper procedures when mounting a tire on a wheel or rim can produce an explosion which may result in serious injury or death. Do not attempt to mount a tire unless you have the proper equipment and experience to perform the job. Have it done by your John Deere dealer or a qualified tire repair service.

When sealing tire beads on rims, never exceed 35 psi (240 kPa) (2.4 bar) or maximum inflation pressures specified by tire manufactures for mounting tires. Inflation beyond this maximum pressure may break the bead, or even the rim, with dangerous explosive force. If both beads are not seated when the maximum recommended pressure is reached, deflate, reposition tire, relubricate bead, and reinflate.

Detailed tire mounting instructions, including necessary safety precautions, are contained in John Deere Fundamentals of Service (FOS) Manual 55, Tires and Tracks, available through your John Deere dealer. Such information is also available from the Rubber Manufacturers Association and from tire manufacturers.

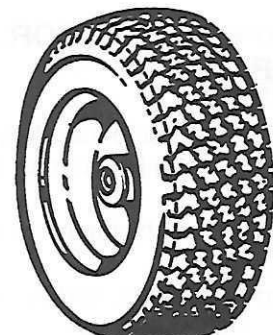
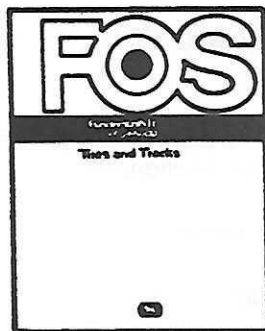

A98;M34163, M34164 M21;;SAJ 18 170784

PROTECT AGAINST NOISE

Prolonged exposure to loud noise can cause impairment or loss of hearing. Wear a suitable hearing protective device, such as earmuffs (A) or earplugs (B) to protect against objectionable or uncomfortable loud noises.

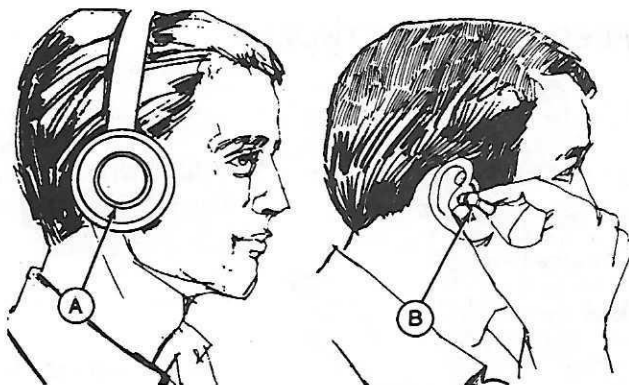

A98;M28247 M21;;SAJ 06 200483

TRANSPORT TRACTOR AND MOWER SAFELY

Transport the tractor and mower on a heavy-duty trailer.

Do not pull tractor and mower behind any other vehicle.

Fasten the tractor and mower to the trailer with straps, chains, or cables.

Be sure trailer has all necessary lights and signs required by local, state, provincial, or federal laws.

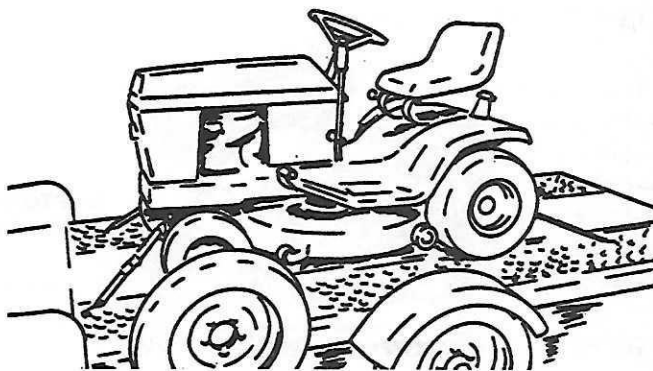

A98;M32806 M21;;SAJ 15 170784

Controls

UPPER DASH CONTROLS

- A—Throttle Lever
- B—PTO Switch
- C—Key Switch

108, 111, and 112L Tractors

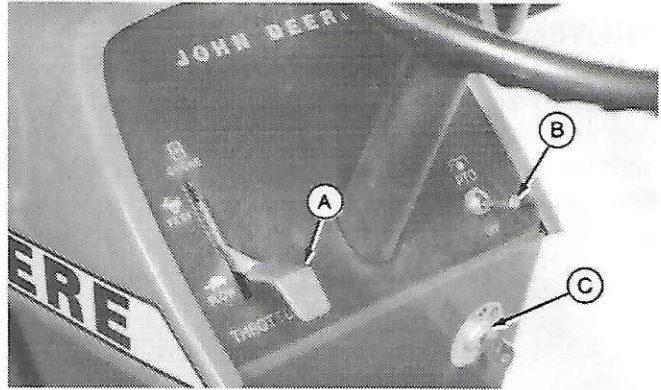

- A—Throttle Lever
- B—Choke

- C—PTO Switch
- D—Key Switch

116 Tractor

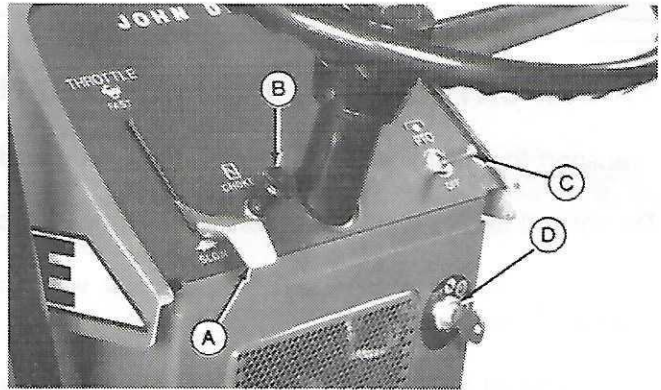

A98;M32809, M32810 M21;;CTJ 01 210483

LOWER DASH CONTROLS

- A—Lift Stop Lever
- B—Park Lock Lever

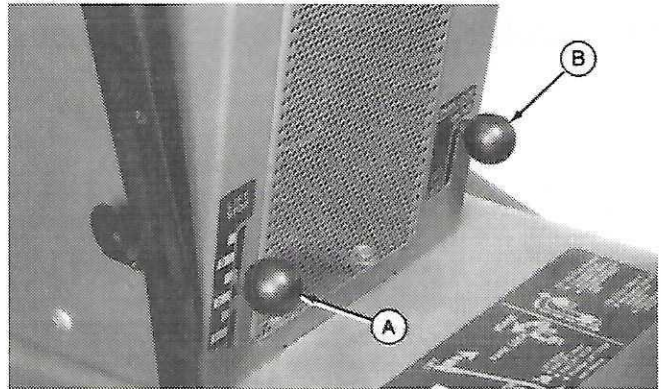

A98;M32811 M21;;CTJ 02 210483

TRANSMISSION SHIFT LEVER

108, 111, and 116 Gear Selector Tractors

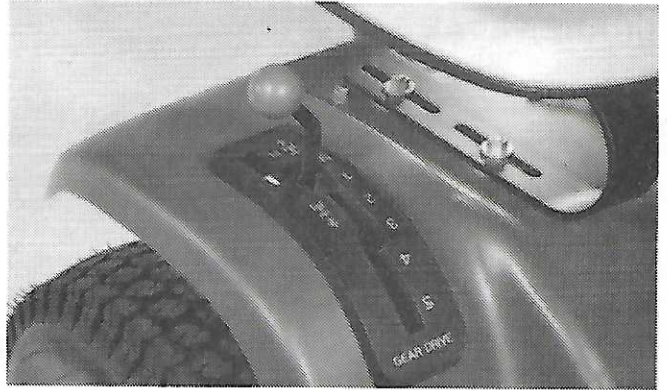

112L and 116 Hydrostatic Tractors

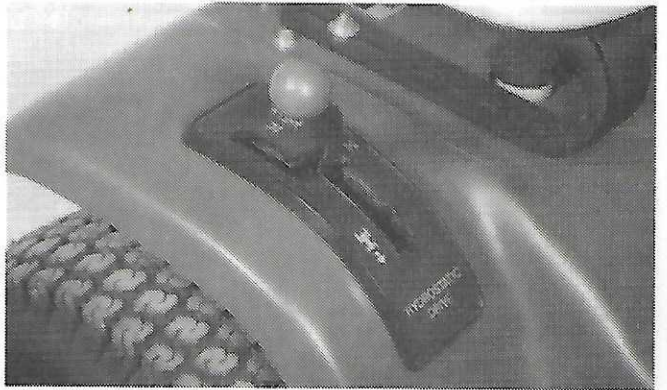

A98;M32814, M32815 M21;;CTJ 05 210483

LEFT-SIDE CONTROLS

A—Clutch Pedal (Gear Selector Tractors Only)
B—Lift Lever

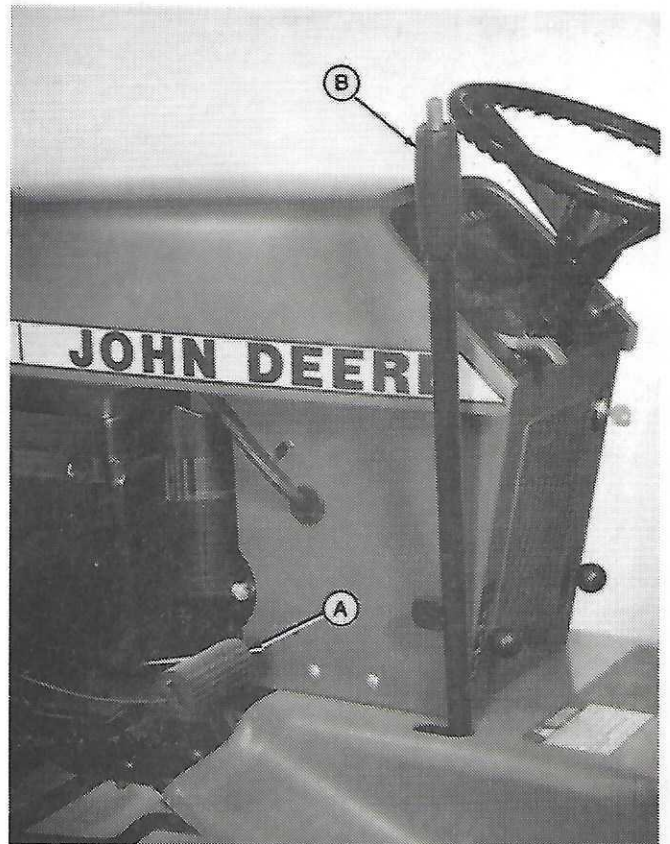

A98;M32812 M21;;CTJ 03 210483

BRAKE PEDAL

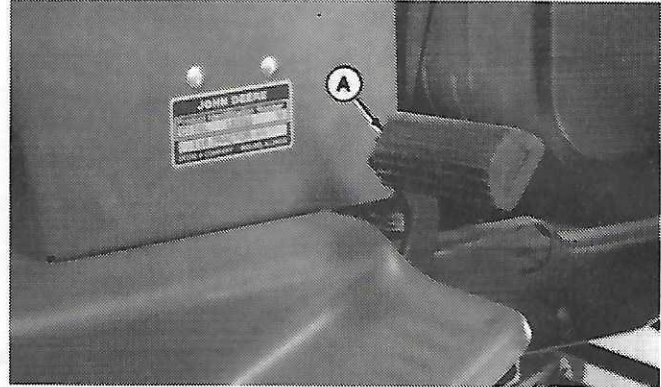

A—Brake Pedal

A98;M32813 M21;CTJ 04 210483

TOW DISCONNECT LEVER



112L and 116 Hydrostatic Tractors

A98;M32816 M21;CTJ 06 170784

Prestarting Checks

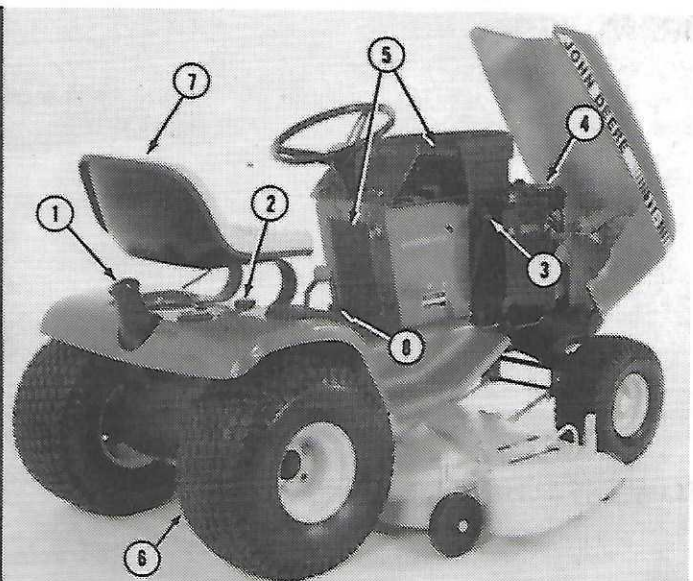
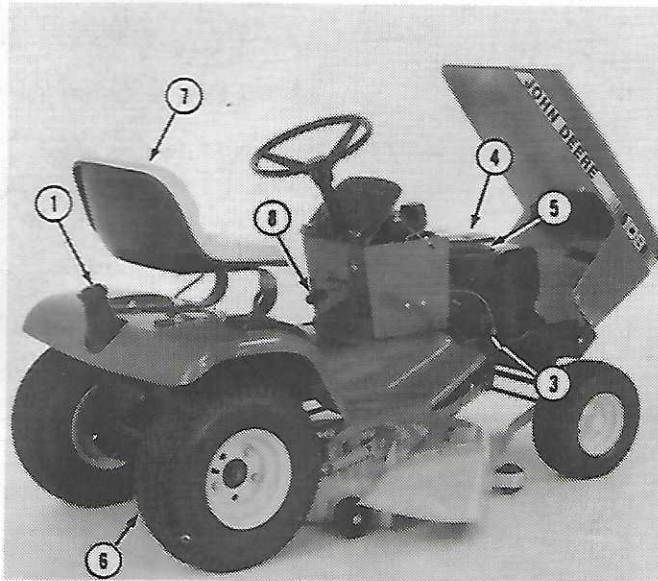

Gear Selector Tractor

Hydrostatic Tractor

Check	When	Reference	Section
1. Fuel level	Daily or when necessary	Fuel	Fuels and Lubricants
2. Engine oil level	Daily	Checking Engine Oil Level	Service Before Each Use
3. Air cleaner	Daily	Cleaning Air Cleaner Element	Service/25-Hours
4. Air intake screens	Daily	Cleaning Air Intake Screens	Service/Before Each Use
5. Tire pressure	Daily	Checking Tire Pressure	Service/25-Hours
6. Seat adjustment	As necessary	Adjusting Seat	Service/As Necessary
7. Cutting height	As necessary	Adjusting Cutting Height	Operating the Mower
Leaking oil or fuel	Daily		
Loose or damaged parts	Daily		

Operating the Engine

BREAKING IN ENGINE

After the first 5 hours of operation, change the engine oil.
(See Changing Engine Oil in Service/25-Hours.)

A98; M21;;OEJ 15 180784

STARTING THE ENGINE

CAUTION: Never start engine or operate tractor in an unventilated building. Carbon monoxide can cause asphyxiation.

1. Move gear selector lever in the "N" (neutral) position.

Gear Selector Tractor

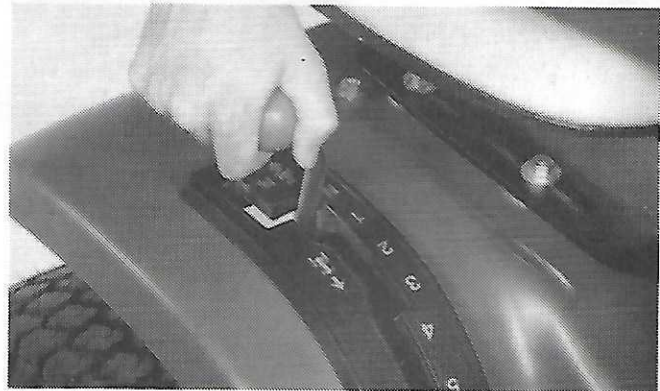

Hydrostatic Tractor



A98;M32820, M32821 M21;;OEJ 02 210483

NOTE: A built-in interlock prevents hydrostatic control lever from being moved out of "N" position when park brake is locked.

2. Move the park lock lever (A) in the "P" position.
3. For hydrostatic tractors, completely push down on the brake pedal (B). For gear selector tractors, completely push down on both the brake and clutch pedal (C). The brake and/or clutch pedal will remain depressed when park lock is properly engaged.

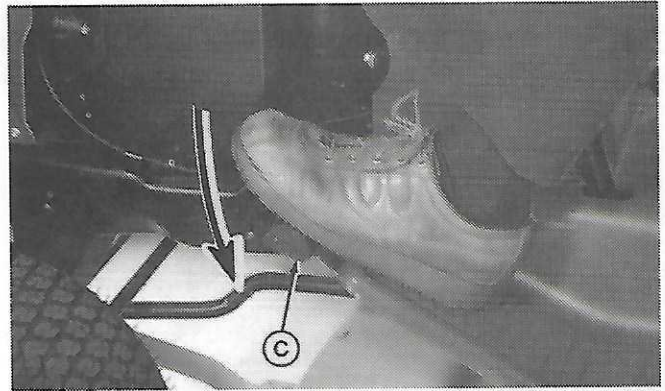

A98;M32822, M32823 M21;;OEJ 03 210483

NOTE: The tractor is equipped with a neutral start safety switch. The engine will not start unless the PTO switch is off and the control lever is in the "N" position.

4. Move PTO switch to the "OFF" position.

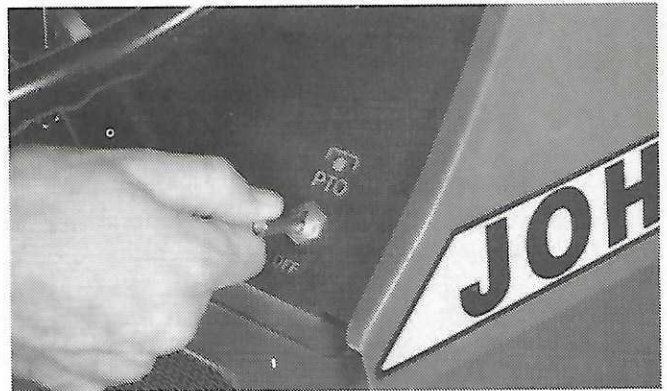

A98;M32824 M21;;OEJ 04 120583

5. For 108, 111, and 112L Tractors, move throttle lever to "CHOKE" position to start a cold engine.

108, 111, and 112L Tractors



For the 116 Tractor, move throttle lever to "FAST" position. Pull choke knob all the way out to start a cold engine.

116 Tractor



A98;M32825, M32826 M21;;OEJ 05 210483

IMPORTANT: DO NOT operate starter more than 10 seconds at a time. If engine does not start, wait 2 minutes before trying again. Not doing so can damage the starter.

6. Install ignition key in key switch. Turn key to "START" position to start the engine. When engine starts, release the key. The key will return to the "RUN" position.

If engine does not start, see the Trouble Shooting section to find the possible cause.



A98;M32827 M21;;OEJ 06 130583

7. After the engine starts:

108, 111, and 112L Tractors: Move throttle lever to half-throttle position.

108, 111, and 112L Tractors



116 Tractor:

- a. Gradually push choke knob in.
- b. Move throttle lever to half-throttle position. You may have to leave choke knob halfway out until engine warms.

116 Tractor



A98;M32828, M32829 M21;;0EJ 07 180784

ENGINE WARM-UP PERIOD

IMPORTANT: In cold weather, run engine a few minutes to permit engine crankcase oil and/or transmission hydraulic fluid to warm up.

Run engine a few minutes with throttle half-way open before putting tractor under full load.

116 Tractor Shown



A98;M32830 M21;;0EJ 08 210483

ENGINE IDLING

1. Keep the air intake screens clean. Your tractor engine is air cooled and requires an unrestricted air flow to keep the engine cool.
2. Prevent unnecessary engine idling. Prolonged engine idling wastes fuel and will cause the engine to over heat.
3. STOP the engine, rather than letting it idle for prolonged periods of time.



A98;M32831 M21;;0EJ 09 210483

STOPPING THE ENGINE

1. Move PTO switch to the "OFF" position.



A98;M32824 M21;OEJ 10 210483

2. Move gear selector in the "N" position.

Gear Selector Tractor

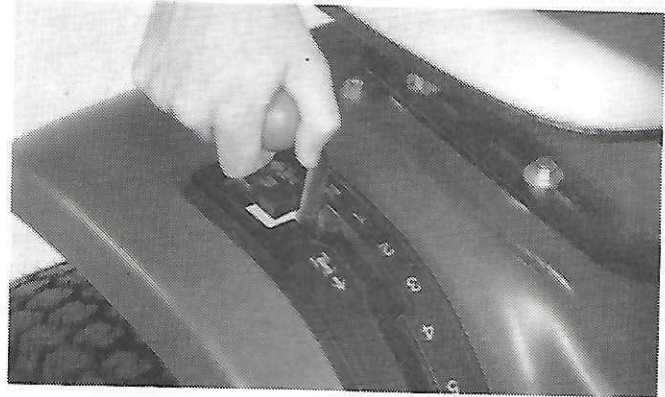

Hydrostatic Tractor



A98;M32820, M32821 M21;OEJ 11 210483

3. Move the throttle lever in the "SLOW" position.

116 Tractor Shown



A98;M32832 M21;OEJ 12 210483

4. Move the park lock lever (A) in the "P" position.

5. For hydrostatic tractors, completely push down on the brake pedal (B). For gear selector tractors, completely push down on both the brake and clutch pedal (C). The brake and/or clutch pedal will remain depressed when park lock is properly engaged.

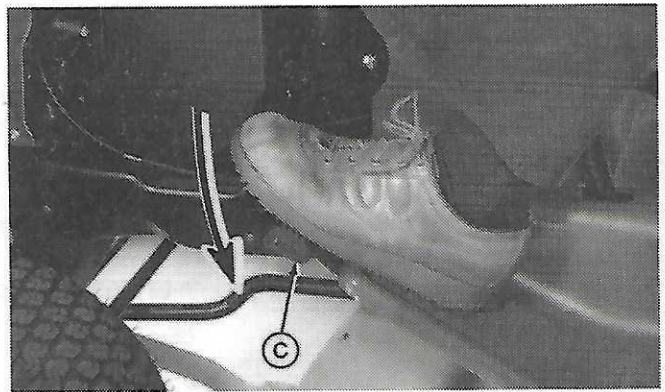

A98;M32822, M32823 M21;;OEJ 13 210483



CAUTION: Wait for engine and all moving parts to stop before leaving tractor seat. NEVER leave tractor unattended with key in switch.

6. Turn ignition key to the "OFF" position.

7. Remove key from switch.

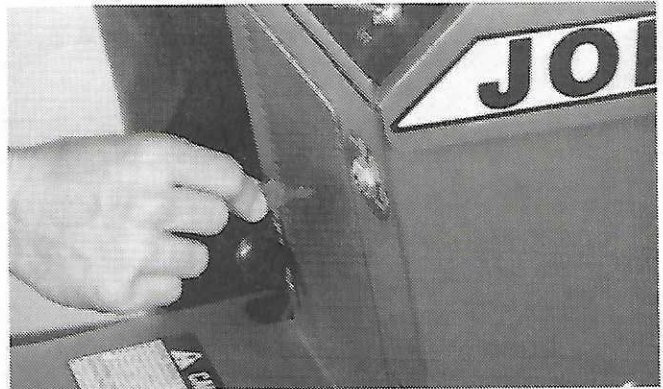

A98;M32833 M21;;OEJ 14 210483

Operating the Tractor

DRIVING THE TRACTOR

1. Start the engine. (See Starting the Engine in Operating Engine section.)
2. Pull back on lift lever until mower deck is locked in the up position.



A98;M32834 M21;;OTJ 01 210483

3. For hydrostatic tractors, completely engage the brake pedal (B), move the park lever (A) in the "UNLOCK" position, and release pedal to disengage park brake.

For gear selector tractors, completely engage both the brake and clutch pedal (C), move the park lever (A) in the "UNLOCK" position, and release pedals to disengage park brake.

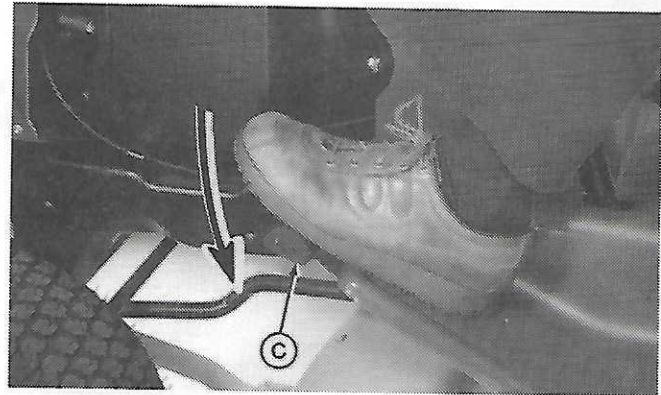
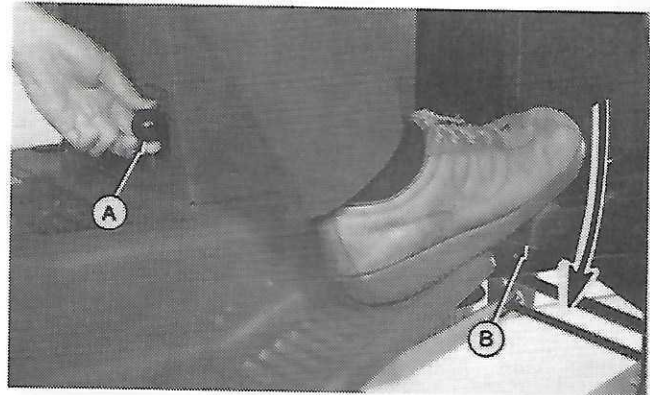

A98;M32835, M32823 M21;;OTJ 03 210483

IMPORTANT: For best engine performance, operate engine at full throttle to avoid prolonged lugging of the engine.

4. Move throttle lever to the "FAST" position.



A98;M32830 M21;;OTJ 04 210483

116 Tractor Shown

5a. For gear selector tractors, go forward by pushing down on the clutch pedal, moving the shift lever to "1" (first gear) position, then slowly releasing the clutch pedal.

NOTE: The farther the lever is moved to the higher gears, the faster the ground travel speed will be.

The transmission can be shifted to any gear, 1st through 5th, by pushing down the clutch pedal, shifting into desired gear, then releasing clutch pedal. Tractor does not have to be stopped to change gears.



A98;M32836, M32837 M21;;OTJ 05 210483

NOTE: The farther the lever is moved in the forward direction, the faster the ground travel speed will be.

5b. For hydrostatic tractors, go forward by slowly moving the shift lever forward.



A98;M32977 M21;;OTJ 06 210483

CAUTION: Carefully look behind you to make sure area is clear before operating tractor in reverse.

6. If moving in a forward direction, and you decide to go in reverse, make sure the tractor comes to a complete stop. (See stopping the Tractor in this section.)

7a. For gear selector tractors, go in reverse by pushing down on the clutch pedal, moving the shift lever to "R" (reverse) position, then slowly releasing the clutch pedal.

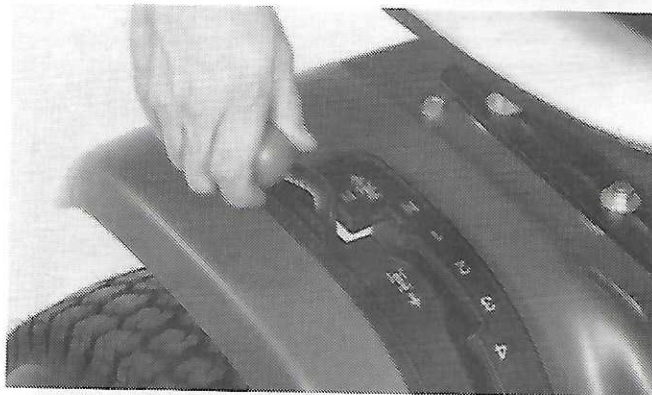
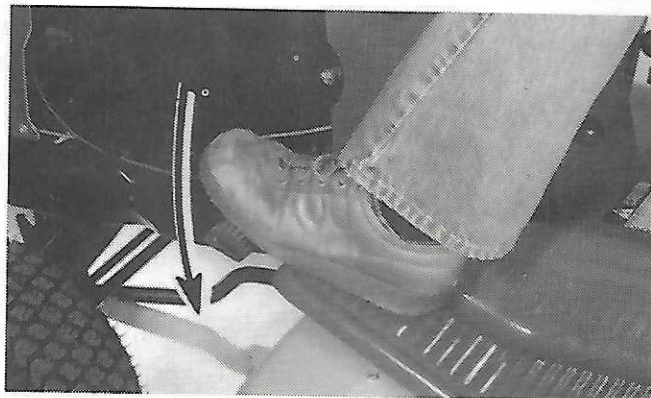

A98;M32836, M32838 M21;OTJ 07 210483

7b. For hydrostatic tractors, go in reverse by slowly moving the shift lever in the "R" (reverse) position.

8. Operate tractor in a large open area for a few minutes so you can get acquainted with the controls. Be prepared to stop the tractor if necessary. (See Stopping the Tractor in this section.)

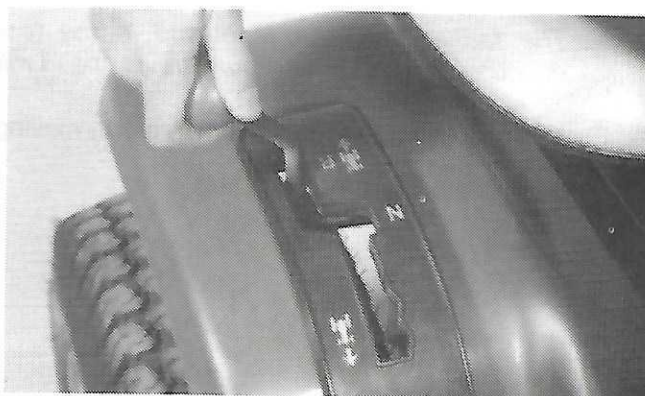

A98;M32839 M21;OTJ 08 210483

STOPPING THE TRACTOR

1. For gear selector tractors, stop the tractor by pushing down on both the clutch and brake pedals. Move the shift lever to the "N" position.

 **CAUTION:** The hydrostatic tractor may creep forward or back while in the neutral position when the parking brake is not set. Move transmission lever forward or back in the neutral slot area to stop the tractor from creeping.

For hydrostatic tractors, stop the tractor by pushing down on the brake pedal. The hydrostatic shift lever will return to the "N" position by its self.

2. Turn engine off (See Stopping the Engine in Operating the Engine section.)

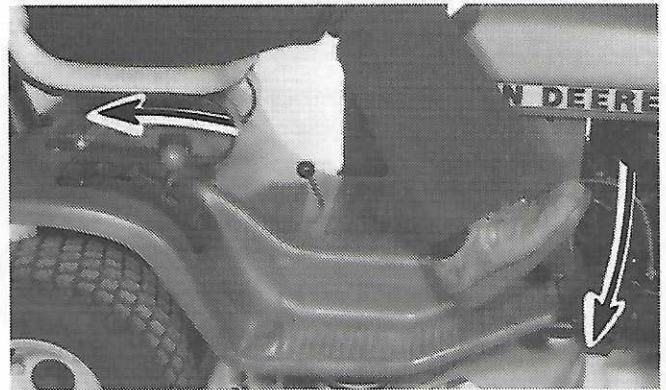
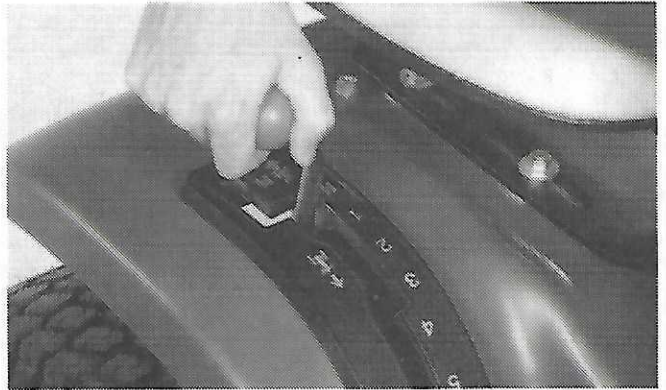

A98;M32820, M32840 M21;;OTJ 10 130583

3. Pull back on lift lever slightly and push down thumb release button (A). Move lever forward to lower mower deck.

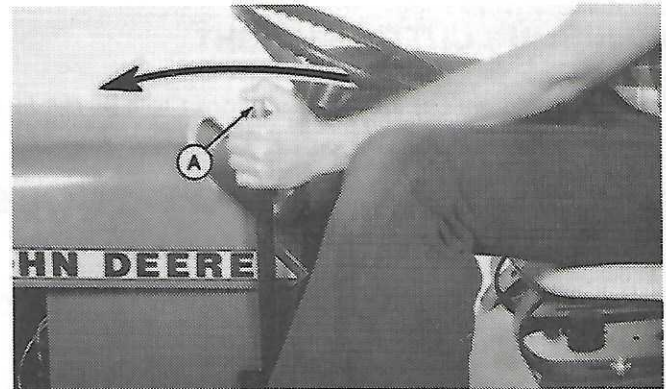

A98;M32841 M21;;OTJ 11 210483

Operating the Mower

BEFORE MOWING

Learn how to operate tractor and mower correctly.

Check: all parts should be in good condition and fastened in place.

Wear hard shoes or boots and clothing that is not loose.



A98;M35176 M21;;OMJ 25 180784

Clear the mowing area of objects that might be picked up and thrown.

Clear the mowing area of people and pets.

Test drive the area with PTO switch in "OFF" position and mower in down position.

Trim low-hanging branches to prevent eye injuries.



A98;M33725 M21;;OMJ 26 170784

ADJUSTING CUTTING HEIGHT

The cutting height can be adjusted from 1 to 4 in. (25 to 102 mm) as follows:

1. Pull lift lever (A) all the way back and hold lever in that position.
2. Pull out on lift stop lever (B). Move lever up or down to desired cutting height.
3. Move lift lever forward to lower mower. The selected cutting height will be obtained.
4. Adjust mower wheels.

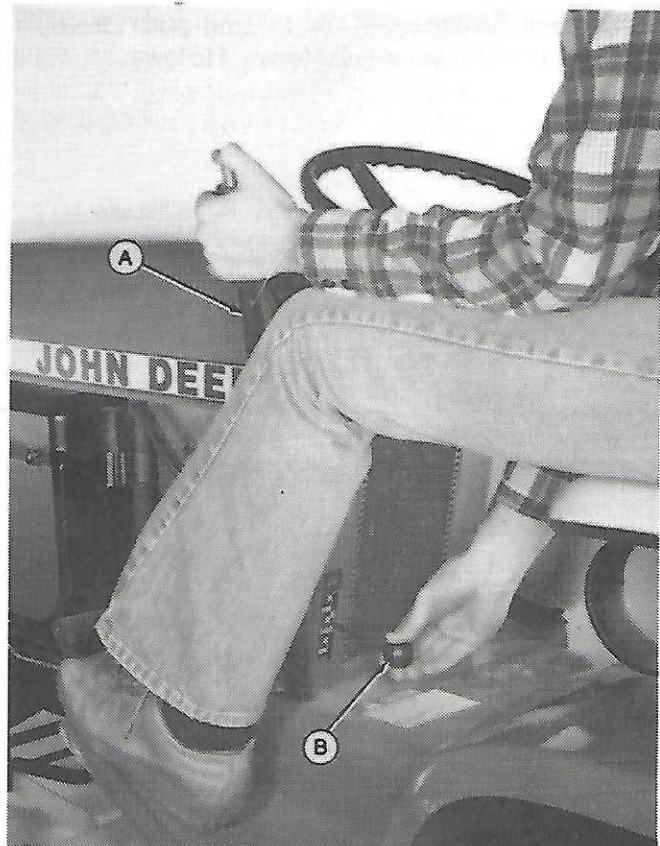

A98;M32843 M21;;OMJ 02 130583

ADJUSTING MOWER WHEELS

CAUTION: Make sure engine is shut off and blades have stopped before adjusting mower wheels.

IMPORTANT: The mower wheels must not ride on the ground to support the mower weight.

1. Remove spring locking pin (A) and headed pin (B) from all mower wheels.
2. Move lift lever forward to lower mower.
3. Move wheels up or down until the wheels are approximately 1/4 in. (6 mm) from the ground. A smoother cut will be obtained if wheels are adjusted properly.
4. Install headed pins (B) in nearest hole and fasten with spring locking pins (A).
5. When changing cutting height, adjust mower wheels accordingly.

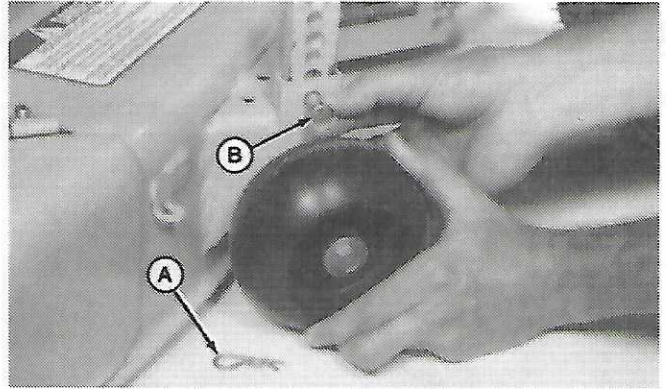

A98;M32844 M21;OMJ 03 130583

ADJUSTING MOWER FROM SIDE-TO-SIDE

CAUTION: Remove ignition key and disconnect spark plug wires so engine does not accidentally start.

1. Put tractor on a level surface. Make sure tire pressures are correct. (See Checking Tire Pressure in Service/25-Hour section.)
2. Put mower in the 2 in. (51 mm) cutting height position. (See Adjusting Cutting Height in this section.)



A98;M32845 M21;OMJ 04 200983

NOTE: The 30-in. mower has only one blade.

3. Turn left blade by hand parallel to tractor axle.
4. Hold drive belt and turn right blade parallel with axle.

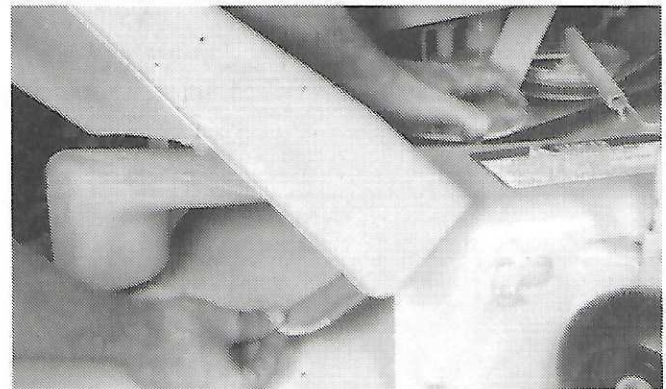

A98;M32846 M21;OMJ 05 210483

5. Measure from each outside blade tip to the level surface. The difference between the right and left blade tips must not be more than 1/8 in. (3 mm).

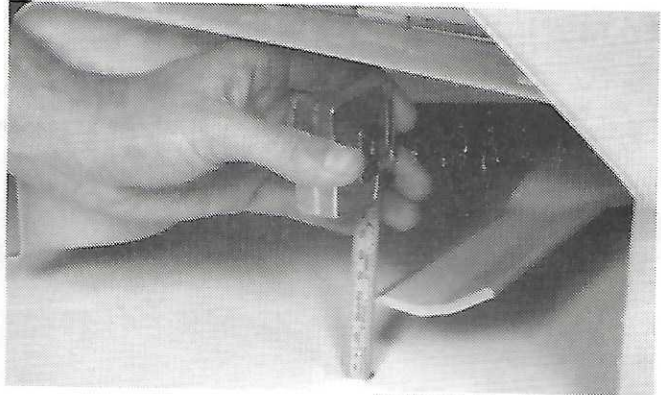

A98;M32847 M21;;OMJ 06 210483

6. To level the 30-in. or 38-in. mower, do the following:

- a. Remove spring locking pin (A) and pull adjustable lift strap (B) from bracket.
- b. Turning threaded pin to the left will lift left-side of mower. Turning threaded pin to the right will lower left-side of mower.

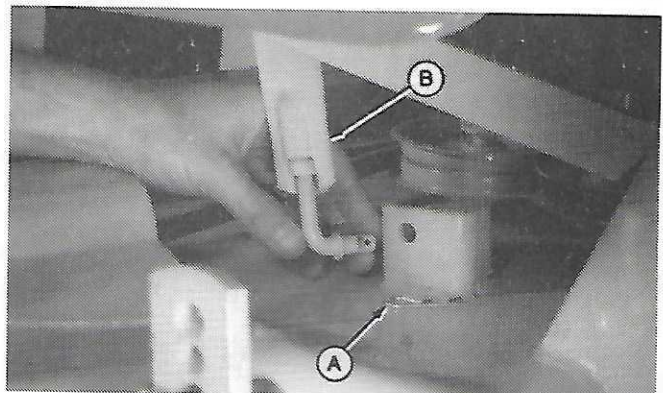

A98;M32848 M21;;OMJ 07 210483

CAUTION: The lift lever is spring loaded and will automatically retract when adjustable lift strap is removed.

- To level the 46-in. mower, do the following:

- a. Hold lift lever in the down position. Remove spring locking pin and pull adjustable lift strap from bracket. While holding lift lever, slowly let lever retract.
 - b. Turning threaded pin to the left will lift left-side of mower. Turning threaded pin to the right will lower left-side of mower.
7. Connect adjustable lift strap in bracket and fasten with spring locking pin.
8. Check for proper level and adjust again if necessary.

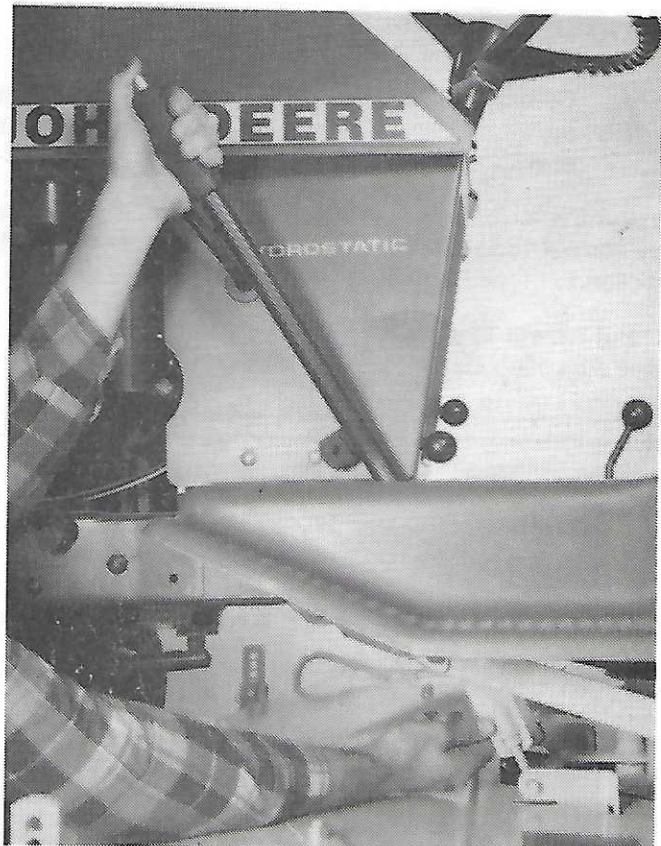

A98;M32849 M21;;OMJ 15 130583

ADJUSTING MOWER FROM FRONT-TO-REAR

CAUTION: Remove ignition key and disconnect spark plug wires so engine does not start.

1. Put tractor on a level surface. Make sure tire pressures are correct. (See Checking Tire Pressures in Service/25-Hour section.)
2. Put mower in the 2-in. (51 mm) cutting height position. (See Adjusting Cutting Height in this section.)



A98;M32845 M21;OMJ 08 120583

NOTE: The 30-in. mower has only one blade.

3. Turn left blade by hand so a blade tip is positioned toward front of tractor.
4. Hold drive belt and turn right blade in the same direction.
5. Measure from each outside blade tip to the level surface. The front blade tips must be $1/8$ to $1/4$ in. (3 to 6 mm) lower than rear blade tips.

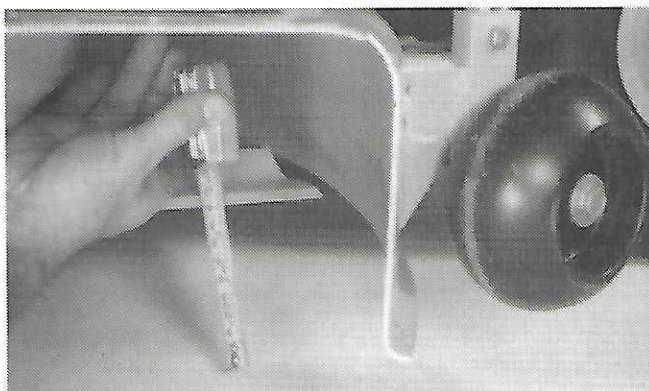

A98;M32850 M21;OMJ 09 220483

6. To level the 30-in. or 38-in. mower, do the following:
 - a. Loosen cap screws from both draft arms.

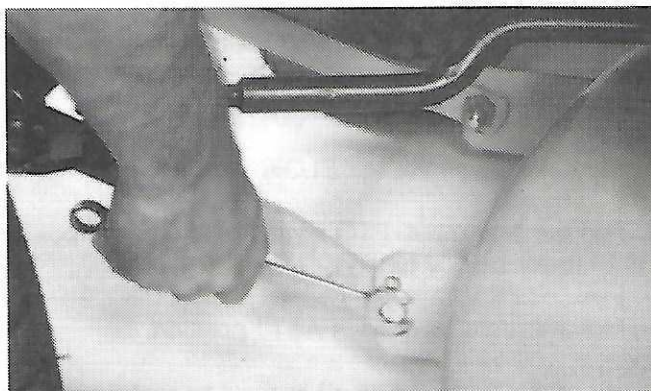

A98;M32851 M21;OMJ 10 220483

- b. Turn both draft arm adjusters equally until the proper measurement is obtained. (See Step 5.)
- c. If adjustment can not be made, move draft arms to a different hole in mower deck and follow steps 5 and 6.
- d. Tighten cap screws after adjustment is made.

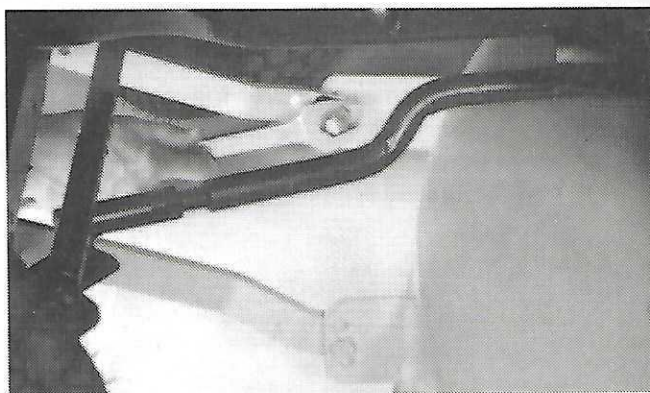

A98;M32852 M21;OMJ 11 220483

To level the 46-in. mower, do the following:

- a. Pull mower draft pins to disconnect front draft arm assemblies.
- b. Loosen nuts (A). Turn yokes (B) equally to either lift or lower front of mower deck.
- c. Connect draft arm assemblies and check for proper level. After adjustment is made, tighten nuts against the yokes.

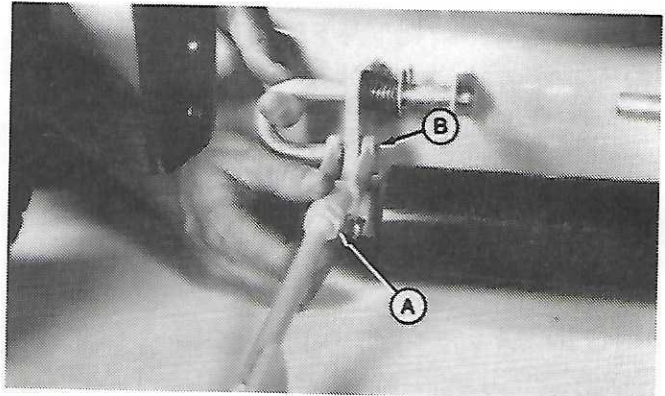

A98;M32853 M21;;OMJ 16 220483

ENGAGING THE MOWER

1. Move tractor in the area for mowing. Move shift lever in the "N" position.
2. Pull back on lift lever slightly and push down thumb release button (A). Move lever forward to lower mower deck.

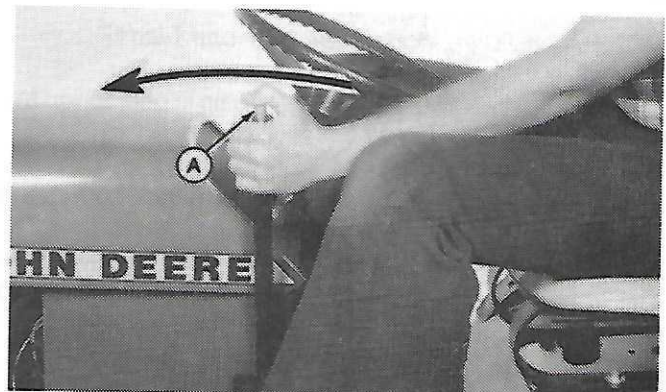

A98;M32841 M21;;OMJ 12 220483

IMPORTANT: Damage to the tractor can occur if PTO is engaged with throttle lever in the "FAST" position.

3. Move throttle lever to "SLOW" position.
4. Pull out and move PTO switch to the "ON" position to start mower blades turning.
5. Move throttle lever to "FAST" position.

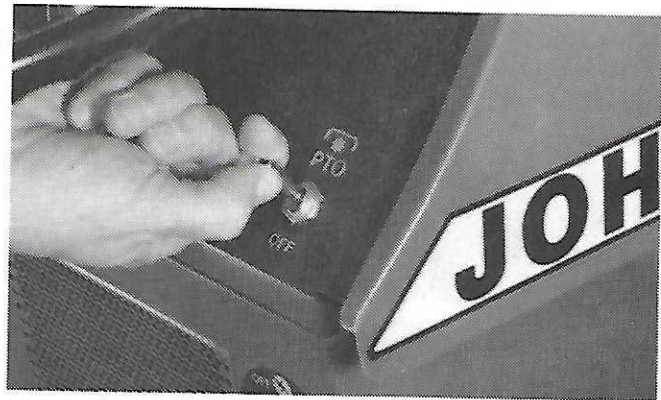

CAUTION: Look all around to make sure area is clear before operating tractor.

Always select a safe ground travel speed.

6. Slowly move transmission lever forward to go forward.
7. Disengage power to mower before backing up. DO NOT mow in reverse unless absolutely necessary.

A98;M32854 M21;;OMJ 13 271083

MOWING TRAVEL SPEEDS

Use slow travel speed for:

1. Trimming.
2. Working in close quarters.
3. Mowing tall grass.

Use faster travel speeds for:

1. Normal mowing on level ground.
2. Driving between mowing jobs.



A98;M32977 M21;OMJ 27 170784

DISMOUNTING TO INSPECT OR UNPLUG MOWER

Before you dismount:

1. Stop the tractor.
2. Put PTO switch in "OFF" position.
3. Put throttle lever in "SLOW" position.
4. Put transmission shift lever in "N" (neutral) position.
5. Lock park brake.
6. Stop engine. Remove key.
7. Wait for mower blade(s) to stop turning.

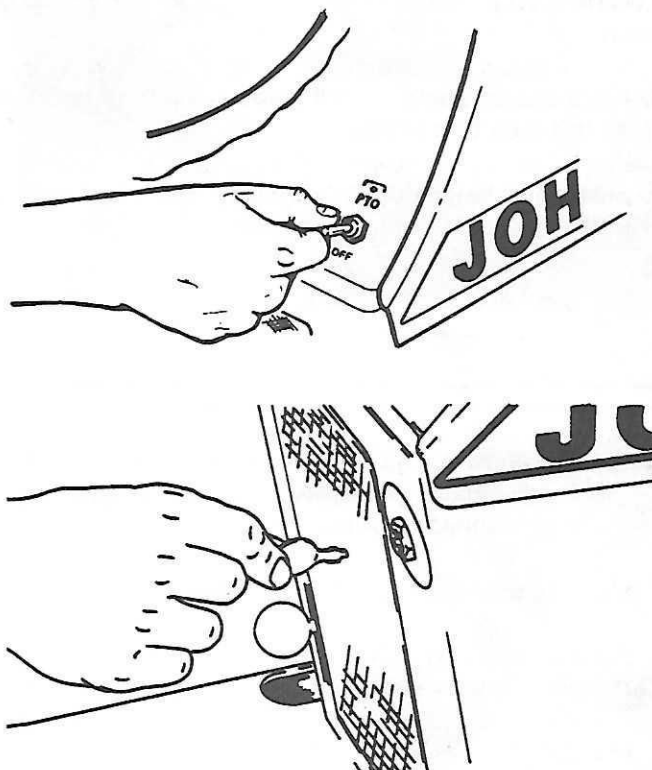

A98;M35130, M32805 M21;OMJ 28 170784

MOWING TIPS

1. Mow only at full throttle.
2. Mow at a safe travel speed.
3. Mow grass only when it is dry.
4. Slow down:
 - when you mow on slopes.
 - before you make a turn.
 - when you mow close to buildings or trees.



A98;M32828 M21;OMJ 29 179784

MOWING FOR A BETTER LAWN

1. Cut grass only when it is dry. Wet grass may plug mower and leave a trail of grass clumps.
2. Keep deck and chute clean. Use water pressure from a hose to clean top and bottom of deck after you mow.
3. Mow grass often. Short grass clippings will decay quickly.



6A9;M32856 M23;OPHA N 030784

4. Cutting grass too short may kill grass and let weeds grow easily.
5. Keep blades sharp. A dull blade will tear grass. Tips of grass will then turn brown.
6. Slow down before you make a turn. Short, fast turns may scuff the ground and pull grass out by the roots.



6A9;M32859 M23;OPHA O 150684

7. If cut is uneven:
 - Check adjustment of wheels.
 - Check side-to-side level.



A98;M32860 M21;OMJ 30 189784

MOWING TALL GRASS

1. Adjust cutting height of mower to mow tall grass (A) to half height (B).
2. Before second pass adjust cutting height so you can mow at desired height (C).

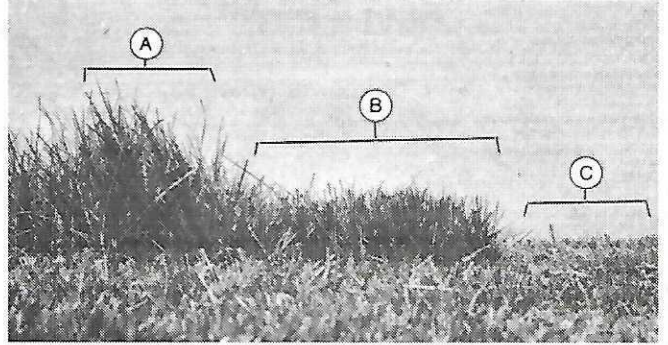

A98;M27196 M21;OMJ 20 180784

Second method:

1. Mow at desired height at slow travel speed, full width OR
2. Mow at desired height using only half of cutting width.

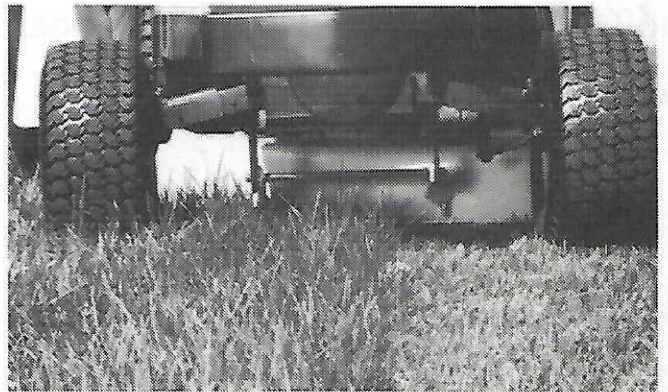

A98;M32858 M21;OMJ 31 180784

MOWING UNEVEN AREAS

1. Mow grass often.
2. Divide uneven areas into sections (Example: A, B, C).
3. Change your mowing pattern regularly.

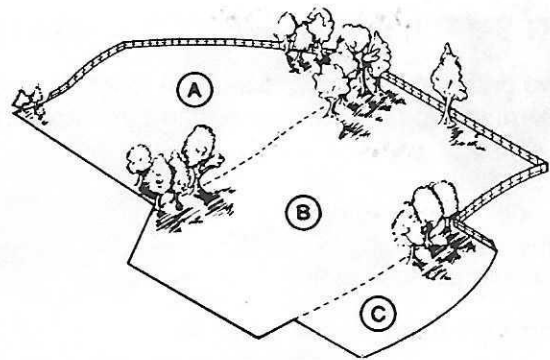

A98;M33868 M21;OMJ 32 180784

PREVENTING UNEVEN CUT

1. Check adjustment of mower wheels. (See Adjusting Mower Wheels in this section.)
2. Check mower level. (See Adjusting Mower in this section.)
3. Slow down before you make a turn.
4. Keep mower blades sharp.

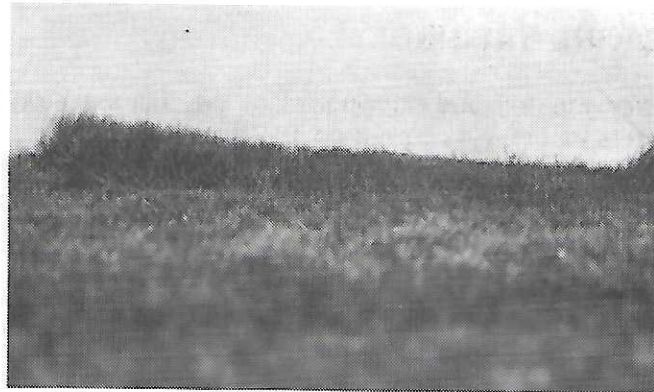

A98;M32860 M21;OMJ 33 180784

MOWING LARGE AREA WITHOUT BAGGER

Use this mowing pattern for a large, open area.

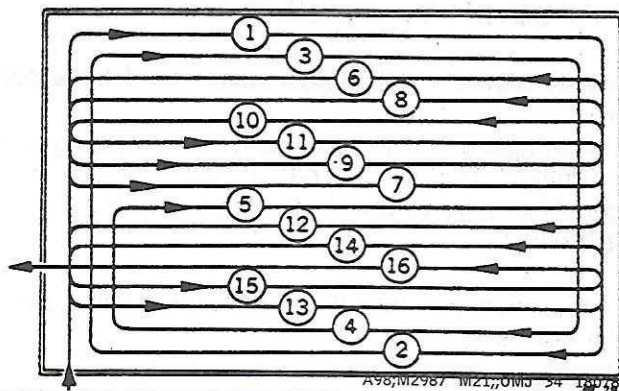

A98;M2987 M21;OMJ 34 180784

MOWING SMALL AREA WITHOUT BAGGER

1. Mow two or three right-hand rounds (A) along the edges of area. Normally do not mow more than three right-hand rounds because:
 - a. Clippings will build up.
 - b. Mower could tend to plug.
 - c. Cutting will be uneven.
 - d. Engine could be overloading.
2. Then mow left-hand rounds (B) to finish.
3. Turn to left when you trim around trees or bushes.

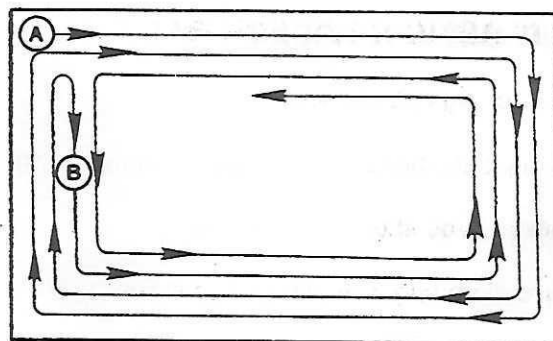

3A5;M33867 M21;OMP AE 010584

AFTER MOWING

1. Lock park brake. Stop engine. Remove key.
2. Clean under mower deck and drive belt area with water pressure from garden hose.
3. Lower mower to ground.

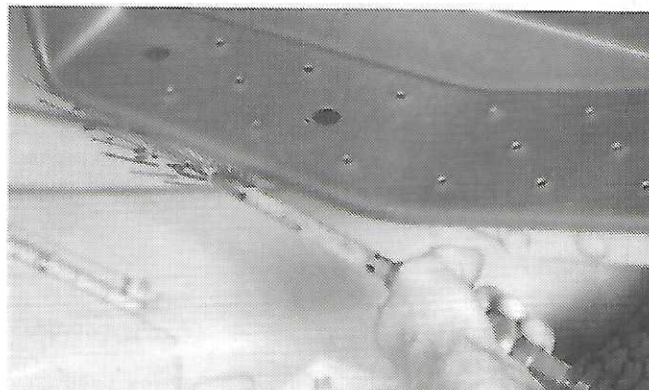

3A5;M35090 M21;OMP AF 010584

BEFORE BAGGING

Before mowing and bagging, clear the mowing area of objects that may be picked up and thrown.

Install front weight (optional equipment) before mowing and bagging on slopes.

Close the hopper top before you operate the riding mower.



3A5;M33725 M21;OMP AG 010584

USING CORRECT BLADE(S)

A. Low-lift blade(s)—for dusty or dirty conditions, not for bagging.

B. Medium-lift blade(s)—standard blade for use without bagger. Also good to use if you bag an average stand of grass regularly.

C. High-lift blade(s)—for cutting and bagging thick, tall grass and/or leaves.

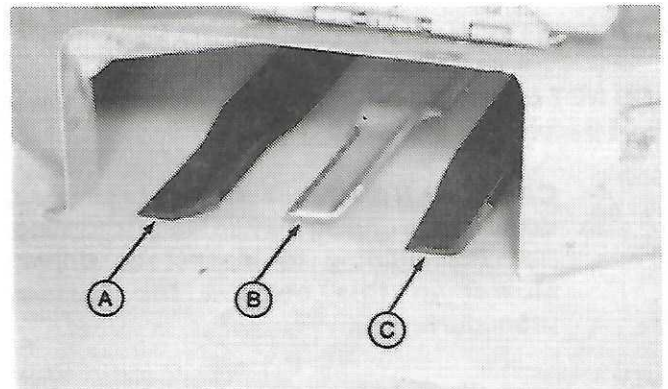

3A5;M35093 M21;OMP AH 010584

USING PLASTIC BAGS FOR BAGGING

Install plastic bags as shown.

To remove plastic bags.

1. Tie plastic bags shut.
2. Remove cloth bag with plastic bag inside.
3. Lay bag on its side on ground.
4. Grasp cord on bottom of cloth bag. Shake plastic bag out of cloth bag.

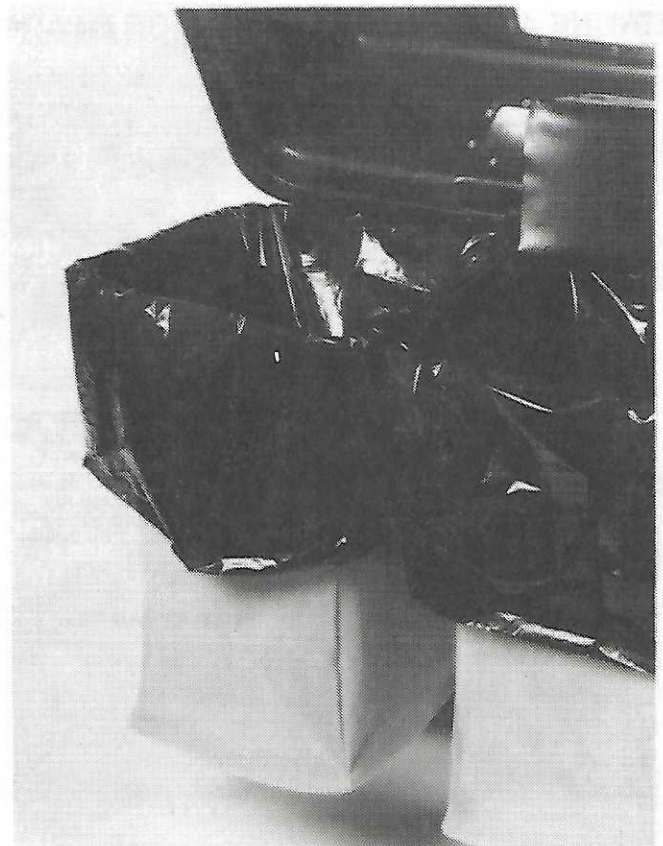

3A5;M35092 M21;OMP AI 010584

AIRFLOW FOR BAGGING

For best performance bagger needs a large amount of air moving from under mower deck, through bagging chute, and into bags.

To help increase airflow:

—Keep underside of mower, bagging chute, hopper top screen, and bags clean.

—Adjust front-to-rear mower level so rear of mower is no more than 1/2 in. (12 mm) higher than front of mower. (See Leveling Mower ... in this section.)

—Install high-lift blade(s). (See Using Correct Blade(s) in this section.)

—Operate with mower in higher cutting positions.

3A5; M21;;OMP AJ 010584

AVOID PLUGGING AND DAMAGE TO MOWER

DO NOT cut wet grass. Wet grass will plug the mower and bagger.

CAUTION: If discharge chute gets plugged, do not try to unplug it while blade is turning. See Dismounting to Inspect or Unplug Mower in this section for correct procedure.

Bag grass only when grass is dry and not very tall or dense.

Cut grass higher than normal the first time so mower blades will clear unseen objects that could damage mower or bagger.

A98; M21;;OMJ 35 180784

ENGINE AND TRAVEL SPEEDS FOR BAGGING

Run engine at maximum speed for bagging.

If engine slows down while you are bagging, operate at slower travel speed.

Travel slower when you are bagging to prevent mower and bagger from plugging.

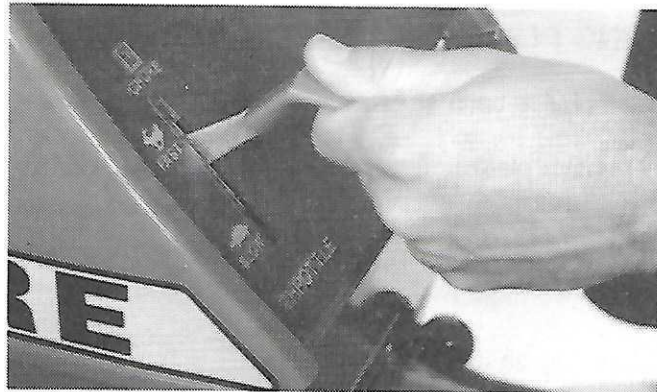

A98; M32828 M21;;OMJ 36 180784

MOWING PATTERN WITH BAGGER

Make only right-hand turns.

Turn to left when you trim around trees or bushes.

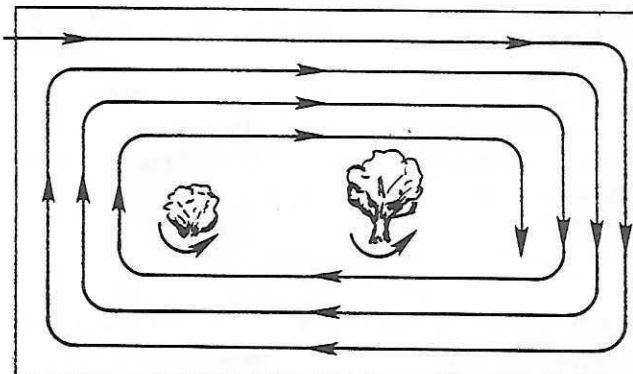

3A5;M35091 M21;;OMP AM 010584

BAGGING ON SLOPES

Do not fill bags full when you mow slopes. Empty bags when they are half full.

Do not operate your tractor and mower on steep slopes with bagger installed.



A98;M35419 M21;OMJ 37 180784

FILLING BAGS

Check level of clippings in bags often.

Empty bags when clippings are up to window of hopper top or you may plug the bagger chute.

The left bag normally fills first. The right bag may not fill completely when you are cutting a thin stand of grass. The bag will fill if you slow the engine to reduce airflow.

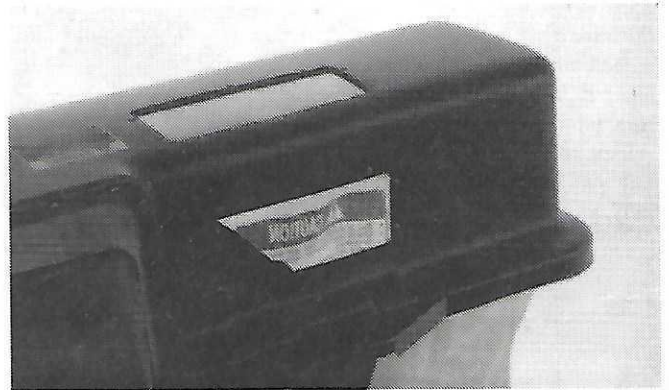

3A5;M32629 M21;OMP A0 010584

CHECKING FOR PLUGGING WHILE BAGGING



CAUTION: If discharge chute gets plugged, do not try to unplug it while blade is turning. See **Dismounting to Inspect or Unplug Mower** in this section for correct procedure.

If there is a trail of clippings behind the mower, check for a plugged chute or full bags.

If grass builds up in front of discharge chute outlet, check for plugged bagger chute.



3A5;M27195 M21;OMP AP 010584

DISMOUNTING TO EMPTY OR CHECK BAGS

Before you dismount to empty or check bags:

1. Move PTO switch to "OFF" position.
2. Put transmission shift lever in "N" (neutral) position.
3. Stop engine.
4. Lock park brake.
5. Remove key.

Do not remove or install any parts of bagger if engine is running: stop engine.

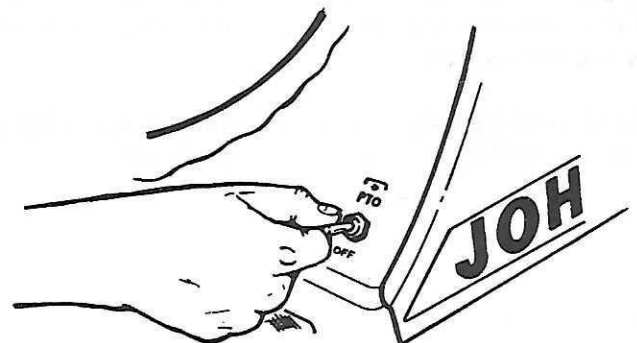

A98;M35130 M21;OMJ 38 180784

M65;P35 040884

AFTER BAGGING

Do not leave clippings in bags. Moisture from clippings will wear out bags. Damp clippings stored in a bag are a fire hazard.

Grasp cord. Shake bag to remove clippings.

For mowing without bagger, remove high-lift blade(s). Install medium-lift blade(s).

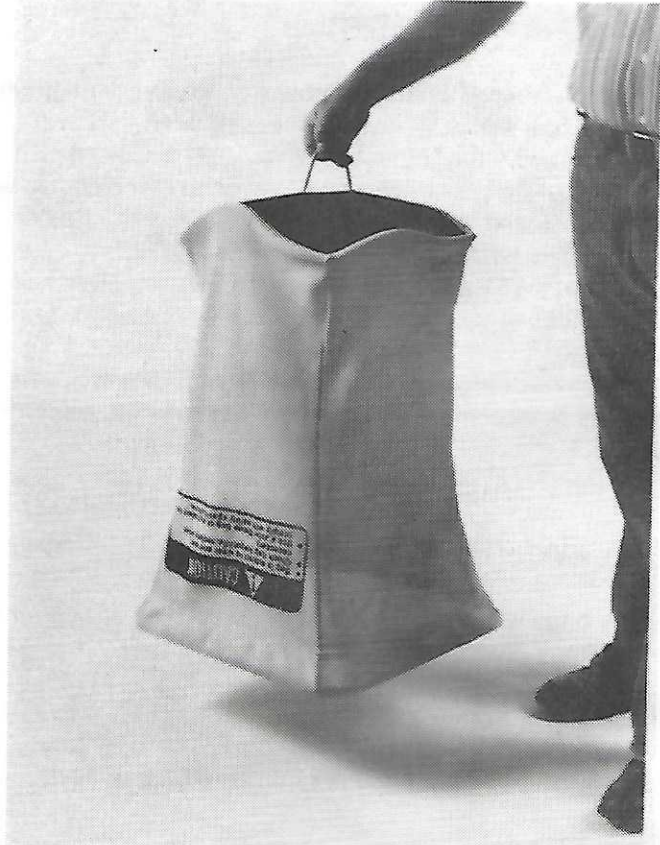

3A5;M35095 M21;;OMP AR 010584

USING FRONT WEIGHTS



CAUTION: Tractor weights improve stability in most slope operations. Add front weights to increase front-end stability and help prevent possible front end tie-up. Operate the tractor in reverse when going up steep hills or inclines; **NEVER** drive forward.

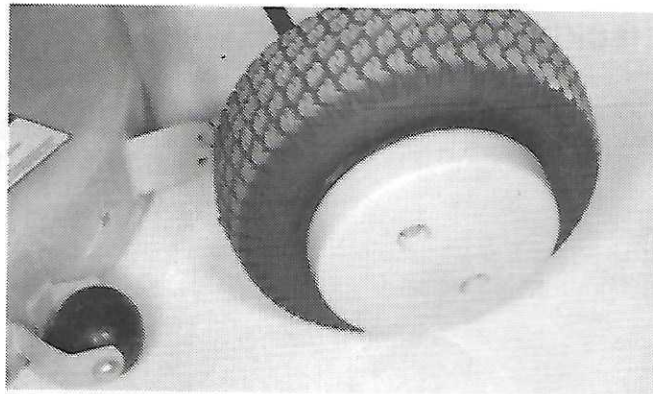

1. Use front wheel weights for stability and steering control when equipment such as the rear-mounted grass collector or dumpcart are installed.

2. Front weights when not needed, waste power, makes steering more difficult, overloads the tires, and compacts the soil unnecessarily. Be sure to remove these weights when they are not needed.

3. Each front tire weight is approximately 40 lb (18 kg) and are available through your John Deere dealer.

A98;M32861 M21;;OMJ 23 220483

USING REAR WEIGHTS

1. Use rear weights to control rear wheel slippage and maintain braking when equipment such as the snow blower and front blade are installed.
2. Select amount of rear weights by the way the tractor will perform. The tire tread pattern in the soil should show a small amount of slip. Accept some wheel slippage when blowing snow or blading.
3. Rear weights when not needed, waste power, overload the tires, and compacts the soil unnecessarily. Be sure to remove these weights when they are not needed.
4. Each rear weight is approximately 40 lb (18 kg) and only two may be used. These weights are available through your John Deere dealer.

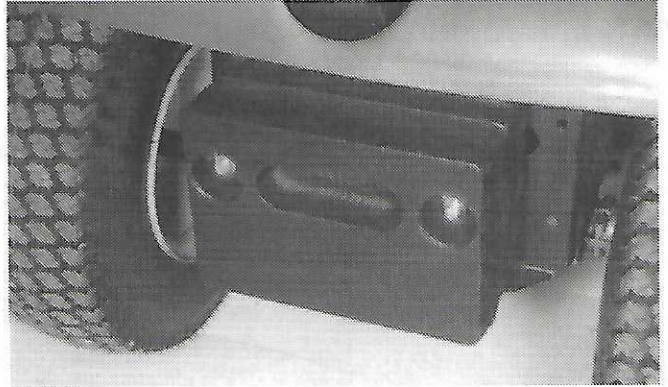

A98;M32862 M21;;OMJ 24 120583

Transporting

TRANSPORTING TRACTOR

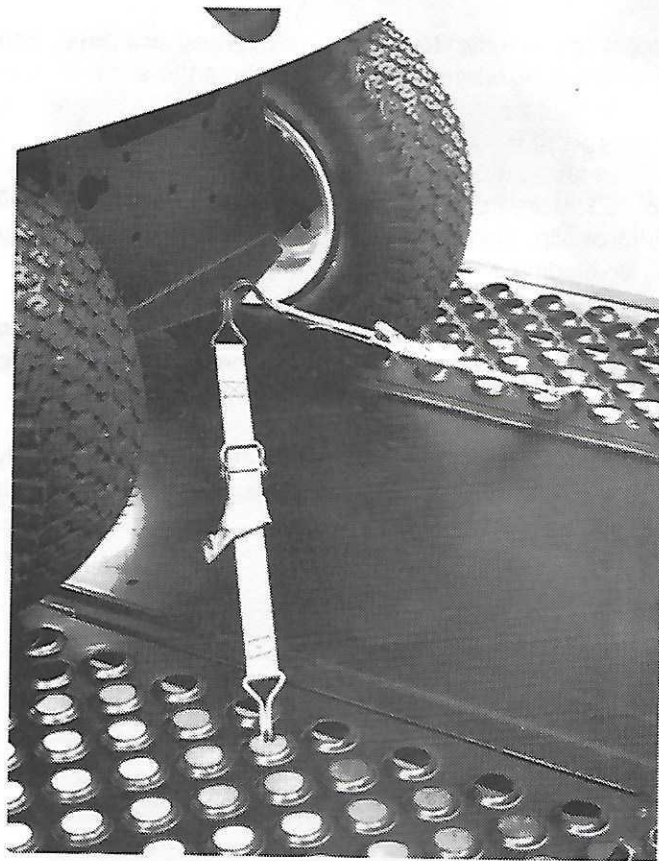
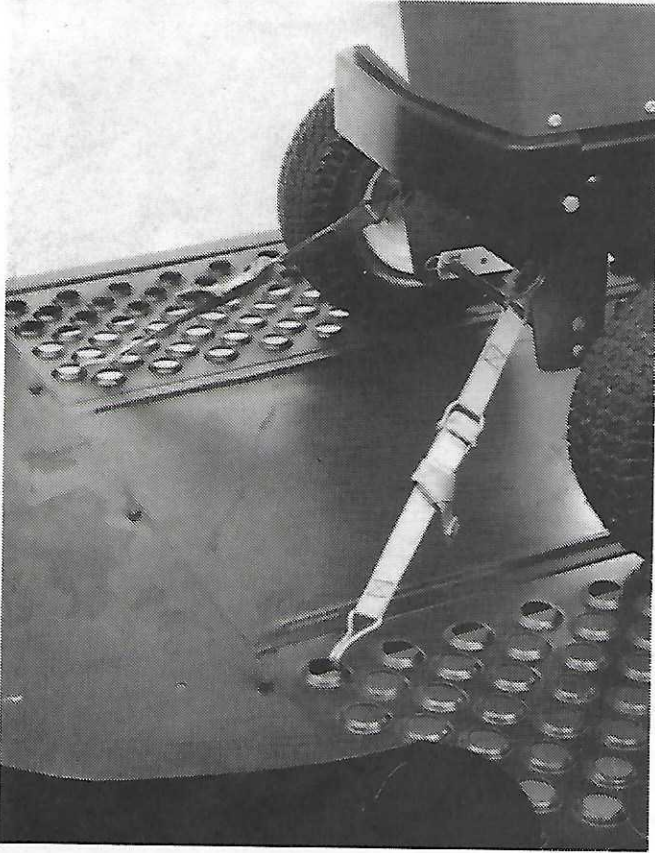

IMPORTANT: DO NOT tow tractor behind any other vehicle.

1. Use a recommended trailer for transporting.
2. Use approved tie-downs to hold tractor securely in place. Both the front and rear straps must be directed down and outward from tractor.

3. Make sure trailer has all the necessary lights and signs required by local, state, provincial, or federal laws.

A98;M32865, M32866 M21;;TPJ 04 190983

PUSHING A GEAR SELECTOR TRACTOR

IMPORTANT: DO NOT tow tractor behind any other vehicle.

To move tractor when engine is off, do the following:

- a. Release parking brake.
- b. Move shift lever to "N" position.
- c. Push tractor by hand to desired location.

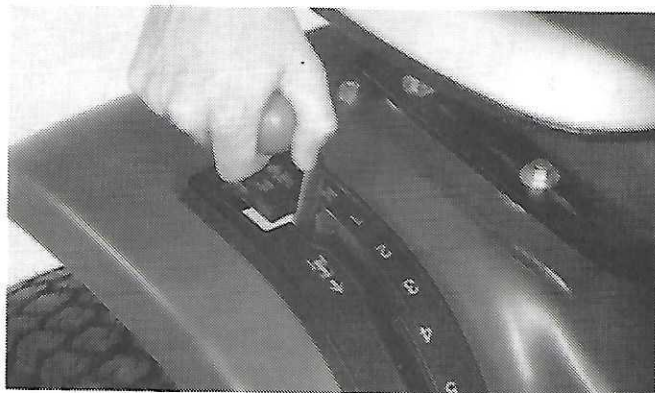

A98;M32820 M21;;TPJ 02 220483

PUSHING A HYDROSTATIC TRACTOR

IMPORTANT: DO NOT tow tractor behind any other vehicle.

To move tractor when engine is off, do the following:

- a. Release parking brake and move shift lever to "N" position.
- b. Move and hold tow disconnect lever in direction of arrow while pushing tractor to desired location.

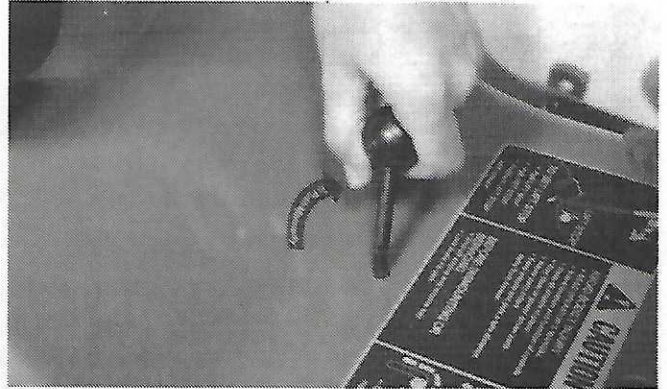

A98;M32864 M21;TPJ 03 120583

Fuels and Lubricants

FUEL



CAUTION: Handle fuel carefully. If the engine is hot or running, do not fill the fuel tank. Do not smoke while you fill the fuel tank or service the fuel system. Fill fuel tank only to "FULL LEVEL" mark.

1. Unleaded fuel is recommended. Regular leaded gasoline with an anti-knock index of 87 or higher may be used. Do not use gasoline that has been stored for a long time.

2. Fill fuel tank at end of each day's operation. Fuel tank holds 2.5 gal (9.5 L).

3. Add TY6295 John Deere Gasoline Storage Stabilizer or an equivalent to fuel tank for winter operation or storage. Follow directions on the can.

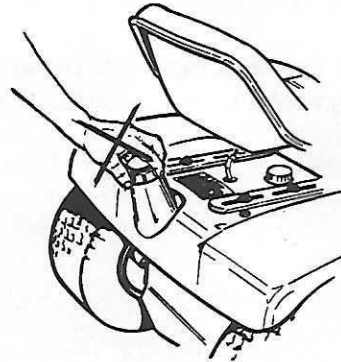

A98;M35124, M35113 M21;;FLJ 08 180784

TRANSMISSION OIL

IMPORTANT: DO NOT use Type "F" Automatic Transmission Fluid.

SAE 20 engine oil with an API Classification of SE, CC, or CD is recommended in the hydrostatic transmission. John Deere HY-GARD® Transmission and Hydraulic Oil may also be used.

A98; M21;;FLJ 03 220483

ENGINE OIL

Use oil viscosity, as shown on the temperature chart for the expected air temperature range during the drain interval.

John Deere TORQ-GARD SUPREME® engine oil is recommended. If other oils are used, they must be premium quality engine oils meeting performance requirements of:

—API Service Classification SD, SE, SE/CC or SF.

Quality engine oils are blended, so additives are neither required nor recommended.

Some increase in oil consumption may be expected when SAE 5W-20 oil is used. Check oil level frequently.

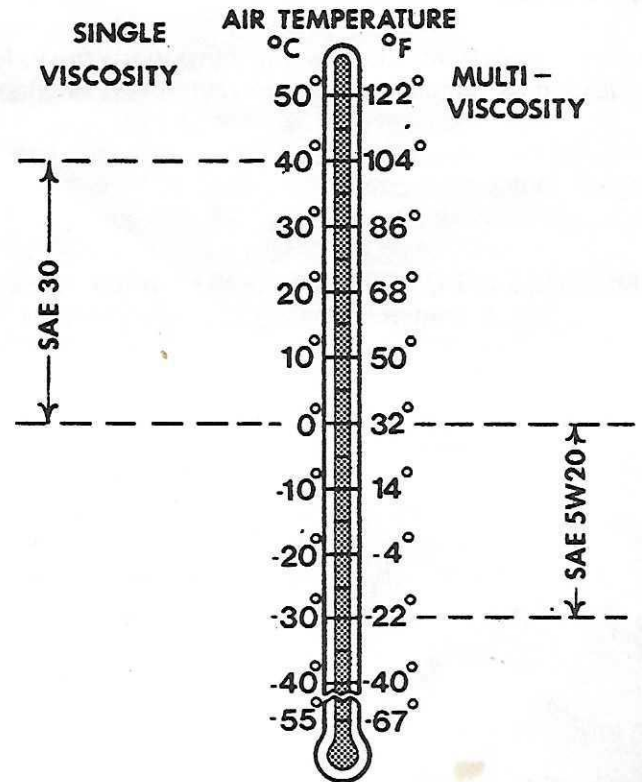

A98;M32868 M21;;FLJ 02 220483

GENERAL PURPOSE GREASE

Use grease as shown on the temperature chart for the expected air temperature range during the service interval.

John Deere Multipurpose Grease is recommended. If other greases are used, use:

- SAE Multipurpose Grease.
- SAE Multipurpose Grease containing 3 to 5 per cent molybdenum disulfide.

At temperatures below -22°F (-30°C), use arctic greases such as those meeting Military Specification MIL-G-10924C.

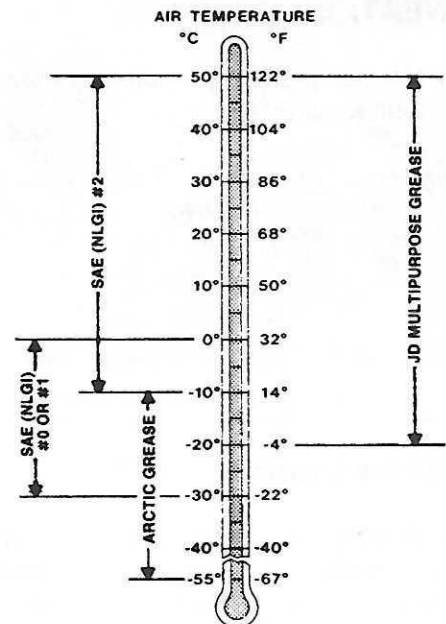

A98;X9326 M21;;FLJ 05 120583

DIFFERENTIAL OIL

Use oil viscosity as shown on the temperature chart for the expected air temperature range during the drain interval.

SAE 90 oil is recommended in the differential. Other oils shown in the chart can also be used. DO NOT mix oils of different viscosities.

IMPORTANT: DO NOT put SAE 90 oil in the hydrostatic transmission.

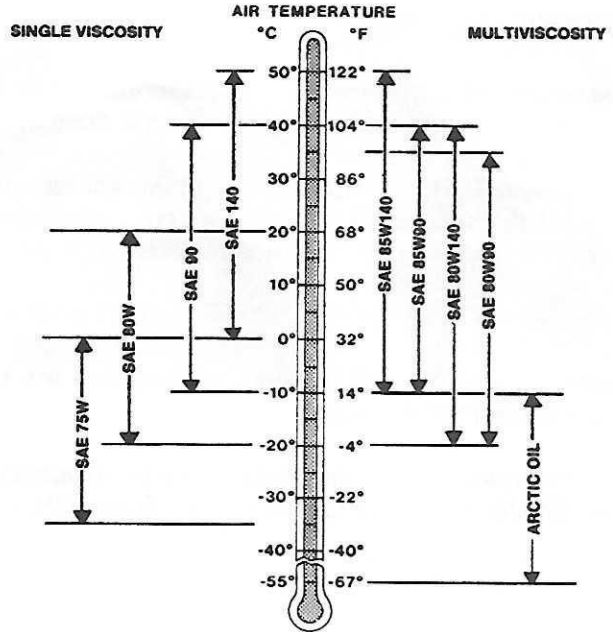

A98;X9322 M21;;FLJ 04 230583

COLD WEATHER OPERATION

Additional information on cold weather operation is available from your John Deere dealer.

A98; M21;;FLJ 06 220483

ALTERNATIVE LUBRICANTS

Conditions in certain geographical areas outside the United States and Canada may require different lubricant recommendations than those printed in the operator's manual. Consult your John Deere dealer to obtain alternative lubricant recommendations.

A98; M21;;FLJ 07 220483

Troubleshooting

ENGINE

Symptom	Problem	Correction	Page
Engine will not start.	Fuel tank empty.	Fill fuel tank.	39
	Brake and/or clutch pedal not pushed down.	Push down brake and/or clutch pedal.	15
	PTO switch in "ON" position.	Put PTO switch in "OFF" position.	15
	Neutral start switch not adjusted correctly.	See your John Deere dealer.	
	Carburetor not adjusted correctly.	See your John Deere dealer.	
	Spark plug wires loose or disconnected.	Connect spark plug wires.	61,65
	Spark plugs not gapped correctly.	Check spark plugs gap.	61,65
	Dirt or water in fuel.	See your John Deere dealer.	
	Fuel filter screen plugged.	See your John Deere dealer.	
	Transmission lever out of "N" position and brake pedal not pushed down	Put transmission lever in neutral and push down brake pedal.	15
Engine hard to start.	Gummed or plugged fuel lines.	See your John Deere dealer.	
	Carburetor not adjusted correctly.	See your John Deere dealer.	
	Carburetor dirty.	See your John Deere dealer.	
	Dirt or water in fuel.	See your John Deere dealer.	
	Faulty spark plugs.	Replace spark plugs.	61,65
	Spark plugs not gapped correctly.	Check spark plug gap.	61,65
Engine misses under load.	Loose or corroded electrical connections.	Clean and tighten connections.	
	Spark plugs not gapped correctly.	Check spark plug gap.	61,65
	Faulty spark plugs.	Replace spark plugs.	61,65
	Carburetor not adjusted correctly.	See your John Deere dealer.	
Engine vapor locks.	Dirt or water in fuel.	See your John Deere dealer.	
	Gas tank cap vent plugged.	Clean gas tank cap vent hole.	39
	Dirt in fuel filter.	See your John Deere dealer.	

ENGINE-Continued

Symptom	Problem	Correction	Page
Engine runs erratically.	Carburetor not adjusted correctly.	See your John Deere dealer.	
	Fuel line or fuel filter plugged.	See your John Deere dealer.	
	Dirt or water in fuel.	See your John Deere dealer.	
	Loose electrical connections.	Tighten electrical connections.	
	Faulty governor.	See your John Deere dealer.	
	Choke or throttle cable sticking.	Lubricate cable.	
	Loose dipstick.	Tighten dipstick.	
Engine overheats.	Air cleaner element plugged.	Clean or replace element.	51
	Engine air intake screen plugged.	Clean air intake screen.	53
	Cooling fins plugged.	Clean cooling fins on 112L. For other units see your John Deere dealer.	68
	Carburetor not adjusted correctly.	See your John Deere dealer.	
	Engine oil low.	Add oil.	50
Engine operated too long at slow idle speed.	Engine operated too long at slow idle speed.	Operate engine with throttle lever in "FAST" position.	28
Engine will not idle.	Carburetor not adjusted correctly.	See your John Deere dealer.	
	Spark plugs not gapped correctly.	Check spark plug gap.	61,65
	Faulty spark plugs.	Replace spark plugs.	
	Dirt in fuel. Plugged fuel lines.	See your John Deere dealer. See your John Deere dealer.	
Engine backfires.	Faulty spark plugs.	Replace spark plugs.	61,65
	Carburetor not adjusted correctly.	See your John Deere dealer.	
	Engine not timed correctly. Faulty condenser.	See your John Deere dealer. See your John Deere dealer.	
Engine knocks.	Stale or low octane fuel.	See your John Deere dealer.	
	Carburetor not adjusted correctly.	See your John Deere dealer.	
	Engine not timed correctly.	See your John Deere dealer.	
	Loose connecting rods.	See your John Deere dealer.	
	Carbon in combustion chamber.	See your John Deere dealer.	
	Engine overloaded. Low engine speed.	Reduce load on engine. Run engine at wide open throttle.	28

ENGINE-Continued

Symptom	Problem	Correction	Page
Engine loses power.	Engine overheating.	See Engine Overheats in this section.	
	Wrong fuel.	See your John Deere dealer.	
	Carburetor not adjusted correctly.	See your John Deere dealer.	
	Too much oil in engine.	Drain oil to correct level.	55
	Dirty air cleaner	Clean air cleaner element.	57
	Choke or throttle cable binding.	Lubricate cables.	
	Faulty spark plugs.	Replace spark plugs.	61,65
	Engine overloaded.	Reduce load on engine.	

A98; M21;;TSJ 08 180784

TRACTOR

Symptom	Problem	Correction	Page
Tractor vibrates too much	Attachment drive belts worn or damaged.	Replace belts	75
	Damaged drive sheaves.	See your John Deere dealer.	
	Faulty drive shaft.	See your John Deere dealer.	
	Dirt on drive sheaves.	Clean sheaves and belts with a damp cloth.	
Tractor will not move with engine running.	Parking brake locked.	Unlock parking brake.	15
	Transmission hydraulic level low.	Add oil.	62
	Cold weather.	Allow tractor to warm several minutes.	17
	Shift lever in "N" position.	Move shift lever to forward or reverse position.	21
Tractor moves with engine running and hydrostatic control lever in neutral.	Linkage out of adjustment.	See your John Deere dealer.	

A98; M21;;TSJ 03 180784

Troubleshooting

ELECTRICAL

Symptom	Problem	Correction	Page
Starter does not work or will not turn engine.	Hydrostatic control lever engaged.	Move lever to "N" position.	14
	PTO switch in "ON" position.	Move switch down to "OFF" position.	15
	Electrical connections loose.	Tighten connections.	
	Neutral start switch faulty or not adjusted correctly.	See your John Deere dealer.	
	Battery discharged.	See your John Deere dealer.	
Battery will not charge.	Battery terminals corroded.	Clean battery terminals.	66
	Key switch or starter motor faulty.	See your John Deere dealer.	
	Rectifier damaged.	See your John Deere dealer.	
	Loose electrical connections.	Tighten connections.	
	Dead cell in battery.	Replace battery.	
	Low engine speed or excessive idling.	Run engine at wide open throttle.	28

A98; M21;;TSJ 04 180784

BRAKES

Symptom	Problem	Correction	Page
Rear wheel brakes not working.	Brakes not adjusted correctly.	See your John Deere dealer.	
	Worn brake pucks.	See your John Deere dealer.	
	Oil or grease on brake disk.	See your John Deere dealer.	
	Worn or damaged brake linkage.	See your John Deere dealer.	

A98; M21;;TSJ 05 180784

STEERING

Symptom	Problem	Correction	Page
Faulty steering.	Tires not inflated correctly.	Check tire inflation pressure.	57
	Linkage lacks lubrication.	Lubricate linkage.	
	Too much play in steering.	See your John Deere dealer.	
	Bent steering linkage.	See your John Deere dealer.	

A98; M21;;TSJ 06 180784

MOWER

Symptom	Problem	Correction	Page
Discharge chute plugged.	Belt installed incorrectly.	Change belt installation.	75
	Grass too wet.	Wait for grass to dry.	
	Grass too long.	Raise cutting height and cut grass twice.	31
	Engine rpm too low.	Mow at full throttle.	28
Patches of grass uncut.	Travel speed too fast.	Slow down.	28
	Engine rpm too low.	Mow at full throttle.	28
	Blades dull or damaged.	Replace blades or have blades sharpened.	78
	Wrong belt tension spring.	Replace tension spring.	
Belt slipping.	Mower plugged.	Unplug and clean mower deck.	29
	Debris in sheaves.	Clean sheaves.	29
Too much vibration.	Debris on mower deck or in sheaves.	Clean mower deck and sheaves.	29
	Damaged drive belt.	Replace drive belt.	75
	Damaged sheaves or sheaves out of alignment.	Replace sheaves. See your John Deere dealer.	
	Blades out of balance.	Have blades balanced.	
Blades scalping grass.	Cutting too low.	Raise cutting height.	24
	Turning speed too fast.	Reduce speed on turns.	
	Ridges in terrain.	Change mowing pattern.	30
	Rough or uneven terrain.	Adjust mower wheels.	25
	Mower wheels not adjusted correctly.	Adjust mower wheels.	25
	Low tire pressure.	Add air to tire.	57
Uneven cut.	Mower not level.	Level mower.	25
	Travel speed too fast.	Slow down.	29
	Blades dull.	Have blades sharpened.	
	Mower wheels not adjusted correctly.	Adjust mower wheels.	25
Mower loads down tractor.	Engine rpm too low.	Mow at full throttle.	28
	Travel speed too fast.	Slow down.	29
	Debris wrapped around mower spindles.	Clean mower.	29
	Bagging blades on mower.	Install regular blades.	33

Periodic Service

ADDITIONAL SERVICE INFORMATION

This manual is not a detailed service manual. It has only information you need for normal operation and maintenance.

If you want more detailed service information, use the form in the back of this manual to order a technical manual.

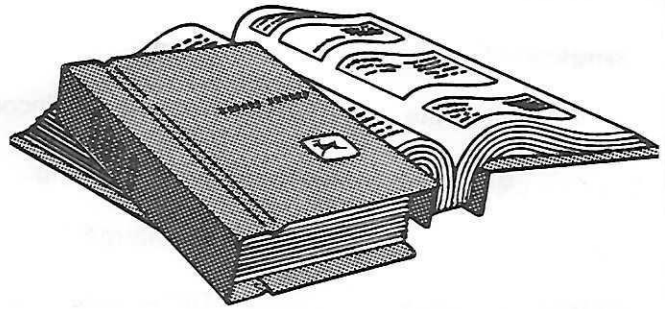

A98;RW408 M21;;PSJ 01 190784

USING SERVICE RECORDS

1. Keep a record of the number of hours you run your tractor engine and mower.
2. Check your record regularly to learn when your tractor and mower need service.
3. Do all the services in an interval section. Then write the number of hours (from your service record) and the date in the spaces provided.

SAMPLE SERVICE RECORD CHART

<i>DATE</i>	<i>HOURS</i>
<i>1 JUN '83</i>	<i>3</i>
<i>6 JUN '83</i>	<i>2 - (5)</i>
<i>7 JUN '83</i>	<i>1 - (6)</i>
<i>11 JUN '83</i>	<i>4 - (10)</i>
<i>17 JUN '83</i>	<i>3 - (13)</i>

A98;M35096 M21;;PSJ 02 190784

BEFORE EACH USE

Check engine oil level.

Clean air intake screen(s).

Hours	<i>5 HR.</i>	<i>22 HRS</i>		
Date	<i>5-7-85</i>	<i>9-5-86</i>		
Hours	<i>1 5-7-85</i>			
Date	<i>5-15-85</i>			
Hours	<i>7 hours</i>			
Date	<i>8.01.85</i>			
Hours	<i>14 HRS.</i>			
Date	<i>7/11.19.85</i>			
Hours	<i>15 hours</i>			
Date	<i>20 WT.</i>			
Hours	<i>17 HRS</i>			
Date	<i>4/3/86</i>			

A98;M33856 M21;;PSJ 03 190784

10 HOURS

Lubricate front wheel spindles.

Hours				
Date				
Hours				
Date				
Hours				
Date				
Hours				
Date				
Hours				
Date				
Hours				
Date				

A98;M33856 M21;;PSJ 04 190784

25 HOURS

- Change engine oil—engine without oil filter.
- Check tire pressure.
- Clean air cleaner element or precleaner.
- Check battery electrolyte level.
- Check spark plug—108, 111, and 116 Tractors.
- Check transmission oil level—112L and 116H Tractors.

New Battery 1/10/95

Hours				
Date				
Hours				
Date				
Hours				
Date				
Hours				
Date				
Hours				
Date				
Hours				
Date				

A98;M33856 M21;;PSJ 05 190784

50 HOURS

- Change engine oil—112L engine with oil filter.

Hours				
Date				
Hours				
Date				
Hours				
Date				
Hours				
Date				
Hours				
Date				
Hours				
Date				

A98;M33856 M21;;PSJ 06 190784

100 HOURS

- Change engine oil filter—112L Tractor.
- Check spark plug—112L Tractor.
- Clean fuel pump screen—112L Tractor.
- Clean paper air cleaner element—112L Tractor.

Hours				
Date				
Hours				
Date				
Hours				
Date				
Hours				
Date				
Hours				
Date				
Hours				
Date				

A98;M33856 M21;;PSJ 07 230884

Periodic Service

YEARLY

Check differential oil level—112L and 116H Tractors.

Clean battery.

Clean engine fins—112L Tractor.

Hours				
Date				
Hours				
Date				
Hours				
Date				
Hours				
Date				
Hours				
Date				
Hours				
Date				

A98;M33856 M21;;PSJ 08190784

Service/Before Each Use

CHECKING ENGINE OIL LEVEL—108 TRACTOR



CAUTION: Check engine oil when oil is cold.

IMPORTANT: DO NOT operate engine when oil level is low.

1. Park tractor on a level surface. Clean around oil fill plug area.
2. Remove fill plug. Fill plug housing must be full to the point of overflowing.

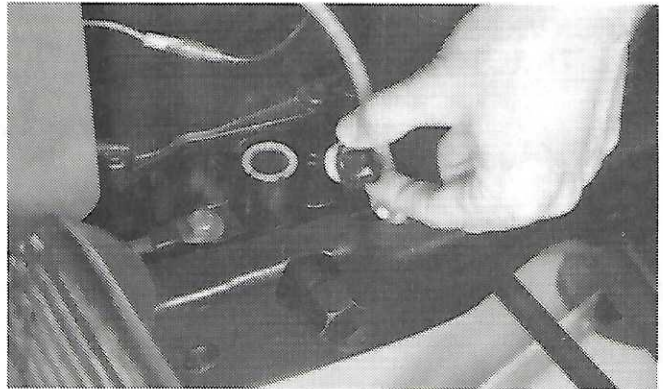

A98;M32869 M21;;SEJ 01 180784

3. If oil level is low, slowly add enough oil to bring oil level to the point of overflowing. (See Fuel and Lubricants section for the recommended oil to use.)

4. Install and tighten oil fill plug.
5. Clean up any spilled oil.

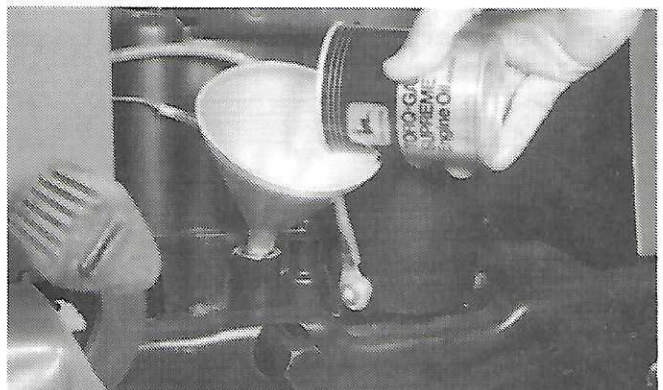

A98;M32870 M21;;SEJ 02 190983

CHECKING ENGINE OIL LEVEL— 112L TRACTOR

NOTE: Check oil twice a day if you use your 112L Tractor for very difficult mowing.

1. Park tractor on a level surface.
2. Check engine oil when oil is cold.
3. Lift hood.



IMPORTANT: Engine must not be running.

4. Remove dipstick. Wipe dipstick with a clean rag.

A98;M35420 M21;;SEJ 98 180784

5. Install dipstick in tube, but do not tighten it. Let dipstick threads rest on top of tube.



A98;M35421 M21;;SEJ 99 180794

6. Remove dipstick. Check oil level on dipstick.
7. Oil must be between "ADD" and "FULL" marks.

IMPORTANT: If oil level is below "ADD" mark, DO NOT run the engine.

8. If oil level is low, add oil to bring oil level no higher than "FULL" mark on dipstick. (See Engine Oil in Fuels and Lubricants section for correct oil.)

9. Install and tighten dipstick. Lower hood.

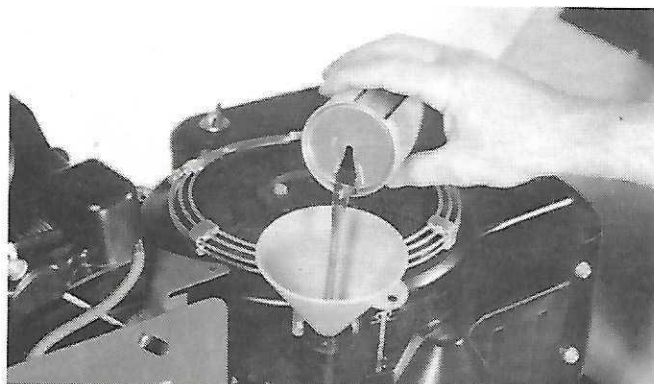

A98;M35422 M21;;SEJ 100 180784

M65;P51 040884

CHECKING ENGINE OIL LEVEL FOR 111 AND 116 TRACTORS



CAUTION: Check engine oil when oil is cold.

IMPORTANT: DO NOT operate engine when oil level is below the "ADD" mark.

1. Park tractor on a level surface.
2. Lift hood.
3. Check dipstick:
 - a. Remove dipstick.
 - b. Wipe dipstick with a clean rag.
 - c. Install and tighten dipstick.
 - d. Remove dipstick.
 - e. Check oil level. Oil level must be between "ADD" and "FULL" marks.



A98;M32871, M32872 M21;;SEJ 03 230884

4. If oil level is at the "ADD" mark or below, add enough engine oil to bring oil level to the "FULL" mark. DO NOT fill above "FULL" mark. (See Fuel and Lubricant section for the recommended oil to use.)

5. Install and tighten dipstick.



A98;M32873 M21;;SEJ 04 260483

CHECKING OR CLEANING AIR INTAKE SCREENS

IMPORTANT: Keep air intake screens clean to prevent engine from overheating.

1. Lift hood.
2. Clean screen(s) with brush or cloth.

108 and 111 Intake Screen

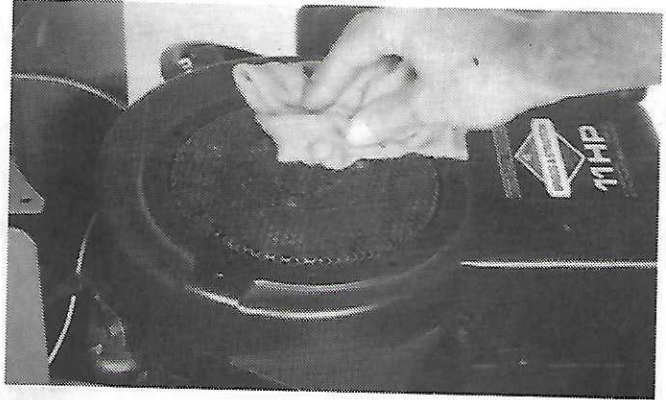

112L Intake Screen

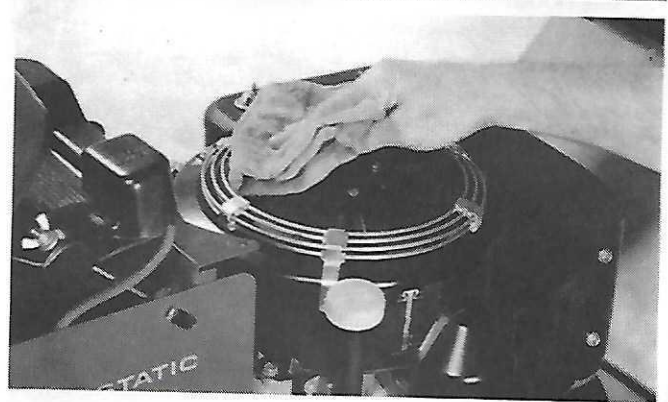

116 Pedestal Screen

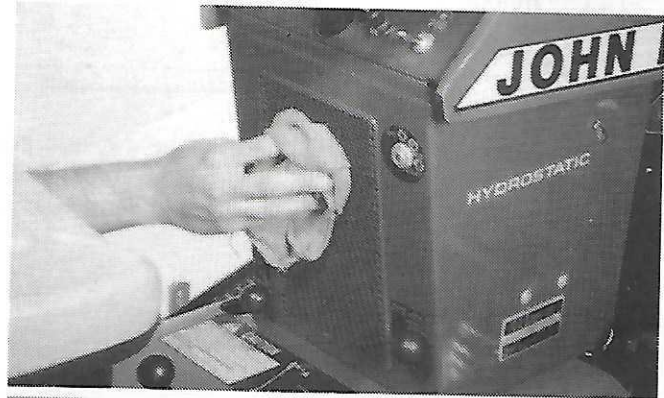

116 Intake Screen

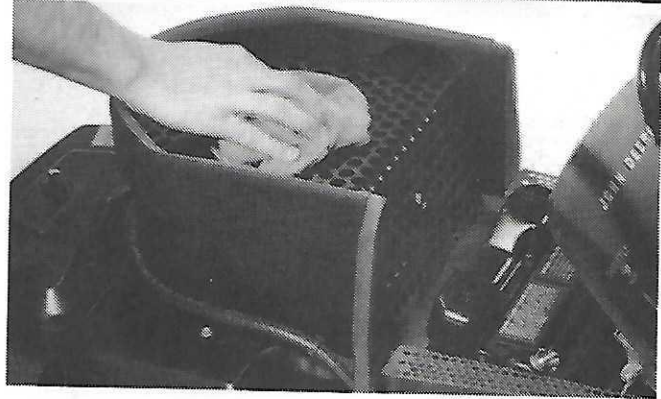

Service/10-Hours

LUBRICATING WHEEL SPINDLES

Use John Deere Multi-Purpose grease or an equivalent in front axle grease fittings.

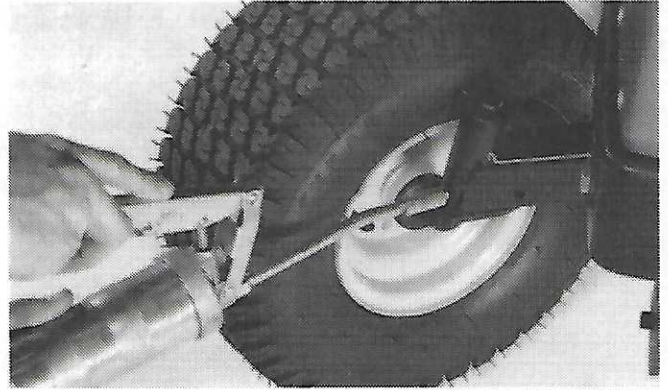

A98;M32880 M21;;SEJ 08 260483

Service/25-Hours

CHANGING ENGINE OIL—ENGINE WITHOUT OIL FILTER

NOTE: Change engine oil after first 5 hours of operation. After that, change oil every 25 hours under normal conditions or every 8 hours under extremely dusty conditions.

1. Run engine to warm the oil.
2. Park tractor on level surface.
3. Remove drain cap to drain oil.
4. Install drain cap.

*108 Tractor (upper)
112L Tractor (middle)
116 Tractor (lower)*

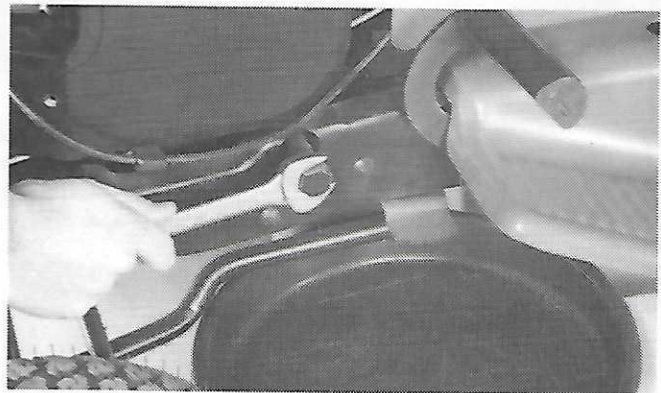
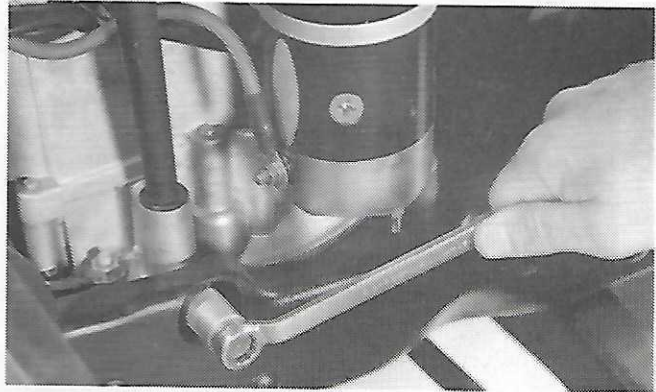
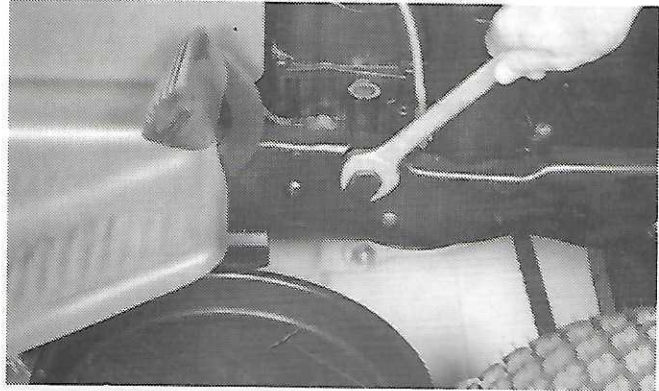

A98;M32818, M35424, M32819 M21;;SEJ 09 180784

5. 108 Tractor: remove fill plug (top photograph).

112L Tractor: remove dipstick (middle photograph).

111 and 116H Tractor: remove dipstick (bottom photograph).

6. Add oil. (See Engine Oil in Fuels and Lubricants section for correct oil.)

Engine Oil Capacity

108 Tractor	2 1/4 pt (1 L)
111 and 112L Tractors (without filter)	3 pt (1.4 L)
112L Tractor with filter	3 1/2 pt (1.7 L)
116 Tractor	3 pt (1.4 L)

7. Tractors with oil plug: fill the plug housing full.

Tractor with dipstick: oil must be between "ADD" and "FULL" marks on dipstick. Before you check a 111 or 116 tractor dipstick, screw dipstick cap down. Before you check a 112L tractor dipstick, let dipstick cap threads rest on top of dipstick tube.

8. Install and tighten oil plug or dipstick.

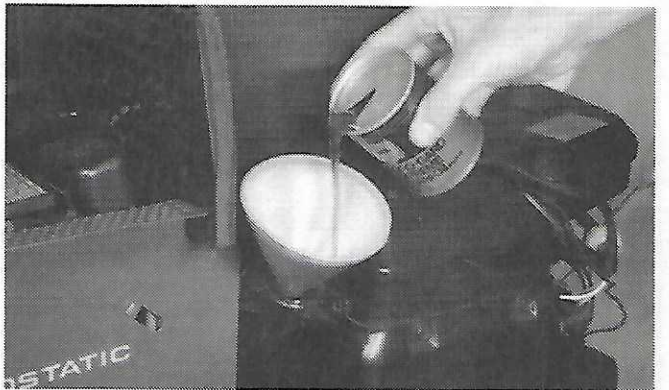
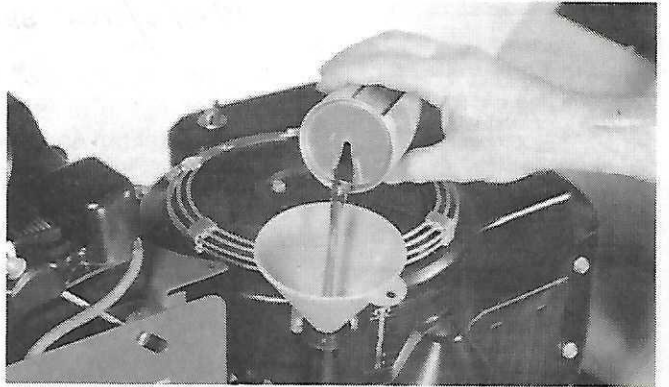
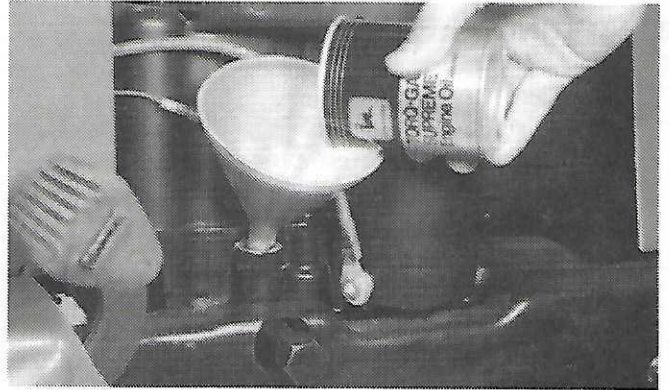

A98;M32870, M35422, M32873 M21;;SEJ 10 180784

CHECKING TIRE PRESSURE

1. Check tires for damage.
2. Check tires for proper tire pressure.

TIRE PRESSURE SPECIFICATION

Tire Size	Pressure
Front:	
13 x 5.00-6	12 psi (83 kPa) (0.8 bar)
15 x 6.00-6	10 psi (69 kPa) (0.7 bar)
Rear:	
18 x 6.50-8	10 psi (69 kPa) (0.7 bar)
18 x 8.50-8	8 psi (55 kPa) (0.6 bar)
20 x 10.00-8	6 to 10 psi (41 to 69 kPa) (0.4 to 0.7 bar)

17 psi w/snow blower

CAUTION: NEVER exceed maximum tire pressure specified by tire manufacturer. Overinflation can cause injury.

3. If tire pressures are low, fill tire to proper specification.

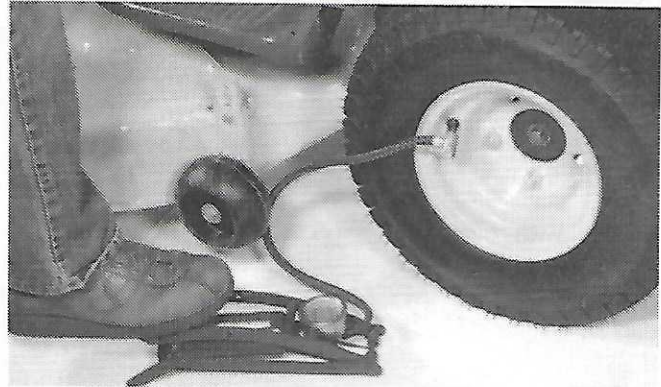
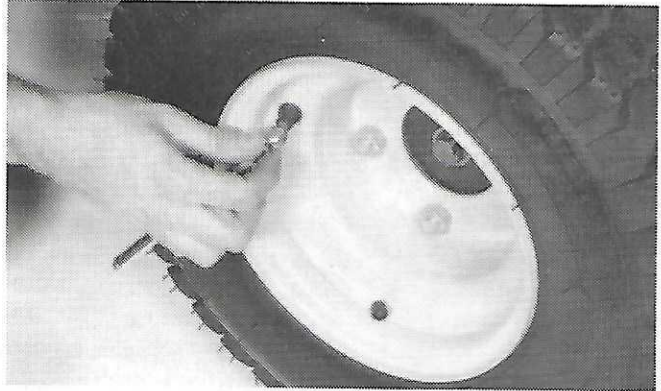

A98;M32881, M32882 M21;;SEJ 11 120583

CLEANING AIR CLEANER ELEMENT— 108 AND 111 TRACTORS

NOTE: If you operate tractor in dusty conditions, replace element more often.

1. Lift hood.
2. Remove two screws. Remove cover.



A98;M32883 M21;;SEJ 12 170784

3. Put a clean cloth in air intake to prevent dirt from entering the carburetor.
4. Remove special screw to remove cover plate and paper element. Remove cover from element.
5. Clean by tapping paper element gently on a flat surface.

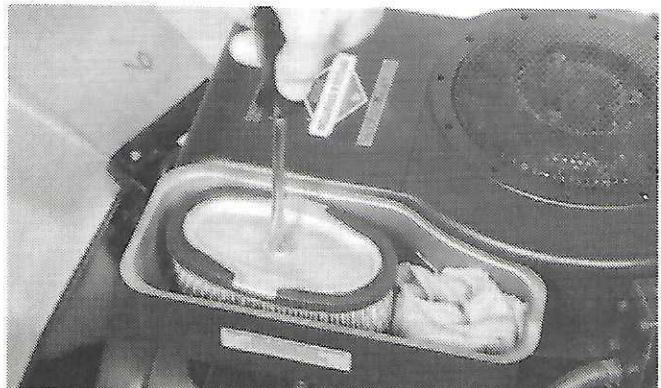

A98;M32884 M21;;SEJ 13 260483

6. If element is very dirty, replace or clean element as follows:

- a. Wash element in liquid detergent and water. DO NOT use petroleum solvents to clean element.
- b. Rinse element until water is clear.
- c. Let element air-dry thoroughly. DO NOT use compressed air to dry element. DO NOT put oil on element.

7. Install paper element and cover plate. Fasten element with special screw.

8. Install cover and fasten with two screws.

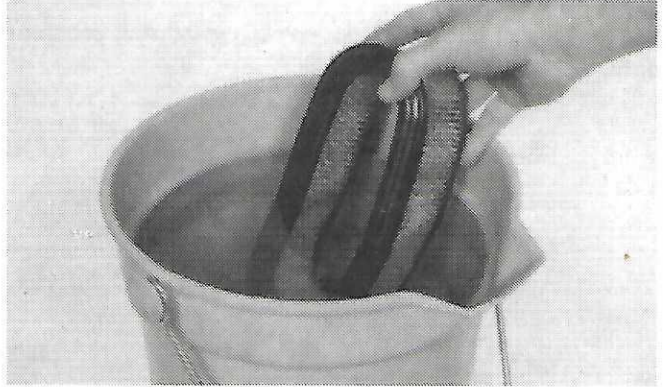

A98;M32890 M21;;SEJ 97 260483

CLEANING PRECLEANER AND AIR CLEANER ELEMENT—112L AND 116 TRACTORS

NOTE: If you operate tractor in dusty conditions, replace element more often.

1. Lift hood.
2. Loosen wing nuts on 112L cover. Remove wing nut on 116 cover. Remove cover.

112L Tractor (upper)



116 Tractor (lower)



A98;;M35425, M32885 M21;;SEJ 101 180784

3. Remove precleaner from paper element. If precleaner is dirty, wash it.

112L Tractor

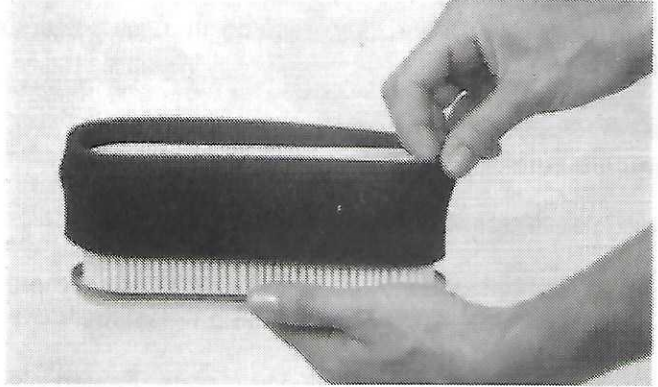

116 Tractor

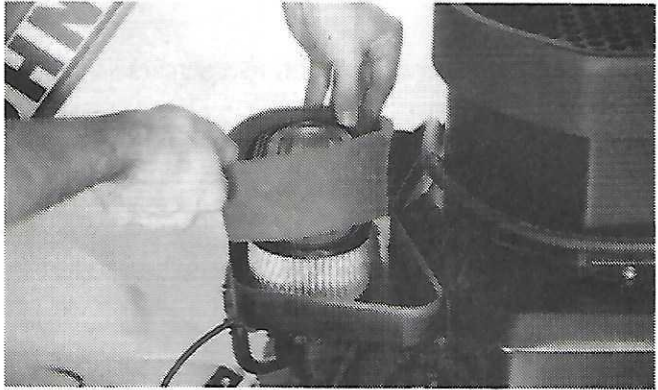

A98;M35433, M32886 M21;;SEJ 102 180784

4. Wash pre-cleaner in liquid detergent and warm water. Squeeze element to remove excess water and allow to air dry.



A98;M32887 M21;;SEJ 16 260483

5. Put approximately 1 oz (30 mL) of clean engine oil on pre-cleaner. Squeeze pre-cleaner to distribute oil evenly.

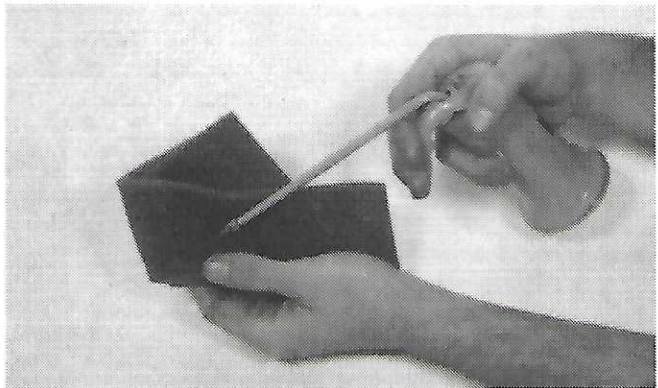

A98;M32888 M21;;SEJ 17 260483

6. Remove nut (116 Tractor) to remove cover plate and paper element. Remove cover plate from element.

7. Put a clean cloth in air intake to prevent dirt from entering the carburetor.

NOTE: On 112L Tractor, clean paper element every 100 hours.

8. Clean by tapping paper element gently on a flat surface.

9. If element is very dirty, replace or clean element as follows:

a. Wash element in liquid detergent and water. DO NOT use petroleum solvents to clean element.

b. Rinse element until water is clear.

c. Let element air-dry thoroughly. DO NOT use compressed air to dry element. DO NOT oil element.

10. Install all parts.

11. Fasten air cleaner cover with wing nut(s).

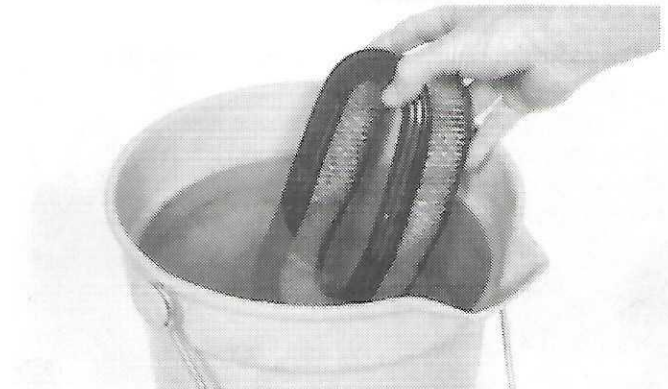
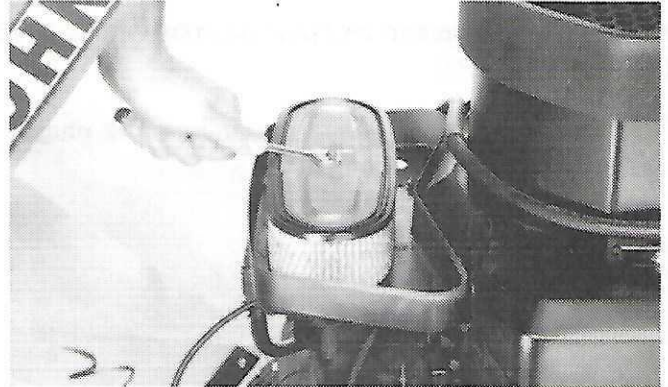

A98;M32889, M32890 M21;;SEJ 18 260483

CHECKING BATTERY ELECTROLYTE LEVEL



CAUTION: Protect against fire and explosion. Keep battery hold-down cover over battery post. Battery electrolyte is poisonous and corrosive. It can injure eyes, skin, and clothing. Handle it carefully. If electrolyte is spilled, flush immediately with a solution of 1 part baking soda to 4 parts water.

1. Lift hood and remove both cell caps.

2. Check that the electrolyte level (A) is 1/4 to 1/2 in. (6 to 13 mm) above plates (B).

3. If necessary, add distilled water to proper level. DO NOT fill to bottom ledge of filler tube.

4. Install caps.

5. During freezing weather, run engine at least 1 hour to mix water and electrolyte thoroughly.

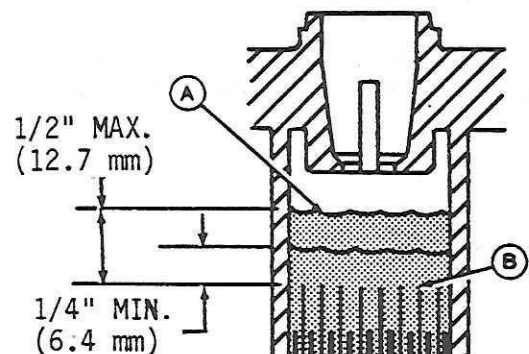
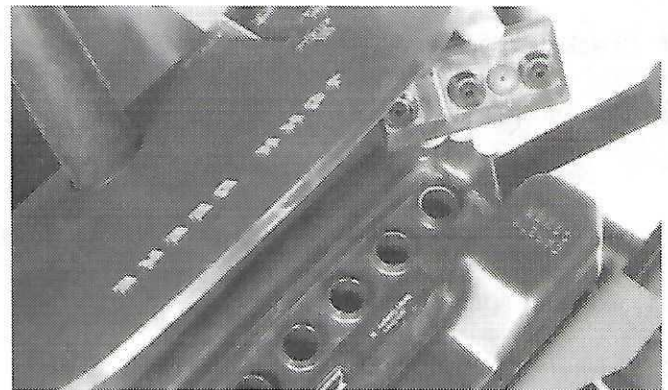

A98;M32891, M32892 M21;;SEJ 19 120583

CHECKING SPARK PLUG(S)—108, 111, AND 116 TRACTORS



CAUTION: Before you remove spark plugs:
Stop engine.
Wait until engine is cool.

1. Lift hood.
2. Disconnect spark plug wire(s) from spark plug(s).
3. Remove spark plug(s).
4. Clean spark plug(s) carefully with a wire brush.
5. Inspect spark plug(s) for:
 - Cracked porcelain
 - Pitted or damaged electrodes
 - Other wear or damage

NOTE: In Canada use only resistor plugs.

6. Replace spark plug(s) as necessary.

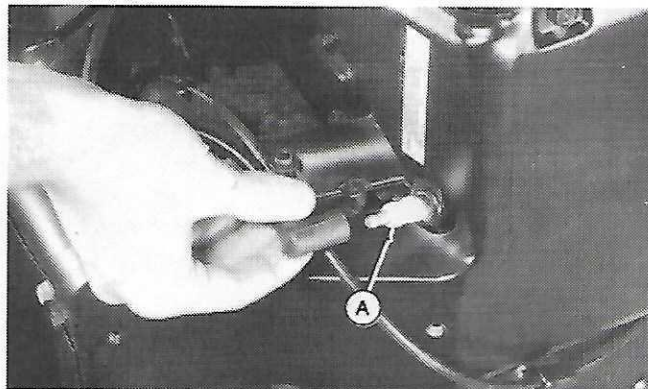

A98;M32893 M21;;SEJ 103 180784

7. Check plug gap with a wire feeler gauge.
8. Gap must be 0.030 in. (0.76 mm).
9. To change gap, move the outer electrode.
10. Install and tighten spark plug(s) to 15 lb-ft (20 N·m).
11. Connect spark plug wire(s).
12. Lower hood.

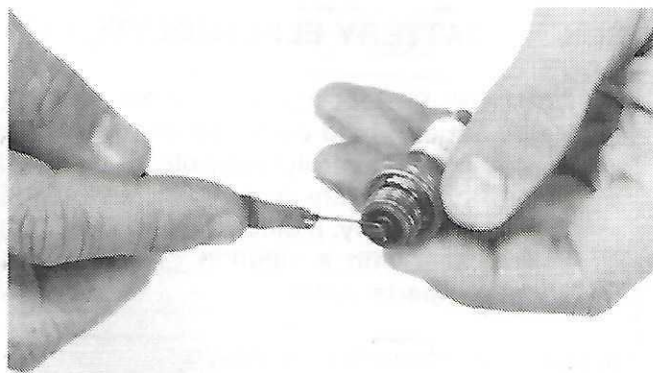

A98;M33906 M21;;SEJ 115 180784

CHECKING TRANSMISSION OIL LEVEL—112L AND 116H TRACTORS

1. Park tractor on level surface.
2. Check transmission oil level when engine is cold.
3. Remove dipstick cap.
4. Wipe dipstick with a clean cloth.
5. Install and tighten dipstick cap.
6. Remove dipstick cap. Oil level must be between the "FULL" and "ADD" marks.

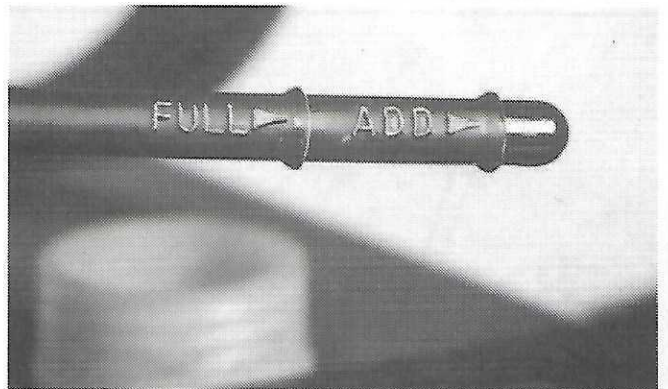
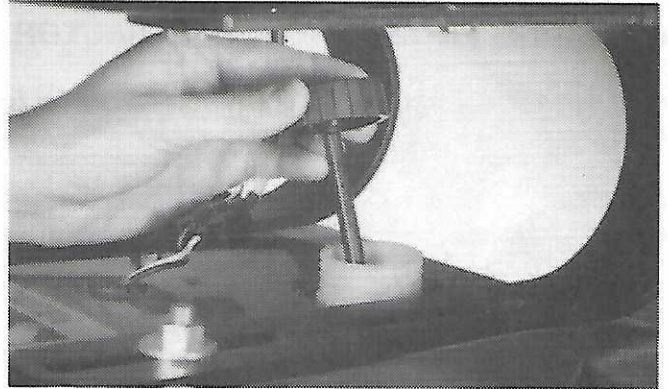

A98;M32874, M32875 M21;;SEJ 05 180784

7. If oil is at or below the "ADD" mark, add enough oil to bring oil level to the "FULL" mark. DO NOT fill above "FULL" mark. (See Fuels and Lubricants section for correct oil.)
8. Install and tighten dipstick cap.
9. Start engine.
10. Operate tractor forward and in reverse several times.
11. Park tractor on level surface.
12. Check oil level again.



A98;M32876 M21;;SEJ 06 180784

Service/50-Hours

CHANGING ENGINE OIL—112L TRACTOR

Change engine oil if your 112L engine has an oil filter (extra equipment).

See Changing Engine Oil in Service/25-Hours section for correct procedure.

A98; M21;SEJ 104 180784

Service/100-Hours

CHANGING ENGINE OIL FILTER— 112L TRACTOR

1. Remove drain cap to drain oil.
2. Install cap.

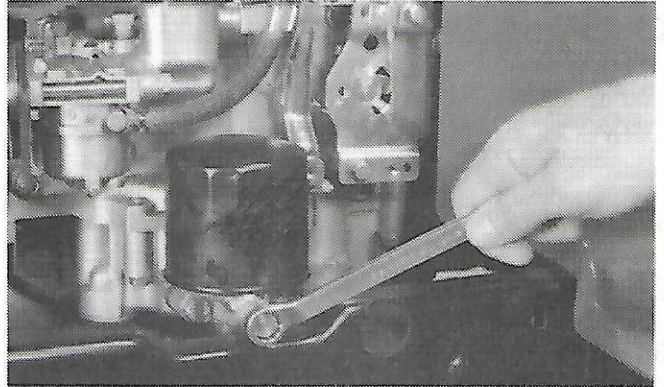

A98;;M35434 M21;;SEJ 105 180784

3. Turn filter counterclockwise to remove it.
4. Apply a film of clean engine oil on seal of new filter.
5. Install filter. Turn filter until seal contacts mounting surface. Then turn filter BY HAND 1/2 turn more.
6. Run engine at slow speed 2 minutes. Check for leaks around filter.
7. Stop engine. Check oil level. Add oil only to "FULL" mark on dipstick.
8. Install and tighten dipstick. Lower hood.

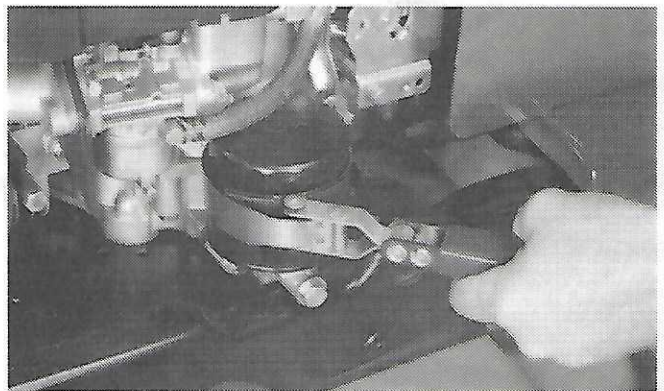

A98;M35435 M21;;SEJ 106 180784

CHECKING SPARK PLUG—112L TRACTOR



CAUTION: Before you remove spark plug:
Stop engine.
Wait until engine is cool.

1. Lift hood.
2. Disconnect spark plug wire.
3. Remove spark plug.
4. Clean spark plug carefully with a wire brush.
5. Inspect spark plug for:
 - Cracked porcelain
 - Pitted or damaged electrodes
 - Other wear or damage

NOTE: In Canada, replace spark plug with resistor plug only.

6. Replace spark plug as necessary.

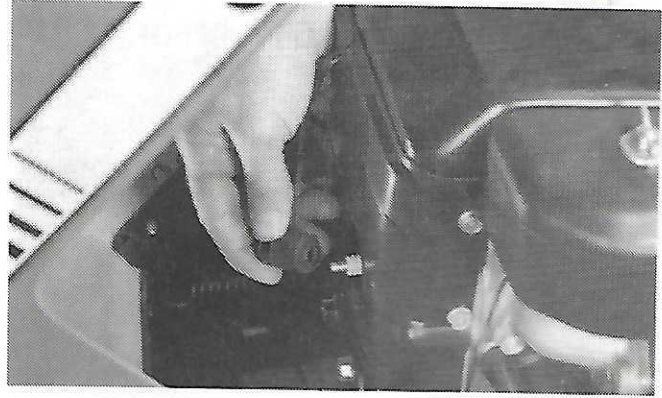

A98;;M35436 M21;;SEJ 107 180784

7. Check plug gap with a wire feeler gauge.
8. Gap must be 0.025 in. (0.64 mm).
9. To change gap, move the outer electrode.
10. Install and tighten spark plug to 15 lb-ft (20 N·m).
11. Connect spark plug wire.
12. Lower hood.

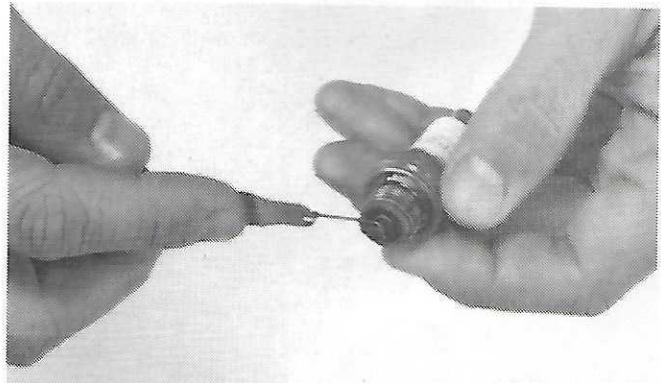

A98;;M33906 M21;;SEJ 113 180784

CLEANING FUEL PUMP SCREEN—112L TRACTOR

Brush dirt from screen.

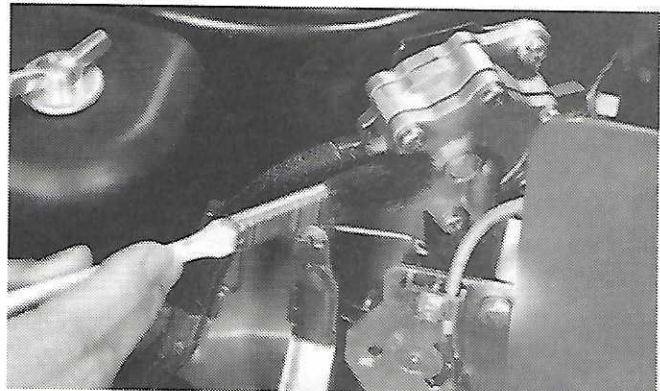

A98;;M35437 M21;;SEJ 114 180784

Service/Yearly

CHECKING DIFFERENTIAL OIL FOR 112L AND 116H TRACTORS

1. Lock park brake.
2. Remove mower. (See Removing Mower in Service/As Necessary section.)
3. Clean the area around differential check plug.
4. Remove check plug.

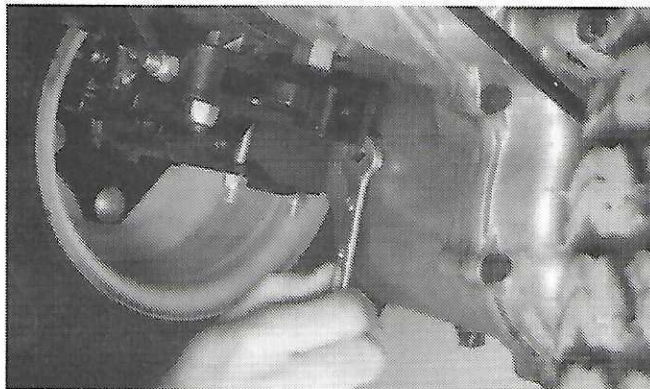

A98;M32895 M21;;SEJ 22 180784

5. Check if you can feel oil. If you can, the oil level is all right.

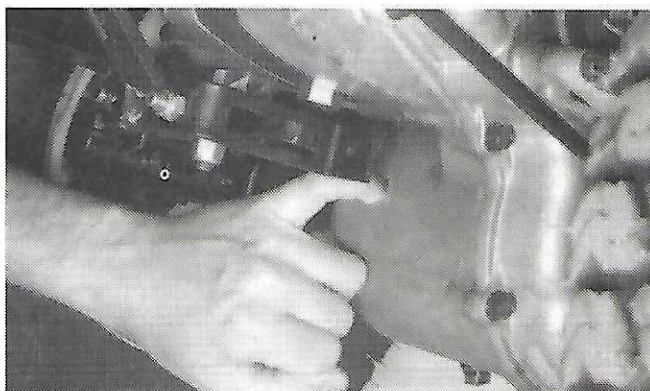

A98;M32896 M21;;SEJ 23 120583

6. If oil level is low, add SAE 90 oil until oil can be felt.



A98;M32897 M21;;SEJ 24 260483

CLEANING BATTERY AND TERMINALS



CAUTION: Gas given off by batteries is explosive. Keep sparks and flames away from batteries.

1. Loosen wing nuts to remove hold-downs and battery hold-down cover.

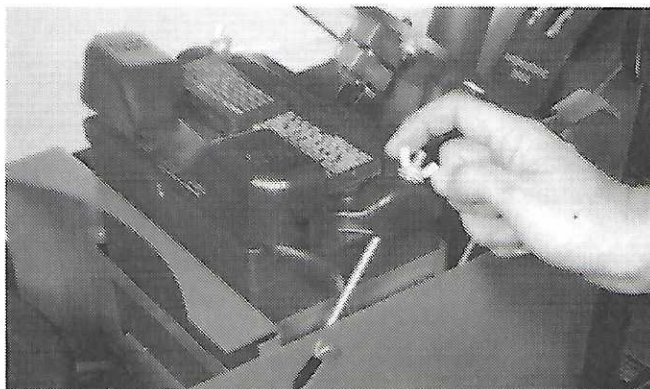

A98;M32898 M21;;SEJ 25 260483

2. Remove negative (black) cable from battery first.
3. Remove positive (red) cable.



A98;M32899 M21;;SEJ 26 260483

4. Thoroughly clean exterior surface of battery with brush or cloth. Keep dirt out of battery cells.
5. Remove corrosion from battery terminals and cable ends with a wire brush.

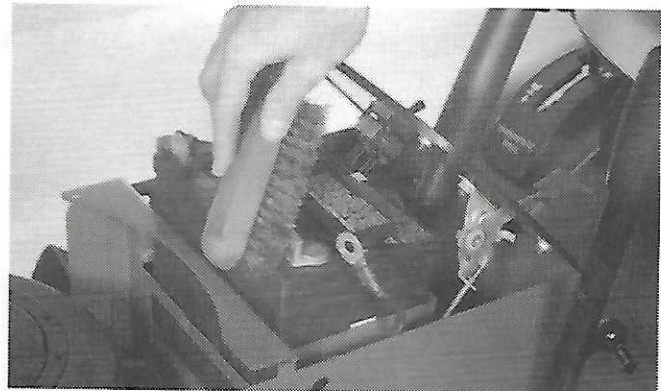

A98;M32900 M21;;SEJ 27 270483

6. If battery is excessively dirty, remove battery to clean it and the battery box.
7. Clean battery, battery terminals, cable ends, hold-down cover, battery box, and other parts with a solution of 1 part baking soda to 4 parts water. KEEP solution out of battery cells.
8. Rinse all parts with clean water and let dry.

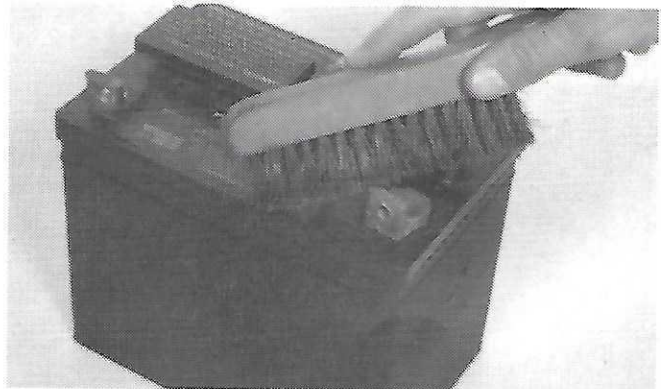

A98;M32901 M21;;SEJ 28 270483

9. If removed, install battery.
10. Check cell cap to be sure vent holes are open.
11. Connect positive (red) cable to battery first, then negative (black) cable.
12. Apply petroleum jelly on battery terminals.
13. Install battery hold-down cover and install the hooked end of hold-down in slots. Tighten wing nuts.

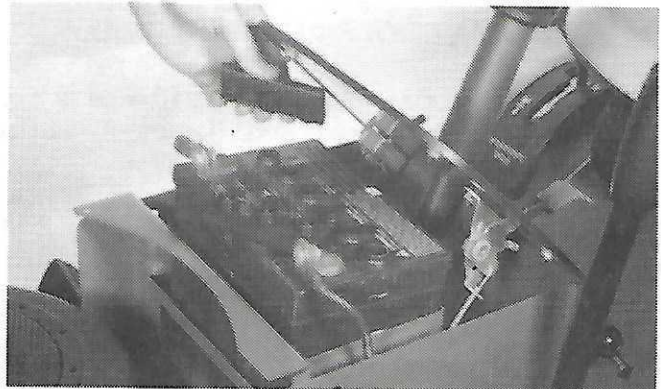

A98;M32902 M21;;SEJ 29 120583

CLEANING ENGINE FINS—112L TRACTOR

1. Lift hood.
2. Disconnect spark plug wire.

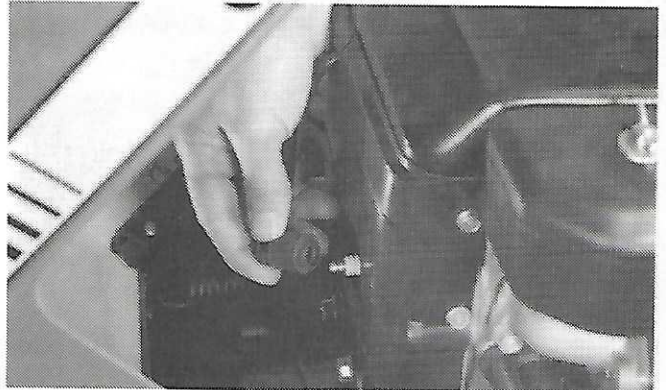

A98;;M35436 M21;;SEJ 109 180784

3. Remove four cap screws.
4. Remove shroud.
5. Clean fins with a brush or compressed air.
6. Install shroud and cap screws. Tighten cap screws.
7. Connect spark plug wire.

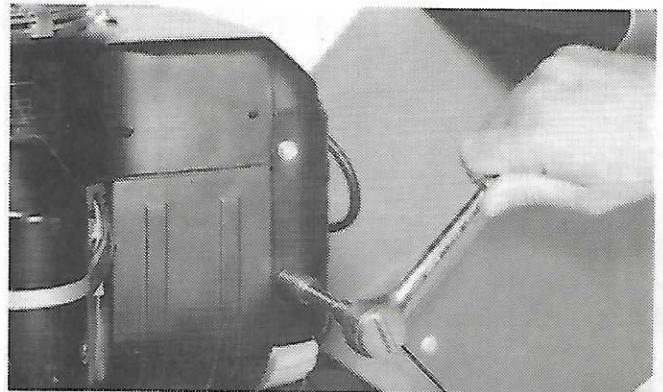

A98;;M35438 M21;;SEJ 110 180784

Service/As Necessary

ADJUSTING SEAT

1. Loosen four nuts.
2. Slide seat forward or rearward to your comfort.
3. Tighten nuts.

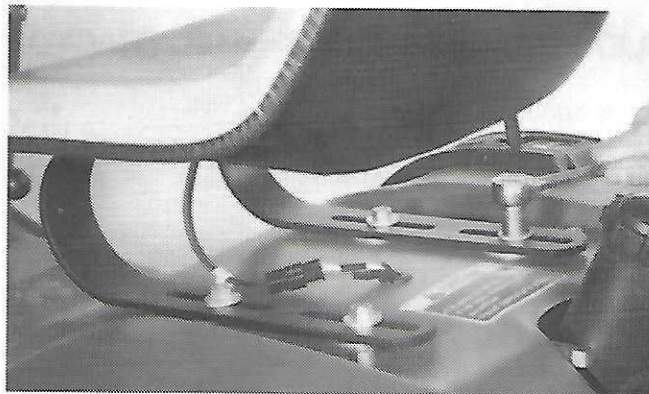

A98;M32916 M21;;SEJ 45 270483

REPLACING FUEL FILTER—112L TRACTOR

 **CAUTION:** Keep cigarettes, sparks, and flames away from fuel system. Make sure engine is cool to touch.

1. Park tractor on level surface. Lift hood.

 **CAUTION:** Wait until fuel is low before you replace fuel filter—OR be prepared to drain fuel into a safe container when you disconnect hose.

2. Slide hose clamp away from fuel pump.
3. Disconnect hose from fuel pump. If necessary, drain fuel into a safe container.



A98; M35439 M21;;SEJ 117 180784

4. Bring fuel line and filter out from behind engine.
5. Slide hose clamps away from filter.
6. Disconnect hoses from filter.
7. Connect hoses to new filter.
8. Install clamps. Connect fuel line to fuel pump. Install clamp.

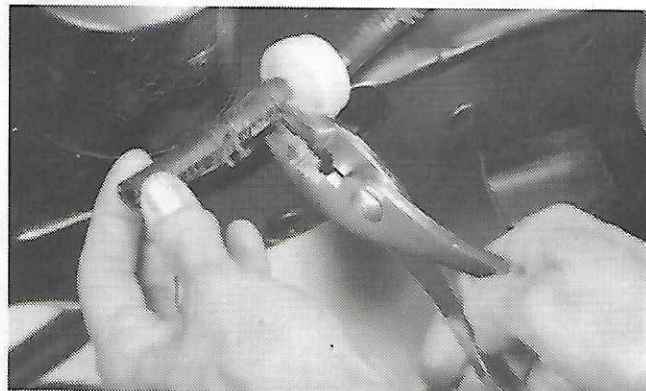

A98;M35440 M21;;SEJ 116 180784

REPLACING FUEL FILTER FOR 116 AND 116H TRACTORS

CAUTION: To prevent fire or explosion, replace fuel filter away from sparks or flame.

1. Stop engine, remove key, and lift hood.
2. Disconnect fuel lines from fuel filter (A) and drain fuel in a safe container.
3. Install new fuel filter and connect fuel lines.

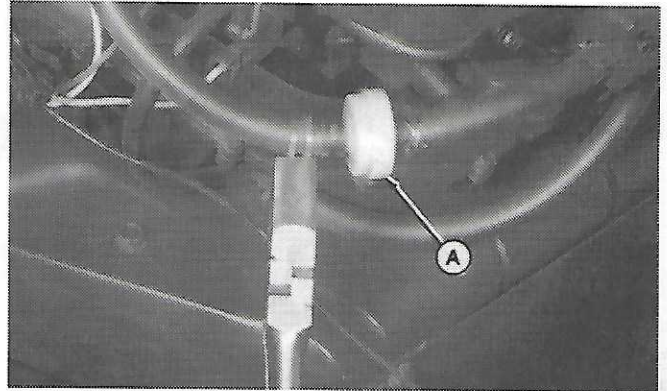

A98;M32938 M21;;SEJ 63A 160583

REPLACING MOWER DRIVE BELT

CAUTION: NEVER replace mower drive belt with engine running. Wait for all moving parts to stop.

1. Stop engine and remove key.
2. Lower mower to the ground.
3. For 30-in. mower, loosen wing nut to end of eye bolt threads to release belt tension.

For 38-in. mower, move belt tension lever out to release belt tension.

For 46-in. mower, loosen adjusting nut to release belt tension.

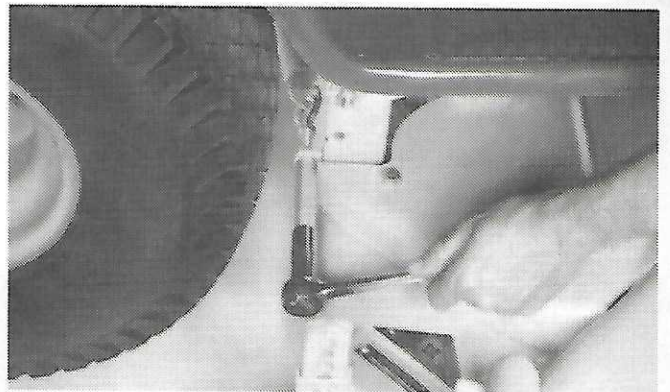
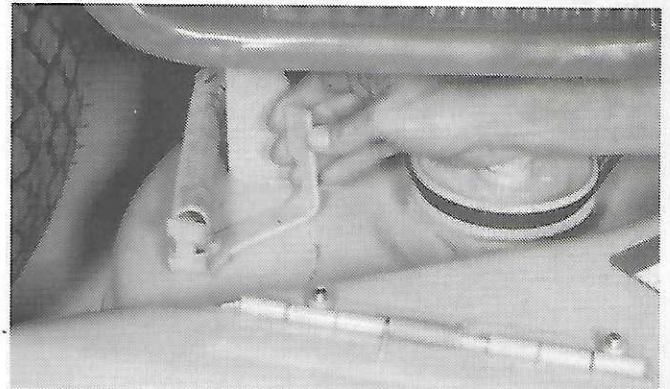
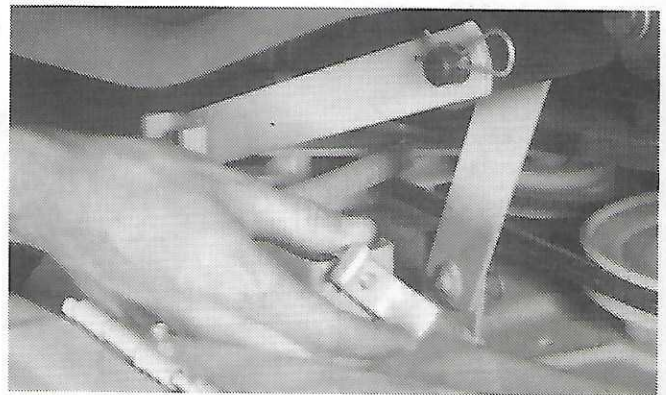

A98;M32939, M32940, M32941 M21;;SEJ 64 160583

Service/As Necessary

4. Remove drive belt from engine drive sheave and rear sheave.

5. Clean belt with a clean cloth. DO NOT use parts cleaning solvents or belt dressing; they soften belt and shorten belt life.

6. Inspect belt for wear or damage; replace as necessary.

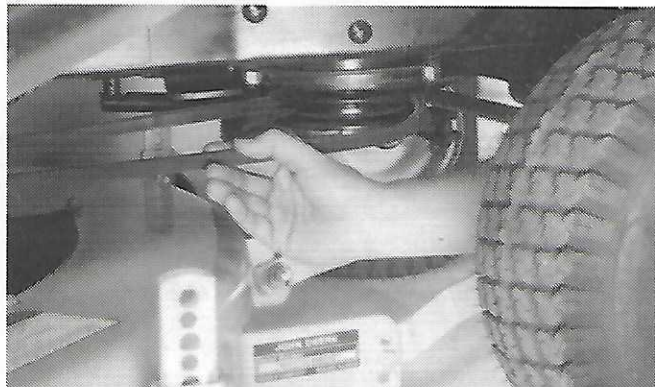

A98;M32942 M21;;SEJ 65 270483

7. Install drive belt on rear sheave and then on engine drive sheave.

8. For 30-in. mower, tighten wing nut completely. For 38-in. mower, move belt tension lever in as far as it will go. For 46-in. mower, tighten adjusting nut completely.

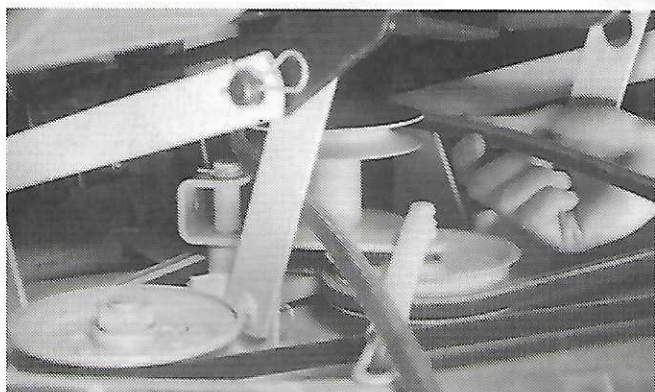

A98;M32943 M21;;SEJ 66 270483

REPLACING TRANSMISSION DRIVE BELT

If the transmission drive belt is broken, worn or frayed, see your John Deere dealer for replacement.

A98; M21;;SEJ 67 270483

REMOVING AND INSTALLING 30 OR 38-INCH MOWER DECK

CAUTION: NEVER remove or install mower deck with engine running. Wait for all moving parts to stop.

1. Stop engine and remove key.
2. Lower mower to the ground.
3. Remove mower drive belt. (See Replacing Mower Drive Belt in this section.)
4. Remove spring locking pin (A) and pull lift straps (B) (both sides) from their mounting. Move lift straps out of way of mower deck.

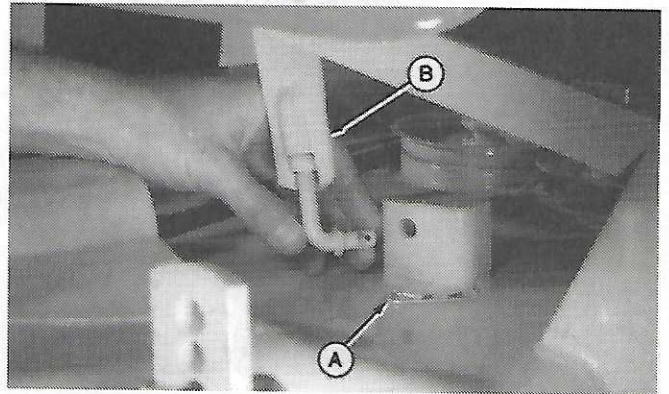

A98;M32848 M21;;SEJ 68 190983

5. Remove spring locking pins and pull rear draft arms (A) (both sides) from their mounting.

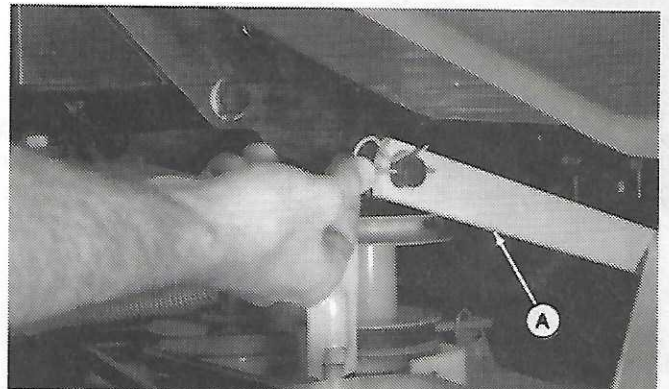

A98;M32944 M21;;SEJ 69 270483

6. Remove both spring locking pins and remove draft rod (A).

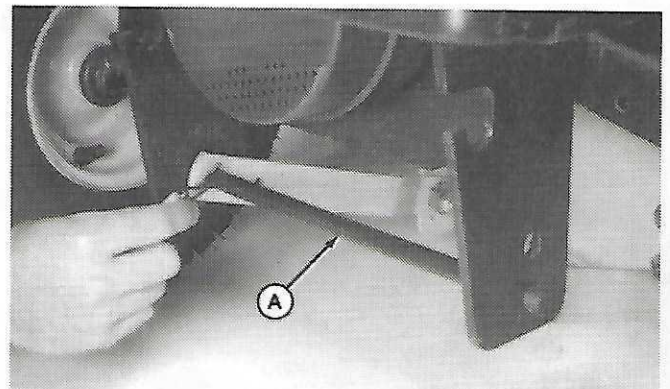

A98;M32945 M21;;SEJ 70 270483

7. Turn front wheels to extreme left.
8. Slide mower deck out from right-side of tractor.
9. Push mower deck under tractor. Align front draft arms with bottom hole and install draft rod and spring locking pins. Connect rear draft arms and fasten with spring locking pins. Connect lift straps and fasten with spring locking pins. Install mower drive belt.

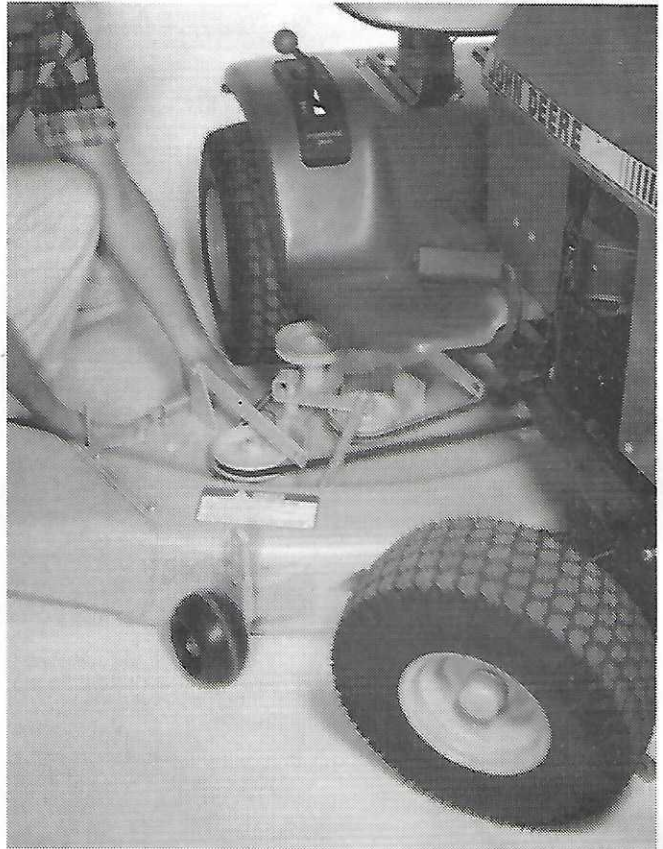

38-in. Mower Shown

A98;M32946 M21;;SEJ 71 270483

REMOVING AND INSTALLING 46-INCH MOWER DECK



CAUTION: NEVER remove or install mower deck with engine running. Wait for all moving parts to stop.

1. Stop engine and remove key.
2. Lower mower to the ground.
3. Remove mower drive belt. (See Replacing Mower Drive Belt in this section.)
4. Remove spring locking pins (A) and remove draft rod (B).

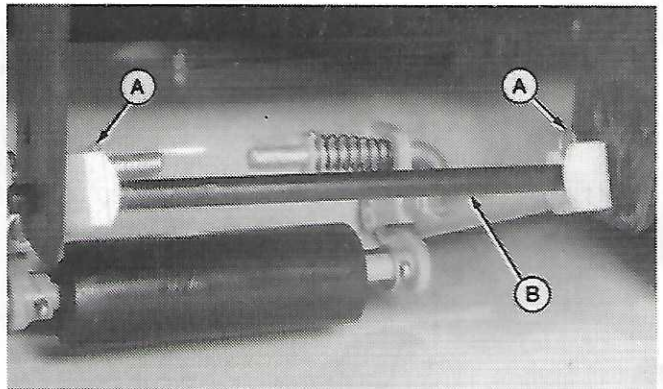

A98;M32947 M21;;SEJ 82 120583

M65;P73 040884

5. Pull mower draft pins to remove front draft arm assemblies.

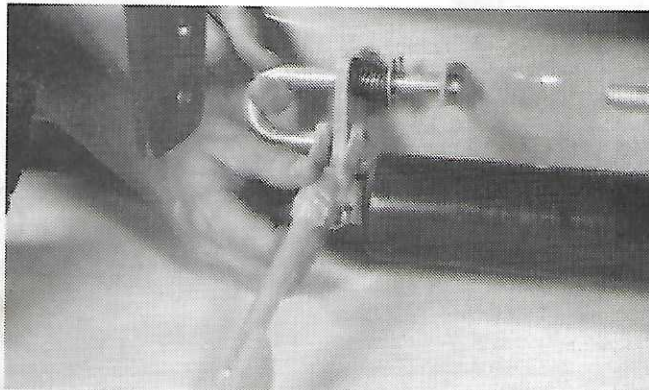

A98;M32948 M21;;SEJ 83 270483

6. Remove spring locking pins from both lift arms. DO NOT remove lift arms from brackets at this time.

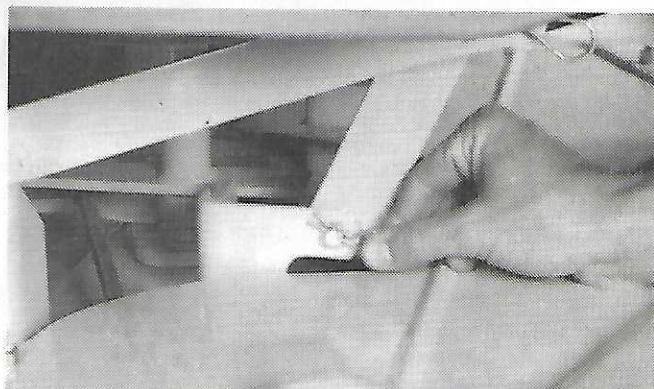

A98;M32949 M21;;SEJ 84 270483

! **CAUTION:** The lift lever is spring loaded and will automatically retract when lift arms are removed from brackets.

7. Hold lift lever in the down position and pull both lift arms from brackets. While holding lift lever, SLOWLY let the lever retract.



A98;M32849 M21;;SEJ 85 270483

8. Remove spring locking pins and pull rear draft arms (A) from their mounting.

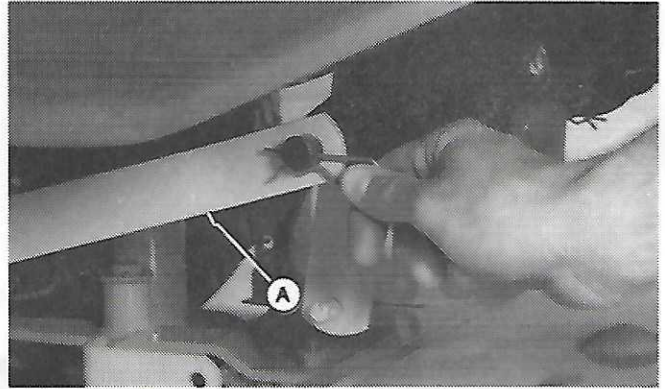

A98;M32950 M21;;SEJ 86 270483

9. Turn front wheels to the extreme left.
10. Slide mower deck out from right-side of tractor.
11. Push mower deck under tractor. Connect rear draft arms and fasten with spring locking pins. Hold lift lever in the down position, connect lift arms and fasten spring locking pins. Install front draft arm assemblies on mower. Align front draft arm assemblies with bottom hole and install draft rod and spring locking pins. Install mower drive belt.

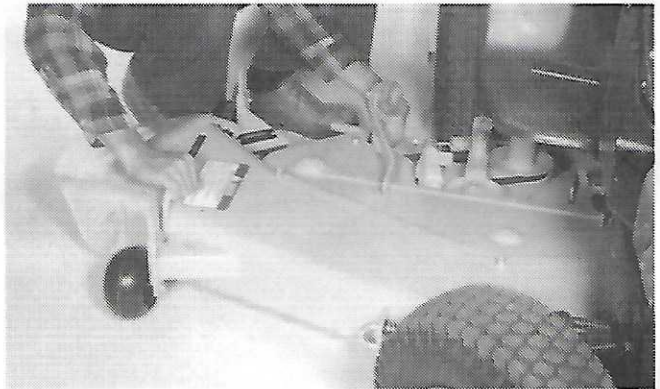

A98;M32951 M21;;SEJ 87 270483

REPLACING MOWER DECK BELT FOR 30-INCH MOWER

1. Remove mower deck. (See Removing and Installing 30 or 38-in. Mower Deck in this section.)
2. Loosen wing nut until end of eye bolt is even with wing nut.
3. Disconnect idler spring.

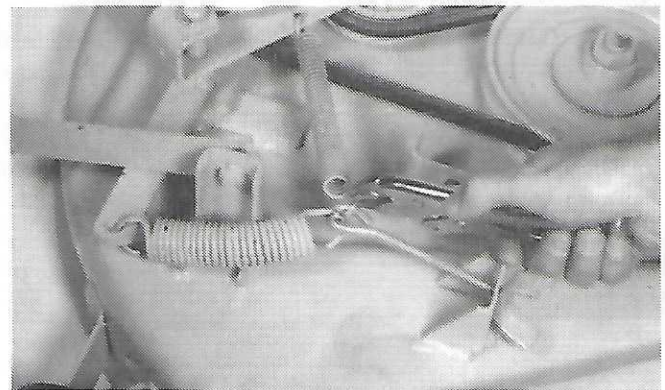

A98;M32952 M21;;SEJ 72 270483

4. Remove mower belt from sheaves.

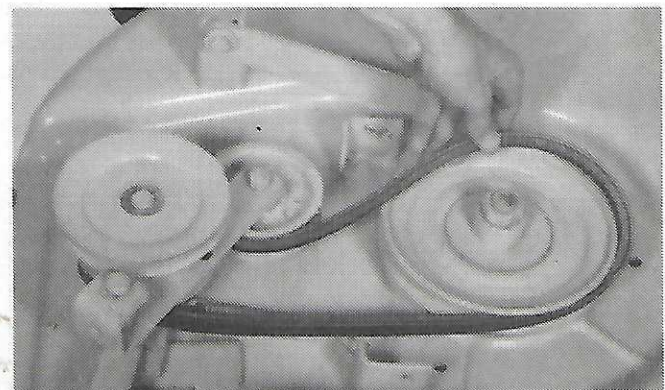

A98;M32953 M21;;SEJ 73 270483

5. Remove cotter pin.

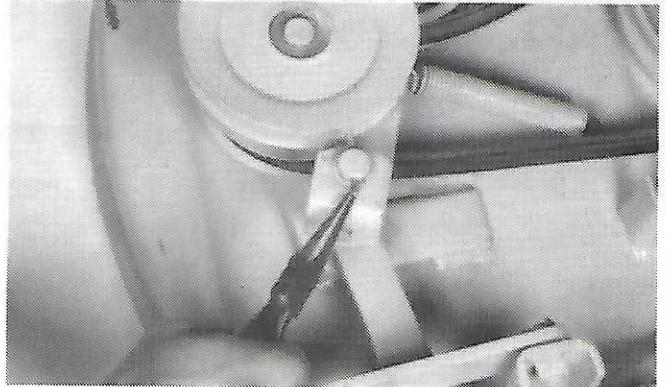

A98;M32954 M21;;SEJ 74 270483

6. Remove idler arm to remove mower belt.
7. Clean and inspect belt for damage DO NOT clean belt using parts cleaning solvent or belt dressing; they soften belt and shorten belt life.
8. Clean upper mower deck and sheaves.
9. Install mower belt, idler arm, cotter pin, connect idler spring, and install mower.

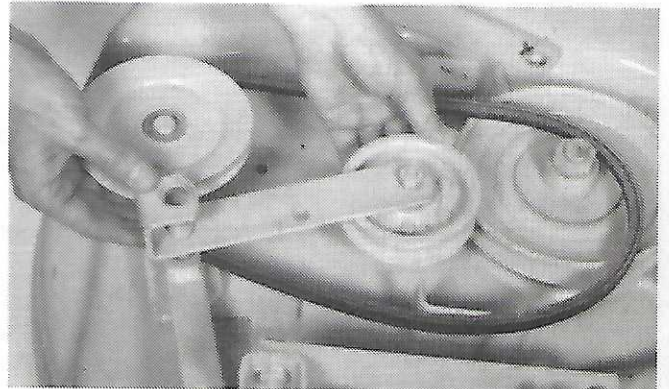

A98;M32955 M21;;SEJ 75 120583

REPLACING MOWER DECK BELT FOR 38-INCH MOWER

1. Remove mower deck. (See Removing and Installing 30 or 38-in. Mower Deck in this section.)
2. Remove belt guard cover.

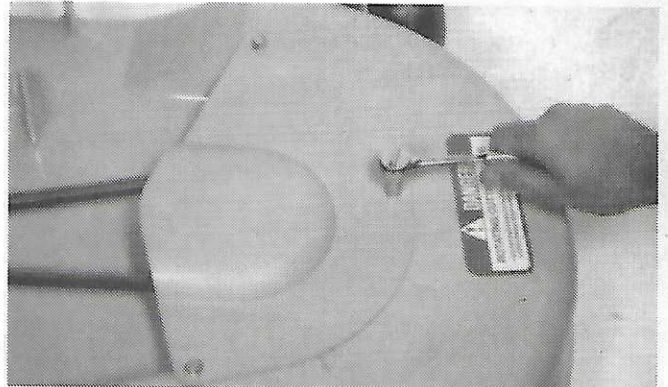

A98;M32956 M21;;SEJ 76 270483

3. Disconnect idler spring.



A98;M32957 M21;;SEJ 77 270483

4. Remove mower belt.

5. Clean and inspect belt for damage. DO NOT clean belt using parts cleaning solvent or belt dressing; they soften belt and shorten belt life.

6. Clean upper mower deck and sheaves.

7. Install mower belt, connect idler spring, install belt guard cover, and install mower.

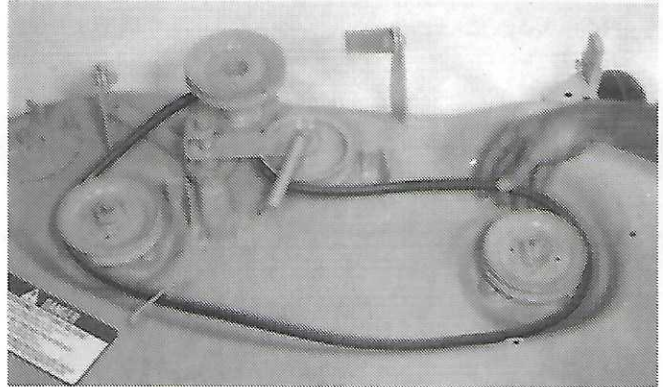

A98;M32958 M21;;SEJ 78 270483

REPLACING MOWER DECK BELT FOR 46-INCH MOWER

1. Remove mower deck. (See Removing and Installing 46-in. Mower Deck in this section.)

2. Remove three nuts, two cap screws, and washers to remove belt guard cover.

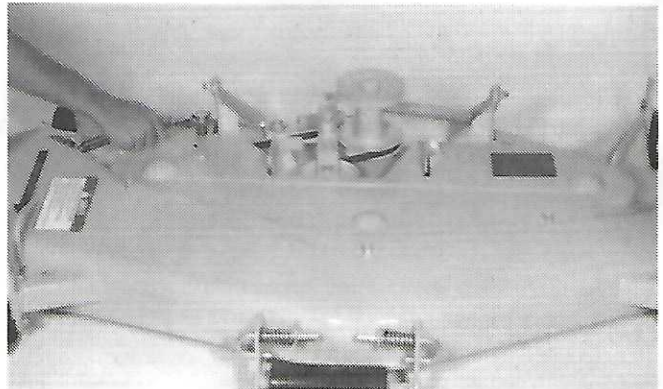

A98;M32959 M21;;SEJ 79 270483

3. Disconnect idler spring.

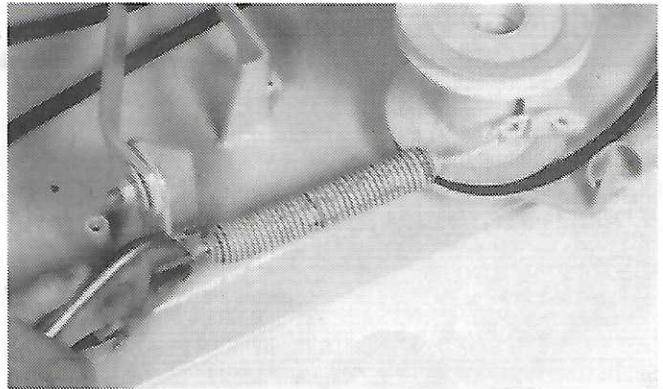

A98;M32960 M21;;SEJ 80 270483

4. Remove mower belt.

5. Clean and inspect belt for damage. DO NOT clean belt using parts cleaning solvent or belt dressing; they soften belt and shorten belt life.

6. Clean upper mower deck and sheaves.

7. Install mower belt, connect idler spring, install belt guard cover, and install mower.

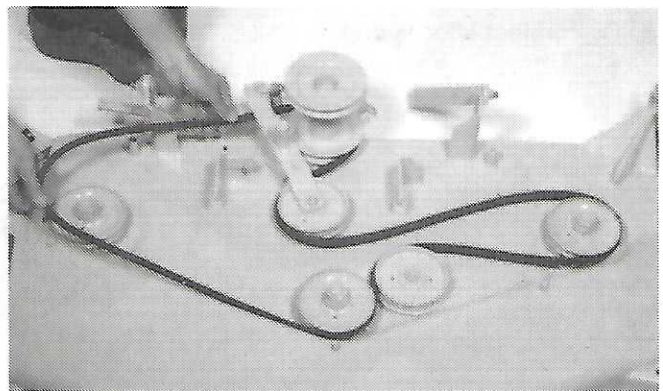

A98;M32961 M21;;SEJ 81 120583

CHECKING MOWER BLADES

To check for a bent blade:

1. Lower mower. Measure distance between blade tip and flat ground surface.
2. Turn blade 180 degrees. Measure distance between other blade tip and flat ground surface.
3. If the difference between the two distances is more than 1/16 in. (1.6 mm), install a new blade.

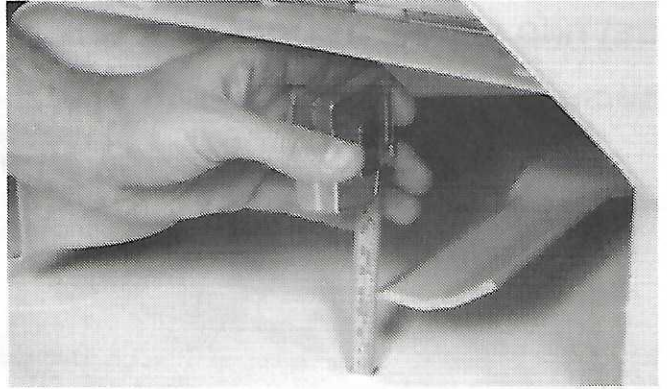

A98;M32847 M21;SEJ 111 180784

REMOVING AND INSTALLING MOWER BLADES

1. Raise mower to full height.
2. Put a block under each side of mower.



CAUTION: Mower blades may be sharp. When you handle blades, wear gloves or wrap a rag around blade.

3. Remove bolt, washer, and blade.
4. If a blade is dull, have it sharpened and balanced.
5. If blade is damaged, install a new blade.
6. Install blade. Fasten it with washer and bolt.
7. Tighten bolt to 55 lb-ft (75 N-m).

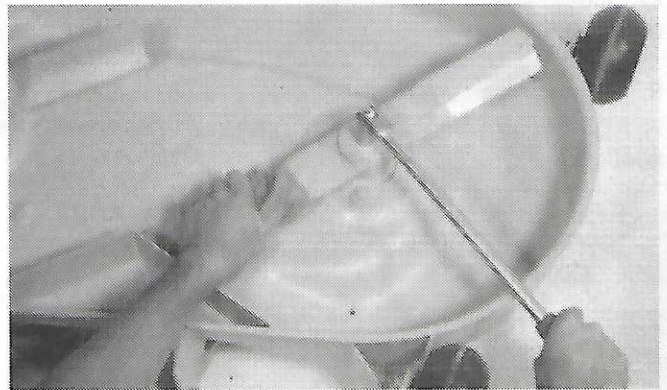

A98;M32962 M21;SEJ 112 170884

Storage

GETTING ENGINE READY FOR STORAGE

IMPORTANT: Gasoline storage stabilizer should always be used when storing lawn tractor to prevent carburetor varnishing and partial plugging of carburetor jets. Either of these conditions can cause the engine to run lean and result in piston seizure and engine failure.

1. Put TY6295 John Deere Gasoline Storage Stabilizer or an equivalent in fuel tank. Follow directions on can.
2. Run engine for at least 10 minutes to make sure stabilizer reaches the carburetor.
3. Drain crankcase oil when engine is warm. Fill crankcase with proper oil. (See Changing Engine Oil in Service/25-Hour section.)

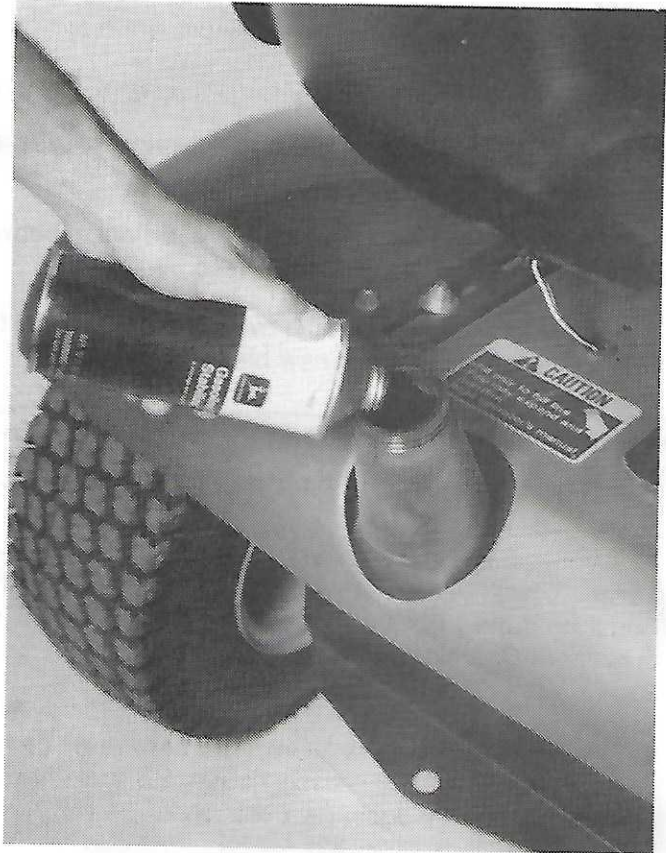

A98;M32965 M21;;SRJ 01 160583

4. Remove spark plugs. Add 1 oz (30 mL) of clean engine oil to cylinders. Turn engine crankshaft five or six times to distribute oil. Install spark plugs.
5. Remove all oil, grease, and dirt from engine and engine area.
6. Apply paint to unpainted areas to prevent rust.

108 Tractor Shown



A98;M32966 M21;;SRJ 02 120583

GETTING MOWER READY FOR STORAGE

1. Remove mower.
2. Thoroughly clean the top and underside of mower deck.
3. Check condition of mower drive belt and mower deck belt; replace if necessary.
4. Remove and either sharpen or replace mower blades.

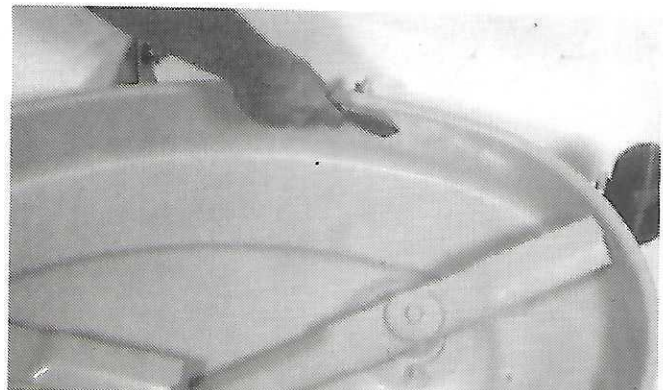

A98;M32969 M21;;SRJ 03 280483

Storage

5. Apply paint to unpainted areas to prevent rust.
6. Install mower on tractor if other attachments will not be used.
7. Release belt tension on mower drive belt.



A98;M32970 M21;;SRJ 04 280483

GETTING TRACTOR READY FOR STORAGE

1. Remove and clean battery. Store battery where it will not freeze. Check electrolyte level and charge fully. (See Checking Battery Electrolyte Level in Service/25-Hour section, and Charging Battery in Service/As Necessary section.)
2. Check all visible parts for wear, breakage or damage. Order parts and make necessary repairs to avoid needless delay when starting again next season.
3. Thoroughly clean tractor. Apply paint to unpainted areas to prevent rust.

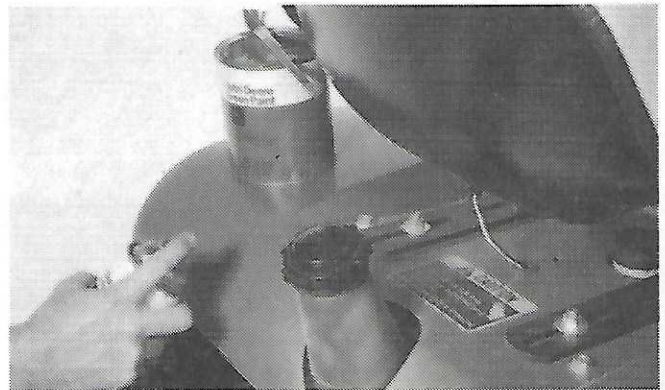

A98;M32967 M21;;SRJ 05 120583

Storage

4. If possible, store tractor in a cool, dark, and dry place.
5. Put blocking or support stands under tractor to take weight off the tires.
6. If tractor will be stored outdoors, a storage cover is available through your John Deere dealer.
7. If mower remains on tractor, lower the mower.



A98;M32968 M21;;SRJ 06 280483

REMOVING TRACTOR FROM STORAGE

1. Take lawn tractor off blocks.
2. Fill fuel tank.
3. Check electrolyte level.
4. Charge battery.
5. Install battery.
6. Remove spark plug.
7. Turn engine crankshaft 10 to 12 times to remove oil from cylinder.
8. Check spark plug gap. Install spark plug.
9. Check tire inflation.
10. Lubricate wheel spindles.
11. Start engine. Let it warm up before operating tractor.

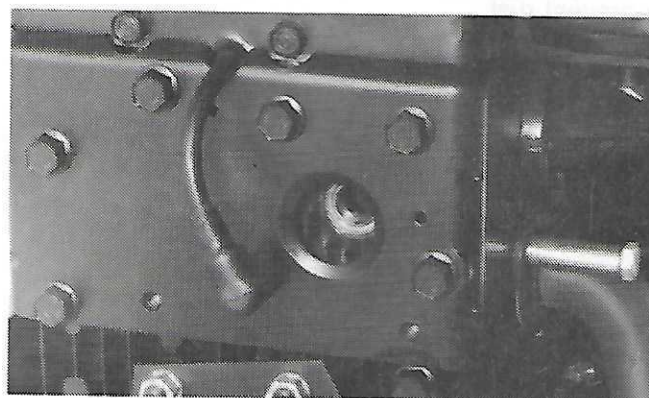

A98;M32980 M21;;SRJ 07 200983

Crime Prevention Tips

GOOD ADVICE

Keep your machine damage-free and YOURS!

Follow the advice on these pages to reduce vandalism, discourage theft, and help recover your machine if it is stolen.

TAKE A BITE OUT OF
CRIME
© 1979 The Advertising Council, Inc.



AB6;TS140 053;CRPRV A 181183

RECORD IDENTIFICATION NUMBERS

1. Record Product Identification Number (PIN) of unit and identification numbers of engine, component, attachment, etc. EXACTLY as they appear on the plates.
2. Check that the complete and correct numbers appear on all documentation (insurance, financial, warranty, manufacturer's certificate of origin, etc.). Keep all documents in a safe location.
3. If available, participate in an "Owner Applied Numbering Program" and mark your own machines.



AB6;TS161 053;CRPRV B 091283

MAINTAIN DOCUMENTED PROOF OF OWNERSHIP

1. Keep in a safe location all documents (invoices, warranty cards, manufacturer's certificate of origin, if available, etc.) that accompanied your machines at the time of purchase.
2. Take color photographs of each machine from several angles.
3. Maintain an up-to-date inventory of all machines. Check regularly to insure no machines have been stolen.

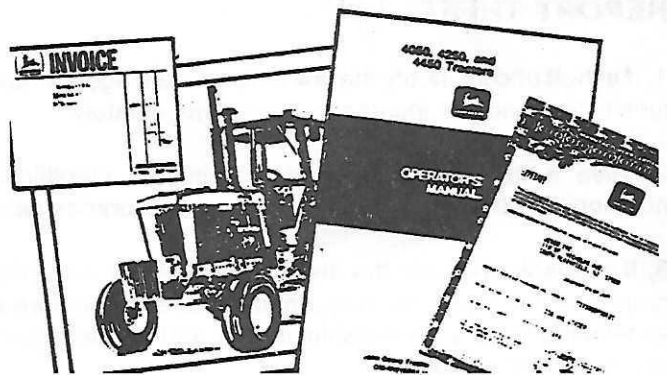

AB6;TS142 053;CRPRV C 181183

PARK INDOORS OUT OF SIGHT

1. Lower all equipment making the machine harder to move.
2. Remove ignition key. If so equipped, lock cab doors, windows and any vandal protection devices. Place hard-to-move equipment in front of exits.
3. If machine is being stored, remove the battery or any essential component in the electrical system.
4. Set wheels in widest position making loading more difficult. Secure all openings to storage buildings.

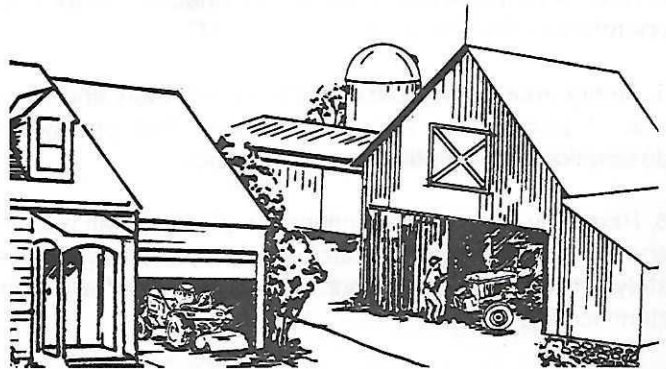

AB6;TS143 053;CRPRV D 100184

PARKING OUTDOORS

1. Park machine in a fenced, well-lighted, locked area. Lower equipment, remove ignition key and lock cab doors, windows, and any vandal protection devices, if so equipped.
2. Make law enforcement aware of your presence in an area and provide them with a contact person to assist them in dealing with suspicious activity.
3. Solicit assistance from neighbors or merchants who permanently reside near the parking area.

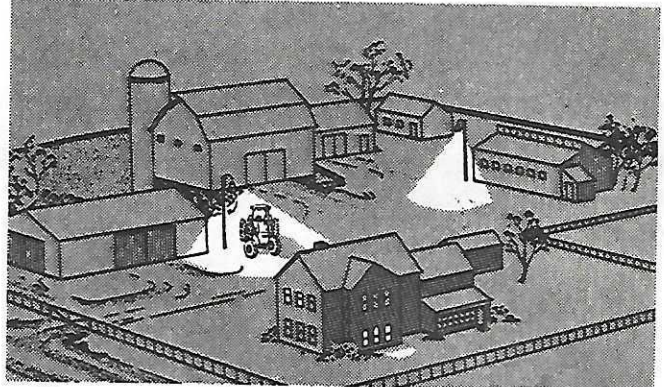

AB6;TS155 053;CRPRV E 091283

REDUCE VANDALISM

1. Install vandal protection devices especially if parking machine in high-risk areas.
2. Solicit assistance for watching machine from individuals residing in the area.
3. Take written notes and report to law enforcement all suspicious vehicles or persons.
4. Participate in a "Neighborhood Watch Program."

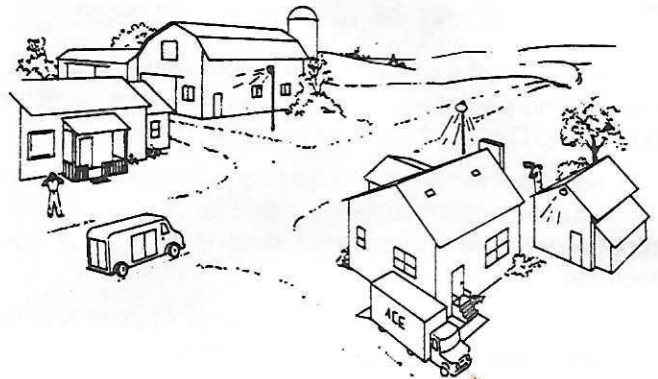

AB6;TS145 053;CRPRV F 100184

REPORT THEFT

1. If a theft occurs, notify the law enforcement agency having jurisdiction and the insurance carrier immediately.
2. Give a full description and a complete identification number(s) to the investigating officer and insurance carrier.
3. If available, provide the investigating officer with photographs of the actual machine, manufacturer's literature and knowledge of any identifiable marks that would assist in identifying the machine.
4. Ask for verification that the stolen machine has been entered into the National Crime Information Center (NCIC) operated by the FBI in Washington D.C.
5. Notify your John Deere dealer of the theft and request that, if possible, a notice be posted that provides the description and identification information.
6. Regularly check the identification plates on all machines and report any removed plates to law enforcement immediately. Promptly contact your dealer and order a duplicate identification plate.



AB6;TS146 053;CRPRV G 181183

Assembly

ADD ELECTROLYTE TO BATTERY



CAUTION: Battery electrolyte is poisonous and can injure eyes, skin, and clothing. Handle it carefully.

IMPORTANT: Battery must be removed from tractor before filling with electrolyte to prevent damage to tractor from spilled electrolyte.

1. Loosen wing nuts to remove hold-downs, battery hold-down cover, and battery.



A98;M32898 M21;;ASJ 03 280483

2. Use only battery grade sulfuric acid electrolyte with 1.265 specific gravity plus or minus 0.005 corrected to 80°F (27°C). Electrolyte temperature should be above 60°F (16°C)—preferably 80°F (27°C).

IMPORTANT: DO NOT fill to bottom ledge of filler tube.

3. Remove caps. Slowly add electrolyte (A) until plates (B) are just covered.

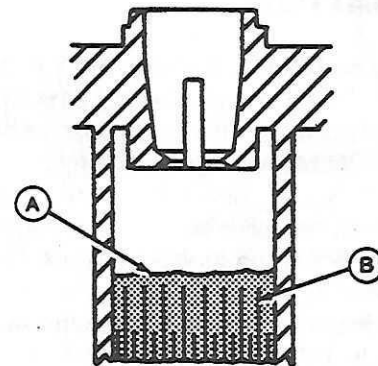

A98;M32971 M21;;ASJ 04 280483

CHARGE BATTERY

CAUTION: Gases in the battery are explosive. Keep open sparks and flames away from battery. Provide adequate ventilation.

1. Charge battery at 15 amps for 10 minutes or at 7 amps for 30 minutes. DO NOT over-charge.
2. If electrolyte bubbles excessively, reduce charging rate. At full charge, electrolyte must have a specific gravity reading of 1.265.
3. After charging, add electrolyte (A) until level is 1/4 to 1/2 in. (6.4 to 12.7 mm) above plates (B). DO NOT fill to bottom ledge of filler tube.
4. Install caps.

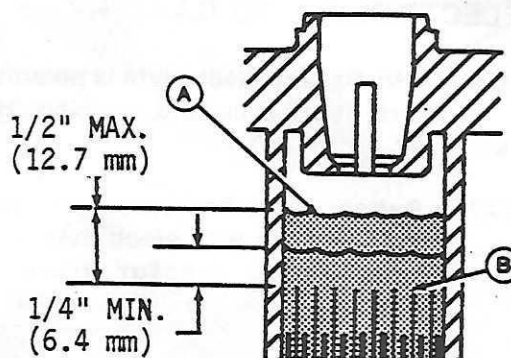

A98;M32892 M21;;ASJ 05 280483

INSTALL BATTERY

1. Put battery on base.
2. Connect red positive cable to the positive battery terminal with 1/4 x 5/8-in. bolt and nut.
3. Connect black negative cable to the negative (-) battery terminal with a 1/4 x 1/2-in. bolt and nut.
4. Apply petroleum jelly on battery terminals.
5. Put battery hold-down cover on battery.
6. Install hold-downs in slots of side frame and battery hold-down cover.
7. Install flat washers, lock washers, and wing nuts on hold-downs. Tighten wing nuts.



A98;M32899 M21;;ASJ 06 280483

INSTALL STEERING WHEEL

1. Put front wheels in straight forward position.
2. Install steering wheel with John Deere logo in upright position.
3. Install shoulder bolt (A) with head of bolt tight against steering wheel hub.
4. Install and tighten locknut. DO NOT use locknut to pull shoulder bolt into position.

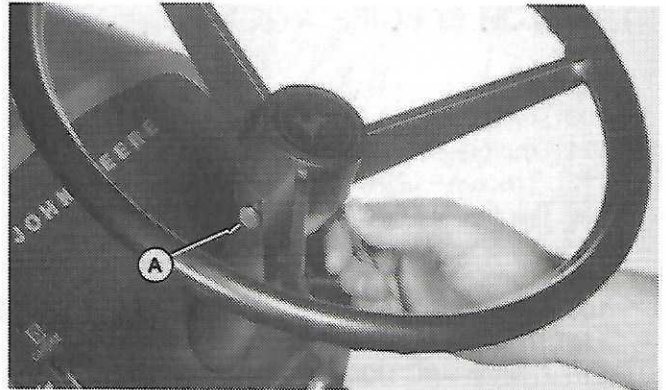

A98;M32972 M21;;ASJ 07 280483

INSTALL SEAT

1. Install seat and fasten with four 5/16 x 3/4-in. cap screws. Tighten cap screws.
2. Connect seat switch connector (A) to wiring harness connector.

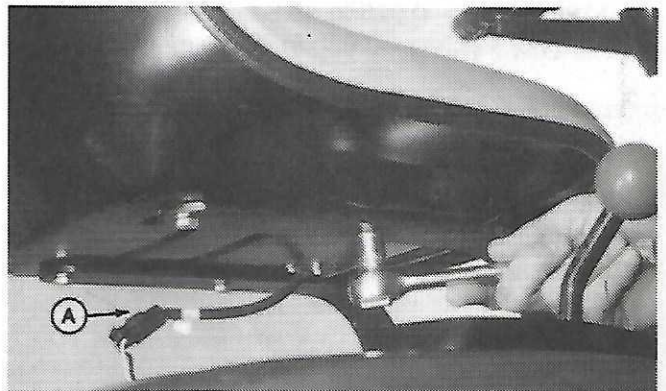

A98;M32973 M21;;ASJ 08 280483

Specifications

TRACTOR SPECIFICATIONS

Horsepower

- 108 Tractor—8 HP (6 kW)
- 111 Tractor—11 HP (8 kW)
- 112L Tractor—12 HP (9kW)
- 116 Tractor—16 HP (12 kW)

Spark Plug

- 108 and 111 Tractors—AC CS-45, Champion CJ-8, Autolite A79
- 112L Tractor—NGK BMR-4A
- 116 Tractor—AC R046, Champion RJ-12, Autolite 308

Spark Plug Gap

- 112L Tractor—0.025 in. (0.64 mm)
- All other tractors—0.030 in. (0.76 mm)

Capacities

Fuel Tank

- All tractors—2-1/2 gal (9.5 L)

Engine Oil

- 108 Tractor 2-1/4 pt (1 L)
- 111 and 112L Tractors (without filter) 3 pt (1.4 L)
- 112L Tractor with filter 3-1/2 pt (1.7 L)
- 116 Tractor 3 pt (1.4 L)

Transaxle

- 108, 111, and 116 Tractors—1-1/2 pt (0.76L)

Hydrostatic

- 112L and 116H Tractors—2-1/4 pt (1.1 L)

Travel Speeds at 3400 rpm for Tractors with Gear Transmission

Gear	108 and 111 Tractors	116 Tractor
First	1.4 mph (2.2 km/h)	1.5 mph (2.4 km/h)
Second	2.2 mph (3.5 km/h)	2.4 mph (3.8 km/h)
Third	3.3 mph (5.3 km/h)	3.5 mph (5.6 km/h)
Fourth	4.2 mph (6.7 km/h)	4.5 mph (7.2 km/h)
Fifth	4.9 mph (7.9 km/h)	5.3 mph (8.5 km/h)
Reverse	1.6 mph (2.5 km/h)	1.7 mph (2.8 km/h)

TRACTOR SPECIFICATIONS-Continued

Travel Speeds at 3400 rpm for 112L and 116H Tractors with Hydrostatic Transmission

Gear Selections—Infinite

Travel Speeds

Forward—0 to 5 mph (0 to 8 km/h)

Reverse—0 to 2-1/2 mph (0 to 4 km/h)

Approximate Weight

108 Tractor—405 lb (184 kg)

111 and 112L Tractors—470 lb (213 kg)

116 Tractor —522 lb (237 kg)

Tire Pressure

	108 Tractor	111 and 112L Tractors	116 Tractor
Front	13 x 5.00-6 12 psi (80 kPa)	15 x 6.00-6 10 psi (70 kPa)	15 x 6.00-6 10 psi (70 kPa)
Rear	18 x 6.50-8 10 psi (70 kPa)	18 x 8.50-8 8 psi (60 kPa)	18 x 8.50-8 or 20 x 10.00-8 8 psi (60 kPa)

Specifications and design subject to change without notice.

A98; M21;;SPJ 02 190784

MOWER SPECIFICATIONS

Item	30-Inch	38-Inch	46-Inch
Type	Rotary	Rotary	Rotary
Cutting Blades	One	Two	Three
Blade Length	30 in. (762 mm)	19.5 in. (496 mm)	16 in. (407 mm)
Cutting Width	30 in. (762 mm)	38 in. (965 mm)	46 in. (1170 mm)
Cutting Height	1.00 to 4.00 in. (25.4 to 102 mm)	1.00 to 4.00 in. (25.4 to 102 mm)	1.00 to 4.00 in. (25.4 to 102 mm)

Specifications and design subject to change without notice.

A98; M21;;SPJ 03 290483

RECORDING PRODUCT IDENTIFICATION NUMBER

Record the tractor's 13 digit product identification number in the space provided. Your John Deere dealer will need to know this number when ordering parts.

Product Identification Number M0112LX322084

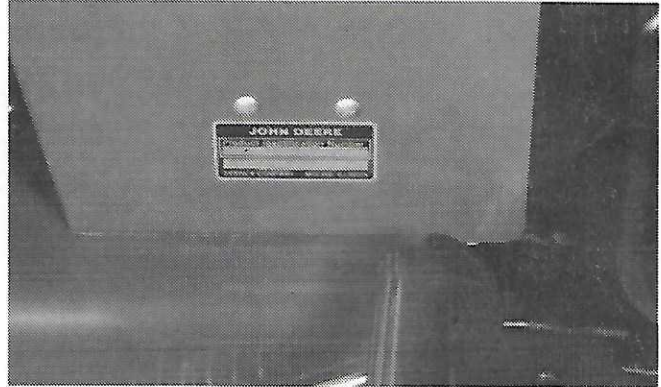

A98;M32974 M21;SPJ 04 190983

RECORDING ENGINE SERIAL NUMBER

Write your engine serial number below. Your dealer needs this number when you order parts.

Engine Serial Number FB460-009980

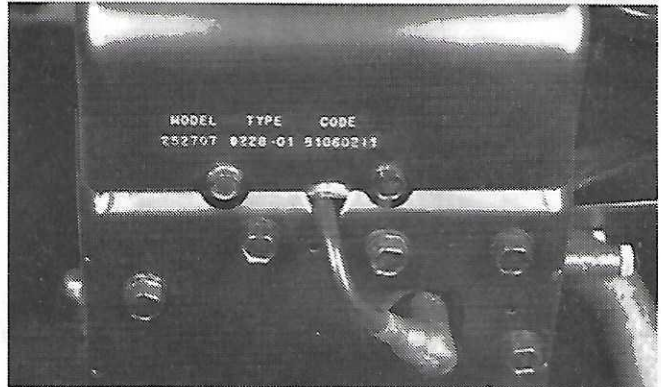

108 and 111 Tractors

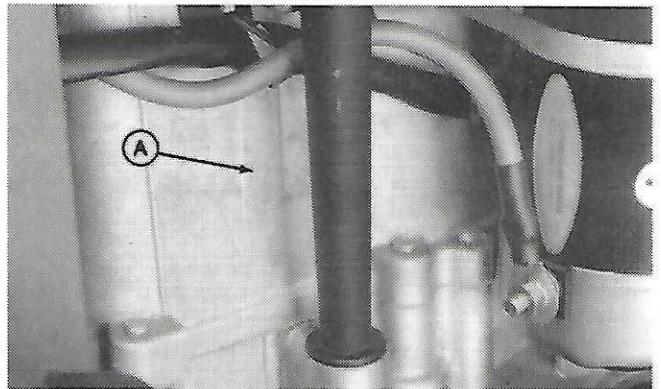

112L Tractor
(Serial number (A) is stamped on block.)



116 Tractor

Index

	Page		Page
A			
Additional service information	47	Engine (Continued)	
Air cleaner element, cleaning	57	Serial number	89
Air intake screens, cleaning	53	Speed for mowing	28
Alternative lubricants	41	Speeds for bagging	34
Assembly section	83	Starting	14
B			
Bagging		Stopping	18
After	36	Troubleshooting	42
Airflow	34	Warm-up	17
Before	33	F-G	
Checking for plugging	35	Front weights	36
Correct blades	33	Fuel	
Dismounting to empty or check bags	35	Filter change	69
Engine speeds	34	Pump screen, cleaning	65
Filling bags on slopes	35	Specifications	39
Mowing pattern	34	Fuels and lubricants section	39
Travel speeds	34	Grease	40
Using plastic bags	33	I-L	
Battery		Intake screens, clean	53
Cleaning	66	Left side controls	11
Electrolyte level	60	Lower dash controls	10
Before each use section	50	M	
Brake pedal	12	Mower	
Brakes, troubleshooting	45	Belt for 30-inch deck	75
C			
Cold weather operation	41	Belt for 36-inch deck	76
Controls section	10	Blades, check	78
Crime prevention tips section	82	Blades, remove and install	78
D			
Differential oil		Belt for 46-inch deck	77
Level	66	Cutting height	24
Specifications	41	Dismounting to inspect or unplug	29
Driving the tractor	20	Drive belt, change	70
E			
Electrical system, troubleshooting	45	Engaging	28
Engine		Installing or removing 30 or 38-inch mower	72
Break-in	14	Installing or removing 46-inch mower	73
Fins, cleaning	68	Level front-to-rear	27
Idling	17	Level side-to-side	25
Oil change for engines without		Stopping	29
oil filter	55	Troubleshooting	46
Oil change for 112L tractor with		Wheels	25
oil filter	63	Mowing	
Oil filter change for 112L Tractor	64	After	32
Oil level	50	Before	24
Oil specifications	40	For better lawn	30
		Large area without bagger	32
		Preventing uneven cut	32
		Small area without bagger	32
		Tall grass	31
		Tips	29
		Travel speeds	29
		Uneven areas	31

Continued on next page

A98; M21;DXJ 1 130784

Index

	Page		Page
O			
Operating the engine section	14	Upper dash controls	70
Operating the mower section	24	Weights	
Operating the tractor section	20	Front	36
P-R			
Periodic service section	47	Rear	36A
Precleaner, cleaning	58	Wheel spindles, lubricate	54
Prestarting checks section	13		
Products identification number	89		
Pushing			
Gear tractor	37		
Hydrostatic tractor	38		
Rear weights	36A		
S			
Safety section	2		
Seat, adjusting	69		
Serial numbers	89		
Service interval lists and charts	47		
Service records	47		
Spark plug check			
For 108, 111, and 116 Tractors	61		
For 112L Tractor	65		
Specifications section	87		
Steering, troubleshooting	45		
Stopping the tractor	23		
Storage section	79		
T			
Tire pressure	57		
Tow disconnect lever	12		
Tractor, troubleshooting	44		
Transmission			
Drive belt change	71		
Oil level	62		
Oil specifications	39		
Shift lever	11		
Transporting section	37		
Troubleshooting			
Brakes	45		
Electrical	45		
Engine	42		
Mower	46		
Steering	45		
Tractor	44		

JOHN DEERE SERVICE LITERATURE AVAILABLE...

To order these publications, fill out the form below and mail it with payment to the address given. Make checks payable to Deere & Co. Service Publications. Please allow three weeks for delivery. Prices include handling, taxes and postage to anywhere in the U.S.A. and Canada.

John Deere Distribution Service Center
Department S/P
 1400 3rd Ave.
 Moline, Ill. 61265

Please send to...

Name _____

Address _____

Town _____

State _____ Zip _____

CUT HERE

Title	Order No.	Qty.	Price Each
Parts Catalog			
116 and 116H Lawn Tractors	PC-1871		\$ 4.50
108, 111, and 111H Lawn Tractors	PC-1699		\$ 3.00
Operator's Manual			
108, 111, 112L, 116, and 116H Lawn Tractors	OM-M88424		\$ 2.60
Service or Technical Manual			
108, 111, 111H, and 116 Lawn Tractors	TM-1206		\$29.50

NOTE: If you want manuals or catalogs for equipment not shown on this list, list the model number, serial number and name of the equipment below.

FOS COMPACT EQUIPMENT MANUALS

FCP-80101B	Engines	\$10.50
FCP-83101B	Electrical Systems	9.50
FCP-82101B	Hydraulics	8.40
FCP-81101B	Power Trains	8.40

Illinois State Residents add 6% for ROT

Check or money order in U.S. dollars enclosed ... Total _____
 (Do not send cash or stamps)

Prices listed will be effective until 31 December 1984.

SP-317 Litho in U.S.A. APR-84

PARTS CATALOG

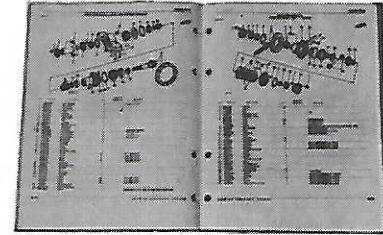

A parts catalog containing exploded view illustrations and lists of all parts is useful when purchasing service parts. Helps identify the correct parts. Useful in assembling and disassembling.

OPERATOR'S MANUAL



An extra copy of the operator's manual may be important if the copy furnished with your machine is misplaced.

SERVICE OR TECHNICAL MANUAL

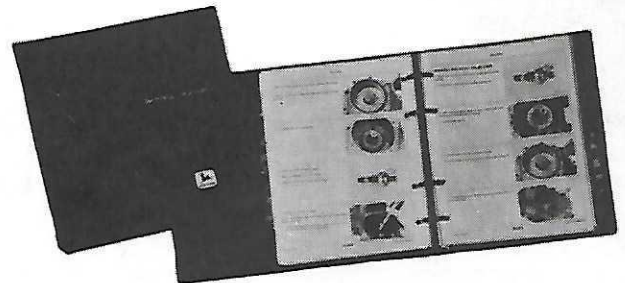

The service or technical manual is a service guide for your machine. Included in the manual are specifications, diagnosis and adjustments, illustrations of special assembly and disassembly procedures, and wiring diagrams.

FOS MANUALS ON COMPACT EQUIPMENT

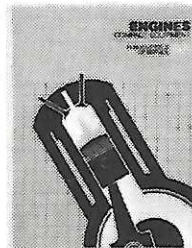

John Deere has made these new books available so you can read and learn the basics of how to service and repair most types of compact tractors and small engine-powered equipment. The fundamentals of how those systems work are shown clearly with hundreds of color illustrations. You can learn about operating principles of engines, electrical systems, power trains, or hydraulic systems. No brands or model numbers are mentioned; only generic principles are covered.

