

STX30, STX38, and STX46 Lawn Tractors



TECHNICAL MANUAL

**John Deere
Worldwide Commercial and
Consumer Equipment Division**

**TM1561 (15Mar97)
Replaces TM1561 (01Sep95) and
TM1418 (26Oct92)**

Litho in U.S.A



STX38 Gear Drive



STX38 Hydrostatic Drive



STX38 Motorsport Edition



STX46 Gear Drive



STX46 Hydrostatic Drive

This technical manual is written for an experienced technician and contains sections that are specifically for this product. It is a part of a total product support program.

The manual is organized so that all the information on a particular system is kept together. The order of grouping is as follows:

- Table of Contents
- Specifications
- Theory of Operation
- Troubleshooting Diagram
- Diagnostics
- Tests & Adjustments
- Repair

Note: Depending on the particular section or system being covered, not all of the above groups may be used.

Each section will be identified with a symbol rather than a number. The groups and pages within a section will be consecutively numbered.

All information, illustrations and specifications in this manual are based on the latest information available at the time of publication. The right is reserved to make changes at any time without notice.

We appreciate your input on this manual. To help, there are postage paid post cards included at the back. If you find any errors or want to comment on the layout of the manual please fill out one of the cards and mail it back to us.

Safety



Specifications and Information



Engine



Electrical



Power Train (Gear)



Power Train (Hydrostatic)



Steering



Miscellaneous



COPYRIGHT© 1997
JOHN DEERE HORICON WORKS
Horicon, Wisconsin
All rights reserved



RECOGNIZE SAFETY INFORMATION



This is the safety-alert symbol. When you see this symbol on your machine or in this manual, be alert to the potential for personal injury.

Follow recommended precautions and safe servicing practices.

Understand Signal Words

A signal word—DANGER, WARNING, or CAUTION—is used with the safety-alert symbol. DANGER identifies the most serious hazards.

DANGER or WARNING safety signs are located near specific hazards. General precautions are listed on CAUTION safety signs. CAUTION also calls attention to safety messages in this manual.

REPLACE SAFETY SIGNS

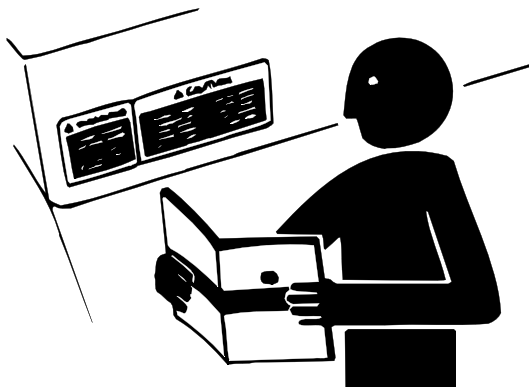

Replace missing or damaged safety signs. See the machine operator's manual for correct safety sign placement.

HANDLE FLUIDS SAFELY-AVOID FIRES

Be Prepared For Emergencies

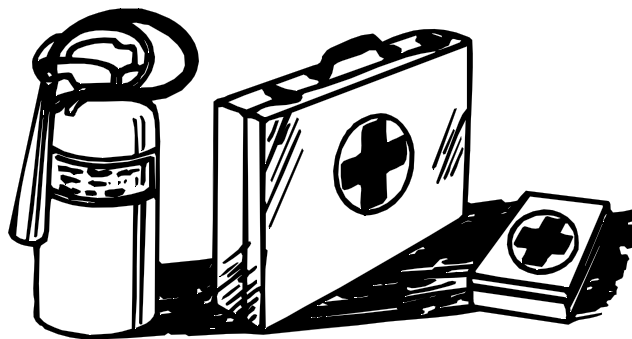

When you work around fuel, do not smoke or work near heaters or other fire hazards.

Store flammable fluids away from fire hazards. Do not incinerate or puncture pressurized containers.

Make sure machine is clean of trash, grease, and debris.

Do not store oily rags; they can ignite and burn spontaneously.

Be prepared if a fire starts.

Keep a first aid kit and fire extinguisher handy.

Keep emergency numbers for doctors, ambulance service, hospital, and fire department near your telephone.

USE CARE IN HANDLING AND SERVICING BATTERIES

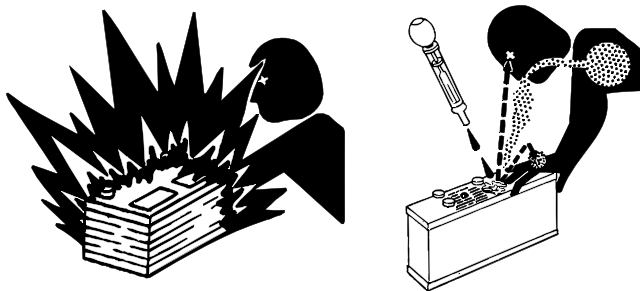

Prevent Battery Explosions

- Keep sparks, lighted matches, and open flame away from the top of battery. Battery gas can explode.
- Never check battery charge by placing a metal object across the posts. Use a volt-meter or hydrometer.
- Do not charge a frozen battery; it may explode. Warm battery to 16°C (60°F).

Prevent Acid Burns

- Sulfuric acid in battery electrolyte is poisonous. It is strong enough to burn skin, eat holes in clothing, and cause blindness if splashed into eyes.
- **Avoid acid burns by:**
 1. Filling batteries in a well-ventilated area.
 2. Wearing eye protection and rubber gloves.
 3. Avoiding breathing fumes when electrolyte is added.
 4. Avoiding spilling or dripping electrolyte.
 5. Use proper jump start procedure.
- **If you spill acid on yourself:**
 1. Flush your skin with water.
 2. Apply baking soda or lime to help neutralize the acid.
 3. Flush your eyes with water for 10_15 minutes.
 4. Get medical attention immediately.
- **If acid is swallowed:**
 1. Drink large amounts of water or milk.
 2. Then drink milk of magnesia, beaten eggs, or vegetable oil.
 3. Get medical attention immediately.

USE CARE AROUND HIGH-PRESSURE FLUID LINES

Avoid High-pressure Fluids

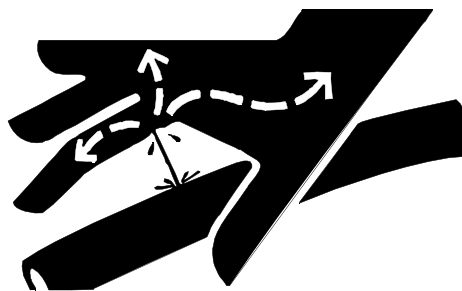

Escaping fluid under pressure can penetrate the skin causing serious injury.

Avoid injury from escaping fluid under pressure by stopping the engine and relieving pressure in the system before disconnecting or connecting hydraulic or other lines. Tighten all connections before applying pressure.

Search for leaks with a piece of cardboard. Protect hands and body from high pressure fluids.

If an accident occurs, see a doctor immediately. Any fluid injected into the skin must be surgically removed within a few hours or gangrene may result. Doctors unfamiliar with this type of injury should reference a knowledgeable medical source. Such information is available from Deere & Company Medical Department in Moline, Illinois, U.S.A.

Avoid Heating Near Pressurized Fluid Lines



Flammable spray can be generated by heating near pressurized fluid lines, resulting in severe burns to yourself and bystanders. Do not heat by welding, soldering, or using a torch near pressurized fluid lines or other flammable materials. Pressurized lines can be accidentally cut when heat goes beyond the immediate flame area.

USE SAFE SERVICE PROCEDURES



Wear Protective Clothing

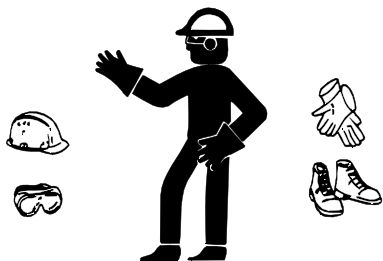

Wear close fitting clothing and safety equipment appropriate to the job.

Prolonged exposure to loud noise can cause impairment or loss of hearing. Wear a suitable hearing protective device such as earmuffs or earplugs to protect against objectionable or uncomfortable loud noises.

Operating equipment safely requires the full attention of the operator. Do not wear radio or music headphones while operating machine.

Service Machines Safely

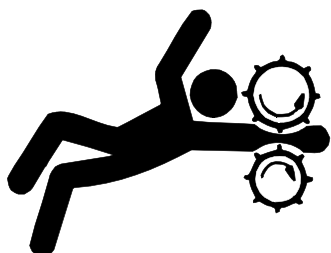

Tie long hair behind your head. Do not wear a necktie, scarf, loose clothing, or necklace when you work near machine tools or moving parts. If these items were to get caught, severe injury could result.

Remove rings and other jewelry to prevent electrical shorts and entanglement in moving parts.

Use Proper Tools

Use tools appropriate to the work. Makeshift tools and procedures can create safety hazards. Use power tools only to loosen threaded parts and fasteners. For loosening and tightening hardware, use the correct size tools. **DO NOT** use U.S. measurement tools on metric fasteners. Avoid bodily injury caused by slipping wrenches. Use only service parts meeting John Deere specifications.

Park Machine Safely

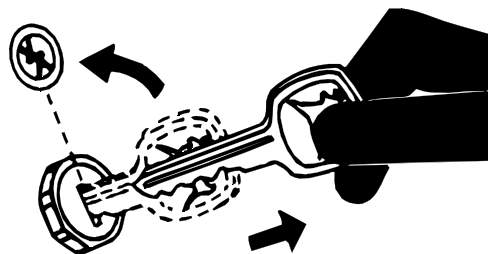

Before working on the machine:

1. Lower all equipment to the ground.
2. Stop the engine and remove the key.
3. Disconnect the battery ground strap.
4. Hang a "DO NOT OPERATE" tag in operator station.

Support Machine Properly And Use Proper Lifting Equipment

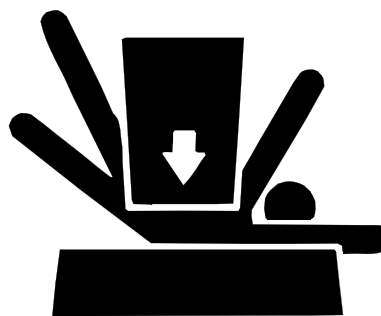

If you must work on a lifted machine or attachment, securely support the machine or attachment.

Do not support the machine on cinder blocks, hollow tiles, or props that may crumble under continuous load. Do not work under a machine that is supported solely by a jack. Follow recommended procedures in this manual.

Lifting heavy components incorrectly can cause severe injury or machine damage. Follow recommended procedure for removal and installation of components in the manual.

Work In Clean Area

Before starting a job:

1. Clean work area and machine.
2. Make sure you have all necessary tools to do your job.
3. Have the right parts on hand.
4. Read all instructions thoroughly; do not attempt shortcuts.

Using High Pressure Washers

Directing pressurized water at electronic/electrical components or connectors, bearings, hydraulic seals, fuel injection pumps or other sensitive parts and components may cause product malfunctions. Reduce pressure and spray at a 45 to 90 degree angle.

Illuminate Work Area Safely

Illuminate your work area adequately but safely. Use a portable safety light for working inside or under the machine. Make sure the bulb is enclosed by a wire cage. The hot filament of an accidentally broken bulb can ignite spilled fuel or oil.

Work In Ventilated Area

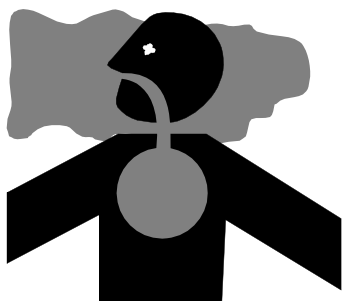

Engine exhaust fumes can cause sickness or death. If it is necessary to run an engine in an enclosed area, remove the exhaust fumes from the area with an exhaust pipe extension.

If you do not have an exhaust pipe extension, open the doors and get outside air into the area.

WARNING: California Proposition 65 Warning

Diesel engine exhaust and some of its constituents are known to the State of California to cause cancer, birth defects, and other reproductive harm.

Gasoline engine exhaust from this product contains chemicals known to the State of California to cause cancer, birth defects, or other reproductive harm.

Remove Paint Before Welding Or Heating

Avoid potentially toxic fumes and dust. Hazardous fumes can be generated when paint is heated by welding, soldering, or using a torch. Do all work outside or in a well ventilated area. Dispose of paint and solvent properly. Remove paint before welding or heating: If you sand or grind paint, avoid breathing the dust. Wear an approved respirator. If you use solvent or paint stripper, remove stripper with soap and water before welding. Remove solvent or paint stripper containers and other flammable material from area. Allow fumes to disperse at least 15 minutes before welding or heating.

Avoid Harmful Asbestos Dust

Avoid breathing dust that may be generated when handling components containing asbestos fibers. Inhaled asbestos fibers may cause lung cancer.

Components in products that may contain asbestos fibers are brake pads, brake band and lining assemblies, clutch plates, and some gaskets. The asbestos used in these components is usually found in a resin or sealed in some way. Normal handling is not hazardous as long as airborne dust containing asbestos is not generated.

Avoid creating dust. Never use compressed air for cleaning. Avoid brushing or grinding material containing asbestos. When servicing, wear an approved respirator. A special vacuum cleaner is recommended to clean asbestos. If not available, apply a mist of oil or water on the material containing asbestos. Keep bystanders away from the area.



SERVICE TIRES SAFELY

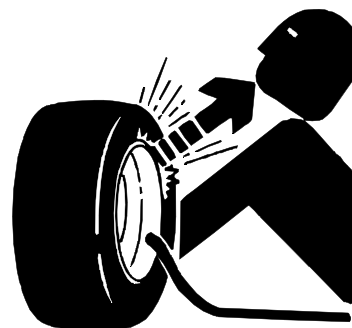

Explosive separation of a tire and rim parts can cause serious injury or death.

Do not attempt to mount a tire unless you have the proper equipment and experience to perform the job. Always maintain the correct tire pressure. Do not inflate the tires above the recommended pressure. Never weld or heat a wheel and tire assembly. The heat can cause an increase in air pressure resulting in a tire explosion. Welding can structurally weaken or deform the wheel.

When inflating tires, use a clip-on chuck and extension hose long enough to allow you to stand to one side and NOT in front of or over the tire assembly. Use a safety cage if available.

Check wheels for low pressure, cuts, bubbles, damaged rims or missing lug bolts and nuts.



AVOID INJURY FROM ROTATING BLADES, AUGERS AND PTO SHAFTS

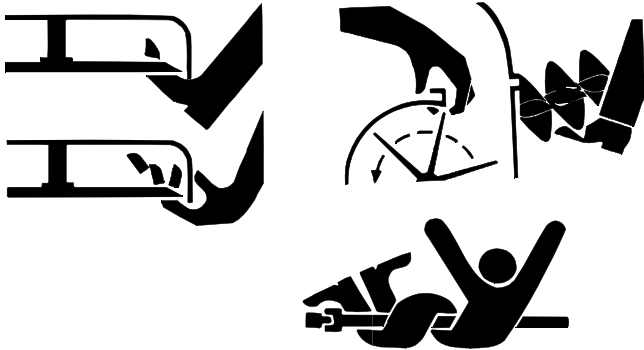

Keep hands and feet away while machine is running. Shut off power to service, lubricate or remove mower blades, augers or PTO shafts.

SERVICE COOLING SYSTEM SAFELY



Explosive release of fluids from pressurized cooling system can cause serious burns.

Shut off machine. Only remove filler cap when cool enough to touch with bare hands. Slowly loosen cap to first stop to relieve pressure before removing completely.

HANDLE CHEMICAL PRODUCTS SAFELY

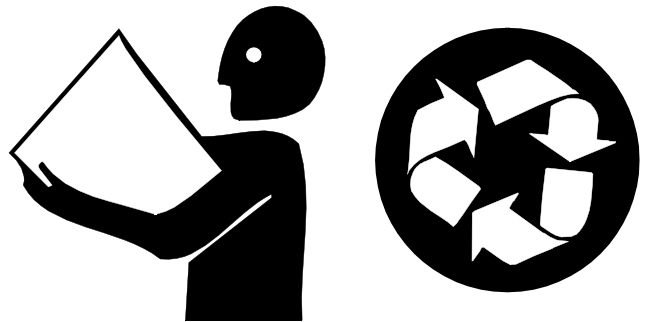

Direct exposure to hazardous chemicals can cause serious injury. Potentially hazardous chemicals used with John Deere equipment include such items as lubricants, coolants, paints, and adhesives.

A Material Safety Data Sheet (MSDS) provides specific details on chemical products: physical and health hazards, safety procedures, and emergency response techniques. Check the MSDS before you start any job using a hazardous chemical. That way you will know exactly what the risks are and how to do the job safely. Then follow procedures and recommended equipment.

Dispose of Waste Properly

Improperly disposing of waste can threaten the environment and ecology. Potentially harmful waste used with John Deere equipment include such items as oil, fuel, coolant, brake fluid, filters, and batteries. Use leakproof containers when draining fluids. Do not use food or beverage containers that may mislead someone into drinking from them. Do not pour waste onto the ground, down a drain, or into any water source. Inquire on the proper way to recycle or dispose of waste from your local environmental or recycling center, or from your John Deere dealer.

LIVE WITH SAFETY



Before returning machine to customer, make sure machine is functioning properly, especially the safety systems. Install all guards and shields.

CONTENTS

Page



SPECIFICATIONS & INFORMATION

GENERAL VEHICLE SPECIFICATIONS	3
METRIC FASTENER TORQUE VALUES	6
METRIC FASTENER TORQUE VALUE - GRADE 7	7
INCH FASTENER TORQUE VALUES	8
O-RING SEAL SERVICE RECOMMENDATIONS	9
FACE SEAL FITTINGS WITH INCH STUD ENDS TORQUE	9
FACE SEAL FITTINGS WITH METRIC STUD ENDS TORQUE	10
O-RING FACE SEAL FITTINGS	11
O-RING BOSS FITTINGS	11
GASOLINE SPECIFICATIONS	12
4-CYCLE ENGINES - NORTH AMERICA	12
GASOLINE STORAGE	12
4-CYCLE ENGINES - EUROPE	13
GASOLINE STORAGE	13
4-CYCLE GASOLINE ENGINE OIL	14
4-CYCLE GASOLINE ENGINE OIL - NORTH AMERICA	14
4-CYCLE GASOLINE ENGINE OIL - EUROPE	15
BREAK-IN 4-CYCLE GASOLINE ENGINE OIL - NORTH AMERICA	16
BREAK-IN 4-CYCLE GASOLINE ENGINE OIL - EUROPE	17
HYDROSTATIC TRANSMISSION OIL	18
HYDROSTATIC TRANSMISSION OIL - NORTH AMERICA	18
HYDROSTATIC TRANSMISSION OIL - EUROPE	19
ALTERNATIVE LUBRICANTS	20
SYNTHETIC LUBRICANTS	20
LUBRICANT STORAGE	20
MIXING OF LUBRICANTS	20
OIL FILTERS	20
GEAR TRANSMISSION GREASE	21
ANTI-CORROSION GREASE SPECIFICATIONS	22
GREASE SPECIFICATIONS	23
GREASE - NORTH AMERICA	23
GREASE - EUROPE	23
SERIAL NUMBER LOCATIONS	24
ENGINE SERIAL NUMBER SUFFIX	24
TRACTOR IDENTIFICATION NUMBER	24
ENGINE SERIAL NUMBER	24
GEAR TRANSAXLE SERIAL NUMBER	24
HYDROSTATIC TRANSMISSION SERIAL NUMBER	24

GENERAL VEHICLE SPECIFICATIONS

Engine:

Make	Kohler
Style	Command LT
STX30	CV12.5—1216s
STX38 (Serial No. —270000)	CV12.5—1215
STX38 (Serial No. 210001—270000)	CV12.5—1270
STX38 (Serial No. 270001—595000 & Motorsport)	CV13S—21509
STX46 (Serial No. 210001—270000)	CV14S—1463
STX46 (Serial No. 270001—595000)	CV15S—41521
Type	Gasoline, Air Cooled, Single Cylinder, 4-Cycle, Overhead Valves
Crankcase Oil Capacity (with filter)	1.8 L (1.9 U.S. qt)
Oil Type: (Warm Climate)	10W30
(Cold Climate)	5W30

Electrical:

Charging System	Flywheel/Electronic Magneto
Magneto Air Gap	0.2—0.3 mm (0.008—0.012 in.)
Charging Capacity	15 amp (regulated)
Spark Plug	Champion RC12YC
Spark Plug Air Gap	1.0 mm (0.040 in.)
Battery Type	BCI Group, U1
Battery Reserve Capacity	23 min. at 25 amp
Battery Cold Cranking Amp.	25 amp at 27° C (0° F) for 20 minutes
Battery Specific Gravity	Above 1.225 Points
Starter Type	Bendix Inertia Drive
PTO Clutch Type	Electric (Manufactured by Warner)
Fuel Shut-Off Solenoid (Optional)	Replaceable (Below Carburetor Float Bowl)
Headlight Kit (Optional)	Two Bulbs—Each 12 Volt/23W/1.9 Amp Draw

Fuel/Air System:

Carburetor Make	Walbro
Carburetor Type	Side Draft
Throttle/Choke	Unitized Control Linkage
Carburetor Fuel Shut-Off Solenoid (Optional)	Electric
Fuel Delivery	Gravity Flow
Fuel Filter	Replaceable Paper (in-line type)
Fuel Type	Unleaded (87 octane minimum)
Fuel Tank Capacity	4.7 L (1.25 gal)
Air Filter	Paper Element with Foam Pre-cleaner
Muffler Type	Anti-Backfire

Power Train:

Gear Transaxle—

Make	Dana
Model	Spicer Heavy-Duty 4360 Transaxle
Type	Five-Speed/Linear Shift
Domestic Ground Speeds (at FAST idle—3350 rpm) and Gear Ratios:	
1st Gear . (STX30 & STX38 SN —210000	2.2km/hr) 2.4 km/hr (1.5 mph)—61.67:1
2nd Gear	3.2 km/hr (2.0 mph)—46.67:1
3rd Gear . (STX30 & STX38 SN —210000	4.5km/hr) 5.0 km/hr (3.1 mph)—30.00:1
4th Gear . (STX30 & STX38 SN —210000	5.7km/hr) 6.4 km/hr (4.0 mph)—23.48:1
5th Gear . (STX30 & STX38 SN —210000	8.5km/hr) 8.0 km/hr (5.0 mph)—15.71:1
Reverse . (STX30 & STX38 SN —210000	3.3km/hr) 3.7 km/hr (2.3 mph)—40.00:1
Export Ground Speeds (at FAST idle—3000 rpm) and Gear Ratios:	
1st Gear	1.97 km/hr (1.22 mph)—61.67:1
2nd Gear	2.61 km/hr (1.67 mph)—46.67:1
3rd Gear	4.07 km/hr (2.53 mph)—30.00:1
4th Gear	5.18 km/hr (3.22 mph)—23.48:1
5th Gear	7.76 km/hr (4.82 mph)—15.71:1
Reverse	3.04 km/hr (1.89 mph)—40.00:1
Brake Type	Single, External Brake Disc With Dual Friction Pucks



Power Train: (Continued)

Lubrication—Input Shaft Needle Bearings Unirex® N3 Grease Only
 Lubrication—Transaxle Shell Darina® D Grease Only
 Capacity—Transaxle 0.64 kg (1.406 lbs)

Hydro Transaxle—

Make Kanzaki
 Model (STX38—early models) Tuff Torq® K50 Transaxle
 Model (STX38—late models) Tuff Torq® K55 Transaxle
 Model (STX46) Tuff Torq® K55 Transaxle
 Type Hydrostatic
 Domestic Ground Speeds (at FAST idle—3350 rpm):
 Forward 0—9.3 km/hr (0—5.8 mph)
 Reverse 0—4.7 km/hr (0—2.9 mph)
 Export Ground Speeds (at FAST idle—3000 rpm):
 Forward 0—7.75 km/hr (0—4.82 mph)
 Reverse 0—3.80 km/hr (0—2.36 mph)
 Brake Type Single, External Disc Brake With Friction Pucks
 Lubrication John Deere Plus-4 10W30 Engine Oil, Class CD
 Reservoir Internal
 Capacity 1.6 L (3.4 pt)

Traction Drive Belt:

Gear—

Actual effective length 2660±8 mm (104.7±0.3 in.)
 Theoretical effective length (short) 2631 mm (103.6 in.)
 Theoretical effective length (long) 2710 mm (106.7 in.)

Hydro—

Actual effective length 2485±8 mm (97.8±0.3 in.)
 Theoretical effective length (short) 2477 mm (97.5 in.)
 Theoretical effective length (long) 2530 mm (99.6 in.)

Mower Deck Drive Belt

38-Inch Deck—

Actual effective length 2425±10 mm (95.5±0.4 in.)

46-Inch Deck—

Actual effective length 3492±10 mm (137.5±0.4 in.)

Mower Deck:

38-Inch Mower Deck—

Type Rotary—Dual Spindles (Non-Serviceable)
 Material Type Stamped 2.5 mm (0.098 in.) Nominal Gauge Steel
 Cutting Blade Two—76 x 5 x 496 mm (3 x 0.2 x 19.5 in.)
 Blade Cutting Edge30±5° Angle
 Blade Wing Lift/Height 40±3 mm (1.57±0.12 in.)
 Overall Cutting Width 965 mm (38 in.)
 Overall Width (w/o discharge chute) 1026 mm (40.4 in.)
 Drive Type Single V-Belt (with spring-tensioned idler)
 Spindle Lubrication None—Sealed Bearings
 Lift Type Manual—Operator's Station
 Cutting Settings Seven: 31.8—89 mm (1.25—3.5 in.)

Mower Deck: (Continued)

46-Inch Mower Deck—

Type	Rotary—Triple Spindles (Non-Serviceable)
Material Type	Stamped 2.5 mm (0.098 in.) Nominal Gauge Steel
Cutting Blade	Three—50.8 x 5 x 407.4 mm (2 x 0.2 x 16 in.)
Blade Cutting Edge	30±5° Angle
Blade Wing Lift/Height	20.3±3 mm (0.8±0.12 in.)
Overall Cutting Width	1168.4 mm (46 in.)
Overall Width (w/o discharge chute)	1308 mm (51.5 in.)
Drive Type	Single V-Belt (with spring-tensioned idler)
Spindle Lubrication	None—Supplier Fill Only
Lift Type	Manual—Operator’s Station
Cutting Settings	Seven: 31.75 mm—89 mm (1.25—3.5 in.)

Chassis:

Wheelbase	1135 mm (44.69 in.)
Overall Length	1524 mm (60 in.)
Overall Width (w/o mower deck)	908 mm (35.75 in.)
Height	980 mm (38.6 in.)
Average Overall Weight STX38 (with mower deck/no fuel)	195.05 kg (430 lbs)
Average Overall Weight STX46 (with mower deck/no fuel)	204.12 kg (450 lbs)
Hitch Capacity—	
Export:	
Horizontal Pull Maximum	250 N (56 lbs)
Tongue Weight Maximum	65 N (15 lbs)
Domestic:	
Trailer Load Maximum	136 kg (300 lbs)
Trailer Tongue Weight Maximum	23 kg (50 lbs)

Steering:

Type	Manual—Pinion/Sector
Axle Pivot Hub	Shim Adjustable
Lubrication	DuBois MPG-2® Multipurpose Grease
Lubrication Interval	10 hrs (maximum)
Toe-In	6 mm (0.24 in.) — Non-Adjustable
Turning Radius	584 mm (23 in.)

Wheels:











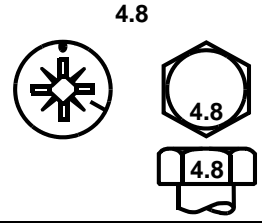

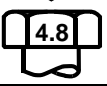
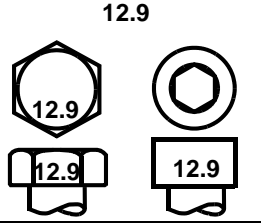
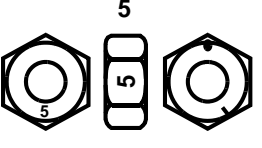
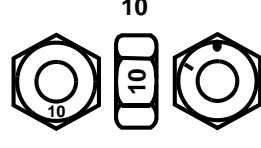
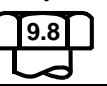
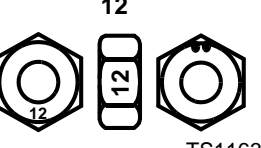
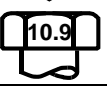

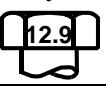



Size—	
Front	6.0 x 4.50
Rear	8.0 x 6.18

Tires:

Size—	
Front (STX30)	13 x 5—6 NHS (2 ply)
Rear (STX30)	18 x 6.50—8 NHS (2 ply)
Front (STX38 SN —210000)	13 x 6.50—6 NHS (2 ply)
Rear (STX38 SN —210000)	18 x 8.50—8 NHS (2 ply)
Front (STX38 SN 210001—270000)	13 x 6.50—6 NHS (2 ply)
Rear (STX38 SN 210001—270000)	18 x 9.50—8 NHS (2 ply)
Front (STX38 SN 270001—595000 & STX46)	15 x 6.50—6 NHS (2 ply)
Rear (STX38 SN 270001—595000 & STX46)	20 x 8.00—8 NHS (2 ply)
Pressure—	
Front (with mower deck)	83 kPa (12 psi)
Front (with snowthrower)	138 kPa (20 psi)
Rear (STX30 with mower deck)	97 kPa (14 psi)
Rear (with mower deck)	55 kPa (8 psi)



METRIC FASTENER TORQUE VALUES

 Property Class and Head Markings	4.8   	8.8 9.8    	10.9  	12.9    
	Property Class and Nut Markings 5   	10   	10   	12   

TS1163

SIZE	Class 4.8				Class 8.8 or 9.8				Class 10.9				Class 12.9			
	Lubricated ^a		Dry ^a		Lubricated ^a		Dry ^a		Lubricated ^a		Dry ^a		Lubricated ^a		Dry ^a	
	N•m	lb-ft	N•m	lb-ft	N•m	lb-ft	N•m	lb-ft	N•m	lb-ft	N•m	lb-ft	N•m	lb-ft	N•m	lb-ft
M6	4.8	3.5	6	4.5	9	6.5	11	8.5	13	9.5	17	12	15	11.5	19	14.5
M8	12	8.5	15	11	22	16	28	20	32	24	40	30	37	28	47	35
M10	23	17	29	21	43	32	55	40	63	47	80	60	75	55	95	70
M12	40	29	50	37	75	55	95	70	110	80	140	105	130	95	165	120
M14	63	47	80	60	120	88	150	110	175	130	225	165	205	150	260	109
M16	100	73	125	92	190	140	240	175	275	200	350	225	320	240	400	300
M18	135	100	175	125	260	195	330	250	375	275	475	350	440	325	560	410
M20	190	140	240	180	375	275	475	350	530	400	675	500	625	460	800	580
M22	260	190	330	250	510	375	650	475	725	540	925	675	850	625	1075	800
M24	330	250	425	310	650	475	825	600	925	675	1150	850	1075	800	1350	1000
M27	490	360	625	450	950	700	1200	875	1350	1000	1700	1250	1600	1150	2000	1500
M30	675	490	850	625	1300	950	1650	1200	1850	1350	2300	1700	2150	1600	2700	2000
M33	900	675	1150	850	1750	1300	2200	1650	2500	1850	3150	2350	2900	2150	3700	2750
M36	1150	850	1450	1075	2250	1650	2850	2100	3200	2350	4050	3000	3750	2750	4750	3500

DO NOT use these hand torque values if a different torque value or tightening procedure is given for a specific application. Torque values listed are for general use only and include a ±10% variance factor. Check tightness of fasteners periodically. DO NOT use air powered wrenches.

Shear bolts are designed to fail under predetermined loads. Always replace shear bolts with identical grade.

Fasteners should be replaced with the same class. Make sure fastener threads are clean and that you properly start thread engagement. This will prevent them from failing when tightening.

When bolt and nut combination fasteners are used, torque values should be applied to the **NUT** instead of the bolt head.

Tighten toothed or serrated-type lock nuts to the full torque value.

^a "Lubricated" means coated with a lubricant such as engine oil, or fasteners with phosphate and oil coatings. "Dry" means plain or zinc plated (yellow dichromate - Specification JDS117) without any lubrication.









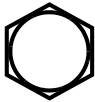

Reference: JDS—G200.

**METRIC FASTENER TORQUE
VALUE - GRADE 7**

Size	Steel or Gray Iron Torque		Aluminum Torque	
	N•m	lb-ft	N•m	lb-ft
M6	11	8	8	6
M8	24	18	19	14
M10	52	38	41	30
M12	88	65	70	52
M14	138	102	111	82
M16	224	165	179	132



INCH FASTENER TORQUE VALUES

SAE Grade and Head Markings	1 or 2 ^b No Marks 	5  5.1  5.2 	8  8.2 
	2 No Marks 	5  	8  

TS1162

SIZE	Grade 1		Grade 2 ^b		Grade 5, 5.1 or 5.2		Grade 8 or 8.2									
	Lubricated ^a	Dry ^a	Lubricated ^a	Dry ^a	Lubricated ^a	Dry ^a	Lubricated ^a	Dry ^a								
	N•m	lb-ft	N•m	lb-ft	N•m	lb-ft	N•m	lb-ft	N•m	lb-ft	N•m	lb-ft	N•m	lb-ft	N•m	lb-ft
1/4	3.7	2.8	4.7	3.5	6	4.5	7.5	5.5	9.5	7	12	9	13.5	10	17	12.5
5/16	7.7	5.5	10	7	12	9	15	11	20	15	25	18	28	21	35	26
3/8	14	10	17	13	22	16	27	20	35	26	44	33	50	36	63	46
7/16	22	16	28	20	35	26	44	32	55	41	70	52	80	58	100	75
1/2	33	25	42	31	53	39	67	50	85	63	110	80	120	90	150	115
9/16	48	36	60	45	75	56	95	70	125	90	155	115	175	130	225	160
5/8	67	50	85	62	105	78	135	100	170	125	215	160	215	160	300	225
3/4	120	87	150	110	190	140	240	175	300	225	375	280	425	310	550	400
7/8	190	140	240	175	190	140	240	175	490	360	625	450	700	500	875	650
1	290	210	360	270	290	210	360	270	725	540	925	675	1050	750	1300	975
1-1/8	470	300	510	375	470	300	510	375	900	675	1150	850	1450	1075	1850	1350
1-1/4	570	425	725	530	570	425	725	530	1300	950	1650	1200	2050	1500	2600	1950
1-3/8	750	550	950	700	750	550	950	700	1700	1250	2150	1550	2700	2000	3400	2550
1-1/2	1000	725	1250	925	990	725	1250	930	2250	1650	2850	2100	3600	2650	4550	3350

DO NOT use these hand torque values if a different torque value or tightening procedure is given for a specific application. Torque values listed are for general use only and include a ±10% variance factor. Check tightness of fasteners periodically. DO NOT use air powered wrenches.

Shear bolts are designed to fail under predetermined loads. Always replace shear bolts with identical grade.

Fasteners should be replaced with the same grade. Make sure fastener threads are clean and that you properly start thread engagement. This will prevent them from failing when tightening.

When bolt and nut combination fasteners are used, torque values should be applied to the **NUT** instead of the bolt head.

Tighten toothed or serrated-type lock nuts to the full torque value.

^a "Lubricated" means coated with a lubricant such as engine oil, or fasteners with phosphate and oil coatings. "Dry" means plain or zinc plated (yellow dichromate - Specification JDS117) without any lubrication.

^b "Grade 2" applies for hex cap screws (not hex bolts) up to 152 mm (6-in.) long. "Grade 1" applies for hex cap screws over 152 mm (6-in.) long, and for all other types of bolts and screws of any length.

Reference: JDS—G200.

O-RING SEAL SERVICE RECOMMENDATIONS

FACE SEAL FITTINGS WITH INCH STUD ENDS TORQUE

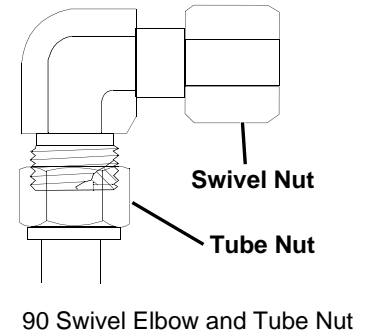
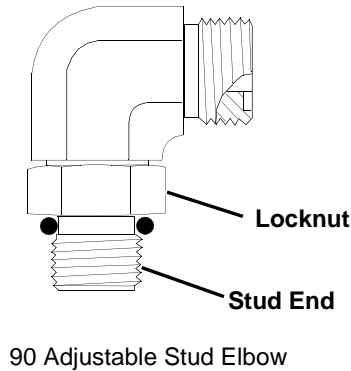
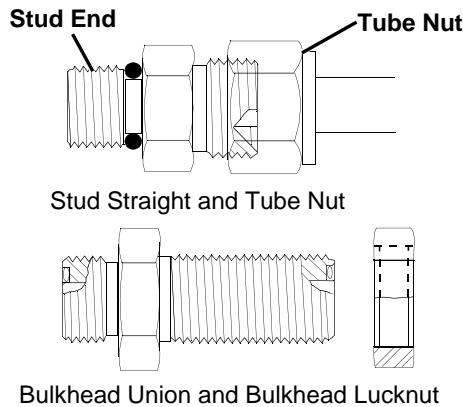

Nominal Tube O.D./Hose I.D.				Face Seal Tube/Hose End					O-ring Stud Ends		
Metric Tube O.D.	Inch Tube O.D.			Thread Size	Tube Nut/ Swivel Nut Torque		Bulkhead Locknut Torque		Thread Size	Straight Fitting or Locknut Torque	
mm	Dash Size	in.	mm	in.	N•m	lb-ft	N•m	lb-ft	in.	N•m	lb-ft
	-3	0.188	4.76						3/8-24	8	6
6	-4	0.250	6.35	9/16-18	16	12	12	9	7/16-20	12	9
8	-5	0.312	7.94						1/2-20	16	12
10	-6	0.375	9.52	11/16-16	24	18	24	18	9/16-18	24	18
12	-8	0.500	12.70	13/16-16	50	37	46	34	3/4-16	46	34
16	-10	0.625	15.88	1-14	69	51	62	46	7/8-14	62	46
	-12	0.750	19.05	1-3/16-12	102	75	102	75	1-1/16-12	102	75
22	-14	0.875	22.22	1-3/16-12	102	75	102	75	1-3/16-12	122	90
25	-16	1.000	25.40	1-7/16-12	142	105	142	105	1-5/16-12	142	105
32	-20	1.25	31.75	1-11/16-12	190	140	190	140	1-5/8-12	190	140
38	-24	1.50	38.10	2-12	217	160	217	160	1-7/8-12	217	160

NOTE: Torque tolerance is + 15 minus 20%.

FACE SEAL FITTINGS WITH METRIC STUD ENDS TORQUE

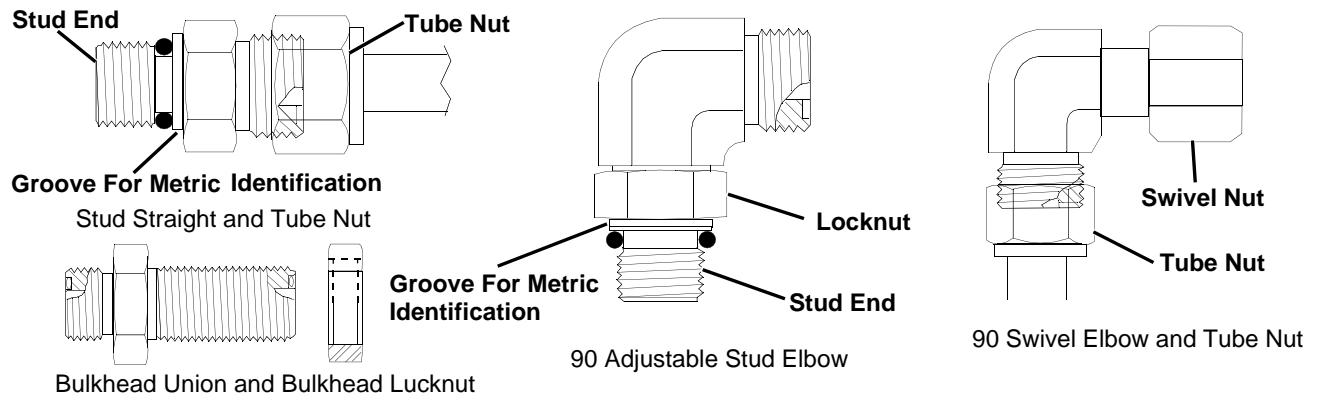

Nominal Tube O.D./Hose I.D.				Face Seal Tube/Hose End						O-ring Stud Ends, Straight Fitting or Locknut					
Metric Tube O.D.	Inch Tube O.D.			Thread Size	Hex Size	Tube Nut/ Swivel Nut Torque		Bulkhead Locknut Torque		Thread Size	Hex Size	Steel or Gray Iron Torque		Aluminum Torque	
	mm	Dash Size	in.			mm	in.	mm	N•m			lb-ft	N•m	lb-ft	mm
6	-4	0.250	6.35	9/16-18	17	16	12	12	9	M12X1.5	17	21	15.5	9	6.6
8	-5	0.312	7.94												
										M14X1.5	19	33	24	15	11
10	-6	0.375	9.52	11/16-16	22	24	18	24	18	M16X1.5	22	41	30	18	13
12	-8	0.500	12.70	13/16-16	24	50	37	46	34	M18X1.5	24	50	37	21	15
16	-10	0.625	15.88	1-14	30	69	51	62	46	M22X1.5	27	69	51	28	21
	-12	0.750	19.05	1-3/16-12	36	102	75	102	75	M27X2	32	102	75	46	34
22	-14	0.875	22.22	1-3/16-12	36	102	75	102	75	M30X2	36				
25	-16	1.000	25.40	1-7/16-12	41	142	105	142	105	M33X2	41	158	116	71	52
28										M38X2	46	176	130	79	58
32	-20	1.25	31.75	1-11/16-12	50	190	140	190	140	M42X2	50	190	140	85	63
38	-24	1.50	38.10	2-12	60	217	160	217	160	M48X2	55	217	160	98	72

NOTE: Torque tolerance is + 15 minus 20%.

O-RING FACE SEAL FITTINGS

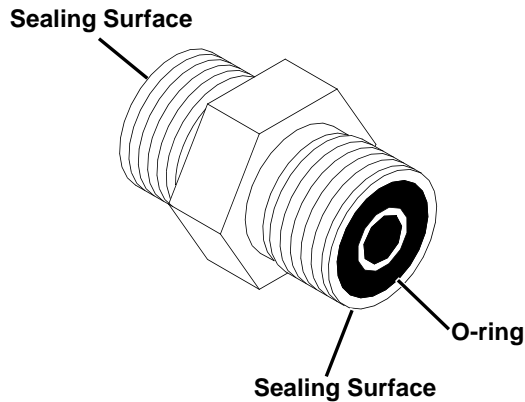

1. Inspect the fitting sealing surfaces. They must be free of dirt or defects.
2. Inspect the O-ring. It must be free of damage or defects.
3. Lubricate O-rings and install into groove using petroleum jelly to hold in place.
4. Push O-ring into the groove with plenty of petroleum jelly so O-ring is not displaced during assembly.
5. Index angle fittings and tighten by hand pressing joint together to insure O-ring remains in place.
6. Tighten fitting or nut to torque value shown on the chart per dash size stamped on the fitting. Do not allow hoses to twist when tightening fittings.

O-RING BOSS FITTINGS

1. Inspect boss O-ring boss seat. It must be free of dirt and defects. If repeated leaks occur, inspect for defects with a magnifying glass. Some raised defects can be removed with a slip stone.

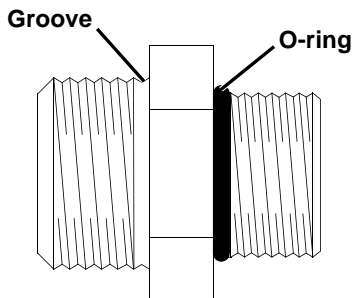

2. Put hydraulic oil or petroleum jelly on the O-ring. Place electrical tape over the threads to protect O-ring from nicks. Slide O-ring over the tape and into the groove of fitting. Remove tape.

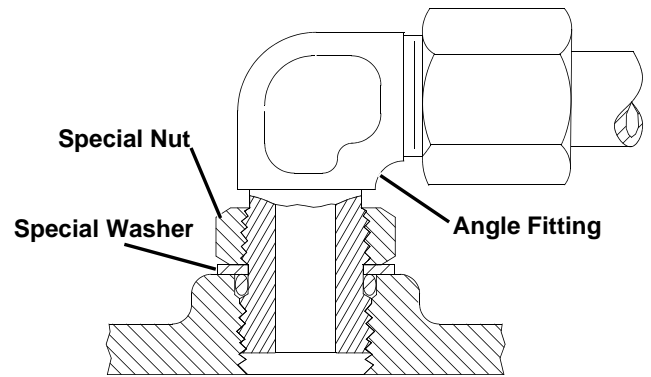

3. For angle fittings, loosen special nut and push special washer against threads so O-ring can be installed into the groove of fitting.
4. Turn fitting into the boss by hand until special washer or washer face (straight fitting) contacts boss face and O-ring is squeezed into its seat.
5. To position angle fittings, turn the fitting counter-clockwise a maximum of one turn.
6. Tighten straight fittings to torque value shown on chart. For angle fittings, tighten the special nut to value shown in the chart while holding body of fitting with a wrench.

STRAIGHT FITTING OR SPECIAL NUT TORQUE

Thread Size	Torque ^a		Number of Flats ^b
	N•m	lb-ft	
3/8-24 UNF	8	(6)	2
7/16-20 UNF	12	(9)	2
1/2-20 UNF	16	(12)	2
9/16-18 UNF	24	(18)	2
3/4-16 UNF	46	(34)	2
7/8-14 UNF	62	(46)	1-1/2
1-1/16-12 UN	102	(75)	1
1-3/16-12 UN	122	(90)	1
1-5/16-12 UN	142	(105)	3/4
1-5/8-12 UN	190	(140)	3/4
1-7/8-12 UN	217	(160)	1/2

a. Torque tolerance is ± 10 percent.

b. To be used if a torque wrench cannot be used. After tightening fitting by hand, put a mark on nut or boss; then tighten special nut or straight fitting the number of flats shown.

GASOLINE SPECIFICATIONS 4-CYCLE ENGINES - NORTH AMERICA

CAUTION

Gasoline is **HIGHLY FLAMMABLE**, handle it with care.

DO NOT refuel machine while:

- indoors, always fill gas tank outdoors;
- machine is near an open flame or sparks;
- engine is running, **STOP** engine;
- engine is hot, allow it to cool sufficiently first;
- smoking.

Help prevent fires:

- fill gas tank to bottom of filler neck only;
- be sure fill cap is tight after fueling;
- clean up any gas spills **IMMEDIATELY**;
- keep machine clean and in good repair—free of excess grease, oil, debris, and faulty or damaged parts;
- any storage of machines with gas left in tank should be in an area that is well ventilated to prevent possible igniting of fumes by an open flame or spark, this includes any appliance with a pilot light.

To prevent fire or explosion caused by **STATIC ELECTRIC DISCHARGE** during fueling:

- **ONLY** use a clean, approved **POLYETHYLENE PLASTIC** fuel container and funnel **WITHOUT** any metal screen or filter.

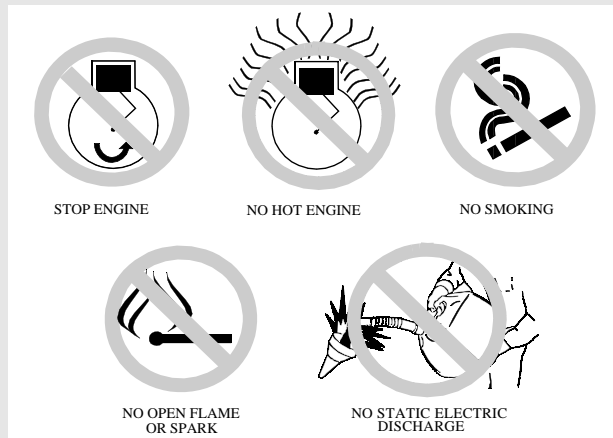

To avoid engine damage:

- DO NOT mix oil with gasoline;
- **ONLY** use clean, fresh unleaded gasoline with an octane rating (anti-knock index) of 87 or higher;
- fill gas tank at the end of each day's operation to help prevent condensation from forming inside a partially filled tank;
- keep up with specified service intervals.

Use of alternative oxygenated, gasohol blended, unleaded gasoline is acceptable as long as:

- the ethyl or grain alcohol blends DO NOT exceed 10% by volume or
- methyl tertiary butyl ether (MTBE) blends DO NOT exceed 15% by volume.

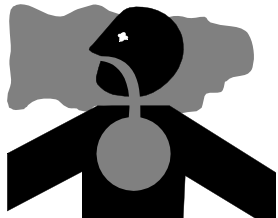

IMPORTANT: DO NOT use **METHANOL** gasolines because **METHANOL** is harmful to the environment and to your health.

WARNING

California Proposition 65 Warning: Gasoline engine exhaust from this product contains chemicals known to the State of California to cause cancer, birth defects, or other reproductive harm.

GASOLINE STORAGE

IMPORTANT: Keep all dirt, scale, water or other foreign material out of gasoline.

Keep gasoline stored in a safe, protected area. Storage of gasoline in a clean, properly marked (**"UNLEADED GASOLINE"**) **POLYETHYLENE PLASTIC** container **WITHOUT** any metal screen or filter is recommended. **DO NOT** use de-icers to attempt to remove water from gasoline or depend on fuel filters to remove water from gasoline. Use a water separator installed in the storage tank outlet. **BE SURE** to properly discard unstable or contaminated gasoline. When storing unit or gasoline, it is recommended that you add **John Deere Gasoline Conditioner and Stabilizer (TY15977)** or an equivalent to the gasoline. **BE SURE** to follow directions on container and to properly discard empty container.

4-CYCLE ENGINES - EUROPE



CAUTION

Gasoline is **HIGHLY FLAMMABLE**, handle it with care.

DO NOT refuel machine while:

- indoors, always fill gas tank outdoors;
- machine is near an open flame or sparks;
- engine is running, **STOP** engine;
- engine is hot, allow it to cool sufficiently first;
- smoking.

Help prevent fires:

- fill gas tank to bottom of filler neck only;
- be sure fill cap is tight after fueling;
- clean up any gas spills **IMMEDIATELY**;
- keep machine clean and in good repair—free of excess parts;
- any storage of machines with gas left in tank should be in an area that is well ventilated to prevent possible igniting of fumes by an open flame or spark, this includes any appliance with a pilot light.

To prevent fire or explosion caused by **STATIC ELECTRIC DISCHARGE** during fueling:

- **ONLY** use a clean, approved **POLYETHYLENE PLASTIC** fuel container and funnel **WITHOUT** any metal screen or filter.



STOP ENGINE

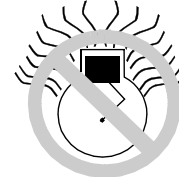

NO HOT ENGINE



NO SMOKING

NO OPEN FLAME
OR SPARKNO STATIC ELECTRIC
DISCHARGE

To avoid engine damage:

- DO NOT mix oil with gasoline;
- **ONLY** use clean, fresh unleaded gasoline with an octane rating (anti-knock index) of 87 or higher;
- fill gas tank at the end of each day's operation to help prevent condensation from forming inside a partially filled tank;
- keep up with specified service intervals.

Use of alternative oxygenated, gasohol blended, unleaded gasoline is acceptable as long as:

- the ethyl or grain alcohol blends DO NOT exceed 10% by volume or
- methyl tertiary butyl ether (MTBE) blends DO NOT exceed 15% by volume.

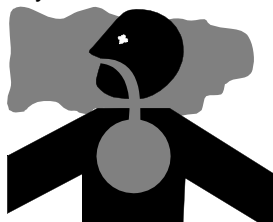

IMPORTANT: DO NOT use **METHANOL** gasolines because **METHANOL** is harmful to the environment and to your health.

GASOLINE STORAGE

IMPORTANT: Keep all dirt, scale, water or other foreign material out of gasoline.

Keep gasoline stored in a safe, protected area. Storage of gasoline in a clean, properly marked (“**UNLEADED GASOLINE**”) **POLYETHYLENE PLASTIC** container **WITHOUT** any metal screen or filter is recommended. **DO NOT** use de-icers to attempt to remove water from gasoline or depend on fuel filters to remove water from gasoline. Use a water separator installed in the storage tank outlet. **BE SURE** to properly discard unstable or contaminated gasoline. When storing unit or gasoline, it is recommended that you add **John Deere Gasoline Conditioner and Stabilizer (TY15977)** or an equivalent to the gasoline. **BE SURE** to follow directions on container and to properly discard empty container.

4-CYCLE GASOLINE ENGINE OIL

4-CYCLE GASOLINE ENGINE OIL -
NORTH AMERICA

IMPORTANT: Kohler command engines were designed and built to use multi-viscosity oil. Multi-viscosity oil is required for proper operation of hydraulic valve lifters used in Kohler command engines.

Use the appropriate oil viscosity based on the expected air temperature range during the period between recommended oil changes. Operating outside of these recommended oil air temperature ranges may cause premature engine failure.

The following John Deere oils are **PREFERRED**:

- **PLUS-4®—SAE 10W-40;**
- **TURF-GARD®—SAE 10W-30;**
- **PLUS-4®—SAE 10W-30;**

The following John Deere oil is **also recommended**, based on their specified temperature range:

- **TORQ-GARD SUPREME®—SAE 5W-30.**

Other oils may be used if above John Deere oils are not available, provided they meet one of the following specifications:

- SAE 10W-40—API Service Classification SG or higher;
- SAE 10W-30—API Service Classification SG or higher;
- SAE 5W-30—API Service Classification SG or higher.

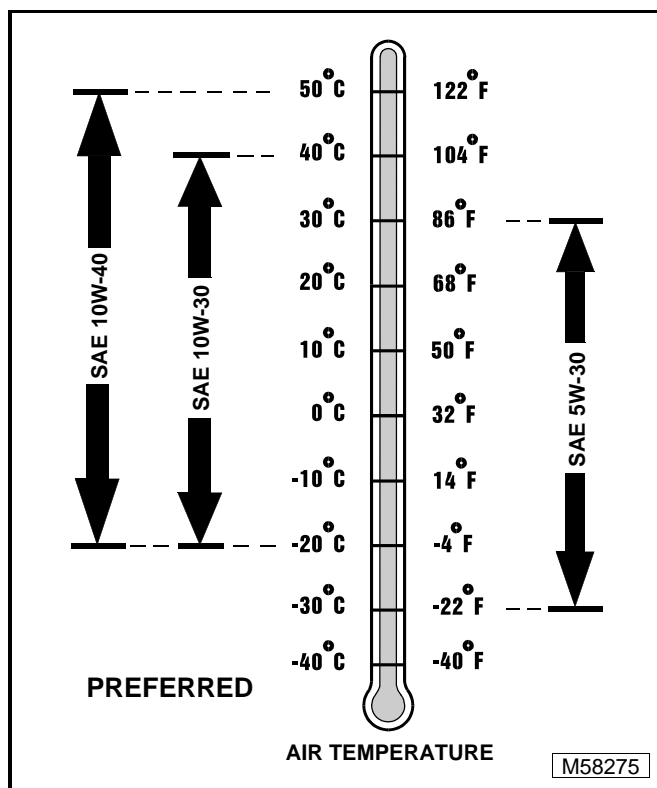

John Deere Dealers: You may want to cross-reference the following publications to recommend the proper oil for your customers:

- Module DX, ENOIL2 in JDS-G135;
- Section 530, Lubricants & Hydraulics, of the John Deere Merchandise Sales Guide;
- Lubrication Sales Manual PI7032.

4-CYCLE GASOLINE ENGINE OIL - EUROPE

IMPORTANT: Kohler command engines were designed and built to use multi-viscosity oil. Multi-viscosity oil is required for proper operation of hydraulic valve lifters used in Kohler command engines.

Use the appropriate oil viscosity based on the expected air temperature range during the period between recommended oil changes. Operating outside of these recommended oil air temperature ranges may cause premature engine failure.

The following John Deere oils are **PREFERRED**:

- **TORQ-GARD SUPREME®—SAE 10W-40;**
- **UNI-GARD™—SAE 10W-40;**
- **TORQ-GARD SUPREME®—SAE 10W-30;**
- **UNI-GARD™—SAE 10W-30.**

The following John Deere oil is **also recommended**, based on their specified temperature range:

- **TORQ-GARD SUPREME®—SAE 5W-30;**
- **UNI-GARD™—SAE 5W-30.**

Other oils may be used if above John Deere oils are not available, provided they meet one of the following specifications:

- CCMC Specification G4 or higher.

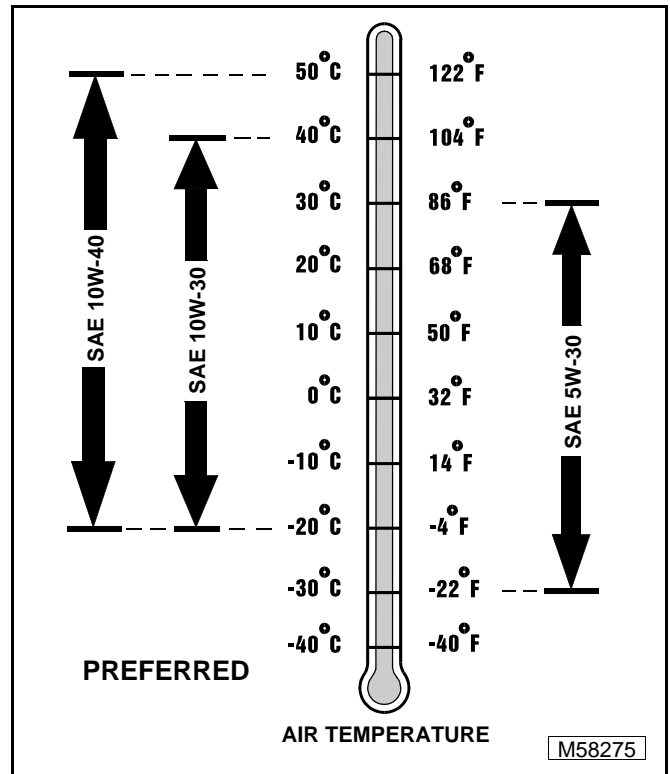

John Deere Dealers: You may want to cross-reference the following publications to recommend the proper oil for your customers:

- Module DX, ENOIL2 in JDS-G135;
- Section 530, Lubricants & Hydraulics, of the John Deere Merchandise Sales Guide.

BREAK-IN 4-CYCLE GASOLINE ENGINE OIL - NORTH AMERICA

IMPORTANT: ONLY use a quality break-in oil (multi-viscosity) in rebuilt or remanufactured engines for the first 5 hours (maximum) of operation. DO NOT use oils with heavier viscosity weights than SAE 5W-30 or oils meeting specifications API SG or SH, these oils will not allow rebuilt or remanufactured engines to break-in properly.

The following John Deere oil is **PREFERRED**:

- **BREAK-IN ENGINE OIL.**

John Deere BREAK-IN ENGINE OIL is formulated with special additives for aluminum and cast iron type engines to allow the power cylinder components (pistons, rings, and liners as well) to “wear-in” while protecting other engine components, valve train and gears, from abnormal wear. Engine rebuild instructions should be followed closely to determine if special requirements are necessary.

John Deere BREAK-IN ENGINE OIL is also recommended for non-John Deere engines, both aluminum and cast iron types.

The following John Deere oil is **also recommended** as a break-in engine oil:

- **TORQ-GARD SUPREME®—SAE 5W-30.**

If the above recommended John Deere oils are not available, use a break-in engine oil meeting the following specification during the first 5 hours (maximum) of operation:

- SAE 5W-30—API Service Classification SE or higher.

IMPORTANT: After the break-in period, use the John Deere oil that is recommended for this engine.

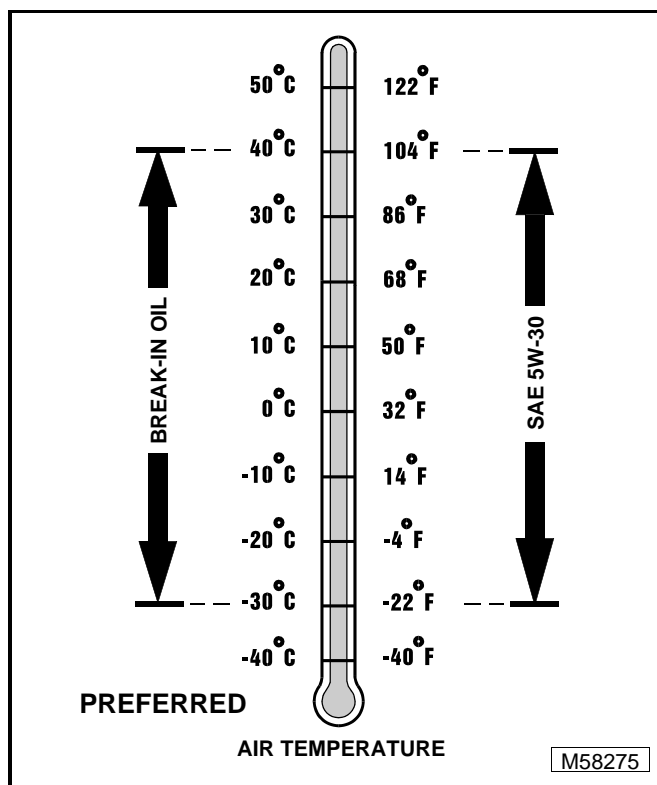

John Deere Dealers: You may want to cross-reference the following publications to recommend the proper oil for your customers:

- Module DX, ENOIL4 in JDS-G135;
- Section 530, Lubricants & Hydraulics, of the John Deere Merchandise Sales Guide;
- Lubrication Sales Manual PI7032.

BREAK-IN 4-CYCLE GASOLINE ENGINE OIL - EUROPE

IMPORTANT: ONLY use a quality break-in oil (multi-viscosity) in rebuilt or remanufactured engines for the first 5 hours (maximum) of operation. DO NOT use oils with heavier viscosity weights than SAE 5W-30 or oils meeting CCMC Specification G5—these oils will not allow rebuilt or remanufactured engines to break-in properly.

The following John Deere oil is **PREFERRED**:

- **BREAK-IN ENGINE OIL.**

John Deere **BREAK-IN ENGINE OIL** is formulated with special additives for aluminum and cast iron type engines to allow the power cylinder components (pistons, rings, and liners as well) to “wear-in” while protecting other engine components, valve train and gears, from abnormal wear. Engine rebuild instructions should be followed closely to determine if special requirements are necessary.

John Deere **BREAK-IN ENGINE OIL** is also recommended for non-John Deere engines, both aluminum and cast iron types.

The following John Deere oil is **also recommended** as a break-in engine oil:

- **TORQ-GARD SUPREME®—SAE 5W-30.**

If the above recommended John Deere oils are not available, use a break-in engine oil meeting the following specification during the first 5 hours (maximum) of operation:

- SAE 5W-30—CCMC Specification G4 or higher.

IMPORTANT: After the break-in period, use the John Deere oil that is specified for this engine.

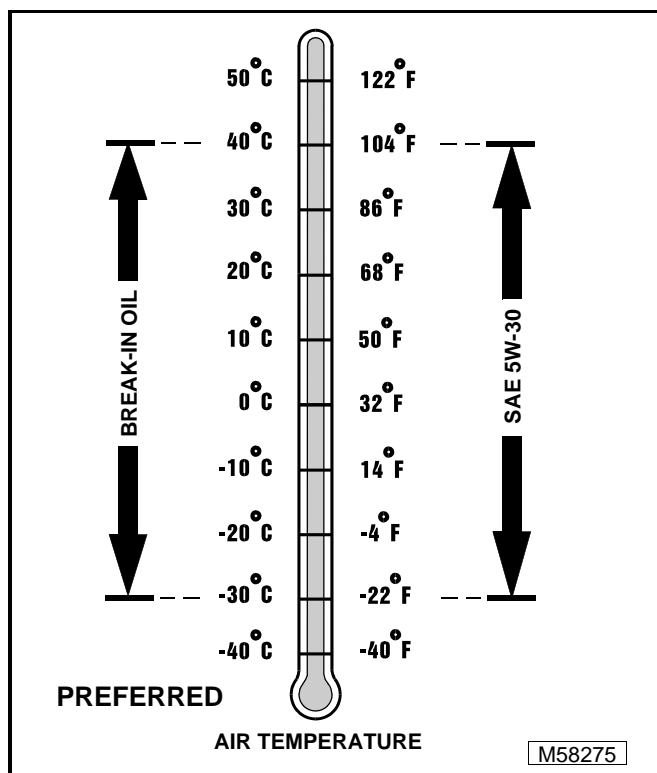

John Deere Dealers: You may want to cross-reference the following publications to recommend the proper oil for your customers:

- Module DX, ENOIL4 in JDS-G135;
- Section 530, Lubricants & Hydraulics, of the John Deere Merchandise Sales Guide.

HYDROSTATIC TRANSMISSION OIL

HYDROSTATIC TRANSMISSION OIL
- NORTH AMERICA

Use the following oil viscosity based on the air temperature range. Operating outside of the recommended oil air temperature range may cause premature hydrostatic transmission failure.

IMPORTANT: ONLY use a quality SAE 10W-30 engine oil in this transmission. DO NOT mix any other oils in this transmission. DO NOT use BIO-HY-GARD® in this transmission.

The following John Deere oils are **PREFERRED**:

- **TURF-GARD®—SAE 10W-30;**
- **PLUS-4®—SAE 10W-30.**

Other oils may be used if above recommended John Deere oils are not available, provided they meet one of the following specifications:

- API Service Classification SG or higher.

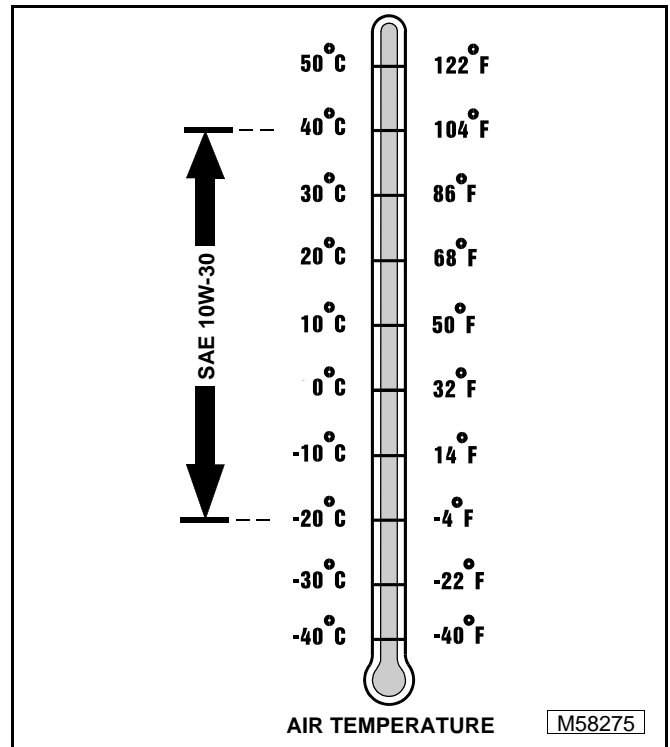

John Deere Dealers: You may want to cross-reference the following publications to recommend the proper oil for your customers:

- Module DX, ENOIL2 in JDS-G135;
- Section 530, Lubricants & Hydraulics, of the John Deere Merchandise Sales Guide;
- Lubrication Sales Manual PI7032.

HYDROSTATIC TRANSMISSION OIL - EUROPE

Use the following oil viscosity based on the air temperature range. Operating outside of the recommended oil air temperature range may cause premature hydrostatic transmission failure.

IMPORTANT: ONLY use a quality SAE 10W-30 engine oil in this transmission. DO NOT mix any other oils in this transmission. DO NOT use BIO-HY-GARD® in this transmission.

The following John Deere oil is **PREFERRED**:

- **TORQ-GARD SUPREME®—SAE 10W-30.**

Other oils may be used if above recommended John Deere oils are not available, provided they meet one of the following specifications:

- CCMC Specification G4 or higher.

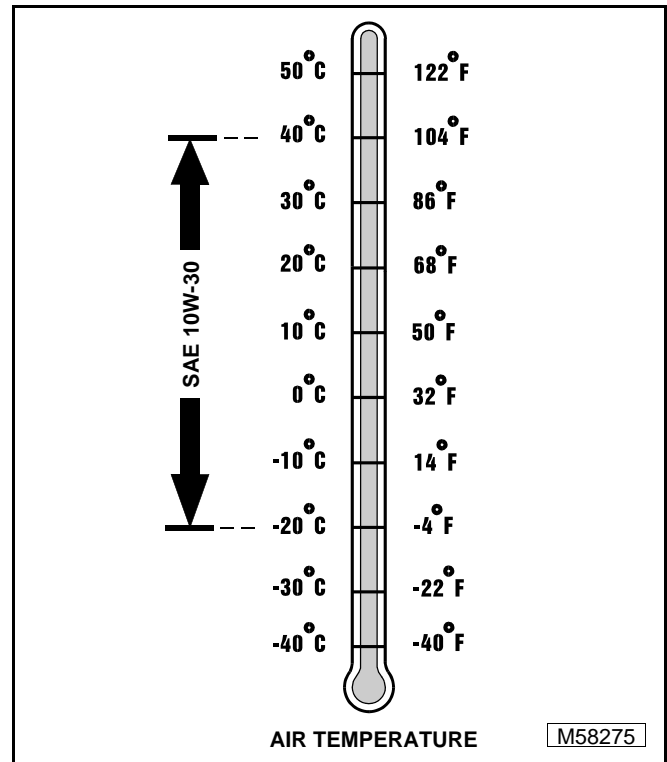

John Deere Dealers: You may want to cross-reference the following publications to recommend the proper oil for your customers:

- Module DX, ENOIL2 in JDS-G135;
- Section 530, Lubricants & Hydraulics, of the John Deere Merchandise Sales Guide.

ALTERNATIVE LUBRICANTS



Conditions in certain geographical areas outside the United States and Canada may require different lubricant recommendations than the ones printed in this technical manual or the operator's manual. Consult with your John Deere Dealer, or Sales Branch, to obtain the alternative lubricant recommendations.

IMPORTANT: Use of alternative lubricants could cause reduced life of the component.

If alternative lubricants are to be used, it is recommended that the factory fill be thoroughly removed before switching to any alternative lubricant.

SYNTHETIC LUBRICANTS

Synthetic lubricants may be used in John Deere equipment if they meet the applicable performance requirements (industry classification and/or military specification) as shown in this manual.

The recommended air temperature limits and service or lubricant change intervals should be maintained as shown in the operator's manual.

Avoid mixing different brands, grades, or types of oil. Oil manufacturers blend additives in their oils to meet certain specifications and performance requirements. Mixing different oils can interfere with the proper functioning of these additives and degrade lubricant performance.

LUBRICANT STORAGE

All machines operate at top efficiency only when clean lubricants are used. Use clean storage containers to handle all lubricants. Store them in an area protected from dust, moisture, and other contamination. Store drums on their sides. Make sure all containers are properly marked as to their contents. Dispose of all old, used containers and their contents properly.

MIXING OF LUBRICANTS

In general, avoid mixing different brands or types of lubricants. Manufacturers blend additives in their lubricants to meet certain specifications and performance requirements. Mixing different lubricants can interfere with the proper functioning of these additives and lubricant properties which will downgrade their intended specified performance.

OIL FILTERS

IMPORTANT: Filtration of oils is critical to proper lubrication performance. Always change filters regularly.

The following John Deere oil filters are PREFERRED:

- AUTOMOTIVE AND LIGHT TRUCK ENGINE OIL FILTERS.

Most John Deere filters contain pressure relief and anti-drainback valves for better engine protection.

Other oil filters may be used if above recommended John Deere oil filters are not available, provided they meet the following specification:

- ASTB Tested In Accordance With SAE J806.

John Deere Dealers: You may want to cross-reference the following publications to recommend the proper oil filter for your customers:

- Module DX,FILT in JDS-G135;
- Section 540, Lubricants & Hydraulics, of the John Deere Merchandise Sales Guide;
- Lawn & Grounds Care Tune-Up Guide PI672.

GEAR TRANSMISSION GREASE

Use the following gear grease based on the air temperature range. Operating outside of the recommended grease air temperature range may cause premature gear transmission failure.

IMPORTANT: ONLY use these specified greases in this transmission. DO NOT mix any other greases in this transmission. DO NOT use any BIO-GREASE in this transmission.

ONLY use the following **PREFERRED** grease as the **input shaft needle bearing** lubricant:

- **Unirex N3 Grease®—M120263.**

Other greases may be used as the input shaft needle bearing lubricant if they meet or exceed the following specification:

- ASTM D-1743, NLGI Grade 1.

ONLY use the following **PREFERRED** grease as the **gear housing** lubricant:

- **Shell Darina D Grease®—AM119608.**

Other greases may be used as the gear housing lubricant if they meet or exceed the following specification:

- ASTM D-1743, NLGI Grade 1.

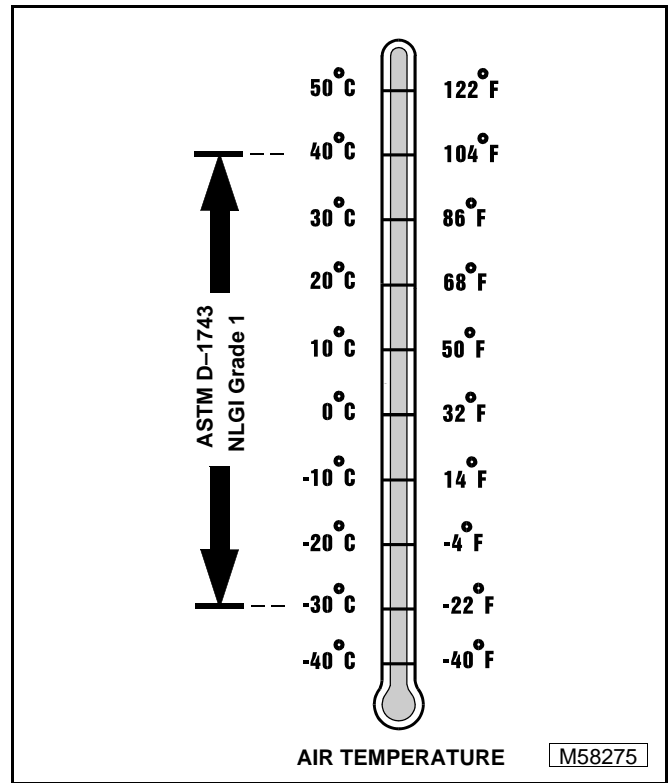

John Deere Dealers: You may want to cross-reference the following publications to recommend the proper grease for your customers:

- Module DX,GREA1 in JDS-G135;
- Section 530, Lubricants & Hydraulics, of the John Deere Merchandise Sales Guide;
- Lubrication Sales Manual PI7032.

ANTI-CORROSION GREASE SPECIFICATIONS



This anti-corrosion grease is formulated to provide the best protection against absorbing moisture, which is one of the major causes of corrosion. This grease is also superior in its resistance to separation and migration.

The following anti-corrosion grease is **PREFERRED**:

- **DuBois MPG-2® Multi-Purpose Polymer Grease—M79292.**

Other greases may be used if they meet or exceed the following specifications:

- John Deere Standard JDM J13A2, NLGI Grade 1.

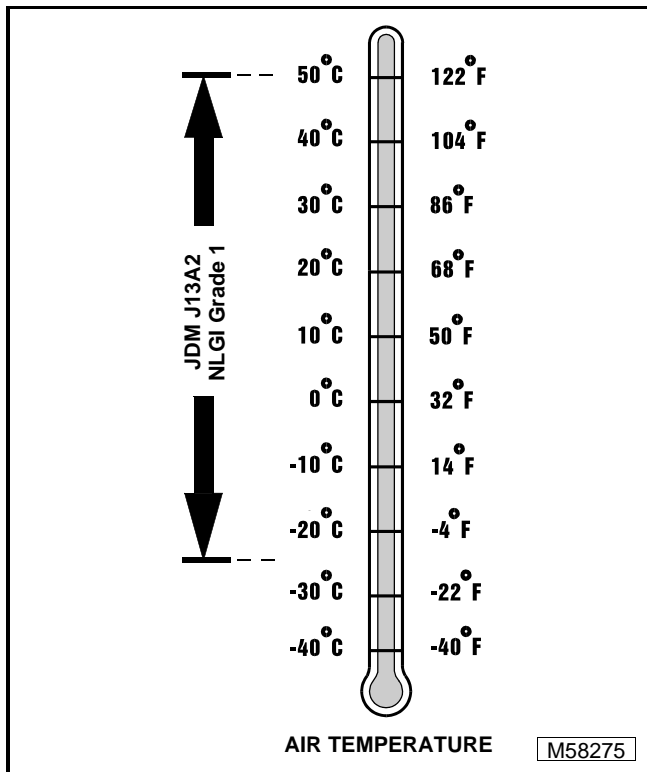

John Deere Dealers: You may want to cross-reference the following publications to recommend the proper grease for your customers:

- Module DX,GREA1 in JDS-G135;
- Section 530, Lubricants & Hydraulics, of the John Deere Merchandise Sales Guide;
- Lubrication Sales Manual PI7032.

GREASE SPECIFICATIONS

GREASE - NORTH AMERICA

Use the following grease based on the air temperature range. Operating outside of the recommended grease air temperature range may cause premature failures.

IMPORTANT: ONLY use a quality grease in this application. DO NOT mix any other greases in this application. DO NOT use any BIO-GREASE in this application.

The following John Deere grease is **PREFERRED**:

- **NON-CLAY HIGH-TEMPERATURE EP GREASE®—JDM J13E4, NLGI Grade 2.**

Other greases may be used if above preferred John Deere grease is not available, provided they meet the following specification:

- John Deere Standard JDM J13E4, NLGI Grade 2.

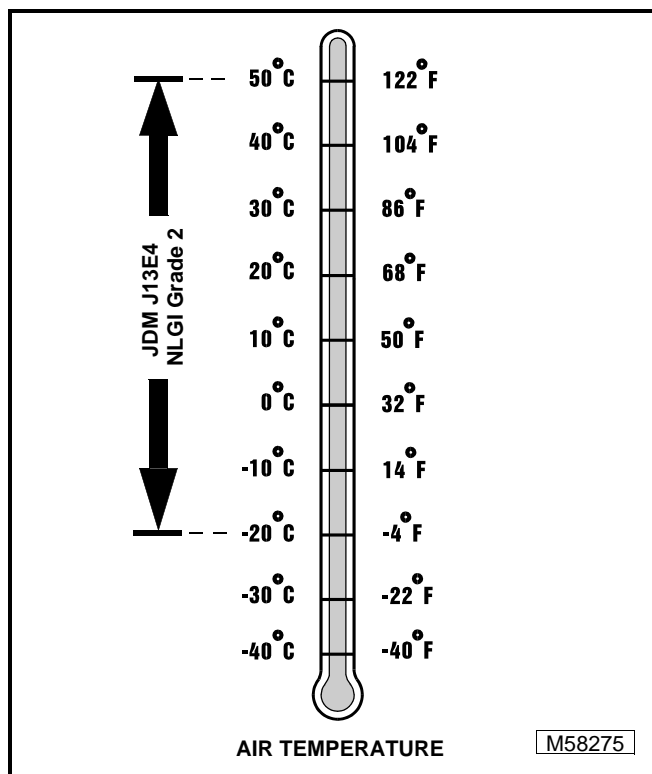

John Deere Dealers: You may want to cross-reference the following publications to recommend the proper grease for your customers:

- Module DX,GREA1 in JDS-G135;
- Section 530, Lubricants & Hydraulics, of the John Deere Merchandise Sales Guide;
- Lubrication Sales Manual PI7032.

GREASE - EUROPE

Use the following grease based on the air temperature range. Operating outside of the recommended grease air temperature range may cause premature failures.

IMPORTANT: ONLY use a quality grease in this application. DO NOT mix any other greases in this application. DO NOT use any BIO-GREASE in this application.

The following John Deere grease is **PREFERRED**:

- **GREASE-GARD™—JDM J13E4, NLGI Grade 2.**

Other greases may be used if above preferred John Deere grease is not available, provided they meet the following specification:

- John Deere Standard JDM J13E4, NLGI Grade 2.

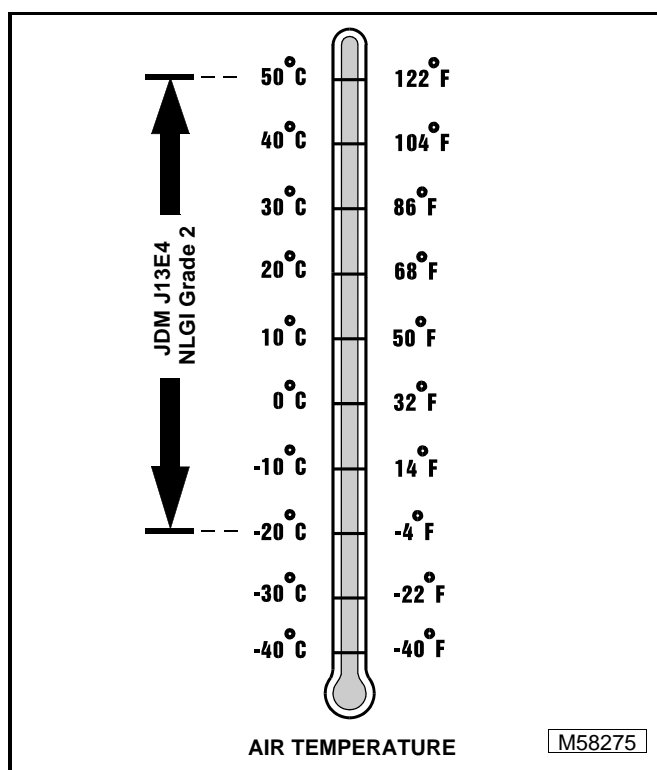

John Deere Dealers: You may want to cross-reference the following publications to recommend the proper grease for your customers:

- Module DX,GREA1 in JDS-G135;
- Section 530, Lubricants & Hydraulics, of the John Deere Merchandise Sales Guide.

SERIAL NUMBER LOCATIONS

ENGINE SERIAL NUMBER SUFFIX



Domestic	Australia	Export
STX38/Gear/12.5 (Steel Cam) = 8	STX38/Gear/12.5 (Steel Cam) = 8	STX38/Gear/12.5 (Plastic Cam) =4
STX38/Hydro/12.5 (Steel Cam) = 8	STX38/Hydro/12.5 (Steel Cam) =8	STX38/Hydro/14 (Plastic Cam) =9
STX46/Gear/14 (Plastic Cam) = 9	STX46/Gear/14 (Plastic Cam) = 9	
STX46/Hydro/14 (Plastic Cam) =9	STX46/Hydro/14 (Plastic Cam) =9	

IMPORTANT: When working on machines or components that are covered by warranty, it is **IMPORTANT** that you include the transporter product identification number and the component serial numbers on the warranty claim form.

The location of transporter identification number and component serial numbers are shown.

TRACTOR IDENTIFICATION NUMBER

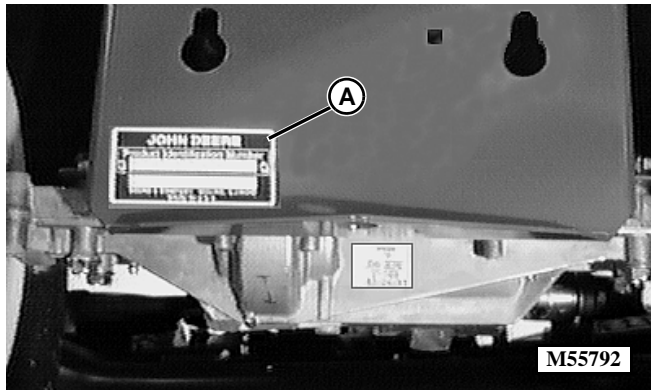

Tractor identification number plate (A) is located on the rear of frame.

ENGINE SERIAL NUMBER

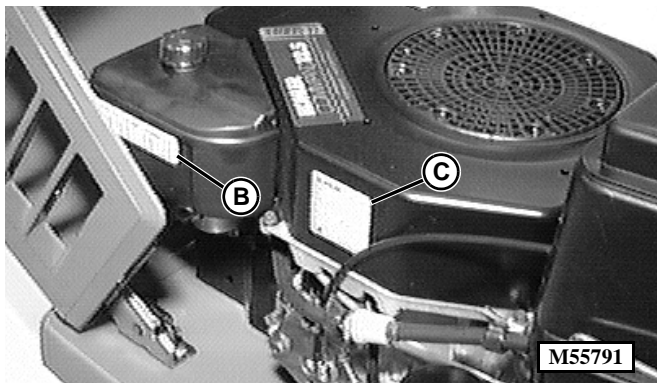

Tractor engine serial number sticker (C) is located on fan shroud and bar code sticker (B) is on air filter housing on left side of engine.

GEAR TRANSAXLE SERIAL NUMBER

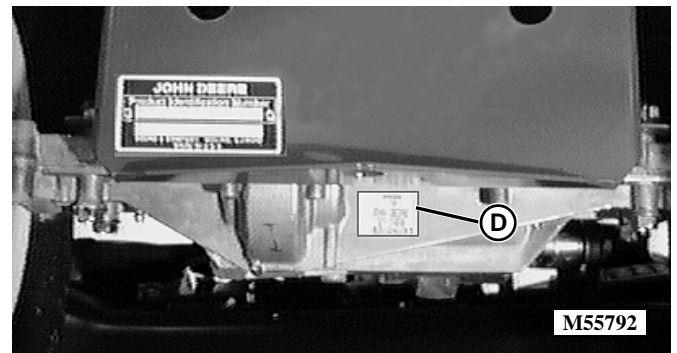

Gear transaxle serial number sticker (D) is on rear of housing.

HYDROSTATIC TRANSMISSION SERIAL NUMBER

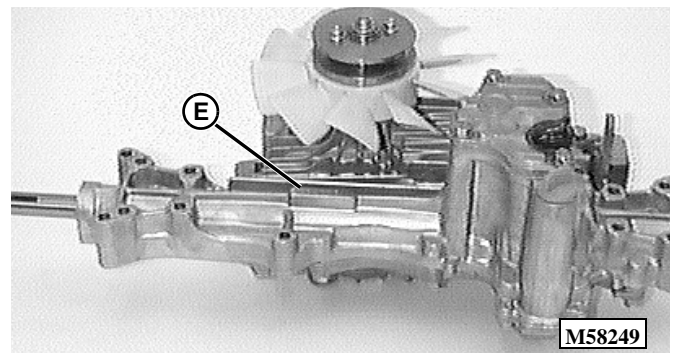

Serial number (E) is stamped into top of upper case half. It is only accessible with hydro removed.

CONTENTS

Page

ENGINE

SPECIFICATIONS	3
GENERAL SPECIFICATIONS	3
TEST AND ADJUSTMENT SPECIFICATIONS	4
REPAIR SPECIFICATIONS	4
TORQUE SPECIFICATIONS	8
ESSENTIAL TOOLS	9
OTHER MATERIALS	9
SERVICE PARTS KITS	9
TROUBLESHOOTING	10
DIAGNOSIS	14
MAIN COMPONENTS	14
ENGINE HARD TO START AND/OR ENGINE STARTER KICKS OUT	16
ENGINE BACKFIRES, HAS LOW POWER, WILL NOT START, OR TURNS OVER SLOWLY AND LOCKS UP	17
TESTS AND ADJUSTMENTS	18
THROTTLE CABLE ADJUSTMENT	18
FAST IDLE SPEED ADJUSTMENT	19
SLOW IDLE SPEED ADJUSTMENT —NON CARB/EPA (EARLY MODELS)	20
SLOW IDLE SPEED ADJUSTMENT —CARB/EPA STX38 (SN 210001—) & STX46	21
CYLINDER COMPRESSION TEST	22
AUTOMATIC COMPRESSION RELEASE TEST	22
CRANKCASE VACUUM TEST	23
FUEL FLOW TEST	24
OIL PRESSURE TEST	24
FUEL AND AIR SYSTEM REPAIR	25
FUEL TANK AND DASH PANEL COMPONENTS	25
REMOVE AND INSTALL FUEL TANK AND DASH PANEL ASSEMBLY	26
REPLACE FUEL FILTER	28
AIR INTAKE SYSTEM COMPONENTS	29
REMOVE AND INSTALL CARBURETOR	29
INSPECT CARBURETOR	30
ENGINE REPAIR	31
REMOVE AND INSTALL ENGINE	31
REMOVE AND INSTALL ROCKER ARMS	32
INSPECT PUSH ROD	32
REMOVE AND INSTALL CYLINDER HEAD	32
REMOVE AND INSTALL VALVES AND SPRINGS	33
INSPECT CYLINDER HEAD	33
INSPECT VALVES	33
ANALYZE VALVES	34
INSPECT VALVE GUIDES	35



RECONDITION VALVE SEATS 35

LAP VALVES 36

INSPECT BREATHER 36

REMOVE AND INSTALL FLYWHEEL 36

REMOVE AND INSTALL CAMSHAFT 37

INSPECT CAMSHAFT 37

MEASURE CAMSHAFT END PLAY 38

HYDRAULIC VALVE LIFTERS—REMOVE AND INSTALL 38

HYDRAULIC VALVE LIFTERS—INSPECTION 38

BALANCER SHAFT REMOVAL & INSTALLATION 39

BALANCER SHAFT INSPECTION 40

GOVERNOR REMOVAL & INSTALLATION 40

GOVERNOR INSPECTION 41

REMOVE PISTON ASSEMBLY 41

ANALYZE PISTON RING WEAR 42

ANALYZE PISTON WEAR 42

PISTON ASSEMBLY—DISASSEMBLE 44

PISTON INSPECTION 44

PISTON RING END GAP MEASUREMENT 44

PISTON RING SIDE CLEARANCE 44

PISTON ASSEMBLY MEASUREMENT 45

PISTON ASSEMBLY 46

INSTALL PISTON ASSEMBLY 46

INSTALL CONNECTING ROD 47

CRANKSHAFT REMOVAL & INSTALLATION 47

CRANKSHAFT & MAIN BEARING INSPECTION 47

CRANKSHAFT ALIGNMENT 48

REMOVE AND INSTALL OIL PAN 48

REMOVE AND INSTALL OIL PAN SEAL 49

REMOVE AND INSTALL CRANKCASE OIL SEAL 49

INSPECT OIL PICKUP 50

OIL PUMP RELIEF VALVE INSPECTION 50

OIL PUMP INSTALLATION 50

CYLINDER BLOCK REMOVE & INSTALL 51

CYLINDER BLOCK INSPECT 51

CYLINDER BORE DEGLAZING 51

REBORE CYLINDER BLOCK 52



SPECIFICATIONS

GENERAL SPECIFICATIONS

Make	Kohler
Style	Command LT
STX30	CV12.5—1216s
STX38 (Serial No. —270000)	CV12.5—1215
STX38 (Domestic & Export) (Serial No. 210001—270000)	CV12.5S—1270
STX38 (Export Gear) (Serial No. 270001—595000)	CV12.5S—1270
STX38 (Domestic Gear & Hydro) (Serial No. 270001—595000)	CV13S—21509
STX38 (Export Hydro) (Serial No. 240001—270000)	CV14S—1463
STX38 (Export Hydro) (Serial No. 270001—595000)	CV14S—1463
STX46 (Domestic Gear & Hydro) (Serial No. 240001—270000)	CV14S—1463
STX46 (Domestic Gear & Hydro) (Serial No. 270001—595000)	CV15S—41521
STX46 (Australia Hydro) (Serial No. 270001—595000)	CV15S—41521
Type	Gasoline, Air Cooled, Single Cylinder, 4-Cycle, Overhead Valve
Power: CV12.5—1270	9.33 kW (12.5 hp)
CV13S—21509	9.69 kW (13.0 hp)
CV14S—1463	10.5 kW (14.0 hp)
CV15S—41521	11.19 kW (15.0 hp)
Bore (12.5, 13, 14 hp)	87 mm (3.43 in.)
Bore (15 hp)	90 mm (3.60 in.)
Stroke (All)	67 mm (2.64 in.)
Displacement (12.5, 13, 14 hp)	398 cc (24.3 cu-in.)
Displacement (15 hp)	426 cc (26.0 cu-in.)
Compression Ratio	2:1 Cranking—8.5:1 Running
Compression Release	Automatic/Centrifugal
Crankshaft Type	Vertical (counterbalanced)
Lubrication	Gerotor Pump (0—60 psi)
Oil Filter	Full Flow (W/O By-Pass Valve)
Oil	John Deere Turf-Gard
Warm Climate	10W30
Cold Climate	5W30
Crankcase Capacity (with filter)	1.8 L (1.9 U.S. qt)
Lubrication Interval	50 Hours First Change, Every 100 Hours After or Yearly
Air Filter	Paper With Outer Foam Element
Fuel Filter	Replaceable (In-Line Type)
Fuel Type	Regular Unleaded—87 Octane Or Higher
Gasoline/Alcohol Blends	Up To 10% Ethyl Alcohol-90% Unleaded (By Volume)
Gasoline/Ether Blends	Up To 15% MTBE-85% Unleaded (By Volume)
Fuel Shut-Off Valve	Replaceable (In-Line Type)
Fuel Shut-Off Solenoid (Optional)	Replaceable (Below Carburetor Float Bowl)
Weight	39.54 kg (87 lbs)



TEST AND ADJUSTMENT SPECIFICATIONS

Engine:

Valve Adjustment None (hydraulic lifters)
 Oil Pressure (Minimum at 1250 rpm) 124 kPa (18 psi)
 Crankcase Vacuum (Minimum At Operating Temp.) . . .25 mm (1 in.) Water Movement
 Automatic Compression Release Minimum Lift (Engine Cold) 0.25 mm (0.01 in.)

Fuel/Air System:

Carburetor Slow Idle Mixture Screw Initial Setting Lightly Seat, Then 1 Turn Out
 Slow Idle Speed—Domestic and Export 1650 ±75 rpm
 Fast Idle Speed—Domestic 3350 ±50 rpm
 Fast Idle Speed—Export 3000 ±50 rpm



REPAIR SPECIFICATIONS

Cylinder Head:

Cylinder Head Flatness (Maximum Warp) 0.076 mm (0.003 in.)

Push Rod:

Maximum Bend 0.76 mm (0.030 in.)

Valves and Valve Lifters:

Hydraulic Lifter Clearance 0.0124—0.0501 mm (0.0005—0.0020 in.)
 Intake Valve-to-Guide Clearance 0.038—0.076 mm (0.0015—0.0030 in.)
 Intake Valve Stem OD 6.982—7.000 (0.2749—0.2756 in.)
 Exhaust Valve Stem OD 6.970—6.988 (0.2744—0.2751 in.)
 Exhaust Valve-to-Guide Clearance 0.050—0.088 mm (0.0020—0.0035 in.)
 Intake Valve Guide ID:
 New 7.038—7.058 mm (0.2771—0.2779 in.)
 Maximum 7.134 mm (0.2809 in.)
 Exhaust Valve Guide ID:
 New 7.038—7.058 mm (0.2771—0.2779 in.)
 Maximum 7.159 mm (0.2819 in.)
 Valve Guide Reamer:
 Standard 7.048 mm (0.2775 in.)
 Oversize (0.25 mm) 7.298 mm (0.2873 in.)
 Intake Valve Lift (Minimum—Engine Cold) 8.96 mm (0.353 in.)
 Exhaust Valve Lift (Minimum—Engine Cold) 9.14 mm (0.360 in.)
 Valve Face Angle 45°
 Valve Seat Angle 44.5

REPAIR SPECIFICATIONS (Continued)

Rocker Arms:

Rocker Arm I.D.

New	15.837—16.127 mm (0.63—0.64 in.)
Wear Limit	15.727 mm (0.619 in.)

Rocker Shaft:

Rocker Shaft O.D.

New	15.837—16.127 mm (0.63—0.64 in.)
Wear Limit	15.727 mm (0.619 in.)

Crankshaft:

End Play	0.0575—0.4925 mm (0.0023—0.0194 in.)
--------------------	--------------------------------------

Crankshaft Bore (Crankcase Half) ID:

New	44.965—45.003 mm (1.7703—1.7718 in.)
Maximum	45.016 mm (1.7723 in.)
Clearance (New)	0.03—0.09 mm (0.0012—0.0035 in.)

Crankshaft Bore (Oil Pan Half):

New	44.965—45.003 mm (1.7703—1.7718 in.)
Maximum	45.016 mm (1.7723 in.)
Clearance (New)	0.03—0.09 mm (0.0012—0.0035 in.)

Main Bearing Journal OD (Flywheel End):

New	44.913—44.935 mm (1.7682—1.7691 in.)
Minimum	44.84 mm (1.765 in.)
Maximum Taper	0.022 mm (0.0009 in.)
Maximum Out-of-Round	0.025 mm (0.0010 in.)

Main Bearing Journal OD (Oil Pan End):

New	41.915—41.935 mm (1.6502—1.6510 in.)
Minimum	41.86 mm (1.648 in.)
Maximum Taper	0.020 mm (0.0008 in.)
Maximum Out-of-Round	0.025 mm (0.0010 in.)

Connecting Rod Journal OD:

New	38.958—38.970 mm (1.5338—1.5343 in.)
Minimum	38.94 mm (1.5328 in.)
Maximum Taper	0.012 mm (0.0005 in.)
Maximum Out-of-Round	0.025 mm (0.0010 in.)

Crankshaft Total Indicated Runout (TIR):

PTO End (In Engine)	0.15 mm (0.0059 in.)
Entire Crankshaft (In Bench V-Blocks)	0.10 mm (0.0039 in.)



REPAIR SPECIFICATIONS (Continued)

Camshaft:

End Play	0.076—0.127 mm (0.003—0/005 in.)
Clearance	0.025—0.063 mm (0.0010—0.0025 in.)
Bore ID:	
New	20.000—20.025 mm (0.7874—0.7884 in.)
Maximum	20.038 mm (0.7889 in.)
Bearing OD:	
New	19.962—19.975 mm (0.7859—0.7864 in.)
Minimum	19.959 mm (0.7858 in.)

Balance Shaft:

End Play	0.0575—0.3625 mm (0.0023—0.0143 in.)
Clearance	0.025—0.063 mm (0.0009—0.0025 in.)
Bore ID:	
New	20.000—20.025 mm (0.7874—0.7884 in.)
Maximum	20.038 mm (0.7889 in.)
Balance Shaft Bearing OD:	
New	19.962—19.975 mm (0.7859—7864 in.)
Minimum	19.959 mm (0.7858 in.)

Cylinder Bore, Piston and Rings:

Cylinder Bore ID (12.5, 13, 14 hp):	
New	87.000—87.025 mm (3.4252—3.4262 in.)
Maximum	87.063 mm (3.4277 in.)
Cylinder Bore ID (15 hp):	
New	90.000—90.025 mm (3.5433—3.5443 in.)
Maximum	90.63 mm (3.5681 in.)
Maximum Out-of-Round	0.12 mm (0.0047 in.)
Maximum Taper	0.05 mm (0.0020 in.)
Piston-To-Pin Clearance	0.006—0.017 mm (0.0002—0.0007 in.)
Piston Pin Bore ID:	
New	19.006—19.012 mm (0.7483—0.7485 in.)
Maximum	19.025 mm (0.7490 in.)
Piston Pin OD:	
New	18.995—19.000 mm (0.7478—0.7480 in.)
Minimum	18.994 mm (0.74779 in.)
Top Compression Ring-To-Groove Side Clearance	
12.5, 13, 14 hp	0.040—0.105 mm (0.0016—0.0041 in.)
15 hp	0.060—0.105 mm (0.0023—0.0041 in.)
Middle Compression Ring-To- Groove Side Clearance	
12.5, 13, 14 hp	0.040—0.072 mm (0.0016—0.0028 in.)
15 hp	0.040—0.085 mm (0.0015—0.0002 in.)
Oil Control Ring-To-Groove Side Clearance	
12.5, 13, 14 hp	0.551—0.675 mm (0.0217—0.0266 in.)
15 hp	0.176—0.026 (0.0069—0.0010 in.)
Top and Center Compression Ring End Gap	
New Bore:	
12.5, 13, 14 hp	0.3—0.5 mm (0.012—0.020 in.)
15 hp	0.27—0.51 mm (0.010—0.020 in.)
Used Bore (Maximum)	
All	0.77 mm (0.030 in.)



REPAIR SPECIFICATIONS (Continued)

Piston Thrust Face OD:

New:

12.5, 13, 14 hp 86.941—86.959 mm (3.4229—3.4236 in.)

15 hp 89.951—89.969 mm (3.5413—3.5420 in.)

Minimum:

12.5, 13, 14 hp 86.814 mm (3.4179 in.)

15 hp 89.824 mm (3.5363 in.)

Piston Thrust Face-To-Cylinder Bore Clearance

New:

12.5, 13, 14 hp 0.041—0.044 mm (0.0016—0.0017 in.)

15 hp 0.031—0.043 mm (0.0012—0.0016 in.)

Connecting Rod:

Crankpin End Clearance

New 0.030—0.055 mm (0.0012—0.0022 in.)

Maximum 0.07 mm (0.0025 in.)

Side 0.18—0.41 mm (0.007—0.016 in.)

Piston Pin Clearance 0.015—0.028 mm (0.0006—0.0011 in.)

Piston Pin End ID:

New 19.015—19.023 mm (0.7486—0.7489 in.)

Maximum 19.036 mm (0.7495 in.)

Governor::

Crankcase Cross Shaft Bore ID:

New 6.025—6.050 mm (0.2372—0.2382 in.)

Maximum 6.063 mm (0.2387 in.)

Cross Shaft OD:

New 5.975—6.000 mm (0.2352—0.2362 in.)

Minimum 5.962 mm (0.2347 in.)

Crankcase Bore-To-Cross Shaft Clearance . . . 0.025—0.075 mm (0.0010—0.0030 in.)

Gear Shaft OD:

New 5.990—6.000 mm (0.2358—0.2362 in.)

Minimum 5.977 mm (0.2353 in.)

Gear Shaft-To- Gear Bore Clearance 0.015—0.140 mm (0.0006—0.0055 in.)



TORQUE SPECIFICATIONS

(Alphabetical Order)

Air Cleaner Base Nut	9.9 N•m (88 lb-in.)
Cylinder Head Cap Screw	41 N•m (30 lb-ft.)
Connecting Rod Cap Screws:	
8mm Straight Shank Bolt	22.6 N•m (200 lb-in.)
Step Down Shank Bolt	14.6 N•m (130 lb-in.)
6mm Straight Shank Bolt	11.3 N•m (100 lb-in.)
Engine Mounting Cap Screws	27.1—46.2 N•m (240—408 lb-in.)
Fan Cap Screw	9.9 N•m (88 lb-in.)
Flywheel Cap Screw	68 N•m (50 lb-ft)
Fuel Pump/Cover Screw	
New Installation (Thread Forming)	9.0 N•m (85 lb-in.)
Replacement	7.3 N•m (65 lb-in.)
Fuel Bowl Nut	4.0 N•m (35 lb-in.)
Governor Control Panel Screw	9.9 N•m (88 lb-in.)
Ignition Module Screw	
New Installation (Thread Forming)	6.2 N•m (55 lb-in.)
Replacement	4.0 N•m (35 lb-in.)
Muffler Nut	24.4 N•m (216 lb-in.)
Oil Filter	5.7—9.0 N•m (50—80 lb-in.)
Oil Filter Drain Plug	7.3—9.0 N•m (65—80 lb-in.)
Oil Pan Cap Screw	24.4 N•m (216 lb-in.)
Oil Pump Cover Screw	
New Installation (Thread Forming)	6.2 N•m (55 lb-in.)
Replacement	4.0 N•m (35 lb-in.)
Rocker Arm Pivot Cap Screw	14 N•m (124 lb-in.)
Spark Plug	38—43.4 N•m (28—32 lb-ft)
Stator Cap Screw	4.0 N•m (35 lb-in.)
Valve Cover Cap Screw	
New Installation (Thread Forming)	10.7 N•m (95 lb-in.)
Replacement	7.3 N•m (65 lb-in.)



SERVICE EQUIPMENT AND TOOLS

Order tools from your SERVICEGARD Catalog.
Some tools may be available from a local supplier.

Name	Use
Valve Spring Compressor	Remove and install valve springs
Telescoping Gauge	Measure valve guides Measure inside diameter of parts.
Outside Micrometer	Measure valve stem Measure outside diameter of parts. Measure camshaft journals & lobes
Valve Guide Reamer	Ream valve guides
Valve Seat Cutter	Cut valve seats
Dial Indicator	Check push rods and valves for bend Measure crankshaft end play.
Vacuum Cup Tool	Lap valve
Strap Wrench	Hold flywheel
Telescoping Gauge	Measure camshaft bearing surface Measure cylinder I.D.
Ridge Reamer	Clean cylinder bore.
Piston Ring Expander	Remove and install piston rings.
Ring Compressor	Install piston.
Ring Groove Cleaner	Clean piston ring grooves.
Seal Driver	Install oil seals.
Cylinder Hone	Bore cylinder block.
Flex Hone	Deglaze/crosshatch cylinder.
Oil Pressure Test Kit	Perform Oil Pressure Test



ESSENTIAL TOOLS

Number	Name	Use
D20020W1	Standard Size Valve Guide Reamer (7.05 mm)	Clean or size valve guide to original size.
D05351ST	Spark Tester	Tests spark plug
JDG705	Oversize Valve Guide Reamer (7.25 mm)	Bores valve guide to proper size for oversize valve.

OTHER MATERIALS

Number	Name	Use
	RTV Silicone Sealant	Seal valve cover.
	Prussian Blue Compound	Check valve seat contact.
	Valve Lap Compound	Lap valves.
	SCOTCH-BRITE® Pad	Clean cylinder head.
	Zinc Oxide/Wood Alcohol	Check block for cracks.

SCOTCH-BRITE® is a trademark of the 3M Company.

SERVICE PARTS KITS

The following kit is available through your parts catalog:

Camshaft Shim Kit, Oversize Piston and Ring Kits, Undersize Connecting Rod, Oil Pressure Test Kit.

**Thank you very much
for your reading.**

Please Click Here

**Then Get More
Information.**