

# Owner's Manual and Installation Instructions

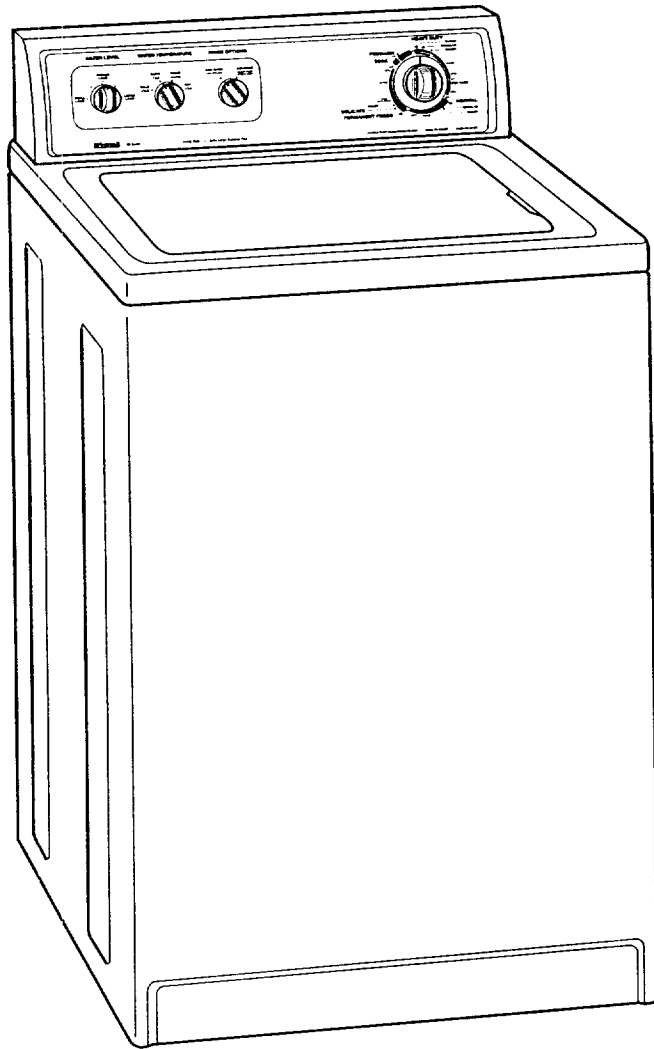

## Two-Speed AUTOMATIC WASHERS



**IMPORTANT:**  
Read and follow all safety  
and operating instructions  
before first use of this product.

Your washer may look different  
from the washer shown.

Sears, Roebuck and Co., Hoffman Estates, IL 60179 U.S.A.

PART NO. 3950146 Rev. B PRINTED IN U.S.A.

WARRANTY/SAFETY

INSTALLATION

OPERATION

LAUNDRY TIPS

MAINTENANCE

TROUBLESHOOTING

SERVICE

ESPAÑOL

## TABLE OF CONTENTS

BEFORE USING YOUR NEW WASHER .....	2
SEARS AUTOMATIC WASHER WARRANTY .....	3
IMPORTANT SAFETY INSTRUCTIONS .....	4
INSTALLATION INSTRUCTIONS .....	5
OPERATING YOUR WASHER .....	20
LAUNDRY TIPS .....	28
CARING FOR YOUR WASHER .....	30
TROUBLESHOOTING .....	31
SEARS MAINTENANCE AGREEMENT .....	35

## BEFORE USING YOUR NEW WASHER

Please read this manual. It will help you install and operate your new Kenmore washer in the safest and most economical way.

For more information about the care and operation of Kenmore appliances call your nearest Sears store. You will need the complete model and serial numbers when requesting information. Your washer's model and serial numbers are located on the Model and Serial Number Plate.

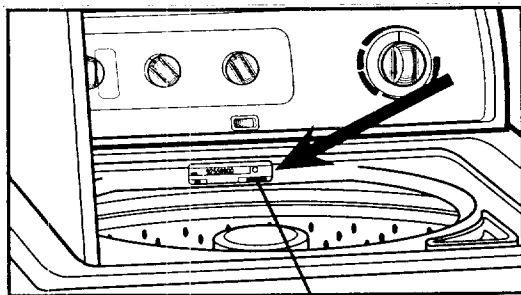

Model and Serial Number Plate

Use the space below to record the model number and serial number of your new Kenmore Washer.

Model No. \_\_\_\_\_

Serial No. \_\_\_\_\_

Date of Purchase \_\_\_\_\_

Keep this book and your Sears Salescheck (receipt) in a safe place for future reference.

## SEARS AUTOMATIC WASHER WARRANTY

WARRANTY/SAFETY

### FULL 1-YEAR WARRANTY ON MECHANICAL AND ELECTRICAL PARTS

For one year from the date of purchase, when the washer is installed and operated in accordance with the instructions in the Owner's Manual, Sears will repair or replace any mechanical or electrical parts in this washer, if defective in material or workmanship.

### LIMITED 5-YEAR WARRANTY ON GEARCASE PARTS

After one year and until five years from the date of purchase, Sears will furnish replacement parts for any defective gearcase parts. You will be charged for labor.

### LIMITED 10-YEAR WARRANTY ON PLASTIC TUB

After one year and until ten years from date of purchase, Sears will furnish a replacement plastic tub for any plastic tub which is defective in material or workmanship. You will be charged for labor.

If the washer is subjected to other than private family use, the above warranty coverage is effective for only 90 days.

WARRANTY SERVICE IS AVAILABLE BY CONTACTING THE NEAREST SEARS SERVICE CENTER IN THE UNITED STATES.

This warranty applies only while this product is in use in the United States. This warranty gives you specific legal rights, and you may also have other rights which vary from state to state.

Sears Roebuck and Co., Dept. 817WA,  
Hoffman Estates, IL 60179.

### Your safety and the safety of others is very important.

We have provided many important safety messages in this manual and on your appliance. Always read and obey all safety messages.



This is the safety alert symbol. This symbol alerts you to hazards that can kill or hurt you and others. All safety messages will be preceded by the safety alert symbol and the word "DANGER" or "WARNING." These words mean:

**! DANGER**

You will be killed or seriously injured if you don't follow instructions.

**! WARNING**

You can be killed or seriously injured if you don't follow instructions.

All safety messages will identify the hazard, tell you how to reduce the chance of injury, and tell you what can happen if the instructions are not followed.

## IMPORTANT SAFETY INSTRUCTIONS

### YOUR SAFETY IS IMPORTANT TO US

**WARNING:** To reduce the risk of fire, electric shock, or injury to persons when using your washer, follow basic precautions, including the following:

- Read all instructions before using the washer.
- Do not wash articles that have been previously cleaned in, washed in, soaked in, or spotted with gasoline, dry-cleaning solvents, other flammable or explosive substances as they give off vapors that could ignite or explode.
- Do not add gasoline, dry-cleaning solvents, or other flammable or explosive substances to the wash water. These substances give off vapors that could ignite or explode.
- Under certain conditions, hydrogen gas may be produced in a hot water system that has not been used for 2 weeks or more. **HYDROGEN GAS IS EXPLOSIVE.** If the hot water system has not been used for such a period, before using a washing machine, turn on all hot water faucets and let the water flow from each for several minutes. This will release any accumulated hydrogen gas. As the gas is flammable, do not smoke or use an open flame during this time.
- Do not allow children to play on or in the washer. Close supervision of children is necessary when the washer is used near children.
- Before the washer is removed from service or discarded, remove the lid.
- Do not reach into the washer if the tub or agitator is moving.
- Do not install or store this washer where it will be exposed to the weather.
- Do not tamper with controls.
- Do not repair or replace any part of the washer or attempt any servicing unless specifically recommended in the Owner's Manual or in published user-repair instructions that you understand and have the skills to carry out.

### SAVE THESE INSTRUCTIONS

**IMPORTANT:** Observe all governing codes and ordinances.

# INSTALLATION INSTRUCTIONS

## INSTALLATION OVERVIEW

For a complete list of tools and parts needed, see pages 6-8.

### A. SELECT LOCATION FOR YOUR WASHER (pgs. 10-12)

Recessed Area/  
Closet Installation Instructions (p. 10)

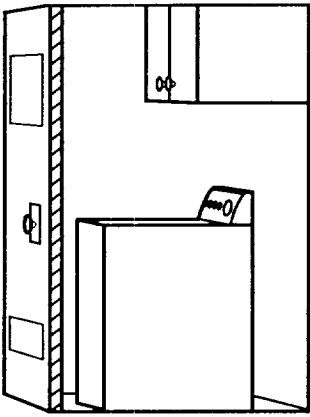

### Laundry Tub Drain System (p. 11)

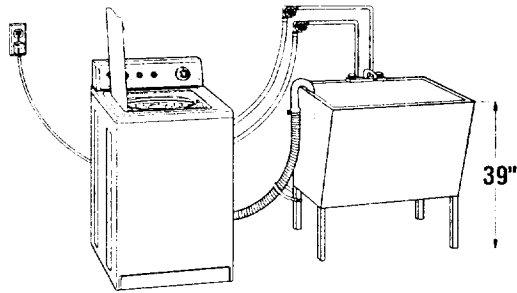

### Standpipe Drain System (p. 12)

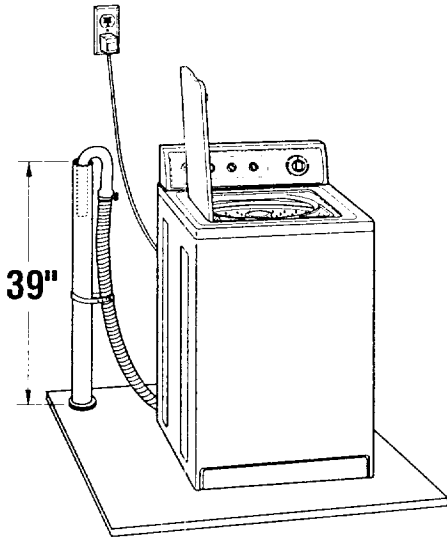

### Floor Drain System (p. 12)

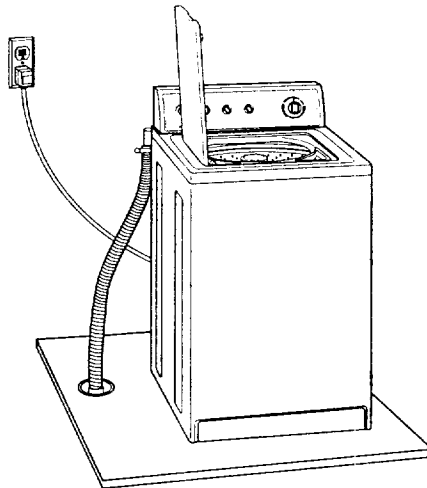

INSTALLATION

**B. REMOVE SHIPPING STRAP (p. 13)**

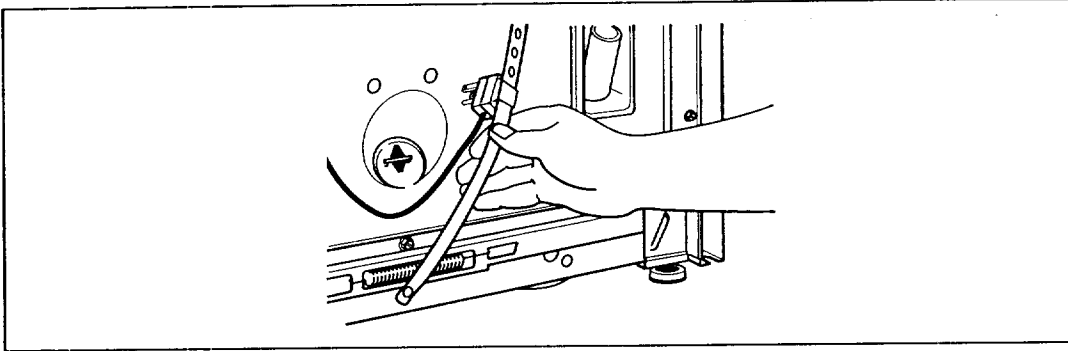

**Tools Needed:**

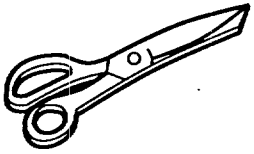

Scissors

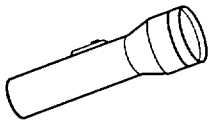

Flashlight (optional depending on installation)

**C. CONNECT DRAIN HOSE (pgs. 14-15)**

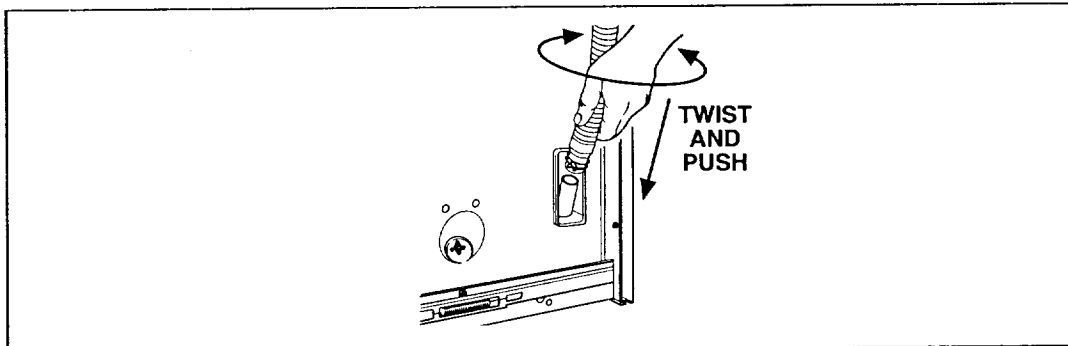

**Tools Needed:**

**Parts Needed:**

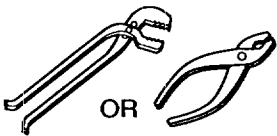

Pliers that open to 1<sup>9</sup>/<sub>16</sub> inches

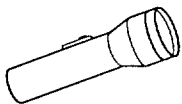

Flashlight (optional depending on installation)

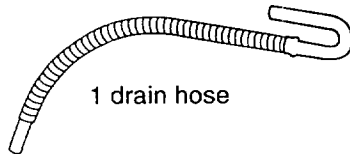

1 drain hose



1 yellow, single-wire hose clamp (top of drain hose)

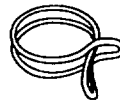

1 silver, double-wire hose clamp (bottom of drain hose)

**D. CONNECT INLET HOSES TO WASHER (pgs. 15-16)**

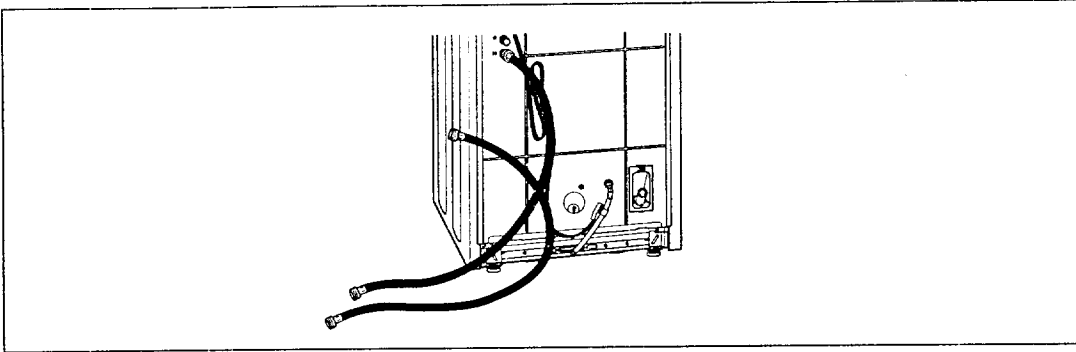

**INSTALLATION**

**Tools Needed:**

**Parts Needed:**

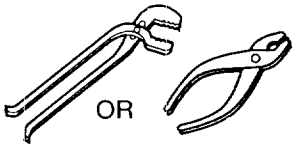

Pliers that open to 1<sup>3</sup>/<sub>16</sub> inches

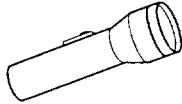

Flashlight (optional depending on installation)

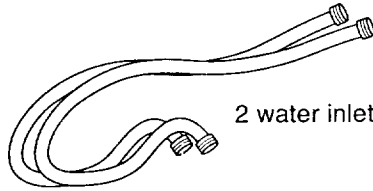

2 water inlet hoses

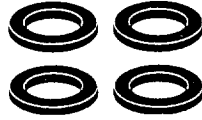

4 flat water inlet hose washers

**E. CONNECT INLET HOSES TO WATER FAUCETS (p. 16)**

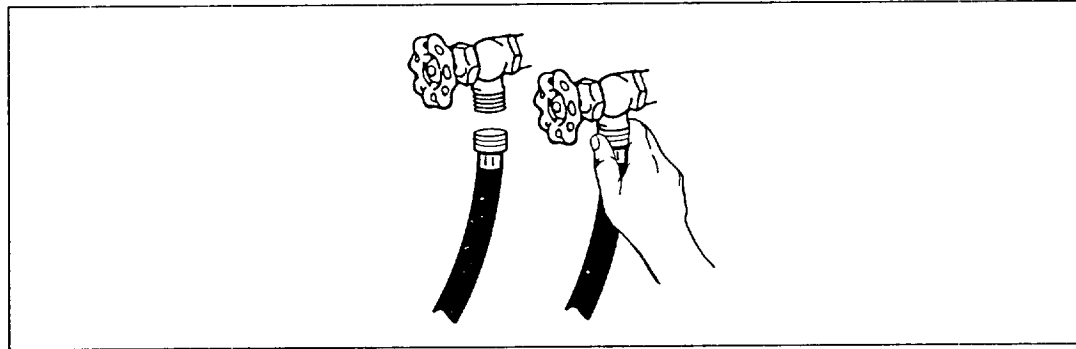

**Tools Needed:**

**Parts Needed:**

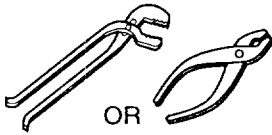

Pliers that open to 1<sup>3</sup>/<sub>16</sub> inches

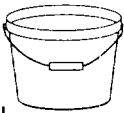

Bucket (optional depending on installation)

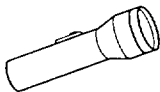

Flashlight (optional depending on installation)

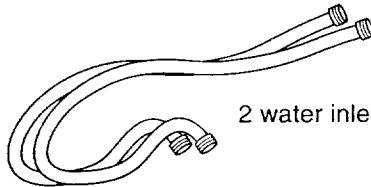

2 water inlet hoses

**F. SECURE DRAIN HOSE (p. 17)**

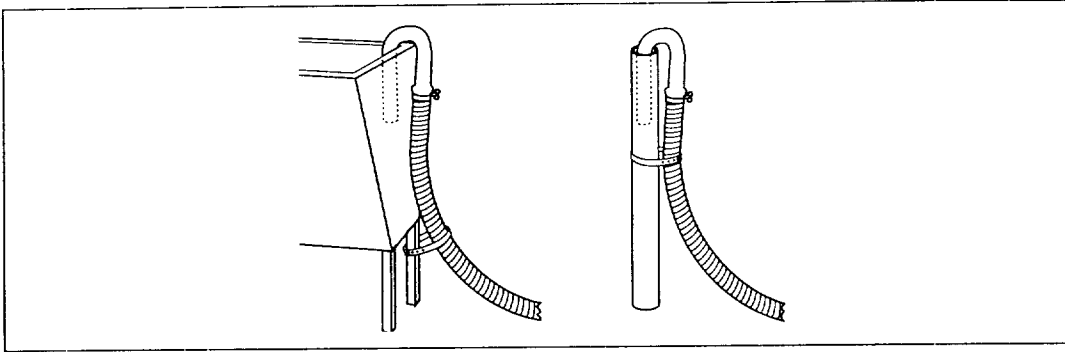

**Tools Needed:**

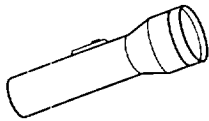

Flashlight (optional depending on installation)

**Parts Needed:**

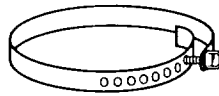

Shipping strap with fastener

**G. LEVEL WASHER (p. 18)**

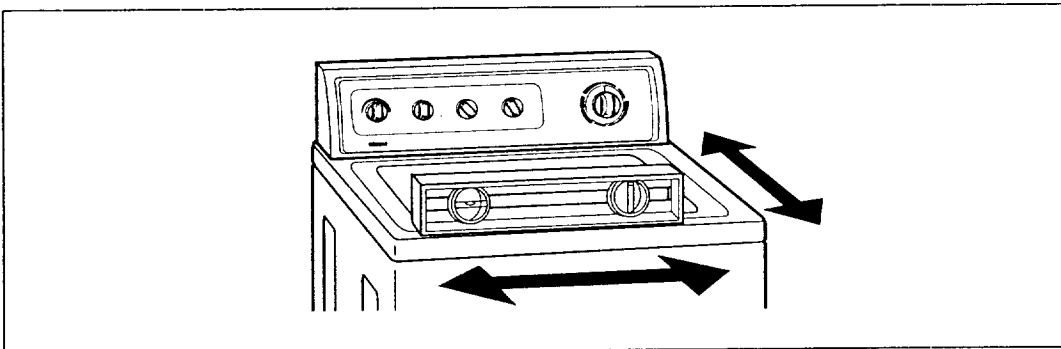

**Tools Needed:**

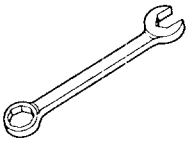

9/16-Inch open-end wrench

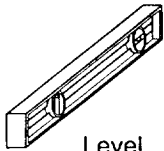

Level



Flashlight (optional depending on installation)

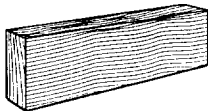

Wood block

**Parts Needed:**

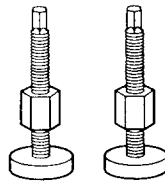

2 front leveling legs with nuts



## for your **Benefit**

Selecting the proper location for your washer will improve its performance and minimize concerns like washer walk or noise.

### ELECTRICAL REQUIREMENTS

120-Volt, 60-Hz., AC-only, 15- or 20-ampere fused electrical supply is required. (Time-delay fuse or circuit breaker is recommended.) Connect to individual branch circuit.

## ⚠ WARNING



### Electrical Shock Hazard

**Plug into a grounded 3-prong outlet.**  
**Do not remove ground prong.**  
**Do not use an adapter.**  
**Do not use an extension cord.**  
**Failure to follow these instructions can result in death, fire, or electrical shock.**

### GROUNDING INSTRUCTIONS

**WARNING:** Improper connection of the equipment grounding conductor can result in a risk of electric shock. Check with a qualified electrician or serviceman if you are in doubt as to whether the appliance is properly grounded. Do not modify the plug provided with the appliance – if it will not fit the outlet, have a proper outlet installed by a qualified electrician.

For your personal safety, this washer must be grounded. In the event of malfunction or breakdown, grounding will reduce the risk of electric shock by providing a path of least resistance for electric current.

This washer is equipped with a power supply cord having a 3-prong grounding plug. To minimize possible shock hazard, you must plug the power supply cord into a mating 3-prong grounding-type wall receptacle, grounded in accordance with National Electrical Code, ANSI/NFPA 70-latest edition and all local codes and ordinances.

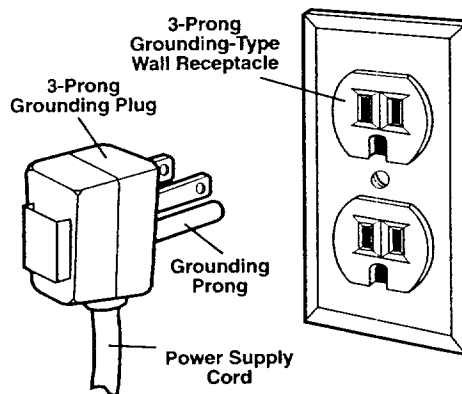

**A. SELECT LOCATION  
FOR YOUR WASHER –**

**RECESSED AREA/  
CLOSET INSTALLATION INSTRUCTIONS**

This washer may be installed in a recessed area or closet.

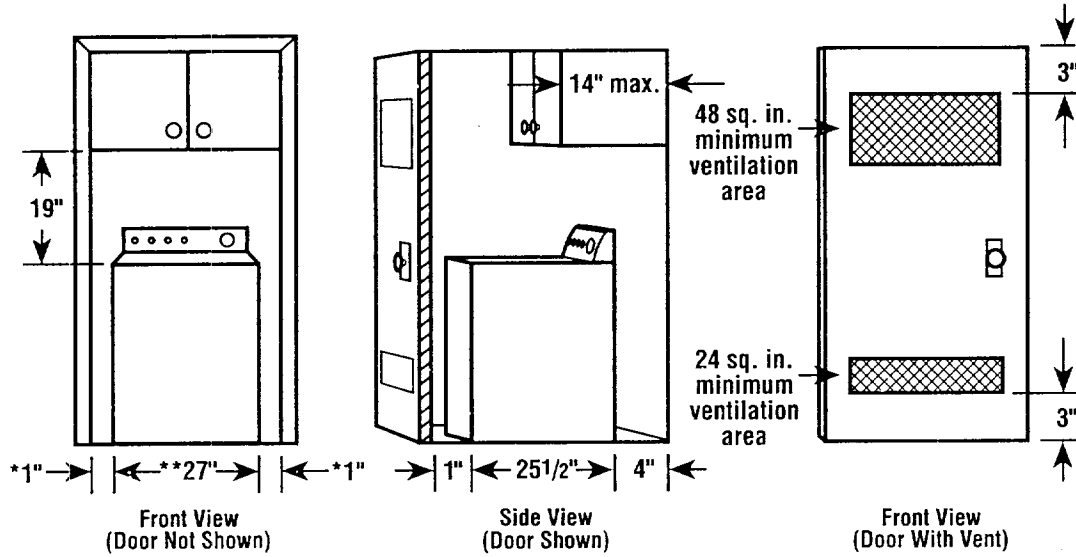

\*Additional clearance for wall, door and floor moldings may be required.  
To reduce transfer of washer sounds, a clearance of 1 inch on the sides of the washer is recommended.  
\*\*Washer width can be 24" or 27" depending on model selected.

- The installation spacing is in inches and is the minimum allowable.
- Allow additional space if other appliances are to be installed in the area.
- If closet door is installed, the minimum air openings in top and bottom are required. Louvered doors with equivalent air openings in top and bottom are acceptable.

## LAUNDRY TUB DRAIN SYSTEM

Check location where washer will be installed. This washer can be installed using one of three systems:

- Laundry tub drain system (below)
- Standpipe drain system (p. 12)
- Floor drain system (p. 12)

Do not store or operate washer at or below 32°F (some water may remain in washer). See page 30 for Winterizing Information.

Proper installation is your responsibility. Make sure you have everything necessary for correct installation including the following points:

INSTALLATION

**Grounded receptacle:** Must be within 4 feet of where the power cord is attached to the back of the washer.

**Hot and cold water faucets:** Must be within 4 feet of the hot and cold water fill valves attached to the back of the washer and provide water pressure between 5-100 P.S.I.

**Water heater:** To get the best washing results, set water heater to deliver 140°F water to washer.

**Laundry tub drain system:** Needs a minimum 20-gallon laundry tub.

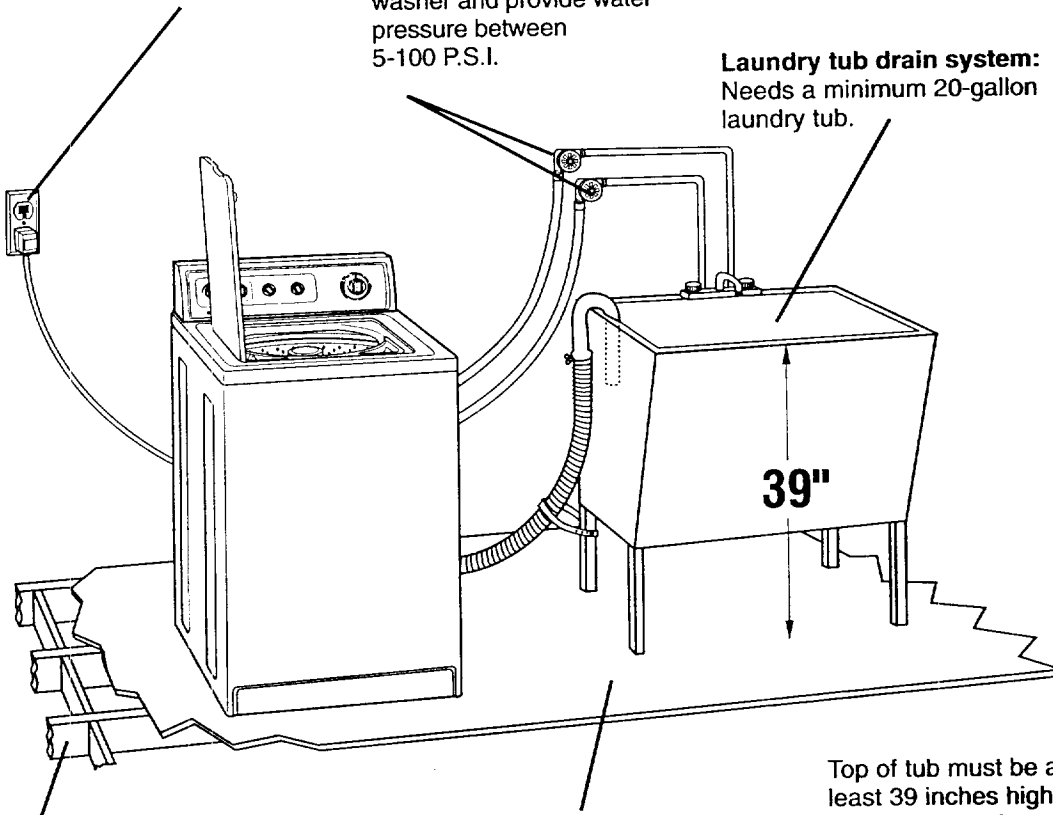

**Support:** Floor must be sturdy enough to support a total weight of 315 pounds (including washer, water, and load weight).

**Level floor:** Maximum allowable slope under entire washer – 1 inch.

Top of tub must be at least 39 inches high and no higher than 96 inches from bottom of washer.

## ALTERNATE LOCATIONS – STANDPIPE AND FLOOR DRAIN SYSTEMS

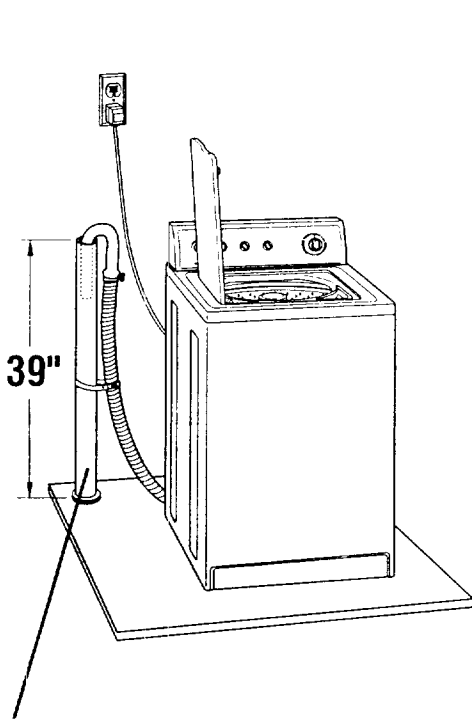

**Standpipe drain system:** Needs a two-inch minimum diameter standpipe with minimum carry-away capacity of 17 gallons per minute. Top of standpipe must be at least 39 inches high and no higher than 96 inches from bottom of washer.

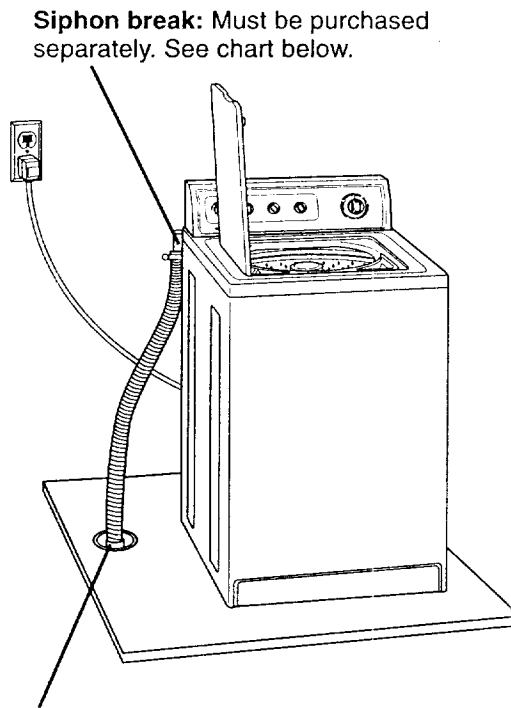

**Floor drain system:** Requires a siphon break, see chart below. A minimum carry-away capacity of 17 gallons per minute is required.

**Siphon break:** Must be purchased separately. See chart below.

<b>If you have:</b>	<b>You will need to buy:</b>
Laundry tub or standpipe higher than 96 inches	Sump pump system (if not already available)
1-inch diameter standpipe	2-inch diameter to 1-inch diameter standpipe adapter, Part No. 3363920
Overhead sewer	Standard 20 gallon, 39-inch high drain tub or utility sink and sump pump (available from local plumbing suppliers)
Floor drain	Siphon break, Part No. 285320; additional drain hose, Part No. 3357090; and Connector Kit, Part No. 285442

Parts listed are available from your local Sears store or Sears Service Center. Call 1-800-366-PART (1-800-366-7278).

## B. REMOVE SHIPPING STRAP

### for your Benefit

Removing the shipping strap is necessary for smooth operation. If the shipping strap is not removed, the washer will make excessive noise.

To prevent floor damage, set washer onto cardboard before moving across floor. Move washer close to its final location.

**STEP 1.** Read, then remove the label over the electrical plug and shipping strap.

**STEP 2.** Pull the yellow shipping strap completely out of the washer. There should be three cotter pins on the end of the shipping strap when it is pulled out of the washer. The electrical plug is attached to this shipping strap.

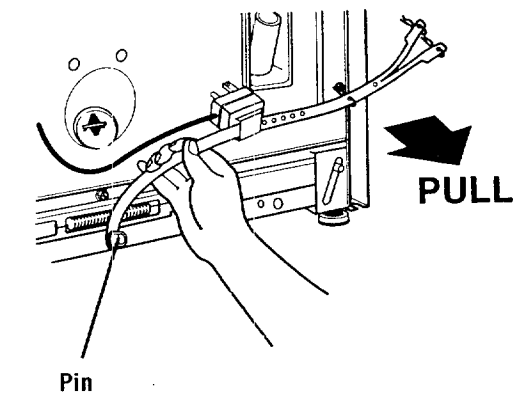
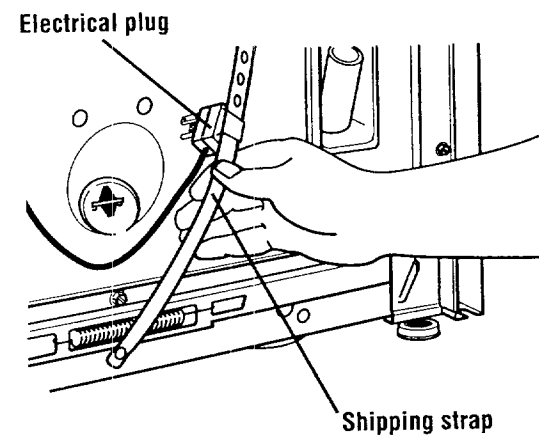

**STEP 3.** Pull firmly to remove the end of the shipping strap that remains pinned to the back of washer. This will release the rear self-leveling legs.

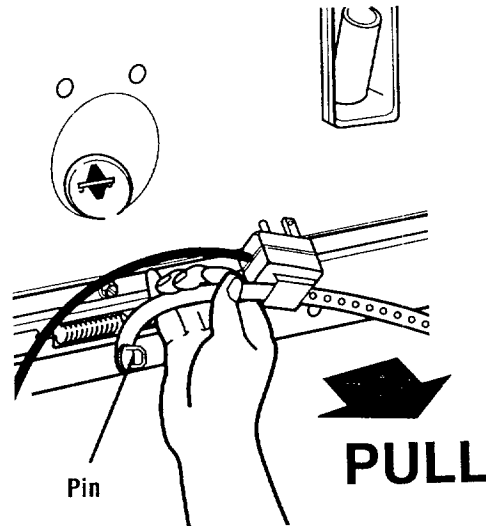

INSTALLATION

**STEP 4.** Cut the shipping strap about 16 inches from plug end. Look for the words "CUT HERE." Remove shipping strap from the electrical plug.

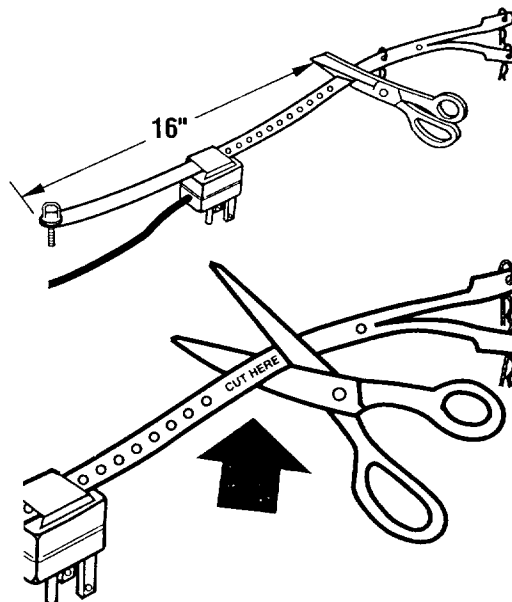

**NOTE:** For use in securing the drain hose, save the end of the shipping strap that does not have the three cotter pins. Discard the rest.

## C. CONNECT DRAIN HOSE

### *for your* **Benefit**

Proper connection of the drain hose will protect your floors from damage due to water leakage.

**STEP 1.** To prevent the drain hose from coming off or leaking, it must be installed per the following instructions:

**IMPORTANT:** This procedure must be followed to ensure proper installation.

- Wet the inside of the straight end of the drain hose with tap water. **DO NOT USE ANY OTHER LUBRICANT.**
- Squeeze ears of silver, double-wire clamp with pliers to open. Place clamp over the straight end of the drain hose  $\frac{1}{4}$  inch from the end.

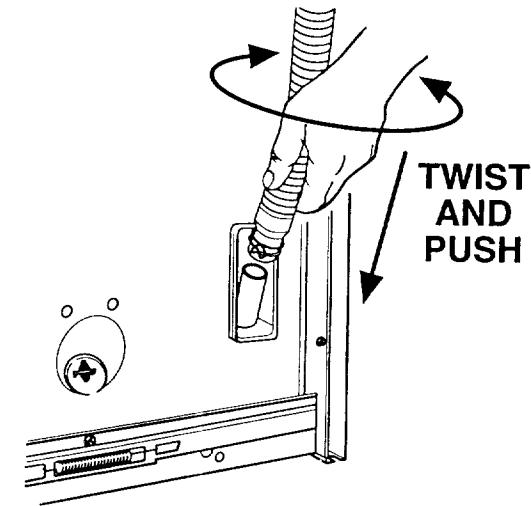
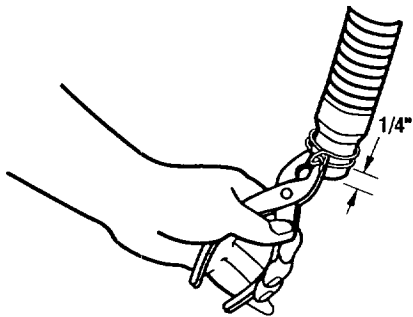

- Place clamp over area marked "CLAMP." Release clamp.

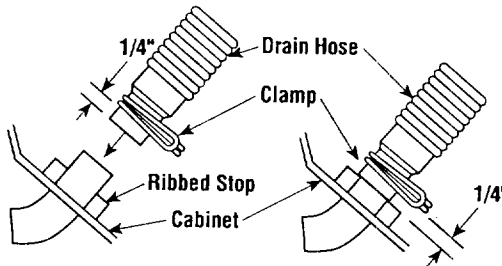

- Open clamp. Twist hose back and forth while pushing down onto drain connector at the bottom of the washer. Continue until hose contacts the ribbed stop on the cabinet.

If you have:	You will need to buy:
Drain hose that is too short	Drain hose, Part No. 388423 and hose kit, Part No. 285442
Drain hose that is too long	Hose kit, Part No. 285442
A problem with lint clogging your drain	Drain protector, Part No. 367031

Parts listed are available from your local Sears store or Sears Service Center. Call 1-800-366-PART (1-800-366-7278).

For standpipe or laundry tub drain systems:

**STEP 2.** Open yellow, single-wire clamp with pliers and slide over hooked end of drain hose to secure the rubber and corrugated sections together.

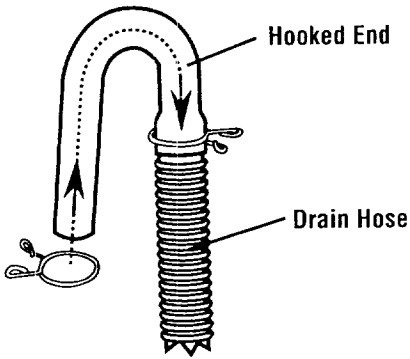

**STEP 3.** Put hooked end of drain hose into laundry tub or standpipe. Check for proper length of drain hose. Rotate hook to eliminate kinks.

To prevent drain water from going back into the washer:

- Do not straighten hooked end of drain hose and force excess drain hose into standpipe.
- Do not lay excess drain hose in bottom of laundry tub.

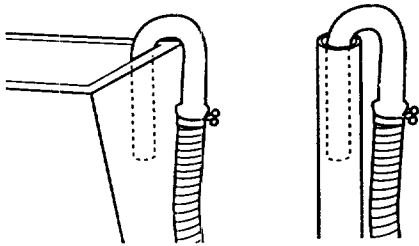

## D. CONNECT INLET HOSES TO WASHER

### for your Benefit

Proper connection of your inlet hoses will allow hot and cold water to enter your washer properly. It also helps prevent water damage due to leaks.

INSTALLATION

### ! WARNING



#### Slip and Fall Hazard

Use new water inlet hoses.  
Failure to do so can result in head injury or broken bones.

**NOTE:** Replace inlet hoses after five years of use to reduce the risk of hose failure. Periodically inspect and replace inlet hoses if bulges, kinks, cuts, wear, or leaks are found. When replacing your inlet hoses, mark the date of replacement on the label with a permanent marker.

**STEP 1.** Insert one new, flat washer (from the parts bag) into each end of the inlet hoses. Check that washers are firmly seated in couplings.

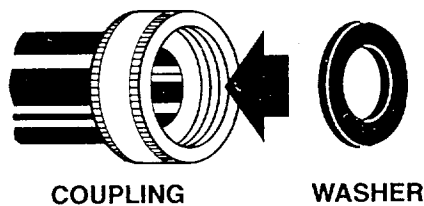

**STEP 2.** Attach the hose with the red coupling to the hot water (bottom) inlet valve. Attaching the red coupling first makes it easier to tighten connection with pliers. Screw on coupling by hand. Make an additional two-thirds turn with pliers to tighten coupling. **DO NOT OVERTIGHTEN;** this could damage the valves.

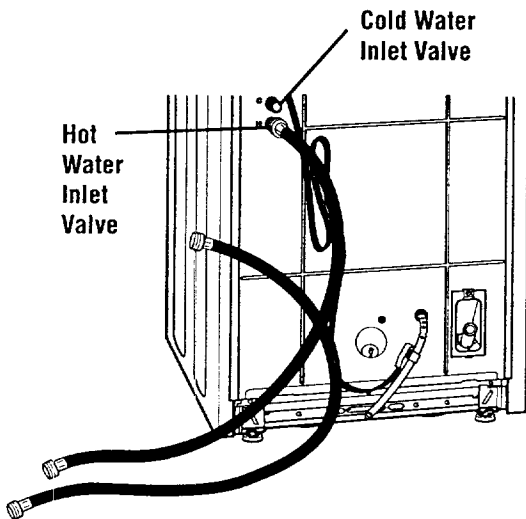

**STEP 3.** Attach the hose with the blue coupling to the cold water (top) inlet valve. Screw on coupling by hand. Make an additional two-thirds turn with pliers to tighten coupling. **DO NOT OVERTIGHTEN;** this could damage valves.

## E. CONNECT INLET HOSES TO WATER FAUCETS

**STEP 1.** Make sure washer basket is empty. Run water through both faucets into a bucket or laundry tub to get rid of particles in the water lines that might clog hoses. Determine which faucet is hot and which is cold. Mark the hot water faucet.

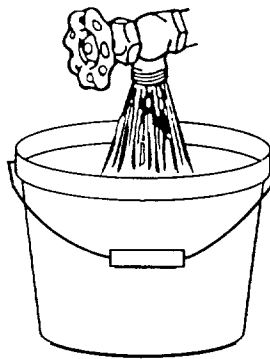

**STEP 2.** Attach the hose with the red coupling to the hot water faucet. Screw on coupling by hand. Make an additional two-thirds turn with pliers to tighten coupling. **DO NOT OVERTIGHTEN;** this could damage the coupling.

**STEP 3.** Attach the hose with the blue coupling to the cold water faucet. Screw on coupling to faucet by hand. Make an additional two-thirds turn with pliers to tighten coupling. **DO NOT OVERTIGHTEN;** this could damage the coupling.

**STEP 4.** Turn on water faucets and check for leaks. A small amount of water may enter the washer. You will drain this later.

If you have:	You will need to buy:
Water faucets beyond the reach of water fill hoses	2 longer water fill hoses: 6 ft. hoses, Part No. 76314 or 10 ft. hoses, Part No. 350008

Parts listed are available from your local Sears store or Sears Service Center. Call 1-800-366-PART (1-800-366-7278).



## F. SECURE DRAIN HOSE

### *for your* **Benefit**

Securing the drain hose properly will protect your floors from damage due to water leakage.

**STEP 1.** Move washer to its final location.

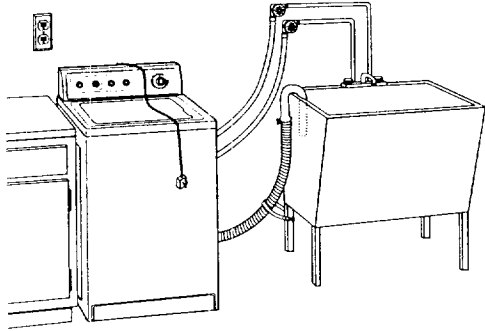

**STEP 2.** Use the shipping strap you cut and removed (without the three cotter pins) and tightly wrap it around the drain hose and laundry tub or standpipe. Push fastener into the nearest hole in the shipping strap.

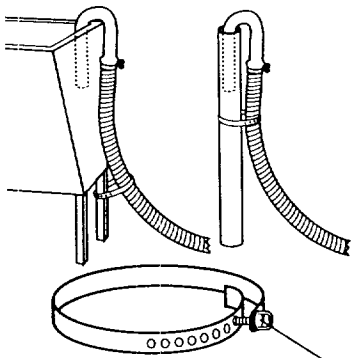

Fastener

If the water faucets and drain standpipe are recessed, put hooked end of drain hose in standpipe. Tightly wrap the shipping strap around the drain hose and water inlet hoses (not the handles or stems). Push fastener into the nearest hole in the shipping strap.

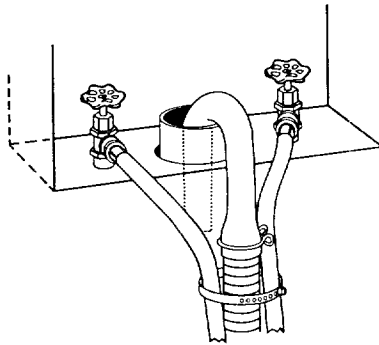

INSTALLATION

## G. LEVEL WASHER

### for your **Benefit**

Leveling your washer properly prevents excessive noise and vibration.

#### To install front legs:

**STEP 1.** Prop front of washer up (about 4 inches). Use a wood block or another object that will support the weight of the washer. If washer was placed against a wall, move the washer out slightly before tipping it up.

**STEP 2.** With one of the legs in hand, screw lock nut onto leg  $\frac{3}{8}$  inch from top of leg base. This is the recommended initial setting.

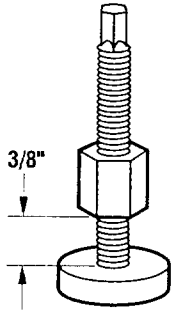

**STEP 3.** Screw leg into washer base by hand until nut reaches washer base. Repeat for other leg.

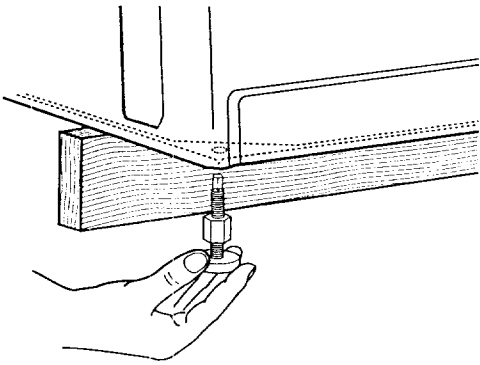

**STEP 4.** Tilt washer backward until front of washer is off the wood block. Remove wood block. Gently lower washer to floor.

**STEP 5.** Move washer to its final location.

**STEP 6.** Tilt washer forward until rear of washer is at least 3 inches off floor. You may hear the self-adjusting rear legs click into place. Lower washer to floor. Check levelness of the washer by placing a level on top of the washer, first side-to-side; then front-to-back.

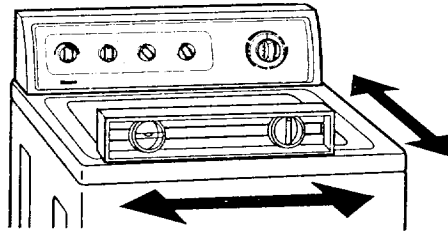

**STEP 7.** If washer is not level, prop up the front of the washer and adjust the legs up or down as necessary. Lower washer and reset self-adjusting rear legs (as in Step 6). Repeat Step 7 until the washer is level.

**STEP 8.** When washer is in its final location and level, use a  $\frac{9}{16}$ -inch open-end wrench to turn nuts on front legs tightly against washer cabinet. If nuts are not tight against washer cabinet, the washer may vibrate.

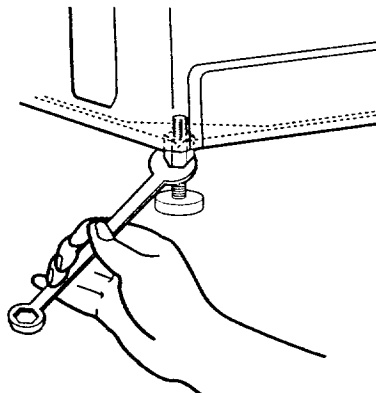

## REVIEW INSTALLATION

### *for your* **Benefit**

Take a few minutes to complete this checklist. It will help assure you that you have a proper installation and increase your satisfaction with your Kenmore washer.

- Check electrical requirements. Be sure you have correct electrical supply and recommended grounding method.
- Check that you have:
  - All the tools you started with.
  - Removed all packaging materials.
  - Removed shipping strap with three cotter pins.
  - Installed all parts listed on pages 6-8.
- Check that:
  - The washer is level.
  - The nuts on the front legs are tight.
- Check that the water faucets are turned on.

INSTALLATION

---

## FINAL STEPS

- Plug power supply cord into grounded outlet.
- Remove the blue protective film on the console and any tape remaining on washer.
- Take a few minutes and read the Operating Instructions (pages 20-27) to fully understand your new washer. Then, start the washer and allow it to complete the NORMAL Cycle.

# OPERATING YOUR WASHER

## for your Benefit

To get the maximum cleaning and fabric care from your washer, please read and follow these instructions.

**NOTE:** The drawings in this section show the basic features of all models covered by this manual. Refer to the supplied "Feature Sheet" for your washer's particular features.

## ⚠ WARNING



### Explosion Hazard

Never place items in the washer that are dampened with gasoline or other flammable fluids.

No washer can completely remove oil.

Do not dry anything that has ever had any type of oil on it (including cooking oils).

Failure to follow these instructions can result in death, explosion, or fire.

## STARTING WASHER

**STEP 1.** Add measured detergent directly into washer basket. Then place a load of sorted clothes in the washer.

**STEP 2. (OPTIONAL STEP)** If desired, add measured liquid chlorine bleach to the liquid bleach dispenser (if available); (see page 25).

**STEP 3. (OPTIONAL STEP)** If desired, add measured liquid fabric softener to the fabric softener dispenser (if available); (see page 26).

**STEP 4.** Close washer lid.

**STEP 5.** Set WATER LEVEL Control **A** based on the size of your wash load.

**STEP 6.** Set the WATER TEMPERATURE Control **B**.

**STEP 7.** Set RINSE OPTIONS Control (if available); **C** (see page 23).

**STEP 8.** Push the Cycle Selector Control (Timer) Knob **D** and turn to the right. Set cycle and time according to the type of fabric in the load (see page 22).

**STEP 9.** Pull the Cycle Selector Control (Timer) Knob out. The dial will rotate as the cycle progresses. The knob will not rotate.

## STOPPING/RESTARTING WASHER

- To stop the washer at any time, push the Cycle Selector Control (Timer) Knob in.
- Pull the knob out to restart.

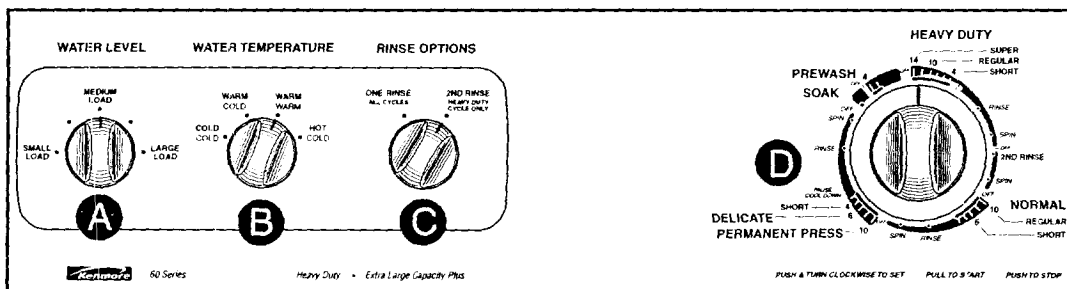

## SET WATER LEVEL CONTROL

### for your **Benefit**

This control gives you the flexibility to save water when washing small loads.

Your washer lets you select a water setting based on the size of your wash load.

- For normal loads, start with the MEDIUM LOAD Setting. Adjust up or down depending on your load. Clothes should move freely and roll toward the agitator.
- To change to a higher water level setting after the washer has started to agitate, turn the knob to the desired new setting.

#### WATER LEVEL

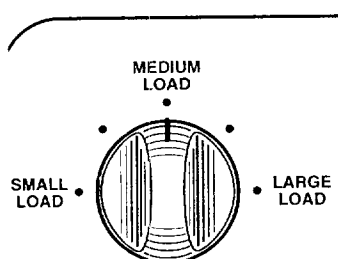

## SET WATER TEMPERATURE CONTROL

Your washer lets you select a wash and rinse water temperature setting based on the type of load you are washing.

Some washers allow you to select warm rinses:

- Using warm rinse water will leave loads dryer after the spin cycle than if you use cold rinse water. However, warm rinses may increase wrinkling when line drying.
- In cold climates, warm rinse water also provides a more comfortable temperature for handling the wash load.

#### WATER TEMPERATURE

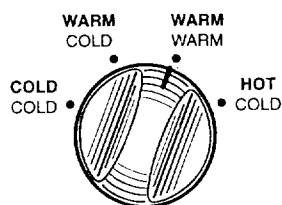

OPERATION

### SELECTING WATER TEMPERATURES

Wash Water Temperature	Suggested Fabrics	Comments
HOT 130°F or above	<ul style="list-style-type: none"> <li>• Work clothes</li> <li>• Sturdy whites/ colorfast pastels</li> <li>• Diapers</li> </ul>	<ul style="list-style-type: none"> <li>• Best cleaning for heavily soiled items</li> <li>• Removes oils, perspiration, greasy soils, and stains</li> <li>• Prevents graying or yellowing</li> </ul>
WARM 90°-110°F	<ul style="list-style-type: none"> <li>• Dark/non-colorfast colors</li> <li>• Permanent press items</li> <li>• Nylon, polyester, acrylics, silks, woolens</li> <li>• Knits/delicate fabrics</li> </ul>	<ul style="list-style-type: none"> <li>• Best for moderately soiled to lightly soiled items</li> <li>• Safe for most fabric finishes</li> <li>• Less fading and dye bleeding</li> <li>• Reduces wrinkling</li> </ul>
COLD* 70°-90°F	<ul style="list-style-type: none"> <li>• Extra-sensitive colors</li> <li>• Non-colorfast items</li> <li>• Hand washables</li> </ul>	<ul style="list-style-type: none"> <li>• Best for very lightly soiled items</li> <li>• Saves hot water</li> </ul>

\*In wash water temperatures colder than 70°F, detergents do not dissolve well. Also, soils may be difficult to remove and some fabrics may retain wear wrinkles and have increased pilling – the formation of small lint-like balls on the surface of garments. Pilling is the natural result of wearing and washing of garments.

## SETTING YOUR CYCLE SELECTOR (TIMER) CONTROL

Use this control to choose the agitation time and to start the washer. Each cycle is designed with the wash and spin speeds that are appropriate for the fabrics and soil levels in your wash load.

- For heavy soil and sturdy fabrics, use the full time (SUPER or REGULAR if indicated).
- For light soil and delicate fabrics, use less time (SHORT if indicated).

**NOTE:** Do not wash garments labeled Hand Wash in your washer. Garments that are labeled Hand Wash have:

- A fiber or construction that is sensitive to agitation.
- Sensitive dyes that may bleed.

Follow care label directions for drying. Items that may shrink should be dried flat. Block these items by gently stretching to original measurements. Woolens tend to shrink more the first time they are washed.

### PERMANENT PRESS

You can select up to 10 minutes of wash time.

### DELICATE

Use this cycle to get up to 6 minutes of wash time for lingerie and loosely knit items.

*for your* **Benefit**

The **PERMANENT PRESS/DELICATE** Cycles include a load cooling process that reduces wrinkling compared to other cycles.

- Wash combines slow speed agitation for gentle soil removal and slow spin speeds to reduce wrinkling.

**NOTE:** When the timer reaches PAUSE, the washer will drain and pause for no more than two minutes while some of the wash water is drained and replaced with rinse water.

### NORMAL

Use this cycle to get up to 10 minutes of wash time for normally soiled cottons and linens.

- Wash combines fast and slow speed agitation with fast spin speeds to shorten drying time.
- Selecting REGULAR gives you fast agitation speeds initially, then the washer steps down to a slow agitation speed.
- Selecting SHORT gives you slow agitation speed.

### HEAVY DUTY

Use this cycle to get up to 14 minutes of wash time for sturdy or heavily soiled loads.

- Wash combines fast speed agitation and fast spin speeds.

### PREWASH (on some models)

Use this cycle to get up to 4 minutes of agitation to help remove heavy soils and stains that need pretreatment. PREWASH Cycle should be followed by a HEAVY DUTY, NORMAL, or PERMANENT PRESS Cycle with additional detergent.

### SOAK (on some models)

SOAK Cycle features 4 minutes of agitation followed by an unlimited soak time to help remove heavy soils and stains that need pretreatment. You will need to reset the washer to a SPIN setting to remove water. SOAK Cycle should be followed by a HEAVY DUTY, NORMAL, PERMANENT PRESS or PREWASH Cycle with additional detergent.

**NOTE:** We do not recommend hot water for soaking. It may set some stains.

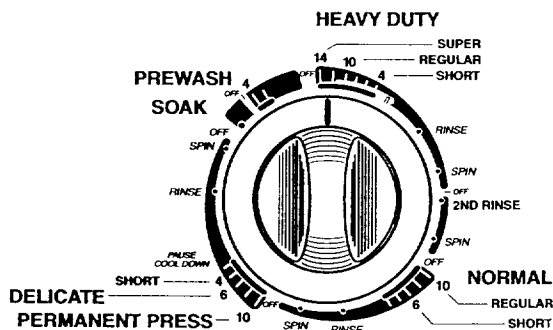

## AUTOMATIC 2ND RINSE

### for your Benefit

A second rinse will remove more detergent residue. It is especially beneficial if extra detergent has been used to remove heavy soils.

Washers with a RINSE OPTIONS Control allow you to automatically add a second rinse to the HEAVY DUTY Cycle.

Simply set the RINSE OPTIONS Control on 2ND RINSE before you start the washer. You won't have to come back to select a second rinse.

### RINSE OPTIONS

ONE RINSE  
ALL CYCLES

2ND RINSE  
HEAVY DUTY  
CYCLE ONLY

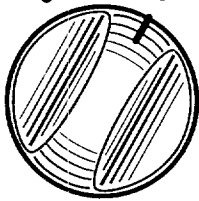

### MANUAL RINSE AND SPIN

When using extra detergent for heavily soiled clothes, or washing special-care items, you may find an extra rinse and spin is needed.

**STEP 1.** Set WATER LEVEL Control.

**STEP 2.** Set WATER TEMPERATURE Control.

**STEP 3.** Set RINSE OPTIONS Control (if available) to ONE RINSE.

**STEP 4.** Set the Cycle Selector Control (Timer) Knob to a RINSE setting:

- For fast agitation and spin, use the HEAVY DUTY Cycle.
- For slow agitation and spin, use the PERMANENT PRESS Cycle.
- For slow agitation and fast spin, use the NORMAL Cycle.

**STEP 5.** Pull Cycle Selector Control (Timer) Knob out to start washer.

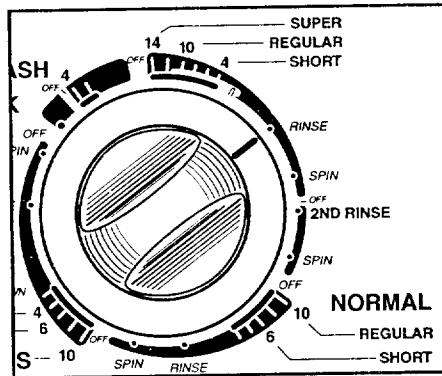

OPERATION

### SPIN ONLY

A drain and spin may help shorten drying times for some heavy fabrics or special-care items by removing excess water.

**STEP 1.** Set RINSE OPTIONS Control (if available) to ONE RINSE.

**STEP 2.** Set the Cycle Selector Control (Timer) Knob to a SPIN setting:

- For fast spin, use the NORMAL Cycle.
- For slow spin, use the PERMANENT PRESS Cycle.

**STEP 3.** Pull the Cycle Selector Control (Timer) Knob out to start washer.

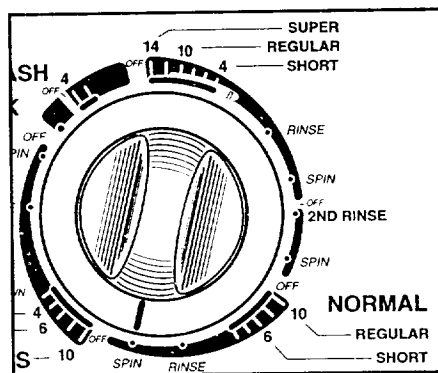

## SELF-CLEANING LINT FILTER

### *for your* **Benefit**

Lint is filtered from the load automatically – there's no messy cleanup.

Your washer features a self-cleaning filter that traps lint from the water while the washer is washing and deep rinsing the laundry. The trapped lint is flushed down the drain automatically. You don't have to clean the filter.

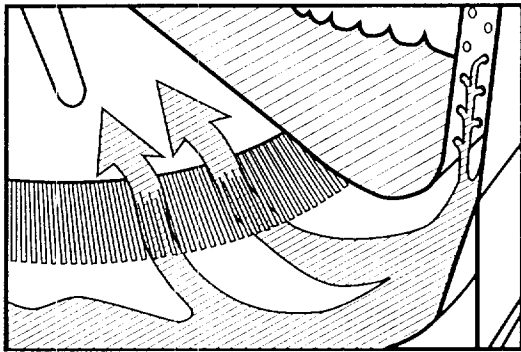

## DUAL-ACTION™ AGITATOR

### *for your* **Benefit**

The Kenmore DUAL-ACTION™ Agitator gives you flexible fabric care for even your largest loads.

The best cleaning action in your washer takes place at the bottom where the agitator vanes move back and forth to flex the fabric, loosening the soil.

The upper portion of the agitator moves in only one direction to help you wash larger loads. The clockwise rotation of the agitator forces the clothes on top down to the bottom where most of the cleaning action takes place.

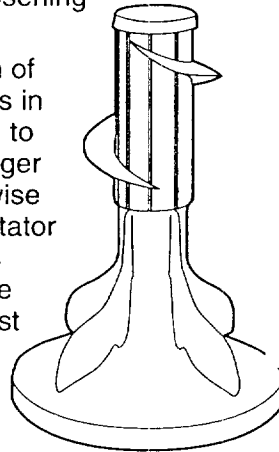

## AGITATORS

Your Kenmore washer will have one of the three agitators shown on this page.

### **STRAIGHT VANE AGITATOR**

This agitator is found in Kenmore extra-large capacity washers. Its design is well-suited to handle your everyday loads.

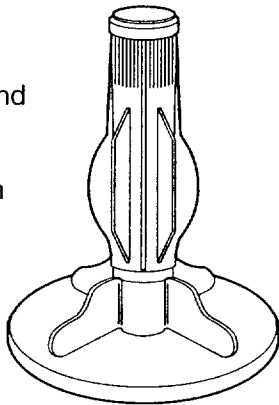

### **DOUBLE ROLL-OVER DUAL-ACTION™ AGITATOR**

This agitator operates identically to the DUAL-ACTION™ Agitator and adds special vanes to help push the clothes down in a spiraling pattern, displacing the clothes that are on the bottom with a "roll-over" motion. These uniquely designed vanes are more efficient in getting the clothes to "roll" down to where they are cleaned.

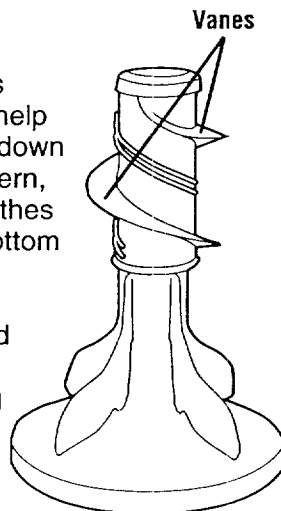



## UNDERSTANDING NORMAL WASHER SOUNDS

Your new washer may make sounds that your old one didn't. Because the sounds are unfamiliar, you may be concerned about them.

The following describes some of the normal sounds you may hear and what causes them.

### During Washing

When you select a small load size setting for a small wash load, your washer has a lower water level. With this lower water level, you may hear a clicking sound from the upper portion of the agitator.

### During Drain

The rate that water is drained from your washer depends on your installation. If water is drained quickly from the washer, you may hear air being pulled through the pump. This happens during the end of draining.

### After Drain and Before Spin

When the cycle changes from draining to spinning, you may hear a noise as the gearcase shifts.

## USING THE LIQUID CHLORINE BLEACH DISPENSER (some models)

### for your **Benefit**

Automatically dilutes bleach to ensure the cleanest and brightest loads.

### Always measure liquid chlorine bleach.

Use a measuring cup, do not guess. Do not pour directly from bottle. Never use more than 1 cup for a full load. Use less with smaller loads. Follow manufacturer's directions for safe use. A cup with a pouring spout will help you avoid spilling.

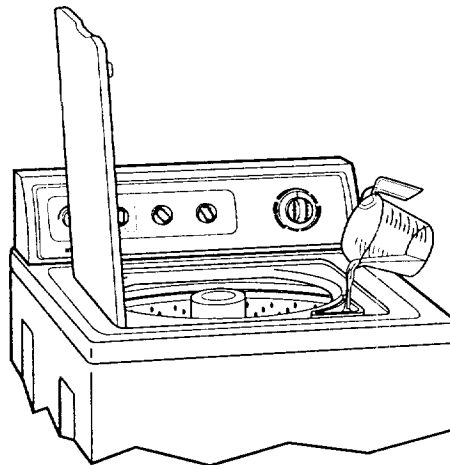

OPERATION

After loading the washer, pour measured liquid chlorine bleach carefully into the dispenser.

- Do not let bleach splash, drip, or run down into washer basket. Undiluted bleach will damage any fabric it touches.
- Start the washer. Bleach will be diluted automatically before it comes in contact with the wash load.

**NOTE:** Do not use this dispenser to add powdered chlorine or color-safe bleach to your wash load. The dispenser is for liquid chlorine bleach only.

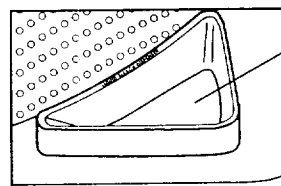

Liquid chlorine bleach dispenser

## USING THE LIQUID FABRIC SOFTENER DISPENSER (some models)

After loading the washer, measure and add the recommended amount of fabric softener into the dispenser. Follow manufacturer's directions.

**NOTE:** Pouring too much fabric softener into the dispenser will cause the fabric softener to dispense instantly into the load due to siphoning action. This instant "dump" could damage fabrics and will make it appear that your dispenser is not working correctly.

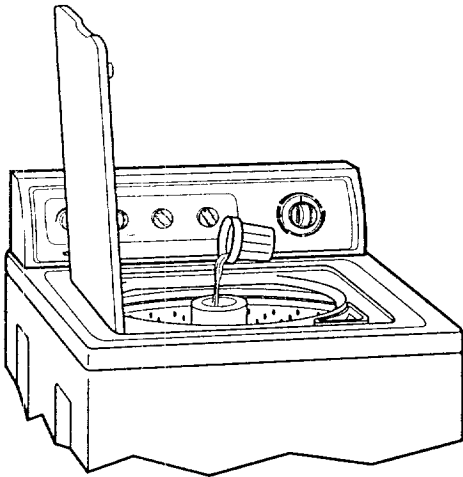

- Add warm water to fill the dispenser until it reaches the crossed opening at the bottom of the funnel-shaped portion of the dispenser.
- Fabric softener is dispensed into the first deep rinse water automatically.

**NOTE:** Fabric softeners are not compatible with detergents. This dispenser should never be used in the PREWASH Cycle since it would dispense fabric softener into a wash load that has not been rinsed. Undiluted fabric softener spilled on fabric may result in spots that look like oil stains.

If you ever use your dispenser this way by mistake, rewash the load with extra detergent to remove these deposits.

## To Remove the Fabric Softener Dispenser for Cleaning

**STEP 1.** Pull the blue lock ring up, then remove dispenser from agitator by pulling up.

**STEP 2.** Flush the dispenser with warm water.

## To Replace the Fabric Softener Dispenser

**STEP 1.** Be sure the blue lock ring is pulled up. Starting at an angle (see illustration), push the bottom of the dispenser down on the agitator top.

**STEP 2.** When the dispenser is seated on the agitator, push the blue lock ring down until it snaps in place. It must fit tightly.

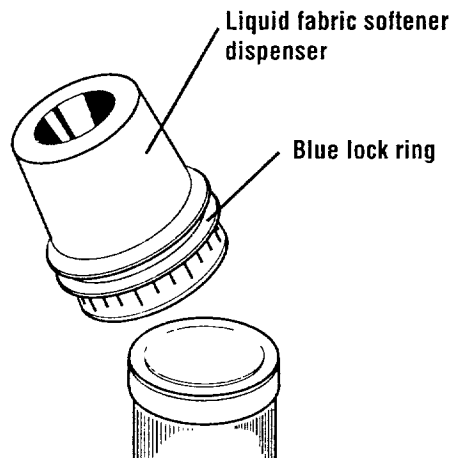

**UNDERSTANDING WHAT HAPPENS  
IN EACH CYCLE**

**PERMANENT PRESS/  
DELICATE**

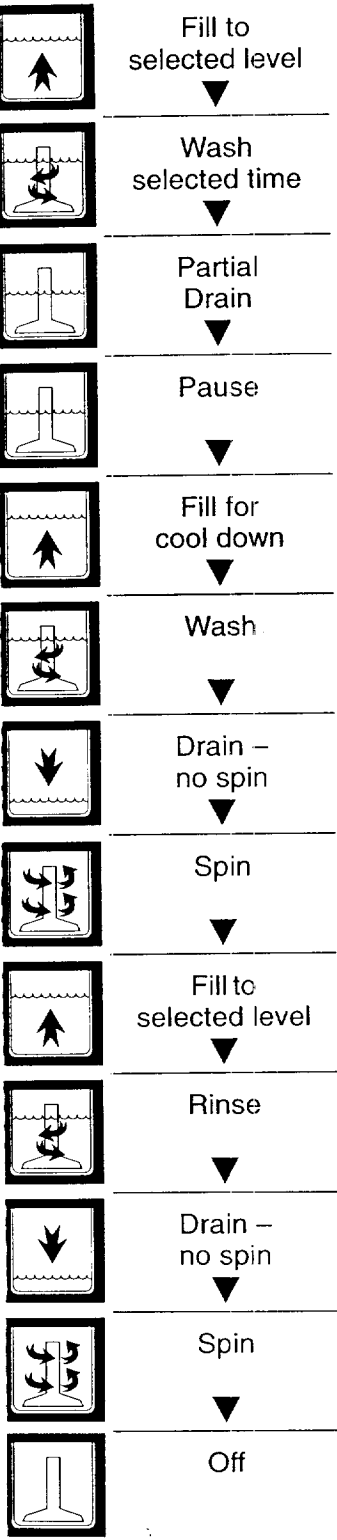

**NORMAL**

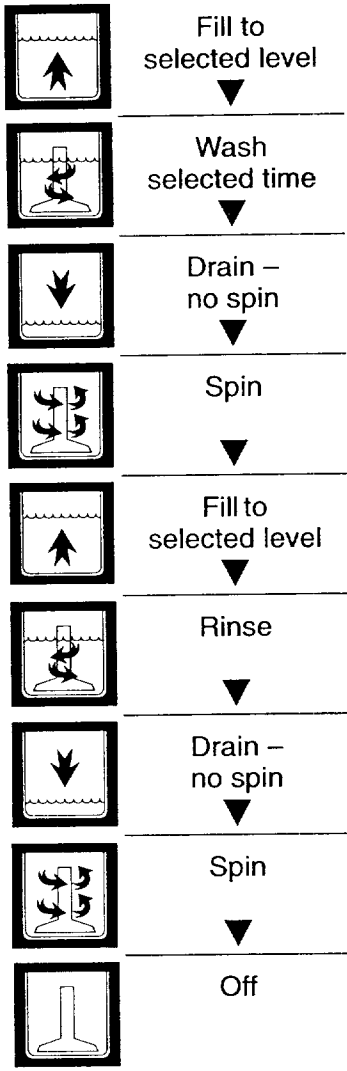

**SOAK**

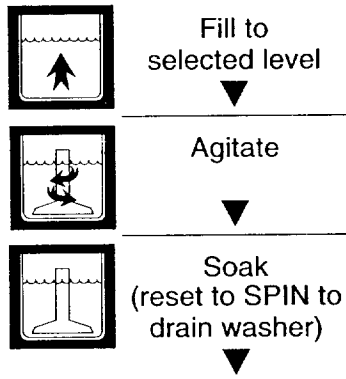

**HEAVY DUTY**

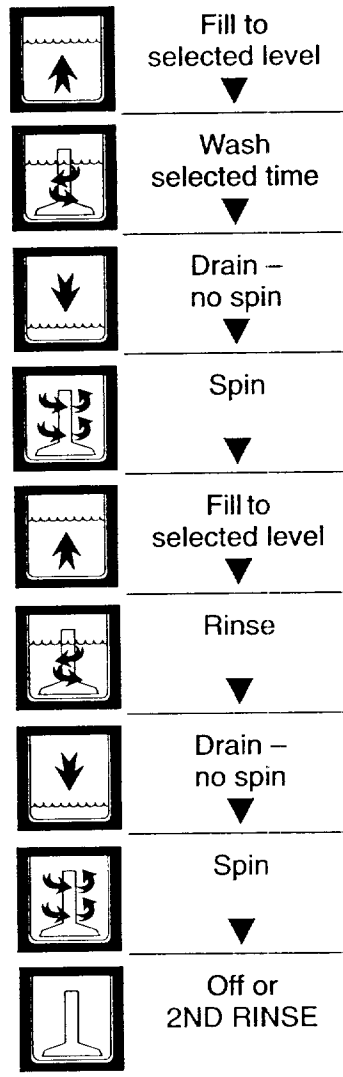

**PREWASH**

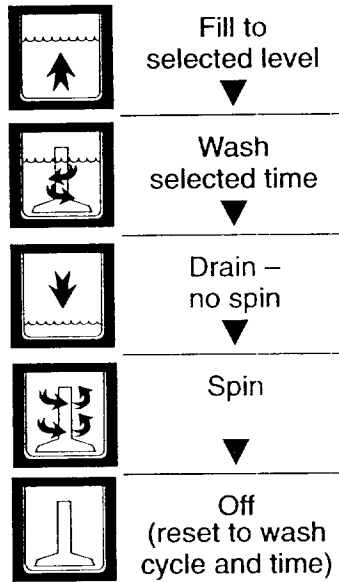

**OPERATION**

## LAUNDRY TIPS

### PREPARING CLOTHES FOR WASHING

#### *for your* **Benefit**

Follow these recommendations to help you prolong the life of your garments.

- Close zippers, snaps, and hooks to avoid snagging other items. Remove pins, buckles, and other hard objects to avoid scratching the washer interior. Remove non-washable trim and ornaments.
- Empty pockets and turn them inside out.
- Turn down cuffs, brush away lint and dirt.
- Turn synthetic knits inside out to avoid pilling.
- Tie strings and sashes so they will not tangle.
- Mend tears, loose hems, and seams.
- Treat spots and stains.
- Stained or wet garments should be washed promptly for best results.

### SORTING

- Separate heavily soiled items from lightly soiled ones, even if they would normally be washed together. Separate lint givers (towels, chenille) from lint takers (corduroy, synthetics, permanent press). When possible, turn lint givers inside out.
- Separate dark colors from light colors, colorfast items from non-colorfast items.
- Sort by fabric and construction (sturdy cottons, knits, delicate items).

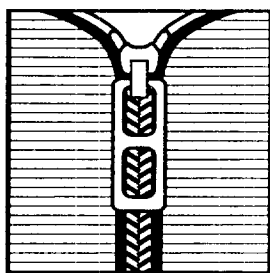
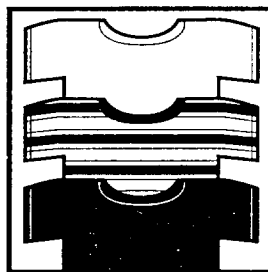

## LOADING

### for your Benefit

Proper loading of your washer contributes to proper cleaning and fabric care and reduces machine noise.

- Drop items into washer loosely. Fill to the top of the basket (top row of holes). Do not wrap items around the agitator. Items should move easily through wash water for best cleaning and wrinkle-free results. Items should sink and reappear later.
- Load washer properly and select correct water level setting. Overloading or packing the machine, and selecting a setting too small for the wash load can:
  - cause poor cleaning
  - increase wrinkling
  - create excessive lint
  - wear out items faster (because of pilling)
- Load by the amount of space items take up, not by their weight.
- Mix large and small items in each load. Load evenly to maintain washer balance. An off-balance load can make the washer vibrate during spin.
- Use a higher water level setting to reduce wrinkling with permanent press clothes and some synthetic knits. These items should have more room to move in the water than heavy items (towels, jeans).
- Reduce wash time by using a lower water level setting. Loads with only a few small items need less wash time.

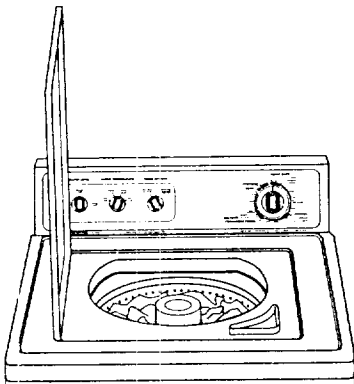

## LOADING SUGGESTIONS

For these suggested full-sized loads, set the WATER LEVEL Selector to the highest water level setting.

SUPER CAPACITY PLUS WASHERS		
Heavy Work Clothes	Towels	Mixed Load
4 jeans	10 bath towels	3 sheets (1 king, 2 twin)
4 workpants	10 hand towels	4 pillowcases
4 workshirts	14 wash cloths	3 shirts
2 sweatshirts		3 blouses
2 sweatpants		9 T-shirts
		9 shorts
		10 handkerchiefs

SUPER CAPACITY WASHERS		
Heavy Work Clothes	Towels	Mixed Load
4 jeans	9 bath towels	3 sheets (1 king, 2 twin)
4 workpants	9 hand towels	4 pillowcases
2 workshirts	10 wash cloths	2 shirts
1 sweatshirt		2 blouses
1 sweatpants		8 T-shirts
		6 shorts
		8 handkerchiefs

LAUNDRY TIPS

EXTRA-LARGE CAPACITY PLUS WASHERS		
Heavy Work Clothes	Towels	Mixed Load
3 jeans	7 bath towels	2 sheets (1 king, 1 twin)
3 workpants	8 hand towels	2 pillowcases
2 workshirts	9 wash cloths	2 shirts
1 sweatshirt		2 blouses
1 sweatpants		6 T-shirts
		5 shorts
		6 handkerchiefs

EXTRA-LARGE CAPACITY WASHERS		
Heavy Work Clothes	Towels	Mixed Load
2 jeans	6 bath towels	2 sheets (1 king, 1 twin)
2 workpants	6 hand towels	2 pillowcases
2 workshirts	8 wash cloths	1 shirt
1 sweatshirt		1 blouse
1 sweatpants		4 T-shirts
		5 shorts
		6 handkerchiefs

## CARING FOR YOUR WASHER

### CLEANING YOUR WASHER

Proper care of your washer can extend its life. This section explains how to care for your washer properly and safely.

#### Exterior

Wipe up detergent, bleach, and other spills with a soft, damp cloth or sponge as they occur. Occasionally wipe the outside of the washer to keep it looking like new.

Do not put sharp or metal objects in your washer. They can damage the finish. Check all pockets for pins, clips, money, bolts, nuts, etc. Do not lay these objects on your washer after emptying pockets.

#### Interior

Clean interior with 1 cup of chlorine bleach mixed with 2 cups of detergent. Run washer through a complete cycle using hot water. Repeat process if necessary.

**NOTE:** Remove hard water deposits using only cleaners labeled as washer safe.

### WATER INLET HOSES

Replace inlet hoses after five years of use to reduce the risk of hose failure. Periodically inspect and replace inlet hoses if bulges, kinks, cuts, wear, or leaks are found. When replacing your inlet hoses, mark the date of replacement on the label with a permanent marker.

### WINTER STORAGE OR MOVING CARE

Install and store your washer where it will not freeze. Because some water may stay in the hoses, freezing can damage your washer. If storing or moving your washer during freezing weather winterize it.

#### To winterize washer:

1. Shut off both water faucets.
2. Disconnect and drain water inlet hoses.
3. Put 1 quart of R.V.-type antifreeze in the basket.
4. Run washer on a SPIN setting for about 30 seconds to mix the anti-freeze and water. Some of the mixture will pump out while the washer spins.
5. Unplug the power supply cord.

#### To use washer again:

1. Flush water pipes and hoses.
2. Reconnect water inlet hoses.
3. Turn on both water faucets.
4. Reconnect power supply cord.
5. Run the washer through a complete cycle with 1 cup of detergent to clean out antifreeze.

### NON-USE OR VACATION CARE

Operate your washer only when you are at home. If you will be on vacation or not using your washer for an extended period of time, you should:

- Unplug the power supply cord or turn off electrical power to the washer.
- Turn off the water supply to the washer. This helps avoid accidental flooding (due to a water pressure surge) while you are away.

## TROUBLESHOOTING

Most laundering problems are easily solved if you understand the cause. Check these lists for common laundry

and washer problems. If you need further assistance, see page 36.

Problem	Possible Cause	Solution
<b>Washer Leaks</b>	Household plumbing is leaking.	Repair plumbing.
	Inlet hoses not tight.	Tighten hoses (see "INSTALLATION," Sections D & E).
	Inlet hose washers not properly seated.	Reseat washers (see "INSTALLATION," Section D).
	Drain hose not properly clamped or is off.	Clamp drain hose (see "INSTALLATION," Section C).
	Drain is clogged.	Remove drain clogs. Sink, standpipe, or floor drain must be able to handle 17 gallons of water per minute.
	Tub moved forward during unloading, causing water to deflect off of tub ring.	Ensure tub is centered before starting washer.
	Unit not level causing water to deflect off of tub ring.	Ensure front feet are installed and nuts are tightened. Level washer. Reset rear legs (see "INSTALLATION," Section G).
	Load is unbalanced. Spray rinses are deflecting off of load.	Redistribute the load.
<b>Won't Drain/ Won't Spin/ Wet Loads</b>	Washer is overloaded. Fills or spray rinses are deflecting off of load.	Reduce load size.
	Drain hose is kinked or clogged.	Straighten or unplug hose (see "INSTALLATION," Section C).
	Correct operation of neutral drain.	After a wash or rinse, the washer will drain without spinning. After draining, the spinning begins.
	Lid is open.	Close the lid.
	Drain hose is more than 96 inches above floor.	Lower drain hose (see "INSTALLATION," Section C).
	Too much detergent – excessive sudsing.	Use less detergent.
Wrong cycle for load being washed.	Choose a cycle with a higher spin speed (see "OPERATION").	

TROUBLESHOOTING

<b>Problem</b>	<b>Possible Cause</b>	<b>Solution</b>
<b>Won't Drain/ Won't Spin/ Wet Loads (cont.)</b>	Low voltage or using an extension cord.	Check electrical source or call electrician. Do not use extension cords.
	Cold rinses.	Cold rinses leave loads wetter than warm rinses. This is normal.
<b>Continues to Fill/ Continues to Drain/ Cycle Stuck</b>	Drain hose is less than 39 inches above floor.	Raise the drain hose (see "INSTALLATION," Section C).
	Drain hose fits tightly into standpipe.	Adjust drain hose for loose fit (see "INSTALLATION," Section C).
	Drain hose taped into standpipe.	Do not seal off drain hose with tape. The drain hose needs an air gap.
<b>Washer Makes Noise</b>	Load is unbalanced.	Redistribute load.
	Washer is not level. Rear leveling legs not set.	Level washer. Reset rear legs (see "INSTALLATION," Section G).
	Nuts on front feet not tight.	Tighten nuts (see "INSTALLATION," Section G).
	Yellow shipping strap with cotter pins not completely removed.	Remove strap with cotter pins (see "INSTALLATION," Section B).
	Floor not strong enough to support washer.	Relocate washer (see "INSTALLATION," Section A).
	Gears engaging after drain and before spin.	This is normal.
	Upper part of agitator clicks during wash.	This is normal.
<b>Won't Fill/ Won't Rinse/ Won't Agitate/ Wrong Temperature</b>	Water inlet valve screens are plugged.	Clean screens.
	Water is turned off.	Turn on water.
	Hot and cold hoses are reversed.	Reverse hoses (see "INSTALLATION," Sections D & E).
	Inlet hose is kinked.	Straighten hoses.
	Timer dial is not lined up.	Turn timer knob to the right slightly and pull to start.
	Power cord not plugged in.	Plug in power cord.



<b>Problem</b>	<b>Possible Cause</b>	<b>Solution</b>
<b>Machine Stops</b>	Power cord not plugged in.	Plug in power cord.
	No power at plug.	Check electrical source or call electrician.
	Fuse blown or circuit breaker open.	Replace fuse or reset circuit breaker. If problem continues, call electrician.
	Using an extension cord.	Do not use extension cords.
	Timer is not lined up.	Turn timer to the right slightly and pull to start.
	Timer knob not pulled out.	Set and pull out knob.
	Washer at pause in PERMANENT PRESS Cycle (approximately two minutes).	Allow cycle to continue (see "OPERATION").
	Machine is overloaded.	Wash smaller loads.
<b>Agitator Not Working</b>	The top of the agitator moves only in one direction.	This is normal.
	The top of the agitator is loose.	This is normal.
<b>Water Level Too Low/Not Completely Filling</b>	The top of the agitator is much higher than the highest water level. This creates a perception of the washer not being full.	This is normal.
<b>Tub is Crooked</b>	Tub pulled forward when unloading.	Ensure tub is centered before starting washer.
	Tub moves.	This is normal.
	Unit not level.	Ensure front feet are installed and nuts are tightened. Level washer. Reset rear legs (see "INSTALLATION," Section G).
<b>Lint on Load</b>	Improper sorting.	Sort lint givers from lint takers and by color.
	Overloading.	Lint can be trapped in load if overloaded. Wash smaller loads.
	Paper or tissue in pockets.	Clean out pockets before washing.
	Not enough detergent.	Use enough detergent to hold lint in water.
	Detergent not dissolving.	Use wash water warmer than 70°F.

**TROUBLESHOOTING**

<b>Problem</b>	<b>Possible Cause</b>	<b>Solution</b>
<b>Tearing</b>	Overloading. Improper use of washer.	Loads should move freely during wash. Wash smaller loads.
	Improper use of chlorine bleach. Undiluted bleach will damage fabrics.	Do not pour chlorine bleach directly on load. Wipe up bleach spills.
	Sharp items not removed from pockets; fasteners not fastened.	Clean out pockets before washing. Zip zippers before washing.
	Items damaged before washing.	Mend rips and broken threads in seams before washing.
<b>Stains on Load</b>	Improper use of fabric softener in washer or dryer.	Dilute fabric softener and add to deep rinse only.
	Iron in water (rust).	Install an iron filter.
	Under use of detergent causing soil to be redeposited.	Use enough detergent to remove soil and hold it in suspension.
	Dye transfer due to not sorting loads properly.	Sort dark clothing from whites and lights.
	Dye transfer due to not unloading washer promptly.	Unload the washer as soon as it stops.
<b>Load is Wrinkled</b>	Not removing load promptly.	Unload the washer as soon as it stops.
	Wrong cycle for fabrics being washed.	Use cold rinses and cycles with slow spin speeds to reduce wrinkling.
	Overloading.	Loads should move freely during wash. Wash smaller loads.
	Wash water not warm enough to relax wrinkles. Using warm rinses.	If safe for fabric, use warm or hot wash water. Use cold rinse water.
	Hoses reversed.	Reverse hoses (see "INSTALLATION," Sections D & E).
<b>Load is Tangled/ Twisted</b>	Overloading.	Loads should move freely during wash. Wash smaller loads.
	Clothes wrapped around agitator.	Do not wrap items around agitator when loading the washer.
<b>Clogged Dispensers/ Bleach Leaking/ Bleach on Wrong Loads</b>	Not diluting softener.	Dilute fabric softener in dispenser.
	Use of color-safe bleach in chlorine bleach dispenser.	Add color-safe bleach directly to the basket. Do not use chlorine bleach dispenser.
	Improper use of chlorine bleach.	Always measure bleach before adding to the dispenser. Carefully pour into the dispenser. Wipe up bleach spills.

## SEARS MAINTENANCE AGREEMENT

### KENMORE WASHERS

#### We Service What We Sell

"We Service What We Sell" is our assurance you can depend on Sears for service. Your washer has added value when you consider that Sears has service units nationwide, staffed with professional technicians specifically trained on Sears appliances and having parts, tools and equipment to ensure that we meet our pledge to you...  
"We Service What We Sell."

#### Sears Maintenance Agreement

Maintain the value of your Kenmore washer with a Sears Maintenance Agreement. Kenmore washers are designed, manufactured, and tested for years of dependable operation. Yet any appliance may require service from time to time.

#### The Sears Maintenance Agreement

- Is your way to buy tomorrow's service at today's prices.
- Eliminates repair bills resulting from normal use.
- Allows for as many service calls as required.
- Provides for service by professional Sears Trained Technicians.
- Even if you don't need repairs, the Maintenance Agreement offers an annual preventative maintenance checkup at your request!

**For more information,  
call 1-800-827-6655.**

SERVICE

For the repair or replacement parts you need delivered directly to your home

Call 7 am - 7 pm, 7 days a week

**1-800-366-PART**

(1-800-366-7278)

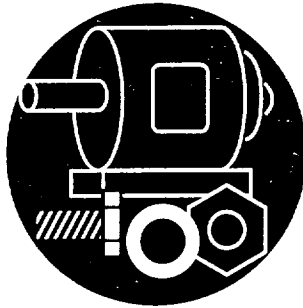

For in-home major brand repair service

Call 24 hours a day, 7 days a week

**1-800-4-REPAIR**

(1-800-473-7247)



For the location of a Sears Parts and Repair Center in your area

Call 24 hours a day, 7 days a week

**1-800-488-1222**



For information on purchasing a Sears Maintenance Agreement or to inquire about an existing Agreement

Call 9 am - 5 pm, Monday - Saturday

**1-800-827-6655**



When requesting service or ordering parts, always give the following information:

- Product Name
- Part Name
- Model Number
- Part Number

