

OWNER'S MANUAL

MODEL NOS.
625.388200
625.388250

Caution:

Read and Follow
All Safety Rules and
Operating Instructions
Before First Use of
This Product.

If you have questions when
installing, operating or main-
taining your softener, and
when setting the timer, call
this toll-free number...

1-800-426-9345

www.KenmoreWater.com

SAVE THIS MANUAL



UltraSoft 200 Water Softener

with Deluxe Valve

- ◆ Warranty
- ◆ Start Up / Setting Timer
- ◆ How It Works
- ◆ Care Of
- ◆ Specifications
- ◆ Repair Parts

Use the plastic bag and tie provided, to hang manuals
nearby the softener for future reference.

Sears, Roebuck and Co., 3333 Beverly Road, Hoffman Estates, IL 60179 USA

**W
A
R
R
A
N
T
Y**

SEARS RESIDENTIAL WATER SOFTENER

FULL ONE YEAR WARRANTY ON WATER SOFTENER

For one year from the date of purchase, when this water softener is installed and maintained in accordance with our instructions, Sears will repair, free of charge, defects in material or workmanship in this water softener.

FULL TEN YEAR WARRANTY AGAINST LEAKS

For ten years from the date of purchase, Sears will furnish and install a new current model water softener tank or salt storage drum, free of charge, if either the tank or drum develop a leak.

TO OBTAIN WARRANTY SERVICE, SIMPLY CONTACT THE NEAREST SEARS SERVICE CENTER THROUGHOUT THE UNITED STATES. This warranty applies only while this product is in use in the United States.

This warranty gives you specific legal rights, and you may have other rights which vary from state to state.

Sears, Roebuck and Co., D/817 WA, Hoffman Estates, IL 60179

If you want your water softener professionally installed, talk to your Sears Salesman. He will arrange for a prompt, quality installation by Sears Authorized Installers.

SEARS INSTALLATION POLICY

All installation labor arranged by Sears shall be performed in a neat, workmanlike manner in accordance with generally accepted trade practices. Further, all installations shall comply with all local laws, codes, regulations, and ordinances. Customer shall also be protected, during installation, by insurance relating to Property Damage, Workman's Compensation and Public Liability.

SEARS INSTALLATION WARRANTY

In addition to any warranty extended to you on the Sears merchandise involved, which warranty becomes effective the date the merchandise is installed, should the workmanship of any Sears arranged installation prove faulty within one year, Sears will, upon notice from you, cause such faults to be corrected at no additional cost to you.

FACTS AND FIGURES TO KEEP

Fill in the blanks below and keep this book in a safe place so you always have these facts.

Water Softener Model No.† _____
 Serial Number _____
 Date Installed _____
 Water Hardness _____ Grains Per Gallon
 Iron Content _____ Parts Per Million
 pH _____ Taste And/Or Odor _____
 Water Pressure _____ Pounds/Square Inch
 Water Flow Rate _____ Gallons Per Minute

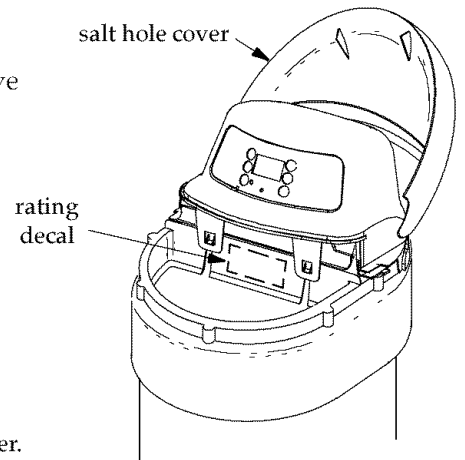

† The model number is on the rating decal, located on the rim, under the salt hole cover.

**T
A
B
L
E

O
F

C
O
N
T
E
N
T
S**

SECTION 1	WATER SOFTENER START UP	PAGE NO.
A.	Safety Guides -----	1-1
B.	Check List of Step-By-Step Guides To Install -----	1-2
C.	Program The Timer -----	1-3, 1-4
D.	Sanitizing The Water Softener -----	1-5
E.	Fill The Storage Tank With Salt -----	1-6
SECTION 2	HOW YOUR WATER SOFTENER WORKS	
A.	Faceplate Timer Features -----	2-1 to 2-3
B.	Soft Water Service and Regeneration -----	2-4 to 2-6
SECTION 3	CARE OF YOUR WATER SOFTENER	
A.	Salt: Refilling Storage Tank / Salt Bridge -----	3-1
B.	Keeping The Water Softener Clean -----	3-2
C.	Protect The Water Softener From Freezing -----	3-3
D.	Checklist (Not Getting Soft Water) -----	3-4
SECTION 4	ABOUT YOUR WATER SOFTENER	
A.	Dimensions / Specifications -----	4-1, 4-2
SECTION 5	SERVICE TECH. INFORMATION	
A.	Troubleshooting -----	5-1 to 5-4
B.	Rotary Valve Service -----	5-5
C.	Water Flow Through The Softener Valve -----	5-6 to 5-8
SECTION 6	REPAIR PARTS FOR WATER SOFTENER	
A.	Water Softener Complete -----	6-1, 6-2
B.	Brine Valve Assembly -----	6-3, 6-4
C.	Valve Assembly -----	6-5, 6-6

A. SAFETY GUIDES

▲ Read all steps, guides and rules carefully before installing and using your new water softener. Follow all steps exactly to correctly install. Failure to follow them could cause personal injury or property damage. Reading this book will also help you to get all of the benefits from your water softener.

▲ Your water softener will remove hardness minerals and “clear water” iron from water, up to the limits shown on page 4-1. It will not remove other types of iron, acids, tastes and odors, etc. It will not purify polluted water or make it safe to drink.

▲ Protect the softener and piping from freezing. Damage from freezing voids the softener warranty. See page 3-3.

CAUTIONS

PLEASE READ AND COMPLY WITH THE FOLLOWING GUIDES TO PREVENT DAMAGE TO THE SOFTENER OR OTHER PROPERTY, PERSONAL INJURY, OR POSSIBLE FATAL SHOCK.

▲ THIS SOFTENER WORKS ON 24 VOLTS ONLY. BE SURE TO USE ONLY THE TRANSFORMER INCLUDED, AND PLUG IT INTO A HOUSEHOLD 120V OUTLET. IF TRANSFORMER IS REPLACED, USE ONLY THE AUTHORIZED SERVICE, CLASS II, 24 VOLT, 10 VA TRANSFORMER.

▲ Unplug the transformer right away if the power cable should become damaged or frayed. Make repairs before plugging back into the power outlet.

▲ Always unplug the softener from electrical power before removing outer valve covers.

▲ This system is not intended to be used for treating water that is microbiologically unsafe or of unknown quality without adequate disinfection before or after the system.

B. CHECK LIST OF STEP-BY-STEP GUIDES TO INSTALL

To be sure you have done all the steps to install the softener, read the following list. Refer to the Installation Manual, part no. 7231741, for step-by-step guides.

Page numbers referred to are in the *Installation Manual* unless otherwise noted.

- ✔ Is the house water flow going INTO the softener valve INLET? Trace piping to be sure. See pages 2-4 and 2-5.
- ✔ Is the plumbing bypass valve (or 3 valves) set for SERVICE? Bypass valve(s) should always remain in soft water service position. Position in "bypass" only if needed for softener repairs. See FIG. 14, page 4-1 of this manual.
- ✔ Is the valve drain hose connected the right way, and without sharp bends or kinks that could stop or reduce water flow? See page 3-5 in the installation manual.

Page numbers referred to are in the *Installation Manual* unless otherwise noted.

- ✔ Is the softener power cable connected to the transformer? Is the transformer plugged into **an inside**, always live 120V-60Hz electrical outlet? See pages 3-8 and 3-9 in the installation manual, and the wiring schematic on page 5-1 of this manual.
- ✔ Be sure to restart the water heater. See page 3-9.

FIG. 1

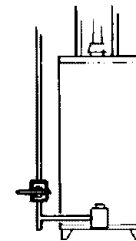
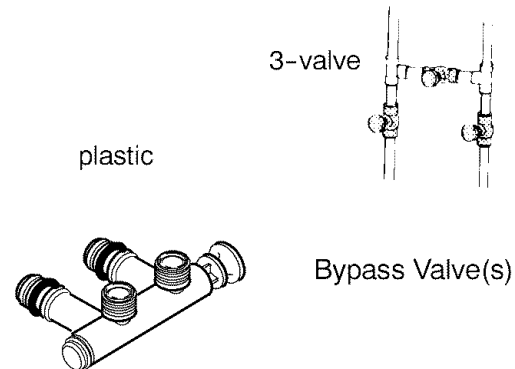
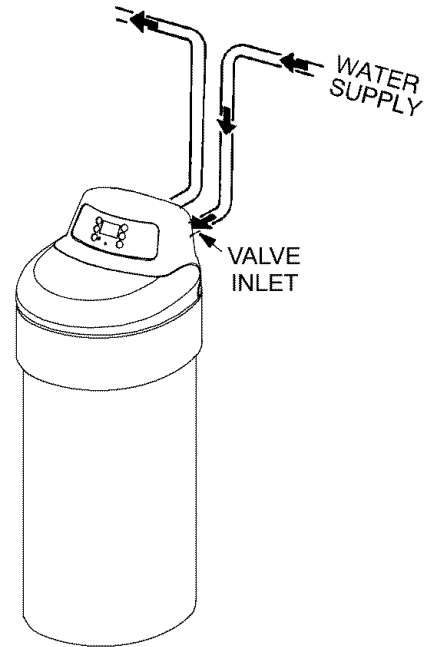

NOTE: Codes in the state of Massachusetts require installation by a licensed plumber. For installation, use plumbing code 248-CMR of the Commonwealth of Massachusetts.

C. PROGRAM THE TIMER

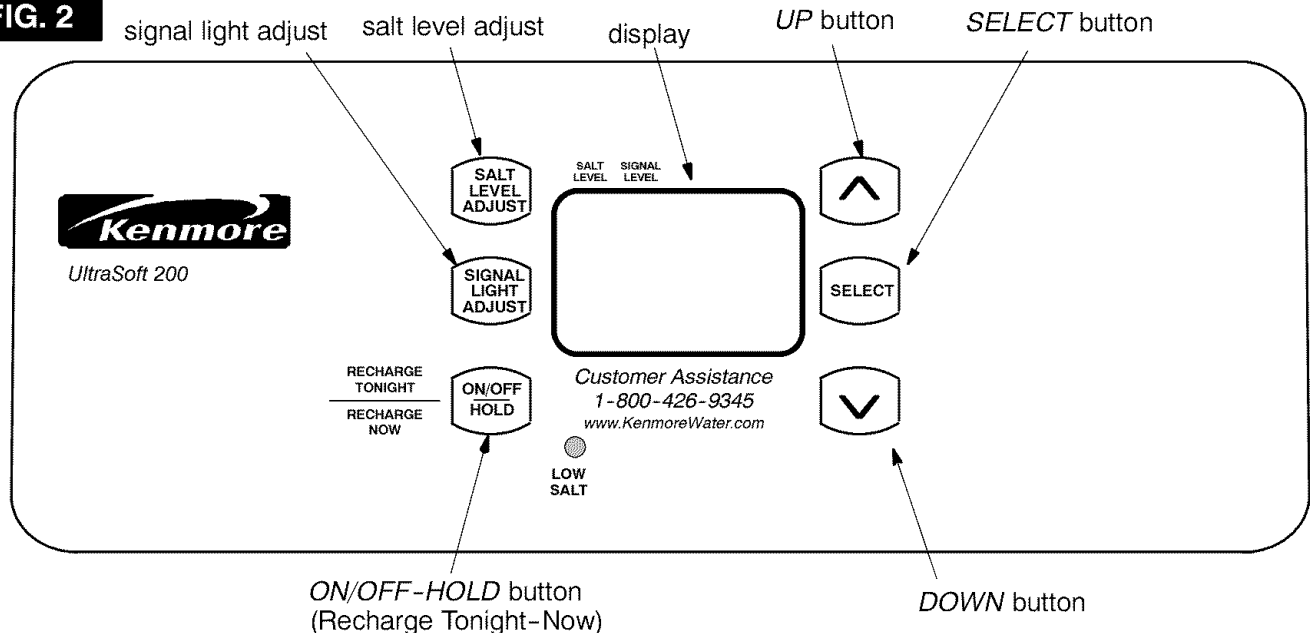

FIG. 2

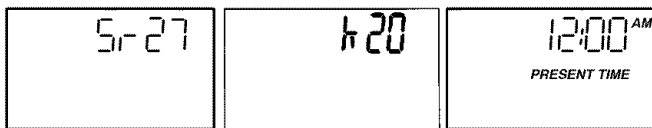

When the transformer is plugged in, the model code SR27, and a test number (example: k20) show in the face plate display for 4 seconds. Then, 12:00 AM and *PRESENT TIME* begin to flash.



Notes:

If SR - - shows in the display, press the UP  or DOWN  button until SR27 shows. Then, press the SELECT button to set, and change to the flashing *PRESENT TIME* display.

To check the model code, unplug the transformer at the wall outlet and plug in again. **if other than SR27 shows, see page 5-3 to reset.**

SOUND "BEEPER": A "beeper" sounds while pressing buttons for timer set-up. One beep signals a change in the face plate display. Repeated beeps mean the timer will not accept a change from the button you have pressed, telling you to use another

button. For example, while setting the hardness (step 2), the beeper sounds repeatedly when the display reaches 1 using the DOWN button, or the highest hardness setting using the UP button.

1. SET PRESENT TIME OF DAY

If the words *PRESENT TIME* do not show in the display, press the SELECT button (FIG. 2) until they do, or see the previous notes.

■ Press the UP / DOWN buttons to set the present time. Press UP to move the display ahead; press DOWN to move the time backward.

If the present time is between noon and midnight, be sure *PM* shows.

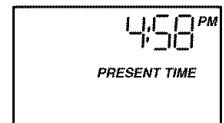

If the present time is between midnight and noon, be sure *AM* shows.

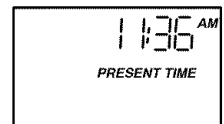

Each press of the UP /DOWN buttons changes the time by 1 minute. Holding the buttons in changes the time 32 minutes each second.

C. PROGRAM THE TIMER

2. SET WATER HARDNESS NUMBER

■ Press the SELECT button once to display 25 (flashing) and *HARDNESS*.

The grains per gallon (gpg) hardness of your water supply is on your water analysis report. Be sure to enter water test results on page A, for future reference.



If your water supply contains iron, compensate for it by adding to the water hardness number. *For example, assume your water is 20 gpg hard and contains 2 ppm iron. Add 5 to the hardness number for each 1 ppm of iron. In this example, you would use 30 for your hardness number.*

$$\begin{array}{r} 20 \text{ gpg hardness} \\ 2 \text{ ppm iron} \times 5 = 10 \\ \text{(times)} \quad \quad \quad \underline{+10} \\ \quad \quad \quad \quad \quad \quad 30 \text{ HARDNESS NUMBER} \end{array}$$

■ Press the UP / DOWN buttons to set your water hardness number in the display. The DOWN button moves the display to 1. The UP button moves the display to the highest setting (see maximum setting for your model in the specifications).

Note:

Each press of the UP / DOWN button changes the display by 1 between 1 and 25. Between 25 and the highest number, the display changes 5 at a time...25, 30, 35, etc. Holding the UP or DOWN button in changes the display twice each second.

3. SET RECHARGE (REGENERATION) TIME

■ Press the SELECT button to display 2:00 AM (flashing) and *RECHARGE TIME*.

At the 2:00 AM recharge time setting, the softener begins regeneration (see pages 2-4 and 2-5) at 2:00 AM. This is a good time in most households because water is not being used (see **Automatic Bypass**, page 2-6). If a different recharge time setting would be better for your household, do the following.



■ Press the UP / DOWN buttons to set the desired recharge starting hour. Be sure to observe the AM-PM as you did when setting the present time of day.

Note:

Each press of the UP / DOWN buttons changes the display one hour. Holding the buttons in changes the display twice each second.

■ Press the SELECT button once again, to return the present time, and *RECHARGE TONIGHT* in the display.

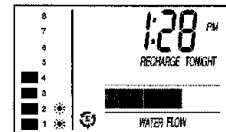

IF YOU NEED HELP PROGRAMMING THE TIMER, CALL TOLL FREE,
NUMBER 1-800-426-9345.

SEE PAGES 2-1, 2-2 AND 2-3 FOR OTHER FACE PLATE TIMER FEATURES.

D. SANITIZE THE WATER SOFTENER

Care is taken at the factory to keep your water softener clean and sanitary. Materials used to make the softener will not infect or contaminate your water supply, and will not cause bacteria to form or grow. However, during shipping, storage, installing and operating, bacteria could get into the softener. For this reason, sanitizing as follows is suggested^① when installing.

1. The first time you sanitize your softener, be sure to do *all* steps in the installation manual, and on pages 1-2, 1-3 and 1-4 of this manual first.
2. Lift the salt hole cover and use a pail to fill the salt storage tank with up to 3 gallons of water.
3. Remove the brinewell cover (FIG. 3) and pour about 3/4 ounce, or 1 to 2 tablespoons, of common 5.25%, *unscented*, household bleach (Clorox, Linco, BoPeep, White Sail, Eagle, etc.) in the softener brinewell. Replace the brinewell cover.
4. Press the **ON/OFF-HOLD** button and *hold for 3 seconds* to start a recharge. This first recharge does several things.

- It draws the bleach into and through the softener to sanitize it.
- It fills the salt tank to the water level needed.
- It gets all the air out of the resin tank.
- It prepares the resin bed (see page 2-4) for service.

Notes:

This recharge takes about 2-1/2 or 2-3/4 hours, depending on the salt type setting (page 1-4).

You can sanitize the softener *with or without* salt in the storage tank.

FIG. 3

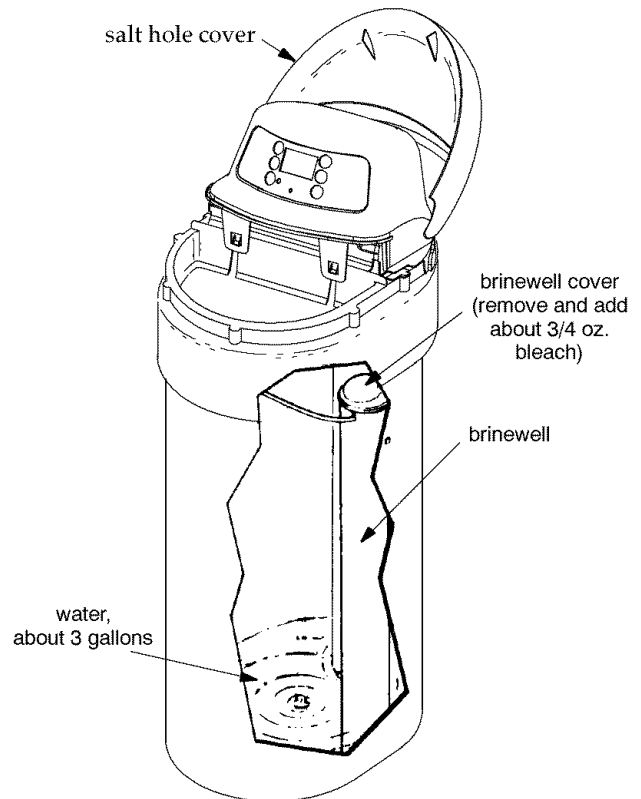

^① Recommended by the Water Quality Association. On some water supplies, the water softener may need periodic disinfecting.

E. FILL THE STORAGE TANK WITH SALT

Brine (salt dissolved in water) is needed for each and every regeneration. The water for making brine is metered into the salt storage tank by the softener. However, you must keep salt in the tank, but it is not necessary to keep it full. **In humid areas**, it is best to fill the storage tank one quarter to one half full, and to refill it more often. Salt bridging (see page 3-1) occurs more often when conditions are humid.

Fill the tank with NUGGET or PELLET water softener salt. **DO NOT** use rock salts, as they have dirt and sediments that will stop the softener from working.

Before filling, be sure the brinewell cover is in place on the top of the brinewell. Salt storage capacity is shown on page 4-1. **Be sure to set the salt monitor system (see page 2-1).**

Note: The salt monitor system, page 2-1, is calibrated to the density of nugget or pellet water softener salt. The monitor will not work as accurately with other types of salt including rock and solar.

If you choose Potassium Chloride (KCl) as a regenerant, following these suggestions will help give you years of maintenance free service.

- 1) Place only one bag of KCl in your softener at a time (the salt storage tank should contain no more than 60 pounds of KCl at any one time).
- 2) A softener using KCl should not be placed in areas with temperature fluctuations and high humidity (KCl will harden in these environments and may make the softener inoperable).
- 3) Check the brine tank and brine well (black tube in salt storage tank) monthly. If hardening is present, pour small amounts of warm water on hardened areas until they loosen.
- 4) If your softener does not have a KCl salt setting you must increase your hardness setting by 25% to ensure continuous soft water as in example below.

Raw Water Hardness (grains per gallon)		Softener setting when using KCl
5 gpg		7 gpg
10 gpg		13 gpg
15 gpg		19 gpg
20 gpg	x 25 % =	25 gpg
25 gpg		32 gpg
30 gpg		38 gpg
35 gpg		44 gpg
40 gpg		50 gpg

You have now finished the water softener start up. After the sanitizing recharge, on page 1 - 5, the softener will be giving you soft water. Please read pages 2 - 4, 2 - 5 and 2 - 6 in section 2 to understand how the softener works to continue to give you soft water.

WATER SOFTENING SALT WITH IRON REMOVING ADDITIVES — Some salts have an additive to help the softener handle iron in the water supply. These salts may be used if your water supply has a high iron content. It is recommended to use Sears Resin Bed Cleaner 42-34426, for periodic treatments to keep your resin bed clean.

FIG. 4

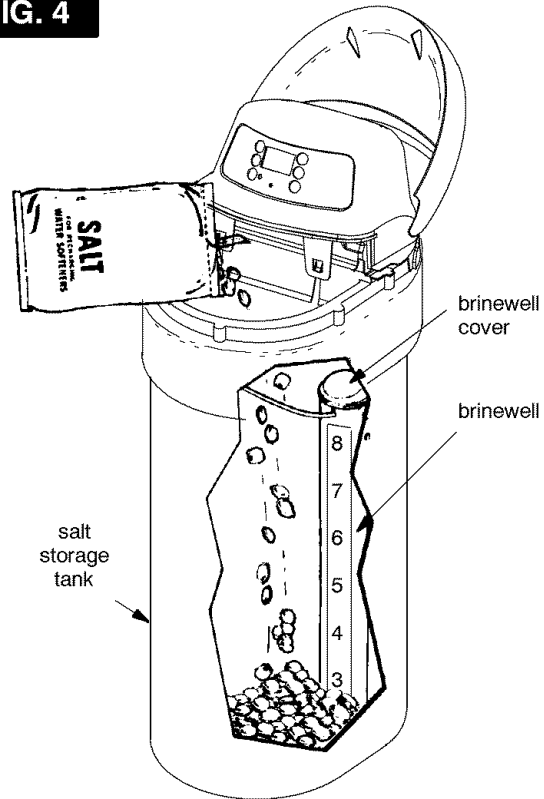

Sodium information: Water softeners using sodium chloride for regeneration add sodium to the water. Persons who are on sodium restricted diets should consider the added sodium as part of their overall sodium intake. For example, if your water supply is 15 grains hard, you would have to drink 3 quarts of softened water to consume 335 milligrams of sodium. That is equivalent to eating 2-1/2 slices of white bread.

Persons who are concerned about their drinking water should consider a Kenmore Drinking Water System that will remove or reduce in excess of 90% of the sodium and other drinking water contaminants.

A. FACEPLATE TIMER FEATURES

SECTION

2

▶ EXTRA RECHARGE

Sometimes, a manually started regeneration (recharge) may be desired, or needed. Two examples are:

- You have used more water than usual (guests visiting) and you may run out of soft water before the next timer started regeneration.

- You did not refill the softener with salt before it was gone. After you refill with salt:

You can start a regeneration right away, or you can set the timer to regenerate at the next 2:00 AM (or other preset recharge time). Do the following.

▶ RECHARGE NOW

Press the ON/OFF-HOLD button and *hold* until *RECHARGE, *Serv* and *Fill* begin to flash in the display. Upon reaching fill, the first cycle of regeneration, the flashing *Serv* goes off and *Fill* is on steady. RECHARGE continues to flash. This regeneration will last for about 2 hours. After the 2 hours, you will have soft water again.

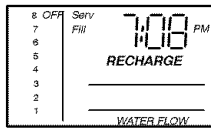

*Note:

If the CLEAN feature is set to ON, a cleaning backwash (CLEAN and *Bkwsh* or *Rinse* flashes in the display, along with the minutes of the clean cycle remaining) precedes the recharge.

▶ RECHARGE TONIGHT

Press and release (*do not hold*) the ON / OFF-HOLD button. RECHARGE TONIGHT flashes in the display, and the softener begins regeneration at the next preset recharge time. Press and release the ON/OFF-HOLD button once more if you decide to cancel the regeneration, and RECHARGE TONIGHT.

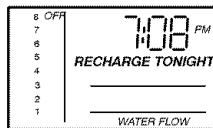

▶ SALT MONITOR SYSTEM

The face plate timer has a low salt monitor with an indicator light to remind you to refill the storage tank with salt. To set this monitor system:

1. Lift the salt hole cover and level the salt in the storage tank.
2. The salt level decal, on the brinewell inside the tank, has numbers from 0 to 8 (see drawing below). Observe the number the leveled salt is at or closest to.
3. Now, press the SALT LEVEL ADJUST button until black bars display up to the salt level number. For example, the pictures below show the salt level at 6.
4. Finally, set the level you want the low salt indicator light to come on. Press the SIGNAL LIGHT ADJUST button until a (*) shows opposite this number. In the example below, the light will come on when the stored salt drops to level 2. At level 2, the storage tank is about 1/3 full. This is the lowest you should allow the stored salt level to drop to (see note on page 1-6).
5. If you wish to turn the salt monitor off, press the SIGNAL LIGHT ADJUST button until OFF shows above.

Note:

For accurate salt monitor operation, always use nugget or pellet water softener salt. See page 1-6.

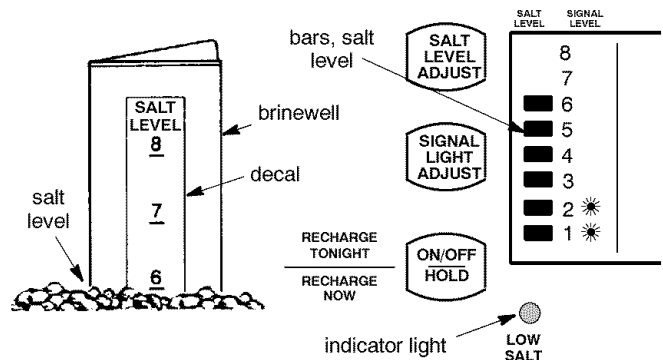

A. FACEPLATE TIMER FEATURES

► OPTIONAL SETTINGS - SALT EFFICIENCY, CLEAN FEATURE, CLEAN FEATURE MINUTES, MAXIMUM DAYS BETWEEN REGENERATIONS and 12 / 24 HOUR CLOCK:

1. To set any of the following options, press and hold SELECT for 3 seconds until 000 shows in the display. Then press once until the SALT EFFICIENCY display shows. Use the UP / Down buttons to change the ON / OFF displays.

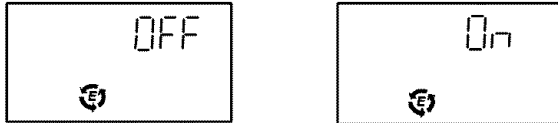

■ **SALT EFFICIENCY:** When this feature is ON, the unit will operate at salt efficiencies of 4000 grains of hardness per pound of salt or higher. (May recharge more often using smaller salt dosage and less water).

2. Press SELECT again to show the CLEAN display.

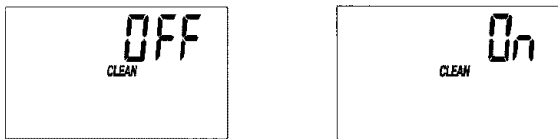

■ **CLEAN:** This feature is beneficial on water supplies containing iron and/or high amounts of sediments (sand, silt, dirt, etc.). When set to ON, a backwash and fast rinse cycle will occur first, preceding the normal regeneration sequence (see page 2-4). This provides extra cleaning of the resin bed before it is regenerated with the salt brine. To conserve water, if your water supply does not contain iron or sediments, be sure this feature is set to OFF.

3. Press SELECT again until the CLEAN TIME display shows.

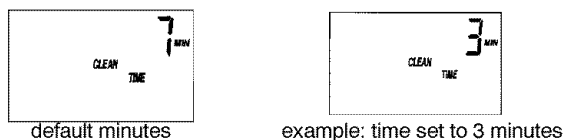

■ **CLEAN feature minutes:** If you are using this feature, the length of the extra backwash cycle automatically sets to 7 minutes. However, you can ad-

just this time from 1 to 15 minutes in length. To change this cycle time, use the UP button to increase the time, or the DOWN button to shorten the time. If no change is desired, continue below.

4. Press SELECT again to show the following RECHARGE display.

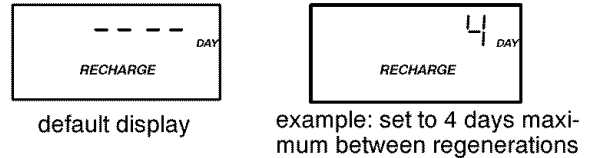

■ **Maximum days between regenerations:** The faceplate timer automatically controls regeneration frequency (see page 2-5). This provides the greatest operating efficiency, and under most conditions this feature will be left in its default mode. However, you can modify this feature if you want to force a regeneration every set number of days. For example, if your water supply contains iron and you want the softener to regenerate at least once every few days to keep the resin bed clean, set the display as typically shown above. Setting is available from 1 to 15 days by using the UP and DOWN buttons.

5. Press SELECT to show the 12 HOUR display.

■ **12 or 24 hour clock:** All time displays are shown in standard clock time (1 to 12 PM; and 1 to 12 AM) at the 12 hr default setting. If military time displays are desired, set to 24 hr by pressing the UP button.

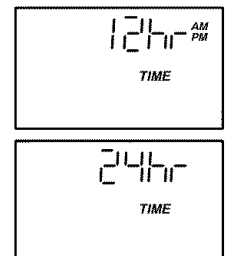

6. Press SELECT to return to the present time display.

► WATER FLOW THROUGH THE SOFTENER

If soft water is in use, the water flow bars continually scroll across the display. The bars scroll slowly when water flow is slow, and move faster as water flow increases. The flow bars do not show when all faucets and water using appliances are off.

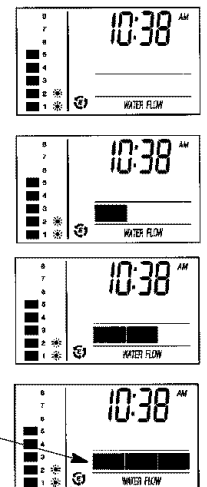

Flow bars scroll when soft water is in use.

► RECHARGE TIME REMAINING and VALVE POSITION INDICATORS

One of the valve position indicators (Serv, Fill, Brine, Bkwsh, Rinse) is displayed while the softener is recharging (See *Note on page 2-1 if the CLEAN feature is ON). RECHARGE flashes in the display and, beginning with *Brine*, the minutes of recharge remaining before return to service appears in place of the present time. When the valve is moving from one cycle to another, both position indicators are flashing.

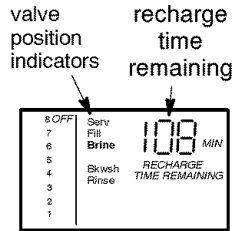

► PROGRAM MEMORY

If electrical power to the softener goes off, the time display is blank but the face plate timer keeps the

correct time for about 12 hours. When electrical power comes on again, you have to reset the present time **only** if the display is flashing. The HARDNESS and RECHARGE TIME never require resetting unless a change is desired. Even if the timer is incorrect after a long power outage, the softener works as it should to keep your water soft. However, regenerations may occur at the wrong time of day until you reset the timer to the correct time of day (page 1-3).

► ERROR CODE

An error code could appear in the face plate display if a problem occurs in the softener electronics. Turn to page 5-2 under "Troubleshooting" to resolve the problem.

B. SOFT WATER SERVICE and REGENERATION

SERVICE

When the softener is giving you soft water, it is called "Service". During service, hard water comes from the house main water pipe into the softener. Inside the softener resin tank is a bed made up of thousands of tiny, plastic resin beads (FIG. 5). As hard water passes through the bed, each bead attracts and holds the hardness minerals. This is called ion-exchanging. It is much like a magnet attracting and holding metals. Water without the hardness minerals (soft water) flows out of the softener and into the house soft water pipes. After a period of time, the resin beads hold all of the hardness minerals they can, and cleaning with salt brine is needed. This cleaning is called regeneration or recharge. Regeneration is started at 2:00 a.m. by the electronic timer (see page 2-6). It takes place in 5 stages or cycles. These are:

- | | | | |
|----------|-------------|----------|------------|
| 1 | FILL | 4 | BACKWASH |
| 2 | BRINING | 5 | FAST RINSE |
| 3 | BRINE RINSE | | |

Note:

If the *Clean* feature is set to ON, additional backwash and fast rinse cycles occur before the fill cycle.

FIG. 5 Water Flow Through the Softener in Service

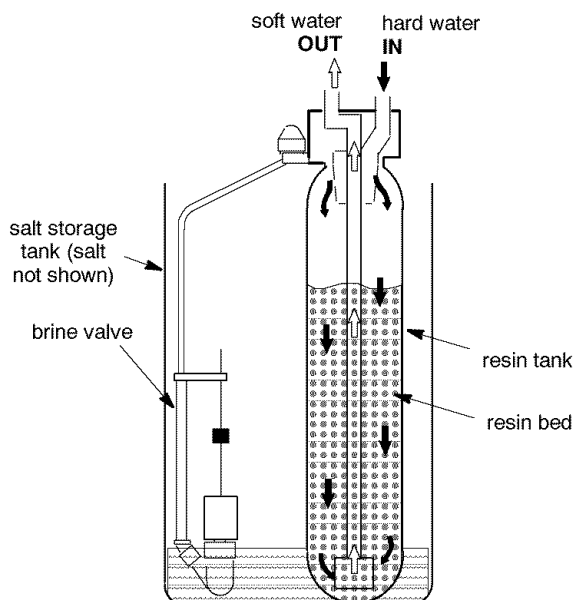

REGENERATION

1 **FILL:** Salt, dissolved in water, is called brine. Brine is needed to clean the hardness minerals from the resin beads. To make the brine, water flows into the salt storage area during the fill stage as shown in FIG. 6. Fill cycle length depends on how much soft water making capacity you have used since the last regeneration. As you use more water, fill time increases so more brine is made. The greater amount of brine cleans more hardness minerals from the resin bed.

FIG. 6

Water Flow Through the Softener in Fill

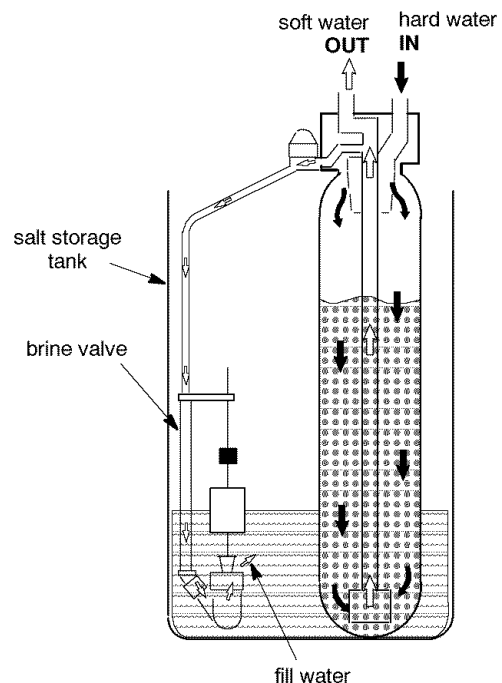

B. SOFT WATER SERVICE and REGENERATION

2 BRINING: During brining, the brine is moved from the salt storage area, into the resin tank. Inside the resin tank, brine cleans hardness minerals from the resin beads and they are discharged out the drain. How much brine is needed to clean the resin depends on:

- the amount of service water used between regenerations,
- the amount of resin in the softener,
- how fast the brine goes through the bed.

The nozzle and venturi (FIG. 7) makes suction to take brine from the salt tank and put it into the resin tank. They keep the brine flow down to a very slow rate to get the best resin cleaning with the least salt.

3 BRINE RINSE: After all of the brine is moved into the resin tank, the brine valve closes. Water keeps flowing the same way it did during brining except the brine flow has stopped. Hardness minerals and brine flush from the resin tank to the drain. Brining and brine rinse together vary in the length of time they take, relative to the fill cycle length.

FIG. 7

Water Flow Through the Softener in Brining and Brine Rinse

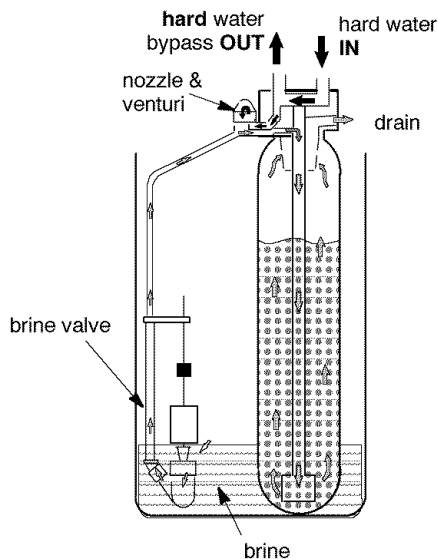

4 BACKWASH: During backwash, water flows UP through the resin tank (FIG. 8) at a fast rate to flush iron minerals, dirt and sediments from the bed

and to the drain. The bed lifts and expands for good cleaning.

FIG. 8

Water Flow Through the Softener in Backwash

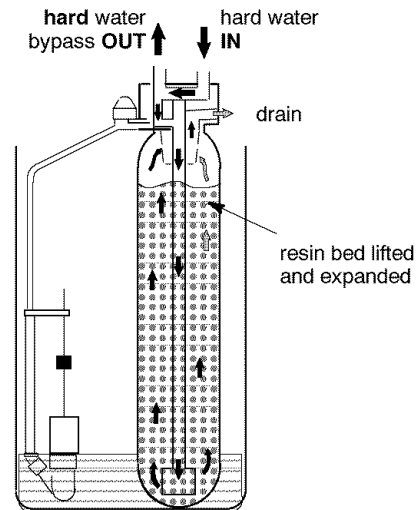

5 FAST RINSE: Backwash is followed by a fast flow of water down through the resin tank. The fast flow packs the resin bed and gets it ready for return to service (FIG. 9).

After fast rinse, the softener returns to service. Hard water goes into the resin tank where the resin bed again takes out the hardness minerals. Soft water goes to the house soft water pipes.

FIG. 9

Water Flow Through the Softener in Fast Rinse

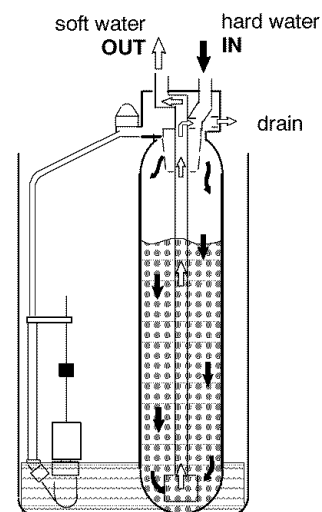

B. SOFT WATER SERVICE and REGENERATION

AUTOMATIC BYPASS

During the brining, brine rinse and backwash cycles of regeneration, HARD water goes through the softener valve and to the house pipes. If a faucet is opened, hard water is there for your needs. However, you should not use **hot** water, if possible, because the water heater will refill with hard water. The softener, as factory programmed, regenerates from 2:00 AM to about 4:00 AM, a time when not much water is used.

If you start your day prior to 4 AM, you may need to change the recharge starting time. Set the recharge time to 12:00 AM or 1:00 AM (page 1-4). Then regeneration will start and end that much earlier and your water heater will not refill with hard water if a hot faucet is opened.

ELECTRONICS

Two main parts of the softener's electronics are ① a WATER METER, and ② a COMPUTER.

① WATER METER — The water meter is in the softener valve outlet. As water flows through the meter, it sends electric pulses to the computer. The computer changes the pulses to a measure in gallons of water.

② COMPUTER — The computer is part of the faceplate timer circuit board. It is programmed to know the softener's capacity (how many grains of hardness minerals it will take out of the water before a regeneration is needed). When starting the softener, page 1-4, you set it for the grains per gallon (gpg) hardness of the water.

To find a regeneration pattern best for your needs, the computer uses: (1) water usage from the meter, (2) hardness setting, (3) softener capacity, and (4) time since the last regeneration. The computer always adjusts this pattern to your water using habits. It works toward providing you with soft water for the longest time and at the most efficient salt usage.

Softening capacity is used as hard water goes through the softener and hardness minerals are removed. When the computer determines that only enough capacity remains to provide soft water up to the next regeneration starting time (2:00 AM, or as otherwise set) it will schedule a regeneration. *RECHARGE TONIGHT* displays until the regeneration begins. When the regeneration begins, *RECHARGE TONIGHT* goes off and **RECHARGE* or *RECHARGE TIME REMAINING* flashes during the regeneration.

* Note:

If the CLEAN feature is set to ON, a cleaning backwash (*CLEAN* and *Bkwsh* or *Rinse* flashes in the display, along with the minutes of the clean cycle remaining), precedes the recharge.

A. SALT: REFILLING STORAGE TANK, SALT BRIDGE

WHEN TO REFILL WITH SALT: The Salt Monitor System (see page 2-1) will turn the low salt light *on* to warn you when to refill with salt. Check for a low salt light a few weeks after you install the softener, and every week after that. **Always refill** at about the #2 salt monitor level. At this level,

the tank is about 1/3 full. Never let the softener use all the salt before refilling. Without salt, you will soon have hard water. After filling, reset the Salt Monitor System, page 2-1.

Note:

You will have a loss in softening capacity and may get partly hard water if less than 10 inches (salt monitor level 2) of salt is in the storage tank.

**PLEASE SEE PAGE 1-6 FOR SALT FILLING DIRECTIONS.
BE SURE TO RESET THE SALT MONITOR, PAGE 2-1.**

SALT BRIDGE

Sometimes, a hard crust or salt bridge forms in the salt storage tank. It is usually caused by high humidity or the wrong kind of salt. When the salt bridges, an empty space forms between the water and salt. Then salt will not dissolve (melt) in the water to make brine. Without brine, the resin bed does not regenerate and you will have hard water.

If the storage tank is full of salt, it is hard to tell if you have a salt bridge. Salt is loose on top, but the bridge is under it. The following is the best way to check for a salt bridge.

Salt should be loose all the way to the bottom of the tank. Hold a broom handle, or like tool, up to the softener as shown in FIG. 10. Make a pencil mark on the handle, 1" or 2" below the top height of the rim. Then, carefully push it straight down into the salt. If a hard object is felt before the pencil mark gets to the top of the tank, it's most likely a salt bridge. Carefully push into the bridge in a few places to break it. **Do not try to break the salt bridge by pounding on the outside of the salt tank. You may damage the tank.**

If the wrong kind of salt made the bridge, take it out. Then fill the tank with nugget or pellet salt only.

FIG. 10

Salt Bridge

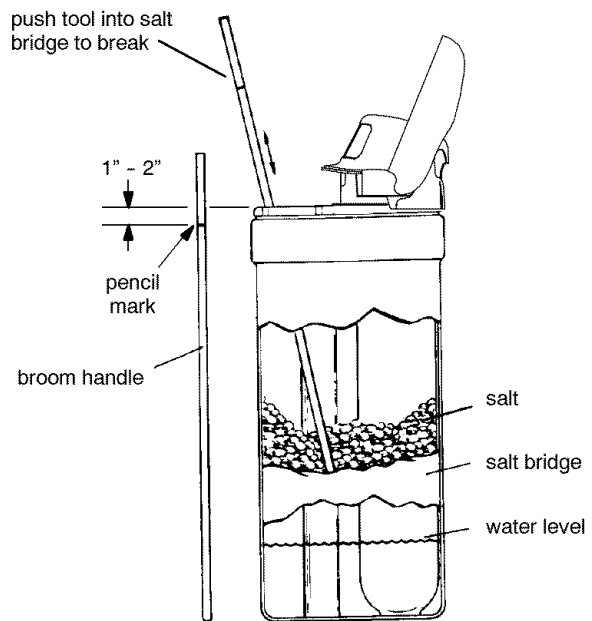

B. KEEPING THE WATER SOFTENER CLEAN

NOZZLE & VENTURI

A clean nozzle and venturi (FIG. 11) is a must for the softener to work right. This small unit moves brine from the salt storage tank to the resin tank during regeneration. If it becomes plugged with sand, silt, dirt, etc., the softener will not work and you will get hard water.

To get to the nozzle and venturi, remove the softener top cover. Be sure the softener is in service cycle (no water pressure at nozzle and venturi).

- 1) Turn off the cap from the nozzle and venturi housing.
- 2) Lift out the screen support and screen, *do not lose the large o-ring seal.*
- 3) Then the nozzle and venturi. Wash and rinse the parts in warm water until clean. If needed, use a small brush to remove iron or dirt. Also check and clean the gasket, flow plugs and screens.

Carefully replace all parts in the correct order. Lubricate the o-ring seal with silicone grease or Vaseline and place in position. Install and tighten the cap, **by hand only. Do not overtighten and break the cap or housing.**

IRON FROM RESIN BED

Your water softener takes hardness minerals (calcium and magnesium) out of the water. It can also control some "clear water" iron. See maximum allowed in the specifications on page 4-1. With clear water iron, water from a faucet is clear when first put into a glass. After 15 to 30 minutes, the water begins to cloud or turn rust colored. A water softener WILL NOT remove any iron which makes the water cloudy or rusty as it comes from the faucet (called red water iron). To take red water iron out of water, or over the maximum of clear water iron, an iron fil-

FIG. 11 Cleaning Nozzle & Venturi

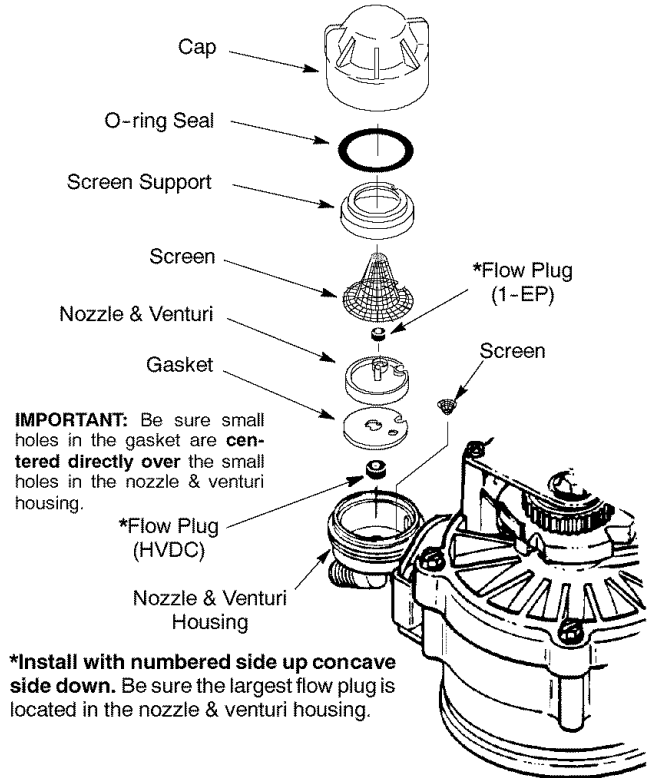

ter or other equipment is needed. Your local Sears store has trained people to help you with iron water problems.

If your water supply has clear water iron, even though less than the maximum allowed, regular resin bed cleaning is needed. Sears has resin bed cleaner, Item No. 42-34426 for this. Clean the bed at least every 6 months. If iron shows up in the soft water before 6 months, clean more often. Printed instructions are on the resin bed cleaner bottle.

C. PROTECT THE WATER SOFTENER FROM FREEZING

If the softener is installed where it could freeze (summer cabin, lake home, etc.), you must drain all water from it to stop possible freeze damage. To drain the softener:

1. Close the shut-off valve on the house main water pipe, near the water meter or pressure tank.
2. Open a faucet in the soft water pipes to vent pressure in the softener.
3. Refer to FIG. 14 on page 4-1. Move the stem in a single bypass valve to bypass. Close the inlet and outlet valve in a 3-valve bypass system, and open the bypass valve. If you want water in the house pipes again, reopen the shut-off valve on the main water pipe.
4. Unplug the transformer at the wall outlet. Remove the salt hole cover and the main cover. Take off both drain hoses.
5. Carefully remove the large holding clips at the softener inlet and outlet (see Key No. 67, on page 6-3). Separate the softener from the copper tubes, or from the bypass valve.
6. Remove the brinewell cover and disconnect the brine valve tubing at the nozzle and venturi assembly (see page 3-2). Lift the brine valve out of the brinewell. Tip the brine valve upside down to drain water.

FIG. 12 Drain All Water From Softener

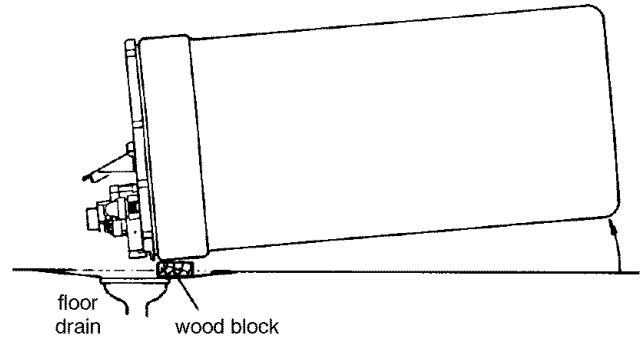

7. Looking at FIG. 12, lay a piece of 2 inch thick board near the floor drain. Move the softener close to the drain. SLOWLY and CAREFULLY, tip it over until the rim rests on the wood block with the inlet and outlet over the drain. **Do not allow the softener's weight to rest on the inlet and outlet fittings or they will break.**
8. Tip the bottom of the softener up a few inches and hold until all water has drained. Leave the softener laying like this until you are ready to use it. Plug the inlet and outlet with rags to keep dirt, bugs, etc. out.

D. CHECKLIST ... TO HELP YOU SAVE MONEY

If your water softener fails to work, make the following easy checks. Often, you will find what's wrong yourself and you won't have to call and wait for service. If you do not find anything wrong, while making the checks, and your softener still does not work, call your Sears Service Department.

Note:

1. Also read ERROR CODE, page 2-3.

2. If an error code is **not** displayed, press and *hold* the SELECT button until the display changes. Then, press the SELECT button again and *hold* until a flashing SR code appears. It must show **SR27**. If any other number shows, the face plate computer is working on incorrect input and would probably be the cause of the problem. **To set SR27**, press either the UP or DOWN button. When SR27 shows, press SELECT to return a flashing 12:00 AM display. *Reset the present time, hardness number, etc., pages 1-3 and 1-4.*

PROBLEM	CAUSE	CORRECTION
No soft water	No salt (or salt bridged) in the storage tank	Refill with salt, or break the salt bridge (page 3-1). Press ON/OFF-HOLD (RECHARGE NOW) button and hold for 3 seconds to start a regeneration (see page 2-1).
	Transformer unplugged at the wall outlet, or power cable leads loose, fuse blown, circuit breaker popped, or circuit switched off.	Check for loss of power due to any of these and correct. With the power back on, look at the time display and read PROGRAM MEMORY, page 2-3.
	Manual bypass valve(s) in bypass position	Look at FIG. 14 on page 4-1. Move the stem in a single valve to service. In a 3-valve bypass, open the inlet and outlet valves, and be sure to fully close the bypass valve.
	Dirty, plugged or damaged nozzle & venturi	Take apart and clean or replace damaged parts (see page 3-2).
	Valve drain hose plugged	The drain hose must not have kinks, sharp bends, or be raised too high above the softener (see page 16 in your <i>installation manual</i>).
Water hard sometimes	Hardness number setting too low	Press and release the SELECT button until HARDNESS shows in the display. Read the hardness number in the display and be sure the same grains per gallon number is shown on your water analysis report. See page 1-4 to reset. Press and release the SELECT button until the present time shows in the display.
	Using hot water when softener is regenerating	Avoid using hot water during this time because the water heater refills with hard water (see Automatic Bypass, page 2-6).
	Increase in the grains of hardness in your water supply	Ask your Sears retail store for a new water analysis. Then make a new hardness number setting (page 1-4).

A. DIMENSIONS / SPECIFICATIONS

SECTION 4

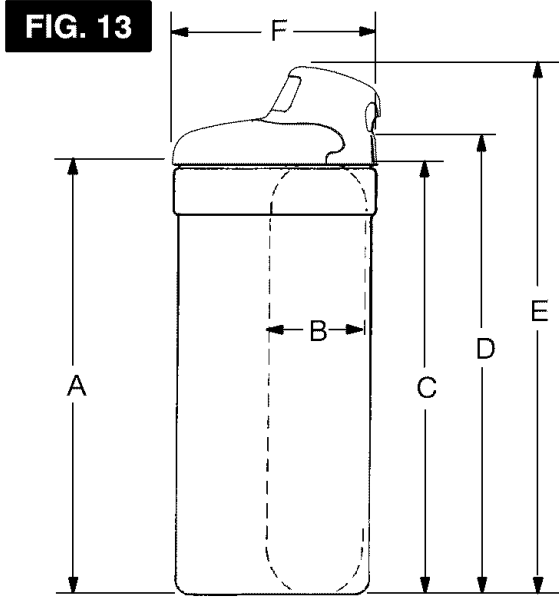

		Inches	CM
A	Salt Tank Height	40-1/4	102.2
B	Resin Tank Diameter (nominal)	9	22.7
C	Resin Tank Height (nominal)	40	101.6
D	Inlet-Outlet Height	41-1/2	105.4
E	Overall Height	47-3/4	121.3
F ¹	Length	19-1/2	49.5
F ²	Width	16-1/2	41.9
—	Distance between inlet-outlet center lines	3-3/8	8.6

FIG. 14

BYPASS VALVES

Bypass valve(s) should always remain in soft water service position. Position in "bypass" only if needed for softener repairs.

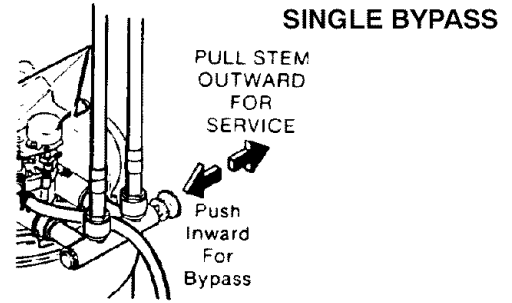

3 - VALVE BYPASS

FOR SERVICE
close bypass valve
open inlet & outlet valves

FOR BYPASS
open bypass valve
close inlet & outlet valves

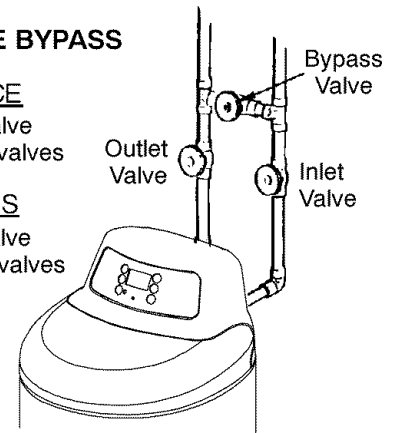

MODEL NOS. 625.388200 & 625.388250

TIMER SR CODE SR27

Note: Please see the rating decal for operating capacity, salt usage and service flow rate/pressure loss performance specifications. Performance specifications are validated by the Water Quality Association (WQA). The rating decal is located on the rim, under the salt hole cover (see page A, inside front cover).

WATER SUPPLY TO WATER SOFTENER	
Minimum water system flow (gpm) -----	3
Minimum-Max. water pressure (psi) ----	20 - 125
Minimum-Max. water temperature (°F) -	40 - 120
Maximum water hardness (gpg) -----	100
Maximum "clear water" iron (ppm) ----	6
SALT FOR WATER SOFTENER	
Type of salt needed -----	nugget or pellet
Alternate type of salt -----	pure, evaporated, compacted water softener salt
Salt storage capacity (lbs) -----	200

A. DIMENSIONS / SPECIFICATIONS

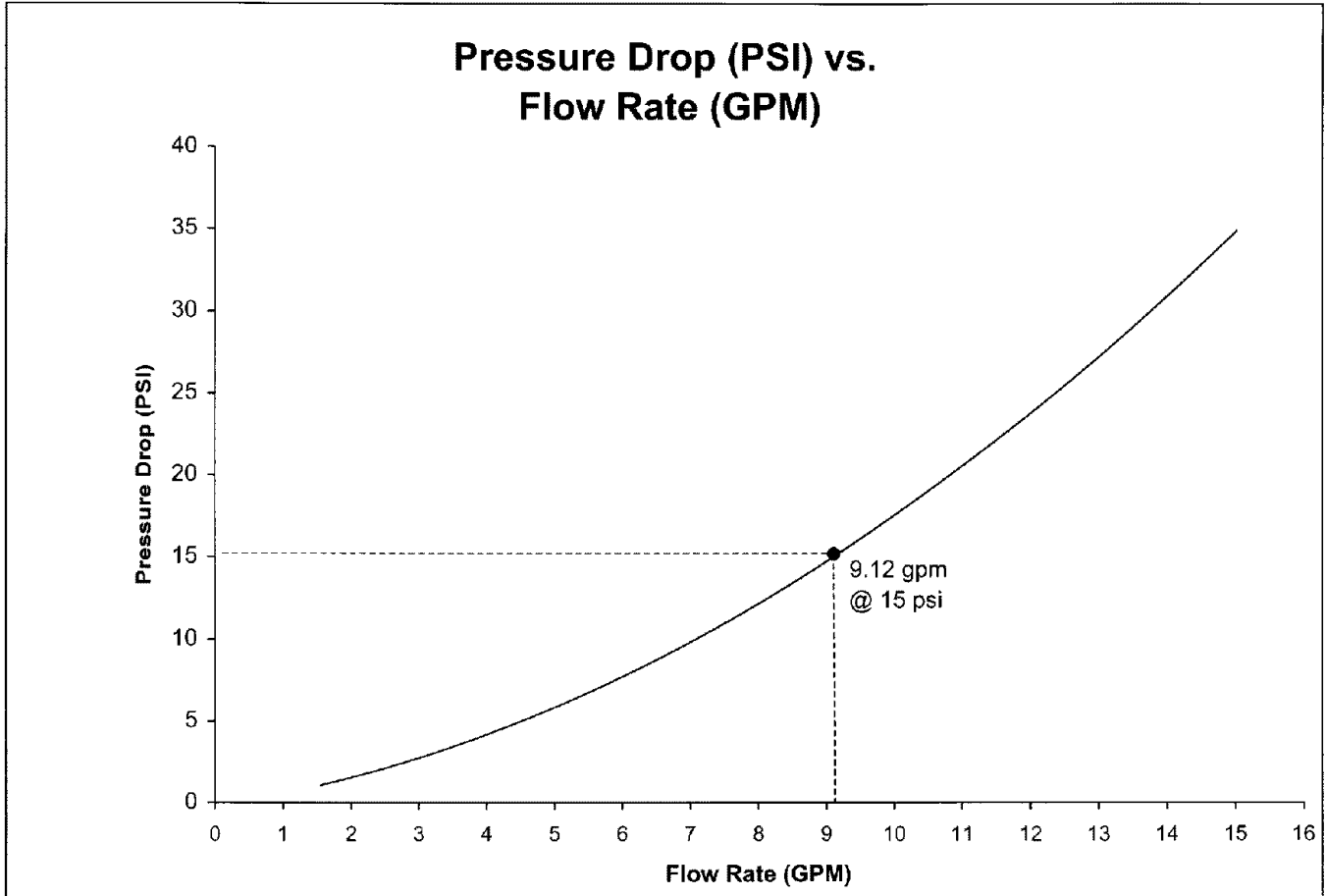

OTHER SPECIFICATIONS	
Type of ion exchange material (resin) --	high capacity
Amount of resin (cu ft) -----	0.87
Regeneration (recharge) cycle times (minutes)	
Fill -----	3 - 9.48
Brining / brine rinse -----	91 - 100
Backwash -----	7
Fast rinse -----	3
Total regeneration time ① -----	108 - 118
Efficiency Rating (gr/lb at 2.6 lb salt dose) -----	5060

gpm = gallons per minute

gpg = grains per gallon

psi = pounds per square inch

ppm = parts per million

① Does not include CLEAN feature cycle times if set to ON.

This system conforms to ANSI/NSF 44 for the specific performance claims as verified and substantiated by test data.

The efficiency rating is only valid at the stated salt dosage. These softeners were efficiency rated according to ANSI/NSF Standard 44.

A. TROUBLESHOOTING

WIRING SCHEMATIC

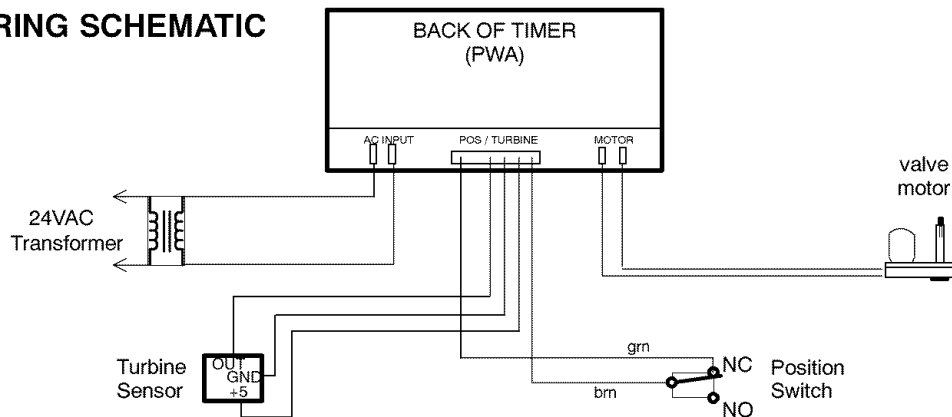

FACEPLATE

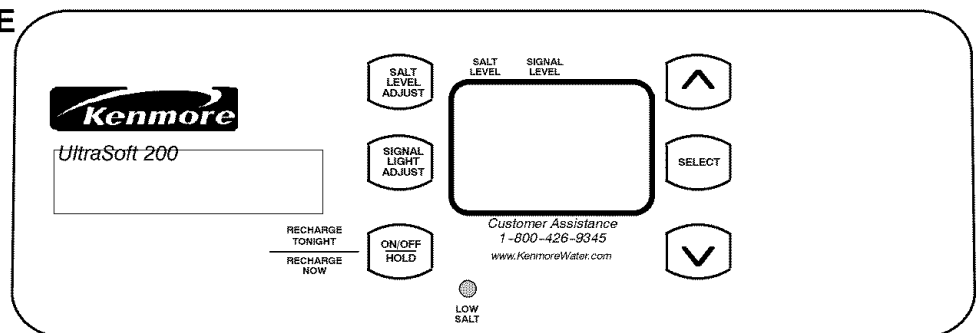

Keep this manual with your water softener. If repairs are needed, the service technician must have the information on the following 8 pages. For telephone assistance, call toll free, 1-800-426-9345.

ALWAYS MAKE THESE INITIAL CHECKS FIRST

1. Does the time display show the correct time of day?
 - If display is blank, check power source to the softener.
 - If time is flashing, power was off for over 24 hours. The softener resumes normal operation but regenerations occur at the wrong time.
 - If an error code (Example: Err3) shows in the faceplate display, go to *AUTOMATIC ELECTRONIC DIAGNOSTICS*, page 5-2.
2. Plumbing bypass valve(s) must be **fully in service position**.
3. The inlet and outlet pipes must connect to the softener inlet and outlet respectively.
4. Is the transformer plugged into a "live", grounded wall outlet, and the power cable fastened securely?
5. The valve drain hose must be free of kinks and

sharp bends, and not elevated over 8 ft. above the floor.

Remove the top cover and salt tank cover.

6. Is there salt in the storage tank?
7. Is the brine tubing connected? Brine tubing connects to nozzle venturi and brine valve assembly. (See page 6-3, key #83)
8. Is the brine valve float set right? (See page 5-4).
9. Press the SELECT button two times to display the hardness setting. Be sure it is the correct setting for the household's water supply. (Make a hardness test of the raw water and compare with the hardness setting. Also test a soft water sample to verify if a problem exists.) Press the SELECT button twice more to return to present time in the display.

If you do not find the problem after making initial checks, do the *MANUAL INITIATED ELECTRONIC DIAGNOSTICS*, and the *MANUAL ADVANCE REGENERATION CHECK*.

A. TROUBLESHOOTING

AUTOMATIC ELECTRONIC DIAGNOSTICS

The faceplate timer (PWA) computer has a self-diagnostic function for the electrical system, except for input power and water meter. The computer monitors electronic components and circuits for correct operation. If a malfunction occurs, an error code appears in the faceplate display.

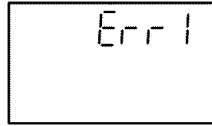

The chart below shows the error codes that could appear, and the possible defects for each code.

While an error code appears in the display, all faceplate buttons are inoperable except the SELECT button. SELECT remains operational so the service person can make the MANUAL INITIATED ELECTRONIC DIAGNOSTICS (below) to further isolate the defect, and check the water meter.

CODE	POSSIBLE DEFECT	
	MOST LIKELY ←	→ LESS LIKELY
Err1, Err3, Err4	motor inoperative / wiring harness or connection to switch / position switch / valve defect causing high torque	
Err5	faceplate timer (PWA)	

PROCEDURE FOR REMOVING ERROR CODE FROM FACEPLATE: 1. Unplug transformer 2. Correct defect 3. Plug in transformer 4. Wait for 6 minutes. The error code will return if the defect was not corrected.

MANUAL INITIATED ELECTRONICS DIAGNOSTICS

- To enter diagnostics, press the SELECT button and hold for three seconds.

You will see the following display, showing valve cycle position, position switch status (open or closed), and turbine operation.

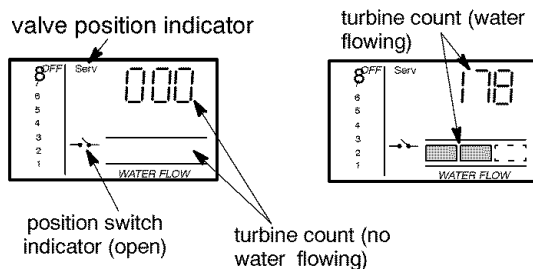

TURBINE OPERATION: If no water is flowing through the softener, the turbine indicator displays three zeros. When water is flowing, the flow bar scrolls across the display, and a 000 to 140 count repeats for each gallon of water passing through the turbine. To check for positive operation of the turbine if zeros are shown, open a nearby soft water faucet and observe the turbine count and flow bar.

If you don't get a reading in the display, with faucet open, pull the sensor from the valve outlet port.

Pass a small magnet back and forth in front of the sensor. You should get a reading in the display. If you get a reading, unhook the in and out plumbing and check the turbine for binding.

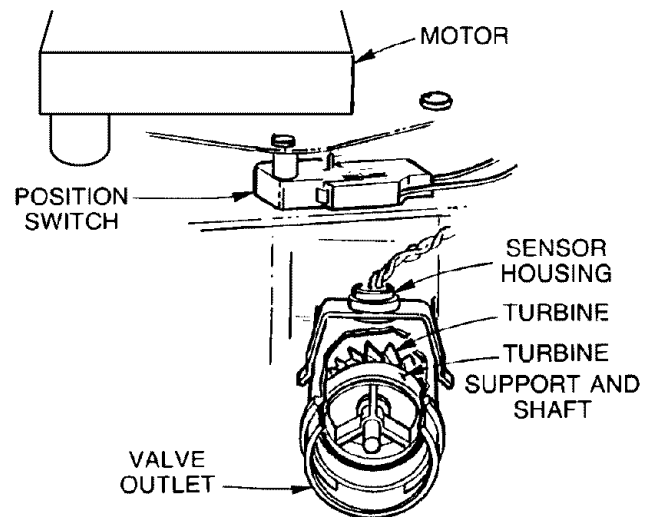

POSITION SWITCH STATUS: With the valve in service, or any of the recharge cycles, the switch indicator will show open \rightarrow . While the valve is rotating from 1 position to another, the indicator will show the switch closed \leftarrow . A defect is probable if indications vary from this pattern.

A. TROUBLESHOOTING

VALVE POSITION INDICATORS: Depending on the valve position, the following indicators show in the display:

INDICATOR	VALVE POSITION
Serv	service
Fill	fill
Brine	brining/brine rinse
Bkwash	backwash
Rinse	fast rinse

When the valve is rotating from one cycle to another, both indicators flash. For example, if the valve is in transition between fill and brining, both **Fill** and **Brine** flash. Upon reaching brining position, Fill goes off and Brine is on steady. The time display shows the minutes of the cycle remaining.

NOTE: If the faceplate is left in a diagnostic display (or a flashing display when setting times or hardness), present time automatically returns if a button is not pressed within 4 minutes. To return to the diagnostic display, repeat step 2.

OTHER INFORMATION: While in this diagnostic screen, the following information is available and may be beneficial for various reasons. This information is retained by the computer from the first time electrical power is applied to the faceplate.

...Press to display the number of days this face plate has had electrical power applied.

...Press to display the number of regenerations initiated by this faceplate since the SR code number was entered.

2. Press the ON/OFF-HOLD button to advance the valve to each position and observe the switch and position indicators to verify component operation, or to possibly isolate a defect.

3. Press and hold the SELECT button for 3 seconds until...

...SR27 shows.

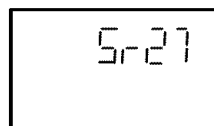

This code identifies the softener nominal capacity size. If the wrong number shows, the softener will

operate on incorrect programming. Do the following as needed.

SR27 does show — Press the SELECT button to return to the present time display.

To change SR number — Press the UP or DOWN button until SR27 shows. Then, press the SELECT button and reset the timer...page 1-3.

TIMER PWA REPLACEMENT: Be sure the valve is in service position when replacing the timer PWA (observe valve cycle indicator).

If, after installing and programming the replacement timer PWA, the valve is not in service position, do the following to assure correct cycle orientation, or timing, between the faceplate and valve.

Use the MANUAL ADVANCE procedures, page 5-4. With the RECHARGE NOW button, advance through the recharge cycles until the valve stops in service position, and RECHARGE no longer flashes in the display.

NOTE: The valve motor may automatically drive through several valve positions while searching for service. If an error code occurs, unplug the transformer, then plug in again.

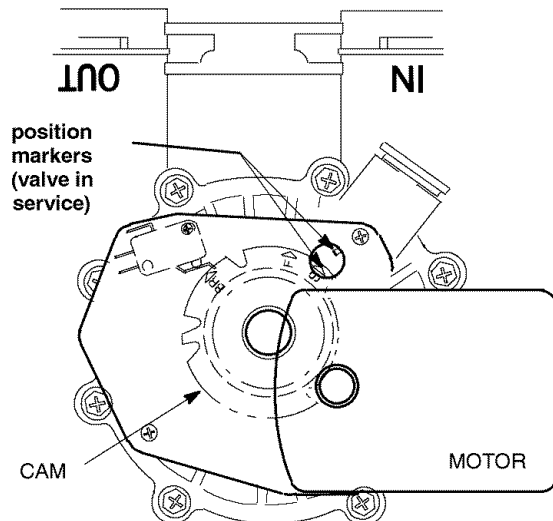

A. TROUBLESHOOTING

MANUAL ADVANCE REGENERATION CHECK

This check verifies proper operation of the valve motor, brine tank fill, brine draw, regeneration flow rates, and other controller functions. **Always make the initial checks, and the manual initiated diagnostics.**

Notes:

The faceplate display must show a steady time (not flashing). If an error code shows, first press the SELECT button to enter the diagnostic display.

1. Press the ON/OFF-HOLD button and hold in for 3 seconds. *RECHARGE and Fill begin to flash (or clean backwash begins, if set) as the softener enters the fill cycle of regeneration. When FILL is on steady, remove the brinewell cover and, using a flashlight, observe fill water entering the tank.

*Note:

If the CLEAN feature is set to ON, a cleaning backwash (CLEAN and Bkwh or Rinse flashes in the display, along with the minutes of the clean cycle remaining), precedes the recharge.

- a. If water **does not** enter the tank, look for an obstructed nozzle, venturi, fill flow plug, brine tubing, or brine valve riser pipe.

CYCLE FLOW RATES (GALLONS PER MIN.)

FILL (flow to salt storage tank)	0.3 (1.1 liters)
BRINING	.16 (.61 liters)
BRINE RINSE	.12 (.45 liters)
BACKWASH	1.8 (6.8 liters)
FAST RINSE	1.8 (6.8 liters)

(flow to drain)

2. After observing fill, press the ON/OFF-HOLD button to move the softener into brining. A slow flow of water to the drain will begin. Verify brine draw from the brine tank by shining a flashlight into the brinewell and observing a noticeable drop in the liquid level.

Note:

Be sure a salt bridge is not preventing water with salt contact.

- a. If the softener does not draw brine...
 - ...nozzle and/or venturi dirty or defective. See page 3-2
 - ...nozzle and venturi not seated properly on gasket. See page 3-2
 - ...restricted drain (check drain fitting and hose).
 - ...defective nozzle and venturi seal. See page 3-2
 - ...other inner valve defect (rotor seal, rotor & disc, wave washer, etc.).

Note: If water system pressure is low, an elevated drain hose may cause back pressure, stopping brine draw.

3. Again press ON/OFF-HOLD to move the softener into backwash. Look for a fast flow of water from the drain hose.

- a. An obstructed flow indicates a plugged top distributor, backwash flow plug, or drain hose.

4. Press ON/OFF-HOLD to move the softener into fast rinse. Again look for a fast drain flow. Allow the softener to rinse for a few minutes to flush out any brine that may remain in the resin tank from the brining cycle test.

5. To return the softener to service, press ON/OFF-HOLD.

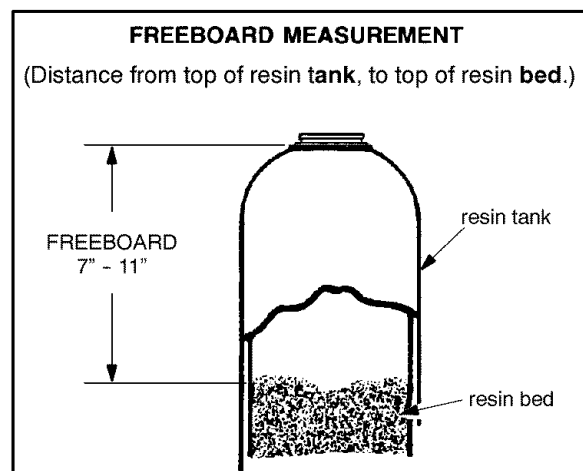
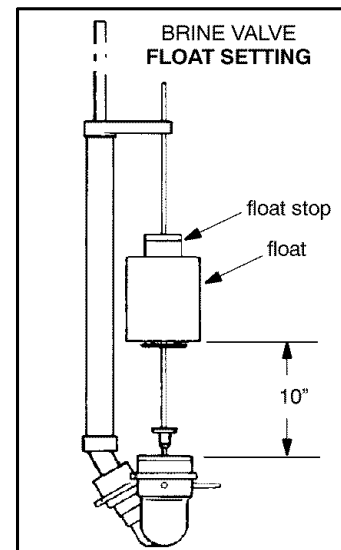

B. ROTARY VALVE SERVICE

Before working on the valve, **turn off the water supply** and **disconnect from electrical power**. **TO RELIEVE PRESSURE:**

- **3 VALVE BYPASS:** Close the inlet valve and open a soft water faucet. Then close the outlet valve and open the bypass valve.
- **SEARS SPECIAL BYPASS:** Slide the bypass valve stem to bypass position. *Loosen* three hex head screws toward the back side of the valve to allow pressure water to bleed out. Catch water with a rag.

DISASSEMBLY

To remove a part or group of parts, refer to the valve drawing. A common screwdriver or nut driver, Phillips screwdriver and pliers are the only tools needed to completely disassemble.

SERVICING THE VALVE

Inspect all o-rings, seals and gaskets for wear or defects.

Inspect the bottom surface of the rotor for scratches, chips or wear.

Note:

If replacement is needed, be sure to use the current replacement part.

ASSEMBLY

Be sure all parts are in place and in the proper position. Lubricate ALL o-rings and seals with FDA approved silicone grease. To install the rotor seal, first place the seal into the valve groove, rounded side down (see cross-section). Apply a light coating of silicone grease to the seal's crossing ribs. Then, carefully center the wear strip on the seal, and push it downward onto the seal.

Install the nozzle and venturi seal and drain seal. Assemble wave washer bearing, the wave washer, and two o-rings onto the rotor top shaft. Then center the rotor in the valve body, on the rotor seal.

Lower the cover onto the valve body and rotor shaft. Then install the cover holding screws. **Before tightening the screws**, install the valve cam and gear. Then, turn the rotor (clockwise only) to service position. Tighten the screws using a criss-cross pattern. If a torque wrench is available, torque to 30-40 inch pounds. Do not over tighten.

Lubricate the gear on the motor, and the valve cam gear with Molykote grease, or other high quality gear lubricant.

Be sure to orient switch as shown, with lever toward the cam.

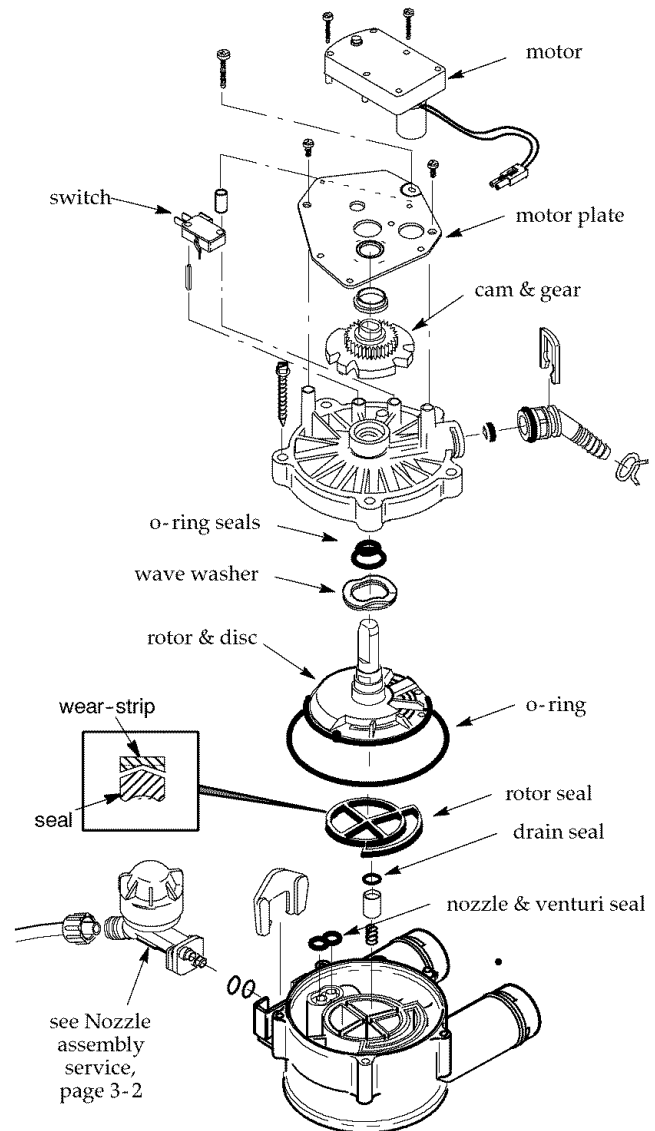

C. WATER FLOW THROUGH THE SOFTENER VALVE

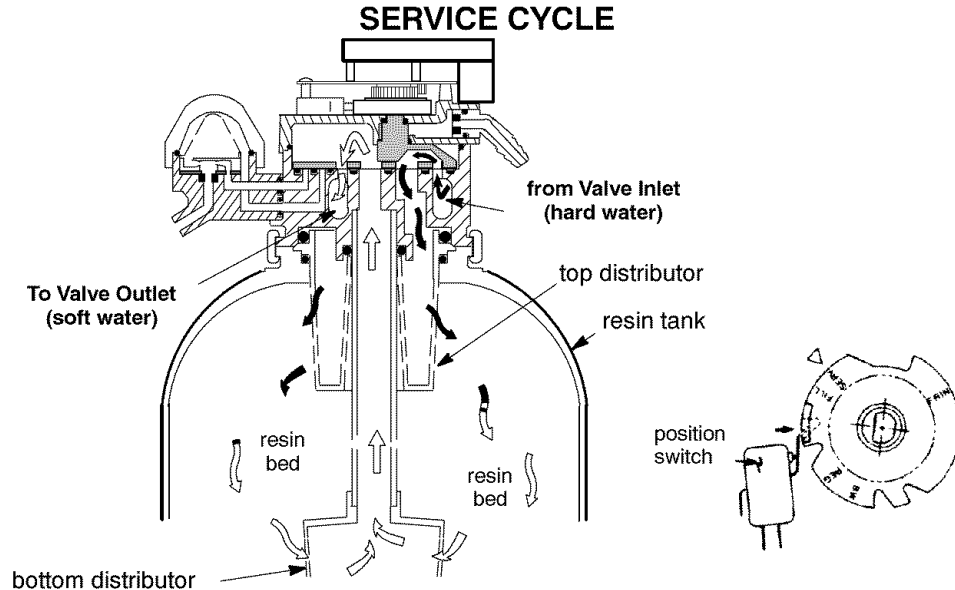

Hard water enters the valve inlet port. Internal valve porting routes the water down and out the top distributor, into the resin tank. Hard water is softened as it passes through the resin bed, then enters the bottom distributor. Soft water flows back into the valve and out the valve outlet, to the house soft water pipes.

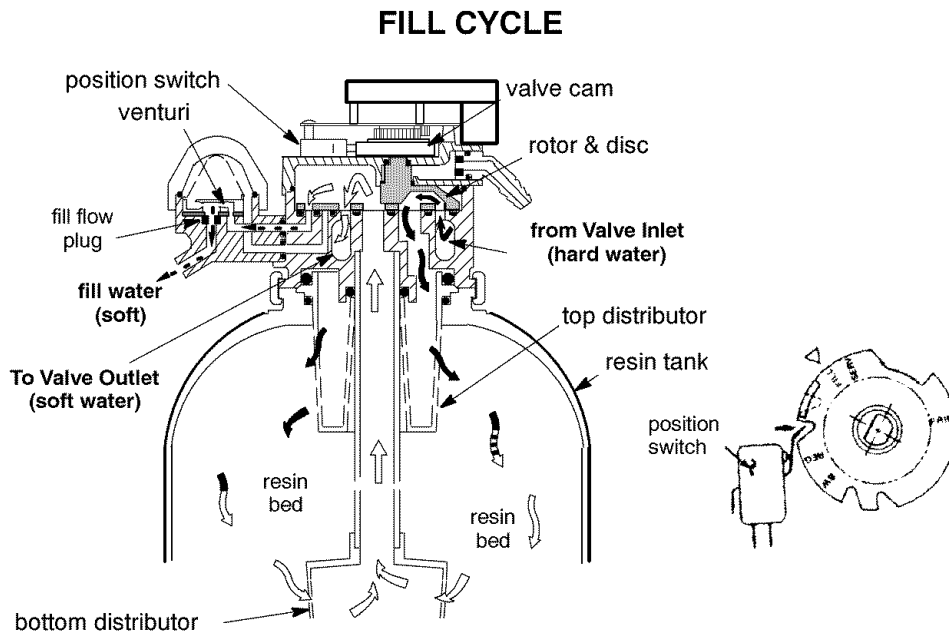

To begin a regeneration, the electronic timer energizes the circuit to the valve motor. The valve motor rotates the rotor and disc and the valve cam until the position switch lever drops, to open the motor circuit and position the valve in FILL. As the rotor and disc rotates, the port opens for SOFT water fill through the venturi. Fill flow continues to the brine valve, and into the salt storage tank. Soft water is still available to the house lines.

C. WATER FLOW THROUGH THE SOFTENER VALVE

BRINING AND BRINE RINSE CYCLES

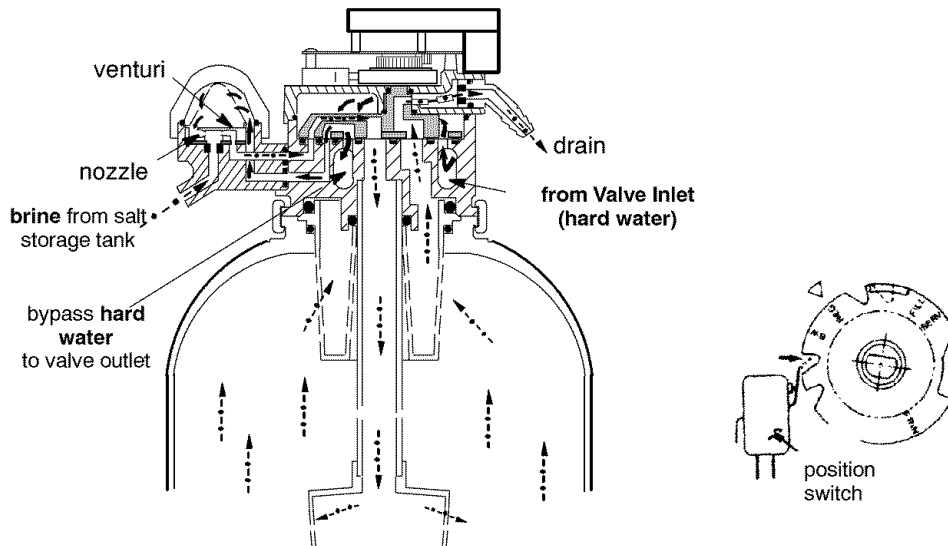

After fill, timer/switch action allows the motor to turn the rotor and disc into BRINING position. Water flow is directed to the nozzle. Suction, created by the nozzle and venturi, draws brine from the salt storage tank and injects it into the resin bed via the bottom distributor. Flow continues out the top distributor and to the drain. Hard water is available at the valve outlet.

When the brine valve closes to end brine draw, water flow continues in the same directions to slowly RINSE brine from the resin bed and to the drain.

BACKWASH CYCLE

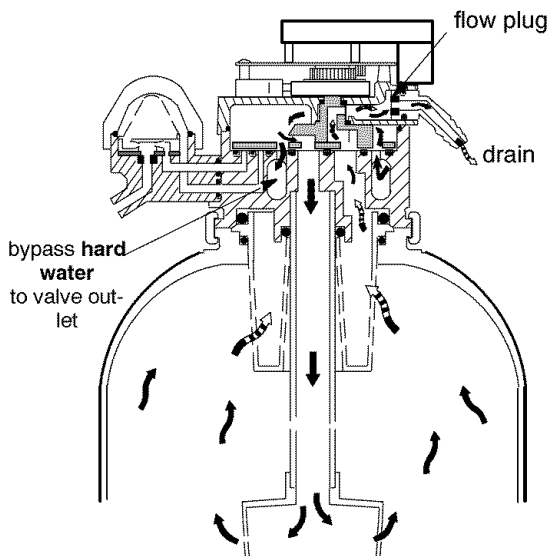

Timer/switch action again allows the motor to turn the rotor & disc to place the valve in BACKWASH, stopping water flow to the nozzle. Water is routed down and out the bottom distributor, up through the bed, and out the top distributor to the drain. The fast flow (controlled by a flow plug in the drain fitting) flushes dirt, sediments, iron deposits, remaining brine and hardness to the drain.

C. WATER FLOW THROUGH THE SOFTENER VALVE

FAST RINSE CYCLE

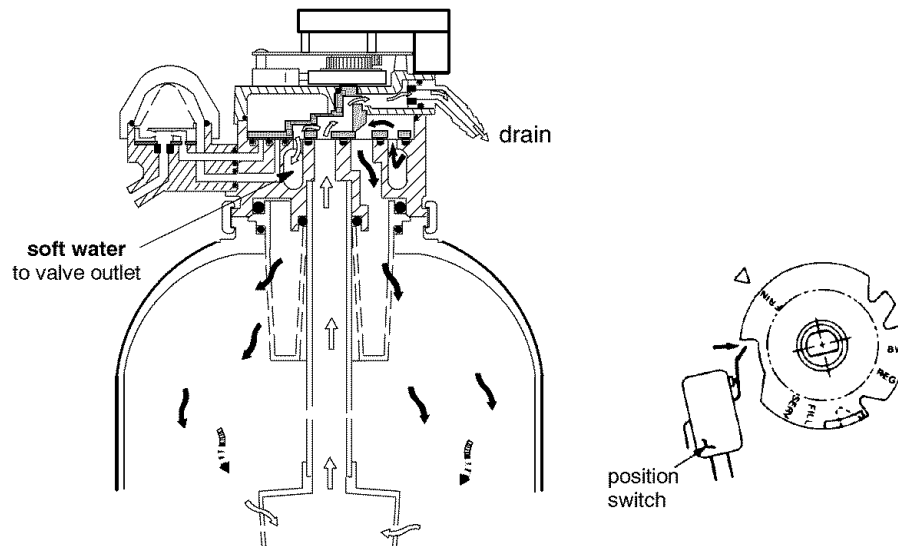

During FAST RINSE, the rotor & disc is positioned so water flow enters the resin tank through the top distributor, and exits through the bottom distributor, to the drain.

The electronic timer again energizes the motor to return the valve to *service*. As the valve rotates, the position switch lever drops to open the circuit. The valve remains positioned in service until the electronic timer initiates the next regeneration.

Kenmore MODEL NOS. 625.388200 & 625.388250

SECTION
6

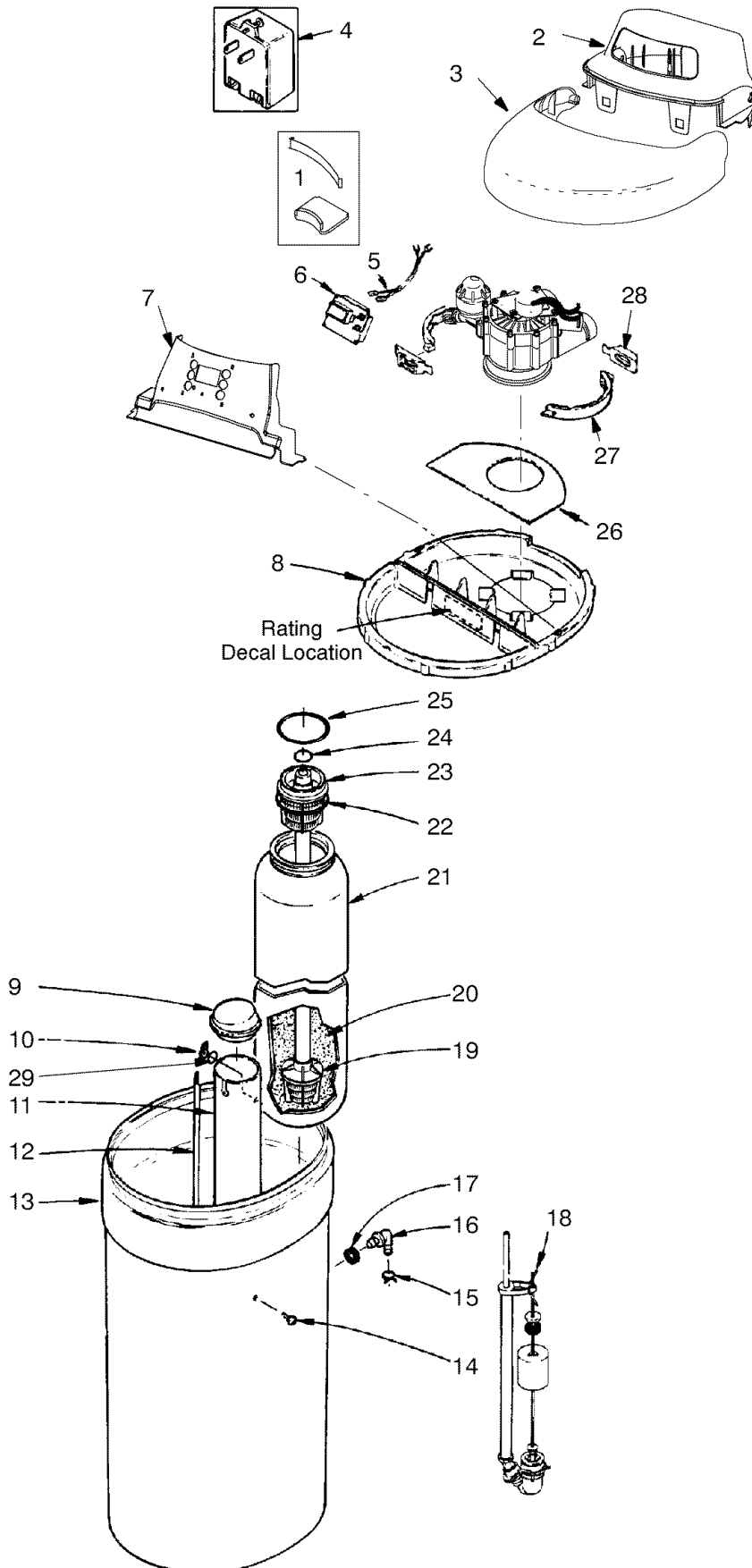

Kenmore MODEL NOS. 625.388200 & 625.388250

A. WATER SOFTENER COMPLETE

KEY NO.	PART NUMBER	DESCRIPTION
1	---	Cover Lock (req'd for ship. only)
1	---	Rim Insert (req'd for shipping only)
2	7230020	Cover (main)
3	7229998	Salt Hole Cover
4	7095373	Transformer, 24V-10VA
5	7132840	Power Cord (transformer)
6	7234757	Timer Repl. (PWA)
7	7230038	Faceplate (order following decal)
-	7232064	Faceplate Decal
8	7231571	Rim
9	7232080	Brinewell Cover
10	7082150	Wing Nut, 1/4"
11	7100819	Brinewell
12	7137913	Decal, Salt Level ①
13	7234723	Salt Storage Tank
14	7232250	Plastic Screw, 1/4" x 5/8"
15	0900431	Tube Clamp
16	1103200	Tube Adaptor
17	9003500	Grommet
18	7116488	Brine Valve Asm. (also see pages 6-3, 6-4)
19	7105047	Replacement Distributor
20	0502272	Resin
21	7144952	Resin Tank (includes Key No. 20)
22	7170270	O-Ring, 2-3/4" x 3"
23	7077870	Top Distributor
24	7170254	O-Ring, 13/16" x 1-1/16"
25	7170296	O-Ring, 2-7/8" x 3-1/4"
26	7141001	Vapor Barrier
27	7176292	Clamp Section (2 req.)
28	7088033	Clamp Retainer (2 req.)
29	7003847	O-Ring
◆	7231741	Installation Manual
◆	7231767	Owners Manual

◆ not illustrated

① Aligns with top of brinewell.

Kenmore MODEL NOS. 625.388200 & 625.388250

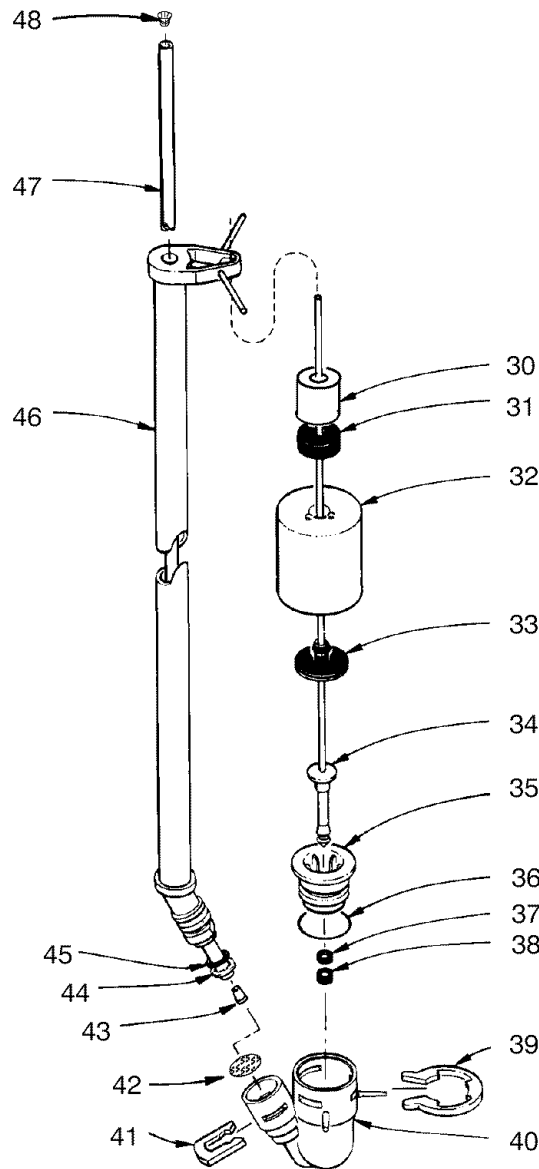

**INLET - OUTLET
GROUNDING CLAMPS**

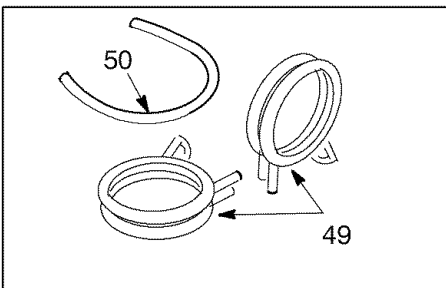

Kenmore MODEL NOS. 625.388200 & 625.388250

B. BRINE VALVE ASSEMBLY

KEY NO.	PART NUMBER	DESCRIPTION
30	7168647	Ceramic Weight
31	0513860	Float Stop
32	7097202	Float (includes Key No. 33)
33	0516947	Float Seal
34	7093216	Float Rod & Stem
35	7092278	Guide Cap
36	7170288	O-Ring 15/16 x 1-3/16
37	0516211	Seal
38	0516924	Retainer, Bottom Seal
39	7116713	Clip
40	7092252	Brine Valve Body
41	7080653	Clip
42	7131365	Screen
43	7094979	Insert
44	7092294	Retaining Ring
45	7176161	O-Ring, 5/16 x 9/16
46	7095470	Brine Tube
47	7113016	Tubing Assy. (includes Key Nos. 43, 44 & 45)
48	7171349	Cone Screen
49	7207718	Ground Clamp (2)
50	7207726	Ground Wire

C. VALVE ASSEMBLY

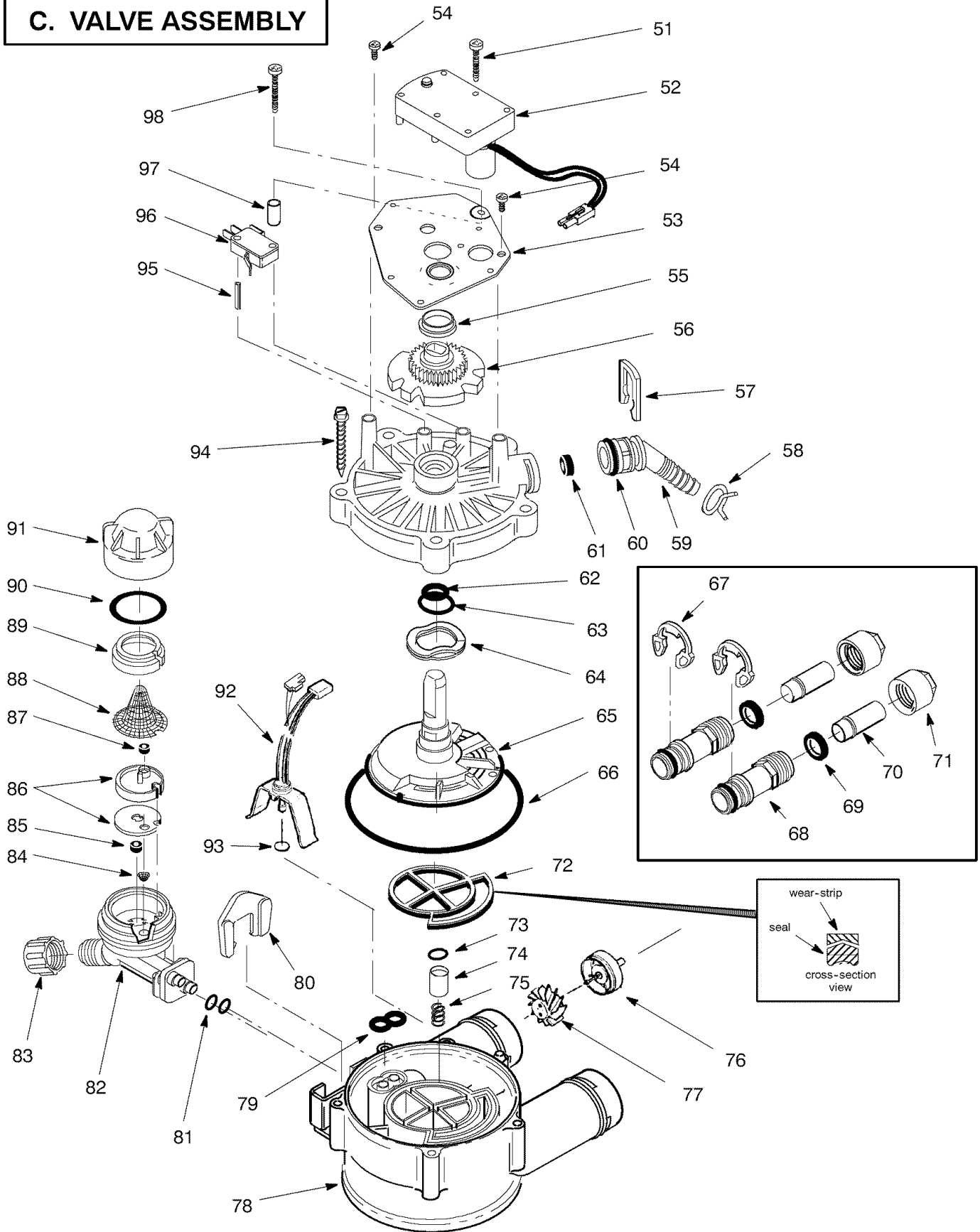

Kenmore MODEL NO. 625.388200 & 625.388250

C. VALVE ASSEMBLY

KEY NO.	PART NUMBER	DESCRIPTION
51	7224087	Screw, #8-32 x 1" (2 req.)
52	7234731	Motor (incl. 2 ea. of Key No. 51)
53	7231385	Motor Plate
54	0900857	Screw, #6-20 x 3/8 (2 req.)
55	0503288	Bearing
56	7113927	Cam and Gear
57	7142942	Clip (Drain)
58	0900431	Tubing Clamp
59	7024160	Drain Hose Adaptor
60	7170327	O-Ring, 5/8 x 13/16
61	0501228	Flow Plug
62	7170238	O-Ring, 7/16 x 5/8
63	7170212	O-Ring, 3/4 x 15/16
64	7082087	Wave Washer
65	7199232	Rotor & Disc
66	7170246	O-Ring, 3-3/8 x 3-5/8
67	7116713	Clip (2 req.)
68	2207800	Installation Adaptor (2 req.) ①
69	7170335	Washer (2 req.) ②
70	0507615	Installation Tube (2 req.) ②
71	0507369	Installation Nut (2 req.) ②
72	7134224	Rotor Seal
73	7170204	O-Ring, 3/8 x 9/16
74	7092642	Plug (Drain Seal)
75	7129889	Spring
76	2204101	Turbine Support and Shaft
77	7117858	Turbine
78	7082053	Valve Body
79	7081764	Seal (Nozzle & Venturi)

KEY NO.	PART NUMBER	DESCRIPTION
80	7081201	Retainer (Nozzle & Venturi)
81	7170319	O-Ring, 1/4 x 3/8 (2 req.)
82	7081104	Nozzle & Venturi Housing
83	1202600	Nut – Ferrule
84	7095030	Cone Screen
85	1148800	Flow Plug, .3 gpm
86	7187772	Nozzle & Venturi – Gasket Kit
–	7190547	Gasket (only)
87	0521829	Flow Plug, .1 gpm
88	7146043	Screen
89	7167659	Screen Support
90	7170262	O-Ring, 1-1/8 x 1-3/8
91	7199729	Cap
92	7235371	Sensor Housing
93	9000803	O-Ring
94	7074123	Screw, #10-14 x 2 (5 req.)
95	7077472	Expansion Pin
96	7030713	Switch
97	7117816	Spacer
98	7070412	Screw, #4-24 x 1-1/8 (flat head)
◆	7187065	Nozzle & Venturi Assy. (incl. Key Nos. 82, and 84 through 91)
◆	7129716	Seal Kit (incl. Key Nos. 62, 63, 66, 72, 73 and 79).
◆	42-3433	Drain Tubing, 3/8" I.D. x 20' ②

◆ not illustrated

① included with model 625.388200

② included with model 625.388250

BYPASS INSTALLATION VALVE
MODEL NO. 625.3437

KEY NO.	PART NUMBER	DESCRIPTION
100	0502206	Retainer Ring
101	7129863	Bypass Body
102	7105013	O-Ring, 13/16 x 1 (4 req.)
103	7130911	Stem
104	7170288	O-Ring, 15/16 x 1-3/16 (2 req.)
◆	42-3437	Bypass Valve (Complete) ②

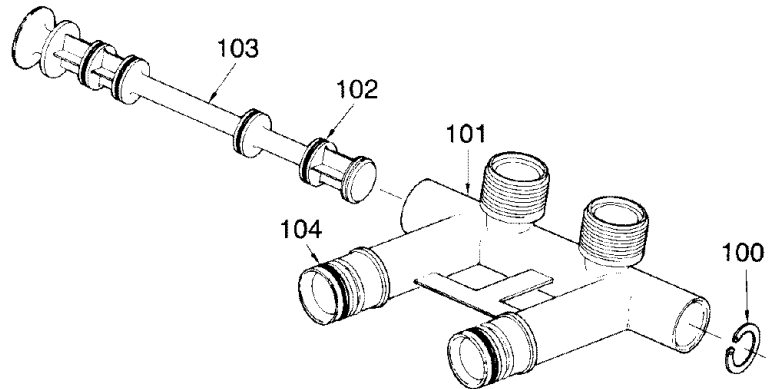

OWNER'S MANUAL

MODEL NOS.

625.388200
625.388250

The model number of your water softener is found on the rating decal. This decal is on the rim, under the salt cover.

When requesting service or ordering parts, always provide the following information:

- ◆ Product Type
- ◆ Model Number
- ◆ Part Number
- ◆ Part Description

www.KenmoreWater.com



UltraSoft 200 Water Softener

For the repair or replacement parts you need delivered directly to your home

Call 7 am - 7 pm, 7 days a week

1 - 800 - 366 - PART

(1 - 800 - 366 - 7278)

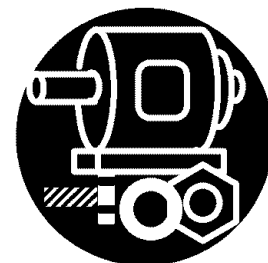

For in-home major brand repair service

Call 24 hours a day, 7 days a week

1 - 800 - 4 - REPAIR

(1 - 800 - 473 - 7247)

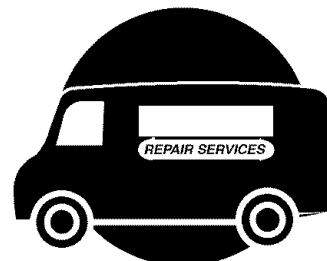

For the location of a
Sears Parts and Repair Center in your area

Call 24 hours a day, 7 days a week

1 - 800 - 488 - 1222



For information on purchasing a Sears
Maintenance Agreement, or to inquire
about an existing Agreement

Call 9 am - 5 pm, Monday - Saturday

1 - 800 - 827 - 6655



SEARS
REPAIR SERVICES

America's Repair Specialists

Sears, Roebuck and Co., Hoffman Estates, IL 60179 U.S.A.

7231767 (Rev. F 05/29/01)