

**KENWOOD**

HF TRANSCEIVER

**TS-140S**

MULTI BANDER

**TS-680S**

---

**INSTRUCTION MANUAL**

KENWOOD CORPORATION

Thank you for purchasing this new transceiver.

**IMPORTANT:**

Please read this Instruction Manual carefully before placing the unit in service.

**SAVE THIS INSTRUCTION MANUAL.**

The following explicit definitions apply in this manual:

**Note** : If disregarded, inconvenience only, no risk of equipment damage or personal injury.

**Caution** : Equipment damage may occur, but not personal injury.

This Instruction Manual covers the following models:

- TS-140S : HF Transceiver
- TS-680S : All Mode Multi Bander

Illustrations show the TS-140S.

## CONTENTS

1. BEFORE OPERATION .....	3	5-5. BLOCK DIAGRAM .....	29
2. SPECIFICATIONS AND ACCESSORIES .....	4	5-6. CIRCUIT DIAGRAM.....	Insert
2-1. SPECIFICATIONS.....	4	<b>6. MAINTENANCE AND ADJUSTMENTS.....</b>	<b>31</b>
2-2. ACCESSORIES .....	5	6-1. GENERAL INFORMATION .....	31
<b>3. INSTALLATION AND CONNECTION.....</b>	<b>6</b>	6-2. SERVICE.....	31
3-1. INSTALLATION .....	6	6-3. CLEANING .....	31
3-2. CONNECTION .....	6	6-4. IN CASE OF DIFFICULTY.....	32
<b>4. OPERATION .....</b>	<b>9</b>	6-5. ORDERING SPARE PARTS.....	33
4-1. OPERATING CONTROLS .....	9	6-6. ADJUSTMENTS.....	33
4-2. RECEIVER OPERATION.....	16	<b>7. OPTIONAL ACCESSORIES .....</b>	<b>35</b>
4-3. TRANSMITTER OPERATION.....	19	7-1. CW FILTER INSTALLATION.....	35
4-4. MEMORY.....	21	7-2. TU-8 TONE UNIT INSTALLATION .....	35
4-5. SCAN .....	26	7-3. IF-10C INTERFACE KIT INSTALLATION .....	36
4-6. REPEATER .....	27	7-4. OTHER ACCESSORIES .....	37
<b>5. CIRCUIT DESCRIPTION.....</b>	<b>28</b>	<b>8. REFERENCE.....</b>	<b>40</b>
5-1. GENERAL DESCRIPTION.....	28	8-1. ANTENNA INSTALLATION.....	40
5-2. TRANSMITTER SECTION.....	28	8-2. MOBILE OPERATION.....	41
5-3. RECEIVER SECTION.....	28	8-3. RADIO FREQUENCY ALLOCATION .....	43
5-4. CIRCUIT BOARD DESCRIPTION .....	28		

# 1. BEFORE OPERATION

## Safety precautions

Never remove the case unless instructed to do so in this Manual. If the internal parts are touched accidentally, a serious electric shock might occur.

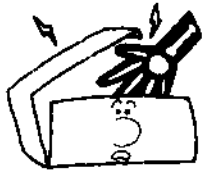

Never touch internal parts.

If a metal object, such as a hair pin or a needle, comes into contact with the power socket on the rear panel, a dangerous electric shock may result. For families with children, never permit children to put anything, especially metal, inside this unit.



Touching the power plug when your hands are wet may result in a serious electric shock.

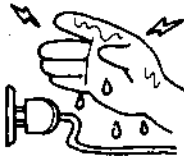

Never touch with wet hands.

Never pull, bend or extend the power cord. This could damage the power cord, resulting in a broken cord or short-circuit.

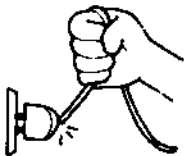

Always grasp the plug.

## In case of abnormal odor

If an abnormal odor or smoke is detected, immediately turn the power OFF and pull out the power cord. Contact your dealer or nearest Service Station.

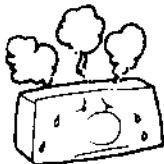

## Notes on installation

Do not place the unit in a place which is exposed to direct sunlight, near a heating appliance, etc.

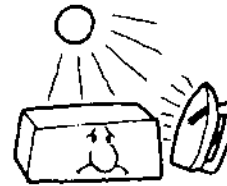

Do not store or use the unit in a dusty location or in a moist atmosphere. Select a location where there is good ventilation.

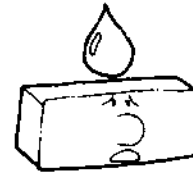

To maintain good ventilation, do not put anything on top of the unit. Place the unit at least 10 cm away from the walls.



Choose a location that is relatively free from vibration.



## Cleaning

Do not use volatile solvents such as alcohol, paint thinner, gasoline, benzene, etc. to clean the cabinet. Use a silicone cloth or a clean dry cloth.



Silicone cloth Thinner Benzene

## 2. SPECIFICATIONS AND ACCESSORIES

### 2-1. SPECIFICATIONS

Specifications		Model	TS-140S	TS-680S	
General	Mode		J3E (LSB, USB), A1A (CW), A3E (AM), F3E (FM)		
	Antenna impedance		50 ohms		
	Power requirement		12 to 16 VDC (13.8 VDC reference)		
	Grounding		Negative		
	Current drain	Receive mode with no input signal	1.5 A		
		Transmit mode	20 A		
	Operating temperature		-10 to +50°C (+14 to +122°F)		
	Frequency stability		Less than ±10 PPM		
	Frequency accuracy		Less than ±10 PPM		
	Dimensions (W × H × D) (Projections included)		281 × 107 × 305 mm (11-1/16" × 4-7/32" × 12")		
Weight		6.1 kg (13.4 lbs)			
Transmitter	Frequency range		160 m band	1.8 to 2.0 MHz	
			80 m band	3.5 to 4.0 MHz	
			40 m band	7.0 to 7.3 MHz	
			30 m band	10.1 to 10.15 MHz	
			20 m band	14.0 to 14.35 MHz	
			17 m band	18.068 to 18.168 MHz	
			15 m band	21.0 to 21.45 MHz	
			12 m band	24.89 to 24.99 MHz	
			10 m band	28.0 to 29.7 MHz	
			6 m band	50.0 to 54.0 MHz	
	Output power	160 m band ~ 15 m band	SSB	110 W ±1	100 W ±1
			CW	100 W ±1	
			AM	40 W ±1	
		12 m band	SSB · CW	100 W	
			AM	40 W	
		10 m band	SSB	100 W	95 W
			CW	95 W	
			FM	50 W	
			AM	40 W	
		6 m band	SSB · CW · FM	—	10 W
AM	—		4 W		
Modulation	LSB, USB		Balanced modulation		
	FM		Reactance modulation		
	AM		Low level modulation		
Spurious radiation (CW)	1.9 MHz to 29.7 MHz		Less than -40 dB		
	50 MHz to 54 MHz		—	Less than -60 dB	
Carrier suppression		More than 40 dB (with 1.5 kHz reference)			
Unwanted sideband suppression		More than 50 dB (with 1.5 kHz reference)			
Maximum frequency deviation (FM)		±5 kHz			
Frequency response (-6 dB)		400 to 2600 Hz			
Microphone impedance		500 ohms to 50 kΩ			

Specifications		Model	TS-140S	TS-680S	
Receiver	Circuitry		Double conversion superheterodyne		
	Frequency range		500 kHz to 30 MHz	500 kHz to 30 MHz 50 MHz to 54 MHz	
	Intermediate frequency		1st: 40.055 MHz, 2nd: 455 kHz		
	Sensitivity	LSB, USB, CW (at 10 dB S + N/N)	500 kHz to 1.6 MHz	Less than 3.98 $\mu$ V	
			1.6 MHz to 21.5 MHz	Less than 0.25 $\mu$ V	
			21.5 MHz to 30 MHz	Less than 0.25 $\mu$ V	Less than 0.18 $\mu$ V *2
			50 MHz to 54 MHz	—	Less than 0.16 $\mu$ V *2
		AM (at 10 dB S + N/N)	500 kHz to 1.6 MHz	Less than 39.8 $\mu$ V	
			1.6 MHz to 21.5 MHz	Less than 2.5 $\mu$ V	
			21.5 MHz to 30 MHz	Less than 2.5 $\mu$ V	Less than 1.78 $\mu$ V *2
			50 MHz to 54 MHz	—	Less than 1.58 $\mu$ V *2
	FM (at 12 dB SINAD)	21.5 MHz to 30 MHz	Less than 0.35 $\mu$ V	Less than 0.18 $\mu$ V *2	
		50 MHz to 54 MHz	—	Less than 0.18 $\mu$ V *2	
	Selectivity	LSB, USB, CW		-6 dB: 2.2 kHz, -60 dB: 4.4 kHz	
		AM		-6 dB: 6 kHz, -50 dB: 18 kHz	
FM		-6 dB: 12 kHz, -50 dB: 25 kHz			
Image ratio		More than 50 dB			
1st IF rejection		More than 50 dB			
IF SHIFT variable range		More than $\pm 1.2$ kHz			
RIT variable range	10 Hz STEP		More than $\pm 1.2$ kHz		
	20 Hz STEP		More than $\pm 2.5$ kHz		
Squelch sensitivity (FM)		Less than 0.32 $\mu$ V			
Output		1.5 W across 8 ohms load (10% distortion)			
Output load impedance		8 ~ 16 ohms			

**Notes:** -

- \*1: The output power on the 160 m band is limited to 10 W depending on local regulations.
- \*2: This is valuable when the RF AMP switch is turned ON.
- Circuit and ratings are subject to change without notice due to advancements in technology.

## 2-2. ACCESSORIES

Unpack your TS-140S/680S carefully and confirm that it is supplied with the following accessories.

Dynamic microphone (Except European and U.K. version) .....	T91-0352-05 .....	1 ea.
DIN plug (7-pin) .....	E07-0751-05 .....	1 ea.
DIN plug (13-pin) .....	E07-1351-05 .....	1 ea.
DC power cable assembly .....	E30-2065-05 .....	1 ea.
Calibration cable .....	E31-2154-05 .....	1 ea.
Fuse (20A) .....	F05-2036-05 .....	1 ea.
Instruction manual .....	B50-8199-XX .....	1 copy
Warranty card .....		1 ea.

After unpacking

Shipping container:

Save the boxes and packing in the event your unit needs to be transported for remote operation, maintenance, or service.

# 3. INSTALLATION AND CONNECTION

## 3-1. INSTALLATION

### 3-1-1. Bail

The transceiver can be elevated for operating convenience.

**Caution:** \_\_\_\_\_  
Do not use the bail to carry the transceiver.

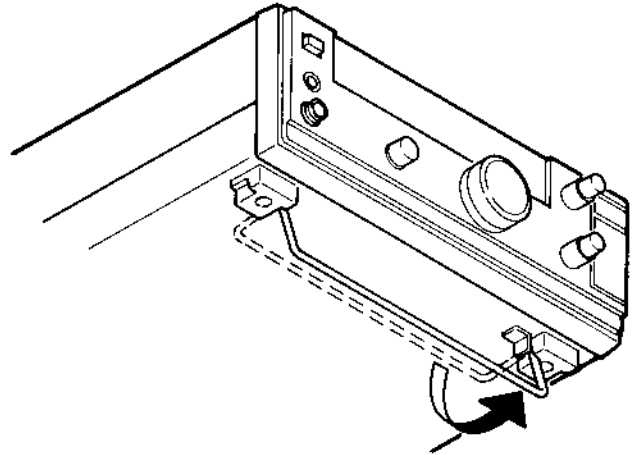

## 3-2. CONNECTION

### 3-2-1. Fixed Station

The TS-140S/680S requires more than 20A at 13.8 VDC when transmitting at full power. Use the PS-50 or PS-430 power supply for fixed station operation.

#### A. Rear Panel

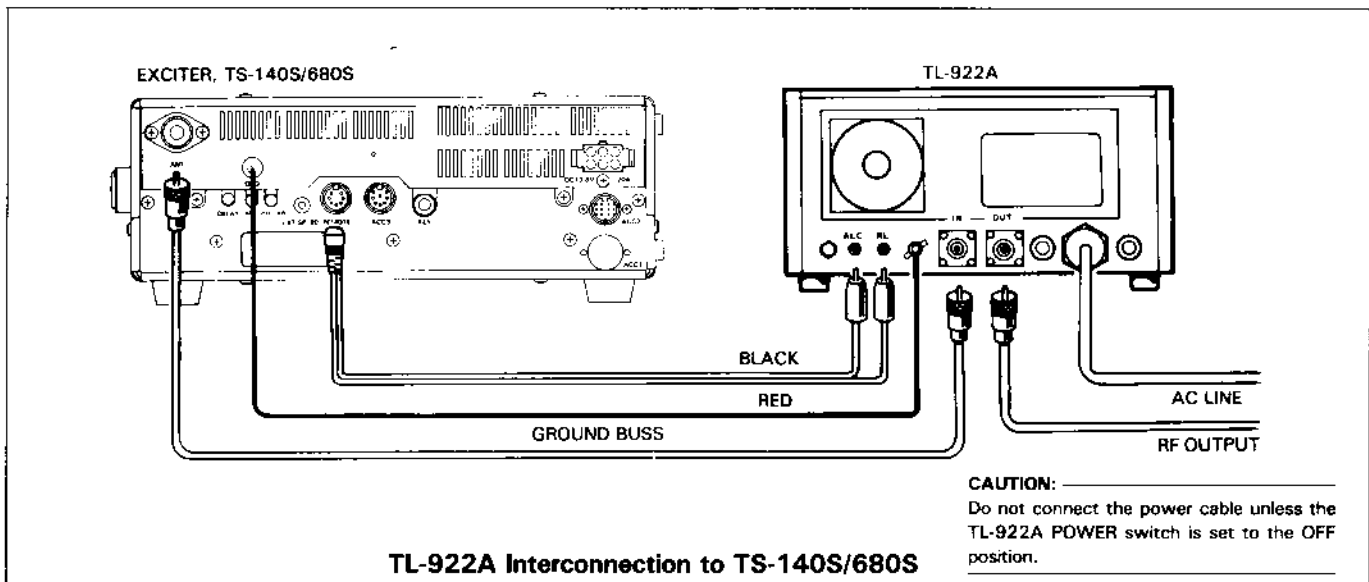
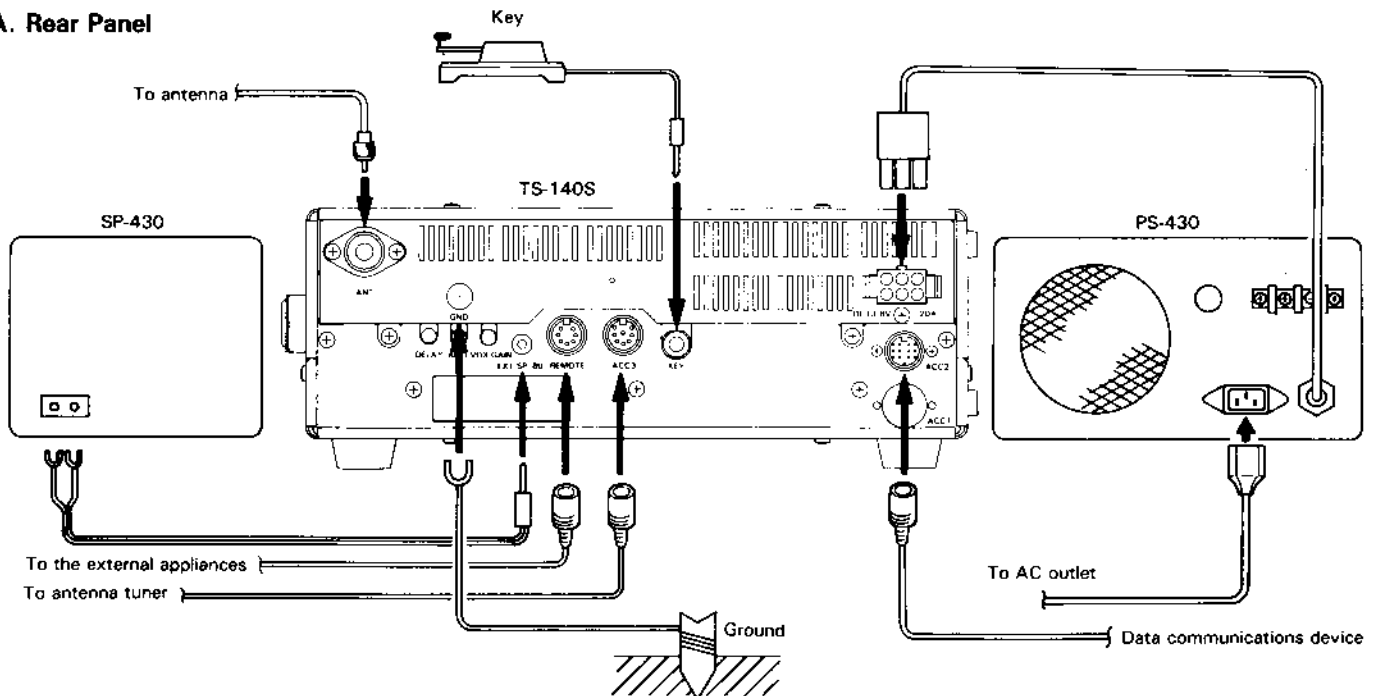

### (1) Antenna

#### Caution:

Protect your equipment—Use a LIGHTNING ARRESTER.

The type of antenna that is used will greatly affect the performance of the transceiver. Use a properly adjusted antenna, of good quality, to enable your transceiver to perform at its best. The antenna input impedance is 50 ohms. Use 50-ohm coaxial cable such as 5D-2V for this connection. If the antenna is far from the transceiver the use of low loss coaxial cable, such as 5D-2V is recommended. Match the impedance of the coaxial cable and that of the antenna so that the SWR is less than 1.5 to 1. The protection circuit in the transceiver will activate if the SWR is particularly poor (greater than 3 to 1). High SWR value will cause transmitter output to drop, and may lead to TVI or BCI reports.

### (2) Grounding

#### Caution:

Never use a gas pipe or electrical conduit pipe.

#### Notes:

1. A ground connection that is a 1/4 wavelength or its multiple may provide a good DC ground, but it will not provide a good RF ground.
2. A city water pipe cannot be used as a good earth in some cases.

Making a good earth connection is important for preventing dangers such as electric shock and for emitting a high quality signal with minimum spurious radiation. Bury a commercially available ground rod or copper plate under the ground and connect it to the GND terminal. A thick wire, cut as short as possi-

ble, should be used for the connection. To make a good earth connection, connect the GND terminal to a grounded metal water pipe.

### (3) External speaker

The TS-140S/680S includes a built-in speaker. If you would like to use an external speaker, such as the SP-430, it may be connected to the EXT SP jack on the rear of the radio. The speaker may be any good 8 ohm permanent magnet type speaker. The diameter should be at least 4 inches for good audio quality. If you plan on using a speaker other than the SP-430 it should be equipped with a miniature phone jack plug.

The internal speaker is disabled when the external speaker plug is inserted into the receptacle.

### (4) Key connection

Your key should be connected as illustrated in the figure below. When using an electronic keyer, make sure that polarity is set for positive. Always use shielded line from the key to transceiver.

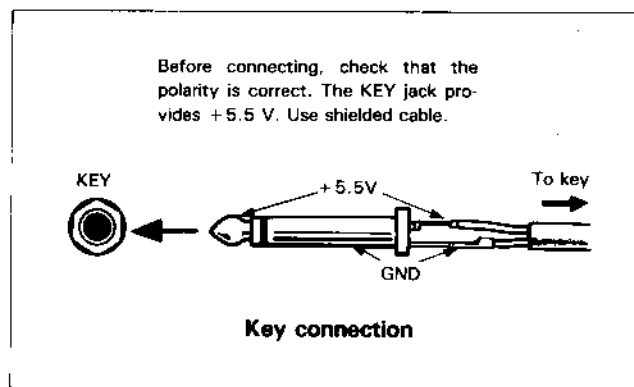

## B. Front Panel

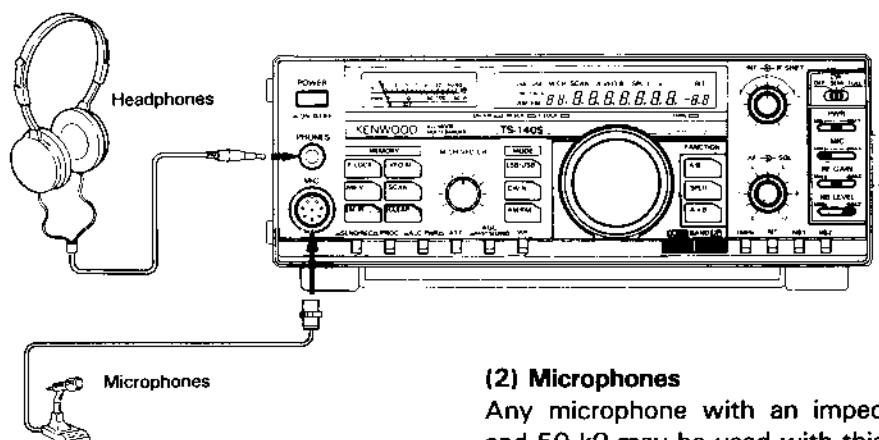

### (1) Headphones

Any low-impedance (4 ~ 16 ohms) headphones may be used with the transceiver. Connect the headphones to the front panel phone jack.

The optional HS-5 or HS-6 headphones are best suited for use with the transceiver. Stereo type headphones can also be used.

### (2) Microphones

Any microphone with an impedance between 500 and 50 k $\Omega$  may be used with this transceiver. The KENWOOD microphones MC-43S (handheld), MC-60A, MC-80, MC-85 (table-top type) are recommended.

You can switch send/receive by voice if a voice controller is connected. (TS-680S only)

### (3) Voice Controller (TS-680S only)

We recommend the use of VOX-4.

Simply connect the MIC cable to the MIC jack.

### 3-2-2. Mobile

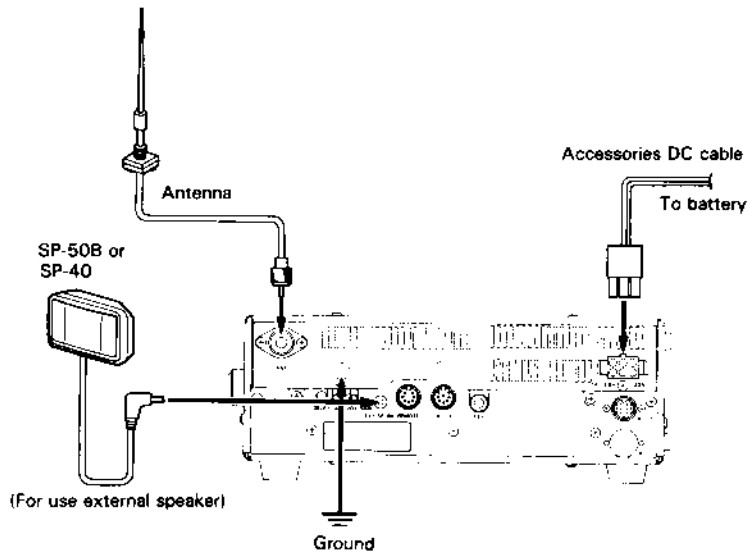

#### A. Battery connection

Connect the supplied power cable with fuse directly to the battery terminals. Connecting to the cigarette lighter socket can cause a poor connection, and excessive voltage drop.

##### Cautions:

1. Before installing the power cable, be sure to remove the negative lead from the battery for safety.
2. After installation and wiring, be sure to double check for correct installation before reconnecting the negative lead to the battery terminal.
3. If the fuse opens, be sure to check that each conductor has not been damaged by short-circuiting, etc.  
Then replace with a new fuse of the same rating.
4. After completing the wiring, wrap the fuse holder with heat resistant tape to protect against heat and moisture.
5. Do not remove the fuse even if the power cable is too long.

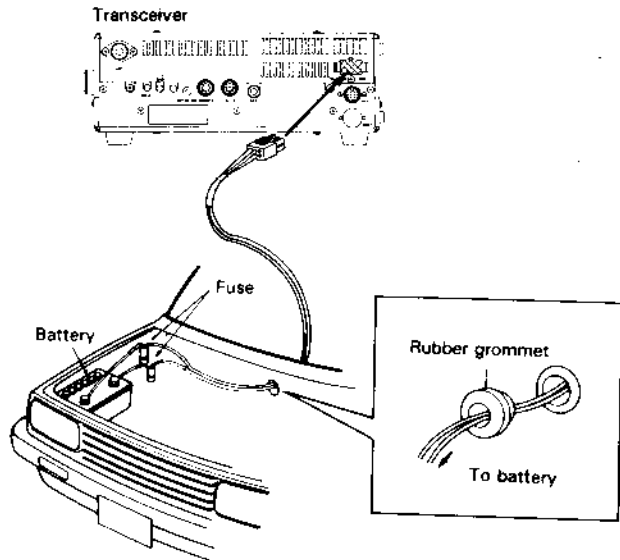

#### B. Ignition Noise

The transceiver has been designed to suppress ignition noise; if excessive noise is present, it may be necessary to use suppressor spark plugs (with resistors).

■ Consider ease of operation and safety when selecting the installation location when installing the transceiver in a vehicle.

Make sure the positive (+) and negative (-) lead polarity are correct when wiring to the battery.

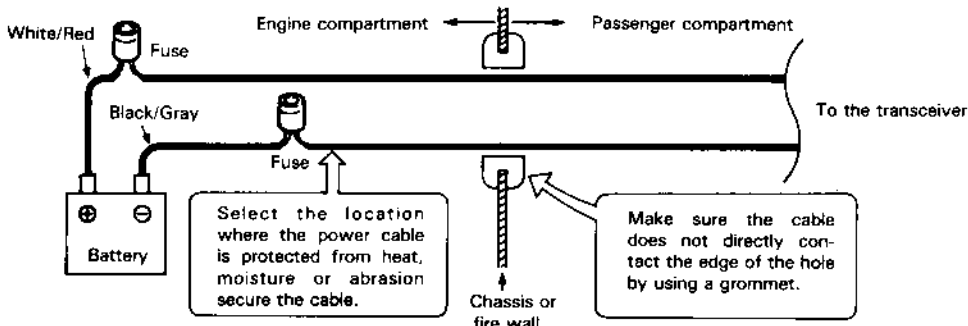





## ⑦ Display Panel

The fluorescent display tube displays operational information such as the operating frequency, memory channel information, and RIT information. (See page 13.)

## ⑧ FUNCTION keys

**A/B** : Selects VFO A or VFO B.

**SPLIT** : For split frequency operations; A-R, B-T (A receive, B transmit), or B-R, A-T.

**A=B** : Equalizes the frequencies and modes of VFO A and VFO B.

## ⑨ RIT control

When the transmit frequency of the distant station drifts a little bit during the QSO, but you do not wish to alter your transmit frequency to compensate, you may wish to make use of the RIT control function. This control allows shifting the receive frequency without shifting the transmit frequency. The RIT control allows you to shift the receiver frequency. This control is also useful for pileups when the DX station is transmitting a little above or below his receive frequency.

The RIT step size is either 10 Hz or 20 Hz. Please refer to Section 4-2-8 for information on how to select the desired step size.

### Notes:

- The RIT offset is displayed on the main display. You can therefore preset the offset before you actually need to use it. When you move to another station make sure you turn OFF the RIT switch.
- The figure at the right illustrates that the RIT display and the VFO display may not agree exactly in all instances since the RIT and VFO tune in 10 Hz steps. The normal resolution of the VFO is 100 Hz, so if the RIT or VFO is turned slowly the associated display may not update immediately. You will have to tune 100 Hz to see the display actually change.

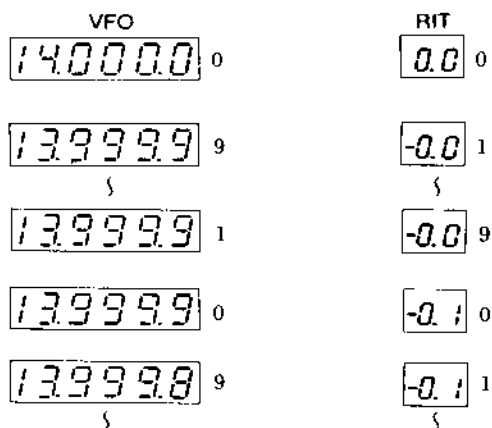

## ⑩ IF SHIFT control

The IF SHIFT control allows you to shift the IF passband of the receiver, without changing the actual center frequency of the receiver. This control is useful when there is interference near your center frequency.

### • USB mode

Interference from lower frequencies can be reduced or eliminated by rotating the IF SHIFT control in the  $\oplus$  direction. This will cause the resulting audio frequencies to have a slightly treble response, i.e. low cut filter (low frequencies attenuated). Interference from higher frequencies can be reduced or eliminated by rotating the IF SHIFT control in the  $\ominus$  direction. This will cause the resulting audio frequencies to sound a little bassy, i.e. high cut filter (high frequencies attenuated).

### • LSB mode

Interference from lower frequencies can be reduced or eliminated by rotating the IF SHIFT control in the  $\oplus$  direction. This will cause the resulting audio frequencies to sound a little bassy, just the opposite of the effect in the USB mode. Interference from higher frequencies can be reduced or eliminated by rotating the IF SHIFT control in the  $\ominus$  direction. This will cause the resulting audio frequencies to appear a little on the high side, again just the opposite of the USB mode.

### Note:

The IF SHIFT control does not function in the AM or FM modes.

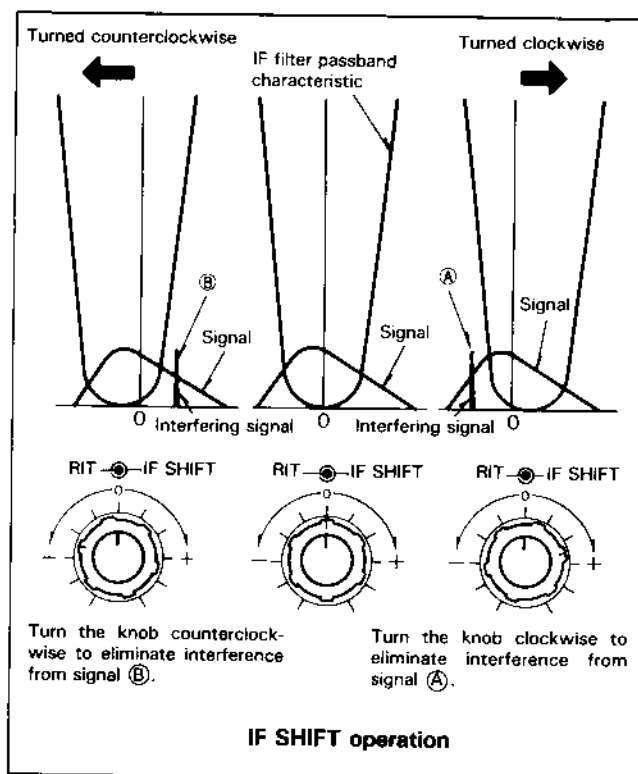

### ⑪ SQL (Squelch) control

**Note:** \_\_\_\_\_

This function operates in the FM mode only.

This control is used to eliminate atmospheric noise, and receiver static noise during no signal periods. Slowly rotate the control clockwise to the point where the ambient noise just disappears, and speaker shuts off. This point is known as the squelch threshold point. Now you will only hear output from the speaker when an incoming signal is present. For weak signal reception this control should be fully counterclockwise.

### ⑫ AF gain control

Turn the knob to increase or decrease the volume. Clockwise rotation increases the volume and counterclockwise rotation decreases the volume.

**Note:** \_\_\_\_\_

The output level of the "Beep" is not affected by the setting of the AF gain control.

### ⑬ CW OFF/SEMI/FULL (Break-in) switch

This switch affects the transmit/receive recovery time. In the SEMI position the transceiver will key when the key is depressed and remain in the transmit position until a preset delay has been reached. In the FULL position the transceiver will switch back to receive as soon as the key is released, thus allowing you to copy incoming signals between characters. The CW switch must be in the FULL position when transmitting a carrier for antenna adjustments, etc.

### ⑭ PWR (Power) control

Power can be controlled in the FM, LSB, and USB modes only. In CW this control functions as the CARRIER level adjustment. This control should be adjusted so that the pointer on the meter remains within the ALC section marked on the meter, in the CW transmit mode, and for 40 watts of unmodulated power output in the AM mode. [50 MHz : 4 watts (TS-680S only)]

### ⑮ MIC gain control

Microphone gain can be adjusted during USB, LSB, and AM operations. Gain is increased by moving the control to the right.

### ⑯ RF GAIN control

This control adjusts the gain of the receiver high-frequency amplifier section.

For normal receiver performance, and maximum gain, this control should be all the way to the right. If you are having trouble copying the desired signal make a note of the stations peak S-meter reading. Then, adjust the RF control left, so that the meter needle is stationary at this level. Now, all signals that were less than the desired signal will be attenuated, such as static noise, etc., making reception easier. If the incoming signal pegs the S-meter you can also

reduce the receiver gain by moving the RF GAIN control to the left. The S-meter pointer will always advance up-scale as the RF control is moved to the left, as a visual reminder that the gain of the radio has been reduced.

### Simultaneous use of the RF GAIN control and AGC switch

If a strong signal (such as a local station) appears in the vicinity of the intended receive signal, the S-meter may show unusual deflection due to the AGC voltage developed from the strong disturbing signal. If this occurs, move the RF GAIN control to the left so the meter pointer remains at about the original deflection peak and turn the AGC switch to the FAST position. This will reduce the unwanted AGC voltage and permit clear reception.

### ⑰ NB LEVEL control

Controls the noise blanker operating level.  
**Use only the minimum level necessary.**

### ⑱ NB 2 switch

Noise blanker 2 is used for long duration pulse noise, like the "woodpecker". To reduce "woodpecker" radar noise interference, set switch NB 2 to the ON position (NB 2's effectiveness depends on the specific type of interference). If you use NB 2 for short duration pulse noise, the receive tone may become distorted, making it difficult to hear.

Unfortunately no noise blanker can remove all different types of interference; but the two noise blankers that have been provided in the TS-140S/680S are effective in most cases.

If there is no "woodpecker" present, the switch should be in the OFF position.

### ⑲ NB 1 switch

For pulse type noise, such as generated by automotive ignition systems, turn the NB 1 switch ON.

When pulsating noise, such as that caused by automobile ignitions is encountered, place the NB 1 switch ON.

This switch will not help to eliminate atmospheric or line noises, only pulse type noise.

### ⑳ RIT switch

Press to turn the RIT ON or OFF.

### ㉑ 1 MHz switch

This switch is used to determine if the UP/DOWN switches will function in 1 MHz steps or only thru the amateur bands. When the 1 MHz step position is selected, the 1 MHz indicator will light.

### ㉒ UP/DOWN switches

Pressing the UP switch increases the frequency, and pressing the DOWN switch decreases it.

### 23 TUNING knob (VFO)

Rotate the knob to select the desired frequency. Fast tuning is possible by rotating the knob rapidly. This knob may also be used to select the desired memory channel. The dial drag is adjustable by holding the outside knob and turning the inside knob clockwise to increase drag, and counterclockwise to decrease drag.

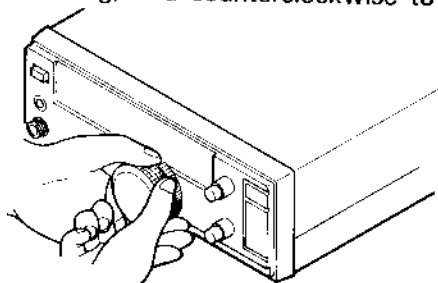

### 24 VOX switch (With the TS-140S)

VOX (Voice Operated Keying) operation is possible in LSB, USB, FM or AM operations. To activate the VOX circuitry place the VOX switch ON.

### RF AMP switch (With the TS-680S)

Depress this control when receiving weak signals.

#### Note:

The RF amplifier does not function below 21.5 MHz even if this switch is ON.

### 25 AGC switch

This switch selects the operating time constant of the AGC (Automatic Gain Control) circuit. When the AGC switch is set to SLOW, the receiver gain and S-meter readings will react slowly to large input changes, and when set to FAST, the receiver gain and S-meter will react quickly to changes in the input signal level.

The normal position when using all modes is the SLOW position. When working any of the following you might wish to use the FAST position.

- When tuning with the TUNING dial.
- When receiving weak signals.
- When a high-speed CW signal is being received.

#### Note:

This switch is disabled during FM operations.

### 26 ATT (Attenuator) switch

The incoming receive signal level is attenuated by approximately 20 dB when this switch is activated.

When the incoming receive signal is very strong (20 dB over S-9), the signal should be attenuated to prevent distortion of the signal, thereby stabilizing the receiver performance. This is easily done by activating the ATT switch. This control is also useful when a strong signal is near your desired signal, while some loss will occur to the desired signal as well as the undesired signal, the use of the attenuator will sometimes allow you to complete the QSO.

### 27 ALC/PWR meter switch

#### ALC meter

Used to monitor the drive level in USB, LSB, and AM modes.

#### PWR meter

Used to indicate the output power. Note that this meter is a peak reading meter, not an average reading meter.

### 28 PROC (Processor) switch

Effective transmit power output will increase when the PROC switch is turned ON during USB, LSB, or AM mode operations. (See 4-3-6. Speech Processor)

#### Note:

When the speech processor function is used in the USB, LSB, or AM mode it is possible to overdrive the transmitter: An easy way to check for excessive modulation is to monitor the ALC meter. If the needle is over the ALC zone you are overmodulating. Reduce the MIC gain control setting until the needle remains in the ALC zone on voice peaks.

### 29 Standby switch

This switch is used when you want to manually control transmit or receive.

**SEND:** Places the radio into transmit.

**REC :** Places the radio into receive.

### 30 MIC jack

Microphone connection.

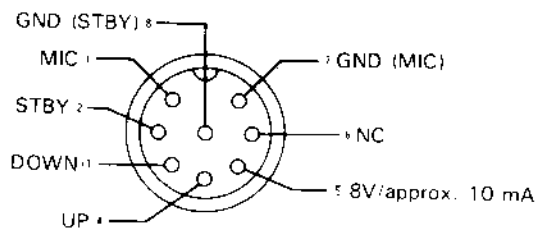

MIC connector (Front view)

### 31 PHONES jack

Output terminal for headphones.

## A. Display Panel

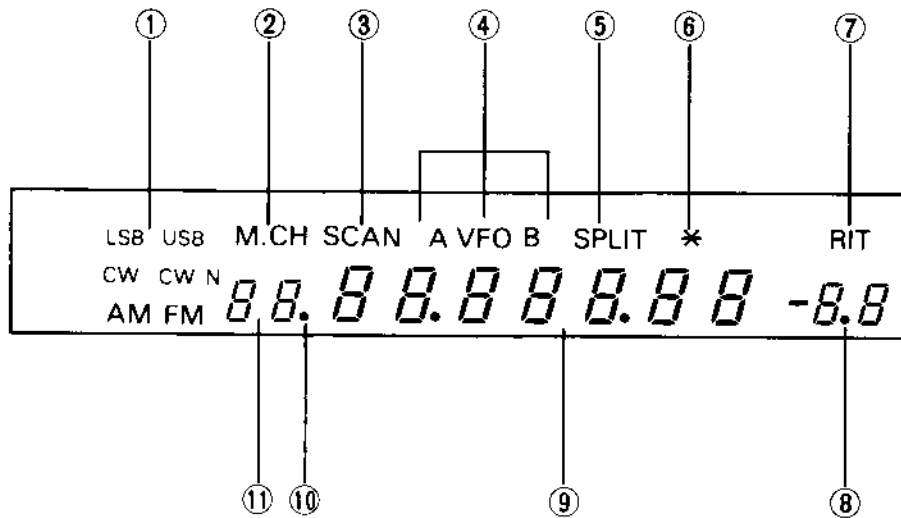

- ① **MODE display** : Indicates the selected mode.
- ② **M.CH display** : Turns ON during a Memory Channel operation.
- ③ **SCAN display** : Turns ON during scanning.
- ④ **VFO A/B display** : Turns ON when VFO A (or VFO B) operates.
- ⑤ **SPLIT display** : Turns ON during split operation.
- ⑥ **\* display** : Lights during selection or operation on memory channels 20 to 30. (See Sections 4-4 and 4-5 for additional information on this indicator.)
- ⑦ **RIT display** : Turns ON when using RIT.

- ⑧ **RIT frequency display** : Shows the amount of RIT offset to the nearest 100 Hz.  
**Note:** \_\_\_\_\_  
Minus “-” appears in the display when the RIT offset is below the transmit frequency.  
\_\_\_\_\_

- ⑨ **Frequency display** : Indicates the operating frequency. Frequency resolution is selectable between 10 and 100 Hz. Please refer to Section 4-2-8 for additional information on the selection process.

- ⑩ **• display** : The • display indicates the Memory Channel currently display will be skipped during Memory Channel scan. (Please refer to Section 4-5-5.)

- ⑪ **Memory Channel number display** : Memory Channel Number is displayed.

## 4-1-2. Rear Panel

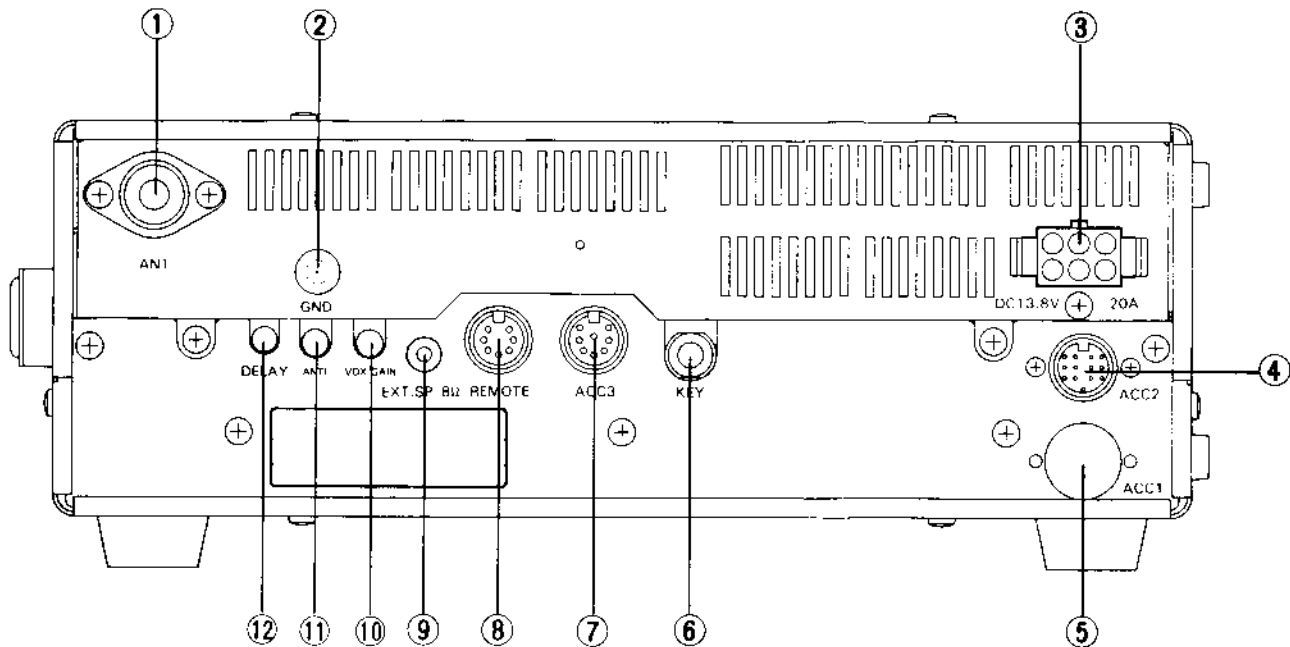

### ① ANT (Antenna) connector

This connector should be attached to a suitable antenna for transmitting and receiving. The antenna cable should be 50-ohm coax, terminated with a PL-259 connector.

### ② GND (Ground) terminal

To prevent electric shock, as well as RFI and BCI, connect the transceiver to a good earth ground.

### ③ DC power connector

This is used to connect the DC power supply.

### ④ ACC 2 jack

Terminal numbers and their applications are as follows:

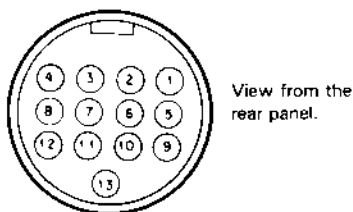

13-pin DIN plug (E07-1351-05)

Pin No.	Pin Name	Application
1	NC	No connection
2	NC	No connection
3	Data output	Output level is fixed regardless of the AF control setting. Output voltage: 300 mV or more at maximum receiving input with 4.7 kΩ load.
4	GND	Grounding (The shielded wire of the audio output terminal is connected here.)
5	PSQ	This pin is used for connecting a TNC (Terminal Node Controller) for use with packet radio. It is the Squelch Control terminal and will not allow packet communications while squelch is off.
6	NC	No connection
7	NC	No connection
8	GND	Grounding
9	PKS	This terminal disconnects the microphone and places the transceiver into transmit when a ground is applied to this terminal.
10	NC	No connection
11	PKD	This is the MIC (microphone) input pin from the terminal unit. The input level is approximately 10 mV.
12	GND	Grounding (The shielded wire of the audio input is connected here.)
13	Standby	Standby terminal Grounding transmits. PTT

**⑤ ACC 1 jack**

This jack is designed for connection of the 6-pin DIN connector supplied with the optional interface unit.

**⑥ KEY jack**

Using shielded line, connect a 1/4" phone plug to this jack for CW operation. Open-terminal voltage is approximately 5.5 VDC.

**⑦ ACC 3 terminal**

This terminal is used to access the automatic antenna tuner AT-250.

**Caution:**  
The TUNER switch should be turned off if the transceiver will be used on frequencies outside the range of the AT-250.

**⑧ REMOTE connector**

**Note:**  
When the control relay is used refer to section 6-6-8.

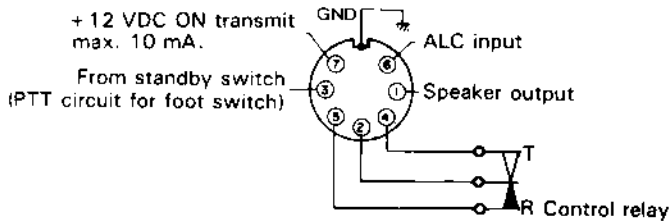

**Internal wiring**

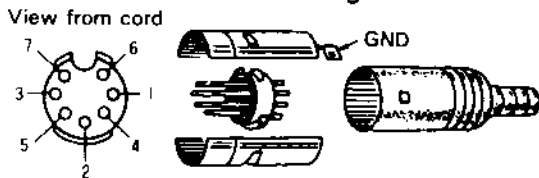

**⑨ EXT. SP (External speaker) jack**

This jack is for connection of an external speaker.

**⑩ VOX GAIN control (TS-140S only)**

This control adjusts the sensitivity of the VOX amplifier. Adjust this control for your personal preference.



**⑪ ANTI VOX control (TS-140S only)**

VOX operations are sometimes difficult with high speaker volume control settings. The ANTI VOX control is used to reduce the tendency of the VOX to activate from inputs from the speaker. The ANTI VOX control is not active when headphones are connected, for obvious reasons!



**⑫ DELAY control**

This control adjusts the "hang-time" that the radio will remain keyed after voice input has stopped.



**4-1-3. Microphone**

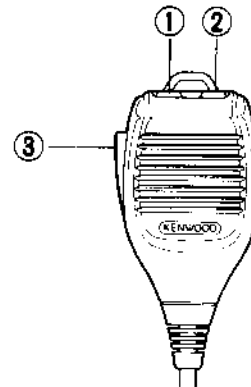

**① ② UP/DWN (Up/Down) switches**

These switches are used to step the VFO frequency or memory channel up and down. The frequency will change continuously if the switches are pressed and held.

**③ PTT (Push To Talk) switch**

The transceiver will be placed into Transmit whenever this switch is pressed. Operations such as scanning, code squelch operations, and channel linkage will be cleared when this switch is pressed.

## 4-2. RECEIVER OPERATION

### 4-2-1. Beep Tones

Audible confirmation of microprocessor functions is provided in the form of a series of audio beeps.

The output level of the "Beeper" is adjustable with a variable resistor located inside the set. (Please refer to Section 6-6-4)

Beep Tone	Indication
1 short beep	When the following keys are pressed: A/B, SPLIT, F.LOCK, A=B, M▶V, SCAN, CLEAR, M.IN (When the Memory Scroll mode is selected.), VFO/M, BAND (UP/DOWN), 1MHz, RIT, LSB/USB*1, CW/N*1, AM/FM*1
1 long beep	When the M.IN key is pressed again to enter the data.
3 short beeps	A. When the SCAN key is pressed and the receiver is unable to memory scan.*2 B. When all memory channels are empty and attempt to select memory channel with 1 MHz switch ON.*2 C. When all memory channels are full and attempt to find out an empty channel with 1 MHz switch ON.*2

Notes: \_\_\_\_\_

- \*1 : 1 short beep can be selected by pressing the CW/N key and the power switch ON. (Please refer to Section 4-2-8)
- \*2 : 3 short beeps can be selected by pressing the F.LOCK key and the power switch ON. (Please refer to Section 4-2-8)

### 4-2-2. Audible Mode Announcement

When a Mode key is pressed, the first character of the mode is sounded in Morse code thru the speaker.

Mode	Morse Code
USB	...—
LSB	—...—
CW (Wide)	—...—
CWN (Narrow)	—...—
AM	...—
FM	...—

Note: \_\_\_\_\_  
1 short beep can be selected by pressing the CW/N key and the power switch ON. (Please refer to Section 4-2-8)



### 4-2-3. Receiving

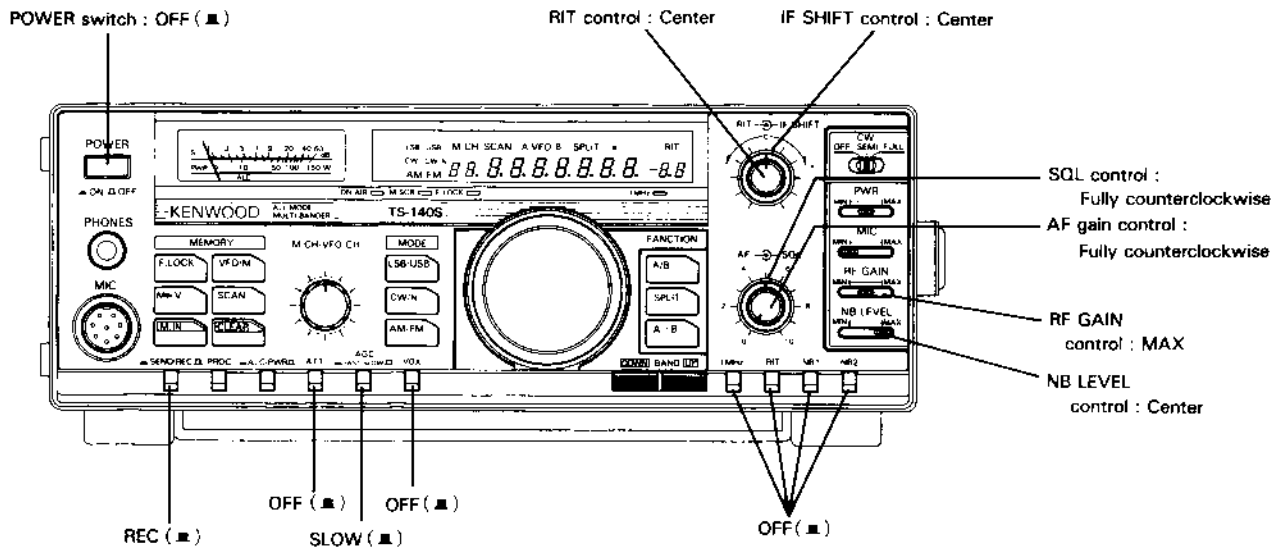

**Note:**

All segments on the Display Panel and Indicators are shown on for this explanation.

1. Preset the controls as shown in the accompanying illustration.
2. Turn on the DC power supply (Fixed station) and then turn the transceiver's power switch ON. The display panel will indicate as shown below.

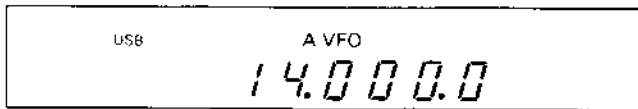

**Note:**

If the display is not as shown reset the microprocessor using the procedure in Section 4-4-2.

3. Select the desired mode using one of the MODE keys.
4. Adjust the AF gain control for the desired volume.
5. Press the UP/DOWN switches to select the desired frequency band.
6. Slowly rotate the TUNING knob until the desired signal can be heard clearly.

### 4-2-4. Dual Digital VFO's

Operational convenience can be enhanced thru the use of both VFO A and VFO B.

Two VFO's are provided to allow you to change frequencies rapidly. You could set one VFO to the lower tuning range and the other VFO to the upper tuning limit. You can set either VFO to any frequency you desire.

**(a) A = B key**

Depressing this key causes the data contained in the inactive VFO (the VFO that is not currently being displayed) to change to the same data contained in the active VFO (the one currently displayed). Both the frequency, mode and antenna selection are changed.

**For example:**

VFO A is set at 7 MHz in LSB, and VFO B is 21 MHz in USB. VFO A is the active VFO (show on the display). Depressing the A = B key will cause VFO B to change to 7 MHz in LSB.

**(b) A/B key**

Allows selection of the desired active VFO. Each time this key is depressed the active VFO will alternate between VFO A and VFO B.

**(c) SPLIT key**

Allows the use of one VFO for transmit, and the other for receive (Split Frequency operation).

**For example:**

VFO A is the active VFO, and VFO B is the inactive VFO. Depressing the SPLIT key will cause the TS-140S/680S to receive on VFO A and transmit on VFO B. The mode of reception and transmission will follow the mode contained in the appropriate VFO memory. It is possible to work cross band, cross mode if desired.

To avoid confusion during contest, or pile-up operations we recommend using VFO A for receive and VFO B for transmit.

### 4-2-5. Frequency Step

1. The frequency step is set automatically depending on the mode that has been selected.

Frequency Step		
Mode	USB/LSB/ CW/CWN	AM/FM
Frequency step	10 Hz	100 Hz
One revolution of TUNING knob	10 kHz	50 kHz

2. When a 10 Hz or 100 Hz frequency step is selected rapid tuning is possible by rotating the TUNING knob quickly.

When the TUNING knob is rotated at about 3 revolutions a second a geometric increase in the tuning step occurs, that corresponds to the speed of dial rotation.

#### 4-2-6. SSB AUTO mode shift

This transceiver automatically selects the appropriate sideband when in the SSB mode.

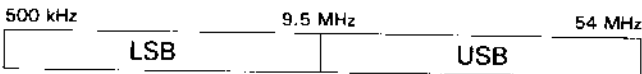

#### Notes:

1. USB is selected from at 9.5 MHz and above.
2. The AUTO mode selection will not function when using RIT.

#### 4-2-7. CW zero-beat Operation

1. When an optional filter is not used, tune the TUNING knob so that the receive beat frequency is approximately 800 Hz.
2. When an optional CW filter is installed the simplest method to use is to adjust the TUNING knob for maximum S-meter deflection.

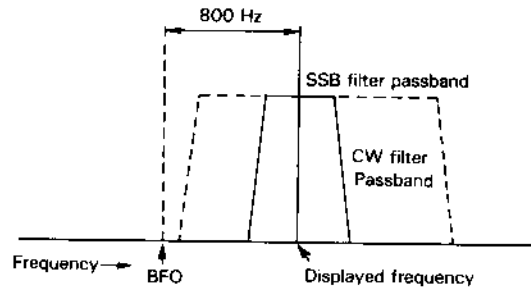

#### 4-2-8. Power on function selection

Several of the functions of this transceiver can be changed at the time the transceiver is turned ON. Repeat when releasing each function.

Switch or key	These functions include
CLEAR	10 Hz Main display resolution: ON/OFF
RIT	RIT step frequency selection: 10 Hz/20 Hz
AM/FM	AM step frequency selection for the 522 kHz to 1620 kHz band: 9 kHz/10 kHz
SCAN	Program scan hold: ON/OFF
CW/N	Audible mode announcement: Beep tones/Morse code
F.LOCK	Audible alarm: Beep tones/Morse code
1 MHz	BAND switch (1 MHz switch is ON): 500 kHz/1 MHz

#### 4-2-9. Alarm Function

Several alarms have been included to signal errors that you might encounter. The chart below lists the possible causes and the resulting Morse code alarm.

Morse code will be heard from the speaker.

Indication	Morse Code
When the microprocessor is reset.	(RESET)
When the system is unlocked.	(UNLOCK)
When the SCAN key is pressed and the receiver is unable to memory scan. *	(CHECK MEMORY)
When all memory channels are empty and attempt to select memory channel with 1 MHz switch ON. *	(EMPTY)
When all memory channels are full and attempt to find out an empty channel with 1 MHz switch ON. *	(FULL)

**Note:** \* : 3 short beeps can be selected by pressing the F.LOCK key and the power switch ON. (Please refer to Section 4-2-8.)

## 4-3. TRANSMITTER OPERATION

Preset the controls as shown in the accompanying illustration.

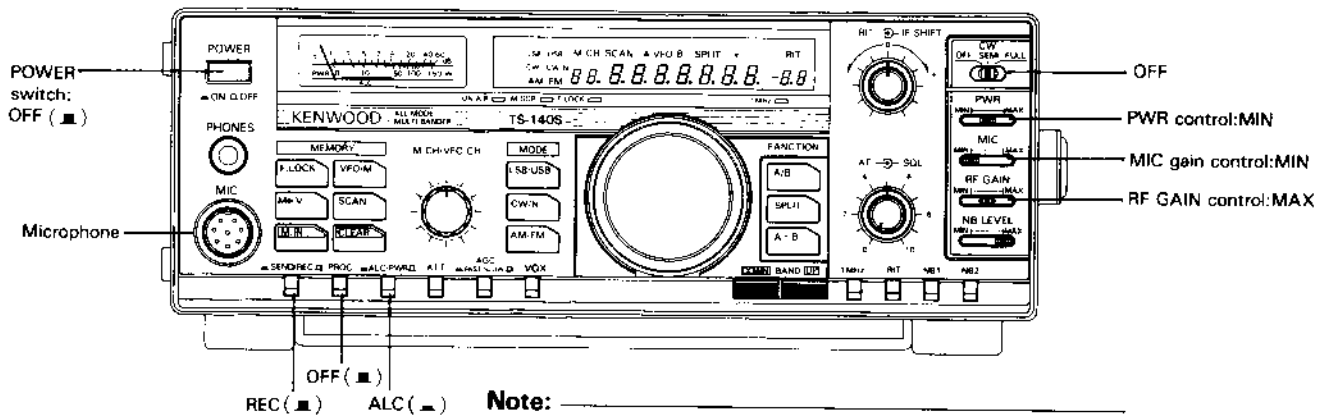

### Note:

All segments on the Display Panel and Indicators are shown on for this explanation.

### 4-3-1. Precaution

Before transmitting check the frequency for activity so that you do not interrupt another QSO.

### 4-3-2. SSB (LSB, USB) Mode

1. Place the POWER switch ON.
2. Set the MODE keys to USB or LSB. By international convention frequencies below 10 MHz utilize the LSB (Lower Sideband) mode, and frequencies above 10 MHz use USB (Upper Sideband). The actual switchover point on the TS-140S/680S is 9.5 MHz. The TS-140S/680S will select the proper mode when you tune to the desired frequency. You can override this by simply pressing the desired mode key.
3. Press the microphone PTT switch, or set the standby switch to SEND. The ON AIR indicator will light.
4. Set the PWR control to the desired level.
5. Speak into the microphone and adjust the MIC gain control so that the meter deflection does not exceed the ALC zone on voice peaks.

### Note:

Adjustment using the ALC meter provides greater accuracy than if you try and use the power meter for adjustment. Never adjust for ALC deflection above the ALC zone, as this will cause distortion of the transmitted audio signal.

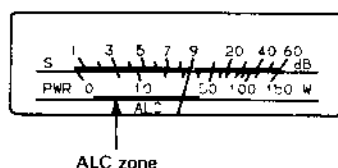

### Notes:

1. Do not exceed the ALC zone on voice peaks.
  2. When using high gain microphones or pre-amplified microphones you might have difficulty in obtaining proper ALC meter readings, or you might receive reports of audio distortion. To prevent this type of problem you should set the front panel MIC gain control to center and reduce the gain of the internal microphone gain control, by rotating the control clockwise, until the proper ALC reading is obtained. The adjustment of this control is described in Section 6-6-6.
  6. Turn on the PROC switch if required. (Please refer to Section 4-3-6)
  7. Release the PTT switch, or place the standby switch to REC. The ON AIR indicator will turn OFF.
- ### 4-3-3. FM Mode
1. Place the POWER switch ON.
  2. Select the desired frequency within the 28 MHz/50 MHz amateur radio band. (50 MHz : TS-680S only) Place the MODE key to FM.
  3. Press the microphone PTT switch or place the standby switch to SEND. The ON AIR indicator will light.
  4. Set the PWR control to the desired level.
  5. Speak into the microphone, holding the microphone about 5 cm away from your mouth. Close talking or talking too loudly may reduce transmission clarity or spread the side bands too much.
  6. Release the PTT switch, or place the standby switch to REC. The ON AIR indicator will turn OFF.

#### 4-3-4. AM Mode

1. Place the POWER switch ON.
2. Set the ALC/PWR meter switch to PWR.
3. Set the MODE key to AM.
4. Press the microphone PTT switch or place the standby switch to SEND. The ON AIR indicator will light.
5. Adjust the PWR control so that the meter indicates 40 watts. [50 MHz : 4 watts (TS-680S only)]

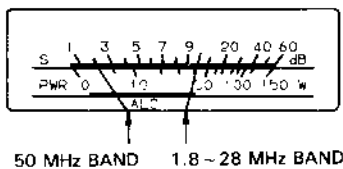

6. Speak into the microphone and adjust the MIC gain control so that the meter indicates 80 watts. [50 MHz : 8 watts (TS-680S only)]

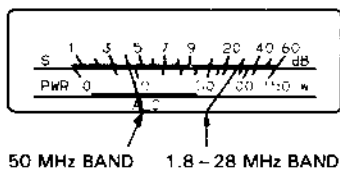

7. Turn on the PROC switch if required. (Please refer to Section 4-3-6)

8. Release the PTT switch, or place the standby switch to REC. The ON AIR indicator will turn OFF.

#### 4-3-5. CW Mode

##### Sidetone oscillator

The transceiver contains a sidetone oscillator circuit to permit you to monitor your own signal. If the key is closed in a mode other than CW, transmit will not be selected but a sidetone will come out of the speaker, to allow Morse code training. The volume of the sidetone can be adjusted internally. (Please refer to Section 6-6-3)

Place the POWER switch ON. Set MODE keys to CW. Placing the standby switch to SEND and depressing the CW key will cause the radio to transmit.

Transmission is also possible when in the SEMI or FULL break-in mode by simply depressing the key, with the standby switch in the REC position.

Adjust the PWR control until the meter deflection is within the ALC zone.

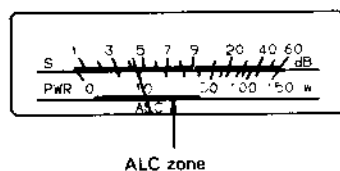

#### • SEMI and FULL break-in

Two break-in methods are provided with the TS-140S/680S transceivers, SEMI and FULL break-in. With either break-in operation depressing the CW key will cause the radio to transmit without the need for manually switching the SEND/REC switch. The difference between FULL and SEMI break-in is that during FULL break-in operation it is possible to listen between dots and dashes, and that during SEMI break-in it is not.

##### Note:

With either SEMI or FULL break-in operation, cross band/cross mode operation is not possible. Additionally, when you are using FULL break-in operation you should not work cross band splits, only in the same band.

The TS-140S/680S also provides a side-tone oscillator circuit to allow monitoring of your CW signal during transmission.

##### (a)Semi-automatic break-in

Depressing the CW key will automatically place the transceiver into the transmit mode. Transmit mode will be maintained for a period determined by the setting of the DELAY control on the rear panel of the transceiver, even after the CW key is released.



##### (b)Full-automatic break-in

Depressing the CW key will automatically place the transceiver into the transmit mode. Releasing the CW key will return the radio to receive immediately enabling reception between characters.

##### Caution:

The TL-922A/922 linear amplifier is not designed for full break-in type operation. Attempting to use this accessory in the FULL break-in mode cause damage to occur to the linear amplifier.



On occasion an electronic keyer may be used that has no method of producing a continuous transmit condition. In order to obtain a continuous carrier for tuning simply place the standby switch to the SEND position, and the CW switch to FULL.

#### 4-3-6. Speech Processor

The Speech Processor is used when signals from your station are weak at the distant station.

##### Notes:

1. Intelligibility is normally reduced when the speech processor is used.

2. This function is not useful in the FM mode.

#### A. SSB (LSB, USB) mode

Speak into the microphone and adjust the MIC gain control so that the meter deflection does not exceed the ALC zone on voice peaks.

#### B. AM mode

Speak into the microphone and adjust the MIC gain control so that the meter indicates 80 watts. [50 MHz : 8 watts (TS-680S only)]

#### 4-3-7. VOX (Voice Operated Switch) (TS-680 only)

Switching between transmit and receive can be voice controlled in the SSB, FM and AM modes by using the optional VOX-4 unit. The operators manual supplied with the VOX-4 contains instructions for its use. The processor should not be used when the VOX-4 is ON. When operating in the CW mode the VOX GAIN on the VOX-4 should be adjusted for minimum (OFF), since voice inputs would tend to cause the radio to transmit.

#### 4-3-8. Data Communications (PACKET, AMTOR, RTTY, SSTV, etc.)

1. The Accessory 2 terminal has been provided for connection of Data communications devices. All necessary connections can be accomplished from the same connector.
2. When using AFSK (Audio Frequency Shift Keying) or modulating the signal with any form of audio tones you should select LSB or USB. If F2 operation is desired select the FM mode. In general LSB is used for RTTY and PACKET communications in the HF band (F1), and USB is used for AMTOR.
3. The transceiver will transmit according to the signals received on the STBY pin of the connector. These inputs are generated by the terminal unit in response to inputs from the associated terminal input device.
4. When using LSB, or USB the MIC gain control should be used to adjust the input level for an on scale ALC meter reading.
5. Pin number 9 of the ACC 2 connector is used to disable the front panel microphone connector during the periods that your communication terminal is in use (grounding the pin accomplishes this task). This prevents unwanted errors from entering your text. In addition this pin is used to reduce the output level to 50 watts for the TS-140S/680S transceivers.

#### Notes:

1. No transmission should be attempted until you have confirmed that all terminal unit connections have been properly completed according to the instructions provided with that unit.
2. If the output of the terminal unit causes the ALC meter to register above the recommended limits even with the MIC gain control turned all the way down you should reduce the output of the ter-

minal unit. Excessive signal levels can cause distortion! If the terminal unit output level is fixed you should add a potentiometer between the transceiver and the terminal unit. (Refer to Section 6-6-5 for further information.)

3. While 100 watt transmissions are possible when using short duration modes such as PACKET continued operation over a long period of time might cause overheating. We recommend that you reduce the transmitter power output to 50 watts whenever using one of these modes, i.e., PACKET, AMTOR, RTTY. This is easily accomplished thru the use of the front panel PWR control.

## 4-4. MEMORY

The TS-140S/680S incorporates a convenient 31 channel memory that can be used to store and recall commonly used frequencies.

#### 4-4-1. Microprocessor back-up lithium Battery

A lithium battery is contained in the transceiver to retain memory. Turning off and POWER switch, disconnecting the power cable, or a power failure will not erase the memory. The battery should last for approximately five years. When the battery discharges, an erroneous display may appear in the display. Lithium battery replacement should be performed by an authorized KENWOOD service facility; either your KENWOOD dealer, or the factory, since this unit contains CMOS type circuitry.

#### Notes:

1. When the lithium battery is replaced, the microprocessor must be reset, using the procedure in section 4-4-2.
2. When the lithium battery fails, the radio's microcoded functions are not affected. Only information stored in memory will be cleared.

#### 4-4-2. Initial state and reset of the microprocessor.

##### A. Initial state of the microprocessor from the factory.

	Frequency	Mode
VFOA	14.000.0	USB
VFOB	14.000.0	USB
Memory Channel 00 ~ 30	.	—

##### B. Microprocessor reset

There are two methods for resetting the microprocessor.

1. Press and hold the A=B key and turn on the POWER. RESET (— · · · —) will be heard from the speaker when the power comes on to indicate the reset operation has been successfully accomplished.

#### Caution:

All user programmed memory will be erased with this operation.

- Press and hold the A/B key and turn on the power to reset all user programmed data except the contents of the Memory Channels.  
RESET (· — · · · · —) will again be sounded from the speaker.

#### 4-4-3. Memory Channel

Memory Channel Number	Memory Channel	Date Entry
00 through 09	Standard	Frequency and mode
10 through 19	Split	Receive and transmit frequency, mode
20 through 30	Programed Band Marker	Frequency, Highest operating frequency Lowest operating frequency and mode

##### A. Standard Memory Channels

These Memory Channels (00 to 09) are capable of storing one frequency and one mode each.

##### B. Split Memory Channels (SPLIT indicator on)

These Memory Channels (10 to 19) are capable of storing separate transmit and receive frequencies for use with 10 Meter repeaters, just to name one possible application. These Memory Channels can also be used as standard Memory Channels by storing the same transmit and receive frequency.

##### C. Programed Band Marker (✱ indicator on)

- Programed band marker (20 to 30) are capable of storing specific band segments (highest operating frequency and lowest operating frequency), and mode. If the highest and lowest operating frequencies are the same, then these Memory Channels will function as standard Memory Channels. Channel 30 is also used to specify the limits of the program scan function.

- Since these channels store both a low and high frequency limit you can vary the operating frequency thru out this specified range during Memory operations. You can also change the mode of these channels during Memory operations. An easy way to check the range of each channel is to use the UP/DOWN switches. These positions are quite useful when working contests etc. You can program the band segments that you want to work. Then if band conditions change and you want to change to another band you can simply select the desired band segment by rotating the M.CH/VFO CH control. This makes for rapid frequency changes, which are a definite aid in large contests, and it keeps you in the band segment you want to use!

#### 4-4-4. Memory Entry

##### A. Standard Memory Channel

Operation	Key	Beep	Remarks
1 Select the receive frequency.	TUNING knob BAND switch	1 short beep	
2 Select the mode.	MODE keys	Morse code or 1 short beep*	*:1 short beep can be selected by pressing the CW/N key and the power switch ON. (Please refer to Section 4-2-8)
3 Press the M.IN key.	M.IN	1 short beep	The M.SCR indicator will light.
4 Select the Memory Channel number.	M.CH/VFO CH control		Channels 10 through 19: The SPLIT indicator will light. Channels 20 through 30: The ✱ indicator will light.
5 Press the M.IN key.	M.IN	Long beep	The M.SCR indicator will OFF. Channels 10 through 19: The SPLIT indicator will OFF. Channels 20 through 30: The ✱ indicator will OFF.

### B. Split Memory Channel

Operation		Key	Beep	Remarks
1	Select the receive frequency.	TUNING knob BAND switch	————— 1 short beep	
2	Select the mode.	MODE keys	Morse code or 1 short beep*	*:1 short beep can be selected by pressing the CW/N key and the power switch ON. (Please refer to Section 4-2-8)
3	Press the A=B key.	A=B	1 short beep	
4	Press the A/B key	A/B	1 short beep	The VFO selected B (or A).
5	Select the transmit frequency.	TUNING knob BAND switch	————— 1 short beep	
6	Press the A/B key.	A/B	1 short beep	The VFO selected A ( or B).
7	Press the M.IN key.	M.IN	1 short beep	The M.SCR indicator will light.
8	Select the Memory Channel number.	M.CH/VFO CH control	—————	Select the Memory Channel number 10 through 19. The SPLIT indicator will light.
9	Press the M.IN key.	M.IN	Long beep	The M.SCR indicator will OFF. The SPLIT indicator will OFF.

### C. Programed Band Marker

Operation		Key	Beep	Remarks
1	Select the lowest operating frequency.	TUNING knob BAND switch	————— 1 short beep	
2	Select the mode.	MODE keys	Morse code or 1 short beep*	*:1 short beep can be selected by pressing the CW/N key and the power switch ON. (Please refer to Section 4-2-8)
3	Press the A=B key.	A=B	1 short beep	
4	Press the A/B key	A/B	1 short beep	The VFO selected B (or A).
5	Select the highest operating frequency.	TUNING knob BAND switch	————— 1 short beep	
6	Press the A/B key.	A/B	1 short beep	The VFO selected A ( or B).
7	Press the M.IN key.	M.IN	1 short beep	The M.SCR indicator will light.
8	Select the Memory Channel number.	M.CH/VFO CH control	—————	Select the Memory Channel number 20 through 30. The ✕ indicator will light.
9	Press the M.IN key.	M.IN	Long beep	The M.SCR indicator will OFF. The ✕ indicator will OFF.

#### 4-4-5. Memory Channel Recall

Fixed channel type recall is possible when using the VFO/M key to recall Memory Channel information. The stored frequency cannot be changed.

The following procedure shows how to recall a channel.

1. During VFO operation, press the VFO/M key to initiate Memory Channel operation. This causes the Memory Channel to return to the status (mode, and frequency) prior to the Memory Channel operation.

**Example:**

When 14.175 MHz is stored in Memory Channel 03.

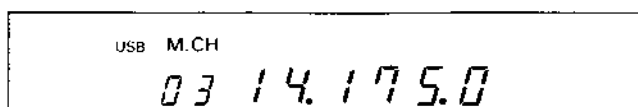

2. Select a Memory Channel by using the M.CH/VFO CH control, or SPLIT key.

**Example:**

When Memory Channel 08 (28.800 MHz) is selected.

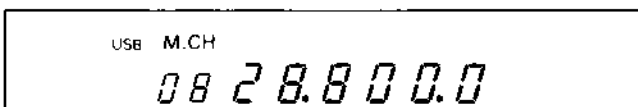

3. If you press the VFO/M key again, the original VFO operating information will be restored.

#### 4-4-6. Checking highest and lowest operating frequencies

The highest and lowest operating frequencies stored in Channels 20 to 30 can be checked by the following method.

1. During VFO operation, press the VFO/M key to initiate Memory Channel operation.
2. Select the desired Memory Channel by using the M. CH/VFO CH control.
3. Press the BAND UP switch.
4. Press the BAND DOWN switch.
5. To return to normal VFO operations press the VFO/M key:

#### 4-4-7. Clearing a Memory Channel

To erase a specific Memory Channel:

1. Press and hold the CLEAR key for approximately 1.5 seconds.
2. Transfer data from an empty Memory Channel to the Memory Channel you wish to clear. (Please refer to Section 4-4-10 for additional information.)

#### 4-4-8. Memory Channel Scroll

The following procedure provides a method to check a Memory Channel Frequency without changing or

losing the current receive frequency.

1. During Memory Channel operation, press the VFO/M key to change to select VFO operation.
2. Press the M.IN key once to initiate Memory Scroll. The M.SCR indicator lights, and the Memory Channel Frequency is displayed. (Although the displayed frequency will change, actual reception will be at the previous frequency (that is, the frequency before the M.IN key is pressed) of the VFO.)
3. Select a Memory Channel using the M.CH/VFO CH control. The frequency stored in the Memory Channel will be displayed.
4. To clear Memory Scroll operation, press the CLEAR key or the M.IN key again to restore Memory Channel operation.

#### 4-4-9. Transferring Memory Information to the VFO.

The following procedure transfers the contents of the Memory Channel to the VFO.

1. In the VFO mode, press the VFO/M key to set the Memory Channel mode. This returns the Memory Channel to the status (mode, and frequency) prior to the VFO operation. To transfer the memory contents to a VFO which is not currently operating, press the A/B key before pressing the VFO/M key, in order to switch to the desired VFO.

**Example:**

When 14.175 MHz is stored in Memory Channel 03.

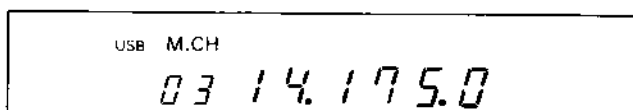

2. Select the desired Memory Channel by using the M.CH/VFO CH control, or SPLIT key.

**Example:**

Memory Channel 06 containing 21.225 MHz is selected.

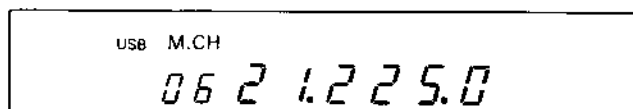

3. Press the M ► V key. The contents of the Memory Channel will be transferred to the VFO and operation changes to the VFO mode.

If you transfer the contents of one of the Split Frequency Memory Channels to the VFO, the transceiver will automatically select the SPLIT mode.

**Notes:**

1. When the M ► V key is pressed, the contents of the VFO are cleared but the contents of the Memory Channel will not be cleared.
2. If nothing is stored in the selected Memory Channel, only the channel number is displayed; no transfer is carried out.



**Example:**

Frequency (21.225 MHz) is transferred to the VFO. When the TUNING knob is turned, the frequency changes from this new frequency.

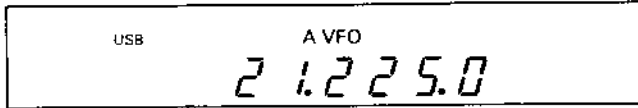

**Notes:**

1. Data in the VFO is replaced by the memory data. Memory data is not lost during this operation.
2. In the Memory Scroll mode (M.SCR LED is lit), Memory Channel information can also be transferred to the VFO.

**4-4-10. Transferring memory information between Memory Channels.**

The following procedure transfers the contents of one Memory Channel to the other Memory Channel.

1. In the VFO mode, press the VFO/M key to select

For example, if a Split Memory Channel is shifted to a programmed band marker, the receiving frequency of the Split Memory Channel will be shifted to the lowest operating frequency, highest operating frequency, and the send/receive frequencies of the programmed band marker.

Transferring memory information to the Memory Channel		Standard Memory Channel (00 to 09)		Split Memory Channel (10 to 19)		Programed Band Marker (20 to 30)		
		Transmit and receive frequency	Receive frequency	Transmit frequency	Lowest operating frequency	Highest operating frequency	Transmit and receive frequency	
Standard Memory Channel (00 to 09)	Transmit and receive frequency	↑	↑	↑	↑	↑	↑	
Split Memory Channel (10 to 19)	Receive frequency	↑	↑	×	↑	↑	↑	
	Transmit frequency	×	×	↑	×	×	×	
Programed Band Marker (20 to 30)	Lowest operating frequency	×	×	×	↑	×	×	
	Highest operating frequency	×	×	×	×	↑	×	
	Transmit and receive frequency	↑	↑	↑	×	×	↑	

**4-4-11. Memory Channel Selection**

To select the desired Memory Channel:

1. Press the VFO/M key if the M.CH indicator does not appear in the display.
2. You can select the desired Memory Channel number by rotating the M.CH/VFO CH control.
3. You can also use the UP/DWN pushbuttons on the microphone to select the desired Memory Channel number.
4. If all Memory Channels are blank a Morse code "EMPTY" will sound from the speaker to signify no memory data is present whenever the M.CH/VFO CH control is rotated.
5. If you wish to find out which Memory Channels are empty press the M.IN key and turn on the 1 MHz switch. Now rotating the M.CH/VFO CH control will

Memory Channel mode. This returns the Memory Channel to the status, (mode, and frequency) prior to the VFO operation.

2. Select the desired Memory Channel by using the M.CH/VFO CH control.
3. Press the M.IN key. The M.SCR indicator will light.
4. Use the M.CH/VFO CH control to select the Memory Channel that you want to transfer to the VFO.
5. When the desired Memory Channel is found and displayed, press the M.IN key again. The current frequency, mode and antenna number will be stored, the Memory Scroll mode will be cancelled.

**Notes:**

1. To erase a Memory Channel when a empty Memory Channel is available, use the procedure given in 4-4-10 above.
2. The various types of memory shift operations are described below.

result in the display of all empty Memory channels. If all Memory Channels contain data a Morse code "FULL" will sound from the speaker as a reminder no empty channels exist.

**4-4-12. Memory Channel Mode Selection**

The Programed Band Marker are the only ones that allow the mode to be changed, while in the M.CH mode. The original contents of the Memory Channel will not be changed on these Memory Channels even though you can switch back and forth from mode to mode.

**4-4-13. Memory channel/RIT relationships**

If the RIT is ON when you switch to M.CH mode the RIT function will be turned OFF until you return to VFO operation automatically by the microprocessor.

## 4-5. SCAN

Both Memory Scan and Program Scan are possible.

### 4-5-1. Memory Scan

During memory channel operation, pressing the SCAN key will cause the radio to scan the memory channels repeatedly, skipping the channels that have on data stored.

To cancel scan press the CLEAR key. A "Check Memory" will be emitted from the speaker in Morse code if you press the SCAN key and the memory channels are vacant. Please refer to Section 4-2-8.

### 4-5-2. Programmable Band-scan

If you press the SCAN key during VFO operation scan will begin at the current frequency and proceed upwards. "P" will appear in the display to signify Program Scan. To cancel this scan operation press the CLEAR key. If channel 30 is empty the lower limit of 50.0 kHz and an upper limit of 34.999.9 MHz (59.999.9 MHz with the TS-680S) will automatically be stored when the SCAN key is depressed.

- a. If scan is initiated within the limits specified in Memory Channel 30 scan will proceed thru that range.

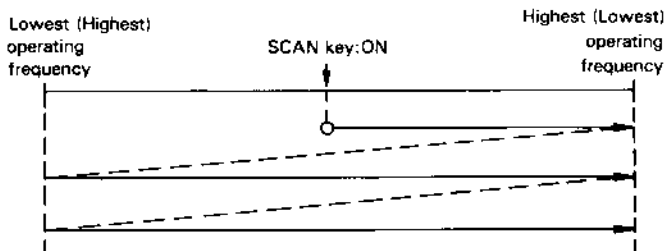

- b. If scan is initiated outside the limits specified in Memory Channel 30 scan will proceed outside of the programmed limits.

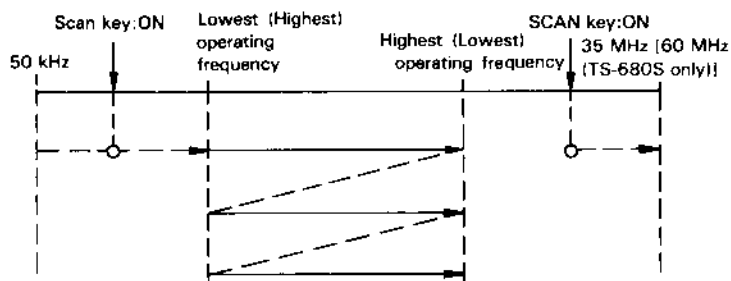

### 4-5-3. Scan Speed

The scanning speed is adjustable from the front panel by using the RIT control during SCAN operations. Clockwise rotation increases the scan speed and counterclockwise rotation decreases the scan speed. This speed adjustment is effective in both VFO and M.CH scan modes. Once set the scan speed remains in memory until it is again changed by the RIT control. You must be in the SCAN mode in order to alter the scan speed.

Rotating either the TUNING knob or the M.CH/ VFO CH control will perform large changes in the operating frequency.

### 4-5-4. Scan Hold

The Scan Hold function is selected by using the Power on function selection described in Section 4-2-8.

### 4-5-5. Memory Channel Lockout

This transceiver has a Memory Channel lockout function which allows you to temporarily skip unwanted Memory Channels during memory scan. Locking out unwanted channels will help to increase the effective scan speed.

1. Press the VFO/M key to enter the Memory Channel mode.
2. Select the Memory Channel that you want to skip using the M.CH/VFO CH control, or SPLIT key.
3. Press the CLEAR key.

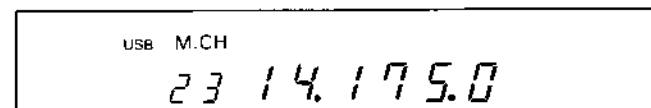

4. A decimal point will appear in the M.CH display to indicate that the channel will be skipped.

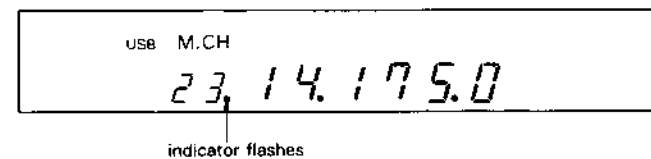

5. To cancel the lockout, select the desired channel and then press the CLEAR key. The decimal point will go out indicating that the channel will again be scanned.

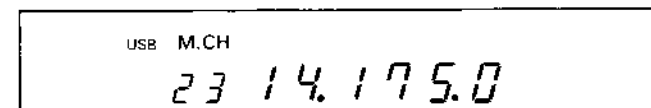

#### Notes:

1. Holding the CLEAR key depressed for longer than 1.5 seconds will clear that channel.
2. If memory scan is initiated while all Memory Channels are locked out a Morse code "CHECK MEMORY" or 3 short beeps will sound from the speaker, depending upon the programming of the Power on functions. Refer to Section 4-2-8 for additional information of the power on functions.

## 4-6. REPEATER

Some 10 meter repeaters require the use of the optional TU-8 Tone Unit. These repeaters permit a very wide coverage area at relatively low power levels using the FM mode. The combination of the low noise mode combined with the generally good propagation offered by this band makes for some excellent low power contacts.

**Note:** \_\_\_\_\_  
During VFO "SPLIT" operations the Tone Encoder is disabled.

1. First select the desired receiver frequency in VFO A.
2. Then select the desired transmitter frequency in VFO B.
3. Press the A/B key to return to VFO A.
4. Press the M.IN key.
5. Select the desired Memory Channel between 10 and 19.
6. Press the M.IN key to enter the transmit and receive frequency.
7. Press the microphone PTT switch or place the standby switch to SEND and speak into the microphone.

**Note:** \_\_\_\_\_  
Check the intended transmitter frequency before transmitting to avoid interrupting another QSO.

8. Release the PTT/SEND switch to return to the receive mode.

# 5. CIRCUIT DESCRIPTION

## 5-1. GENERAL DESCRIPTION

The TS-140S/680S utilizes double-conversion for FM transmissions, and triple-conversion for all other transmission modes, and for all modes in receive. The intermediate frequencies are 40.055 MHz and 455 kHz.

A wide dynamic range is made possible thru the use of 2SK125 junction FET's in the receiver section's 1st and 2nd mixers.

An integrated circuit balanced modulator (SN16913) is used in the 1st transmitter mixer and 3SK122 is used in the 2nd mixer. The PLL circuit, consisting of 4 loops, and the digital VFO are controlled by a single reference oscillator circuit. IF SHIFT and 10 Hz tuning steps are provided thru the use of this system.

## 5-2. TRANSMITTER SECTION

The incoming microphone audio is routed to the SW unit where it is amplified by the microphone amplifier and then distributed to the SSB, FM and VOX circuits. (VOX circuit is TS-140S only.)

The amplified SSB audio signals are converted into a 455 kHz DSB (Double Sideband) signal by the balanced modulator (AN612). The signal is then filtered by a ceramic filter in order to obtain the desired SSB signal. This signal is then mixed with a local oscillator signal of 39.6 MHz by the first mixer which results in a 40.055 MHz signal. This signal is filtered by a monolithic crystal filter (MCF) and combined with the VCO frequency, in the 2nd Mixer, to obtain the final transmit frequency. In FM the microphone audio signal is amplified and used to directly modulate the 39.6 MHz local oscillator. This FM signal is then mixed with the VCO signal to obtain the final transmit frequency. The SSB and FM signals enter the final unit for amplification to the final output power level. This signal is applied to the Low Pass Filter where unwanted spurious components are removed before actual transmission.

## 5-3. RECEIVER SECTION

The incoming signal for the antenna is fed to the receive band-pass filters in the signal unit, via a front panel controlled attenuator circuit.

The appropriate bandpass filter is automatically selected based upon control information supplied by the Control Unit. Independent RF amplifiers are also included for the 28, and 50 MHz bands and can be turned OFF or ON via a front panel control. (TS-680S only)

Signals from the BPF are mixed with the VCO signal in the 1st RX mixer to obtain the 1st IF frequency of 40.055 MHz. This signal is filtered by a MCF (Monolithic Crystal Filter) and applied to the 2nd RX mixer. This mixer combines the 1st IF frequency with the HET OSC frequency of 39.6 MHz to obtain the 2nd IF frequency of 455 kHz.

This signal is separated and applied to two different areas. One is used to control the operation of the Noise Blanker. The other signal passes the Noise Blanker gate is amplified, and passed thru the appropriate IF filter. The SSB, CW, and AM signals are amplified further and then demodulated by their respective detector circuits. The FM signal is amplified and detected in a custom IC.

## 5-4. CIRCUIT BOARD DESCRIPTION

The TS-140S/680S contains the following major units: Signal unit, Control unit, Filter unit, Final unit, Display unit, Switch unit, etc. A brief description of these units follows.

### 5-4-1. Signal Unit (X57-3190-00, 3200-10)

The signal unit is composed of the transmit and receive sections. These consists of the Signal system amplifiers, mixers, detectors, modulators, filters, VCO's, and the various timing circuits used for transmit/receive switching. This unit handles practically all TS-140S/680S signal processing.

### 5-4-2. Control Unit (X53-3100-11, 12)

The control unit is composed of the frequency control section which is controlled by a microprocessor and four PLL loops. The unit also contains a reference oscillator, operating at 36 MHz, which is the reference for all frequencies generated by the transceiver.

### 5-4-3. Display Unit (X54-3050-00)

The display unit consists of a fluorescent display tub, LED indicator section, DC to DC converter, and various switching circuits.

### 5-4-4. Final Unit (X45-3100-00, 11)

This unit amplifies the TX RF signal for transmission. This is accomplished by utilizing a three-stage final amplifier section having a relatively low collector loss figure, and a high efficiency cooling system.

### 5-4-5. Filter Unit (X51-3040-00, 11)

The filter unit removes the undesirable spurious high frequency components from the transmitter output. A 50 MHz power module is also included in this section for the TS-680S.

### 5-4-6. Switch Unit (X41-3030-00, 11)

The switch unit includes the speech processor and the MIC amp circuit.

## 5-5. BLOCK DIAGRAM

### 5-5-1. TS-140S BLOCK DIAGRAM

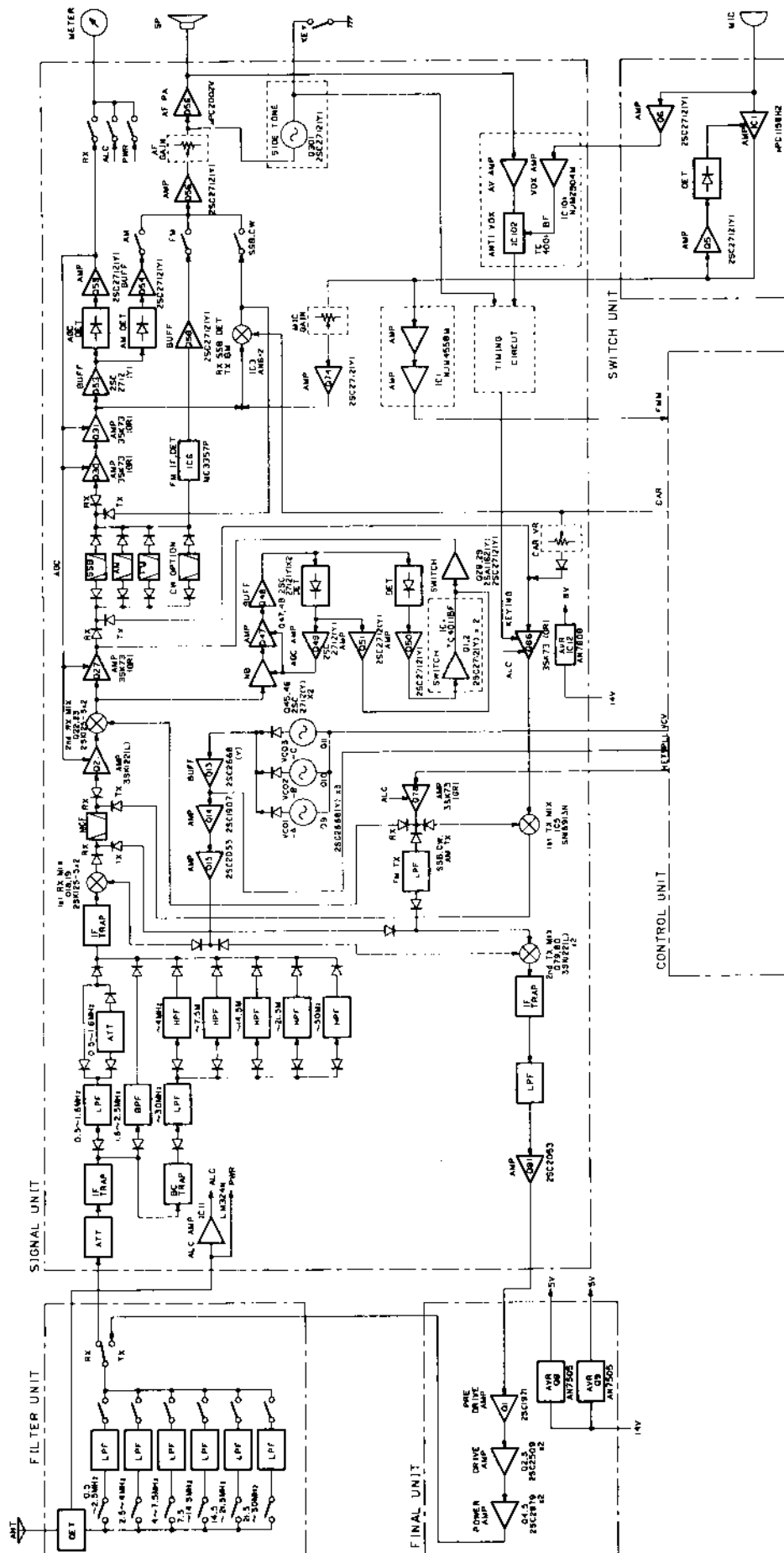

Note: Block Diagram is subject to change without notice due to advancements in technology.



# 6. MAINTENANCE AND ADJUSTMENTS

## 6-1. GENERAL INFORMATION

Your transceiver has been factory aligned and tested to specification before shipment. Under normal circumstances the transceiver will operate in accordance with these operating instructions. All adjustable trimmers and coils in your transceiver were preset at the factory and should only be readjusted by a qualified technician with proper test equipment. Attempting service or alignment without factory authorization can void the transceiver's warranty.

When operated properly, the transceiver can give years of service without requiring realignment. The information in this section gives some general service procedures which can be accomplished without sophisticated test equipment.

## 6-2. SERVICE

Should it ever become necessary to return the equipment to your dealer or service center for repair, pack in its original box and packing, and include a full description of the problems involved. Also include your telephone number. You need not return accessory items unless directly related to the service problem.

You may return your radio for service to the Authorized KENWOOD Dealer from whom you purchased it. A copy of the service report will be returned with the unit. Please do not send sub-assemblies or printed circuit boards. Send the complete unit, in its original boxes and packing.

Tag all returned items with your name and call for identification. Please mention the model and serial number of your radio in any correspondence, whether phone or written. For future reference, record this information in the space provided on the back cover of this manual.

**Service note:** \_\_\_\_\_

Dear OM, if you desire to correspond on a technical or operational problem, please make your note short, complete, and to the point. And PLEASE make it readable.

**Please list:** Model and serial number.

The question or problem you are having.

Please give sufficient detail to diagnose: other equipment in the station, meter readings and anything you feel might be useful in attempting diagnosis.

**Caution:** \_\_\_\_\_

Do not pack the equipment in crushed newspapers for shipment! Extensive damage may result, during shipping.

**Notes:** \_\_\_\_\_

1. Record the date of purchase, serial number and dealer from whom purchased.
2. For your own information, retain a written record of any maintenance performed on the unit.
3. When claiming warranty service, please include a photocopy of the bill of sale, or other proof of purchase showing the date of sale.

## 6-3. CLEANING

The knobs, front panel and cabinet of the transceiver are likely to become soiled after extended use. The knobs should be removed from the transceiver and cleaned with a neutral soap and warm water. Use a neutral soap (not harsh chemicals) and damp cloth to clean the cabinet and front panel.

## 6-4. IN CASE OF DIFFICULTY

The problems described in this table are failures caused in general by improper operation or connec-

tion of the transceiver, not by defective components. Examine and check according to the following table. If the problem persists, contact an authorized agent or service station.

### RECEPTION

Symptom	Probable cause	Corrective action
Indicators do not light and no receiver noise is heard when the POWER switch is turned on.	<ol style="list-style-type: none"> <li>1. Bad power cable or connections.</li> <li>2. Blown power supply fuse.</li> <li>3. Power supply is OFF.</li> </ol>	<ol style="list-style-type: none"> <li>1. Check cables and connections.</li> <li>2. Check for the cause of the blown fuse and replace the fuse.</li> </ol>
Nothing is displayed or wrong digits are displayed when the POWER switch is turned on.	The microprocessor may malfunction if the input voltage is too low.	<ol style="list-style-type: none"> <li>1. Use a step-up transformer to raise the line voltage. Use a 12 V to 16 V battery.</li> <li>2. Turn on the POWER switch while depressing the A=B (or A/B) key, and then release the A=B (or A/B) key.</li> </ol>
When you press the POWER switch, "14 MHz USB" is displayed ...or the receive sensitivity is low.	The backup battery voltage is low.	Please refer to Section 4-4-1.
No signal is received even when the antenna is connected or the receiving sensitivity is low.	<ol style="list-style-type: none"> <li>1. SQL control fully clockwise.</li> <li>2. The ATT switch is ON.</li> <li>3. The standby switch is in the SEND position.</li> <li>4. Microphone PTT switch is in the transmit position.</li> <li>5. No optional CW filter is installed and the mode switch is in the CWN position.</li> </ol>	<ol style="list-style-type: none"> <li>1. Turn the SQL control counter-clockwise.</li> <li>2. Set the ATT switch off.</li> <li>3. Set standby switch to REC.</li> <li>4. Set the PTT switch to the receive position.</li> <li>5. Select a different mode.</li> </ol>
An antenna is connected, but no signal is received and the S-meter fully deflects.	RF GAIN control is too low, decreasing the high frequency circuit gain.	Turn the RF GAIN control MAX position.
The S-meter deflects and stays at a certain position even with no signal.	<ol style="list-style-type: none"> <li>1. Low AC line voltage.</li> <li>2. RF GAIN control closed.</li> </ol>	<ol style="list-style-type: none"> <li>1. Use a step-up transformer to raise the line voltage. Use a 12 V to 16 V battery.</li> <li>2. Turn the RF GAIN control MAX position.</li> </ol>
Signal is received, but no sound is heard.	MODE key position is incorrect.	Change the MODE key to the correct mode.
SSB received signal is extremely high cut or low cut.	IF SHIFT control is wrong adjusted.	Set the control to the center (click position).
Frequency is not changed by pressing the UP/DOWN switches, turning the TUNING knob, or M.CH/VFO CH control.	F.LOCK key is ON.	Set F.LOCK key to OFF.
Memory scan fails.	Nothing is stored in memory.	Store the frequency.
Display goes out with VFO/M ON.	When nothing is stored in the memory channel, a channel is displayed and blanked with only the decimal point displayed.	

#### Note:

A heterodyne signal may be heard at or around 4.5 MHz and 12.89 MHz. This is due to the internal frequency configuration of the radio and is not an indication of any problem. It is normal.



## Transmit

Symptom	Probable cause	Corrective action
Output	1. Microphone jack is not plugged in. 2. Poor antenna connection.	1. Plug jack in. 2. Connect antenna securely.
In CW, pressing the key does not cause transmission.	1. Key jack is not plugged in. 2. Poor key contact.	1. Plug jack in. 2. Clean contact.
In USB, LSB, CW, AM, or FM the called station does not answer.	RIT causes send and receive frequency mismatch.	Press RIT switch to exit RIT mode.
Linear amplifier does not key.	1. Internal switch was not moved.  2. REMOTE connector is miswired, or has a poor contact.	1. Move the switch as described in section 6-6-8. 2. Correct wiring.

## 6-5. ORDERING SPARE PARTS

When ordering replacement or spare parts for your equipment, be sure to specify the following:  
Model and serial number of your transceiver.  
Schematic number of the part. Printed circuit board

number on which the part is located, part number and name, if known, and quantity desired. Part numbers for most replacement parts is contained in the service manual (available as an option from your dealer).

## 6-6. ADJUSTMENTS

### 6-6-1. Cover Removal

#### Removing the covers

Remove the top cover (4 screws), and the bottom covers (8 screws) from radio.

#### Cautions:

1. Before removing the cover, turn the DC power supply's power switch OFF and disconnect the power cable.
2. Do not pinch wiring when opening or closing cases.

### 6-6-2. Remove the Subchassis

1. Remove the four screws as shown in the diagram.
2. Open in a counterclockwise direction.

#### Cautions:

1. Open on a flat surface.
2. Be careful not to damage the wiring.
3. Do not catch your finger or the cables between the chassis when closing.

### A. Top Cover

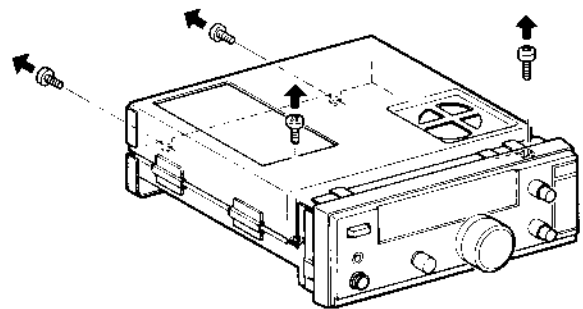
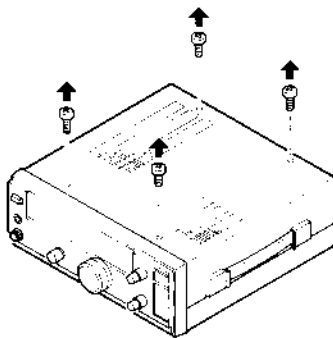

### B. Bottom Cover

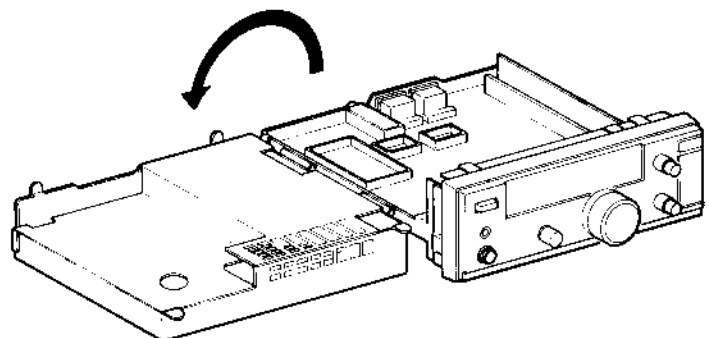
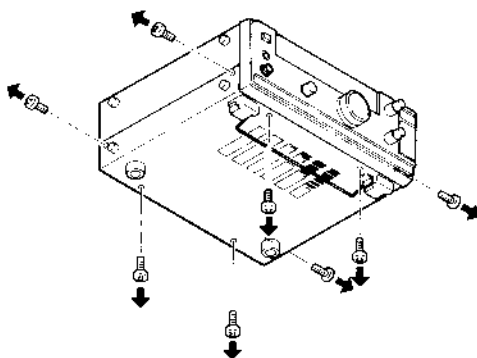

### 6-6-3. Sidetone Level

Turn VR21 while holding down the key in the USB, LSB, or CW mode for the desired tone level.

### 6-6-4. Beep Tone Level

Turn VR23 to the desired tone volume.

### 6-6-5. Adjusting the Data Communications Modulation Input Level.

Set the input level for the desired modulation level with VR-1. Input is reduced by turning the control counterclockwise, and increased by turning clockwise.

### 6-6-6. Microphone sensitivity level

Select the desired sensitivity by adjusting VR5.

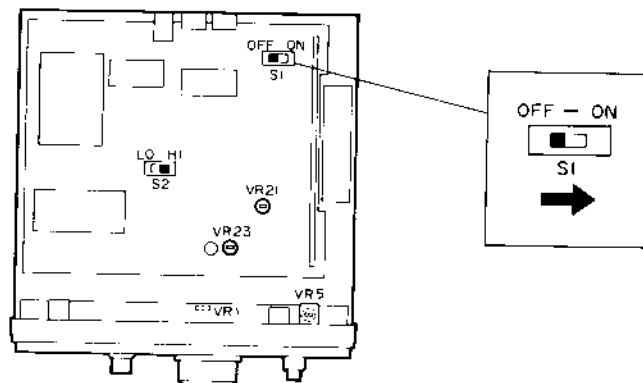
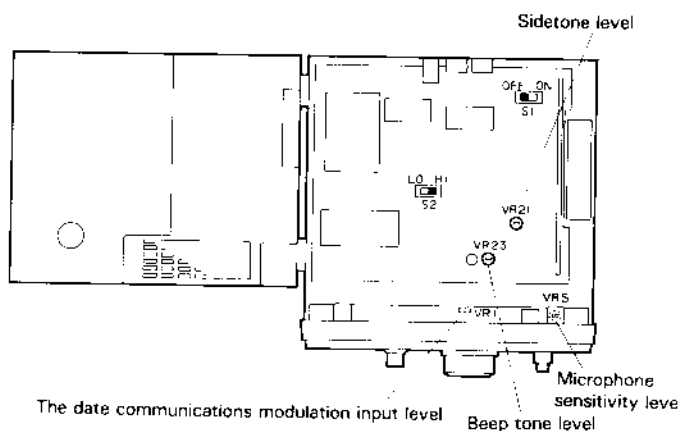

12 volts at approximately 10 mA maximum is available at pin number 7 of the REMOTE connector for control of an external keying relay, if necessary. We recommend the use of a 7 pin DIN plug for this connection. When operation of this transceiver with the TL-922/922A is anticipated you should use the control cable supplied with the linear amplifier.

#### Note:

The TL-922/922A is NOT designed for Full Break-in operation. Attempting operation of the linear in this mode might lead to damage in the linear amplifier. Ensure the CW switch is in the SEMI or OFF position before operating the TL-922/922A.

### 6-6-9. Digital display calibration

1. Remove the case and open the subchassis. Please refer to Sections 6-6-1 and 6-6-2.

**Caution:**  
Open on a flat surface.

2. Plug the accessory calibration cable to any one of the TP1 pins at upper left of the signal unit.
3. Plug the other end of the calibration cable to Pin TP7 on the control unit in bottom.
4. Connect your antenna and tune to WWV.
5. Using a small flat bladed screwdriver adjust trimmer capacitor TC1 of the control unit, for zero beat. Zero beat is the point where the two audio tones are oscillating at the slowest rate.
6. The reference frequency has been calibrated correctly.
7. Pull out the calibration cable.

### 6-6-7. Semi Break-in Delay Time

In the CW mode, turn the DELAY control for the desired delay time.

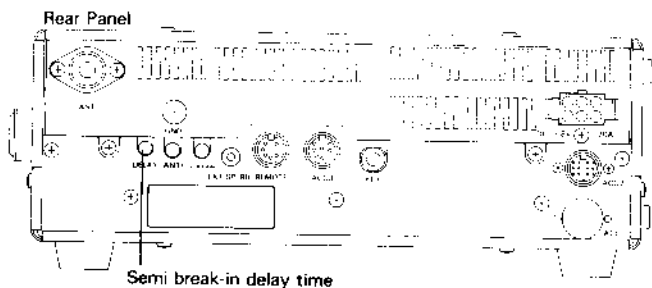

### 6-6-8. Linear Amplifier Control

The external control relay is not activated at the factory so that the operation of the radio will remain at the lowest mechanical noise level during CW Full break-in operations. If the use of this control relay is required, such as for use with an external linear amplifier it may be activated with the following procedure.

1. Remove the top and bottom covers of the transceiver. Refer to Sections 6-6-1 and 6-6-2.
2. Set the slide switch (S1) on the signal unit to ON as shown in the accompanying diagram.

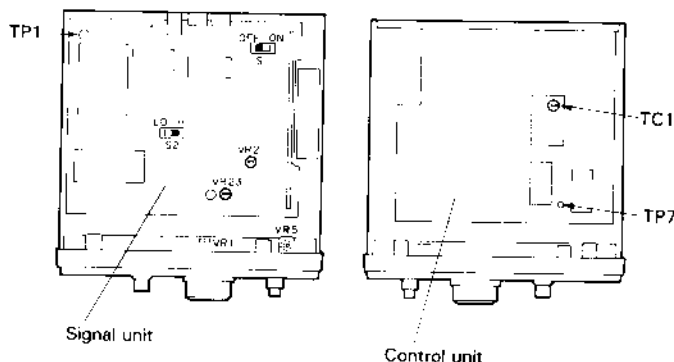

# 7. OPTIONAL ACCESSORIES

## 7-1. CW FILTER INSTALLATION

1. Remove the case and open the subchassis. Please refer to Sections 6-6-1 and 6-6-2.

**Caution:** \_\_\_\_\_  
Open on a flat surface.

2. Remove the two screws on the boss of the small printed circuit board on the right side of the signal unit.

3. Plug the CW filter in to the connector. The filter is not polarized so it may be placed in either direction.

**Note:** \_\_\_\_\_  
Do not pinch any cable harnesses when reassembling.

4. Secure with the screws removed in Step 2.

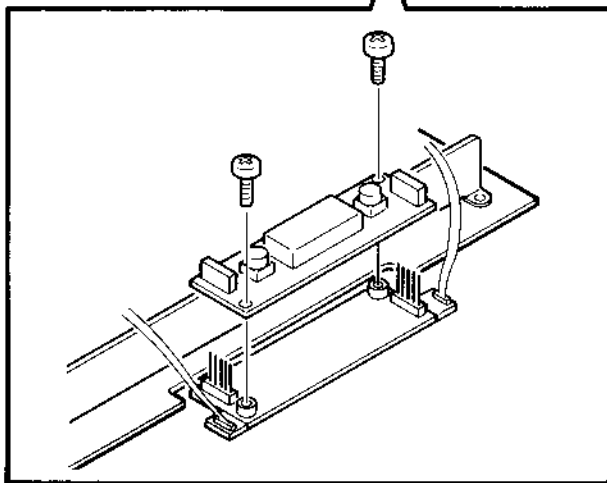
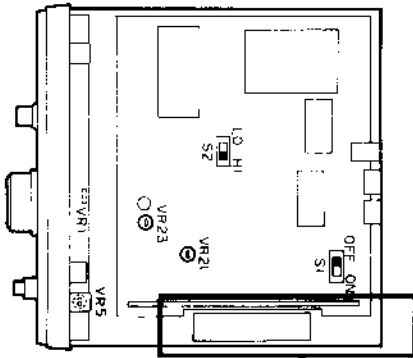

5. Close the subchassis and replace the top and bottom covers.

**Note:** \_\_\_\_\_  
Avoid catching your fingers and wiring harness when closing.

## 7-2. TU-8 TONE UNIT INSTALLATION

1. Remove the top and bottom covers of the transceiver. Refer to Sections 6-6-1 and 6-6-2.

2. Remove the backing from the cushion attached to the front of the signal unit.

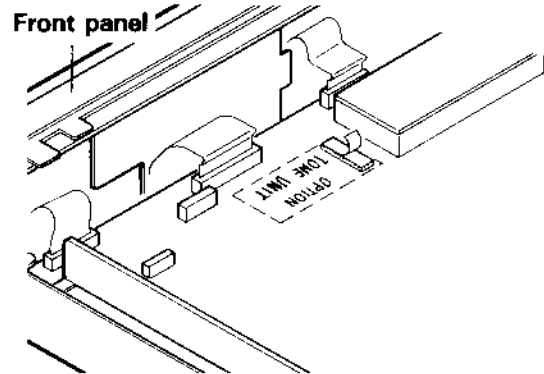

3. Remove the backing from the cushion attached to the TU-8.

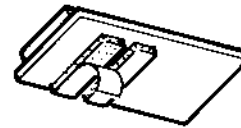

4. Attach the TU-8 in the area illustrated (Labeled OPTION TONE UNIT) on the signal unit.

**Note:** \_\_\_\_\_  
Do not pinch any cable harnesses when reassembling.

5. Plug in the 3 pin connector that is located near the TU-8 as shown.

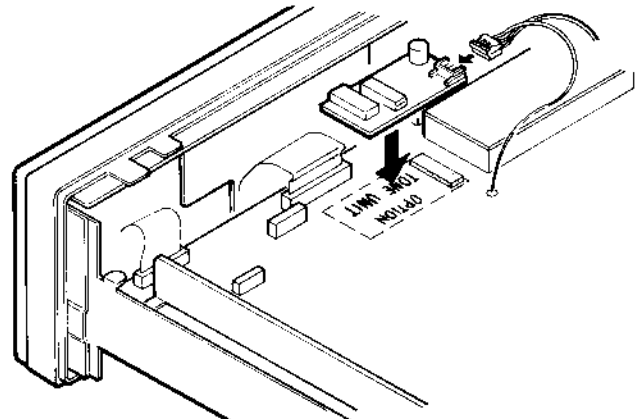

6. Close the subchassis and replace the top and bottom covers.

**Note:** \_\_\_\_\_  
Avoid catching your fingers and wiring harness when closing.

### 7-3. IF-10C INTERFACE KIT INSTALLATION

1. Remove the bottom cover of the transceiver. Please refer to Section 6-6-1.
2. Install the IF-10C in the upper left of the control unit with the 4 screws provided with the IF-10C. Ensure the unit is properly positioned as shown in the diagram.

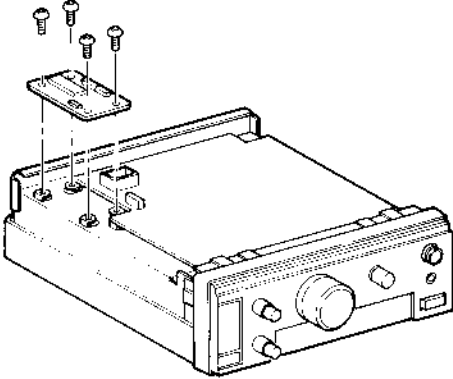

5. Attach the DIN connector from the IF-10C with the supplied bracket and mounting screws. Lay the wiring along the back of the set.

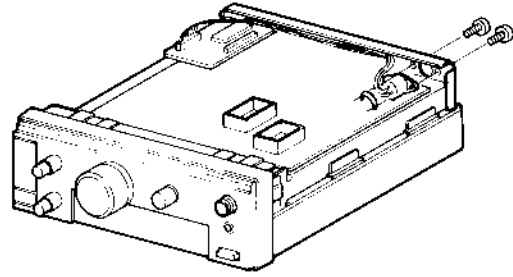

6. Reinstall the bottom cover.

**Note:**

Do not pinch any cable harnesses when reassembling.

3. Insert the 7 and 9 pin connectors from the IF-10C onto connectors CN8 and CN9 near the center of the control unit. Lay the wiring along the back of the set.

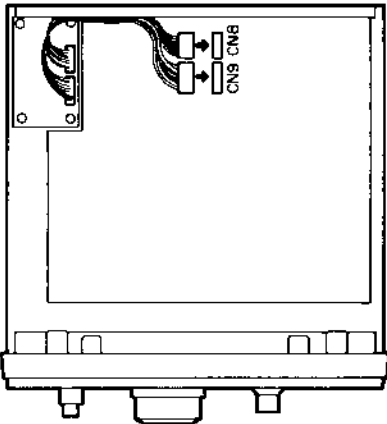

4. Remove the black filler from the ACC1 area on the back of the transceiver.

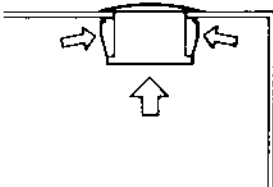

## 7-4. OTHER ACCESSORIES

### ■ PS-50 HEAVY DUTY DC POWER SUPPLY

Designed to match the TS-140S/680S. Supplies regulated 13.8 VDC at 20 A with built-in cooling fan and protection circuits for maximum reliability.

### ■ PS-430 DC POWER SUPPLY

The PS-430 is a regulated DC power supply with high current capability. The output is 13.8 VDC/20 A (intermittent). Since terminals for 13.8 VDC/10 A are also provided, in addition to an output power cable for use with the TS-140S/680S, the PS-430 can be used as the power source for another low power mobile transceiver such as a 2-meter rig.

### ■ AT-250 AUTOMATIC ANTENNA TUNER

The AT-250 Automatic Antenna Tuner covers 160 through 10 meters bands.

### ■ AT-130 ANTENNA TUNER

The AT-130 Antenna Tuner covers 80 through 10 meters bands.

### ■ MC-85 MICROPHONE (8-pin)

The MC-85 is a unidirectional high-class electret condenser microphone provided with the output selective switch, audio level compensation circuit, low cut filter, level meter, PTT and LOCK switches. An 8-pin cable is provided, with optional cables, up to three outputs are possible.

### ■ MC-80 MICROPHONE (8-pin)

The MC-80 is an omnidirectional electret condenser microphone provided with UP/DOWN switches, volume adjustment for output level, PTT and LOCK switches, built-in pre-amplifier.

### ■ MC-60A MICROPHONE (8-pin)

The zinc die-cast base provides high stability, and the MC-60A is complete with PTT and LOCK switches, UP/DOWN switches, and impedance selector switch and a built-in pre-amplifier.

### ■ MC-55 MOBILE MICROPHONE (8-pin)

The MC-55 provides UP/DOWN switches, LED display for switching transmit or receive, adjustable microphone gain, automatic receive returning circuit (approx. 5 minutes) and many functions.

### ■ MC-43S UP/DOWN HAND MICROPHONE

The MC-43S is handy dynamic microphone with PTT switch and UP/DOWN switches.

### ■ LF-30A LOW PASS FILTER

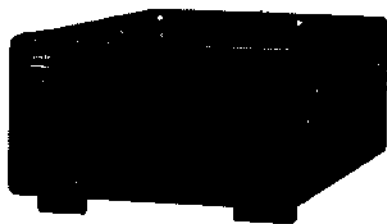

PS-50

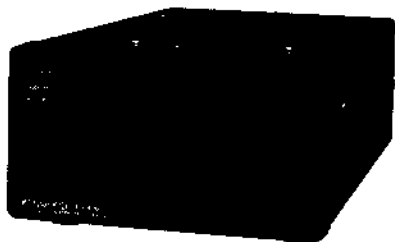

PS-430

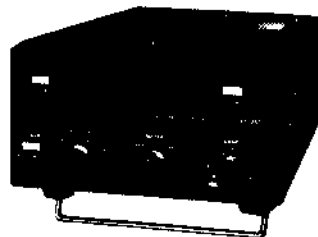

AT-250



MC-85



MC-80



MC-60A



MC-55



MC-43S

■ **MB-430 MOBILE MOUNT**

The Mobile Mount MB-430 allows easy installation and removal of the TS-140S/680S. The MB-430 can either be suspended from the dashboard or attached to the transmission tunnel or a center console. The transceiver tilt angle can be adjusted 5 steps.

■ **PG-2S DC POWER CABLE**

■ **MA-5 5 BAND HELICAL TYPE HF MOBILE ANTENNA**

■ **VP-1 BUMPER MOUNT FOR MA-5**

■ **SP-430 EXTERNAL SPEAKER**

The SP-430 is an attractive, compact external speaker. This low-distortion speaker provides clear reproduction of the high-quality audio obtained from the transceiver.

■ **SP-50B MOBILE SPEAKER (8 ohms)**

Compact and smart high quality external speaker provides flexibility of installation for maximum convenience.

■ **SP-41 MOBILE SPEAKER (4 ohms)**

■ **TL-922A/TL-922 HF LINEAR AMPLIFIER**

(Not for QSK operation.)

The TL-922A/922 is an HF linear amplifier operating at maximum legal power, and employing a pair of 3-500Z high performance transmitting tubes. TL-922A (without 10 meter band) is available only in U.S.A.

■ **SM-220 STATION MONITOR**

Built around a basic 10 MHz oscilloscope, the SM-220 station monitor features, in combination with a built-in two-tone generator, a variety of waveform-observing capabilities.

■ **PC-1A PHONE PATCH**

(Available only where phone patch operation legal.)

Hybrid phone patch with VU meter for null and audio gain measurements. The PC-1A Phone Patch provides interface between the transceiver and telephone line. Providing excellent performance, it is designed with high isolation between receive input and transmit output. Its compact design permits easy installation in a limited space. (FCC Part 68 registered)

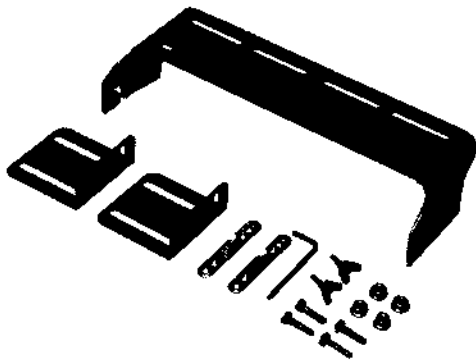

MB-430

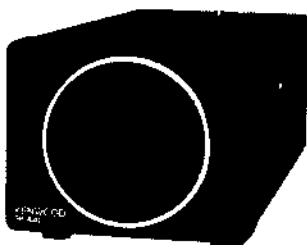

SP-430

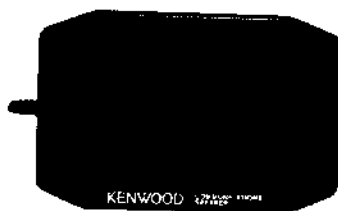

SP-50B

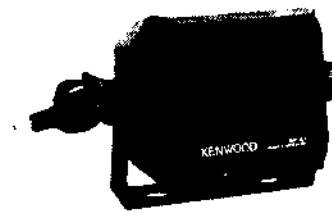

SP-41

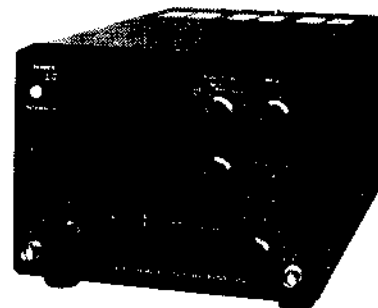

SM-220

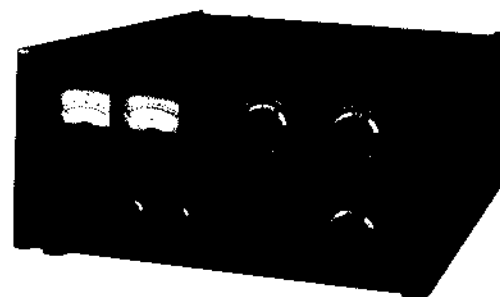

TL-922A/TL-922

■ **TU-8 SUBAUDIBLE TONE UNIT**

38 CTCSS tone frequencies can be selected by setting of the dip switch.

■ **IF-232C INTERFACE**

The IF-232C Interface is the adapter for connection between the RS-232C terminal of a personal computer and the interface terminal of the TS-140S/680S.

■ **IF-10C INTERFACE KIT**

■ **SW-2000 SWR/POWER METER**

SWR/POWER meters cover 1.8~54 MHz in range of 0~200/2000 W, full scale for base station use.

■ **SW-200A SWR/POWER METER**

SW-200A supplied with SWC-1. Selectable Peak-reading/RMS. SWR/POWER meters cover 1.8~150 MHz in range of 0~20/200 W full scale for base station use.

■ **SW-100A SWR/POWER METER**

Compact and lightweight SWR/POWER/VOLT meters cover 1.8~150 MHz in range of 150 W full scale for mobile use.

■ **HS-7 MICRO HEADPHONES (16 OHMS)**

■ **HS-6 COMMUNICATIONS HEADPHONES (12.5 OHMS)**

Deluxe, very light-weight headphones designed for communications equipment.

■ **HS-5 COMMUNICATIONS HEADPHONES (8 OHMS)**

Headphones designed for communications equipment. These light-weight open air-type headphones remain comfortable during extended operation. Easily attached earpads are provided.

■ **YG-455C-1**

Center frequency : 455 kHz  
Pass band width : 500 Hz (-6 dB)  
Attenuation band width : 820 Hz (-60 dB)  
Guaranteed attenuation : Better than 80 dB

■ **YK-455C-1**

Center frequency : 455 kHz  
Pass band width : 500 Hz (-6 dB)  
Attenuation band width : 2 kHz (-60 dB)



SW-200A



SW-100A



SW-2000



HS-7



HS-6



HS-5

# 8. REFERENCE

## 8-1. ANTENNA INSTALLATION

### 8-1-1. Fixed Station

For HF fixed-station operation, an antenna specifically designed for amateur operation is recommended. Antenna types include wire antennas, verticals, rotary beams, and other antenna types. (Fig. 8-1) HF antennas are quite large and must be installed to withstand strong wind, heavy rain, etc.

Any antenna used with the TS-140S should be of 50-ohm impedance and should be connected using an appropriate coaxial cable such as 5D-2V.

Impedance matching is important. Impedance mismatching will result in a high VSWR and power loss, or can cause unwanted harmonic radiation and interference (TVI, BCI).

The impedance match can be checked with an SWR meter. Generally, satisfactory operation is assured when the VSWR (Voltage Standing Wave Ratio) is less than 1.5:1.

A rotary beam antenna is very effective for DX communication in the 14,21 and 28 MHz bands. (Fig. 8-2) If open wire or balanced type transmission line is used with the antenna, a suitable antenna tuner with balun is recommended between the transceiver and the feed line. Methods of construction and operating such tuners are described in detail in the ARRL Antenna Handbook, or similar publications. For operation on the 160,75 and 40 meter bands, a simple dipole antenna, cut to resonance in the most used portion of the band, will perform satisfactorily. For operation on the 10,15 and 20 meter bands, the efficiency of the station will be greatly increased if a good directional rotary antenna is used. Remember that even the most sophisticated transceiver is useless without a good antenna.

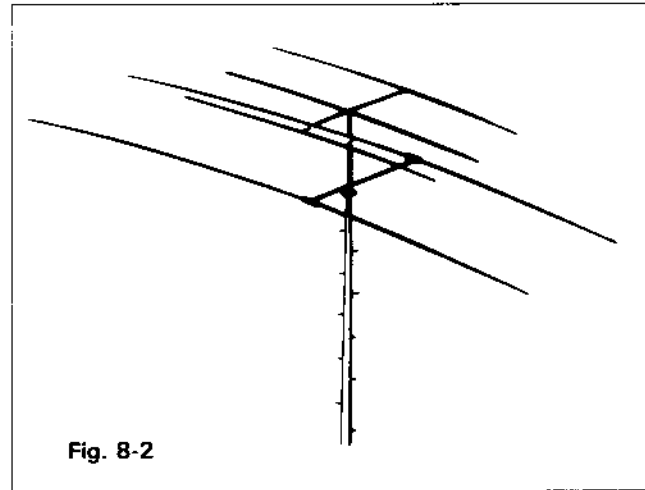

Fig. 8-2

### 8-1-2. Mobile

#### (1) Antenna

Use a sturdy mount for the mobile antenna since HF antennas are larger (and have more wind load) and are heavier than VHF antennas. A bumper mount is recommended for general use. The ground side of the mount must be well grounded to the car body, since the body itself functions as the ground plane for the mobile antenna. (Refer to Fig. 8-4)

#### Notes:

1. Some cars have plastic bumpers. For such cars, ground the antenna mount to the body.
2. When tuning a newly installed antenna, use the following procedure:
  - Turn the CAR control fully counterclockwise for minimum transmit power.
  - With the transceiver in transmit mode. Raise transmit power output slowly by rotating the CAR control clockwise. The antenna should be adjusted with minimum power.
  - Transmitting with full power is recommended only after the antenna has been adjusted for a VSWR below 1.5:1.
3. Antenna installation is critical for successful mobile operation. For further information refer to THE RADIO AMATEUR'S HANDBOOK, RADIO HANDBOOK, or other texts.

#### (2) Coaxial cable connection

When the antenna is mounted on the vehicles bumper, the coaxial cable from the antenna can be routed through a drain hole in the trunk. When the antenna is roof mounted pass the cable between the body and door. Leave a driploop at the lowest point in the cable before entry into the vehicle to prevent water from entering the car.

#### (3) Adjustment

Some mobile antennas are not designed at 50-ohm impedance. In this case, impedance matching between the antenna and the coaxial cable (50  $\Omega$ ) is required. This can be achieved by using an antenna matching device or coupler.

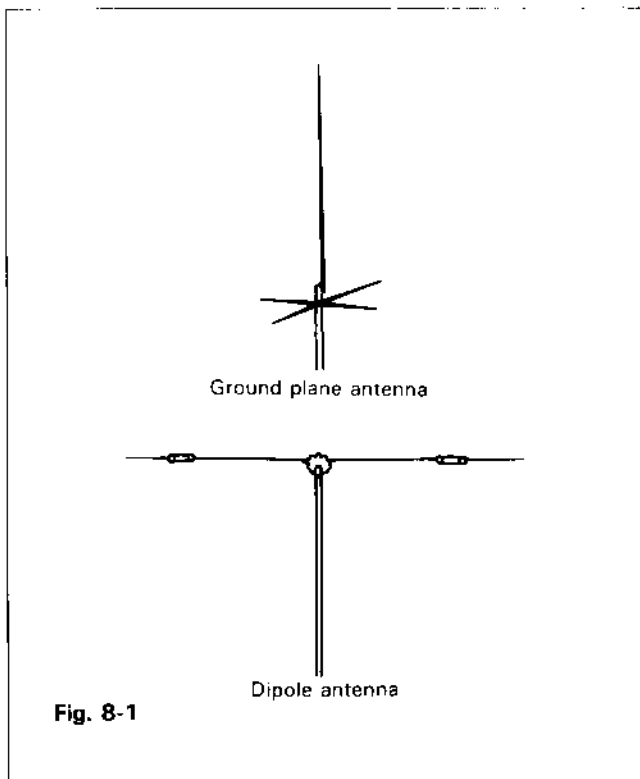

Fig. 8-1



The antenna to be used should first be checked with a dip meter to insure that it is designed for your operating band, then the impedance matching should be checked with an SWR meter. (Fig. 8-3) The VSWR should preferably be less than 1.5:1 for satisfactory operation. For antenna adjustment refer to the antenna instruction manual.

**(4) Antenna matching**

In general, mobile antennas have a lower impedance than the 50-ohm coaxial cable used to feed them, resulting in a mismatch between the antenna and the coax. Such trouble can be eliminated by using an antenna tuner between the transceiver and the coaxial cable.

• **Matching circuit examples**

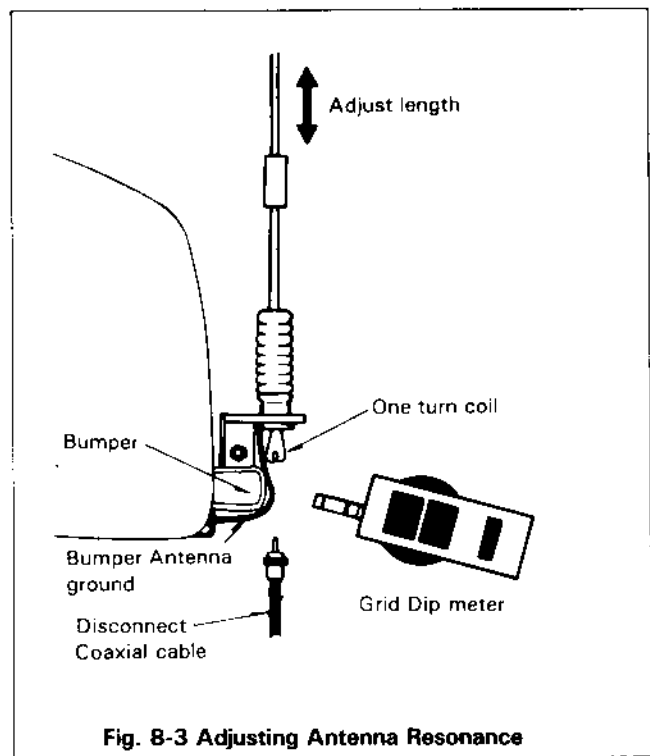
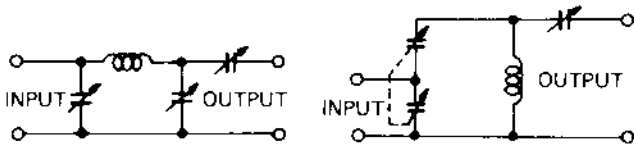

**8-2. MOBILE OPERATION**

**8-2-1. Installation**

Route battery and ANTENNA leads away from all high voltage secondary circuits to prevent ignition noise interference.

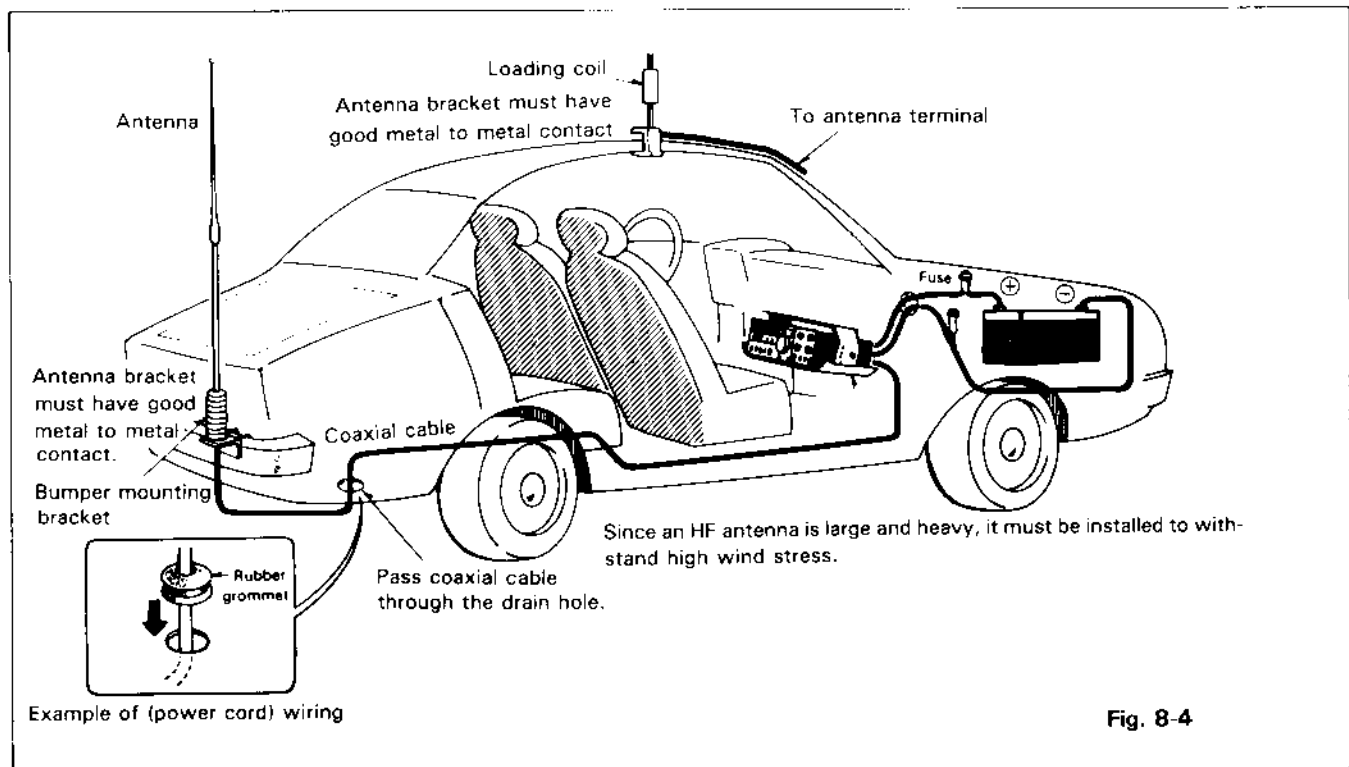

### **8-2-2. Noise Reduction**

In motor vehicles, noise is generated by the ignition system. Other sources of noise include the wiper and heater motors.

Although the transceiver is equipped with a noise blanker to minimize ignition noise, it is imperative that some preventive measures be taken to reduce the noise to the lowest possible level.

#### **(1) Antenna location selection**

Since ignition noise is generated by the vehicles engine, the antenna must be installed as far from the engine as possible.

#### **(2) Bonding**

The component parts of motor vehicles, such as the engine, transmission, muffler system, accelerator, etc., are coupled to one another at DC and low frequencies, but are isolated at high frequencies. By connecting these parts using heavy, braided ground straps, ignition noise can be reduced. This connection is called "bonding".

#### **(3) Use ignition suppressor cable or suppressor spark plugs**

Noise can be reduced by using spark plugs with internal resistors, or resistive suppressor ignition cable.

### **8-2-3. Battery Capacity**

The power system of a motor vehicle is comprised of a battery and an alternator (which generates power while the engine is running) to supply current to loads or to charge the battery.

Since the transceiver draws high current during transmit, care should be exercised so the power system is not overloaded. When using the transceiver, the following points should be observed from the viewpoint of battery maintenance:

1. Turn the transceiver OFF when the lights, heater, wipers and other high-draw accessories are used.
2. Avoid transceiver operation when the engine is not running.
3. If necessary, use an ammeter and/or a voltmeter to check battery condition.

### 8-3. RADIO FREQUENCY ALLOCATION

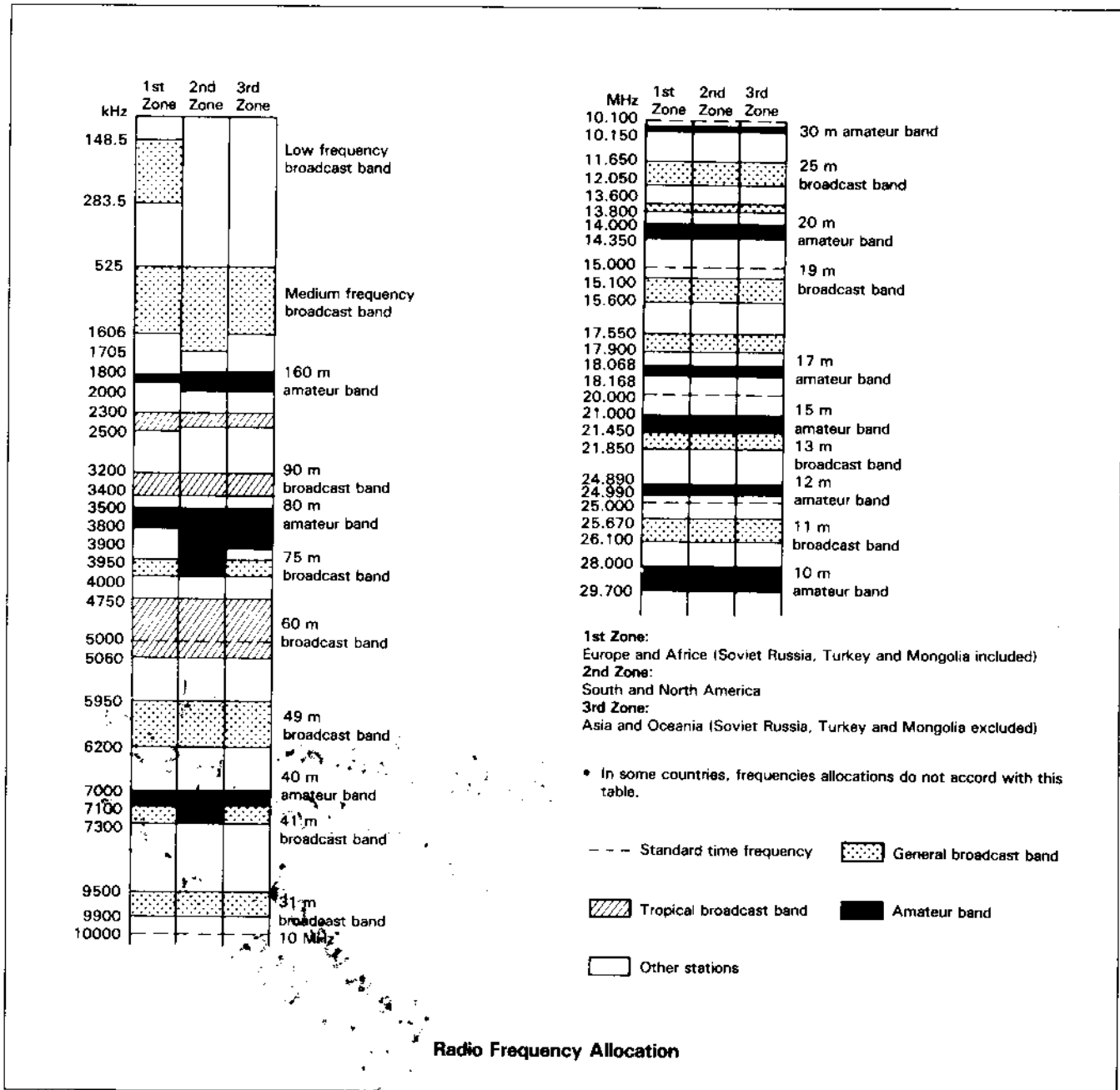

#### Frequency distribution in the broadcast and amateur bands

The general coverage receiver covers from 100 kHz to 30 MHz, to receive international broadcast and communication services.

As shown in the frequency allocation chart, above figure, broadcast and amateur radio station frequencies are allocated in specific bands expressed in megahertz (MHz) or wavelength in meters (m). Also in the above figure the frequencies of "other stations" are assigned for fixed station business use, marine mobile, aviation mobile, land mobile, radio beacon stations, etc.

#### Notes:

1. Radio stations throughout the world are listed in the WORLD RADIO TV HANDBOOK or similar publications.
2. Antennas designed for ham band operation will generally provide satisfactory reception for SW stations near the ham bands. For antenna construction details, see the ARRL ANTENNA HANDBOOK, or similar publications.

KENWOOD

Radio Center USA  
1-800-821-7323  
Kenwood  
1-40-639-9000