

KENWOOD

HF TRANSCEIVER

TS-530S

TS-44X

INSTRUCTION MANUAL

TRIO-KENWOOD CORPORATION

AFTER UNPACKING

It is advisable to save all original packing cartons (inner and outer) to protect your valuable transceiver from damage should you wish to transport it for remote operation or ship it for after-sales service.

The following explicit definitions apply in this manual. Be sure to read these definitions:

NOTE: If disregarded, inconvenience only — no damage or personal injury.

CAUTION: Equipment damage may occur, but not personal injury.

WARNING: Personal injury may occur — do not disregard.

CAUTION: _____
Read Operating Manual Section 4. before placing transmitter in service.

WARNING: _____
HIGH VOLTAGES PRESENT.

CONTENTS

SPECIFICATIONS	3
SECTION 1. INTRODUCTION AND FEATURES	4
SECTION 2. INSTALLATION	5
2.1. Unpacking	
2.2. Operating Location	
2.3. Cabling	
2.4. Microphone	
2.5. Key	
2.6. External Speaker and Headphones	
2.7. Ground	
2.8. Antenna	
SECTION 3. CONTROLS AND THEIR FUNCTIONS	8
3.1. Front Panel	
3.2. Rear Panel	
SECTION 4. OPERATION	14
4.1. Reception (I)	
(1) Basic Procedures for Receive Operation	
(2) WWV Reception	
4.2. Reception (II)	
(1) RF ATT Switch	
(2) RF Gain Control	
(3) AGC (Automatic Gain Control)	
(4) RIT/XIT	
(5) IF Shift	
(6) NARROW Switch	
(7) Noise Blanker (NB)	
4.3. Transmission (I)	
(1) SSB Operation	
4.4. Transmission (II)	
(1) Speech Processor	
(2) VOX (Voice Operated Transmit) Operation	
(3) XIT (Transmitter Incremental Tuning)	
(4) CW Operation	
4.5. Digital Display Calibration	
4.6. Analog Dial Calibration	
SECTION 5. OPTIONAL ACCESSORIES	22
5.1. Optional Accessories	
5.2. Installation of Accessories	
SECTION 6. MAINTENANCE AND ALIGNMENT ..	26
6.1. General	
6.2. Service Position	
6.3. Receiver Adjustments	
6.4. Transmitter Adjustments	
6.5. Transmitting on WARC BANDS	
6.6. Operation on 220V AC or 240V AC (USA)	
SECTION 7. TROUBLESHOOTING	28
BLOCK DIAGRAM	29
INTERNAL VIEW	30
SCHEMATIC DIAGRAM	31

TS-530S SPECIFICATIONS

[GENERAL]

Frequency Range	160 m Band 1.8 ~ 2.0 MHz 80 m Band 3.5 ~ 4.0 MHz 40 m Band 7.0 ~ 7.3 MHz 30 m Band 10.1 ~ 10.15 MHz (10.0 MHz WWV) 20 m Band 14.0 ~ 14.35 MHz * 17 m Band 18.068 ~ 18.168 MHz 15 m Band 21.0 ~ 21.45 MHz * 12 m Band 24.89 ~ 24.99 MHz 10 m Band 28.0 ~ 29.7 MHz
Modes	SSB/CW
Frequency Stability	Within 1 kHz during the first hour after 1 minute of warmup. Within 100Hz during any 30 minute period after warmup.
Power Requirement	120VAC/220VAC/240VAC, 50/60 Hz
Power Consumption	Transmit: 295 watts Receive: 27 watts (with heaters off)
Dimensions	333 (13.3) × 133 (5.3) × 333 (13.3) mm (inch)
Weight	12.8 kg (28.2 lbs)

[TRANSMITTER]

*Final Power Input	220W PEP for SSB operation 180W DC for CW operation
Audio Input Impedance	500Ω ~ 50 kΩ
RF Output Impedance	50Ω ~ 75Ω
Carrier Suppression	Better than 40 dB
Sideband Suppression	Better than 50 dB
Spurious Radiation	Better than 60 dB
Harmonic Radiation	Better than 40 dB
Audio Freq. Response	400 to 2,600 Hz, within -6 dB
ALC Input	-10V DC Max
Linear Amp Relay Contact Rating	100V DC 1A

[RECEIVER]

Receiver Sensitivity	0.25 μV at 10 dB S + N/N
Image Ratio	Better than 60 dB
IF Rejection	Better than 70 dB
Receiver Selectivity	
SSB/CW	2.4 kHz (-6 dB), 4.2 kHz (-60 dB)
CW Optional Filter	
YK-88C	500 Hz (-6 dB), 1.5 kHz (-60 dB)
YK-88CN	270 Hz (-6 dB), 1.1 kHz (-60 dB)
SSB Optional Filter	
YK-88SN	1.8 kHz (-6 dB), 3.3 kHz (-60 dB)
Audio Output Impedance	8 ~ 16Ω
Audio Output	1.5W (8Ω)

- * Will transmit on the 17, and 12 meter bands.
Diodes installed for preventing accidental transmission before government Amateur authorization.

NOTE: The circuit and ratings may change without notice due to developments in technology.

SECTION 1. INTRODUCTION AND FEATURES

1.1 KENWOOD TS-530S

The TS-530S is a highly sophisticated solid state Amateur band transceiver employing only three vacuum tubes.

Operating on all Amateur bands between 1.8 and 29.7 MHz, this unit is constructed modularly. The TS-530S includes many built-in features usually found as extras on other transceivers. Included are VOX, 25 kHz calibrator, RIT, RF attenuator, and an effective noise blanker. The TS-530S also includes automatic gain control (AGC), automatic level control (ALC), semi-break-in CW with sidetone, a speech processor, speaker and built-in AC power supply.

Designed for operation on SSB or CW, the TS-530S delivers more than 220 watts PEP input.

Any complicated electronic device will be damaged if operated incorrectly, and this transceiver is no exception. Please read all of the operating instructions before putting the TS-530S on the air.

1.2 FEATURES

1. Interference-free DX operation

* IF shift circuit

The IF SHIFT is a circuit to shift IF pass-bandwidth without changing receive frequency. It eliminates interference or adjusts receive frequency characteristic as desired.

*NARROW/WIDE BAND WIDTH selection and optional filters for enhanced operation. NARROW or WIDE CW operation can be selected when using one of two optional filters:

YK-88C (500 Hz) or YK-88CN (270 Hz)

NARROW or WIDE SSB operation can be selected when using the optional YK-88SN (1.8 kHz) filter.

2. WARC bands

The TS-530S fully covers the 160-10m Amateur bands, including the new WARC bands of 10, 18 and 24.5 MHz. The VFO covers at least 50 kHz above and below each 500 kHz band. The optional VFO-230 external digital VFO covers about 100 kHz above and below each band, for MARS and other applications.

3. All-in-one, compact AC Power supply.

4. Advanced circuit design for improved two-signal characteristics. Cleverly designed front-end circuit components and receive circuit system assure excellent two-signal characteristics. Cross-modulation and blocking are reduced.

5. TX final unit uses 6146B's

The finals are pair of 6146B transmitting tubes. Amplified ALC provide clear, strong signals with reduced cross modulation.

6. Variable level noise blanker

Conventional fixed level noise blankers are sometimes less than effective in removing pulsating noise over weak signals or rejecting strong interference signals. This variable level noise blanker is equipped to control the optimum threshold level of the gate pulse amplifier.

7. The speech processor controls the audio compression level and ALC time constant to increase the average audio level and transmit power.

8. XIT (Transmit Incremental Tuning) for fine adjustment of transmit frequency independent of receive frequency.

9. Built-in digital display

Accurate frequencies to the 100 Hz order, any band or mode.

10. The controls are arranged on the zinc die-cast front panel for easy operation.

11. A full variety of accessory circuits are provided:

The TS-530S includes:

VOX circuit (available for Semi-Break in), Marker circuit, side-tone oscillator, selectable AGC (OFF, FAST, SLOW), RF Attenuator, CW zero-beat circuit (in the Tune position), HEATER switch, SCREEN GRID switch, and Built-in speaker.

SECTION 2. INSTALLATION

2.1 UNPACKING

Remove the TS-530S from its shipping container and packing material and examine it for visible damage. If the equipment has been damaged in shipment, notify the transportation company immediately. Save the boxes and packing material for future shipping or moving.

The following accessories should be included with the transceiver.

1. Instruction Manual (B50-2791-00) 1
2. Plastic Extension Feet with Screws (J02-0049-14) 2
3. Speaker Plug 1/8" (E12-0001-05) 1
4. 7P DIN Plug (E07-0751-05) 1
5. Fuse (6A) (F05-6021-05) (U.S.A.) 1
(4A) (F05-4022-05) (Europe) 1

2.2 OPERATING LOCATION

As with any solid state electronic equipment, the TS-530S should be kept from extremes of heat and humidity. Choose an operating location that is dry and cool, and avoid operating the transceiver in direct sunlight. Also, allow at least 3 inches clearance between the back of the equipment to any object. This space allows an adequate air flow from the ventilating fan to keep the transceiver cool.

CAUTION:

Do not operate the radio in an RF Field greater than 6V RF. Receiver damage may occur.

2.3 CABLING (See Figure 2-1.)

■ GROUND

To prevent electric shock, and reduce the possibility of TVI and BCI, connect the transceiver to a good earth ground through as short and heavy lead as possible. Use ground rods or metal cold water feedline.

NOTE:

A ground connection greater than $1/4 \lambda$ away from the transceiver may be a good DC ground, but NOT an RF ground.

■ ANTENNA

Connect through a 50 ohm antenna feedline to the coaxial connector on the rear panel.

■ KEY

If CW operation is desired, connect a key to the KEY jack. Use shielded line or coaxial cable.

■ POWER CONNECTIONS

Make sure the POWER switch on the front panel is turned off, the stand-by switch is in the REC position, and the line voltage is correct. Then connect the POWER cord to the line source.

■ AC POWER

For fixed station operation, the TS-530S operates from 120V AC (U.S.A.) or 220V AC/250V AC (Europe), 50/60 Hz power source capable of supplying 280 watts or more.

● 120V AC line model (U.S.A.)

A 6A fuse is used.

If you desire operation on 220V AC or 240V AC, it is necessary to change the power transformer connections and the fuse.

See page 27.

● 220/240V AC line model (Europe)

This destination type is equipped with a voltage selector switch on the rear panel.

A 4A fuse should be used.

Set the switch to your line voltage and use the correct fuse.

NOTE:

The 220/240V AC model is preset to 220V.

2.4 MICROPHONE

Attach the microphone connector to a suitable microphone, as shown in Figure 2-1. Be sure the microphone PTT switch is separate from the microphone circuit, as shown. It should be noted that a microphone with a 3P plug using a common ground terminal should not be used.

The microphone input is designed for $500\Omega \sim 50k\Omega$ microphones. The choice of microphone is important for good speech quality, and should be given serious consideration. The crystal lattice filter in the transceiver provides all the restriction necessary on audio response, and further restriction in the microphone is not required. It is more important to have a microphone with a smooth, flat response throughout the speech range.

Follow the microphone manufacturer's instructions for connecting the microphone cable to the plug. With many microphones, the push-to-talk button must be pressed to make microphone audio available. For VOX operation, this unwanted feature may be eliminated, if desired, by opening the microphone case and permanently connecting the contacts which control the microphone audio.

Headphones

Use headphones of 4 to 16Ω impedance. The optional HS-4, HS-5 headphones best suited for use with the TS-530S. Stereo-type stet phones can also be used.

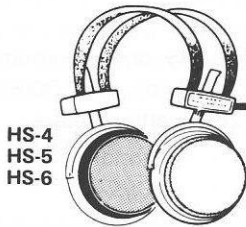

HS-4
HS-5
HS-6

Microphone

Either a low or high impedance microphone (500Ω to 50 kΩ) can be used. The P.T.T. switch should be isolated from the mic circuit (shown in "A"). Use a microphone with a separate switch and MIC line so both P.T.T. and VOX are available.

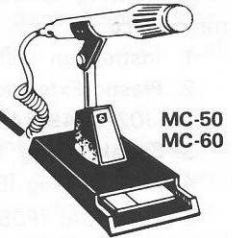

MC-50
MC-60

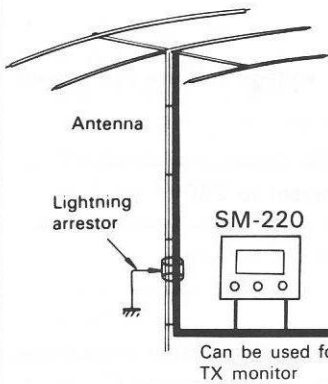
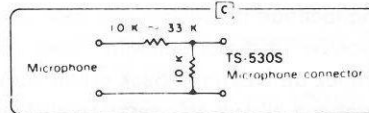
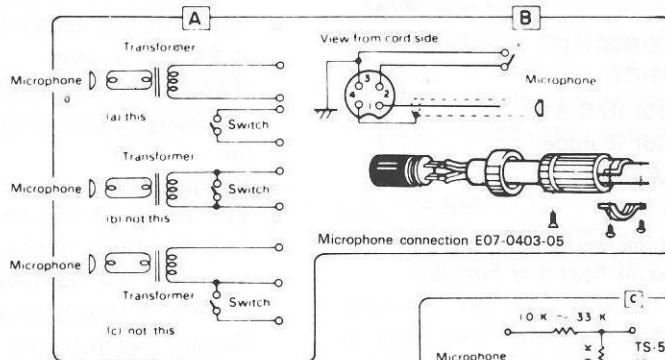
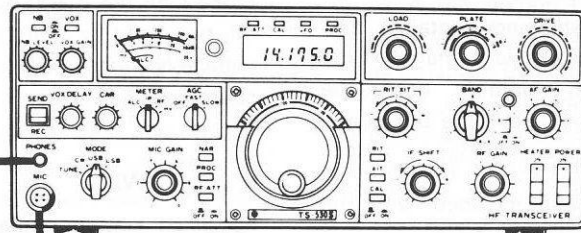

Antenna

Lightning arrester

SM-220

Can be used for TX monitor

Key
For CW operation, connect your key to the KEY jack at the rear. Use shielded cable.

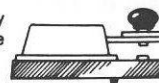

External speaker

Besides the built-in speaker, an external speaker can also be used. Connect to the rear EXT SP jack using the supplied plug.

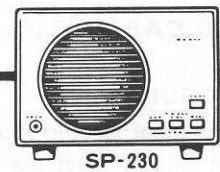

SP-230

GND terminal

It is recommended that a ground lead be connected to the GND terminal at the rear of the set to prevent the possibility of electric shock, TVI and BCI. Use as short and heavy a lead as possible.

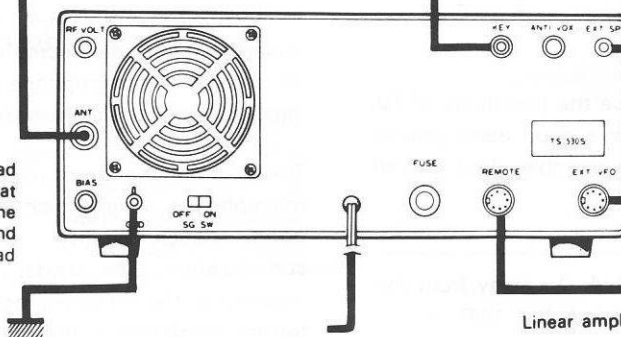

Linear amplifier

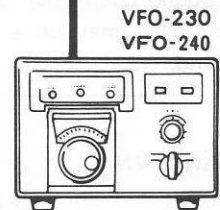

VFO-230
VFO-240

External VFO

AC line source
See page 5, AC POWER

Fig. 2-1 TS-530S Connections

Standard microphone sensitivity is within the range of -50 dB to -60 dB. If a microphone having a higher sensitivity is used, the ALC and compressor circuits will not function properly. In this case, insert in the mike line an attenuator as shown in Fig. 2-1c. A typical MIC gain control setting is 12 o'clock. If you must run this control at 9 o'clock or less, use an attenuator.

2.5 KEY

If CW operation is desired, connect a key to the KEY jack. Use shielded cable, and a standard (mono or 2P) phone plug.

2.6 EXTERNAL SPEAKER AND HEADPHONES

Receive audio output from the TS-530S is 1.5 watts at 4 to 16 ohms. The TS-530S has a built-in SPEAKER jack on the rear panel. The speaker may be an 8-ohm permanent-magnet type, 4 inches or larger. The internal speaker is disconnected when an external speaker is used. Headphones should also be 4 to 16 ohms impedance. When headphones are connected to the front-panel PHONES jack, the speaker is disabled.

2.7 GROUND

To prevent electric shock, and reduce the possibility of TVI and BCI, connect the transceiver to a good earth ground through as short and heavy a lead as possible.

2.8 ANTENNA

Any of the common antenna systems designed for use on the high frequency amateur bands may be used with the TS-530S, provided the input impedance of the transmission line is not outside the capability of the pi-output matching network. The transmission line should be coaxial cable. An antenna system which shows a standing wave ratio of less than 2:1 when using 50 or 75 ohm coaxial transmission line, or a system that results in a transmission line input impedance that is essentially resistive, and between 15 and 200 ohms will take power from the transceiver with little difficulty. If openwire or balanced type transmission line is used with the antenna, a suitable antenna tuner with balun is recommended between the transceiver and the feed line. Methods of construction and operating such tuners are described in detail in the ARRL Antenna Handbook, and similar publications. For operation on the 160, 75 and 40 meter bands, a simple dipole antenna, cut to resonance in the most used portion of the bands, will perform satisfactorily. For operation of the transceiver on the 10, 15 and 20 meter bands, the efficiency of the station will be greatly increased if a good directional rotary antenna is used. Remember that even the most powerful transceiver is useless without a proper antenna.

CAUTION: _____
Protect your Equipment — Use a LIGHTING ARRESTOR.

SECTION 3. CONTROLS AND THEIR FUCTIONS

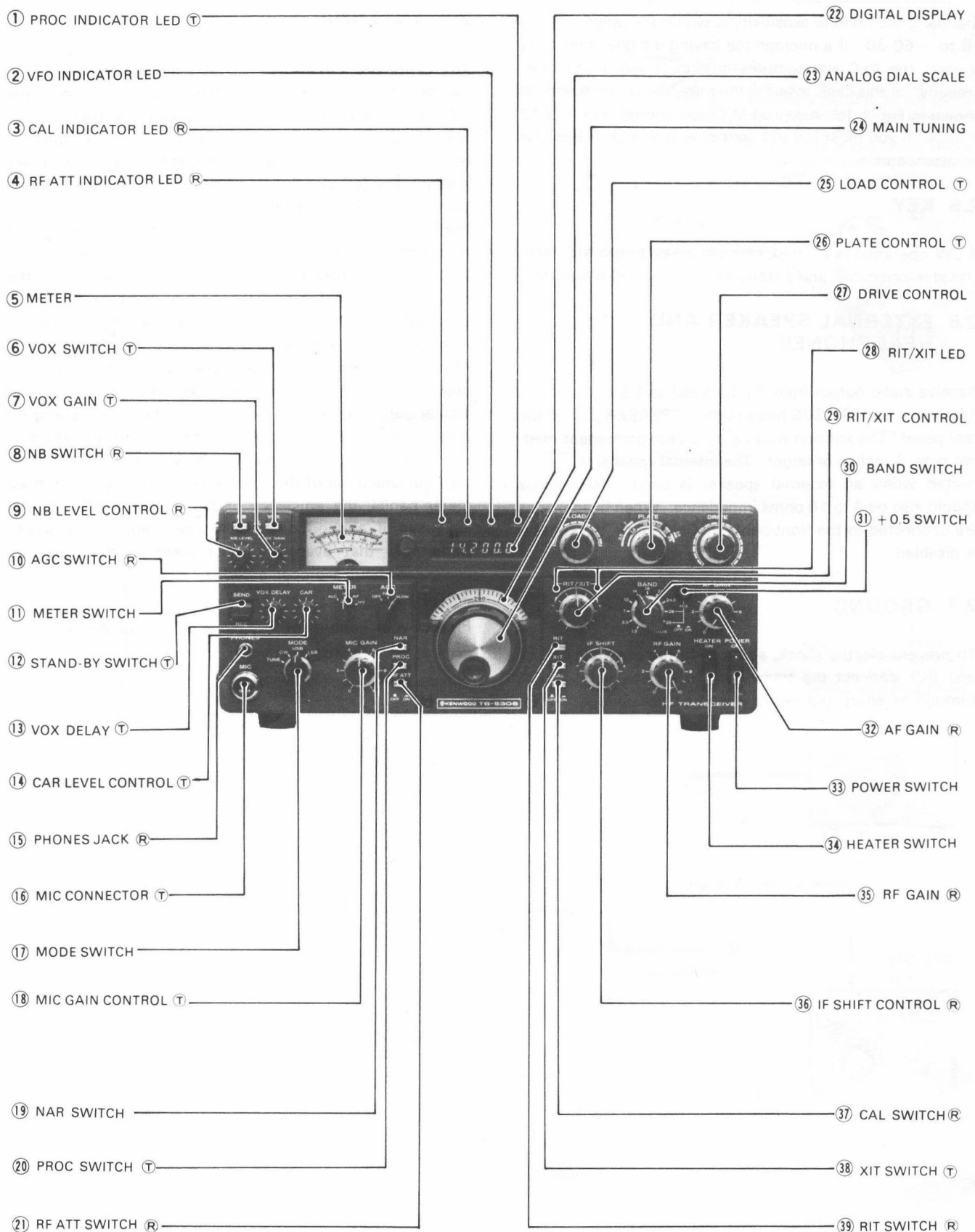

Fig. 3-1 Front Panel View

3.1 FRONT PANEL

The symbol after the part name indicates:

- Ⓡ: Active only during reception.
- Ⓣ: Active only during transmission
- No symbol: Always active

1. PROC (SPEECH PROCESSOR) INDICATOR Ⓣ

This indicator, (light emitting diode), illuminates when the PROC switch is turned ON.

2. VFO INDICATOR

The VFO indicator illuminates when the internal VFO controls transceiver operation. The indicator is not lighted during fixed channel or remote VFO operation.

3. CAL INDICATOR Ⓡ

The CAL indicator illuminates when the CAL switch is turned ON.

4. RF ATT INDICATOR Ⓡ

This illuminates when the RF ATT is turned ON.

5. METER

The meter monitors five different functions, depending on METER switch position. In receive the meter is automatically an S-meter, and shows received signal strength on a scale of 0 to 40 dB over S9. In transmit, meter function depends on the position of the METER switch, as described below. This is an average-responding meter, NOT peak-reading.

6. VOX SWITCH (T)

The VOX circuit is readied for voice operated transmit in SSB or semi-break-in CW.

7. VOX GAIN (T)

This controls sensitivity of the VOX (Voice Operated Transmit) circuit.

8. NB SWITCH Ⓡ

With the push switch IN, the noise blanker circuit turned ON reducing pulse-type (ignition) noise. Power-line, radar, QRM and atmospheric "white" noises will not operate the blanker. The noise blanker circuit operating level is adjustable by the noise blanker control.

9. NB LEVEL CONTROL Ⓡ

This control adjusts the noise blanker circuit operating level according to receiving conditions or noise level.

10. AGC SWITCH Ⓡ

This controls the AGC (Automatic Gain Control) circuit:
OFF..... AGC disabled (no AGC).
FAST..... Normally used for CW operation.
SLOW Normally used for SSB operation.

11. METER SWITCH

This determines the transmit meter function:

ALC (Automatic Level Control)

Monitors internal ALC voltage, or the ALC voltage feedback from a linear amplifier operated in conjunction with the TS-530S. For SSB operation the ALC reading for voice peaks should be within the indicated ALC range. ALC voltage adjustment is made with the MIC control for SSB and with the CAR control for CW.

IP (Plate Current)

In this position the meter monitors final tube plate current. The scale is calibrated from 0 to 350 ma.

RF (Output Power)

This monitors relative output power of the transceiver. There is no meter scale for this position. Normally the reading should be adjusted (with the RF METER control) for a 2/3 scale reading.

HV (High Voltage)

This position monitors the high voltage power supply. The meter scale is calibrated from 0 to 10, indicating 0 to 1000 volts.

12. STAND-BY SWITCH Ⓣ

This two-position lever switch selects:

REC The transceiver is receiving unless the microphone PTT switch, or the VOX circuit is activated.

SEND Locks the unit in transmit.

13. VOX DELAY CONTROL (T)

The DELAY control adjusts the hold time for VOX or break-in CW operation. Adjust for individual preference.

14. CAR LEVEL CONTROL (T)

This controls carrier level during CW operation. Adjust the CAR level so that the ALC meter points to the center of the ALC zone. The ALC meter should not read beyond the ALC zone.

15. PHONES JACK [®]

The headphones jack allows use of a 4 to 16 ohm headphone through a 1/4" phone plug. When phones are used the speaker is disconnected.

16. MIC CONNECTOR [Ⓟ]

The four pin connector allows use of a microphone with PTT. Figure 2-1B shows plug wiring.

17. MODE SWITCH

The mode switch selects type of emission, and TUNE. TUNE This position provides reduced carrier and shorted key line for transceiver tuning. (Input power to the final section is reduced to prevent tube damage during tune-up.) Use this position to zero-beat an incoming CW signal.

CW Used for CW operation.

USB Used for upper-sideband operation. International Amateur practice dictates the use of USB on and above the 10 MHz band.

LSB Selects lower-sideband. International Amateur practice dictates the use of LSB on and below the 7 MHz band.

18. MIC GAIN CONTROL [Ⓟ]

This control adjusts microphone amplifier gain for SSB operation. Adjust for an on-scale ALC reading on voice peaks.

19. NAR SWITCH (R)

With optional filters installed, the IF bandwidth can be selected by the Narrow Switch. The bandwidth varies with filters being used. For details, refer to Narrow Switch on page 16.

20. PROC (SPEECH PROCESSOR) SWITCH (T)

This switch is used during SSB operation. Set the switch to the ON position and the speech processor will be activated, increasing the average talk power.

21. RF ATT SWITCH (R)

With this switch ON, A 20 dB attenuator is inserted in the antenna circuit, protecting the RF amplifier and mixer from overload on strong input signals.

22. DIGITAL DISPLAY

The digital display indicates operating frequency to the nearest 100 Hz.

23. ANALOG DIAL SCALE

The mono-scale permits direct analog frequency readout over the 0 to 500 kHz range, graduated at 1-kHz intervals. Operating frequency equals the dial (in kHz) plus the BAND switch frequency (in MHz). An additional 50 kHz both above and below the 500 kHz range is also covered.

24. MAIN TUNING

This controls the VFO, selecting the transceiver's operating frequency. The indented knob is convenient for quick tuning.

25. LOAD CONTROL (T)

This controls the loading of the network between the final section and the antenna. Adjustment is described in Section 4.

26. PLATE CONTROL (T)

This controls the plate tuning of the final amplifiers. Calibration is approximate.

27. DRIVE CONTROL

This control tunes the plate tank circuit of the 12BY7A driver as well as the receiver's antenna and mixer coils. In receive the DRIVE control is tuned for maximum sensitivity (maximum S-meter deflection), and in transmit for a maximum ON-SCALE ALC reading. These points occur concurrently. Tuning for one also achieves the other.

28. RIT/XIT INDICATOR

This indicator will light when the RIT switch or XIT switch is ON.

29. RIT/XIT CONTROL

This control allows the receive frequency, transmit frequency or both to be shifted without using the main tuning control. With the RIT switch ON, the RIT circuit is activated to shift only the receive frequency.

With the XIT switch ON, the XIT circuit is activated to shift only the transmit frequency.

When both switches are ON, both frequencies are shifted. The center (O) position equals no shift.

30. BAND SWITCH

The 10-position switch selects all Amateur bands from 1.8 to 29.7 MHz. To select the 28.5 or 29.5 MHz bands, push the +0.5 switch ON.

Use the 10 MHz band for WWV reception.

An AUX receive band is also available.

Coilpack (Receiver front-end) and PLL components must be installed and aligned for the specific receive frequency range desired.

31. +0.5 SWITCH

This switch is used in conjunction with the bandswitch. Depress the switch with the bandswitch set to "28", and the transceiver will operate in the 28.5 MHz band. When the bandswitch is set to "29", the transceiver will operate in the 29.5 MHz band. This switch has no function at any other bandswitch position.

32. AF GAIN (R)

This adjusts receiver audio level. Volume increases clockwise.

33. POWER SWITCH

This switches all power to the transceiver.

34. HEATER SWITCH

This switch turns the three transmitting tube filaments ON.

35. RF GAIN (R)

This adjusts receiver RF amplifier gain. Turn fully clockwise for maximum gain and a correct S-meter reading.

36. IF SHIFT CONTROL (R)

During reception, the center frequency of the IF crystal filter can be shifted ± 1.2 kHz facilitating adjustment of tone quality, or eliminating interference from nearby frequencies. For normal operation, set to the center detent position (click stop).

37. CAL SWITCH (R)

This switch energizes the built-in marker circuit. Receive frequency can be calibrated at 25 kHz intervals using this oscillator.

38. XIT SWITCH (T)

This push switch activates the XIT (Transmit Incremental Tuning) circuit and the XIT indicator. By adjusting the XIT control, the VFO transmit frequency can be varied ± 2 kHz without changing the receive frequency.

39. RIT SWITCH (R)

This push switch activates the RIT (Receiver Incremental Tuning) circuit, and the RIT indicator. By adjusting the RIT control, the VFO receive frequency can be varied ± 2 kHz, without changing the transmit frequency.

If, both switches are ON, both the transmit and receive frequencies will shift simultaneously.

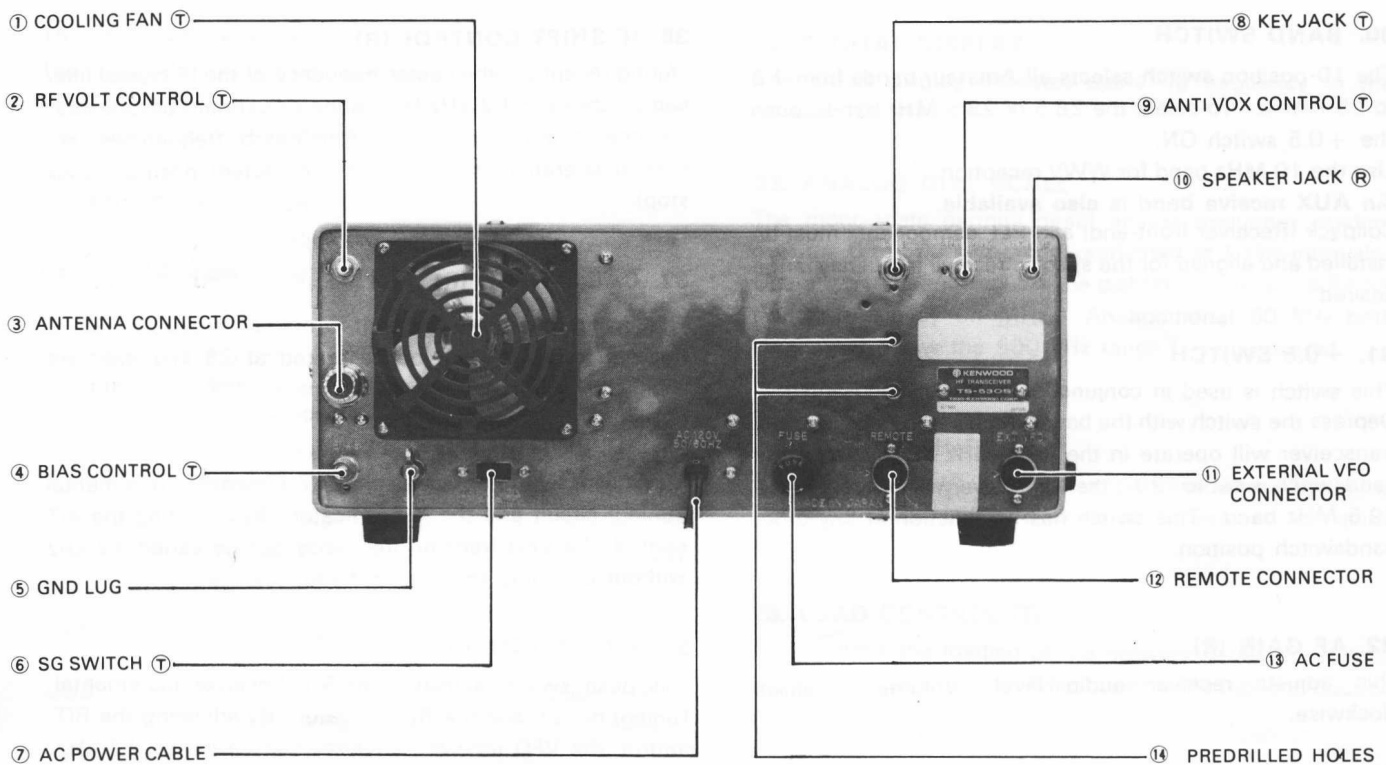

Fig. 3-2 Rear Panel View

3.2 REAR PANEL

1. COOLING FAN (T)

This fan cools the RF amplifier section to insure reliable and efficient operation.

2. RF METER CONTROL (T)

This adjusts the RF output meter reading. Set for 2/3 scale reading during CW transmission.

3. ANTENNA CONNECTOR

This SO-239 coax connector should be attached to a suitable 50Ω antenna for transmitting and receiving.

4. BIAS CONTROL (T)

This adjusts the bias voltage to the 6146B amplifier tubes. Clockwise rotation increases the idling plate current. Section 4 describes adjustment to 60 ma.

5. GND (GROUND) LUG

To prevent electric shock, as well as RFI and BCI, connect the transceiver to a good earth ground.

6. SG SWITCH (T)

This slide switch controls the screen grid voltage to the final tubes. For neutralizing, switch OFF. The switch remains ON for normal operation.

7. AC POWER CABLE

This cable is used to connect an AC power source to the transceiver.

8. KEY JACK (T)

Using shielded line, connect a key to this 1/4" phone jack for CW operation. Key open-terminal voltage is approximately -65V.

9. ANTI VOX CONTROL $\text{\textcircled{T}}$

Adjust the control to prevent speaker output from tripping the VOX.

10. SPEAKER JACK $\text{\textcircled{R}}$

The receiver audio output can be connected through this jack to an external 4 to 16 ohm speaker. The internal speaker is disconnected when an external speaker is connected.

11. EXTERNAL VFO CONNECTOR

This DIN connector is used to interface the KENWOOD VFO-240 external VFO. The interconnecting cable is provided with the VFO.

PIN	FUNCTION	PIN	FUNCTION
1	VFO signal	5	VFO control
2	Relay control (+ on transmit)	6	Display control
3	+9V	7	Ground
4	CW freq. shift control	8	+12V

12. REMOTE CONNECTOR

This connector is used to interconnect a linear amplifier or other accessory item. See page 24 for detail.

13. AC FUSE

This fuse protects the transmitter power supply against short circuits. Never use a higher amperage fuse than specified; it will eventually cause extensive damage. If the fuse blows, try to determine the cause before replacing.

For 120 volt operation use a 6 ampere fuse and for 220/240 volt operation, a 4 ampere fuse.

14. PREDRILLED HOLES

These are provided for owner-installed switches or connectors.

* VOLTAGE SELECTOR SWITCH

The 220/240 VAC line model (in Europe) is equipped with a voltage selector switch on the rear panel.

Set this switch to suit your line voltage, if necessary.

SECTION 4. OPERATION

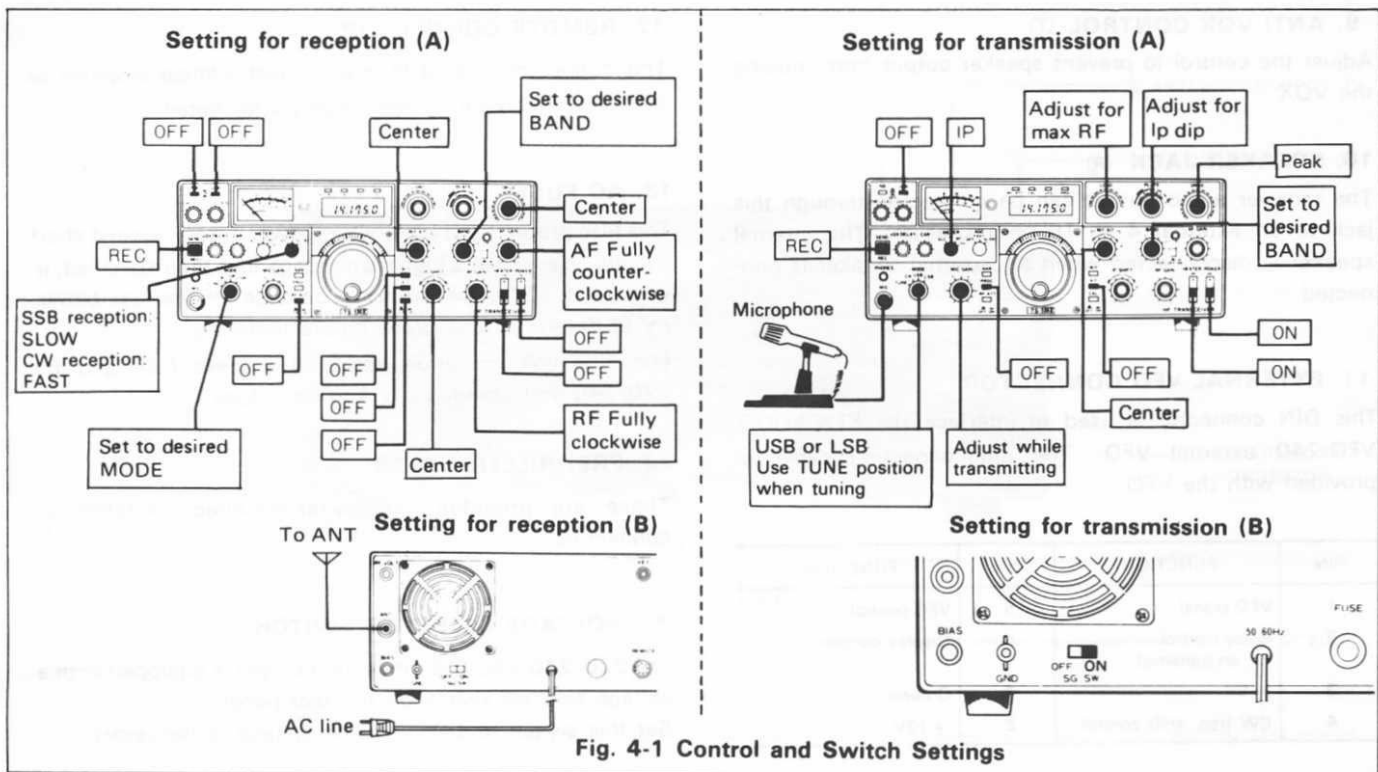

Fig. 4-1 Control and Switch Settings

4.1 RECEPTION (I)

NOTE:

Set the MIC and CAR controls to minimum to prevent accidental transmission before tune-up is completed. The TS-530S must be operated into 50 ohm ~ 75 ohm antenna or dummy load with an SWR less than 2 : 1. Random length wire antennas or light-bulb dummy loads cannot be used.

Conventional half-wave dipoles and beam antennas should only be used at or near their resonant frequency. Exceeding an SWR of 2:1 can damage the output stage of the transceiver.

(1) Basic Procedures for Receive Operation

With a suitable antenna and microphone or key connected to the transceiver, set the controls as shown in Fig. 4-1.

Turn the POWER switch ON. The meter, dial scale, and VFO indicator will light, indicating the transceiver is operating. Advance the AF GAIN control clockwise until some receiver noise is heard in the speaker. Turn the main tuning dial within the frequency range of the Amateur band chosen until a signal is heard. Tune the signal for clearest reception, and then adjust the DRIVE control for maximum S-meter deflection. (Fig. 4-2)

(2) WWV Reception

Set the band switch to "10" and turn the main tuning control to 10.0 MHz.

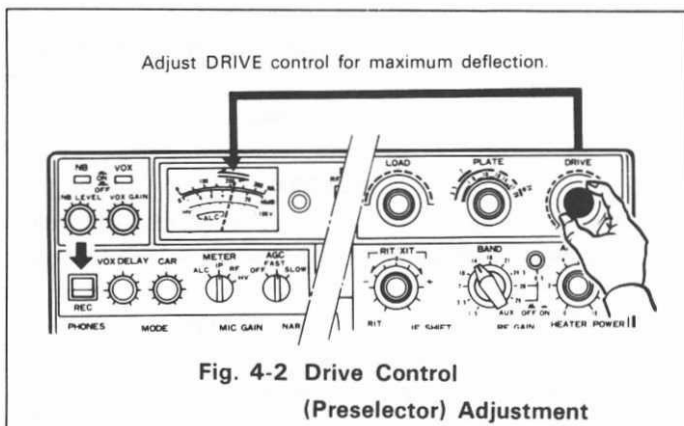

Fig. 4-2 Drive Control (Preselector) Adjustment

4.2 RECEPTION (II)

This section covers operation of controls and switches to provide maximum performance from the TS-530S.

(1) RF ATT SWITCH

The input to the receive RF amplifier is attenuated approximately 20 dB, providing distortion-free reception. This feature may be used in cases of receiver overload, caused either by a strong local signal, or during weak signal reception when a strong adjacent signal may blank the receiver or pump the noise blanker.

(2) RF GAIN CONTROL

RF GAIN is controlled by changing the AGC threshold voltage. Adjust the RF GAIN so the S-meter does not deflect excessively. This also reduces noise during reception. For normal operation, this control should be turned fully clockwise for maximum sensitivity.

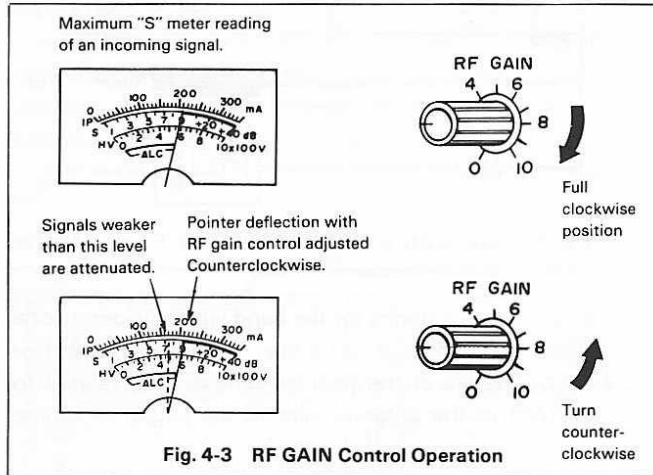

(3) AGC (AUTOMATIC GAIN CONTROL)

Set the AGC switch to the appropriate position: Generally for SSB, SLOW, for CW FAST, and for very weak signals, the AGC may be turned OFF.

Simultaneous Use of the RF GAIN CONTROL and AGC Switch

If a strong signal (such as a local station) appears in the vicinity of the intended receive signal, the S meter may show unusual deflection due to the AGC voltage developed from the strong disturbing signal. If this occurs, turn the RF GAIN down so the meter pointer remains at about the original deflection peak and turn the AGC switch OFF. This will eliminate the unwanted AGC voltage and permit clear reception.

(4) RIT/XIT

First set the RIT/XIT control to center, and turn the RIT switch ON.

The RIT/XIT control allows shifting the receive frequency by approximately ± 2 kHz without changing the transmit frequency.

With the RIT switch ON, the receive frequency can be adjusted by using the RIT control.

With both the RIT and XIT switches ON, both the transmit and receive frequencies can be shifted.

For XIT switch operation, refer to Section 4.4 "Transmission (II)".

NOTE:

When the RIT is ON, transmit frequency is different from the receive frequency. For normal operation, leave the RIT switch OFF. It should be turned ON only when needed.

(5) IF SHIFT

The IF SHIFT control is used to shift the passband of the IF filter without changing receive frequency. By turning this control in either direction, the IF passband is shifted as shown in Fig. 4-3.

The IF SHIFT is effective in eliminating interference when the receive signal is superimposed on nearby signals during operation in both SSB or CW mode.

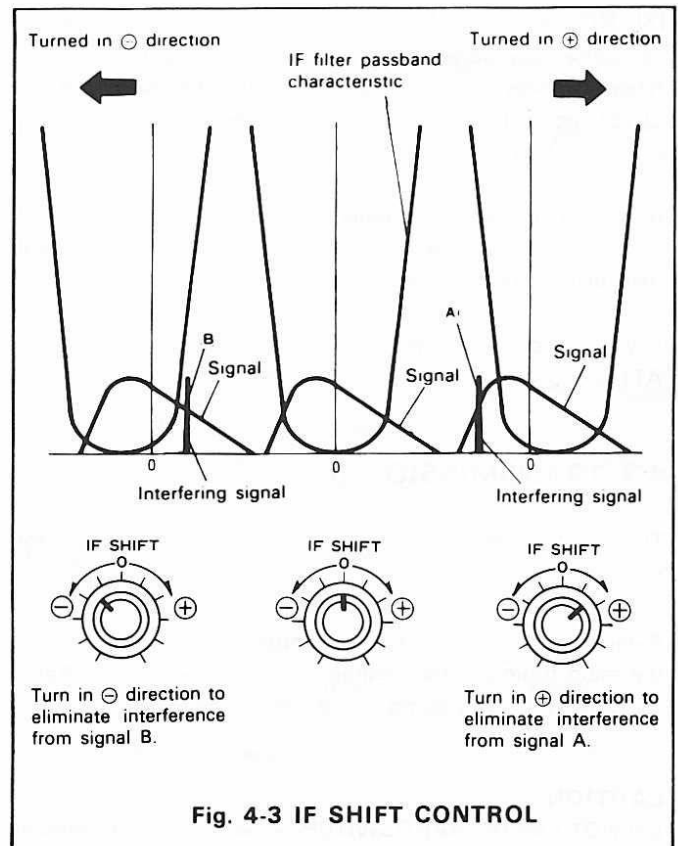

(a) USB MODE (10 MHz and above)

Adjust the IF SHIFT control in the (+) direction and lower frequencies are cut. Adjust the control in the (-) direction and high frequencies are cut.

(b) LSB MODE (7 MHz and below)

Adjust the control in the (+) direction and higher frequencies are cut. Adjust the control in the (-) direction and low frequencies are cut.

(c) CW MODE

By using the IF SHIFT in conjunction with the RIT, tone quality can be adjusted.

(6) NARROW SWITCH

In the NARROW position without optional filters no signals are received. Optional filters (CW: YK-88C, YK-88CN, SSB: YK-88SN) for NARROW operation are available for improved radio interference rejection. Any two filters can be used according to your application. When two CW filters, YK-88C and YK-88CN are used, the WIDE position in CW mode is 0.5 kHz.

(7) NOISE BLANKER (NB)

For pulse type noise, such as generated by automotive ignition systems, turn the NB switch ON. Adjusting the NB LEVEL control varies the blanker's threshold, eliminating even low level noises.

If high level signal or noise is present on an adjacent frequency, do not use excessive NB threshold LEVEL as it may distort the received signal.

If you are operating near other strong signals, use the RF ATT along with the noise blanker level control.

4.3 TRANSMISSION (I)

This section covers adjustment of the transceiver for transmission.

Refer to Fig. 4-1 for initial transmitter switch settings. Set the main tuning to the desired operating frequency. (Refer to Table 4-1 for a summary of the following.)

CAUTION: _____
DO NOT turn the BANDSWITCH while the transceiver is in transmit mode.

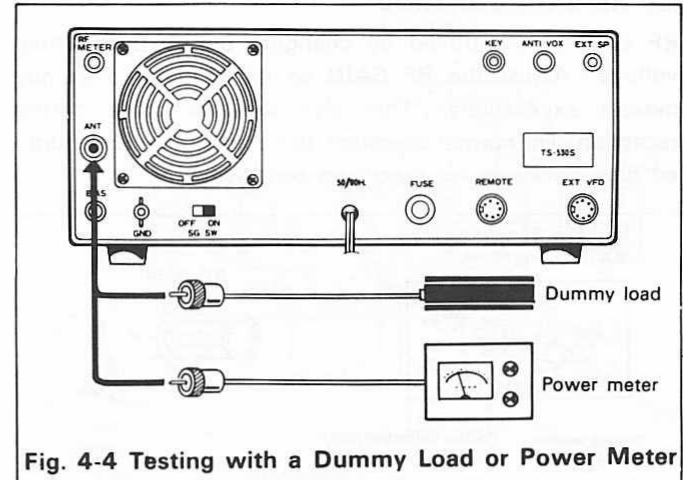

Fig. 4-4 Testing with a Dummy Load or Power Meter

1. Connect a 50Ω antenna for the band you will operate or a dummy load, and connect a key. SWR must be 2:1 or better. The life of the final tubes is directly related to the SWR of the antenna, and to the length of tuning periods.
2. Turn POWER and HEATER Switches ON.
3. Place the MODE switch to SSB, METER switch to Ip.
4. Place the STAND-BY switch to SEND and adjust bias to 60 mA with the BIAS control on the rear panel, Fig. 4-5.

CAUTION: _____
If the plate current is higher than 60 mA do not leave the stand-by switch on for more than a few seconds. Excessive plate current shortens the life of the final tubes.

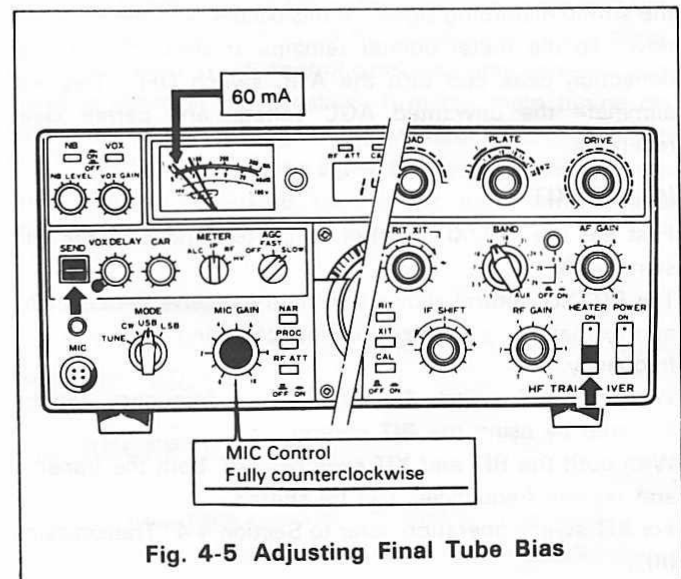

Fig. 4-5 Adjusting Final Tube Bias

- Place MODE switch to TUNE, METER switch to ALC. Peak the DRIVE control. If the meter pegs or goes out of the ALC range, reduce the CARRIER control setting for an on-scale reading. (the CAR control is a level adjustment, while the drive control is a resonating adjustment.) Fig. 4-6

NOTE:

The TUNE position permits tuning of the final tank circuit at reduced power without danger to the tubes. In the TUNE position, the screen voltage to the finals is reduced approximately 50% and the keying circuit is closed.

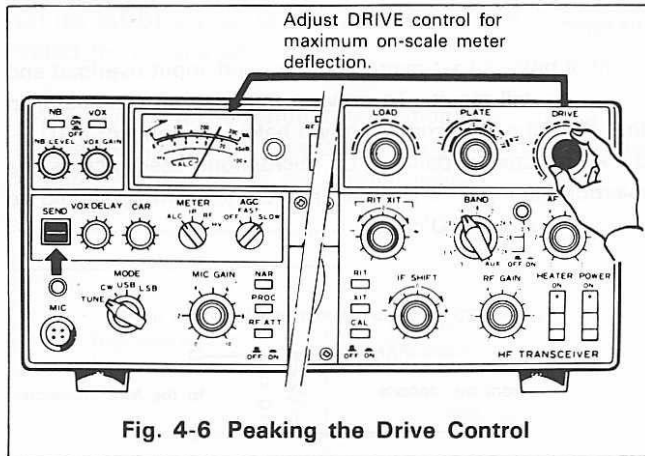

Fig. 4-6 Peaking the Drive Control

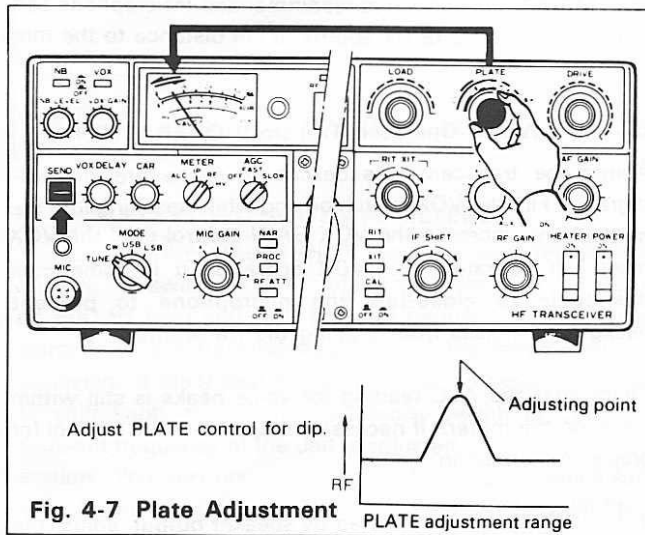

Fig. 4-7 Plate Adjustment

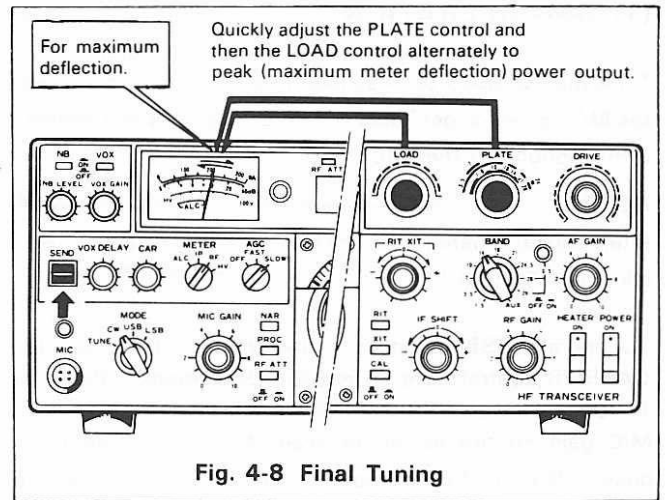

Fig. 4-8 Final Tuning

- Place the meter switch to Ip and dip the PLATE. Dip will be typically only about 5 ma. (or to RF and peak the Plate) Fig. 4-7
- Place the meter switch to RF and peak the LOAD control.
- Place the Mode switch to CW, Meter switch to Ip. Close the key and IMMEDIATELY redip the PLATE control. Reduce the carrier control setting if Ip reads over 265ma. Open the key.
- Place the meter switch to RF. Close the key and repeat the LOAD for maximum RF output. You may at your option also redip the PLATE for maximum RF output. Fig. 4-8 Open the key. You are tuned up for CW operation. If necessary, adjust the RF METER control on the rear panel to bring the output reading to about 2/3 scale. This is a meter adjustment, not an output adjustment.

NOTE:

Dip point may not always coincide with maximum output, because neutralization is accomplished on the 10 meter band.

For this reason, you may simply adjust both the PLATE and the LOAD controls for maximum output as described in both tune-up procedure and summary Table 4-1.

Table 4-1. Summary of Transmitter Tuning Procedure

MODE Switch	METER Switch	Stand-by Switch	Procedure
USB or LSB	IP	REC → SEND	Adjust BIAS control for 60 ma.
TUNE	ALC	REC → SEND	Peak the RF reading with the PLATE and LOAD controls.
TUNE	RF	REC → SEND	Peak RF output by alternately adjusting the PLATE and LOAD controls.
CW	RF	REC → SEND	

(1) SSB OPERATION

Tune the TS-530S as described in steps 1 through 9. Set the MODE switch per Table 4-2, to USB or LSB and connect a microphone to the MIC input.

NOTE: International Amateur practice dictates using USB or LSB as shown in Table 4-2.

To operate SSB, connect a microphone. (The Key and CARRIER control have no effect in SSB mode.) Place the MODE switch to SSB, METER switch to ALC. Adjust the MIC gain control for an on-scale ALC reading on voice peaks. (Disregard RF and Ip meter readings in SSB—they are not accurate or relevant.)

1.8 MHz Band	LSB
3.5 MHz Band	LSB
7 MHz Band	LSB
10 MHz Band	USB
14 MHz Band	USB
18 MHz Band	USB
21 MHz Band	USB
24.5 MHz Band	USB
28 MHz Band	USB

TABLE 4-2 Mode By Band

■ PTT (Push to talk) OPERATION

By using a microphone equipped with a PTT switch, the transceiver is ready for PTT operation. To key, depress the PTT switch with the stand-by switch left in the REC position.

- NOTE:**
1. Transmission is impossible with the BAND switch set to AUX, 18 or 24.5.
 2. Do not transmit when the BAND switch is set to AUX or is midway between AUX and 1.5. Doing so will damage the 12BY7A driver tube.

4.4 TRANSMISSION (II)

To obtain maximum transmitter performance from your TS-530S you should understand the proper operation of the following controls and switches.

(1) SPEECH PROCESSOR

In DX (long distance) operation, it may be desirable to increase talk-power by using the speech processor. The speech processor in the TS-530S combines an audio compression amplifier with changes in ALC time constant to provide extra audio punch and to increase average SSB output power, while suppressing sideband splatter. To activate, turn on the PROC switch, and readjust mic gain. Operated as described, distortion will be minimum. However, tone quality will be affected. It is therefore advisable to conduct normal operation with the processor disabled.

When a high-output microphone is used, input overload and distortion will result. To prevent this, use an attenuator in the microphone circuit as shown below, or connect a 10 — 33 kΩ resistor (depending on microphone used) across the microphone input. ("Normal" mic control setting should be approximately 12 O'clock).

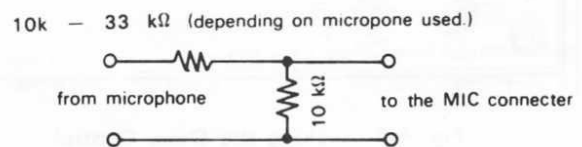

The MC-50 microphone is recommended (Microphone sensitivity: -55 ± 3 dB for approx. 5 cm distance to the mic.)

(2) VOX (Voice Operated Transmit) OPERATION

Adjust the transceiver as described in the previous paragraph. Flip the VOX switch on and while speaking into the microphone, increase the VOX GAIN control until the VOX relay just operates. For VOX operation it is sometimes desirable to close-talk the microphone to prevent background noises from tripping the transmitter.

Check that the ALC reading for voice peaks is still within range on the meter. If necessary, adjust the MIC control for proper ALC reading.

If the VOX circuit is activated by speaker output, adjust the ANTI-VOX control (on the rear panel) as necessary for proper VOX operation.

Do not use excessive VOX or ANTI VOX gain more than necessary to control VOX operation. If the VOX circuit transfers between words, or holds too long, adjust the release time constant by the DELAY control.

(3) XIT

By using XIT, transmit frequency can be shifted independent of receive frequency.

With the XIT switch ON, the XIT is controlled by the RIT/XIT knob and transmit frequency can be shifted by about ± 2 kHz. When both the RIT and XIT switches are ON, both receive and transmit are shifted without adjusting the main tuning.

(4) CW OPERATION (Fig. 4-9)

Tune and load the TS-530S as described in Sections 4.3. Using shielded line, connect a key to the rear panel KEY jack, set the MODE switch to CW, and set the stand-by switch to SEND for transmitting.

CW transmission is automatically monitored through the transceiver's speaker. Sidetone audio gain can be adjusted through the opening in the bottom cover.

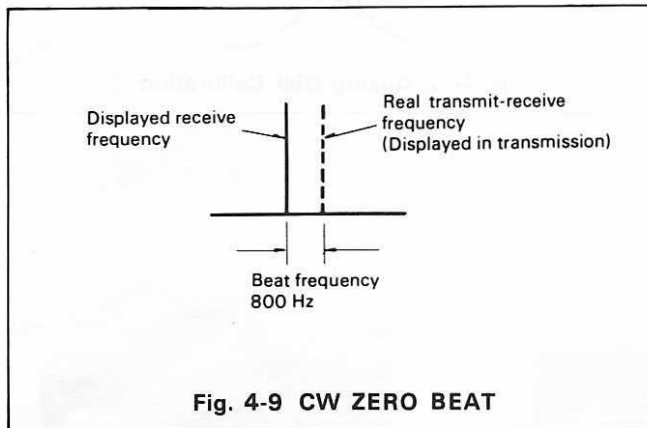

■ OPERATION WITHOUT CW FILTERS

To receive CW, set the IF SHIFT control to its center position and the RIT switch to OFF. Adjust the main tuning for about an 800 Hz beat and your transmit frequency will be tuned (zeroed) to the transmit frequency of the station you are receiving. If the 0 beat cannot be obtained easily, adjust the IF shift knob, then return the mode switch to CW. The transmit frequency of the unit is adjusted to that of the mate station. You may now adjust the RIT for a pitch which suits your preference. If interference is encountered, adjust the IF SHIFT. For more convenient and effective CW operation, use of the optional CW filters is recommended.

■ OPERATION WITH CW FILTERS (OPTION)

Set the IF SHIFT to its center position and the RIT OFF. Adjust the main tuning for maximum S-meter deflection. Receive signal pitch will be about 800 Hz, indicating correct tuning. For optional CW filter information see page 23.

■ KEY CONNECTION (Fig. 4-10)

Your key should be connected as illustrated in Fig. 4-10. When using an electronic keyer, make sure that polarity is correct. Use shielded line from the key to transceiver.

NOTE:

When using an electronic keyer, set polarity of the keyer for NEGATIVE keying.

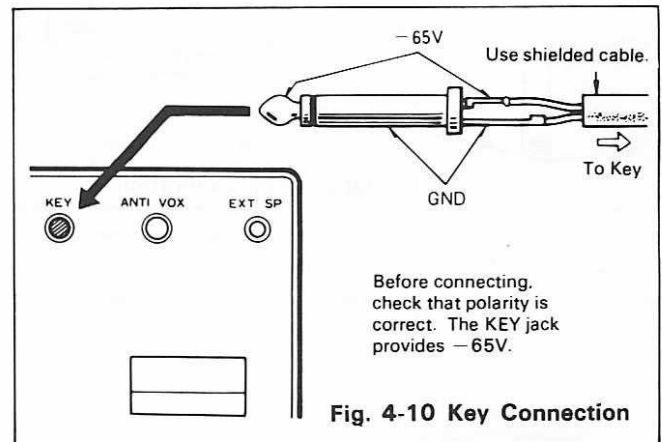

■ SEMI-BREAK-IN OPERATION

The TS-530S has a built-in side-tone oscillator to permit semi-break-in operation, besides the normal CW operation. During semi-break-in operation, the transceiver is set in transmit mode when the key is depressed, and returns to receive mode when the key is released. For semi-break-in operation, place the STANDBY switch to REC and turn the VOX GAIN control ON. Adjust the DELAY control for your preference.

4.5 DIGITAL DISPLAY CALIBRATION

Connect the antenna and set the BAND switch to WWV. Turn the main tuning dial to receive 10 MHz WWV. Adjust the dial until a low-frequency beat is heard. A marker signal will be superimposed on the WWV signal. A double beat (two beat signals of high and low frequencies) will now be heard. Adjust the IF shift for low AF response. While receiving this double beat, adjust the Standard oscillator trimmer through the reference frequency adjustment access opening (on the bottom of the TS-530S) so the two beats are heard as a single beat. Repeat this procedure 2 or 3 times. This completes calibration of the Digital Display. After calibration turn of the CAL switch.

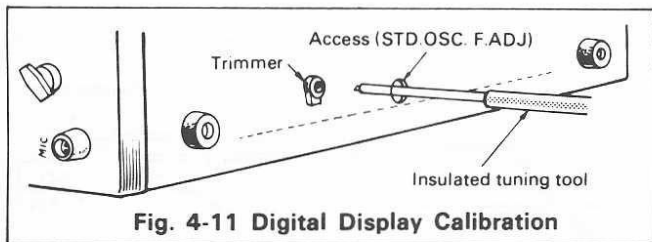

4.6 ANALOG DIAL CALIBRATION

The dial scale is graduated at 1 kHz intervals. One revolution of the main dial covers 25 kHz. To calibrate the scale, turn the MIC control to the CAL position. Zero-beat in either SSB or CW mode. Hold the main tuning knob from rotating and slip the calibration ring to the nearest major (5 kHz) graduation. The dial is now calibrated.

NOTE:
For exact frequency, read the Digital Display.

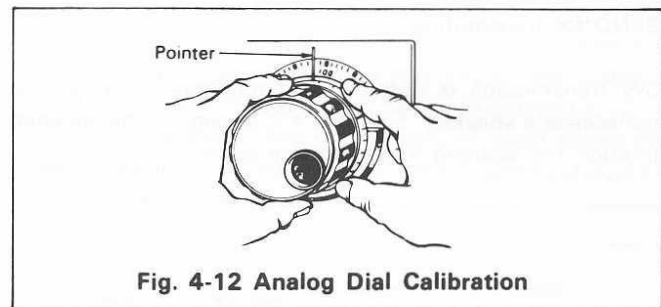

SECTION 5. OPTIONAL ACCESSORIES

5.1 OPTIONAL ACCESSORIES

The following optional accessories are available for use with the TS-530S.

■ REMOTE VFO

VFO-240:

The VFO-240 is an all solid-state VFO with high stability, designed to match the TS-530S in design and performance.

The T-F switch makes it possible to check the transmit frequency while in the receiving mode.

VFO-230:

The VFO-230 digital VFO provides maximum efficiency and flexibility for all operating conditions, including split-frequency operation, by combining a 20 Hz step digital VFO with five memories.

■ ANTENNA TUNER

AT-230:

The AT-230 antenna tuner includes the three new bands and such functional features as a through-line wattmeter, SWR meter and antenna selector switch.

■ EXTERNAL SPEAKER

SP-230:

The SP-230 is a low-distortion speaker with selectable frequency response for high intelligibility in any mode. The frequency response is determined by the built-in audio filters, which are effective in improving signal-to-noise ratio under certain interference conditions, or when receiving weak signals.

■ LINEAR AMPLIFIER

TL-922 (A):

The TL-922 (A) is an HF linear amplifier operating at maximum legal power, and employing a pair of 3-500Z high performance transmitting tubes.

■ STATION MONITOR

SM-220:

Based on a wide-frequency-range oscilloscope (up to 10 MHz), the SM-220 station monitor features, in combination with a built-in two-tone generator, a wide variety of waveform-observing capabilities.



VFO-240



VFO-230



AT-230



TL-922 (A)



SM-220



SP-230

■ PHONE PATCH

PC-1: (Available only where phone patch operation is legal.)

Hybrid phone: patch with VU meter for null and audio gain measurements.

The PC-1 Phone Patch provides connection between a transceiver and a telephone line.

Providing excellent performance, it is designed with high isolation between receive input and transmit output.

Its compact design permits easy installation in a limited space.

■ HEAD PHONES

HS-4: 8 Ω communications headphones.

HS-5: Deluxe 8 Ω headphone set.

HS-6: Deluxe 12.5 Ω lightweight headphone set.

■ MICROPHONE

MC-50: Desk Microphone (50 k Ω /500 Ω)

MC-35S: Noise Cancelling Hand Microphone (50 k Ω)

MC-30S: Noise Cancelling Hand Microphone (500 Ω)

■ FILTER

SSB: YK-88SN : 1.8 kHz SSB filter

CW: YK-88C : 500 Hz CW filter

YK-88CN : 270 Hz CW filter

■ DIGITAL WORLD CLOCK

HC-10:

The HC-10 is a highly advanced world clock with dual display which can memorized 10 world major cities and 2 additional regions.

■ KB-1

Deluxe flywheel VFO tuning knob.



PC-1



HC-10



HS-4



HS-5



HS-6



MC-50



MC-60

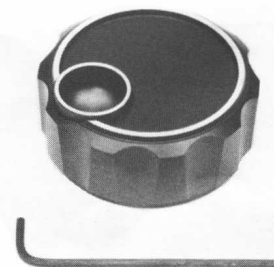

KB-1

5.2 INSTALLATION OF ACCESSORIES

■ REMOVING THE CABINET (See Fig. 5-1)

Figure 5-1 illustrates cabinet removal. Remove the eight top-cover and eight bottom-cover screws and lift away the panels.

NOTE:

This product uses metric hardware.

CAUTION:

The speaker lead is attached to the chassis, so be careful when removing the top cover.

The lead can be unplugged, if necessary.

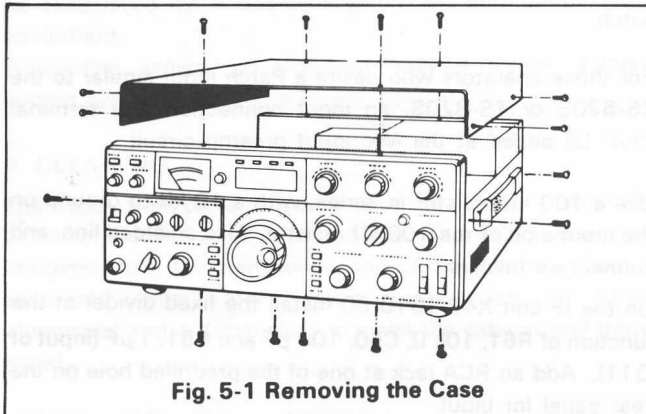

Fig. 5-1 Removing the Case

■ OPTIONAL FILTER INSTALLATION

- Using a number 2 Phillips screwdriver, remove the top cover (eight screws). Unplug the speaker and set the cover aside.
- Remove the bottom cover (eight screws).
- Remove the six screws holding the IF unit X48-1310-00 and swing the printed-circuit board over.
- Using a 45-W (or less) soldering pencil, clear the six holes for the filter, if they are filled with solder.
- YK-88S, C, or CN there is no polarity to the filter. Install the filter into its position on the IF unit. Solder the two mounting tabs and the four input and output pins to the circuit boards. Solder sparingly, and heat the connections only long enough to insure a good solder joint. Don't overheat the filter or circuit board.
- Carefully inspect your soldering. Be certain that all pins are actually soldered, and that you have not soldered across any spots on the board or between any of the pins on the filter. Clip the pins flush to the board.
- Replace the IF unit. Make certain no wires will be pinched underneath the board. Replace the six screws.
- Move the A and B connectors as illustrated, following Table 5-1.
- Reinstall the bottom cover. Reconnect the speaker lead, and reinstall the top cover.

- Apply power and verify your work. Filter installation is now complete.

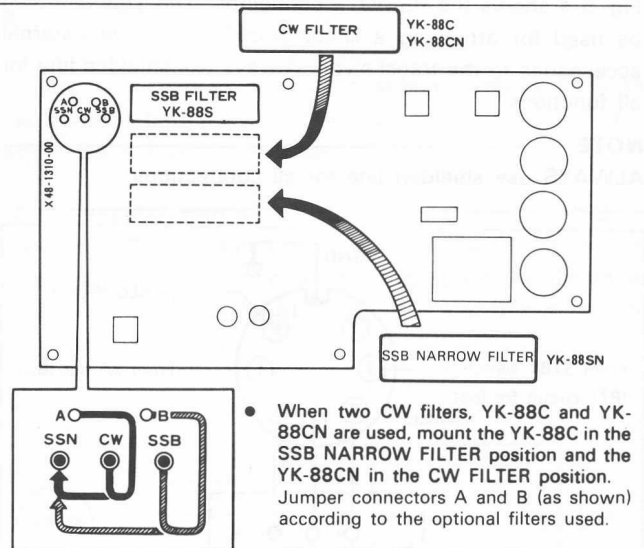

Fig. 5-2 Filter installation

Optional Filter	Jumper connector		SSB		CW	
	A	B	NAR SW		NAR SW	
YK-88XX	A	B	OFF	ON	OFF	ON
Without filter optional	CW	SSB	2.4 kHz	*	2.4 kHz	*
SN	SSN	SSB	2.4 kHz	1.8 kHz	2.4 kHz	1.8 kHz
C	CW	SSB	2.4 kHz	*	2.4 kHz	500 Hz
CN	CW	SSB	2.4 kHz	*	2.4 kHz	270 Hz
SN + C	CW	SSB	2.4 kHz	1.8 kHz	2.4 kHz	500 Hz
	CW	SSN	2.4 kHz	1.8 kHz	1.8 kHz	500 Hz
SN + CN	CW	SSB	2.4 kHz	1.8 kHz	2.4 kHz	270 Hz
	CW	SSN	2.4 kHz	1.8 kHz	1.8 kHz	270 Hz
C + CN	CW	SSN	2.4 kHz	500 Hz	500 Hz	270 Hz

Table 5-1 Optional Filter Selection

* No reception in this position

In transmission, the SSB (WIDE) filter is used regardless of MODE or NAR-WIDE switch positions.

■ VFO-240 CONNECTION (Fig. 5-3)

Connect the VFO-240 as shown.

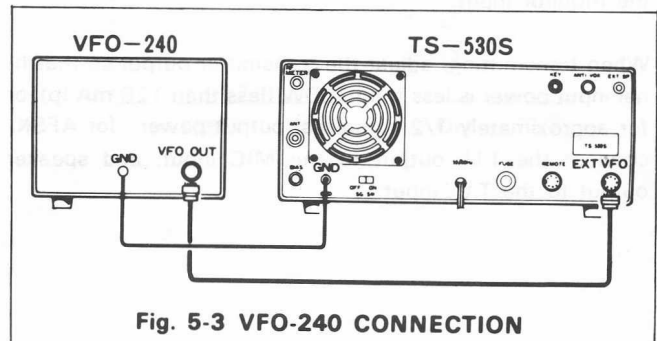

Fig. 5-3 VFO-240 CONNECTION

■ REMOTE CONNECTIONS

Fig. 5-4 shows the REMOTE connector. This DIN plug can be used for attaching a linear amplifier or other external accessories to the transceiver. Always use shielded line for all functions.

NOTE:

ALWAYS use shielded line for all connections.

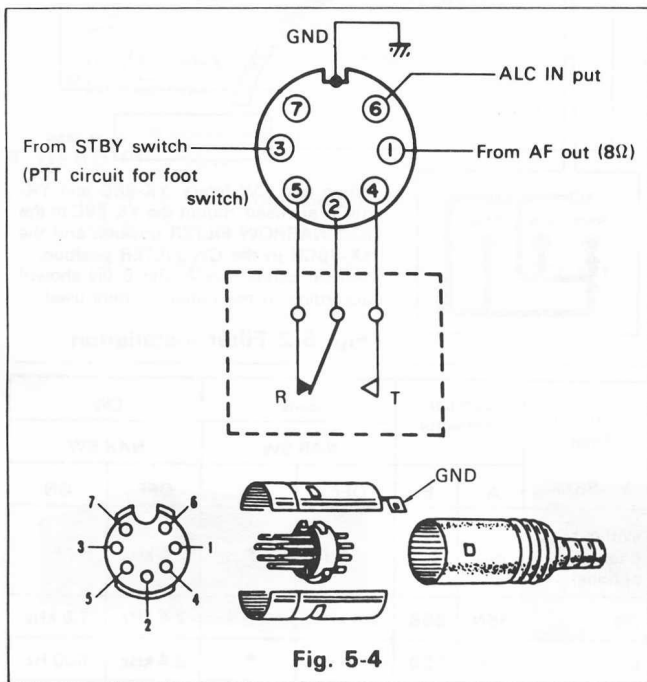

Fig. 5-4

Operation with a linear amplifier. Refer to Fig. 5-4.
 Pin 6 ALC input
 Connector metal shell ground
 Pin 2 Ground to connector metal shell and control line braid.
 Pin 4 Control line center conductor.
 Use shielded line for both ALC and RL (control line).

■ SSTV, AFSK OPERATION

The TS-530S will adapt very well to slow scan television or AFSK RTTY operation. For SSTV, the only cabling required are connections between the MIC connector of the TS-530S and the camera output, and between the SPEAKER jack and the monitor input.

When transmitting, adjust the transmitter output so that final input power is less than 100W (less than 125 mA Ip), or for approximately 1/2 of normal output power. for AFSK, connect the T.U. output to the MIC input, and speaker output to the T.U. input.

■ PHONE PATCH OPERATION

The PC-1 Phone Patch can be used with the TS-530S. Recommended settings are:

PC-1	RX Gain	4
	TX Gain	4
	Null as necessary	
TS-530S	Vox Gain	1
	AF Gain	4
	Mic Gain	5
	Anti Vox Max	

Most other phone patches will work satisfactorily without any modification to the radio, requiring only an external speaker connection, and that the Mic line be run through the patch.

For those operators who desire a Patch input similar to the TS-520S or TS-820S, an input connection and terminal must be added at the Mic input preamp circuit.

Use a 100 kΩ resistor in series, with a 10 kΩ to ground on the input side of the 100 kΩ resistor. Use shielded line, and connect as follows:

On the IF unit X48-1310-00 install the fixed divider at the junction of R61, 10k Ω, C50, 100 pF and C51, 1 μF (input of Q11). Add an RCA jack at one of the predrilled hole on the rear panel for input.

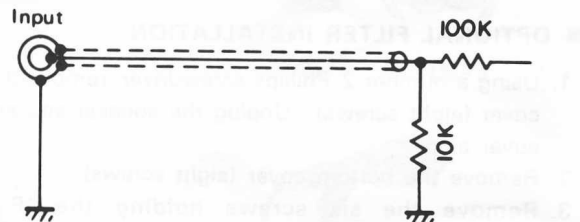

Fig. 5-5 Optional Special Phone Patch Input.

■ EXTENSION FEET

The TS-530S is provided with two extension feet which can be used to elevate the front panel. In some operating positions the tilt makes it easier to read the dial and meter. Fig. 5-6 shows how to install the feet.

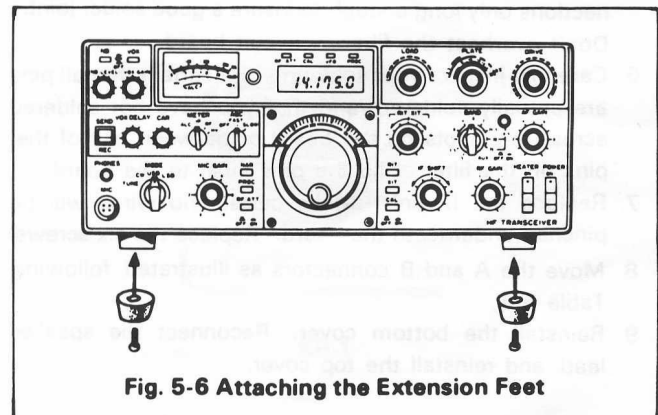

Fig. 5-6 Attaching the Extension Feet

SECTION 6. MAINTENANCE AND ALIGNMENT

CAUTION: DANGEROUS HIGH VOLTAGES ARE PRESENT WITHIN THE CASE OF THE TS-530S WHEN THE TRANSCEIVER IS TURNED ON. EXERCISE EXTREME CAUTION TO AVOID ELECTRIC SHOCK.

6.1 GENERAL

Your TS-530S has been factory aligned and tested to specification before shipment. Under normal circumstances the transceiver will operate in accordance with these operating instructions. All adjustable trimmers and coils in your transceiver were preset at the factory and should only be readjusted by a qualified technician with proper test equipment.

Attempting service or alignment without factory authorization can void the transceivers warranty.

■ CLEANING

The knobs, front panel and cabinet of the TS-530S are likely to become soiled after extended use. The knobs should be removed from the transceiver and cleaned with a neutral soap and warm water. Use a neutral soap (not harsh chemicals) and a damp cloth to clean the cabinet and front panel.

■ FUSE REPLACEMENT

When the fuse blows, there is some cause. Be sure to find the cause before attempting operation. Use a 6 amp fuse for 120V AC operation and a 4 amp. fuse for 220/240V AC operation. Under no circumstances use a higher amperage fuse than specified: This can cause extensive damage. Also, the warranty will be void if an oversized fuse is used.

■ FAN MOTOR LUBRICATION

Every 6 months dust out the final compartment, and apply a few drops of light machine oil to the front and rear fan motor bearings.

WARNING:

Be certain to disconnect power, and to discharge high voltage before servicing in the final compartment.

6.2 SERVICE POSITION

The TS-530S should be placed on its side, with the final section up, for any alignment or service. This position permits adequate ventilation for the final tubes as well as easy accessibility to the modules. Most of the described adjustments can be made without removing the boards from the transceiver.

6.3 RECEIVER ADJUSTMENTS

■ RIT ZERO (IF UNIT)

When the RIT circuit is turned on, and the RIT control is set to zero, the receive frequency should be exactly the same as the transmit frequency. If the frequency is not the same, adjust the RIT zero preset control, VR5.

To zero the RIT, turn on the calibrator and tune the VFO for about a 1000 Hz calibrator tone. Turn the RIT control to zero. Turn the RIT switch ON and adjust VR5 for the same 1000 Hz tone. Push the RIT switch ON and OFF to be sure the tones are identical.

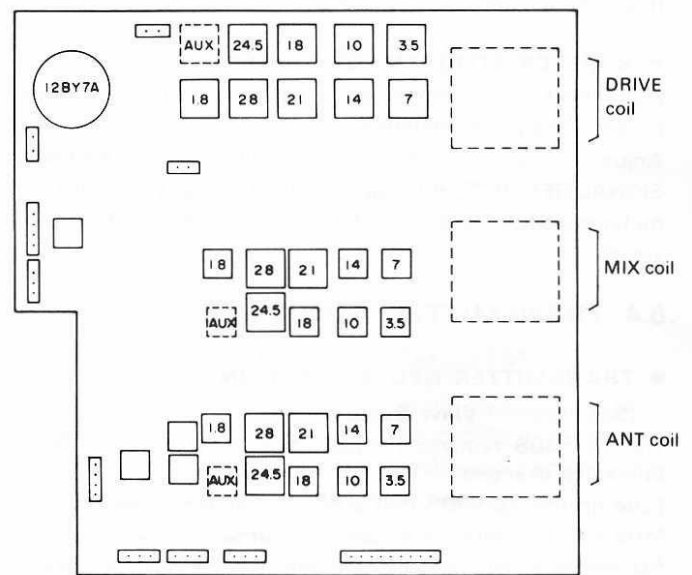

Fig. 6-1
Coil Pack Locations FRONT Panel

BAND Switch	Frequency for adjustments
1.5	1.9 MHz
3.5	3.75
7	7.15
10	10.125
14	14.175
18	18.125
21	21.225
24.5	24.95
28.5	28.8

Table 6-1 Alignment Order

■ ADJUSTMENT OF ANT AND MIX COILS (RF UNIT)

The ANT and MIX coils are included in the coil pack unit. Use the 25 kHz calibrator as a signal. Connect a 50Ω dummy load to terminate the receiver input. Set the DRIVE control to 12 o'clock. Adjust the ANT and MIX coils for maximum S meter deflection, following the frequency table. Start with the 1.8 MHz band and then proceed to other bands. To adjust the 10m band, use only 28.8 MHz in the 28.5 MHz band.

■ ADJUSTMENT OF RECEIVE IF COILS (RF AND IF UNITS)

Receive a marker signal using any frequency. Adjust the DRIVE and the main tuning for maximum S meter deflection. Adjust T2 on the RF unit, L2, L5, L6, L7 and L10 on the IF unit for maximum S meter indication. DO NOT adjust L8.

■ S METER ADJUSTMENT (IF UNIT)

Disconnect the antenna with the transceiver in receive mode. Zero-point adjustment:

Adjust VR1 for meter pointer zero indication. If a standard SIGNAL GENERATOR (SSG) is available, adjust VR2 so the S-meter indicates "S-9", at 14.175 MHz for a 40 dB (50μV) signal.

6.4 TRANSMITTER ADJUSTMENTS

■ TRANSMITTER NEUTRALIZATION

(See Internal View Bottom)

The TS-530S requires neutralization every time the final tubes are changed.

Tune up the TS-530S into a 50 ohm dummy load at 28.5 MHz for CW operation as described in Section 4. Set the SG switch to OFF and place a sensitive RF milli-voltmeter across the dummy load. Flip the stand-by switch to SEND and adjust TC1 (at the bottom of the final section) for a minimum reading on the voltmeter. After the final section is neutralized, flip the stand-by switch to REC and slide the SG switch ON.

A receiver tuned to 28.5 MHz works very well for neutralizing if an RF voltmeter is not available. Instead of tuning for a minimum voltage, tune for a minimum S-meter reading.

NOTE:

Since the drive tube operates into a fixed load (the finals) it is not always necessary to replace this tube when replacing the finals.

CAUTION:

Neutralization of the final section should be carried out with the chassis shield in place. Dangerous high voltages are present in the final section when the transceiver is turned on. Use an insulated tool to make this adjustment.

■ TRANSMIT DRIVE COIL ADJUSTMENT (RF UNIT)

The drive coils are part of the coil pack unit. Set the SG switch on the rear panel to OFF and center the DRIVE control (12 o'clock). Set the METER switch to ALC and the MODE switch to CW or TUNE.

With the standby switch in the SEND position, adjust the drive coils for maximum ALC deflection for each band using the same frequency and in the same order as for adjustment of the ANT and MIX coils.

During adjustment, adjust the CAR control so there is just enough injection to swing the ALC meter.

■ TRANSMIT IF COIL ADJUSTMENT (RF UNIT)

Using any frequency, place the transceiver in transmit mode in the CW or TUNE position. Adjust T4 on the RF unit for maximum ALC deflection.

■ CARRIER BALANCE ADJUSTMENT (IF UNIT)

With a 50Ω dummy load connected to the ANT terminal, adjust for maximum output at 14.175 MHz. Reduce mic gain to zero. Set the transceiver in LSB mode and adjust the RF METER control on the rear panel for maximum sensitivity. The RF meter will deflect if the carrier is unbalanced. To balance the carrier, alternately adjust trimmer TC1 and trimpot VR4 until the meter indicates minimum. Switch to USB mode and if the pointer deflects, readjust so the pointer deflects equally for both LSB and USB.

■ ADJUSTMENT OF SIDE TONE LEVEL (AF UNIT)

Adjust VR1 to your preference.

6.5 TRANSMITTING ON WARC BANDS (Fig. 6-2)

As supplied, the TS-530S will receive but not transmit on the 17, and 12 meter WARC bands. If transmit capability is desired, a minor wiring change is required.

1. For 2 bands: Break the line between the RF unit X44-1360-01, connector #6, Pin #1 (TOF terminal) and AF unit X49-1150-00, connector #7, Pin #4 (TOF terminal).
2. Or, for individual Bands: On the RF unit X44-1360-01:

Band	Remove (or Cut) Part
18 MHz	D5
24.5 MHz	D6

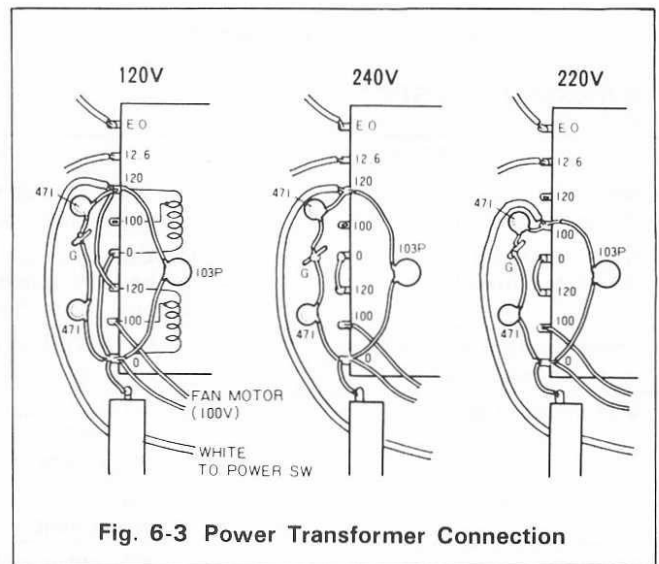
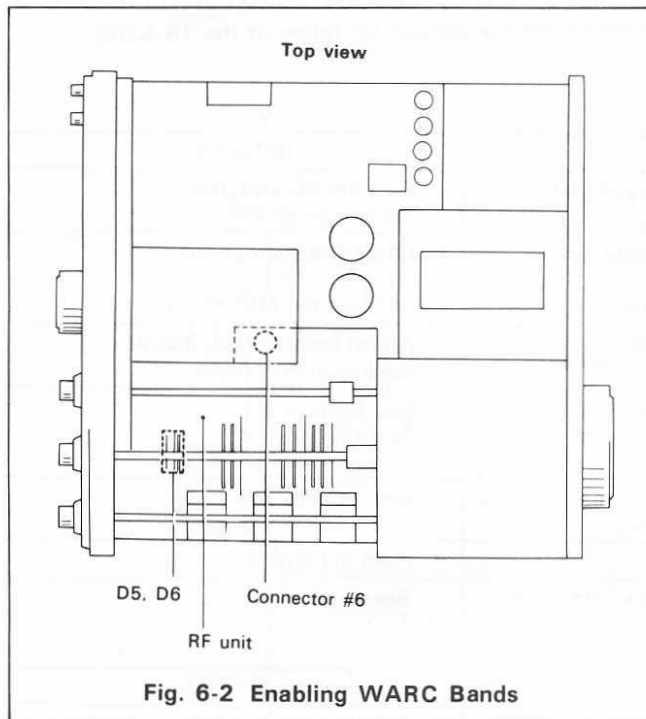

6.6 OPERATION ON 220V or 240V AC (U.S.A.) (Fig. 6-3)

To operate the TS-530S on 240V AC, the power transformer split primaries must be rewired from parallel to series connection.

1. Unplug the AC power cable.
2. Remove the bottom cover.
3. Remove the jumper wires between the two ϕ terminals and two 120 terminals on the bottom of the power transformer.
4. Connect the adjacent 120 and ϕ terminals at the middle of the transformer. This will provide 240V AC operation. For 220V AC operation, connect the adjacent 120 to ϕ winding and move the white lead and bypass caps from 120 to 100 terminal.
5. Change the AC fuse from 6A to 4A. Tag the power cord at the back of the radio to indicate that the transformer is strapped for 240V AC, and the power fuse should be 4A, and not 6A.
6. Replace the bottom cover and reconnect power to verify your work.

TS-530S ANALOG DIAL ADJUSTMENT

1. Turn the main dial fully CCW. The red cursor should line up with the VFO start mark on the sub-dial. If it does not, remove the main knob (2 mm allen), loosen and line 12 mm nut up the scale start point to the red cursor.
2. Turn the main knob to 50 kHz analog. Adjust the aluminum slip sub-dial to line up with any one of the larger black dial marks.
3. Note the digital error: If it is MORE than 2 kHz adjust the VFO trimmer cap TC1 (front under the seal tape) to exactly 50.0 on the digital readout.
4. Turn the main knob to 450 analog. If the digital error is less than 2 kHz it is in spec. If the digital error is greater, proceed:
For instance if the digital error is 14.454.0 (plus 4 kHz), multiply the error times 4 (16 kHz) and adjust the VFO trimmer cap to the desired frequency (14.450.0) LESS the error, or 14.434.0. Next adjust the VFO inductor L3 (center under the seal tape) back up to the desired frequency of 14.450.0.
5. If the error in step 4 was in the minus direction, reverse the direction of the correction adjustment in step 4.
6. VFO linearity final check: The digital readout and analog dial should agree to within ± 2 kHz at every 100 kHz dial point.

SECTION 7. TROUBLESHOOTING

6.1 GENERAL

The problems described in this table are failures caused in

general by improper operation or connection of the transceiver, not by defective components. There is a separate service manual for repair of the TS-530S.

TRANSMITTER SECTION

SYMPTOMS	CAUSE	REMEDY
No output (No plate current)	No voltage on the screen grid of the final tubes.	Turn the SG switch on the rear panel ON.
No output in SSB (No plate current)	1. Open microphone cable or bad microphone. 2. Low microphone gain.	1. Check the microphone. 2. Increase the MIC control.
There is output, but the RF meter shows no output.	RF METER control not adjusted correctly.	Adjust control for 2/3 scale reading at full output.
VOX does not operate.	1. VOX GAIN control too low. 2. ANTI VOX control requires adjustment.	1. See section 4.4 2. See section 4.4
VOX trips by speaker output.	ANTI VOX control requires adjustment.	See section 4.4
XIT control inoperative	XIT switch is off.	Push XIT button.
Mic or radio chassis is "hot" during TX.	Excess RF in the shack. No earth ground, poor ground, or antenna is too close to the radio.	See section 2
Poor audio in SSB, TX-feedback	Excess RF in the shack.	See section 2
RF METER reading varies by band.	SWR differences between bands	Retune antenna system.

RECEIVER SECTION

SYMPTOM	CAUSE	REMEDY
Pilot lights do not light and there is no receiver noise when the POWER switch is turned on.	1. Bad power cable or connections. 2. Blown power supply fuse.	1. Check cables and connections. 2. Check for the cause of the blown fuse and replace the fuse.
An antenna is connected but no signals are heard.	Microphone PTT switch (or stand-by switch) is in the transmit position.	Release the PTT switch.
An antenna is connected but S-meter deflects without a received signal.	1. RF GAIN control closed. 2. Low AC line voltage.	1. Open RF GAIN control. 2. Use a step-up transformer to raise the line voltage.
SSB signal unintelligible	MODE switch is set to wrong sideband.	Turn MODE switch to the correct sideband.
RIT control inoperative.	RIT switch is off.	Push RIT button.
SSB received signal is extremely high cut or low cut.	IF shift is out of adjustment.	Set to the center (click) position.

TS-530S BLOCK DIAGRAM

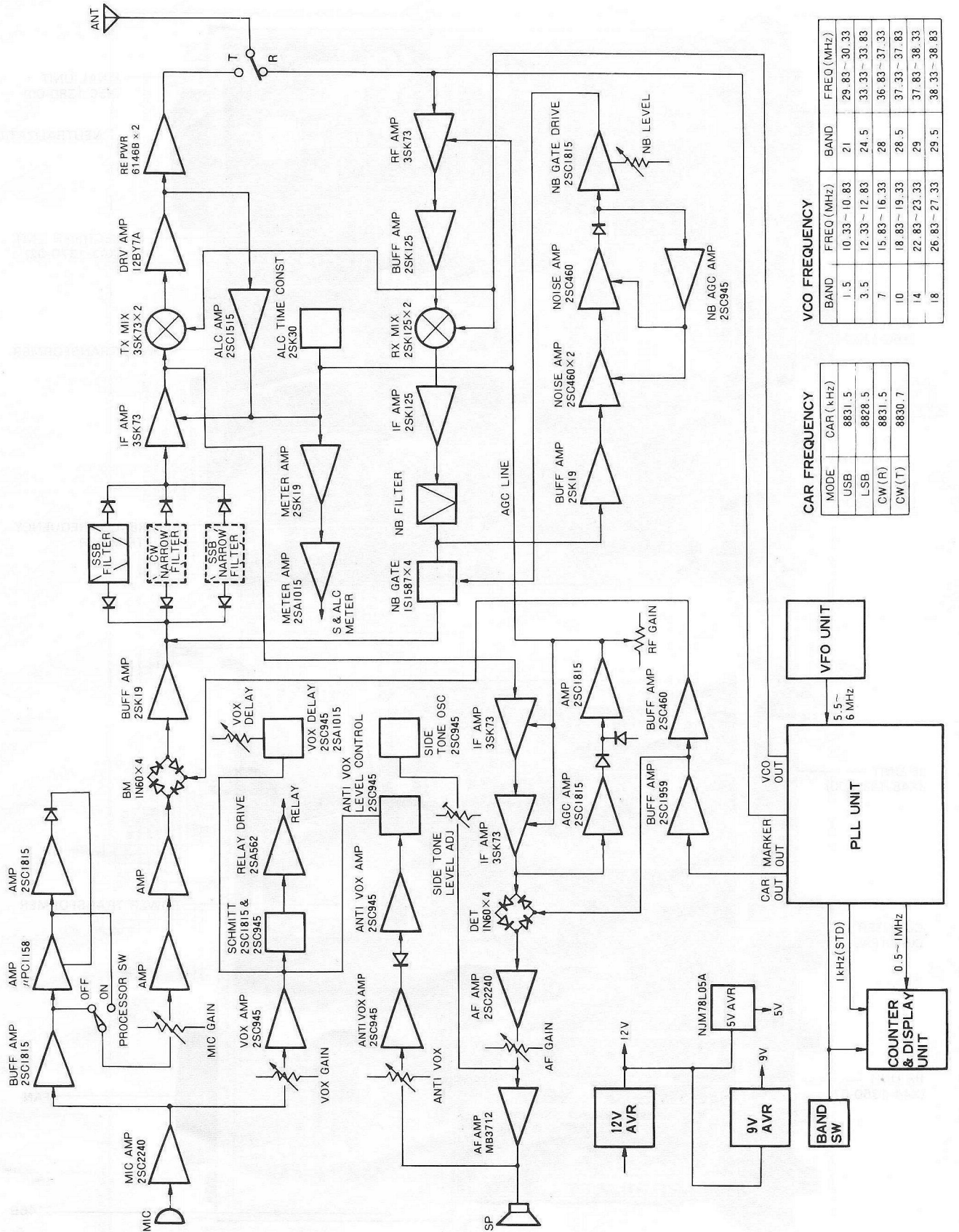

VCO FREQUENCY

BAND	FREQ (MHz)	BAND	FREQ (MHz)
1.5	10.33 ~ 10.83	21	29.83 ~ 30.33
3.5	12.33 ~ 12.83	24.5	33.33 ~ 33.83
7	15.83 ~ 16.33	28	36.83 ~ 37.33
10	18.83 ~ 19.33	28.5	37.33 ~ 37.83
14	22.83 ~ 23.33	29	37.83 ~ 38.33
18	26.83 ~ 27.33	29.5	38.33 ~ 38.83

CAR FREQUENCY

MODE	CAR (kHz)
USB	8831.5
LSB	8828.5
CW(R)	8831.5
CW(T)	8830.7

INTERNAL VIEW

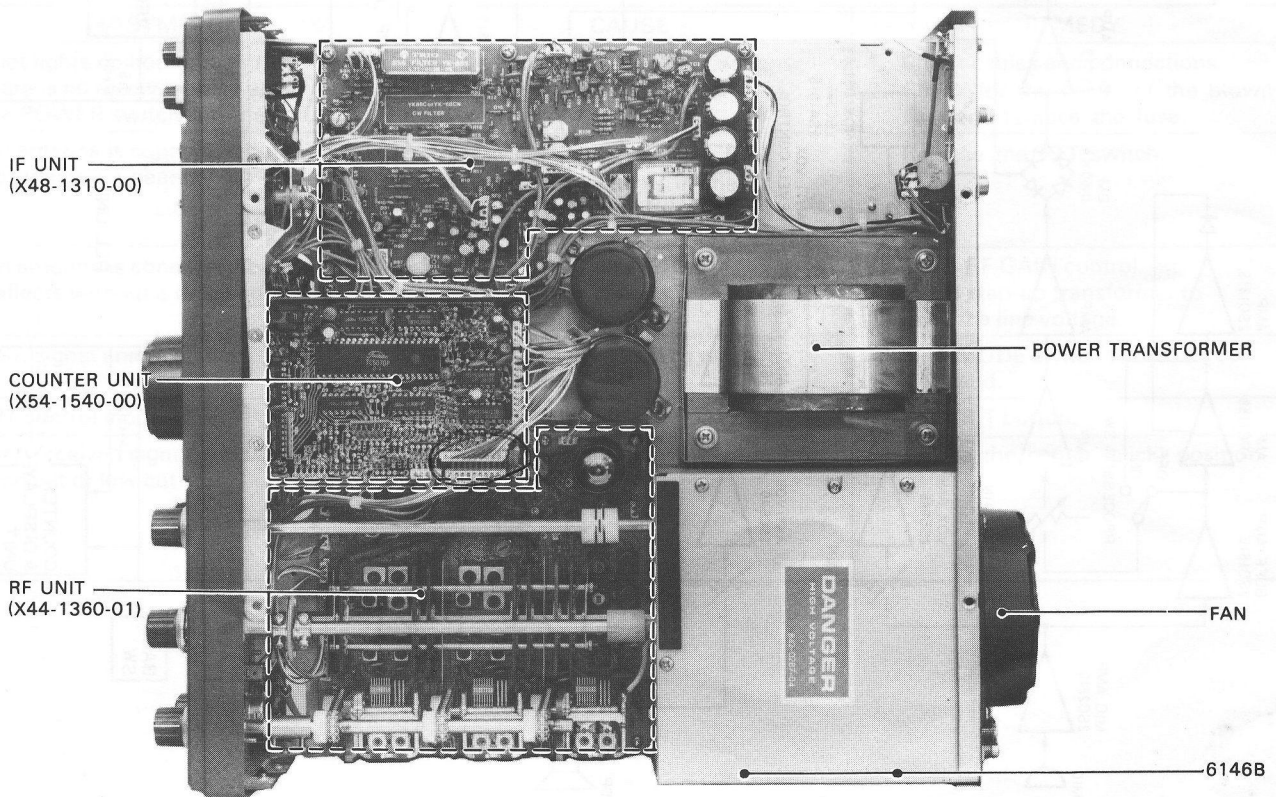
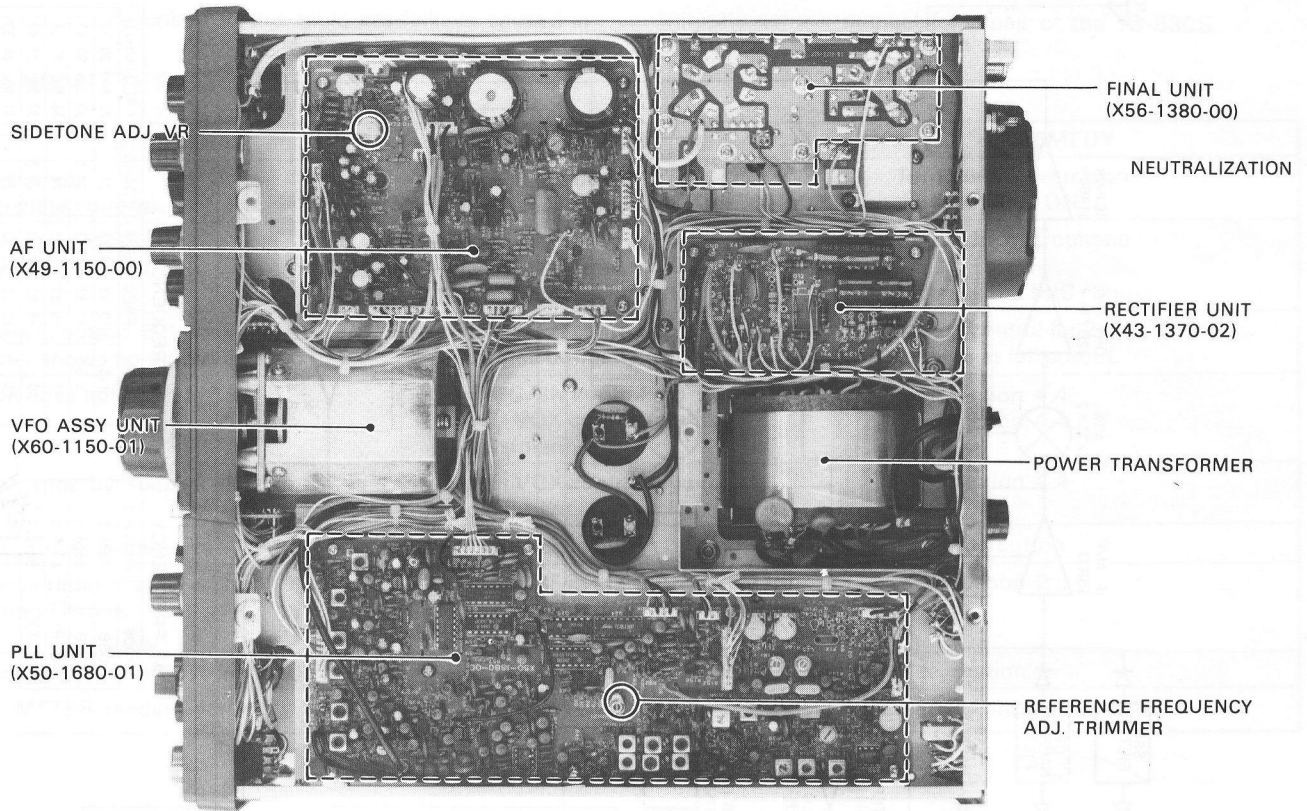

TS-530S SCHEMATIC DIAGRAM

PLL UNIT (X50-1680-01)

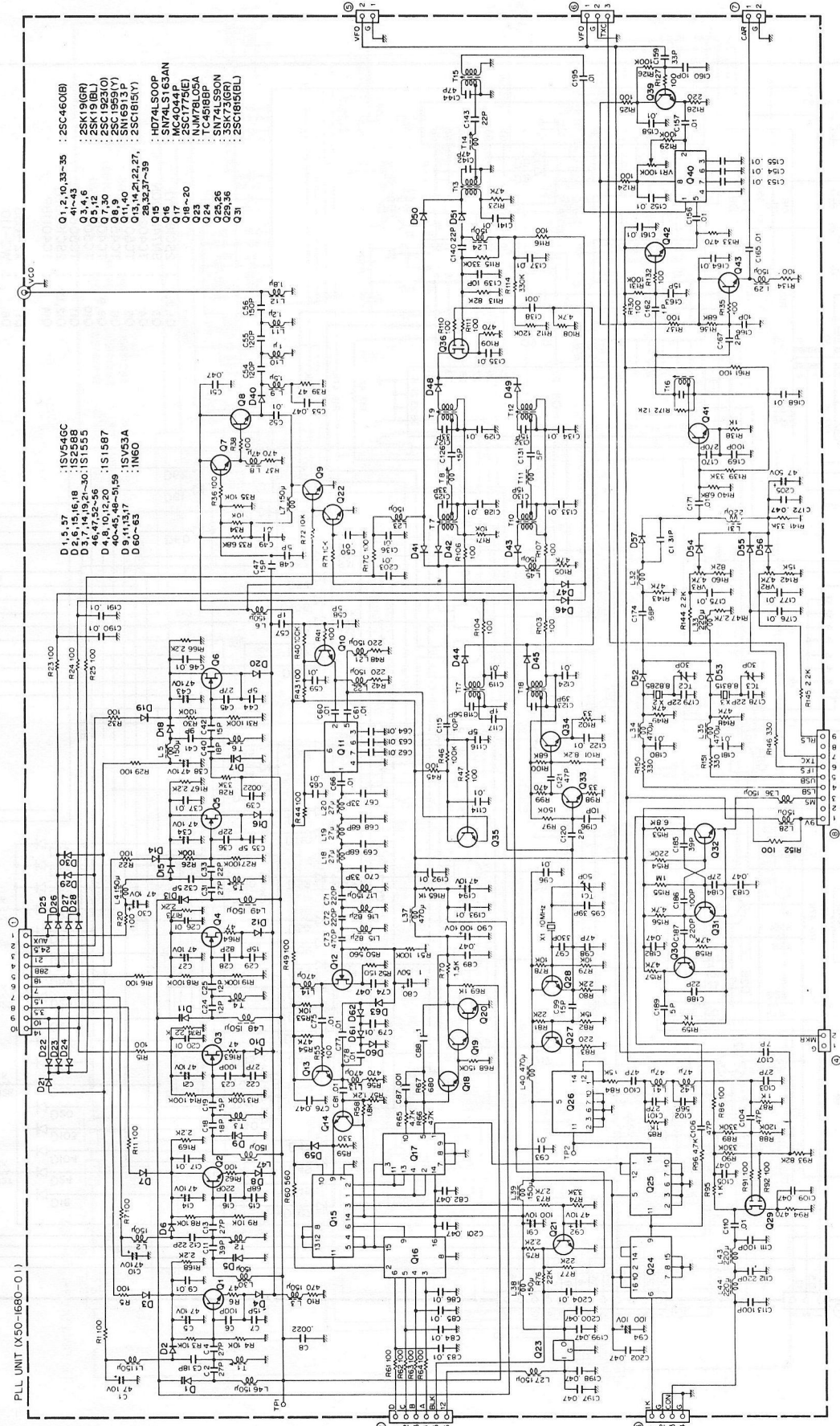

- Q 1, 2, 10, 13-35 : 2SC460(B)
- Q 3, 4, 6 : 2SK19(GR)
- Q 5, 11, 12 : 2SK19(BL)
- Q 7, 30 : 2SC1923(O)
- Q 8, 9 : 2SC1923(Y)
- Q 13, 14, 21, 22, 27, 28, 32, 27-39 : 2SC181(B/Y)
- Q 15 : HD74LS00P
- Q 16 : SN74LS163JAN
- Q 17 : 2SC177(AE)
- Q 18-20 : NJM78L05A
- Q 23 : TC4518BP
- Q 24 : SN74LS90N
- Q 25, 26 : 2SC181(B/L)
- Q 1 : 2SC181(B/L)

- D 1, 5, 37 : 1S1554GC
- D 2, 9, 16, 18 : 1S1555
- D 3, 11, 16, 20 : 1S1555
- D 4, 6, 7, 32-56 : 1S1587
- D 4, 8, 10, 12, 20 : 1S1587
- D 40-45, 48-51, 59 : 1S153A
- D 61, 63, 7 : 1N60
- D 69-65

PLL UNIT (X50-1680-01)

TS-530S SCHEMATIC DIAGRAM

COUNTER UNIT (X54-1540-00)

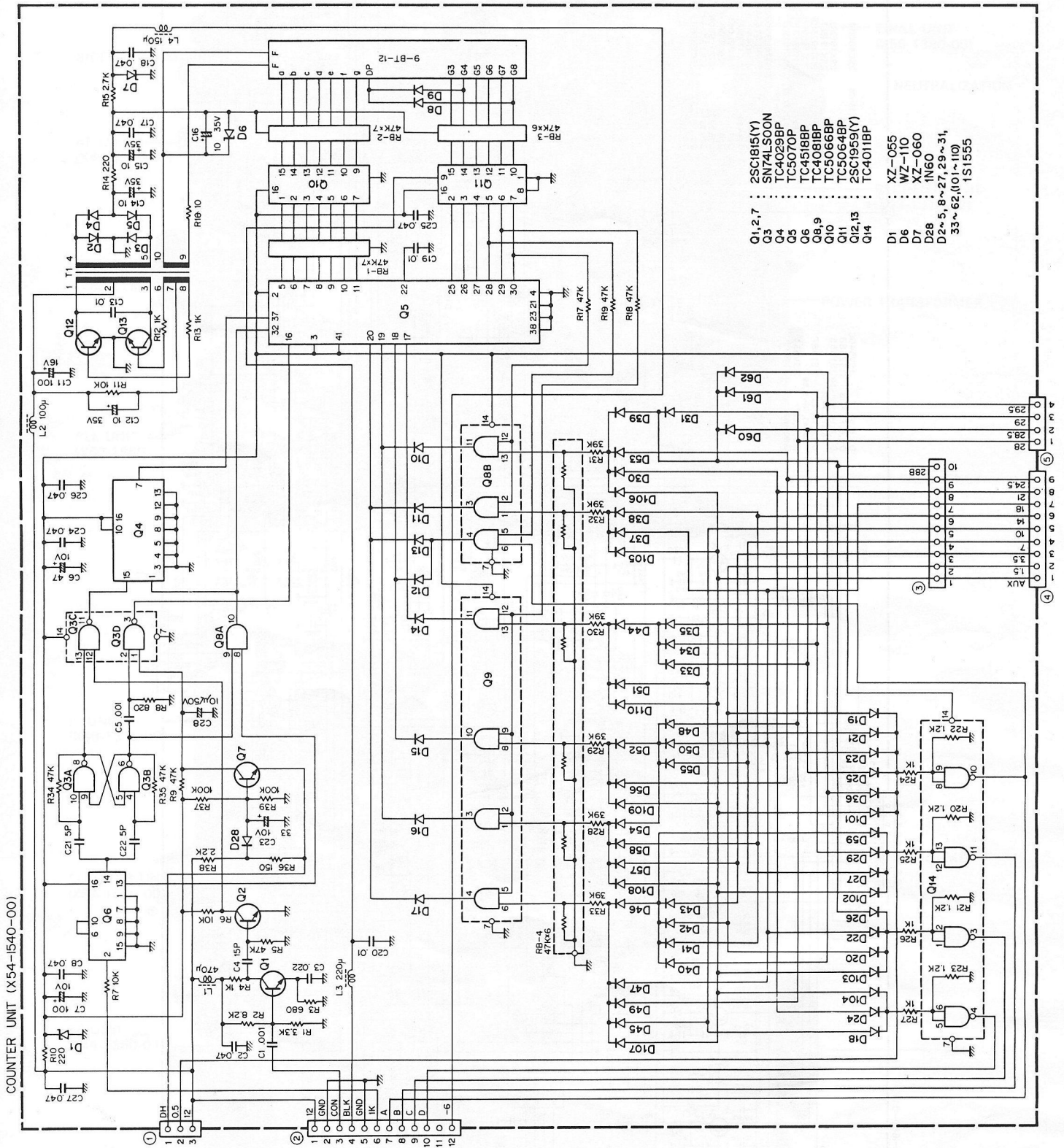

TS-530S SCHEMATIC DIAGRAM

IF UNIT (X48-1310-00)

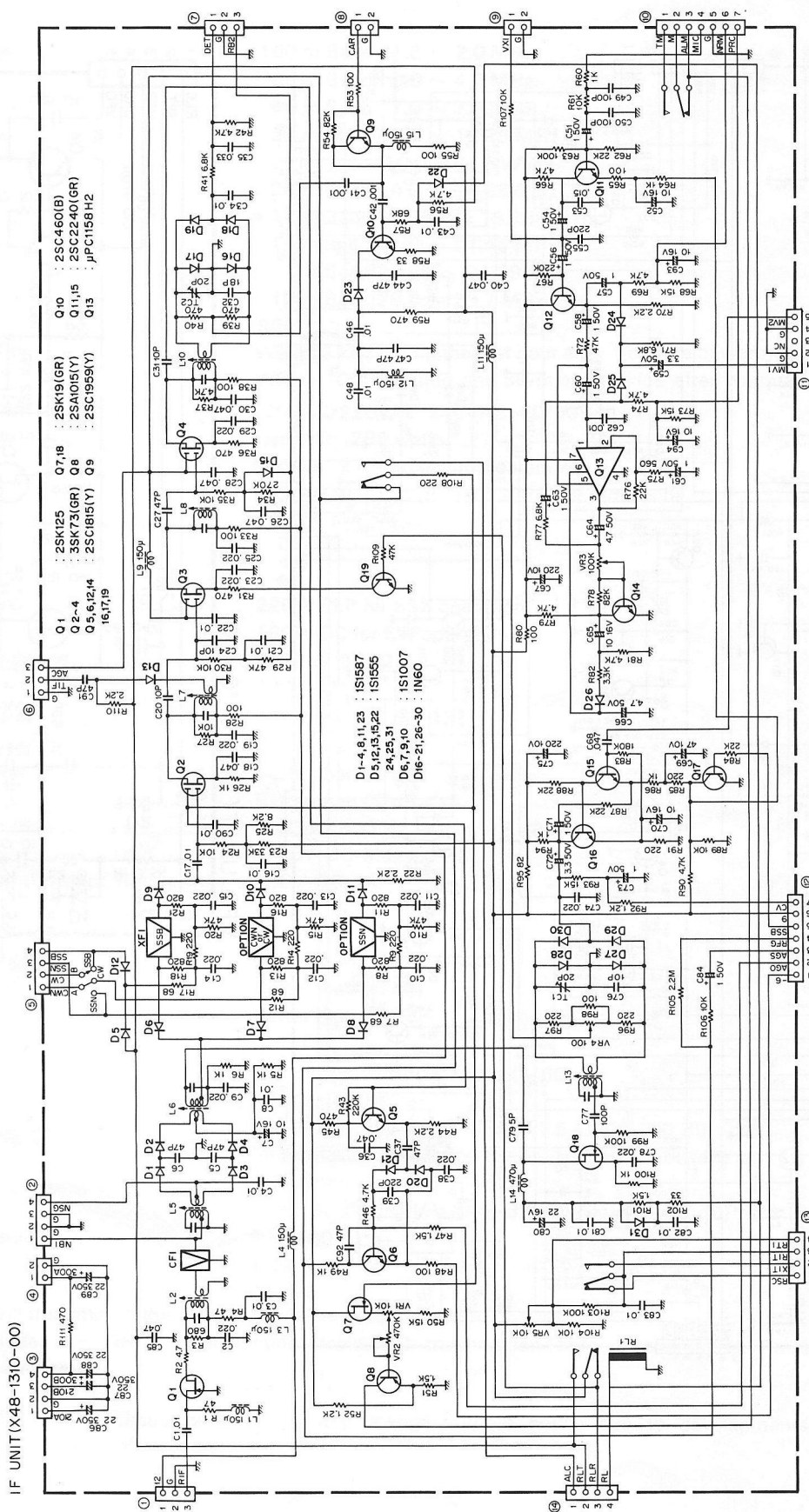

TS-530S SCHEMATIC DIAGRAM

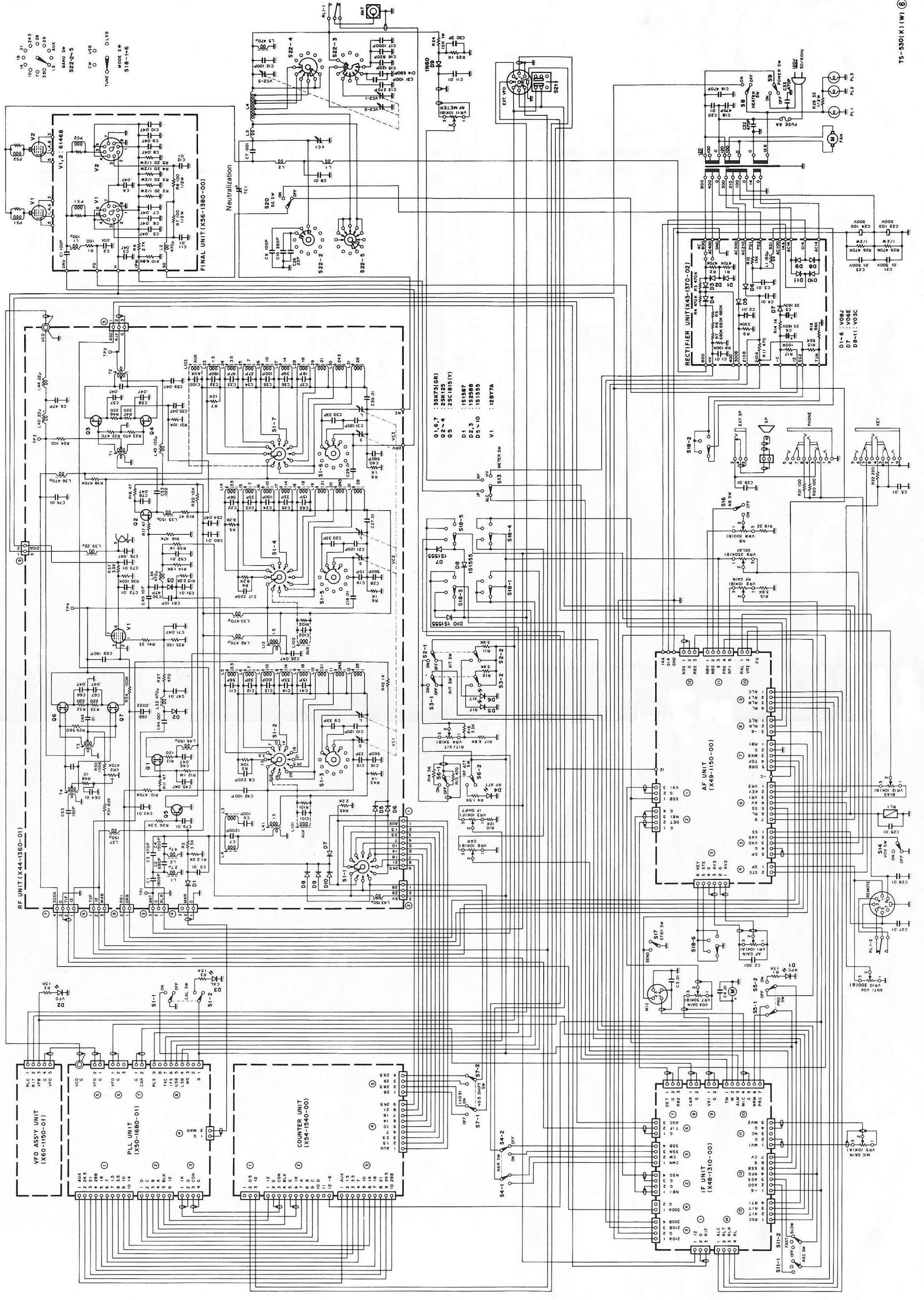

TS-530S 220/240V AC LINE MODEL

Place S23, AC selector switch to your line voltage.

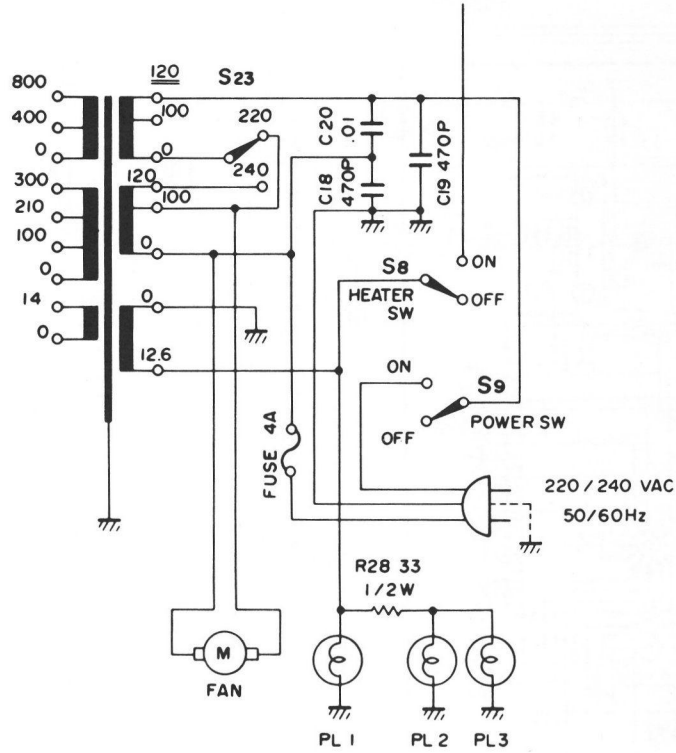

TS-530S 120/220V AC LINE MODEL

Place S23, AC selector switch to your line voltage and replace the fuse (120V AC → 6A, 220V AC → 4A).

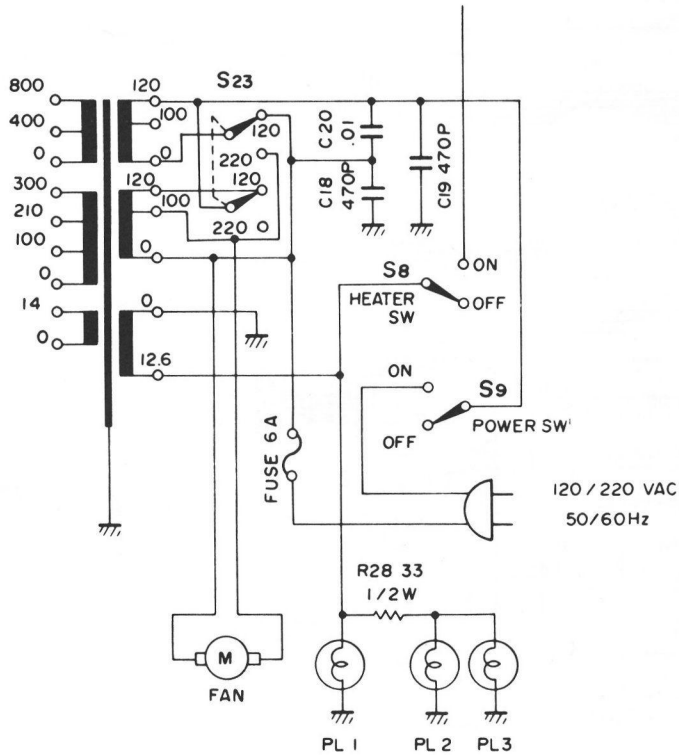

Model TS-530S

Serial No. _____

Date of Purchase _____ / _____ / _____

Dealer _____

A product of
TRIO-KENWOOD CORPORATION
17-5, 2-chome, shibuya, shibuya-ku Tokyo 150, Japan

TRIO-KENWOOD COMMUNICATIONS

1111 West Walnut Street, Compton, California, 90220, U.S.A.

TRIO-KENWOOD COMMUNICATIONS, GmbH

D-6374 Steinbach TS, Industriestrasse 8A, West Germany

TRIO-KENWOOD ELECTRONICS, N.V.

Leuvensesteenweg 504, B-1930 Zaventem, Belgium

TRIO-KENWOOD (AUSTRALIA) PTY. LTD.

4E Woodcock Place, Lane Cove N.S.W. 2066, Australia